

# Catalog June 2023

# Beveltools

INTRODUCING A COMPLETE PLATFORM OF HAND TOOLS  
CREATED FOR STAINLESS STEEL:

## BEVELTOOLS INOX



**BEVEL TOOLS**





## Content

<b>Beveltools advantages</b>	<b>4</b>
<b>Types of cutter heads and materials</b>	<b>5</b>
<b>Bevel Mite®</b>	
EBI 3.0 electric motor	10
EBI-C 3.0 cordless	10
ABIS-R pneumatic motor	11
ABIS-B pneumatic motor	11
Angled cutters 8mm	13
Radius cutters 6mm	14
<b>Bevel Mate®</b>	
EBA 3.0 electric motor	17
ABA 3.0 pneumatic motor	18
Angled cutters 8mm	19
Angled cutters 12mm	20
Radius cutters 8+ mm	21
<b>INOX series</b>	
EBI INOX	23
ABIS INOX	23
EBA INOX	24
INOX cutters (all)	25
<b>BevelTools Top Edge</b>	<b>27</b>
Beveltools Top Edge options	28
<b>Guide</b>	<b>29</b>
<b>Accessories</b>	<b>30</b>
<b>Contact</b>	<b>32</b>



# Beveltools The Game Changer

Regardless of whether you are beveling or rounding metal, Beveltools' innovative patented technology created a true revolution!

After Beveltools introduction in 2015 we brought our solution to the next level in 2020 by introducing **Beveltools 3.0**

Improved and completely new developed pneumatic and electrical tools together with improved cutters and guide bearings results in even significant better results and durability.

Older methods sold by the competition for weld preparation, rounding and beveling are physically demanding, inaccurate and time-consuming. With this in mind Beveltools has been developed.

2 compact and ergonomic concepts, Bevel Mite® and Bevel Mate®. They make weld preparation, beveling and rounding metal easier, faster, more accurate and cheaper.

Experience the difference now with our patented solution!

**With Beveltools your company will be ready for the future.**

# Beveltools advantages

## Weld preparation and beveling

Welding remains a professional's job. Not everybody can create strong and clean weld. It all starts with a perfect bevel. By introducing the norm NEN-EN 1090 and ISO 9692 a good welding becomes more important, due to the specific requirements to manufacture steel and aluminum construction components.

## Rounding

Smooth and even rounding is essential whether you need to comply with IMO PSPC, ISO 12944, ISO 8501 or NEN-EN 1090. With the products from Beveltools, high quality that complies with all the norms and guidelines can be achieved quickly and consistently when rounding a wide range of metals.



### Accurate and even

The Beveltools products make for consistent and accurate angles or rounding for metals. This produces stronger welding joints, a good bonding surface for paint and coatings, or smooth cable entry holes.



### Work faster

Beveling and rounding metals goes faster than with current conventional methods thanks to the unique design of the bevel head. The shaping and angle of the cutting surfaces mean that the metal can be cut quickly and effortlessly.



### Long service life

Experience shows that with correct and careful use, you can bevel 100 to 140 metres with only one bevel head. For rounding, you can achieve up to 250 metres and sometimes even more depending on the edge's hardness.



### No finishing needed

An impeccable result is achieved immediately, with no finishing needed. Discoloration is prevented through precision machining that adds hardly any heat to the material.



### Lightweight and handy to use

Because of the handy design and the light weight, minimal physical effort is needed to operate the machine. The machine rests on the material during rounding and beveling. The only effort required is guiding the machine.



### Better working conditions

Beveling is done with hardly any sparks or vibrations. The chips are large and heavy, meaning they immediately drop to the ground. It doesn't release any harmful dust particles and/or combustion gases. Work without vibrations and prevent getting HAVS

# Types of bevel heads and materials

Would you always like to achieve the best and most consistent end results when preparing an edge? With the Beveltools bevel heads, this can always be done quickly and cheaply.

## Beveltools offers 4 different types of bevel heads



### Steel

The bevel heads for steel are ideal for beveling and rounding the most common types of steel such as S235. For rounding and beveling harder types of steel, we have developed the version 3.0 bevel head.

*Note: The STL versions will be phased out because bottom line higher quality cutters are more versatile and requested. So when STL versions are out of stock these will not be replaced anymore.*



### Version 3.0

Stronger types of construction steel and plasma- or laser cut steel need a special type of cutter head. The NEW 3.0 cutter heads produced with state-of-the-art hard metal / carbide components, grinding technology and high-end coatings. This makes the 3.0 cutter ideal for stronger types of construction steel. You can recognize these 3.0 cutters at their bronze/copper toned coating.



### Aluminum

The chips from non-ferrous metals such as aluminum can weld to the cutting surfaces of the bevel head. The aluminum bevel head has the perfect cutting edge for this group of metals. The combination of the right geometry and coating means that aluminum, non-ferrous metals and harder plastics can be bevelled or rounded with no problems, and without the use of any lubricants.



### Stainless Steel

is a tough material and difficult to get reworked with hand tools. The specific for stainless steel developed new INOX cutters have got a adjusted geometry and a special coating. This combination reduces the friction between the stainless steel and cutter significant. This makes cutting the stainless steel much easier. We started with a line off the most common cutters, both for angles and radii.

Patented cutter with angle:  
15° - 22,5° - 30° - 37,5° - 45° - 52,5° - 60°



Patented cutters with radius:  
R2 - R3 - R4 - R5 - R6 - R8



# Types of bevel heads and materials

## Recognizable colors

Because Beveltools portfolio is expanding we decided to use new color schemes which makes it easier to recognize for which kind of material the product is most suitable. In the upcoming you will see more and more of the colors appear:



Marine blue indicates product best for regular steel



Azure blue indicates products for non ferro work pieces



Green indicates products from the INOX range for stainless steel

## Choose the right bevel head that suits the material

For the best end result, it is highly important to choose the right bevel head that is the most suitable for the job at hand. The diagram below is a guide for making the right choice.

		S235	S355	Steel plasma / laser cut	SS 304/316	Non-ferro metals
STL cutter		😊😊	😊	😊	😞	😞
Version 3.0 cutter		😊😊😊	😊😊😊	😊😊😊	😊	😞
Aluminum cutter		😞	😞	😞	😞	😊😊
INOX cutter		😊😊	😊😊	😊😊	😊😊😊	😊😊

“ THE PATENTED GEOMETRY OF THE BEVELTOOLS CUTTERS MAKES THEM SO UNIQUE ”



## User experience - Linssen Yachts B.V.

*“With Beveltools, I have finally found a way to round steel without needing to deburr or polish afterwards.”*



Linssen Yachts from Maasbracht is a family business specialising in the manufacture of steel motor yachts with lengths of between 8 and 15 metres. Linssen Yachts was founded in 1949 and has grown in the Netherlands to become one of the major players in this sector of yacht-building. In the meantime, the company has developed a large sales network all across Europe. The various models of yachts are designed and finished by their own specialists. By producing them in batches and using the best materials and techniques to do so, the steel yachts are of excellent quality.

In yacht-building, the finishing is crucial. Peter Zentjes (Production Leader - Hulls) says: “rounding sharp edges in the hull material is important to ensure that the coating and paint bond well and stay on for a long time. Rounded edges look better to the end user too. By rounding sharp edges with Beveltools,

you get a beautiful, smooth, rounded finish.”

The Beveltools system is used almost daily in the hull production hall. “Before, we used to weld a tube on the top edge to create the rounding. Then we had to deburr the material from irregularities. This was time-consuming work. I went on the lookout for a system that would create a rounding in the steel without needing deburring and polishing afterwards. I quickly came across Beveltools,” says Peter.

The EBA tool in combination with the Premium bevel head is the perfect solution for Linssen Yachts. “The machine is lightweight and handy. I can use it anywhere. The Beveltools R3 and R4 bevel heads we use have a long service life but are easy to replace when necessary. For us, Beveltools is the ideal method to achieve quick and consistent rounding,” says Peter.





**“After using the Bevel Mate® EBA-12 for one week, we had made up all the lost time and were even a week ahead of schedule. For our next project, we will definitely be using this machine from the start.”**

A well-renowned company in the oil, gas and chemical industry from Texas, USA, had already been introduced to the Bevel Mate® concept, but - as is often the case - there was no time to go into the field and view a machine in action.

Two weeks later, it turned out that it had been unwise not to free up some time for this. They were behind schedule on a project. If they failed to meet the deadline, they would be

facing severe penalties. That was enough reason for a demonstration of the Bevel Mate® EBA, together with all the workers involved.

During the demonstration, it quickly turned out that the skeptical attitude of the workers was completely unfounded. The Bevel Mate® EBA-12 proved to be 15 times faster than the grinding disc in creating a bevel of exactly 37.5° for an accurate weld.



# Bevel Tools 3.0 The Best on Steel

The Bevel Tools 3.0 productline has been developed with all the experiences we gathered with our first products. Feedback from users and distributors worldwide gave us many ideas and chances to improve.

The result: 4 complete new designed Bevel Mite® tools and 2 new Bevel Mate® tools that offer even more ease-of-use, consistent look and better/easier height adjustment. Also all Bevel Tools 3.0 versions now have a spindle locking button, for easy change of cutters, and a freely rotating flange. The flanges now are made of nitrated stainless steel to get the highest possible hardness which prevents from getting scratches and therefor improves the sliding capability. The result is a complete new line of very easy to use and incredible reliable tools. This in combination with a whole new line of cutters, which cut easier and have significant longer service times makes it the best combination for your bevel- and rounding jobs.



## Bevel Mate®

Very versatile tools that can handle more intense jobs as well. It can bevel up to 12mm and the largest radius is 8mm. Bevel Mate® tools have more power and 'body' which makes them run very smooth and without any noticeable vibrations. Available with 2 motor types: electric motor (EBA) or pneumatic motor (ABA).



## Bevel Mite®

For lighter beveling and rounding work, up to a depth of 6 mm, you can use the Bevel Mite® tools. These tools are compact, manoeuvrable and lightweight. This makes them excellent for usage on smaller work pieces and in smaller holes as well. Bevel Mite® tools are available with 3 motor types: electric motor (EBI), a pneumatic motor (ABIS) or battery powered motor (EBI-C).



# Bevel Mite® 3.0

The 2 new EBI 3.0 electric tools are lightweight and easy to use

A precise depth adjustment in 0,125 mm increments.

The spindle locking buttons makes changing the cutters even simpler and quicker.

A flange head of QPQ nitrated stainless steel with a freely rotating flange.

Available in 230V and 120V with US or UK plug.

VERSION  
3.0



Electric motor



Battery

EBI 3.0

3.0



EBI-C 3.0 cordless

3.0



Spindle locking  
button



Freely rotating  
and nitrated flange

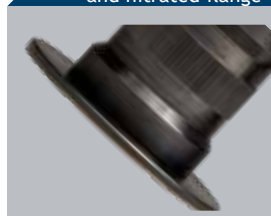

Stong 18V/5Ah  
battery



€ 839,-

€ 1.259,-

	EBI 3.0	EBI-C cordless
Part no.	1041000	1041020
Motor	Electric	Electric- Cordless
Max. bevel depth	6 mm	6 mm
Available radius cutters	R2 - R3 - R4	R2 - R3 - R4
Available bevel heads	15° - 22,5° - 30° - 37,5° - 45° - 52,5° - 60°	15° - 22,5° - 30° - 37,5° - 45° - 52,5° - 60°
Power	600 W	
Battery capacity	-	5.0 Ah
Voltage	230 V (also available in 120 V)	18 V
Speed	adjustable speed 5.000 - 13.000 rpm	8000 rpm (with fully charged battery)
Weight	2,46 kg	2,63 kg without battery
Min. hole diameter for beveling	22 mm	22 mm
Min. hole diameter for rounding	16 mm	16 mm
Extras	-	Includes: 2nd battery and battery charger

# The new ABIS 3.0 bevel tools have unique features!

A precise and easy to use depth adjustment in 0,125 mm increments.

The new spindle locking button enables changing the router head within 35 seconds.

A freely rotating flange made of hardened (nitrated) steel.

While the ABIS-R is suitable for deburring, small bevels and rounding up to R4 the ABIS-B is the allrounder that can even bevel up to 6mm on 45°



## Pneumatic motor

ABIS-R 3.0



3.0

ABIS-B 3.0



3.0

Safety lever



Removable head with nitrated flange



Spindle locking button

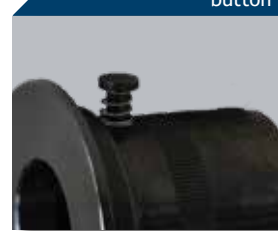

	ABIS-R 3.0	€ 628,-	ABIS-B 3.0	€ 839,-
Part no.	1123010		1123110	
Motor	Pneumatic		Pneumatic	
Max. bevel depth	±3 mm at 45°		6 mm	
Available radius cutters	R2 - R3 - R4		R2 - R3 - R4	
Available bevel heads	15° - 22,5° - 30° - 37,5° - 45° - 52,5° - 60°		15° - 22,5° - 30° - 37,5° - 45° - 52,5° - 60°	
Air pressure	6,3 bar   91 PSI		6,3 bar   91 PSI	
Recommended air flow	25 CFM   0,71 m3/min		25 CFM   0.71 m3/min	
Power	0,375 Kw		0,820 Kw	
Speed	25.000 rpm max		16.000 rpm max	
Weight	1,07 kg		1,13 kg	
Min. hole diameter for beveling	22 mm		22 mm	
Min. hole diameter for rounding	16 mm		16 mm	

## User experience - Roweko Staalconstructies B.V.

*“For me, saving time is a great benefit. With Beveltools, I can make a bevel or radius, with no further finishing. With grinding discs you take much longer and the end result is never as smooth as with Beveltools.”*

**R**oweko from Nootdorp specialises in making large steel constructions for applications such as bridges or buildings. Roweko uses Beveltools for both beveling and rounding.

Previously, this was always done with an angle grinder and grinding discs. According to René de Kok, owner of Roweko, this is fine but far from the best solution. “Grinding discs produce a lot of dust and take a very long time to achieve a flush or rounded finish. It is much faster with Beveltools. After taking a look at the different machines, I opted for the EBI-06 Premium and then later on the EBA-12 for the slightly heavier work.”

René and his colleagues immediately saw the advantages of Beveltools as compared with discs. “For me, the greatest advantages of Beveltools are: how much time they save and how easy they are to work with. With grinding discs, you just take too long to get a good result. Now I take the Beveltools beveling machine and make a bevel or radius with one movement. It works so quickly that a grinding disc simply can’t compare. Finishing is no

longer necessary either, which saves a lot of time. I use Beveltools mainly for steel, but they also work brilliantly with plastic,” says René.

Apart from the fact they save time, Roweko are also delighted with the improvement to the work environment. “The chips made by the Beveltools products are relatively large and immediately drop to the ground. We have no more issues with chips flying around and fine dust blown into the air. The machines also make quite a bit less noise.”

Like other metalworkers, Roweko often needs to observe the EN-1090 standard. Sharp edges in steel must be rounded before it can be galvanised and/or coated. “Beveltools simply deliver a great result. You would never get such a smooth edge with an angle grinder,” says René. “I recommend Beveltools for any business that regularly has to do rounding or beveling. It is no huge investment either. For a couple of hundred euros, you have a machine with bevel heads. It saves you so much time that you quickly recoup that investment.”

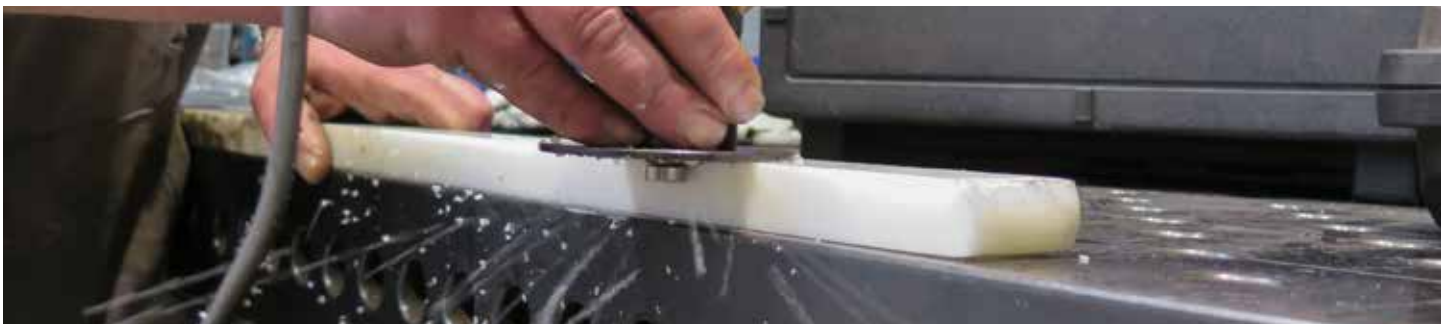

# Bevel Mite® bevel heads



	Steel bevel head	Aluminum bevel head	Version 3.0 bevel head
Type	15-06-STL *	15-06-ALU	
Part no.	7106000	7106010	
Price	€ 72. <sup>45</sup>	€ 103. <sup>95</sup>	
Type	22-06-STL *	22-06-ALU	
Part no.	7107000	7107010	
Price	€ 72. <sup>45</sup>	€ 103. <sup>95</sup>	
Type		30-06-ALU	30-06-v3.0
Part no.		7104010	7104030
Price		€ 103. <sup>95</sup>	€ 103. <sup>95</sup>
Type	37-06-STL *	37-06-ALU	
Part no.	7103000	7103010	
Price	€ 82. <sup>95</sup>	€ 114. <sup>45</sup>	
Type		45-06-ALU	45-06-v3.0
Part no.		7102010	7102030
Price		€ 114. <sup>45</sup>	€ 110. <sup>25</sup>
Type	52-06-STL *	52-06-ALU	
Part no.	7108000	7108010	
Price	€ 82. <sup>95</sup>	€ 114. <sup>45</sup>	
Type	60-06-STL *		
Part no.	7105000		
Price	€ 82. <sup>95</sup>		

\* STL versions- these will be phased out and can only be ordered as long as they are in stock. No back orders possible

# Bevel Mite® cutter heads with radius



	Steel radius cutter	Aluminum radius cutter	Version 3.0 radius cutter
Type		R2-06-ALU	R2-06-v3.0
Part no.		7101110	7101130
Price		€ 93. <sup>45</sup>	€ 99. <sup>75</sup>
Type		R3-06-ALU	R3-06-v3.0
Part no.		7101010	7101030
Price		€ 93. <sup>45</sup>	€ 99. <sup>75</sup>
Type	R4-06-STL *	R4-06-ALU	R4-06-v3.0
Part no.	7101200	7101210	7101230
Price	€ 82. <sup>95</sup>	€ 93. <sup>45</sup>	€ 99. <sup>75</sup>

\* STL versions- these will be phased out and can only be ordered as long as they are in stock. No back orders possible



## User experience from a Dutch metalworking company

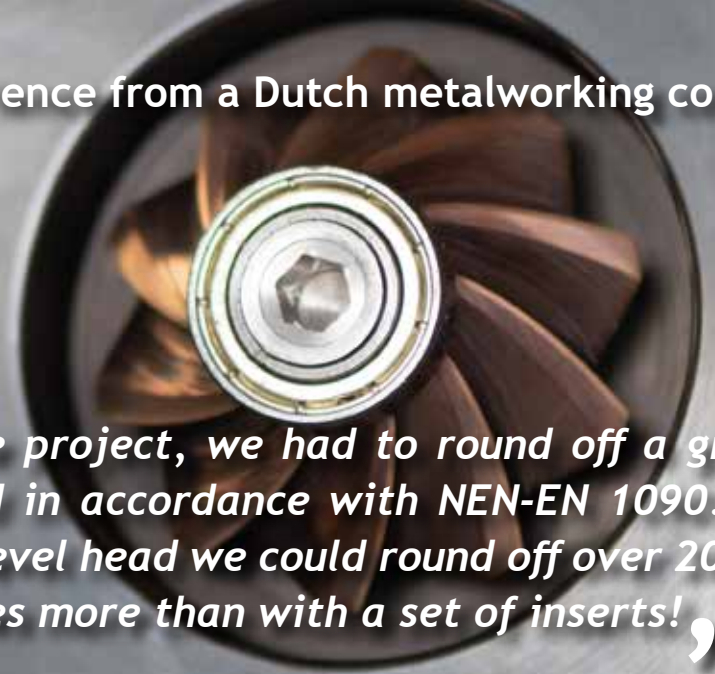

*“For a large project, we had to round off a great number of metres and in accordance with NEN-EN 1090. With just one Premium bevel head we could round off over 200 metres. That is four times more than with a set of inserts!”*

A metalworking company from the region of Utrecht used Beveltools for a large project. For one particular client, they had to produce different steel parts for electricity pylons. These electricity pylons, with a height of 55 to 75 metres, were recently fitted in several areas, including Achterhoek (The Netherlands).

The manager explains: “For this client we delivered the steel parts for the electricity pylons. These included a large number of connection rings, lifting eyes, bulkheads, brackets and attachment points used for the pylons.” Because these are load-bearing galvanised steel constructions, all parts must carry CE certification in accordance with NEN-EN 1090. This norm states the technical specifications to which the steel end products must adhere. Part of this norm stipulates that edges must be rounded with a minimum radius of 2 mm to obtain a greater bonding surface for coating.

“The connection rings must all be rounded in accordance with the EN 1090 norm. We chose to do this with radius 3 to achieve a better finish. The largest connection ring had a diameter of 2.5 metres, which makes a lot of metres to round off. I looked for a system with which I could quickly achieve radius 3 at a low cost. We didn’t have much experience with rounding, but for this project we delved into it and we decided to purchase

a machine,” says the manager. The machine had to be easy to handle and control, and not too expensive to use so that it would also make sense for smaller projects. Initially, the company had gone for a system with inserts.

However, they did not meet expectations. The service life promised was not achieved and the inserts had to be exchanged much too often. “Alternating the inserts takes an incredible amount of time, plus they are fragile so they broke all too often even before we’d used them for all cutting edges. The work took much longer and cost much more than I’d anticipated. Then I contacted Beveltools and immediately switched to this system, especially because of the single bevel head. The steel bevel heads by Beveltools lasted 2 to 2.5 times longer in our case than a set of inserts. When Beveltools showed us the Premium bevel head, we immediately started to use it. With just one Premium bevel head we could round off over 200 metres. That is four times more than with a set of inserts!”

For the metalworking company it is a huge advantage that the bevel heads are made up of one piece. You can swap the bevel head in the blink of an eye and because it has many cutting edges, machining goes really smoothly. “With Beveltools we were able to finish our work before the deadline and at an advantageous cost. Our client was delighted with the results.”



*“With a bur bit it took us on average 45 seconds to 1 minute to bevel a hole. Now, with the lightweight ABIS machine, it only takes us 7 to 10 seconds.”*



Located in El Dorado, KS, ConFab Incorporated, part of C-Tech Industrial Group, specializes in custom made pipe and steel construction for commercial, industrial and petrochemical applications.

Jesus Arredondo: “Before we purchased the Bevel Mite® ABIS-06 we were using a bur bit and it would take on average 45 seconds to 1 minute to bevel a 4 cm diameter hole. Now with this tool we are averaging 7 to 10 seconds per hole and that’s a lot in an 8 hour day.”



# Bevel Mate® 3.0 | for more intensive work

## The Bevel Mate® concept

The Bevel Mate® concept has been designed for heavy-duty beveling and radius work, like bevel up to a depth of 12 mm or radius 8mm. The Bevel Mate® machines are compact and powerful. Available in 2 types: with electric motor (EBA 3.0) or pneumatic motor (ABA 3.0).



Electric motor

EBA 3.0

3.0



	EBA 3.0
Part no.	2031110
Motor	Electric
Max. bevel depth	12 mm
Available radius cutters	R2 - R3 - R4 - R5 - R6 - R8
Available bevel heads	15° - 22,5° - 30° - 37,5° - 45° - 52,5° - 60°
Power	1,53 KW
Voltage	230 V (also available in 120 V)
Speed	5000 - 10.000 rpm
Weight	4,5 kg
Min. hole diameter for beveling	41 mm
Min. hole diameter for rounding	22 mm

€ 1.048



The Bevel Mate® concept works 50% faster and considerably quieter than with a sanding disc and all without grinding dust. The end result is exact in radius and without burrs, so no post-processing is required.



Pneumatic motor

### ABA 3.0

3.0



€ 1.499

	ABA 3.0
Part no.	2042000
Motor	Pneumatic
Max. bevel depth	12 mm
Available radius cutters	R2 - R3 - R4 - R5 - R6 - R8
Available bevel heads	15° - 22,5° - 30° - 37,5° - 45° - 52,5° - 60°
Air pressure	6,3 bar
Recommended air flow	38 CFM   1,1 m3/min
Power	1,1 KW
Speed	11.000 rpm max
Weight	4,40 kg
Min. hole diameter for beveling	41 mm
Min. hole diameter for rounding	22 mm



# Bevel Mate® bevel heads



	Steel bevel head	Aluminum bevel head	Version 3.0 bevel head
Type	15-08-STL *	15-08-ALU	
Part no.	7205000	7205010	
Price	€ 93. <sup>45</sup>	€ 131. <sup>25</sup>	
Type	22-08-STL *	22-08-ALU	
Part no.	7206000	7206010	
Price	€ 93. <sup>45</sup>	€ 131. <sup>25</sup>	
Type	30-08-STL *	30-08-ALU	30-08-v3.0
Part no.	7204000	7204010	7204030
Price	€ 93. <sup>45</sup>	€ 131. <sup>25</sup>	€ 141. <sup>75</sup>
Type		37-08-ALU	37-08-v3.0
Part no.		7203010	7203030
Price		€ 141. <sup>75</sup>	€ 141. <sup>75</sup>
Type		45-08-ALU	45-08-v3.0
Part no.		7202010	7202030
Price		€ 166. <sup>95</sup>	€ 162. <sup>75</sup>
Type	52-08-STL *	52-08-ALU	
Part no.	7208000	7208010	
Price	€ 114. <sup>45</sup>	€ 166. <sup>95</sup>	
Type	60-08-STL *	60-08-ALU	
Part no.	7207000	7207010	
Price	€ 114. <sup>45</sup>	€ 166. <sup>95</sup>	

\* STL versions- these will be phased out and can only be ordered as long as they are in stock. No back orders possible

# Bevel Mate® bevel heads



	Steel bevel head	Aluminum bevel head	Version 3.0 bevel head
Type		15-12-ALU	15-12-v3.0
Part no.		7305010	7305030
Price		€ 177. <sup>45</sup>	€ 173,00
Type	22-12-STL *	22-12-ALU	
Part no.	7306000	7306010	
Price	€ 131. <sup>25</sup>	€ 177. <sup>45</sup>	
Type		30-12-ALU	30-12-v3.0
Part no.		7304010	7304030
Price		€ 177. <sup>45</sup>	€ 173. <sup>25</sup>
Type		37-12-ALU	37-12-v3.0
Part no.		7303010	7303030
Price		€ 187. <sup>95</sup>	€ 187. <sup>95</sup>
Type		45-12-ALU	45-12-v3.0
Part no.		7302010	7302030
Price		€ 208. <sup>95</sup>	€ 198. <sup>45</sup>
Type	52-12-STL *	52-12-ALU	52-12-v3.0
Part no.	7308000	7308010	Only available on request
Price	€ 166. <sup>95</sup>	€ 208. <sup>95</sup>	
Type	60-12-STL *	60-12-ALU	60-12-v3.0
Part no.	7307000	7307010	7307030
Price	€ 166. <sup>95</sup>	€ 208. <sup>95</sup>	€ 198. <sup>45</sup>

\* STL versions- these will be phased out and can only be ordered as long as they are in stock. No back orders possible

# Bevel Mate® cutter heads with radius



	Steel radius cutter	Aluminum radius cutter	Version 3.0 radius cutter
Type	R2-08-STL	R2-08-ALU	R2-08-v3.0
Part no.	7201100	7201110	7201130
Price	€ 124. <sup>95</sup>	€ 131. <sup>25</sup>	€ 136. <sup>50</sup>
Type	-	R3-08-ALU	R3-08-v3.0
Part no.	-	7201010	7201030
Price		€ 131. <sup>25</sup>	€ 136. <sup>50</sup>
Type		R4-08-ALU	R4-08-v3.0
Part no.		7201210	7201230
Price		€ 131. <sup>25</sup>	€ 136. <sup>50</sup>
Type	-	R5-08-ALU	R5-08-v3.0
Part no.	-	7201310	7201330
Price		€ 177. <sup>45</sup>	€ 166. <sup>95</sup>
Type	-	R6-10-ALU	R6-10-v3.0
Part no.	-	7201410	7201430
Price		€ 177. <sup>45</sup>	€ 187. <sup>95</sup>
Type	-	R8-12-ALU	R8-12-v3.0
Part no.	-	7201610	7201630
Price		€ 219. <sup>45</sup>	€ 219. <sup>45</sup>

\* STL versions- these will be phased out and can only be ordered as long as they are in stock. No back orders possible

“ We work a lot with harder metals and laser-cut steel. The Bevel Mate® EBA, because of its long service life, is ideal for rounding holes in our pieces. ”

At Jos van den Bersselaar Constructie B.V. in Udenhout, quality has always been paramount and ultimately it became a specialism: not supplying steel, but solutions. The company specializes in high-performance, lightweight structures made of steel aluminum and stainless steel.

Lots of holes have to be rounded in these structures. This rounding should have a constant radius of at least 2 mm, because the workpieces are galvanized and coated. In the past this regularly resulted in major challenges. It cost the company a lot of time and effort to supply the expected high quality using a machine with inserts.

After watching a demonstration of the Bevel Mate® EBA, they were immediately enthusiastic and a second machine was purchased within six months. This was the perfect solution to their issue.

Maarten van de Wouw, CWL: “The machine with inserts would already be blunt after using it 2 to 3 times, so that did not work for us. We work a lot with hard materials and laser-cut steel. The Bevel Mate® EBA is truly ideal for rounding the holes in workpieces because of the long service life and its high level of user-friendliness. We are very happy that we can now supply our high quality to our customers without issues.”



# Bevel Mite® INOX

The 2 new BevelMite INOX tools are lightweight and easy to use

Great results on INOX when you need smaller welding edges

Perfect roundings up to radius 4mm

A precise depth adjustment in 0,125 mm increments.

A flange head of QPQ nitrated stainless steel with a freely rotating flange.

Available in 230V and 120V with US or UK plug.



Electric motor



Pneumatic motor

EBI INOX

€ 999,-



ABIS INOX

€ 999,-



Spindle locking button



Freely rotating and nitrated flange

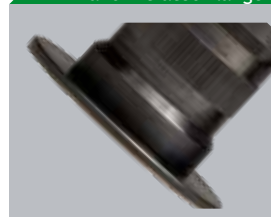

Adjustable RPM on EBI



	EBI INOX	ABIS INOX
Part no.	1051000	1125110
Motor	Electric	Pneumatic
Max. bevel depth	6 mm	6 mm
Available radius cutters	R2 - R3 - R4	R2 - R3 - R4
Available bevel heads	30° - 45°	30° - 45°
Power	600 W	820 Wat
Air pressure	-	6,3 bar   91 PSI
Air consumption	-	0,62 M3/min
Voltage	230 V (also available in 120 V)	-
Speed	adjustable speed 2700 - 6000 rpm	Max. 6.000 rpm
Weight	2,46 kg	1,5 kg
Min. opening diameter for beveling	22 mm	22 mm
Min. opening diameter for rounding	16 mm	16 mm



# Bevel Mate® INOX | for more intensive work

## The Bevel Mate® concept

The Bevel Mate® concept has been designed for heavy-duty beveling and radius work. Bevel up to a depth of 8 mm or a radius of 6mm on stainless steel.

The Bevel Mate® machines are compact and powerful. Available only in an electric versions 230V and 120V.



Electric motor

## EBA INOX

€ 1599,-



Flangehead with depth adjustment



Extra sturdy handle



Nitrated and freely rotating flange































	EBA INOX
Part no.	2051100
Motor	Electric
Max. bevel depth	8 mm
Available radius cutters	R2 - R3 - R4
Available bevel heads	30° - 37,5° - 45°
Power	1,10 KW
Voltage	230 V (also available in 120 V)
Speed	1100 - 3600 rpm
Weight	5,65 kg
Min. opening diameter for beveling	41 mm
Min. opening diameter for rounding	22 mm



# Beveltools available INOX cutters

	BevelMite® 6mm	BevelMate® 8mm
--	----------------	----------------

	 	 
Type	R2-06-INOX	R2-08-INOX
Part no.	7101150	7201150
Price	€ 118. <sup>00</sup>	€ 157. <sup>50</sup>
	 	 
Type	R3-06-INOX	R3-08-INOX
Part no.	7101050	7201050
Price	€ 118. <sup>00</sup>	€ 157. <sup>50</sup>
	 	 
Type	R4-06-INOX	R4-08-INOX
Part no.	7101250	7201250
Price	€ 118. <sup>00</sup>	€ 157. <sup>50</sup>
		 
Type	-	R6-10-INOX
Part no.	-	7201450
Price		€ 303. <sup>59</sup>
	 	pictures not available
Type	30-06-INOX	30-08-INOX
Part no.	7104050	7204050
Price	€ 135. <sup>00</sup>	€ 182. <sup>95</sup>
		 
Type	-	37-08-INOX
Part no.	-	7203050
Price		€ 196. <sup>95</sup>
	 	 
Type	45-06-INOX	45-08-INOX
Part no.	7102050	7202050
Price	€ 127. <sup>50</sup>	€ 219. <sup>95</sup>



## User experience - CIG Groningen

“ The combination of the further developed machine and the special INOX 30° milling cutter resulted in a rework-free welding edge .....

”

CIG from Groningen is a renowned global player when it comes to architectural constructions and works of art. The construction techniques used by CIG make it possible for architects and artists worldwide to make beautiful constructions, including stainless steel. CIG projects can be found at [www.cig-eu.com](http://www.cig-eu.com).

CIG is one of the companies where we had the opportunity to test our new INOX concept and use their experience to fine-tune our solutions. The workshop manager told us that after being approached by the Dutch dealer of Beveltools, he was very curious if the new solution could be helpful in the assembly/production.

The workshop manager explains: “Even for the current stainless steel project, many edges have to be processed so that they have a weld edge of 30°. If you look at our projects, it will come as no surprise that a lot of precision is required when it comes to the perfect weld edge. The first prototype that we put into use (spring 2022) was already doing quite well, but could actually only be tested with the existing v3.0 milling cutters for normal structural steel. Fortunately, our feedback would lead to a modified and improved version of the prototype which we received a few weeks later. We received these at the same time as a number of new test cutters that were also specifically developed for use on stainless steel.

This made us happy: the combination of the further developed machine and the special INOX

30° cutter resulted in a rework-free welding edge and an unexpectedly long service time of these new cutters. It was amazing how fast and quiet the combination was in use. Beveltools also succeeded in virtually eliminating vibrations during processing, which was much appreciated by our colleagues who work with it.

August 2022: “We could only be enthusiastic and have already decided to place an order for 2 new EBA INOX machines and 100 pieces of 30-08-INOX cutters. Unfortunately, we only have to wait until everything is available.”



Fenix II in Rotterdam - MAD Architects - ready by end 2023

# Beveltools | Q-FIN TOP EDGE

## Table milling machine.

The table milling machine is the result of the long existing cooperation between Q-Fin and Beveltools. The Top Edge is a proven concept and with the new developed flange head by Beveltools we brought it to the next level of perfection. It offers a perfect solution for smaller objects and/or repeating work.

It's a manually operated machine with which you can easily and quickly mill various radii or weld edges at various angles. The motor has a steplessly adjustable speed and a clamping table. Workpieces can be clamped firmly on the table by regular clamps or by the included electromagnets which can be switched on/off very easily and quick. To guarantee a safe working environment we added a two-button control on the handle. It enables your staff to operate this machine on the most comfortable way, it takes away the use of force and carrying the machine for longer periods of time. Because the TopEdge machine has wheels it can be positioned wherever you needed it.

The Beveltools TopEdge has been developed together with Q-Fin to quickly provide your workpiece with a perfect angle or radius provided by the BevelMate® cutters. You can use all available BevelMate® cutters (8mm & 12mm) on the Beveltools TopEdge.



- Mobile setup
- Standard with welding table hole pattern
- 4 raisable electromagnets
- 1.1 kW motor with frequency control
- Workpiece width: max. 780 mm/length unlimited
- Power consumption of the machine: 400 V, 50 Hz, 10 A, 6 kW
- Dimensions: 1435 x 1100 x 1510 mm (L x W x H)
- Weight: 445 KG
- Optional with nebulizer flange head

# TOP EDGE OPTIONS



Although the Beveltools TopEdge is quite heavy ( $\pm 450\text{Kg}$ ) it's still flexible because of its castor wheels. So you can change the position of the unit depending on the situation. Do you want it close to where the workpieces are cut? No problem just put it nearby and save time needed for internal transport. With the

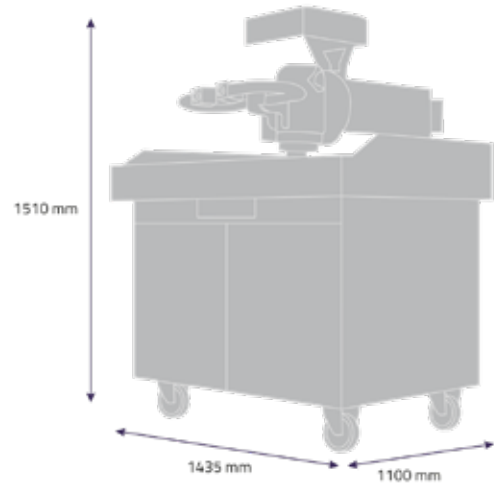

The Beveltools TopEdge can be ordered with the Beveltools flange head that comes with an integrated oil nebulizer.

With this option you can spray a very small amount of oiled air around the cutter in order to improve the service time of the cutter even more. Another great development made by Beveltools!

The oil compartment and lubricator pump are located inside the table and are integrated in the table's power supply.

**CALL for  
availability and  
lead times!**



# Bevel Mate® Guide

## More stability when machining metal

The Bevel Mate® Guide has been specially developed to give you perfect lateral guidance for beveling and rounding. This attachment gives your Bevel Mate® machine even more stability when machining metal.

The wear-resistant POM guiding blocks increase the running surface, thereby offering increased support both on sheet material and round pipes. Especially if many meters of material are being machined sequentially, this attachment offers extra stability. Equally, because of its special design, the discomfort of flying chips is reduced.

This unique accessory is simple to fit on the flange head and is made of top-grade nitrided stainless steel. With the use of POM plastic guiding blocks scratches on the material are prevented. Thanks to the open underside, the bevel head is still simple to swap.

The Bevel Mate® Guide is a separate attachment for your EBA or ABA machine.



Part no. 8233300



# Accessories

In addition to the range of machines and cutting tools, we also offer a series of accessories.



## Flange heads

These are available for all 3.0 machines. Nitrided and with freely rotating flange, which is also QPQ® hardened. So can be used on stainless steel.

Part name	Art. nr.	Prijs
Flange head for all EBA's & ABA's	8233010	€ 204. <sup>75</sup>
Flange head for EBI 3.0 & EBI-C 3.0	8232010	€ 183. <sup>75</sup>
Flange head for ABIS-R 3.0 & ABIS-B	9140201	€ 130. <sup>75</sup>



## POM guide blocks

The guide blocks, made of wear-resistant POM plastic, are used on the Bevel Mate® Guide. Set of 2 pieces, including mounting screws.

Part name	Art. nr.	Prijs
Guide blocks POM	9233300	€ 36. <sup>70</sup>



## Sacrificial adapters

All 3.0 machines have an adapter with shear pin for mounting the cutter. When damaged these can be easily replaced. Available repair-sets:

Part name	Part no.	Price
Adapter repair set EBA 3.0 *	9700211	€ 21. <sup>00</sup>
Adapter repair set ABA 3.0 *	9330153	€ 20. <sup>00</sup>
Adapter repair set EBI 3.0 & EBI-C 3.0 *	9150125	€ 25. <sup>00</sup>
Adapter rep. set ABIS-R 3.0 & ABIS-B 3.0 *	9140127	€ 21. <sup>00</sup>
* contains: 1x adapter, 5x pin, 2x set screw and 2x bolts		



## Guide bearings

The guide bearings are available individually and in 5 different sizes. (9400014 not shown on picture)

Part name	Part no.	Price
Guide bearing xx-06-C for all 6mm cutters	9400003	€ 15. <sup>75</sup>
Guide bearing xx-08B-C for bevel cutters	9400006	€ 15. <sup>75</sup>
Guide bearing xx-08R-C for R2-R3-R4 cutters	9400005	€ 15. <sup>75</sup>
Guide bearing xx-12-C for bevel cutters	9400004	€ 15. <sup>75</sup>
Guide bearing xx-R6R8-12-C for R6/R8 cutters	9400014	€ 15. <sup>75</sup>





# Beveltools The Game Changer

## History

2013 was an exciting year. An American-Korean duo of inventors developed a revolutionary new bevel tool. This created a new standard for rounding and beveling metal. Entrepreneur Jan Enno Hofman recognized the quality and the innovative application of it, leading to the incorporation of Beveltools in 2015.

## Future

The current team of specialists is continuously busy developing new solutions. It must be possible to make beveling and rounding metal easier, more accurate, faster and cheaper. The daily struggles one faces when rounding and beveling metal creates our drive to provide tools that can be used to create perfect end results. The basic assumptions used here are cost and time savings, but also user-friendliness.





THE PLACE TO BE FOR THE METAL INDUSTRY

De Tonne 89-91 • Industriezone 5 • 9800 Deinze

T 09 386 69 31 • F 09 380 38 41

info@vamatec.be  visit us online [www.vamatec.be](http://www.vamatec.be)



**ABA 3.0**  
PNEUMATIC TOOL



[www.beveltools.com](http://www.beveltools.com)