



WELCOME WILLKOMMEN

SOLID CARBIDE
KERAMIK
GEWINDEDREHEN
FRÄSEN
VOLLHARTMETALL
CERAMIC TOOLS
DREHEN
PARTING AND GROOVING
TOOLING SYSTEMS
AB- UND EINSTECHDREHEN
BOHRER
DRILLS
THREADING
PSC
MILLING
AUFNAHMEN
TURNING

TURNING DREHEN

Highlights

New turning line

Canela is launching a completely new turning line that provides a complete solution for all types of applications and materials with new insert geometries, combined with upgraded carbide grades. The innovative turning solutions that Canela is offering are designed to meet the high customer demands for tool life and productivity.



Neue Linie zum Drehen

Canela führt eine komplett neue Linie zum Drehen ein, die eine komplette Lösung für alle Typen von Anwendungen und Materialien bietet, mit neuen Einsatzgeometrien kombiniert mit verbesserten Hartmetall-Sorten. Die innovativen Drehlösungen, die Canela anbietet, sind so konzipiert, daß sie den hohen Kundenanforderungen an Werkzeug-Standzeiten und Produktivität gerecht werden.

WDM..

Wide range of toolholders and cartridges, which allow multiple combinations for all grooving needs. Easy to use modular blade system that offers ultimate rigidity and accuracy for stability when grooving and side turning. The V-system ensures that the blade is securely fixed, giving high rigidity for stable grooving.

Ein breites Sortiment an Haltern und Kurzklemmhaltern, die vielfältige Kombinationsmöglichkeiten für alle Einstechbedürfnisse ermöglicht. Ein einfach zu anwenden modulares Schneidsystem, welches die optimale Starrheit und Genauigkeit beim Einstechen und Längsdrehen anbietet. Das V-System garantiert, dass der Messer sicher befestigt ist, was dann eine hohe Starrheit für stabiles Schlitzzen gewährleistet.

Für weitere Informationen, siehe Seiten B20 bis B25

For more information see pages B20 to B25



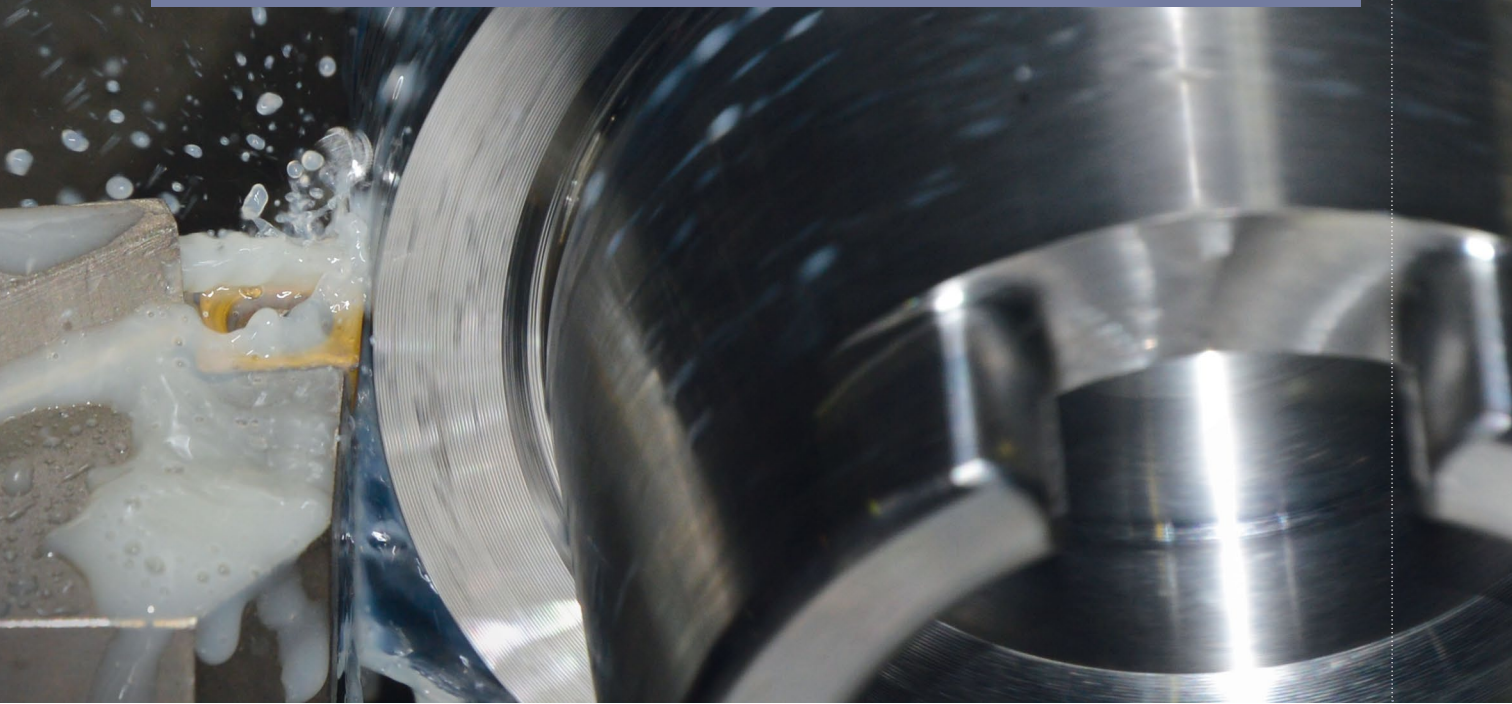

Flow-master

The Flow-Master coolant system works by delivering the machine coolant with maximum efficiency. The volume and speed of coolant coming out direct to the insert cutting edge improves machining performance.

Flow-Master tooling is extremely effective removing heat from the cutting edge, cooling the chips rapidly and helping to break them faster. Chips with poor heat removal are malleable and flexible, not breaking properly and adding extra heat to the cutting edge.

Das Flow-Master Kühlmittel-System bringt das Kühlmittel mit maximaler Effizienz an die Schneide. Das max. Volumen des Kühlmittels wird mit hohem Druck direkt an die Schneidkante geführt und verbessert die Bearbeitungsleistung.

Dieses System ist äußerst effektiv, da es die Wärme von der Schnittkante schnell abführt, Späne werden schneller abgekühlt und brechen dadurch besser. Späne mit einer schlechten Wärmeabfuhr sind verformbar und flexibel, brechen nicht richtig und leiten weniger Wärme von der Schnittkante ab.

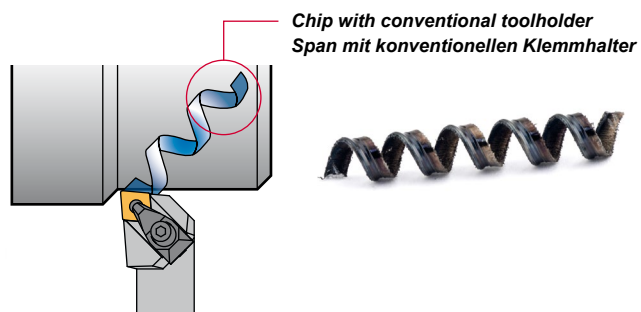
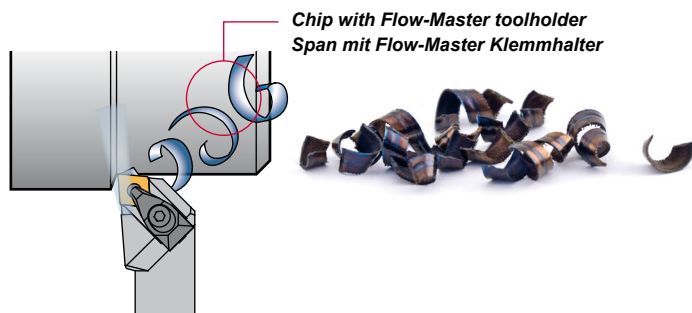

MILLING FRÄSEN

Highlights

Ecomill 45°

The Ecomill series features a highly effective 45 degree face mill with very strong square inserts with positive cutting angles. The result is effective machining and lower costs thanks to its 8-cornered inserts. Diameter range of 50-500 mm.

For more information see pages F26 and F27

Die Ecomill Serie bietet einen hochwirksamen 45-Grad-Planfräser mit sehr starken vierkantigen Wendeschneidplatten mit positiven Schnittwinkel an. Das Ergebnis ist eine effektive Bearbeitung und geringere Kosten dank der Wendeschneidplatten mit 8 Schneidkanten. Durchmesser-Bereich von 50 bis 500 mm.

Für weitere Informationen, siehe Seiten F26 und F27

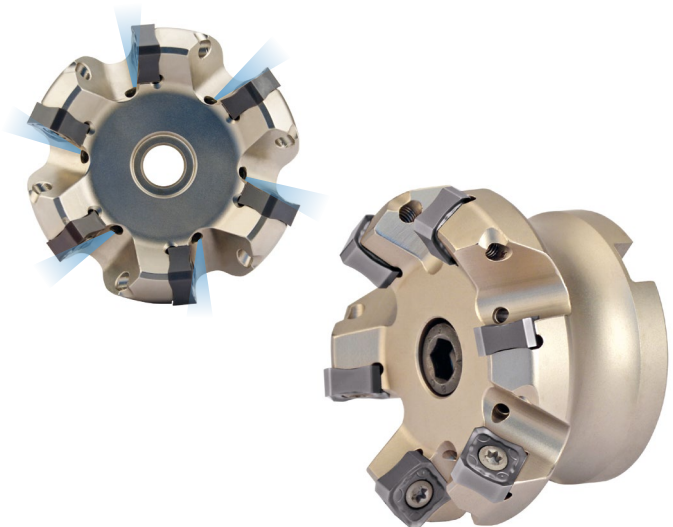

Ecomill 90°

Ecomill is a highly efficient double-sided 90-degree shoulder face mill with negative inserts, but with positive cutting angles. This is a low cutting force cutter, where both sides of the insert can be used to benefit the overall economy.

For more information see pages F66 to F71

Ecomill ist ein hoch effizienter doppelseitiger 90-Grad-Eck- und Planfräser mit negativen Wendeschneidplatten, aber mit positiven Schnittwinkeln. Dieser Fräser braucht niedrige Schnittkräfte, und es können beide Seiten der Wendeschneidplatten verwendet werden, um Kosten zu sparen.

Für weitere Informationen, siehe Seiten F66 bis F71

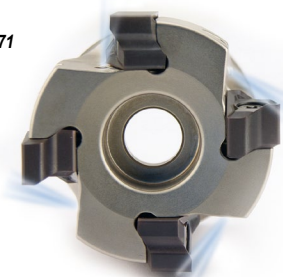



Mill-Plus

The Mill-Plus insert features a high helix sharp cutting edge, which in turn provides fast metal removal.

Mill-Plus milling cutters can be used for very steep helical interpolations for penetration into deep cavities.

For more information see pages F84 to F87

Die Mill-Plus Wendeschneidplatte verfügt über eine stark spiralförmige Schneidkante, die wiederum eine schnelle Metallentfernung ermöglicht.

Die Mill-Plus Fräser können zum Bohrzirkularfräsen eingesetzt werden, für die Bearbeitung von tiefen Kavitäten.

Für weitere Informationen, siehe Seiten F84 bis F87

Chamfer-Plus

Chamfers, V-cuts, undercuts, preparation for welding, and deburring operations along the workpiece edges are frequent operations. Depending upon the type of machine and set-up, these operations can be performed in a variety of ways. Chamfer-Plus is suitable when a long edge cutter is needed.

For more information see page F45

Fasen, V-Schnitte, Gewindefreistriche, Vorbereitung zum Schweißen und Entgraten entlang der Werkstückkanten sind häufige Anwendungen. Je nach Art der Maschine und Aufspannung können diese Bearbeitungen auf unterschiedliche Weise durchgeführt werden. Chamfer-Plus ist geeignet, wenn man einen Walzenstirnfräser braucht.

Für weitere Informationen, siehe Seite F45

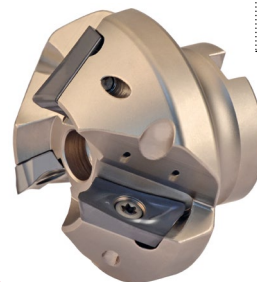
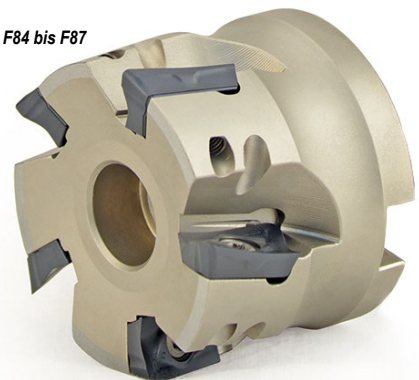

PSC

Highlights

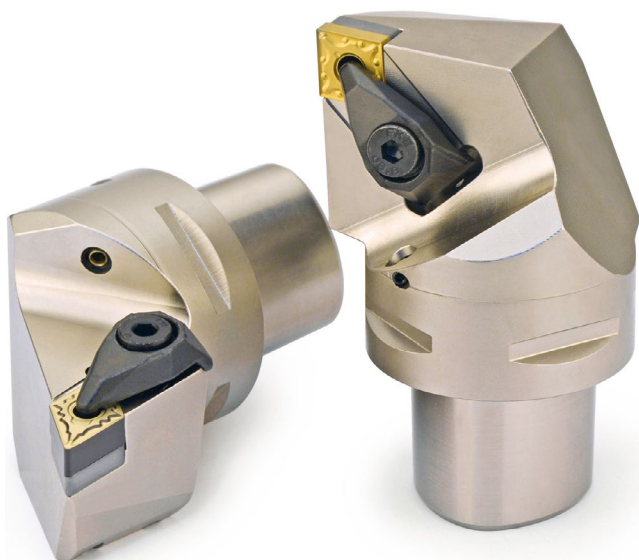

PSC ISO 26623-1

Canela presents its range of PSC tools and holders. These tools are widely used for the most productive machining operations on lathes with either manual or automatic tool changers, multitask machining centers and vertical turn-mill machines. Both quick change adaptation systems include integral shank tools and a wide variety of stationary and rotating machine turret and spindle adapters, extensions, reducers and toolholders.



Canela stellt seine Palette von PSC-Werkzeuge und -Aufnahmen vor. Diese Werkzeuge werden für die meist produktivere Zerspanung auf Drehmaschinen mit manuellem oder automatischem Werkzeugwechsler, auf Multitasking-Bearbeitungszentren und auf vertikalen Fräsmaschinen verwendet. Beide Schnellwechsel-Systeme bestehen aus PSC-Werkzeugen und einer Vielzahl von statischen und rotierenden Adaptern, Verlängerungen, Reduzierhülsen und Aufnahmen für Maschinenrevolver und Spindeln.



TOOLING AUFNAHMEN

Highlights



Member of CANELA Group
Unternehmen der CANELA Gruppe

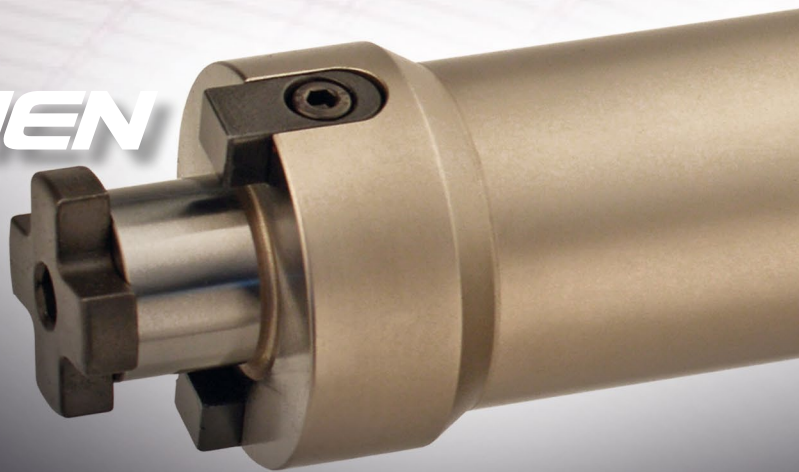

DIN 69871-A

Characteristics:

Cylindrical antivibratory shell mill adaptors. DIN 69871-A

For cutters with driving slot DIN 138.

Special for mould and die makers

Vibration reduced up to 60% compared to any other conventional shell mill adaptor, as they are manufactured with materials and mechanisms having antivibration properties.

For more information see pages I35 to I37

Eigenschaften:

Zylindrische schwingungsgedämpfte Aufsteckfräsdorne. DIN 69871-A
Für Fräser mit Quernut DIN 138.

Besonders empfohlen für Werkzeug- und Formenbau

60% weniger Schwingungen im Vergleich mit anderen konventionellen Aufsteckfräsdornen, da diese Ausführung mit schwingungsdämpfenden Materialien und Mechanismen hergestellt wird.

Für weitere Informationen, siehe Seiten I35 bis I37



A11.160

JIS B 6339-BT





Antivibratory shell mill adaptors
Schwingungsgedämpfte Aufsteckfräsdorne

HSK DIN 69893-1

Characteristics:

Cylindrical antivibratory shell mill adaptors. HSK DIN 69893-1

For cutters with driving slot DIN 138.

Special for mold and die makers.

For more information see pages 182 to 183

Eigenschaften:

Zylindrische schwingungsgedämpfte Aufsteckfräsdorne. HSK DIN 69893-1

Für Fräser mit Quernut DIN 138.

Besonders empfohlen für Werkzeug- und Formenbau.

Für weitere Informationen, siehe Seiten 182 bis 183



PSC ISO 26623-1

MATERIAL:

- Chromium-manganese carburized steel 1.7131 (16MnCr5).

EXECUTION:

- Carburized, hardened and tempered.
- Surface hardness HRC 58±2 (670±40 HV30)
- Depth of carburized layer minimum 0,5 mm.
- Tensile strength in core minimum 800 N/mm² after carburizing.

ACCURACY:

- Taper according to DIN 254
- Taper angle: tolerance AT 3 DIN 7178 part 1 and DIN 2080 part 1.
- Other tolerances according to DIN 7160 and 7168.
- Taper surface roughness RZ<0,001 mm.

For more information see pages E100 to E125

MATERIALIEN:

- Legierter aufgekohlter Stahl mit Chrom-Mangan 1.7131 (16MnCr5).

KONSTRUKTIONSDATEN:

- Aufgekühlt, gehärtet und angelassen.
- Oberflächenhärte HRC 58±2 (670±40 HV30)
- Aufgekühlt auf minimum 0,5 mm Tiefe.
- Zugfestigkeit im Kern minimum 800 N/mm² nach der Aufkohlung.

GENAUIGKEIT:

- Dorn nach DIN 254
- Kegelwinkel: Toleranz AT 3 DIN 7178 Teil 1 und DIN 2080 Teil 1.
- Andere Toleranzen entsprechend DIN 7160 und 7168.
- Rauigkeit der Oberfläche RZ<0,001 mm.

Für weitere Informationen, siehe Seiten E100 bis E125

SOLID CARBIDE VOLLHARTMETALL

ALBERG

Member of CANELA Group
Unternehmen der CANELA Gruppe

**HIGH PERFORMANCE
HOCHLEISTUNG**



6230



6240



6440



6054



6064



6164



6022



6023



6043



6143



6243



6342



6343



6322



6323



6324



6325



**SOLID CARBIDE
VOLLHARTMETALL**



**DRILLS
BOHRER**



**OTHERS
ANDERE**



CERAMIC KERAMIK

Highlights

Ceramic milling cutters

Ceramic inserts run faster than carbide inserts, so productivity is highly increased in high-temperature machining.

Fräser für Keramik-Wendeschneidplatten

Die Keramik-Wendeschneidplatten arbeiten schneller als die Hartmetall-Wendeschneidplatten. Auf dieser Weise erhöht sich die Produktivität bei hohen Temperaturen.

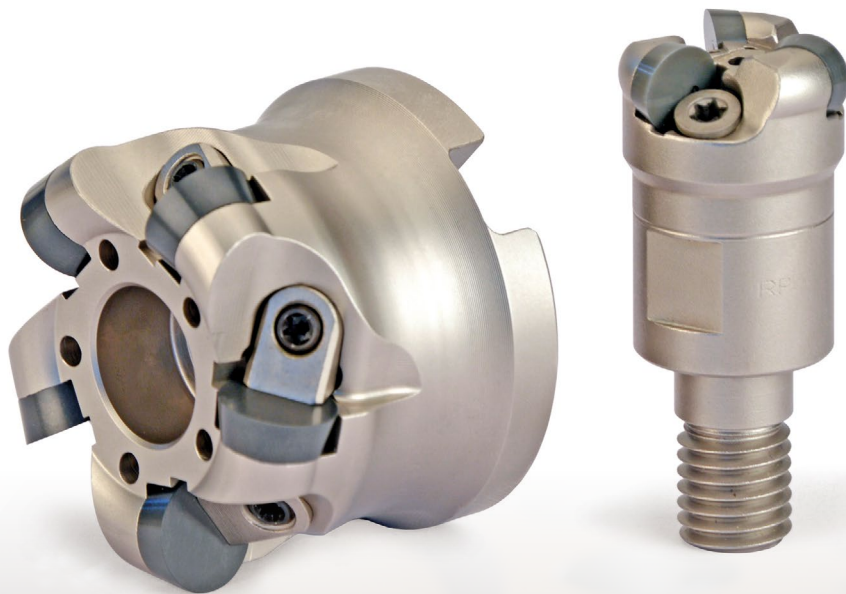

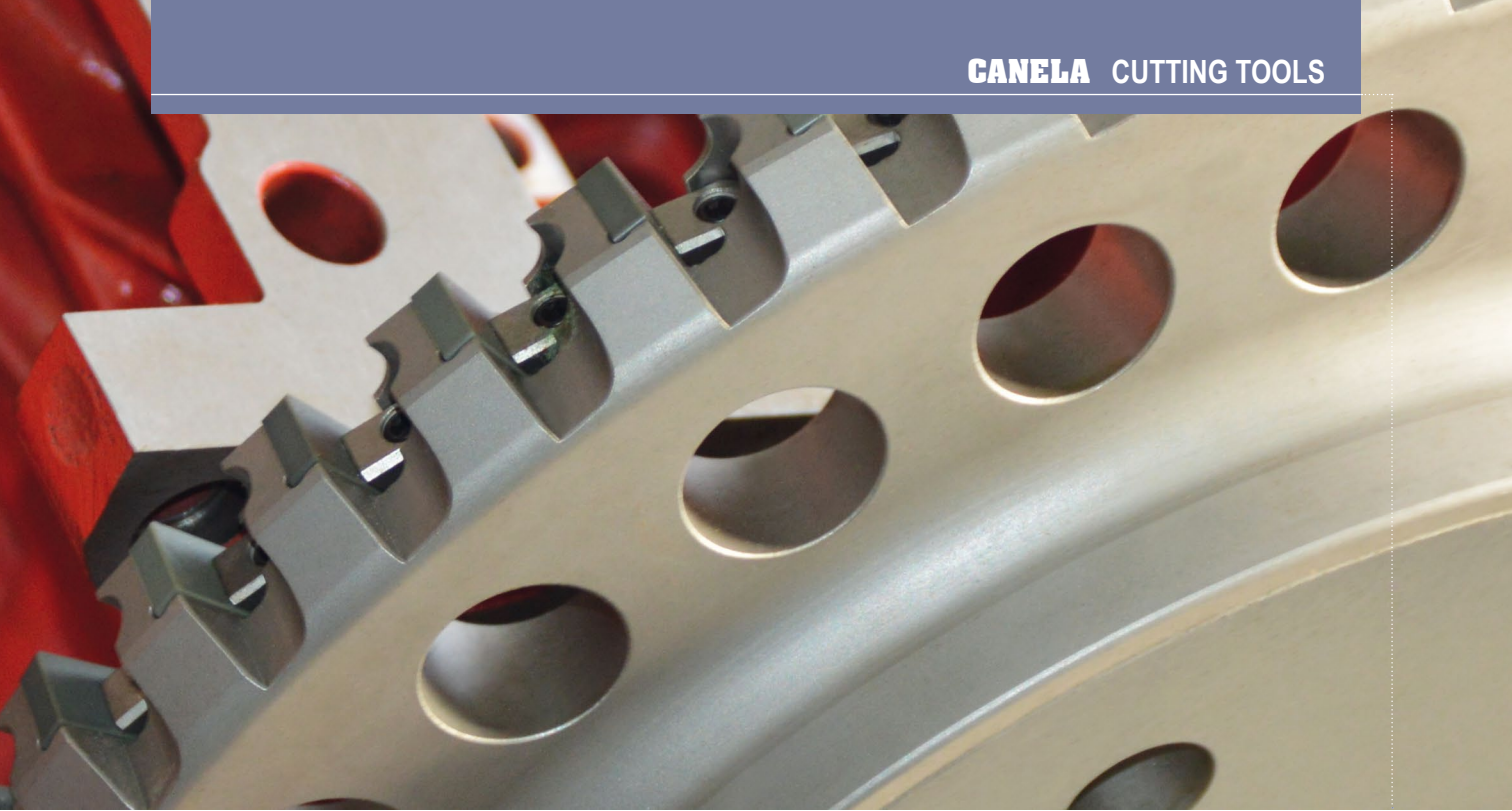

Ceramic tool systems

Canela ceramic clamping systems enable productive turning of cast iron, steel, hardened steels and other difficult to machine materials.

Three proven clamping systems support customers in all machining tasks.

Keramik-Werkzeugsysteme

Die Canela Keramik-Klemmsysteme ermöglichen eine produktive Zerspanung von Guß, Stahl, gehärteten Stählen und andere schwer zu zerspanenden Materialien. Drei erprobte Klemmsysteme unterstützen die Kunden bei allen Zerspanungsaufgaben.

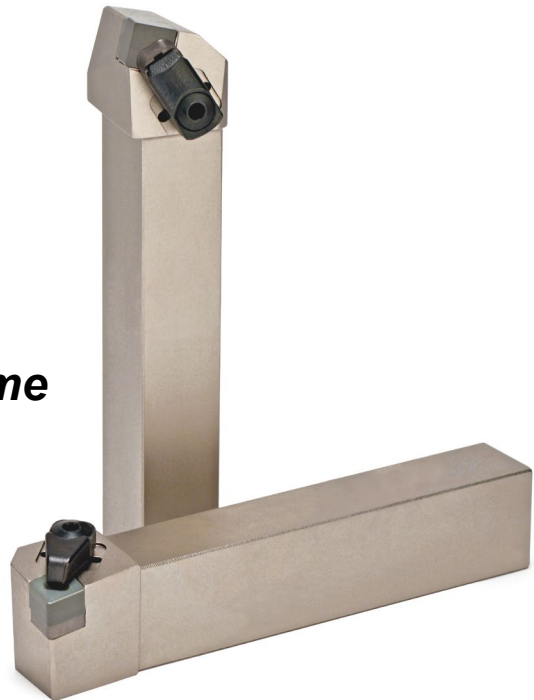

SPECIALS ***SONDERWERKZEUGE***

Highlights

AEROSPACE

Canela develops innovative tooling solutions for aerospace. The range includes tools for lighter materials that reduce airframe weight, materials such as high temperature alloys, composite materials, and aluminum alloys. Canela produces tooling products for a variety of applications uniquely suited for high efficiency machining of super alloys as well as other difficult-to-machine aerospace materials.

LUFT- UND RAUMFAHRT

Canela entwickelt innovative Werkzeuglösungen für die Luft- und Raumfahrt. Das Sortiment umfasst Werkzeuge für leichtere Materialien, die das Gewicht des Flugwerks reduzieren, wie Hochtemperatur-Legierungen, Verbundwerkstoffe und Aluminiumlegierungen. Canela produziert Werkzeuge für eine Vielzahl von Anwendungen, die für die hocheffiziente Bearbeitung von Superlegierungen und von anderen schwer bearbeitenden Materialien für die Luft- und Raumfahrt besonders geeignet sind.



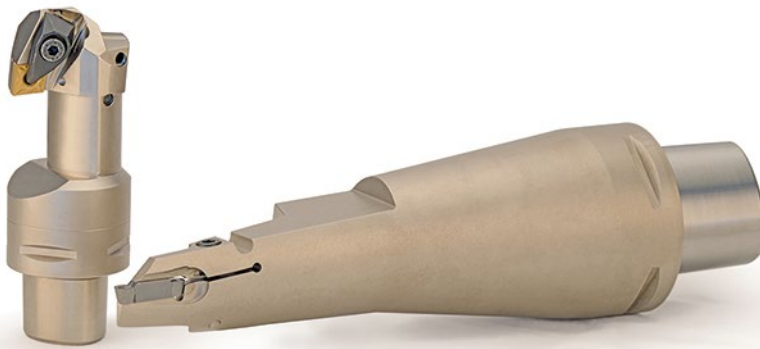

AUTOMOTIVE

Canela supplies special tools for all machining needs, taking into consideration the characteristics of machine tool, workpiece and cycle time. Our cutting tools specialists support initial tooling set-up, test periods and analyze machining processes in existing machine lines.

AUTOMOBIL-INDUSTRIE

Canela liefert Sonderwerkzeuge für alle Bearbeitungsanforderungen unter Berücksichtigung der Eigenschaften von Werkzeugmaschine, Werkstück und Zykluszeit. Unsere Schneidwerkzeuge-Spezialisten unterstützen sowohl die erste Werkzeug-Einrichtung, als auch die Testzeiten, und analysieren auch die Bearbeitungsprozesse bei den bestehenden Maschinenanlagen.



DRILLING BOHREN

Highlights

Drills

Brand new square insert design for maximum drilling efficiency. Excellent cutting performance and chip control due to the optimized geometry and chip breaker of the inserts, central and peripheral.

Bohrer

Nagelneue vierkantige Wendschneidplatten-Design für maximale Bohrleistung. Ausgezeichnete Schneidleistung und Spankontrolle durch die optimierte Geometrie und durch den Spanbrecher der Wendschneidplatte, zentral und peripherisch.

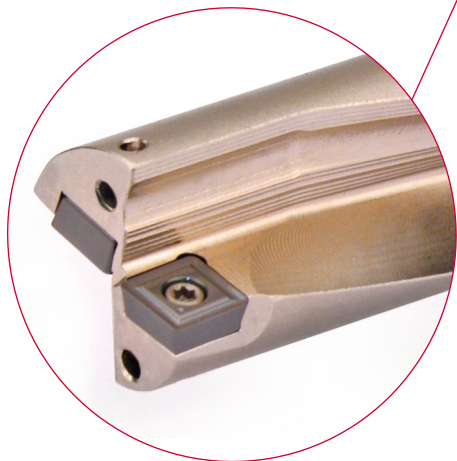



PSC

Canela has enhanced its drill program with the addition of the PSC clamping system for indexable inserts. The 45° drills range in diameter from 15 to 43 mm with a depth of cut of 3xD.

For more information see pages E92 to E94

Canela hat sein Bohr-Programm mit dem PSC-Spannsystem für Wendeschneidplatten erweitert. Die Durchmesser der 45° Bohrer gehen von 15 bis 43 mm, mit einer Schnitttiefe von 3xD.

Für weitere Informationen, siehe Seiten E92 bis E94

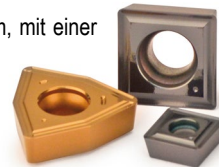

Trepanning drills

Trepanning is used for larger hole diameters and where machine power is limited, because it is not as power consuming as solid drilling. The trepanning tool does not machine the whole diameter, only a ring at the periphery. Instead of removing all the material in the form of chips, a core is left in the center of the hole – consequently, this method is for through-hole applications.

For more information see page H08

Kernbohrer

Das Kernbohren wird bei größeren Bohrungsdurchmessern verwendet, sowie bei begrenzter Maschinenleistung, weil es nicht so viel Energie braucht als das Vollbohren. Der Kernbohrer bearbeitet nicht den ganzen Durchmesser, sondern nur einen Ring an der Peripherie. Anstatt das ganze Material als Späne zu entfernen, bleibt ein Kern in der Mitte des Loches. So ist diese Methode für Durchgangslochanwendungen geeignet.

Für weitere Informationen, siehe Seite H08

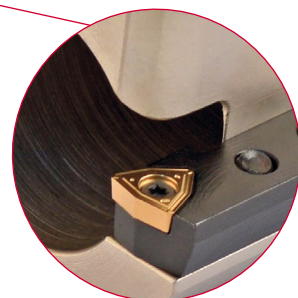

**TURNING
DREHEN**



Geometries and grades

- A02-07** Geometries
- A08** CVD coated carbide
- A10** PVD coated carbide
- A12** Uncoated carbide
- A14** Cermet
- A16** Ceramic
- A18** CBN / PCD
- A20-21** Inserts selection
- A22** Grade chart
- A23** Label designation system
- A24-25** ISO Code key

Geometrien und Sorten

- A02-07** Geometrien
- A09** CVD-beschichteter Hartmetall
- A11** PVD-beschichteter Hartmetall
- A13** Unbeschichteter Hartmetall
- A15** Cermet
- A17** Keramik
- A19** CBN / PCD
- A20-21** Wendeschneidplattenwahl
- A22** Tabelle von Sorten
- A23** Etiketten-Bezeichnungssystem
- A24-25** ISO Bezeichnung

Turning inserts



- A30** Parallelogram inserts
- A30-34** 80° Rhombic inserts
- A35-37** 55° Rhombic inserts
- A38** KNUX inserts
- A38-39** Round inserts
- A40-43** Square inserts
- A44-47** Triangular inserts
- A48-49** 35° Rhombic inserts
- A50-51** 80° Trigon inserts
- A54-58** Ceramic inserts
- A59-60** CBN/PCD Inserts

Drehwendeschneidplatten

- A30** Parallelogramme Wendeschneidplatten
- A30-34** Rhombische Wendeschneidplatten 80°
- A35-37** Rhombische Wendeschneidplatten 55°
- A38** KNUX Wendeschneidplatten
- A38-39** Runde Wendeschneidplatten
- A40-43** Vierkant-Wendeschneidplatten
- A44-47** Dreikant-Wendeschneidplatten
- A48-49** Rhombische Wendeschneidplatten 35°
- A50-51** Trigon-Wendeschneidplatten 80°
- A54-58** Keramik-Wendeschneidplatten
- A59-60** CBN/PCD Wendeschneidplatten

Toolholders



- A62** Clamping systems
- A63** Code system ISO
- A68-79** Dimple lock toolholders
- A80-93** Wedge clamp toolholders / Double lock toolholders
- A94-113** Lever lock toolholders
- A114-127** Top clamp toolholders
- A128-165** Center screw toolholders
- A166-167** Cutting data

Klemmhalter

- A62** Klemmsysteme
- A63** Kodifizierung ISO
- A68-79** Klemmhalter mit Dimple Lock-Klemmung
- A80-93** Klemmhalter mit Prätzen-Klemmung / Klemmhalter mit Doppel-Klemmung
- A94-113** Klemmhalter mit Kniehebel-Klemmung
- A114-127** Klemmhalter mit oberer Klemmung
- A128-165** Klemmhalter mit Zentralschrauben-Klemmung
- A166-167** Schnittdaten

Boring bars



- A170** Clamping systems
- A171** Code system ISO
- A176-177** Dimple lock boring bars
- A178-186** Wedge clamp boring bars / Double lock boring bars
- A187-199** Lever lock boring bars
- A200-203** Top clamp boring bars
- A204-236** Center screw boring bars
- A237-246** Anti-vibration tools
- A247** Cutting data

Bohrstangen

- A170** Klemmsysteme
- A171** Kodifizierung ISO
- A176-177** Bohrstangen mit Dimple Lock-Klemmung
- A178-186** Bohrstangen mit Prätzen-Klemmung / Bohrstangen mit Doppel-Klemmung
- A187-199** Bohrstangen mit Kniehebel-Klemmung
- A200-203** Bohrstangen mit oberer Klemmung
- A204-236** Bohrstangen mit Zentralschrauben-Klemmung
- A237-246** Schwingungsgedämpfte Bohrstangen
- A248** Schnittdaten

TURNING DREHEN



Cartridges

- A250-251** Technical information
- A252** Code system
- A254-258** Lever lock cartridges
- A259-262** Top clamp cartridges
- A263-267** Center screw cartridges

Kurzklemmhalter

- A250-251** Technische Auskünfte
- A252** Kodifizierung
- A254-258** Kurzklemmhalter mit Kniehebel
- A259-262** Kurzklemmhalter mit oberer Prätze
- A263-267** Kurzklemmhalter mit Zentralschraube



Brazed tools

- A272-274** Toolholders
- A275-276** Boring bars

Gelötete Werkzeuge

- A272-274** Drehmeißel
- A275-276** Innendrehmeißel

PARTING AND GROOVING AB- UND EINSTECHDREHEN



Parting and grooving

- B02-15** Inserts for parting and grooving
- B18-43** Toolholders
- B44-47** Boring bars
- B48** Tool blocks
- B49-53** Blades
- B54-57** Top Notch tools
- B58-63** Cutting data

Ab- und Einstechdrehen

- B02-15** Ab- und Einstechwendeschneidplatten
- B18-43** Klemmhalter
- B44-47** Bohrstangen
- B48** Grundhalter
- B49-53** Stechschwerter
- B54-57** Top Notch Werkzeuge
- B58-63** Schnittdaten

THREADING GEWINDEDREHEN



Threading tools

- C02** Code system
- C03-10** Threading inserts
- C12-16** External threading
- C17-20** Internal threading
- C21-24** Cutting data
- C25** Technical information

Gewindedrehen

- C02** Kodifizierung
- C03-10** Wendeschneidplatten zum Gewindedrehen
- C12-16** Außengewindedrehen
- C17-20** Innengewindedrehen
- C21-24** Schnittdaten
- C26** Technische Auskünfte

CERAMIC TOOLS WERKZEUGE FÜR KERAMIK-WENDESCHNEIDPLATTEN



Ceramic tools

- D03-07** Ceramic inserts
- D10-15** Ceramic milling cutters
- D16-33** Toolholders
- D34-40** Boring bars
- D41-53** Top clamp ceramic PSC

Werkzeuge für Keramik-WSP

- D03-07** Keramik-Wendeschneidplatten
- D10-15** Fräser für Keramik-Wendeschneidplatten
- D16-33** Klemmhalter
- D34-40** Bohrstangen
- D41-53** PSC Keramikhalter mit oberer Klemmung

PSC



Toolholders

- E06-24** Dimple lock toolholders
- E25-40** Wedge clamp toolholders /
Double lock toolholders
- E41-50** Lever lock toolholders
- E51-65** Center screw toolholders

Klemmhalter

- E06-24** Klemmhalter mit Dimple Lock-Klemmung
- E25-40** Klemmhalter mit Prätzen-Klemmung /
Klemmhalter mit Doppel-Klemmung
- E41-50** Klemmhalter mit Kniehebel-Klemmung
- E51-65** Klemmhalter mit Zentralschrauben-Klemmung



Boring bars

- E66** Antivibratory adaptor
- E67-69** Dimple lock boring bars
- E70-72** Wedge clamp boring bars /
Double lock boring bars
- E73-75** Lever lock boring bars
- E76-82** Center screw boring bars

Bohrstangen

- E66** Schwingungsgedämpfte Aufnahmen
- E67-69** Bohrstangen mit Dimple Lock-Klemmung
- E70-72** Bohrstangen mit Prätzen-Klemmung /
Bohrstangen mit Doppel-Klemmung
- E73-75** Bohrstangen mit Kniehebel-Klemmung
- E76-82** Bohrstangen mit Zentralschrauben-Klemmung



Threading

- E83** External threading
- E84** Internal threading

Gewindedrehen

- E83** Außengewindedrehen
- E84** Innengewindedrehen



Parting and grooving

- E85-90** Toolholders
- E91** Boring bars

Ab- und Einstechdrehen

- E85-90** Klemmhalter
- E91** Bohrstangen



Drills

- E92-94** Drills

Bohrer

- E92-94** Bohrer



Arbors and adaptors

- E97** Code system
- E96,98** Technical information
- E100-118** Arbors and adaptors
- E119-123** Reducers
- E124** Arbors for boring heads
- E125** Caps

Aufnahmen

- E97** Kodifizierung
- E96,98** Technische Auskünfte
- E100-118** Aufnahmen
- E119-123** Reduzieraufnahme
- E124** Aufnahmen für Bohrköpfe
- E125** Verschlussstopfen



MILLING FRÄSEN



- Grades**
- F02** Uncoated carbide
 - F04** CVD/PVD coated carbide
 - F06-07** ISO Code key

- Sorten**
- F03** Unbeschichteter Hartmetall
 - F05** CVD/PVD-beschichteter Hartmetall
 - F06-07** ISO Bezeichnung



- Milling inserts**
- F10-11** Parallelogram inserts
 - F12** 80° Rhombic inserts
 - F13** 75° Rhombic inserts
 - F13** Single-ended inserts
 - F14** Concave radius inserts
 - F14** Rectangular inserts
 - F15** Heptagonal inserts
 - F15** Octogonal inserts
 - F14-16** Round inserts
 - F17-20** Square inserts
 - F20** High feed inserts
 - F21-22** Triangular inserts
 - F22** 35° Rhombic inserts

- Fräswendeplatten**
- F10-11** Parallelogramme Wendeschneidplatten
 - F12** Rhombische Wendeschneidplatten 80°
 - F13** Rhombische Wendeschneidplatten 75°
 - F13** Einseitige Wendeschneidplatten
 - F14** Wendeschneidplatten für konkave Radien
 - F14** Rechteckige Wendeschneidplatten
 - F15** Siebeneckige Wendeschneidplatten
 - F15** Achtkantige Wendeschneidplatten
 - F14-16** Runde Wendeschneidplatten
 - F17-20** Vierkant-Wendeschneidplatten
 - F20** Hoher Vorschub- Wendeschneidplatten
 - F21-22** Dreikant-Wendeschneidplatten
 - F22** Rhombische Wendeschneidplatten 35°



- Face and chamfering**
- F26-43** Facing milling cutters
 - F44-59** Chamfer and corner radius milling cutters
 - F60** Cutting data

- Plan- und Anfasfräser**
- F26-43** Planfräser
 - F44-59** Anfas- und Viertelkreisfräser
 - F61** Schnittdaten



- Square shoulder cutters**
- F66-95** Facing square shoulder cutters
 - F96-99** Cutting data

- Eckfräser**
- F66-95** Eckfräser
 - F96-99** Schnittdaten



- Slot cutters**
- F102** Code system
 - F104-105** T-Slot cutters
 - F106-112** Slot cutters
 - F113** Drive-rings
 - F114** Cutting data

- Nutenfräser**
- F102** Kodifizierung
 - F104-105** T-Nutenfräser
 - F106-112** Scheibenfräser
 - F113** Mitnehmerringe
 - F115** Schnittdaten

**MILLING
FRÄSEN**

Profile milling

- F120-127** High feed
- F128-135** Round inserts
- F136-138** Aluminium die cutting
- F139-146** Finishing ball nose

Profilfräsen

- F120-127** Hoher Vorschub
- F128-135** Fräser mit runden Wendeschneidplatten
- F136-138** Fräser für Aluminium-Formen
- F139-146** Kugelbahnfräser zum Schlichten

Porcupine milling cutters

- F148** Code system
- F150-152** Porcupine milling cutters
- F153** Cutting data

Igelfräser

- F148** Kodifizierung
- F150-152** Igelfräser
- F154** Schnittdaten

**SOLID CARBIDE
VOLLHARTMETALL**

Solid carbide

- G10-43** High performance
- G44-67** Solid carbide
- G68-72** Others

Vollhartmetall

- G10-43** Hochleistung
- G44-67** Vollhartmetall
- G68-72** Andere

Drills

- G73-88** Drills

Bohrer

- G73-88** Bohrer

Tungsten carbide burs

- G89-93** Tungsten carbide burs
- G94** Technische information

Rotierfräser

- G89-93** Rotierfräser
- G95** Technische Auskünfte

**DRILLS
BOHRER**

Drills

- H02** Inserts for drills
- H03** Code system
- H05-07** Drills
- H08** Trepanning drills
- H09-11** Spot facing and countersink milling cutters
- H12** Technische information
- H14-17** Cutting data

Bohrer

- H02** Wendeschneidplatten für Bohrer
- H03** Kodifizierung
- H05-07** Bohrer
- H08** Kernbohrer
- H09-11** Senkfräser und Rückwärtssenker
- H13** Technische Auskünfte
- H14-17** Schnittdaten



TOOLING SYSTEMS AUFNAHMEN



DIN 2080

- 102** Code system
- 103** Technical information
- 105-24** Arbors and adaptors
- 125** Special tool request

DIN 2080

- 102** Kodifizierung
- 103** Technische Auskünfte
- 105-24** Aufnahmen
- 125** Sonderwerkzeug-Anfrage



DIN 69871-A

- 128** Code system
- 129** Technical information
- 132-75** Arbors and adaptors
- 135-37,60** Antivibratory adaptors
- 163** Sets
- 176** Special tool request

DIN 69871-A

- 128** Kodifizierung
- 129** Technische Auskünfte
- 132-75** Aufnahmen
- 135-37,60** Schwingungsgedämpfte Aufnahmen
- 163** Sätze
- 176** Sonderwerkzeug-Anfrage



HSK DIN 69893-1

- 178** Code system
- 179** Technical information
- 181-96** Arbors and adaptors
- 182-83,91** Antivibratory adaptors
- 197** Special tool request

HSK DIN 69893-1

- 178** Kodifizierung
- 179** Technische Auskünfte
- 181-96** Aufnahmen
- 182-83,91** Schwingungsgedämpfte Aufnahmen
- 197** Sonderwerkzeug-Anfrage



JIS B 6339-BT

- 1100** Code system
- 1101** Technical information
- 1104-145** Arbors and adaptors
- 106,107,130** Antivibratory adaptors
- 1146** Special tool request

JIS B 6339-BT

- 1100** Kodifizierung
- 1101** Technische Auskünfte
- 1104-145** Aufnahmen
- 106,107,130** Schwingungsgedämpfte Aufnahmen
- 1146** Sonderwerkzeug-Anfrage



Boring heads

- 1148-151** Code system
- 1152** Technical information
- 1154** Adjustable boring bars
- 1155-163** Boring heads
- 1164-170** Arbors for boring heads
- 1171** Sets
- 1172** Special tool request

Bohrköpfe

- 1148-151** Kodifizierung
- 1152** Technische Auskünfte
- 1154** Verstellbare Bohrstangen
- 1155-163** Bohrköpfe
- 1164-170** Aufnahmen für Bohrköpfe
- 1171** Sätze
- 1172** Sonderwerkzeug-Anfrage

**TOOLING SYSTEMS
AUFNAHMEN**



Cylindrical shanks

- I174** Code key
- I175** Technical information
- I176-184** Cylindrical shanks

Zylindrische Schäfte

- I174** Kodifizierung
- I175** Technische Auskünfte
- I176-184** Zylindrische Schäfte



Morse shanks

- I186** Code key
- I187** Technical information
- I189-194** Morse shanks

Morse Schäfte

- I186** Kodifizierung
- I187** Technische Auskünfte
- I189-194** Morse Schäfte



Accessories

- I198** Revolving lathe centres
- I199-201** Drill chucks
- I202-203** Quick change adapters
- I206-218** Collets
- I219** Wrenches
- I220-222** Nuts for collets chucks
- I223-227** Pull studs
- I228** Assembly fixtures

Zubehör

- I198** Zentrierspitze
- I199-201** Bohrfutter
- I202-203** Wechseleinsätze für Gewindebohrer
- I206-218** Spannzangen
- I219** Schlüssel
- I220-222** Spannmutter für Spannzangen
- I223-227** Anzugsbolzen
- I228** Montagevorrichtungen

**SPARE PARTS FOR TURNING AND MILLING
ERSATZTEILE ZUM DREHEN UND FRÄSEN**



Turning spare parts

- J02-05** Screws
- J06** Lock pins
- J06-09** Clamps
- J10-15** Shim seats
- J15** Seats
- J16-17** Levers
- J17-18** Others
- J19** Wrenches

Ersatzteile zum Drehen

- J02-05** Schrauben
- J06** Rohrstifte
- J06-09** Pratzen
- J10-15** Unterlegplatten
- J15** Kassetten
- J16-17** Kniehebel
- J17-18** Andere
- J19** Schlüssel



Milling spare parts

- J20-22** Screws
- J22** Washers
- J23** Shim seats
- J24** Wedges and seats
- J25-27** Seats and cartridges
- J28** Wrenches

Ersatzteile zum Fräsen

- J20-22** Schrauben
- J22** Unterlegscheiben
- J23** Unterlegplatten
- J24** Keile und Kassetten
- J25-27** Kassetten
- J28** Schlüssel

**TECHNICAL INFORMATION
TECHNISCHE AUSKÜNFTE**

Technical information

- K02-07** Reference list of materials
- K08-15** Alphanumeric index
- K16** General information
- K17** Safety regulations

Technische Auskünfte

- K02-07** Werkstoffliste
- K08-15** Alphanumerischer Inhalt
- K16** Allgemeine Auskunft
- K18** Sicherheitsvorschriften



INSERTS WENDESCHNEIDPLATTEN

Geometries Geometrien	A02-07
Grades Sorten	A08-19
Inserts selection Wendeschneidplattenwahl	A20-21
Grade chart Tabelle von Sorten	A22
Label designation system Etiketten-Bezeichnungssystem	A23
ISO Code Key ISO Bezeichnung	A24-25
ISO inserts ISO Wendeschneidplatten	A26-51
Technical information Technische Auskünfte	A52-53
Ceramic inserts Keramik-Wendeschneidplatten	A54-60

NEW *Turning line* NEUE *Linie zum Drehen*

-FC

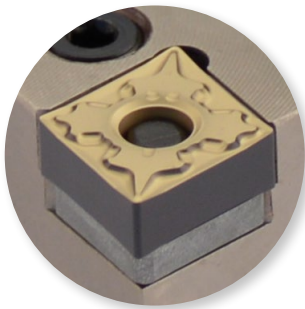

FC chipbreaker is engineered for light finishing operations at high speeds in the 0,08 mm to 0,3 mm feed range at depths of cut between 0,2 to 2,5 mm.

Main application area:
Cutting depth (Ap): 0,2 - 2,5 mm
Feed (f): 0,08 - 0,3 mm

Der FC Spanbrecher ist für leichte Schlichtoperationen mit hohen Schnittgeschwindigkeiten und einem Vorschub von 0,08 bis 0,3 mm und eine Schnitttiefe von 0,2 bis 2,5 mm entworfen worden.

Haupt-Einsatzbereich:
Schnitttiefe (Ap): 0,2 - 2,5 mm
Vorschub (f): 0,08 - 0,3 mm

-FMC

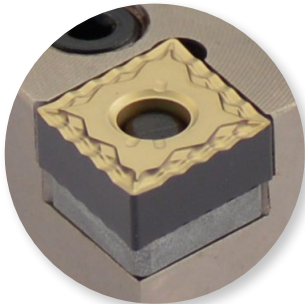

Alternative chipbreaker for light cutting of carbon steel and alloyed steel.

Double-sided chipbreaker.
Higher chip control and small cutting depths. The wavy edge is ideal for copying and back turning. Recommended for workpieces with a hardness between 200 and 300 HB.

Main application area:
Cutting depth (Ap): 0,5 - 2,5 mm
Feed (f): 0,05 - 0,25 mm

Alternativer Spanbrecher für die leichte Zerspannung von Kohlenstoffstahl und legiertem Stahl.

Doppelseitiger Spanbrecher.
Höhere Spankontrolle und geringe Schnitttiefen. Die wellige Schneidkante ist zum Kopieren und Rückwärtsdrehen gut geeignet.

Empfohlen für Werkstücke im Härtebereich 200-300 HB.

Haupt-Einsatzbereich:
Schnitttiefe (Ap): 0,5 - 2,5 mm
Vorschub (f): 0,05 - 0,25 mm

-MC

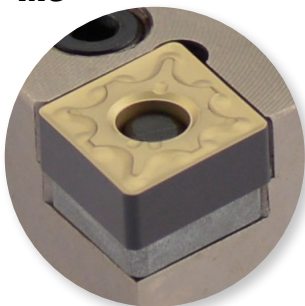

MC chipbreaker provides a positive rake angle with land for high edge strength in medium duty applications on a wide range of materials. Recommended for general purpose use on all types of steel and stainless steels.

Main application area:
Cutting depth (Ap): 1,0 - 3,5 mm
Feed (f): 0,15 - 0,35 mm

Der MC Spanbrecher gibt einen positiven Schnittwinkel, mit einer Fase für eine höhere Festigkeit der Schnittkante in mittleren Anwendungen bei einer breiten Palette von Materialien.

Empfohlen für allgemeine Bearbeitung in allen Sorten von Stahl und rostfreiem Stahl.

Haupt-Einsatzbereich:
Schnitttiefe (Ap): 1,0 - 3,5 mm
Vorschub (f): 0,15 - 0,35 mm



Available in / Verfügbar in

TN15, TN20, TN30 and/und TN35

-MFC

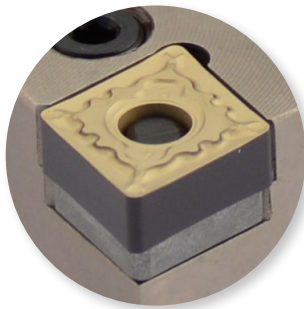

MFC chipbreaker provides excellent chip control with low cutting forces and free cutting action over a broad range of light duty applications.

Recommended for light duty use on carbon alloys.

Main application area:

Cutting depth (A_p): 0,5 - 4,0 mm

Feed (f): 0,15 - 0,5 mm

Der Spanbrecher MFC sichert eine ausgezeichnete Spankontrolle mit niedrigen Schnittkräften und einem freien Spanschnitt in einer breiten Palette von leichten Anwendungen. Empfohlen für leichte Anwendungen in Kohlenstoff-Legierungen.

Haupt-Einsatzbereich:

Schnitttiefe (A_p): 0,5 - 4,0 mm

Vorschub (f): 0,15 - 0,5 mm

-MHC

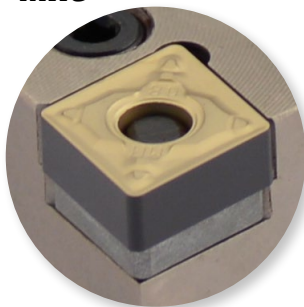

Alternative chipbreaker for medium cutting of carbon steel and alloyed steel.

First recommendation for rough cutting of mild steel.

Double-sided chipbreaker.

The flat land offers high resistant cutting edges.

Main application area:

Cutting depth (A_p): 1,0 - 5,0 mm

Feed (f): 0,2 - 0,8 mm

Alternativer Spanbrecher für die mittlere Zerspanung von Kohlenstoffstahl und legiertem Stahl.

Erste Empfehlung für das Schruppen von Baustahl.

Doppelseitiger Spanbrecher. Die flache Fase bietet eine hohe Schneidkantenstabilität.

Haupt-Einsatzbereich:

Schnitttiefe (A_p): 1,0 - 5,0 mm

Vorschub (f): 0,2 - 0,8 mm

-RC

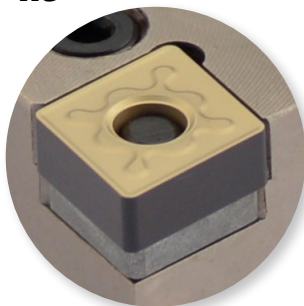

The RC chipbreaker is suitable for high feed rates and depths of cut that normally require single-sided inserts. The chipbreaker has a wide negative T-land, which gives high edge strength.

Main application area:

Cutting depth (A_p): 1,5 - 5 mm

Feed (f): 0,3 - 0,5 mm

Der Spanbrecher RC ist für hohe Vorschübe, und auch für Schnitttiefen geeignet, für die im Normalfall einseitige Wendeschneidplatten eingesetzt werden. Der Spanbrecher hat eine negative Fase, die eine hohe Kraft auf die Schnittkante gibt.

Haupt-Einsatzbereich:

Schnitttiefe (A_p): 1,5 - 5 mm

Vorschub (f): 0,3 - 0,5 mm

Geometries / Geometrien

-FC



FC chipbreakers are engineered for light finishing operations at high speeds in the 0,08 mm to 0,3 mm feed range at depths of cut between 0,2 to 2,5 mm.

Main application area: Cutting depth (A_p): 0,2 - 2,5 mm
Feed (f): 0,08 - 0,3 mm

Die FC Spanbrecher sind für leichte Schlichtoperationen zu hohen Geschwindigkeiten mit einem Vorschub von 0,08 mm bis 0,3 mm und einer Schnitttiefe von 0,2 to 2,5 mm.

Haupt-Einsatzbereich: Schnitttiefe (A_p): 0,2 - 2,5 mm
Vorschub (f): 0,08 - 0,3 mm

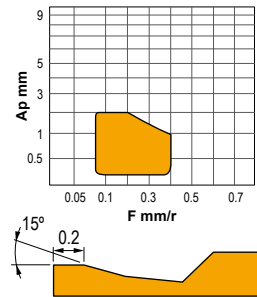

-FMC



Alternative chipbreaker for light cutting of carbon steel and alloyed steel. Double-sided chipbreaker.

Higher chip control and small cutting depths.

The wavy edge is ideal for copying and back turning.

Recommended for workpieces with a hardness between 200 and 300 HB.

Main application area: Cutting depth (A_p): 0,5 - 2,5 mm
Feed (f): 0,05 - 0,25 mm

Alternativer Spanbrecher für die leichte Zerspanung von Kohlenstoffstahl und legiertem Stahl.

Doppelseitiger Spanbrecher.

Höhere Spankontrolle und geringe Schnitttiefen.

Die wellige Schneidkante ist zum Kopieren und Rückwärtsdrehen gut geeignet.

Empfohlen für Werkstücke im Härtebereich 200-300 HB.

Haupt-Einsatzbereich: Schnitttiefe (A_p): 0,5 - 2,5 mm
Vorschub (f): 0,05 - 0,25 mm

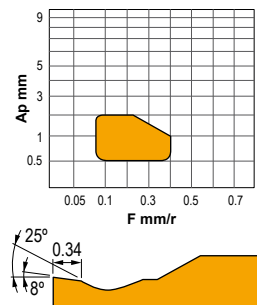

-CC



CC chipbreakers combined with the performance of Cermets provide for efficient chip control in finishing and light machining operations.

Recommended for finishing steels and cast iron.

Main application area: Cutting depth (A_p): 0,2 - 1,5 mm
Feed (f): 0,05 - 0,4 mm

Die CC Spanbrecher kombiniert mit der Leistung des Cermets sorgen für effiziente Spankontrolle beim Schlichten und beim leichten Schruppen.

Empfohlen zum Schlichten von Stahl und Guß.

Haupt-Einsatzbereich: Schnitttiefe (A_p): 0,2 - 1,5 mm
Vorschub (f): 0,05 - 0,4 mm

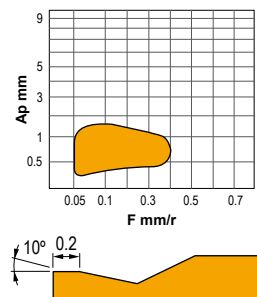

-MC



MC chipbreakers provide a positive rake angle with land for high edge strength in medium duty applications on a wide range of materials.

Recommended for general purpose use on all types of steel.

Main application area: Cutting depth (A_p): 1,0 - 3,5 mm
Feed (f): 0,15 - 0,35 mm

Die MC Spanbrecher geben einen positiven Schnittwinkel mit einer Fase für eine hohe Festigkeit der Schnittkante in mittleren Anwendungen bei einer breiten Palette von Materialien.

Empfohlen für die allgemeine Bearbeitung von allen Stahlsorten.

Haupt-Einsatzbereich: Schnitttiefe (A_p): 1,0 - 3,5 mm
Vorschub (f): 0,15 - 0,35 mm

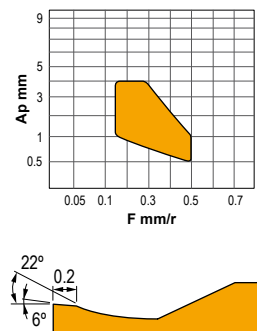

Geometries / Geometrien

-MFC



MFC chipbreakers provide an excellent chip control with low cutting forces and a very free cutting action over a broad range of light duty applications. Recommended for light duty use on carbon alloys and stainless steels.

Main application area: Cutting depth (A_p): 0,5 - 4,0 mm
Feed (f): 0,15 - 0,5 mm

Der MFC Spanbrecher sorgt für eine ausgezeichnete Spankontrolle mit niedrigen Schnittkräften und hat eine sehr positive Spanleitstufe für eine breite Palette von leichten Anwendungen.

Empfohlen für leichte Anwendungen in Kohlenstoff-Legierungen und rostfreiem Stahl.

Haupt-Einsatzbereich: Schnitttiefe (A_p): 0,5 - 4,0 mm
Vorschub (f): 0,15 - 0,5 mm

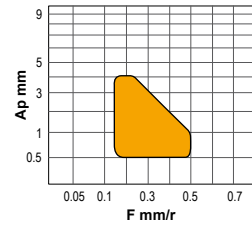

-MHC



Alternative chipbreaker for medium cutting of carbon steel and alloyed steel.

First recommendation for rough cutting of mild steel.

Double-sided chipbreaker.

The flat land offers high resistant cutting edges.

Main application area: Cutting depth (A_p): 1,0 - 5,0 mm

Feed (f): 0,2 - 0,8 mm

Alternativer Spanbrecher für die mittlere Zerspanung von Kohlenstoffstahl und legiertem Stahl.

Erste Empfehlung für das Schruppen von Baustahl.

Doppelseitiger Spanbrecher.

Die flache Fase bietet eine hohe Schneidkantenstabilität.

Haupt-Einsatzbereich: Schnitttiefe (A_p): 1,0 - 5,0 mm
Vorschub (f): 0,2 - 0,8 mm

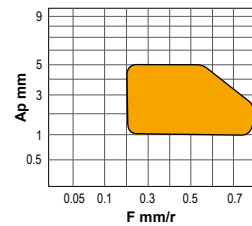

-RC



RC is the strongest chipbreaker for double-sided inserts.

It is suitable for high feed rates and depths of cut that normally require single-sided inserts.

It has a wide negative T-land, which gives high edge strength.

Main application area: Cutting depth (A_p): 1,5 - 5,0 mm

Feed (f): 0,3 - 0,5 mm

RC ist der stärkste Spanbrecher für doppelseitige Wendeschneidplatten.

Er ist für hohe Vorschübe geeignet und auch für Schnitttiefen, die normalerweise einseitige Wendeschneidplatten benötigen.

Er hat eine negative breite Kante, die eine hohe Kraft zu der Schnittkante gibt.

Haupt-Einsatzbereich: Schnitttiefe (A_p): 1,5 - 5,0 mm

Vorschub (f): 0,3 - 0,5 mm

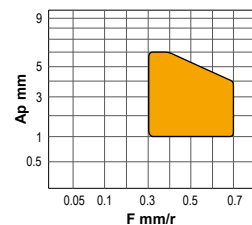

-KC



First recommendation for medium cutting of cast iron.

Optimum balance between sharpness and high resistant cutting edges for general use.

Main application area: Cutting depth (A_p): 1,0 - 4,0 mm

Feed (f): 0,2 - 0,5 mm

Erste Empfehlung für die mittlere Zerspanung von Gußeisen.

Exzellenter Ausgleich zwischen Schärfe und hoher Schneidkantenstabilität für allgemeine Anwendungen.

Haupt-Einsatzbereich: Schnitttiefe (A_p): 1,0 - 4,0 mm

Vorschub (f): 0,2 - 0,5 mm

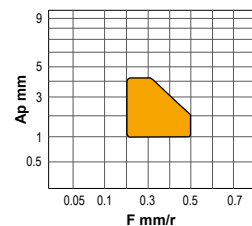

Geometries / Geometrien

-TC



First recommendation for medium cutting of stainless and mild steel and for light cutting of difficult-to-cut materials. Double-sided chipbreaker.

The sharp cutting edge gives best performance.

Main application area: Cutting depth (A_p): 1,0 - 4,0 mm
Feed (f): 0,1 - 0,5 mm

Erste Empfehlung für die mittlere Zerspanung von rostfreiem und weichem Stahl und für die leichte Zerspanung von schwer zu bearbeitenden Werkstoffen.

Doppelseitiger Spanbrecher. Die scharfe Schneidkante gibt eine sehr gute Leistung.

Haupt-Einsatzbereich: Schnitttiefe (A_p): 1,0 - 4,0 mm
Vorschub (f): 0,1 - 0,5 mm

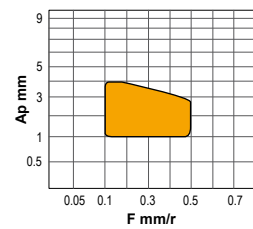

..NGP



For medium duty machining of tough work materials, above all chrome-nickel based alloys.

It minimises the tendency of these materials to adhere to the insert.

Main application area: Cutting depth (A_p): 0,1 - 4 mm
Feed (f): 0,1 - 0,25 mm

Für mittlere Bearbeitung von schwer zu bearbeitenden Materialien, vor allem für Legierungen mit Chrom- und Nickelbasis. Sie minimiert die Neigung dieser Materialien, an der Wendeschneidplatte zu haften.

Haupt-Einsatzbereich: Schnitttiefe (A_p): 0,1 - 4 mm
Vorschub (f): 0,1 - 0,25 mm

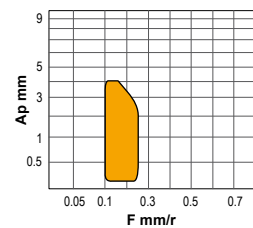

..NMA



Double-sided insert for short chipping materials.

Strong cutting edge.

Main application area: Cutting depth (A_p): 1 - 12 mm
Feed (f): 0,2 - 1 mm

Doppelseitige Wendeschneidplatte für kurzspanige Materialien.

Starke Schnittkante.

Haupt-Einsatzbereich: Schnitttiefe (A_p): 1 - 12 mm
Vorschub (f): 0,2 - 1 mm

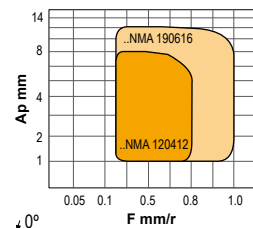

..NMM



Chipbreaker for single-sided inserts.

It has a positive cutting edge that gives rise to low cutting forces.

Main application area: Cutting depth (A_p): 2,5 - 6 mm
Feed (f): 0,4 - 0,6 mm

Spanbrecher für einseitige Wendeschneidplatten.

Sie hat eine positive Schnittkante für niedrige Schnittkräfte.

Haupt-Einsatzbereich: Schnitttiefe (A_p): 2,5 - 6 mm
Vorschub (f): 0,4 - 0,6 mm

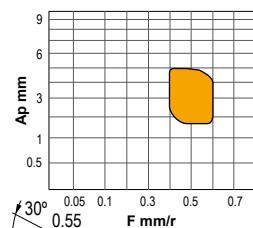

..NMX

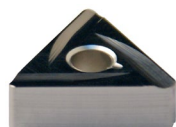

Light duty positive/negative inserts provide excellent chip control in light feed ranges using high positive shear angles.

Recommended for machining of steels and other materials.

Main application area: Cutting depth (A_p): 0,5 - 3 mm
Feed (f): 0,1 - 0,4 mm

Positive/negative Wendeschneidplatten gewährleisten eine hervorragende Spankontrolle bei niedrigen Vorschüben, indem man extrem positive Spanwinkel verwendet. Empfohlen für die Bearbeitung von Stahl und anderen Materialien.

Haupt-Einsatzbereich: Schnitttiefe (A_p): 0,5 - 3 mm
Vorschub (f): 0,1 - 0,4 mm

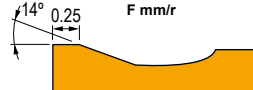
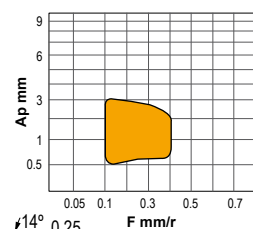



Geometries / Geometrien

-AL



This geometry can be used for turning aluminium, light alloys, non ferrous materials, high-melting metals, plastics, glass fiber, reinforced plastics, laminated board, carbon and fine ceramics.

Main application area: Cutting depth (A_p): 1 - 10 mm
Feed (f): 0,1 - 0,75 mm

Diese Geometrie kann für das Drehen von Aluminium, rostfreien Stählen, Nichteisenmetallen, leicht schmelzbaren Metallen, Kunststoff, Glasfiber, verstärkte Kunststoffe, Walzplatten, Kohle und feiner Keramik verwendet werden.

Haupt-Einsatzbereich: Schnitttiefe (A_p): 1 - 10 mm
Vorschub (f): 0,1 - 0,75 mm

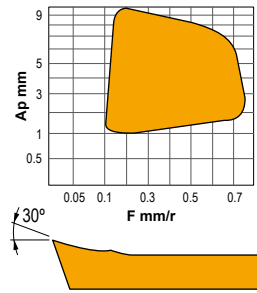

-AP



Suitable for aluminium, light alloys, non ferrous materials, high-melting metals, plastics, glass fiber, reinforced plastics, laminated board, carbon and fine ceramics.

Main application area: Cutting depth (A_p): 0,5 - 8 mm
Feed (f): 0,1 - 0,7 mm

Geeignet für Aluminium, leichten Legierungen, Nichteisenmetallen, leicht schmelzbaren Metallen, Kunststoff, Glasfiber, verstärkte Kunststoffe, Walzplatten, Kohle und feine Keramik verwendet werden.

Haupt-Einsatzbereich: Schnitttiefe (A_p): 0,5 - 8 mm
Vorschub (f): 0,1 - 0,7 mm

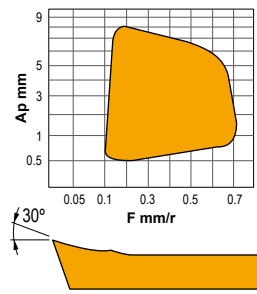

..MR



This geometry provides chip control in the finishing and medium duty range. Positive rake that reduces cutting forces and power consumption. It can also be used on low-strength and stainless steels.

Main application area: Cutting depth (A_p): 0,5 - 4 mm
Feed (f): 0,15 - 0,4 mm

Diese Geometrie erlaubt eine Spankontrolle in Schlicht-Operationen und mittleren Bearbeitungen. Die positive Schnittkante reduziert die Schnittkräfte und benötigt wenig Antriebsleistung. Es kann auch in wenig widerstandsfähige Stählen und in rostfreiem Stahl verwendet werden.

Haupt-Einsatzbereich: Schnitttiefe (A_p): 0,5 - 4 mm
Vorschub (f): 0,15 - 0,4 mm

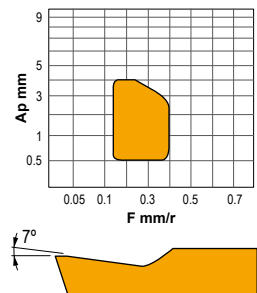

..MT



Light to medium-duty machining operations. Low cutting forces and reduced power requirements thanks to positive rake angle. Good chip control over a wide range of materials. It is also used on short-chipping cast-iron materials.

Main application area: Cutting depth (A_p): 0,5 - 4 mm
Feed (f): 0,15 - 0,4 mm

Für leichte bis mittlere Bearbeitungsoperationen. Dank der positiven Schnittwinkel braucht man nur niedrige Schneidkräfte und eine geringe Antriebsleistung. Gute Spankontrolle in einer breiten Anwendungspalette. Es wird auch in kurzspanendem Guß verwendet.

Haupt-Einsatzbereich: Schnitttiefe (A_p): 0,5 - 4 mm
Vorschub (f): 0,15 - 0,4 mm

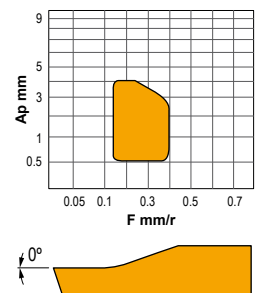

..MW

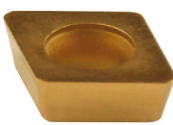

Double-sided insert for short chipping materials. Strong cutting edge.

Main application area: Cutting depth (A_p): 0,2 - 4 mm
Feed (f): 0,1 - 0,3 mm

Doppelseitige Wendeschneidplatte für kurzspanenden Materialien. Verstärkte Schnittkante.

Haupt-Einsatzbereich: Schnitttiefe (A_p): 0,2 - 4 mm
Vorschub (f): 0,1 - 0,3 mm

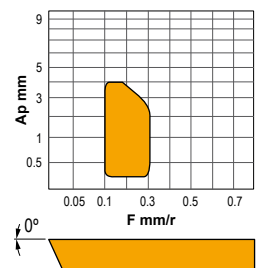



CVD

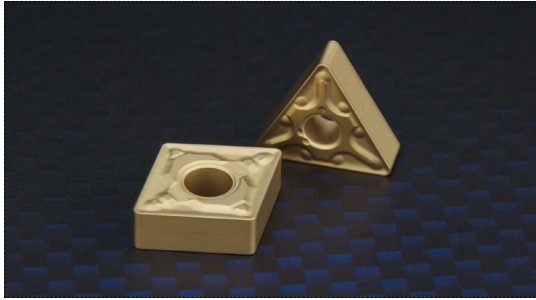

CVD coated carbide

The CVD coatings are generated by a chemical reaction at high temperatures (700-1050°C). All CVD coatings provide a high wear resistance due to its excellent adhesion to cemented carbide.

CVD coatings are the first choice in a large turning range where wear resistance is important.

Features of CVD coated carbide

Material		Grade	Colour	Coating composition	Definition
P Steel		TN15	●	TiCN+Al ₂ O ₃ +TiN	Wear resistant finishing to intermediate grade suitable for many applications on steel, cast iron, stainless steel and high temperature alloys. It is generally used at higher speeds where deformation may be a problem. The multi-layer coating includes TiCN and aluminium oxide.
		TN20	●	TiCN+Al ₂ O ₃ +TiN	General purpose wear resistant grade. It has an enriched substrate that has exceptionally good deformation as well as fracture resistance. The multi-layer coating includes aluminium oxide to add additional heat and wear resistance. It is used to machine steel and stainless steel at lower speeds than TN15.
		TN30	●	TiCN+Al ₂ O ₃ +TiN	General purpose wear resistant turning grade. The multi-layer coating includes aluminium oxide to add additional heat and wear resistance. It is used to machine steel at lower speeds than TN15. This turning grade is for demanding metal removal operations, including cutting through scale at low speeds through heavy interruption, and problem machining of stainless steel at low speed and poor rigidity.
M Stainless		TN35	●	TiCN+Al ₂ O ₃ +TiN	New coated grade developed to machine stainless steel and heat-resistance alloys. This grade is only used in combination with the MC chipbreaker. First choice for stainless steel applications.
K Cast iron		TK15	●	TiCN+Al ₂ O ₃	CVD grade for gray, ductile nodular cast iron with excellent balance of wear and fracture resistance. The smooth coating prevents insert failure such as welding and chipping, providing a consistent cutting performance.

Grade characteristics

Grade	Substrate			Coating Layer	
	Hardness (HRA)	T.R.S (GPa)	Surface	Composition	Thickness
TN15	90.3	2.0	Tough	Accumulated TiCN-Al ₂ O ₃ +Ti Compound	Thick
TN20	90.3	2.0	Tough	Accumulated TiCN-Al ₂ O ₃ +Ti Compound	Thick
TN30	90.0	2.2	Tough	Accumulated TiCN-Al ₂ O ₃ +Ti Compound	Thick
TN35	89.0	2.6	-	Ti Compound	Thin
TK15	91.0	2.2	-	TiCN-Al ₂ O ₃ Compound	Thick



CVD-beschichteter Hartmetall

Die CVD-Beschichtungen erfolgen durch eine chemische Reaktion bei hohen Temperaturen (700-1050°C). Alle CVD-Beschichtungen verfügen über eine hohe Verschleißfestigkeit, weil sie eine hervorragende Haftung auf dem Hartmetall haben.

Die CVD-Beschichtungen sind die erste Wahl bei einer breiten Drehpalette, bei der die Verschleißfestigkeit wichtig ist.

Eigenschaften von CVD-beschichtetem Hartmetall

Beschreibung	Zusammensetzung	Farbe	Sorte		Werkstoff
Es ist eine verschleißfeste Sorte zum mittleren Schruppen und Schlichten in Stahl, Guß, rostfreiem Stahl und hochlegierte Stähle. Normalerweise wird sie bei hohen Schnittgeschwindigkeiten verwendet, wo die Verformung ein Problem sein kann. Die mehrlagige Beschichtung enthält TiCN und Aluminiumoxid.	TiCN+Al ₂ O ₃ +TiN	●	TN15		P Stahl
Es ist eine allgemeine verschleißfeste Sorte. Sie enthält ein angereichertes Substrat, das eine hervorragende Verformung und Bruchfestigkeit hat. Die mehrlagige Beschichtung enthält Aluminiumoxid, um zusätzliche Wärme und verschleißfestigkeit zu erreichen. Es wird für die Bearbeitung von Stahl und rostfreiem Stahl bei niedrigeren Geschwindigkeiten als TN15 benutzt.	TiCN+Al ₂ O ₃ +TiN	●	TN20		
Es ist eine allgemeine verschleißfeste Sorte zum Drehen. Die mehrlagige Beschichtung enthält Aluminiumoxid, um zusätzliche Wärme und Verschleißfestigkeit zu erreichen. Es wird für die Bearbeitung von Stahl bei niedrigeren Geschwindigkeiten als TN15 benutzt. Diese Sorte ist für Operationen mit großen Spanabfluß geeignet, auch mit unterbrochenen Schnitten und für die problematische Bearbeitung von rostfreiem Stahl bei niedrigen Geschwindigkeiten und ungünstigen Bedingungen.	TiCN+Al ₂ O ₃ +TiN	●	TN30		
Es ist eine neue beschichtete Sorte für die Bearbeitung von rostfreiem Stahl und hitzebeständigen Legierungen. Diese Sorte wird nur zusammen mit dem MC-Spanbrecher benutzt. Es ist die erste Wahl für Anwendungen in rostfreiem Stahl.	TiCN+Al ₂ O ₃ +TiN	●	TN35		M Rostfreier Stahl
CVD-Sorte für Grauguß und Kugelgraphit mit einem ausgezeichneten Widerstand gegen Verschleiß und Bruch. Die glatte Beschichtung vermeidet Probleme wie Verschweißen oder Risse, und bietet eine hervorragende Schnittleistung.	TiCN+Al ₂ O ₃	●	TK15		K Guß

Sorteneigenschaften

Sorte	Substrat			Beschichtung	
	Härte (HrA)	T.R.S (GPa)	Oberfläche	Zusammensetzung	Dicke
TN15	90.3	2.0	Zäh	Akkumuliertes TiCN-Al ₂ O ₃ +Ti Verbund	Dick
TN20	90.3	2.0	Zäh	Akkumuliertes TiCN-Al ₂ O ₃ +Ti Verbund	Dick
TN30	90.0	2.2	Zäh	Akkumuliertes TiCN-Al ₂ O ₃ +Ti Verbund	Dick
TN35	89.0	2.6	-	Ti Verbund	Dünn
TK15	91.0	2.2	-	TiCN-Al ₂ O ₃	Dick



PVD



PVD coated carbide

PVD coatings offer wear resistance due to their hardness. The coating process involves the evaporation of metal, which reacts with nitrogen to form a hard nitride coating. The full process is made at relatively low temperatures (400-600°C).

PVD coatings are recommended when sharp cutting edges are needed.

Features of PVD coated carbide

Material		Grade	Colour	Coating composition	Definition
P Steel		TL20	●	TiAlN	Carbide with TiAlN and lubricity layer PVD coating. It has a lower friction coefficient and a lower cutting energy during finishing. The sharper cutting edge reduces the built-up edge damage and gives the workpiece an excellent surface finish. Recommended for alloyed steel.
		TIN25	●	TiN-TiC-TiN	Coated with TiN-TiC-TiN. The coating has a thickness of 3-5 microns for use on steel, alloyed steel and stainless steel, with or without coolant.
M Stainless		TS15	●	TiAlN	Coated TiAlN grade in the K20 range. It is used on cast iron, aluminium and heat-resistant alloys. It works well on cobalt based alloys and synthetic materials, and is suitable for finishing on heat-resistant alloys.
S Heat resistant alloys		TS20	●	TiN+TiAlN+TiN	Coated TiN+TiAlN+TiN grade for machining super alloys. It has a fine grain of 0.8 µm and a hardness of HV30 1820 and it offers an excellent rupture and heat resistance.
N Non ferrous materials		ZR10	●	TiB ₂	Micrograin grade with an extremely hard single TiB ₂ layer for machining aluminium, copper alloys and plastics.

Grade characteristics

Grade	Substrate		Coating Layer	
	Hardness (HRA)	T.R.S (GPa)	Composition	Thickness
TL20	91.5	2.5	(Al,Ti)N	Thin
TIN25	90.5	2.0	TiN	Thin
TS15	91.5	2.5	(Al,Ti)N	Thin
TS20	90.5	2.5	(Al,Ti)N-Ti Compound	Thin
ZR10	99.2	2.8	TiB ₂	Thin



PVD-beschichteter Hartmetall

Aufgrund Ihrer Härte bieten PVD-Beschichtungen Verschleißfestigkeit an. Der Beschichtungsprozess beinhaltet die Verdampfung des Metalls, das mit Stickstoff reagiert, um eine harte Nitridbeschichtung auszubilden. Der ganze Prozess erfolgt bei relativ niedrigen Temperaturen (400-600°C).

PVD-Beschichtungen werden empfohlen, wenn man scharfe Schneidkanten braucht.

Eigenschaften von PVD-beschichtetem Hartmetall

Beschreibung	Zusammensetzung	Farbe	Sorte		Werkstoff
PVD beschichtete Sorte mit TiAlN und einer Gleitschicht. Sie hat einen niedrigen Reibungswert und eine niedrige Schneidenergie beim Schlichten. Die scharfe Schneidkante reduziert den Schneidenaufbau und erzeugt eine hervorragende Oberfläche. Empfohlen für legierten Stahl.	TiAlN	●	TL20		P Stahl
Mit TiN-TiC-TiN beschichtet. Die Dicke der Schicht ist 3-5 Mikron und ist zur Bearbeitung von Stahl, legierten Stahl und rostfreien Stahl geeignet, mit oder ohne Kühlung.	TiN-TiC-TiN	●	TIN25		M Rostfreier Stahl
Es ist eine TiAlN-beschichtete Sorte im K20 Bereich. Sie ist für Guß, Aluminium und hitzebeständige Legierungen geeignet. Sie hat gute Eigenschaften für die Bearbeitung von Kobaltlegierungen und synthetischen Materialien und ist zum Schlichten in hitzebeständigen Legierungen besonders gut geeignet.	TiAlN	●	TS15		S Hitzebeständige Legierungen
Beschichtete TiN+TiAlN+TiN Sorte zur Bearbeitung von Super-Legierungen. Sie hat eine Feinkornschicht von 0.8 µm und eine Härte von HV30 1820, und sie bietet eine ausgezeichnete Bruch- und Hitzebeständigkeit an.	TiN+TiAlN+TiN	●	TS20		N Nicht-Eisen-Metalle
Mikrokorn-Sorte mit einer einzigen sehr harten TiB ₂ -Schicht, zur Bearbeitung von Aluminium, Kupfer-Legierungen und Kunststoff.	TiB ₂	●	ZR10		

Sorteneigenschaften

Sorte	Substrat		Beschichtung	
	Härte (HRA)	T.R.S (GPa)	Zusammensetzung	Dicke
TL20	91.5	2.5	(Al,Ti)N	Dünn
TIN25	90.5	2.0	TiN	Dünn
TS15	91.5	2.5	(Al,Ti)N	Dünn
TS20	90.5	2.5	(Al,Ti)N-Ti Verbund	Dünn
ZR10	99.2	2.8	TiB ₂	Dünn

UNCOATED CARBIDE

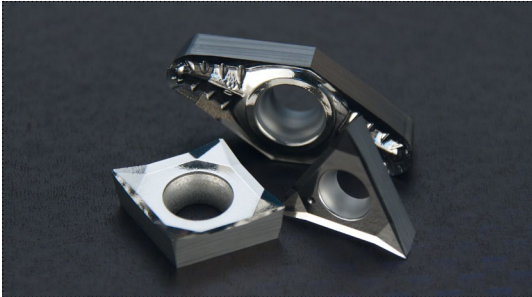

UNCOATED CARBIDE

- Excellent thermal crack resistance makes it possible to machine in wet cutting conditions.
- Cemented carbide can be applied for various workpieces.
- High toughness and low cutting force.
- Low affinity to workpiece.

Features of UNCOATED CARBIDE

Material		Grade	Colour	Composition	Definition
P Steel		PM25		WC+TiC+TaC+Co	General purpose uncoated grade in the P30 range. This tough, economical grade is suitable to work carbon steels, alloyed steels, tool steels and stainless steels. PM25 provides toughness and resistance to deformation in roughing and semi-finishing applications.
		PM40		WC+TiC+TaC+Co	Roughing grade in the P35 range. This tough grade is for structural, cast and tool steels. It is recommended when toughness is more important than wear resistance.
K Cast iron		KM15		WC+Co	Finishing grade in the K10 range. This carbide grade is for use on cast iron, aluminium and heat-resistant alloys. This grade works well on cobalt based alloys and synthetic materials and is suitable for finishing on heat-resistant alloys.

Application

ISO	Composition	Features	Workpiece
P	WC+TiC+TaC+Co	Heat resistance, excellent plastic deformation resistance.	Carbon steel, alloy steel, stainless steel.
M	WC+TiC+TaC+Co	General tools stable heat resistance with strength.	Carbon steel, alloy steel, stainless steel, cast steel.
K	WC+Co	High strength and superior wear resistance.	Carbon iron, non-ferrous metal, plastic, etc.

Properties

Grade	Hardness (HRA)	TRS (Kgf/mm ²)	Young's modulus (103Kgf/mm ²)	Thermal expansion coefficient (10 ⁻⁶ /°C)	Thermal conductivity (cal/cm·sec·°C)
KM15	90.9	250	63	-	105
PM25	91.9	200	56	5.2	45
PM40	91.3	230	53	5.2	-



UNBESCHICHTETES HARTMETALL

- Die hervorragende Wärmerißbeständigkeit ermöglicht eine Bearbeitung mit Kühlmittel.
- Unbeschichtetes Hartmetall eignet sich zur Bearbeitung von verschiedenen Werkstoffen.
- Hohe Zähfestigkeit und geringe Schneidkraft.
- Niedrige Affinität zum Werkstoff.

Eigenschaften von unbeschichtetem Hartmetall

Beschreibung	Zusammensetzung	Farbe	Sorte		Werkstoff
Allgemeine unbeschichtete Sorte im P30 Bereich. Diese zähe und wirtschaftliche Sorte ist zur Bearbeitung von Kohlenstoffstahl, legiertem Stahl, Werkzeugstahl und rostfreiem Stahl gut geeignet. PM25 hat eine gute Zähigkeit und Verschleißfestigkeit in Schrupp- und mittlere Schlichtarbeiten.	WC+TiC+TaC+Co		PM25		P Stahl
Es ist eine Sorte zum Schruppen im P35 Bereich. Diese zähe Sorte ist für Baustahl, Stahlguß und Werkzeugstahl geeignet, insbesondere wenn die Zähigkeit wichtiger als die Verschleißfestigkeit ist.	WC+TiC+TaC+Co		PM40		
Es ist eine Sorte zum Schlichten im K10 Bereich. Diese Sorte ist für Guß, Aluminium und hitzebeständigen Legierungen geeignet. Sie hat gute Bearbeitungseigenschaften für Kobaltlegierungen und synthetischen Materialien und ist für das Schlichten in hitzebeständigen Legierungen besonders gut geeignet.	WC+Co		KM15		K Guß

Anwendung

ISO	Zusammensetzung	Eigenschaften	Bearbeitungsstück
P	WC+TiC+TaC+Co	Hitzebeständigkeit, ausgezeichneter Widerstand gegen plastische Verformung.	Kohlenstoffstahl, legierter Stahl, rostfreier Stahl.
M	WC+TiC+TaC+Co	Stabile Hitzebeständigkeit mit Stärke.	Kohlenstoffstahl, legierter Stahl, rostfreier Stahl, Stahlguß.
K	WC+Co	Hohe Festigkeit und hervorragende Verschleißfestigkeit.	Kohlenstoff-Eisen, Nicht-Eisen-Metall, Kunststoff, usw.

Sorteneigenschaften

Sorte	Härte (HRA)	TRS (Kgf/mm ²)	Youngscher Modul (103Kgf/mm ²)	Wärmeausdehnungs-Koeffizient (10 ⁻⁶ /°C)	Wärmeleitfähigkeit (cal/cm-sec-°C)
KM15	90.9	250	63	-	105
PM25	91.9	200	56	5.2	45
PM40	91.3	230	53	5.2	-



CERMET

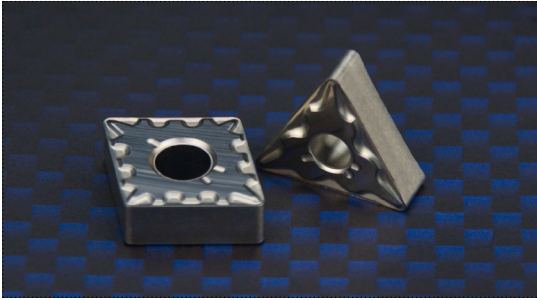

CERMET

- Maximum heat and wear resistance.
- Excellent resistance to oxidation.
- For very high cutting speeds.
- Ideal for finishing.
- Universal application.

Features of CERMET

Material		Grade	Colour	Composition	Definition
P Steel		NC25		Ti+W+Ta/Nb	NC25 is a newly developed Cermet applicable for a wide range of cutting conditions as a standard grade for general machining of steel. It can successfully be used for a range of cutting speeds from 100 to 200 m/min with better wear resistance than conventional TiC Cermet. It gives an excellent performance from semi-finish to finish operation of ductile cast iron at cutting speeds of 200 m/min. or less.

Application recommendations

i It is required to prerough following the profile precisely.

i Use conventional approach for face turning.

i Several cuts are required for deep applications.

CERMET

- Maximale Hitzebeständigkeit und Verschleißfestigkeit.
- Ausgezeichnete Oxidationsbeständigkeit.
- Für sehr hohe Schnittgeschwindigkeiten.
- Ideal zum Schlichten.
- Für alle Anwendungen.

Eigenschaften von CERMET

Beschreibung	Zusammensetzung	Farbe	Sorte		Werkstoff
NC25 ist ein neuentwickeltes Cermet, das für eine Vielfalt von Schnittbedingungen geeignet ist, als Standardsorte zur Stahlbearbeitung. Es wird mit Erfolg für einen großen Schnittgeschwindigkeitsbereich von 100 bis 200 m/min mit einer besseren Verschleißfestigkeit als konventionelles TiC Cermet. Es gibt eine hervorragende Leistung bei geringem Schruppen und auch bei Schlichten von Temperguß bei eine Geschwindigkeit von 200 m/min. oder weniger.	Ti+W+Ta/Nb		NC25		P Stahl

Anwendungen-Empfehlungen

i Beim Vorschruppen ist es erforderlich, das Profil genau zu folgen.

i Beim Plandrehen versuchen Sie konventionell an das Werkstück zu gehen.

i Für tiefe Anwendungen braucht man mehrere Schnitte.



CERAMIC

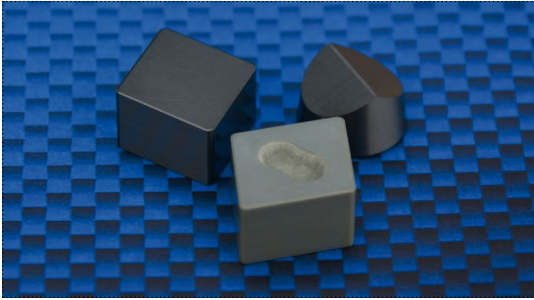

CERAMIC

Ceramic grades are able of running at high speeds, thus reducing expensive machining time. Ceramic inserts are recommended for hard turning of 38HRC to 64HRC hardened steel, or for roughing and finishing of cast iron.

Ceramic maintains good surface finishes due to its low affinity to workpiece materials.

Features of CERAMIC

Material		Grade	Colour	Composition	Definition
K Cast iron		CX9		Al ₂ O ₃	CX9 is a highly wear-resistant tool that has been formed into microstructure by adding a trace amount of zirconia (ZrO ₂) to highly pure alumina (Al ₂ O ₃), the main component of this tool material.
		CC2		Al ₂ O ₃ +TiC	This material is well-balanced between wear resistance and fracture resistance, and it works well in a wide range of cutting cast iron and in the turning of hard materials.
		CX6		SiAlON	CX6 is a ultimate silicon-nitride material that has been developed to improve the notch wear of the conventional ceramics that contain silicon nitride. It reduces notch wear amount in machining gray cast iron.
S Heat resistant alloys		CW1		Al ₂ O ₃ -based	CW1 is a whisker-reinforced composite ceramic material with silicon-carbide whisker added to alumina. Excellent wear resistance with high toughness and crack resistance for heat-resistant alloys and high-hardened mill rolls.
P Steel		CC7		Al ₂ O ₃ +TiC	Since it has the finest grain size particle with a high melting point, the composite CC7 improves both hardness and strength, and it shows superior performance as a special material for machining high-hardened materials.

Ceramic main application areas

Cast iron	Aerospace	Roll turning	Hardened materials



KERAMIK

Keramik-Sorten können zu hohen Geschwindigkeiten arbeiten, wodurch die teuren Bearbeitungszeiten reduziert werden. Keramische Wendschneidplatten sind für die Bearbeitung von gehärtetem Stahl von 38HRC bis 64HRC geeignet, und auch zum Schruppen und Schlichten von Grauguß. Wegen seiner niedrigen Affinität zu den Materialien des Werkstücks gibt Keramik eine gute Oberflächengüte.

Eigenschaften von KERAMIK

Beschreibung	Zusammensetzung	Farbe	Sorte		Werkstoff
CX9 ist eine hoch verschleißfeste Sorte, die eine Mikrostruktur geworden ist, indem man eine Spurmengung von Zirkonium (ZrO_2) zum Aluminiumoxid (Al_2O_3), hinzugefügt hat.	Al_2O_3	○	CX9		K Guß
Dieses Material hat ein gutes Verhältnis zwischen Verschleißfestigkeit und Bruchfestigkeit, und arbeitet gut bei der Bearbeitung von Grauguß und dem Drehen von harten Materialien.	Al_2O_3+TiC	●	CC2		
CX6 ist ein Siliziumnitrid Material, das entwickelt worden ist, um den Kerbverschleiß der konventionellen Keramiken zu verbessern. Es reduziert den Kerbverschleiß bei der Bearbeitung von Grauguß.	SiAlON	○	CX6		
CW1 ist ein Whiskerverstärktes Komposit-Keramikmaterial, bei dem Whisker-Siliziumkarbide dem Aluminiumoxid beigemischt sind. Hervorragende Verschleißfestigkeit bei hoher Zähigkeit und ausgezeichnetem Widerstand gegen Risse. Für hitzebeständige Legierungen und hoch gehärtete Walzen.	Al_2O_3 -Basis	●	CW1		S Hitzebeständige Legierungen
Die Feinstkorn-Partikel von Komposit CC7 haben einen hohen Schmelzpunkt. Das verbessert die Härte und die Standzeit und zeigt eine hervorragende Leistung bei der Bearbeitung von hoch gehärteten Materialien.	Al_2O_3+TiC	●	CC7		P Stahl

Haupt-Einsatzbereiche von Keramik

Guß	Luft- und Raumfahrt	Walzendrehen	Gehärtetes Material

CBN / PCD

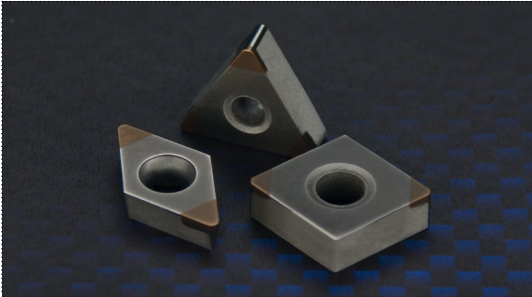

CBN

- High thermal conductivity, which provides stable cutting.
- Suitable for high speed cutting of cast iron and sintered steel.
- Superior wear resistance when cutting hardened materials.

PCD

- Applicable for turning and milling of non-ferrous materials and non-metals.
- Long tool life due to extreme hardness.
- High cutting speeds and increased cutting productivity.

Features of CBN / PCD

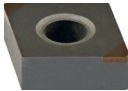
Material	Grade	Colour	Composition	Definition
H Hard materials 	CB10	●	TiCN+Al ₂ O ₃ +TiN	These CBN are formed with a special ceramic binder based on CBN (Cubic Boron Nitride) particles, and the CBN sintered layer increases the thickness of the carbide base. CBN are high-performance tool materials that have high hardness at room temperature and high temperature and are almost free from chemical reactions against the material to be cut.

Material	Materials to be machined with polycrystalline boron nitride	Vc = m/min.	Infeed f = mm/U	Depth of cut ap=mm
CBN	- Hardened materials and nitriding steels.	60-120	0,03-0,2	1
	- High temperature and corrosion resistant alloys with high nickel or cobalt content.	70-150	0,03-0,15	1
	- Gray cast iron, especially hard and abrasion resistant types.	300-600	0,10-0,5	3
	- High speed steel (HSS).	60-120	0,03-0,1	1
	- Metal powder spraying.	60-120	2	1

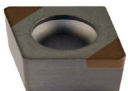
Material	Grade	Colour	Composition	Definition
N Non ferrous materials 	PD10	●	TiCN+Al ₂ O ₃ +TiN	PCD consists of a 0,5 mm thick diamond layer, which is inseparably connected to a carbide base. This polycrystalline diamond layer originates at a pressing operation by bonding of the smallest diamond grains, supported by a metallic bonding agent. This cutting material has also a very long tool life.

Material	Materials to be machined with polycrystalline diamond	Vc = m/min.	Infeed f = mm/U	Depth of cut ap=mm
PCD	- Aluminium alloys under 3% SIC	200-2000	0,05-0,4	up to the whole diamond cutting edge
	- Aluminium alloys up to 12% SIC	150-1000	0,05-0,4	
	- Aluminium alloys up to approx. 21% SIC	100-800	0,05-0,4	
	- Brass, magnesium, zinc alloys.	200-2000	0,05-0,4	
	- Copper, bronze, lead alloys.	200-1000	0,05-0,4	
	- Duro and thermoplastics with and without fillers e.g. epoxy resin.	100-1000	0,05-0,2	
	- Hard papers.	200-600	0,10-0,3	
	- Hard and soft rubber with and without fillers.	100-500	0,10-0,3	
	- Graphite and pre-sintered carbide.	100-500	0,10-0,4	
	- Aluminium oxide, silicon, tungsten.	50-180	0,1	



CBN

- Hohe Wärmeleitfähigkeit, die ein stabiles Schneiden erlaubt.
- Geeignet zum Schneiden bei hohen Geschwindigkeiten von Guß und gesintertem Stahl.
- Sehr hohe Verschleißfestigkeit bei gehärteten Materialien.

PCD

- Geeignet zum Drehen und Fräsen von Nicht-Eisen-Metalle und Nichtmetalle.
- Hohe Standzeit aufgrund seiner extremen Härte.
- Hohe Schnittgeschwindigkeiten und erhöhte Effizienz beim Schneiden.

Eigenschaften von CBN / PCD

Beschreibung	Zusammensetzung	Farbe	Sorte		Werkstoff
CBN wird mit einem speziellen Keramik-Bindemittel gebildet, das CBN-Partikel (kubisches Bornitrid) enthält. Die gesinterte CBN-Schicht liegt auf der Hartmetall-Basis. CBN sind hochleistende Materialien, die eine hohe Härte bei Raumtemperatur und auch bei hoher Temperatur haben, und fast keine chemische Reaktionen gegen das zu bearbeitende Material zeigen.	TiCN+Al ₂ O ₃ +TiN		CB10		H Harte Materialien

Schnitttiefe ap=mm	Vorschub f = mm/U	Vc = m/min.	Mit polykristalinem Bornitrid zu bearbeitende Materialien Werkstoff	
1	0,03-0,2	60-120	- Gehärtete Materialien und nitrierter Stahl.	CBN
1	0,03-0,15	70-150	- Hohe Temperaturen- und korrosionsbeständige Legierungen mit einem hohen Anteil an Nickel oder Kobalt.	
3	0,10-0,5	300-600	- Grauguß, insbesondere hart und abrasionsbeständige Typen.	
1	0,03-0,1	60-120	- Schnellarbeitsstahl (HSS).	
1	2	60-120	- Metallpulver zum Spritzgießen.	

Beschreibung	Zusammensetzung	Farbe	Sorte		Werkstoff
PCD besteht aus einer 0,5 mm dicken Diamant-Schicht, die mit einer Hartmetall-Basis untrennbar verbunden ist. Diese polykristaline Diamant-Schicht entsteht bei einer Pressoperation, die sehr kleine Diamant-Körner mit einem metallischen Bindemittel zusammenbindet. Diese Sorte erzielt auch sehr lange Standzeiten.	TiCN+Al ₂ O ₃ +TiN		PD10		N Nicht-Eisen-Metalle

Schnitttiefe ap=mm	Vorschub f = mm/U	Vc = m/min.	Mit polykristalinem Diamant zu bearbeitende Materialien Werkstoff	
bis der ganzen Diamant-Schnittkante	0,05-0,4	200-2000	- Aluminium-Legierungen unter 3% SiC	PCD
	0,05-0,4	150-1000	- Aluminium-Legierungen bis 12% SiC	
	0,05-0,4	100-800	- Aluminium-Legierungen bis ca. 21% SiC	
	0,05-0,4	200-2000	- Messing-, Magnesium- und Zink-Legierungen.	
	0,05-0,4	200-1000	- Kupfer-, Bronze- und Blei-Legierungen.	
	0,05-0,2	100-1000	- Duro-Kunststoff und Thermoplast mit und ohne Füller z. B. Epoxidharz.	
	0,10-0,3	200-600	- Harte Papiere.	
	0,10-0,3	100-500	- Harter und weicher Gummi mit und ohne Füller.	
	0,10-0,4	100-500	- Graphit und vorgesintertes Hartmetall.	
700	0,1	50-180	- Aluminiumoxid, Silyzium, Tungsten.	

Insert selection / Wendeschneidplattenwahl

- Main application / Haupteinsatzbereich
- Extended application / Nebeneinsatzbereich

		Machining type Bearbeitungsart	Material Werkstoff	Continuous Ununterbrochen	Slight interruption Leicht unterbrochen	Interruption Unterbrochen
				●	●	⊕
- FC		Finishing / Schlichten ●	●	TN15	TN15	TN30
		Medium / Medium ○	○	TN15	-	-
		Roughing / Schruppen	○	TN15	-	-
- FMC		Finishing / Schlichten ●	●	TN15	TN15	-
		Medium / Medium ○	○	-	-	-
		Roughing / Schruppen	○	-	-	-
- CC		Finishing / Schlichten ●	●	NC25	NC25	-
		Medium / Medium	○	-	-	-
		Roughing / Schruppen	○	●	NC25	-
- MC		Finishing / Schlichten ●	●	TN15	TN15	TN30
		Medium / Medium ●	●	TN35	TN35	TN35
		Roughing / Schruppen	○	TN15	-	-
- MFC		Finishing / Schlichten ○	●	TN15	TN15	TN30
		Medium / Medium ●	○	-	-	-
		Roughing / Schruppen ○	○	-	-	-
- MHC		Finishing / Schlichten	●	TN15	TN20	TN30
		Medium / Medium ●	○	-	-	-
		Roughing / Schruppen ●	○	-	-	-
- RC		Finishing / Schlichten	●	TN15	TN15	TN30
		Medium / Medium ○	○	-	-	TN30
		Roughing / Schruppen ●	○	-	-	-
- TC		Finishing / Schlichten ●	●	TS20	TS20	-
		Medium / Medium ●	○	-	-	-
		Roughing / Schruppen ●	●	TS20	TS20	-
- KC		Finishing / Schlichten ●	○	-	-	-
		Medium / Medium ●	○	-	-	-
		Roughing / Schruppen ●	●	TK15	TK15	TK15



- Main application / Haupteinsatzbereich
- Extended application / Nebeneinsatzbereich

		Machining type Bearbeitungsart	Material Werkstoff	Continuous Ununterbrochen ●	Slight interruption Leicht unterbrochen ◐	Interruption Unterbrochen ⊕
..NGP 	Finishing / Schlichten	●	●	TS15	TS15	-
	Medium / Medium	●	○	TS15	TS15	-
	Roughing / Schruppen		●	TS15	-	-
..NMA 	Finishing / Schlichten	●		-	-	-
	Medium / Medium	●		-	-	-
	Roughing / Schruppen	●	●	TK15	TK15	TK15
..NMM 	Finishing / Schlichten		●	-	TN15	TN30
	Medium / Medium		○	-	-	TN30
	Roughing / Schruppen	●		-	-	-
..NMX 	Finishing / Schlichten	●	●	NC25	NC25	-
	Medium / Medium	○		-	-	-
	Roughing / Schruppen		○	NC25	-	-
- AL 	Finishing / Schlichten	●		-	-	-
	Medium / Medium	●	●	KM15 - ZR10	KM15 - ZR10	KM15 - ZR10
	Roughing / Schruppen	●	○	KM15 - ZR10	-	-
- AP 	Finishing / Schlichten	●		-	-	-
	Medium / Medium	●	●	KM15 - ZR10	KM15 - ZR10	KM15 - ZR10
	Roughing / Schruppen	○	○	KM15 - ZR10	-	-
..MR 	Finishing / Schlichten	●	●	TN15	TN30	TN30
	Medium / Medium	●	○	TN15	TN30	-
	Roughing / Schruppen	○	○	TN15	-	-
..MT 	Finishing / Schlichten	●	●	TN15	TN15	TN30
	Medium / Medium	●	●	TN35	TN35	TN35
	Roughing / Schruppen		●	TN15	-	-
..MW 	Finishing / Schlichten	●	●	PM25	PM25	PM25
	Medium / Medium	●		-	-	-
	Roughing / Schruppen		●	KM15	KM15	KM15



Grade chart / Tabelle von Sorten

		KM15	PM25	PM40	NC25	TN15	TN20	TN30	TN35	TK15	TS15	TS20	TIN25	ZR10
P	P05													
	P10													
	P15													
	P20													
	P25													
	P30													
	P35													
	P40													
	P45													
	P50													
	M	M05												
M10														
M15														
M20														
M25														
M30														
M35														
M40														
K	K05													
	K10													
	K15													
	K20													
	K25													
	K30													
	K35													
	K40													
N	N05													
	N10													
	N15													
	N20													
	N25													
	N30													
S	S05													
	S10													
	S15													
	S20													
	S25													
	S30													
H	H05													
	H10													
	H15													
	H20													
	H25													
	H30													

ISO Code key / ISO Bezeichnung

INSERT SHAPE FORM DER WENDEPLATTE		
V	Rhombic 35° Rhombisch 35°	
D	Rhombic 55° Rhombisch 55°	
E	Rhombic 75° Rhombisch 75°	
C	Rhombic 80° Rhombisch 80°	
M	Rhombic 86° Rhombisch 86°	
K	Parallelogram 55° Parallelogramm 55°	
B	Parallelogram 82° Parallelogramm 82°	
A	Parallelogram 85° Parallelogramm 85°	
L	Rectangular 90° Rechteckig 90°	
P	Pentagonal 108° Fünfkant 108°	
H	Hexagonal 120° Sechskant 120°	
O	Octagonal 135° Achtkant 135°	
R	Round Rund	
S	Square 90° Vierkant 90°	
T	Triangular 60° Dreikant 60°	
W	Trigon 80° Trigon 80°	
X	Special design Spezielles Design	

TOLERANCES TOLERANZEN										
	m	Ø d	s	Detail of M Class insert tolerance (Tolerance of nose height m) Detailtoleranz für Wendeschneidplatten M-Klasse (Toleranz ohne Radius m)						
				D.I.C						
A	±0.005	±0.025	±0.025	6.35	±0.08	±0.08	±0.08	±0.11	±0.16	-
F	±0.005	±0.013	±0.025	9.525	±0.08	±0.08	±0.08	±0.11	±0.16	-
C	±0.013	±0.025	±0.025	12.70	±0.13	±0.13	±0.13	±0.15	-	-
H	±0.013	±0.013	±0.025	15.875	±0.15	±0.15	±0.15	±0.18	-	-
E	±0.025	±0.025	±0.025	19.05	±0.15	±0.15	±0.15	±0.18	-	-
G	±0.025	±0.025	±0.013	25.40	-	±0.18	-	-	-	-
J	±0.005	±0.05 - ±0.15	±0.025	31.75	-	±0.20	-	-	-	-
Detail of M Class insert tolerance (Tolerance of inscribed circle d) Detailtoleranz für Wendeschneidplatten M-Klasse (Toleranz des Innenkreises d)										
				D.I.C						
K	±0.013	±0.05 - ±0.15	±0.025	6.35	±0.05	±0.05	±0.05	±0.05	±0.05	-
L	±0.025	±0.05 - ±0.15	±0.025	9.525	±0.05	±0.05	±0.05	±0.05	±0.05	±0.05
M	±0.08 - ±0.20	±0.05 - ±0.15	±0.13	12.70	±0.08	±0.08	±0.08	±0.08	-	±0.08
N	±0.08 - ±0.20	±0.05 - ±0.15	±0.025	15.875	±0.10	±0.10	±0.10	±0.10	-	±0.10
U	±0.13 - ±0.38	±0.08 - ±0.25	±0.13	19.05	±0.10	±0.10	±0.10	±0.10	-	±0.10
				25.40	-	±0.13	-	-	-	±0.13
				31.75	-	±0.15	-	-	-	±0.15

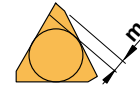
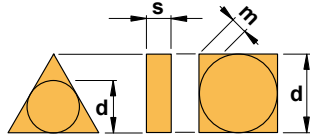

Triangular insert with a facet (Secondary cutting edge)
Dreikant-Wendeschneidplatte mit Seitenschneide (Nebenschneide)



CLEARANCE ANGLE FREIWINKEL		
A	3°	
B	5°	
C	7°	
D	15°	
E	20°	
F	25°	
G	30°	
N	0°	
P	11°	

SYMBOL FOR FIXING AND/OR FOR CHIPBREAKER BEFESTIGUNGS- UND/ODER SPANBRECHERSYMBOL				
Metric / Metrisch				
	Hole Loch	Hole configuration Loch-Konfiguration	Chipbreaker Spanbrecher	Figure Abbildung
N	Without hole / Ohne Loch	-	No / Nein	
R	Without hole / Ohne Loch	-	One-sided / Einseitig	
F	Without hole / Ohne Loch	-	Double-sided / Doppelseitig	
A	With hole / Mit Loch	Cylindrical hole Zylindrisches Loch	No / Nein	
M	With hole / Mit Loch	Cylindrical hole Zylindrisches Loch	One-sided / Einseitig	
G	With hole / Mit Loch	Cylindrical hole Zylindrisches Loch	Double-sided / Doppelseitig	
W	With hole / Mit Loch	Cylindrical hole + One countersink (40-60°) Zylindrisches Loch + Einseitige Senkung (40-60°)	No / Nein	
T	With hole / Mit Loch	Cylindrical hole + One-sided countersink (40-60°) Zylindrisches Loch + Einseitige Senkung (40-60°)	One-sided / Einseitig	
Q	With hole / Mit Loch	Cylindrical hole + Double countersink (40-60°) Zylindrisches Loch + Doppelseitige Senkung (40-60°)	No / Nein	
U	With hole / Mit Loch	Cylindrical hole + Double countersink (40-60°) Zylindrisches Loch + Doppelseitige Senkung (40-60°)	Double-sided / Doppelseitig	
B	With hole / Mit Loch	Cylindrical hole + One countersink (70-90°) Zylindrisches Loch + Einseitige Senkung (70-90°)	No / Nein	
H	With hole / Mit Loch	Cylindrical hole + One-sided countersink (70-90°) Zylindrisches Loch + Einseitige Senkung (70-90°)	One-sided / Einseitig	
C	With hole / Mit Loch	Cylindrical hole + Double countersink (70-90°) Zylindrisches Loch + Doppelseitige Senkung (70-90°)	No / Nein	
J	With hole / Mit Loch	Cylindrical hole + Double countersink (70-90°) Zylindrisches Loch + Doppelseitige Senkung (70-90°)	Double-sided / Doppelseitig	
X	-	-	-	Special / Spezielles Design



SYMBOL FOR INSERT SIZE SYMBOL FÜR WENDEPLATTENGRÖSSE							
	04	03	03	06			3,97
08	05	04	04	08			4,76
09	06	05	05	09	03		5,56
						06	6,00
11	07	06	06	11	04		6,35
13	09	08	07	13	05		7,94
						08	8,00
16	11	09	09	16	06		9,52
						10	10,00
						12	12,00
22	15	12	12	22	08		12,70
	19	16	15	27	10		15,87
						16	16,00
	23	19	19	33	13		19,00
						20	20,00
	27	22	22	38			22,22
						25	25,00
	31	25	25	44			25,40
	38	32	31	54			31,75
						32	32,00

INSERT CORNER ECKENRADIUS			
00	0,0	12	1,2
M0	0,0	16	1,6
02	0,2	20	2,0
04	0,4	24	2,4
08	0,8	32	3,2
SECONDARY CUTTING EDGE WINKEL DER NEBENSCHNEIDE			
A	45°	F	85°
D	60°	P	90°
E	75°		
CLEARANCE ANGLE FREIWINKEL			
A	3°	F	25°
B	5°	G	30°
C	7°	N	0°
D	15°	P	11°
E	20°	Z	Special Spezielles

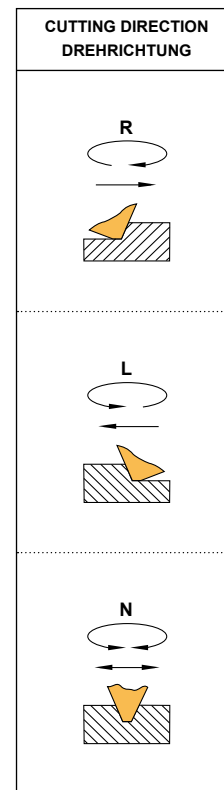















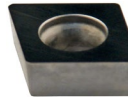















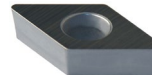

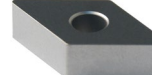



12 04 08 E N FC

SYMBOL FOR INSERT THICKNESS SYMBOL FÜR WENDEPLATTENDICKE	
SYMBOL	THICKNESS (mm) DICKE (mm)
01	1,59
02	2,38
03	3,18
T3	3,97
04	4,76
05	5,56
06	6,35
07	7,94
09	9,52



















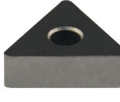

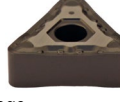
SYMBOL FOR CUTTING EDGE CONDITION SYMBOL FÜR SCHNEIDKANTENAUSFÜHRUNG	
SYMBOL	CUTTING EDGE SCHNEIDKANTE
F	Sharp Scharf
E	Honed Abgerundet
T	Chamfered Gefasst
S	Chamfered and honed Gefasst und abgerundet
K	Double-chamfered Doppelgefasset
P	Double-chamfered and honed Doppelgefasset und abgerundet

SYMBOL FOR CHIPBREAKER SYMBOL FÜR SPANBRECHER		
AL	AP	CC
FC	FMC	KC
MC	MFC	MHC
MR	MT	MW
NGP	NMA	NMM
NMX	RC	TC

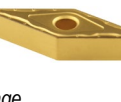













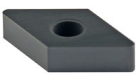

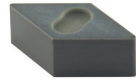

<p>ADMT-R</p>  <p>Page Seite A30 15° <input checked="" type="checkbox"/></p>	<p>CCET</p>  <p>Page Seite A30 7° <input checked="" type="checkbox"/></p>	<p>CCGT-AL</p>  <p>Page Seite A30 7° <input checked="" type="checkbox"/></p>	<p>CCGT-AP</p>  <p>Page Seite A31 7° <input checked="" type="checkbox"/></p>	<p>CCMT</p>  <p>Page Seite A31 7° <input checked="" type="checkbox"/></p>	<p>CCMW</p>  <p>Page Seite A31 7° <input checked="" type="checkbox"/></p>
<p>CNGP</p>  <p>Page Seite A32 0° <input type="checkbox"/></p>	<p>CNMA</p>  <p>Page Seite A32 0° <input type="checkbox"/></p>	<p>CNMG-CC</p>  <p>Page Seite A32 0° <input type="checkbox"/></p>	<p>CNMG-FC</p>  <p>Page Seite A32 0° <input type="checkbox"/></p>	<p>CNMG-FMC</p>  <p>Page Seite A32 0° <input type="checkbox"/></p>	<p>CNMG-KC</p>  <p>Page Seite A33 0° <input type="checkbox"/></p>
<p>CNMG-MC</p>  <p>Page Seite A33 0° <input type="checkbox"/></p>	<p>CNMG-MFC</p>  <p>Page Seite A33 0° <input type="checkbox"/></p>	<p>CNMG-MHC</p>  <p>Page Seite A33 0° <input type="checkbox"/></p>	<p>CNMG-RC</p>  <p>Page Seite A33 0° <input type="checkbox"/></p>	<p>CNMG-TC</p>  <p>Page Seite A34 0° <input type="checkbox"/></p>	<p>CNMM</p>  <p>Page Seite A34 0° <input type="checkbox"/></p>
<p>DCGT-AL</p>  <p>Page Seite A35 7° <input checked="" type="checkbox"/></p>	<p>DCGT-AP</p>  <p>Page Seite A35 7° <input checked="" type="checkbox"/></p>	<p>DCMT</p>  <p>Page Seite A35 7° <input checked="" type="checkbox"/></p>	<p>DCMW</p>  <p>Page Seite A35 7° <input checked="" type="checkbox"/></p>	<p>DNGP</p>  <p>Page Seite A36 0° <input type="checkbox"/></p>	<p>DNMA</p>  <p>Page Seite A36 0° <input type="checkbox"/></p>
<p>DNMG-FC</p>  <p>Page Seite A36 0° <input type="checkbox"/></p>	<p>DNMG-FMC</p>  <p>Page Seite A36 0° <input type="checkbox"/></p>	<p>DNMG-KC</p>  <p>Page Seite A36 0° <input type="checkbox"/></p>	<p>DNMG-MC</p>  <p>Page Seite A37 0° <input type="checkbox"/></p>	<p>DNMG-MFC</p>  <p>Page Seite A37 0° <input type="checkbox"/></p>	<p>DNMG-MHC</p>  <p>Page Seite A37 0° <input type="checkbox"/></p>
<p>DNMG-TC</p>  <p>Page Seite A37 0° <input type="checkbox"/></p>	<p>DNMX</p>  <p>Page Seite A37 0° <input type="checkbox"/></p>				
<p>KNUX</p>  <p>Page Seite A38 0° <input type="checkbox"/></p>					
<p>RCGT-AL</p>  <p>Page Seite A38 7° <input checked="" type="checkbox"/></p>	<p>RCGT-AP</p>  <p>Page Seite A38 7° <input checked="" type="checkbox"/></p>	<p>RCMT</p>  <p>Page Seite A39 7° <input checked="" type="checkbox"/></p>	<p>RNMG</p>  <p>Page Seite A39 0° <input type="checkbox"/></p>		



<p>SCGT-AL</p>  <p>Page Seite A40 7° <input checked="" type="checkbox"/></p>	<p>SCMT</p>  <p>Page Seite A40 7° <input checked="" type="checkbox"/></p>	<p>SCMT-39</p>  <p>Page Seite A40 7° <input checked="" type="checkbox"/></p>	<p>SCMW</p>  <p>Page Seite A40 7° <input checked="" type="checkbox"/></p>		<p>SNMG-FMC</p>  <p>Page Seite A41 0° <input type="checkbox"/></p>
<p>SNMG-KC</p>  <p>Page Seite A41 0° <input type="checkbox"/></p>	<p>SNMG-MHC</p>  <p>Page Seite A41 0° <input type="checkbox"/></p>	<p>SNMG-RC</p>  <p>Page Seite A41 0° <input type="checkbox"/></p>	<p>SNMG-TC</p>  <p>Page Seite A42 0° <input type="checkbox"/></p>	<p>SNMM</p>  <p>Page Seite A42 0° <input type="checkbox"/></p>	<p>SPMR</p>  <p>Page Seite A43 11° <input checked="" type="checkbox"/></p>
<p>SPUN</p>  <p>Page Seite A43 11° <input checked="" type="checkbox"/></p>		<p>TCGT-AL</p>  <p>Page Seite A44 7° <input checked="" type="checkbox"/></p>	<p>TCMT</p>  <p>Page Seite A44 7° <input checked="" type="checkbox"/></p>	<p>TCMW</p>  <p>Page Seite A44 7° <input checked="" type="checkbox"/></p>	<p>TNMA</p>  <p>Page Seite A45 0° <input type="checkbox"/></p>
<p>TNMG-CC</p>  <p>Page Seite A45 0° <input type="checkbox"/></p>	<p>TNMG-FC</p>  <p>Page Seite A45 0° <input type="checkbox"/></p>	<p>TNMG-FMC</p>  <p>Page Seite A45 0° <input type="checkbox"/></p>	<p>TNMG-KC</p>  <p>Page Seite A45 0° <input type="checkbox"/></p>	<p>TNMG-MC</p>  <p>Page Seite A46 0° <input type="checkbox"/></p>	<p>TNMG-MFC</p>  <p>Page Seite A46 0° <input type="checkbox"/></p>
<p>TNMG-MHC</p>  <p>Page Seite A46 0° <input type="checkbox"/></p>	<p>TNMG-TC</p>  <p>Page Seite A46 0° <input type="checkbox"/></p>	<p>TNMX</p>  <p>Page Seite A46 0° <input type="checkbox"/></p>	<p>TPMN</p>  <p>Page Seite A47 11° <input checked="" type="checkbox"/></p>	<p>TPMR</p>  <p>Page Seite A47 11° <input checked="" type="checkbox"/></p>	<p>TPUN</p>  <p>Page Seite A47 11° <input checked="" type="checkbox"/></p>
<p>TPUX</p>  <p>Page Seite A47 11° <input checked="" type="checkbox"/></p>		<p>VBMT</p>  <p>Page Seite A48 5° <input checked="" type="checkbox"/></p>	<p>VCGT-AL</p>  <p>Page Seite A48 7° <input checked="" type="checkbox"/></p>	<p>VCGT-AP</p>  <p>Page Seite A48 7° <input checked="" type="checkbox"/></p>	<p>VCMT</p>  <p>Page Seite A48 7° <input checked="" type="checkbox"/></p>
<p>VNGP</p>  <p>Page Seite A49 0° <input type="checkbox"/></p>	<p>VNMG</p>  <p>Page Seite A49 0° <input type="checkbox"/></p>	<p>VNMG-TC</p>  <p>Page Seite A49 0° <input type="checkbox"/></p>		<p>WNMA</p>  <p>Page Seite A50 0° <input type="checkbox"/></p>	<p>WNMG-FC</p>  <p>Page Seite A50 0° <input type="checkbox"/></p>
<p>WNMG-FMC</p>  <p>Page Seite A50 0° <input type="checkbox"/></p>	<p>WNMG-KC</p>  <p>Page Seite A50 0° <input type="checkbox"/></p>	<p>WNMG-MC</p>  <p>Page Seite A50 0° <input type="checkbox"/></p>	<p>WNMG-MFC</p>  <p>Page Seite A51 0° <input type="checkbox"/></p>	<p>WNMG-MHC</p>  <p>Page Seite A51 0° <input type="checkbox"/></p>	<p>WNMG-TC</p>  <p>Page Seite A51 0° <input type="checkbox"/></p>

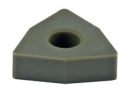

**Ceramic inserts
Keramik-Wendeplatten**

<p>CNGA</p>  <p>Page Seite A54 0° <input type="checkbox"/></p>	<p>CNGN</p>  <p>Page Seite A54 0° <input type="checkbox"/></p>	<p>CNGX</p>  <p>Page Seite A54 0° <input type="checkbox"/></p>	<p>DNGA</p>  <p>Page Seite A54 0° <input type="checkbox"/></p>	<p>DNGN</p>  <p>Page Seite A54 0° <input type="checkbox"/></p>	<p>DNGX</p>  <p>Page Seite A55 0° <input type="checkbox"/></p>
<p>GWG</p>  <p>Page Seite A55 3° <input checked="" type="checkbox"/></p>	<p>RCGX</p>  <p>Page Seite A55 7° <input checked="" type="checkbox"/></p>	<p>RNGN</p>  <p>Page Seite A55 0° <input type="checkbox"/></p>	<p>RPGN</p>  <p>Page Seite A56 0° <input type="checkbox"/></p>	<p>SNGA</p>  <p>Page Seite 56 0° <input type="checkbox"/></p>	<p>SNGN</p>  <p>Page Seite A56 0° <input type="checkbox"/></p>
<p>SNGN</p>  <p>Page Seite A56 0° <input type="checkbox"/></p>	<p>SNGX</p>  <p>Page Seite A57 0° <input type="checkbox"/></p>	<p>TNGA</p>  <p>Page Seite A57 0° <input type="checkbox"/></p>	<p>TNGN</p>  <p>Page Seite A57 0° <input type="checkbox"/></p>	<p>VNGA</p>  <p>Page Seite A57 0° <input type="checkbox"/></p>	<p>WNGA</p>  <p>Page Seite A58 0° <input type="checkbox"/></p>

**CBN/PCD Inserts
CBN/PCD Wendeplatten**

<p>CCMW</p>  <p>Page Seite A59 7° <input checked="" type="checkbox"/></p>	<p>CNGA</p>  <p>Page Seite A59 0° <input type="checkbox"/></p>	<p>DCMW</p>  <p>Page Seite A59 7° <input checked="" type="checkbox"/></p>	<p>DNGA</p>  <p>Page Seite A59 0° <input type="checkbox"/></p>	<p>SNGA</p>  <p>Page Seite A59 0° <input type="checkbox"/></p>	<p>TCMW</p>  <p>Page Seite A60 7° <input checked="" type="checkbox"/></p>
<p>TNGA</p>  <p>Page Seite A60 0° <input type="checkbox"/></p>	<p>TPMN</p>  <p>Page Seite A60 11° <input checked="" type="checkbox"/></p>				

Inserts ADMT-R

More information see page A30

Wendeschneidplatten ADMT-R

Für weitere Informationen, siehe Seite A30





80° Rhombic inserts / Positive Rhombische Wendeschneidplatten 80° / Positiv

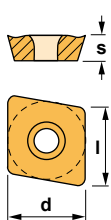

- i** Use classification / Einsatzbereich
- Continuous / Ununterbrochen
 - ◐ Slight interruption / Leicht unterbrochen
 - ⊕ Interruption / Unterbrochen
- i** Availability / Verfügbarkeit
- Standard item / Standard-Artikel
 - Check availability / Verfügbarkeit prüfen

	P	M	K	N	S	H													
P	Steel Stahl																		
M	Stainless Rostfreier Stahl																		
K	Cast iron Guß																		
N	Non ferrous materials Nicht-Eisen-Metalle																		
S	Heat-resistant alloys Hitzebeständige Legierungen																		
H	Hard materials Harte Materialien																		

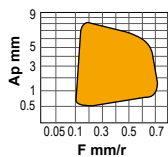

CCGT-AP



Reference / Bezeichnung	l	s	d	r	KM15	PM25	PM40	NC25	TN15	TN20	TN30	TN35	TK15	TS15	TS20	TIN25	ZR10
CCGT 060202-AP	6,45	2,38	6,35	0,2	●												○
CCGT 060204-AP	6,45	2,38	6,35	0,4	●												○
CCGT 09T302-AP	9,65	3,97	9,52	0,2	●												○
CCGT 09T304-AP	9,65	3,97	9,52	0,4	●												○
CCGT 09T308-AP	9,65	3,97	9,52	0,8	●												○
CCGT 120402-AP	12,90	4,76	12,70	0,2	●												○
CCGT 120404-AP	12,90	4,76	12,70	0,4	●												○
CCGT 120408-AP	12,90	4,76	12,70	0,8	●												○

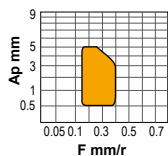

CCMT



Reference / Bezeichnung	l	s	d	r	KM15	PM25	PM40	NC25	TN15	TN20	TN30	TN35	TK15	TS15	TS20	TIN25	ZR10
CCMT 060202	6,45	2,38	6,35	0,2	●				●								
CCMT 060204	6,45	2,38	6,35	0,4	●			●	●		●	●				●	
CCMT 080304	8,05	3,18	7,94	0,4	●				●							●	
CCMT 080308	8,05	3,18	7,94	0,8	●				●							●	
CCMT 09T304	9,65	3,97	9,52	0,4	●			●	●		●	●				●	
CCMT 09T308	9,65	3,97	9,52	0,8	●			●	●		●	●				●	
CCMT 120408	12,90	4,76	12,70	0,8	●				●		●					●	

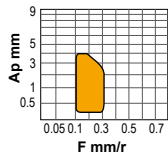

CCMW



Reference / Bezeichnung	l	s	d	r	KM15	PM25	PM40	NC25	TN15	TN20	TN30	TN35	TK15	TS15	TS20	TIN25	ZR10
CCMW 060202	6,45	2,38	6,35	0,2												○	
CCMW 060204	6,45	2,38	6,35	0,4		●										○	
CCMW 080304	8,05	3,18	7,94	0,4		●										○	
CCMW 09T304	9,65	3,97	9,52	0,4		●										○	
CCMW 09T308	9,65	3,97	9,52	0,8		●										○	
CCMW 120408	12,90	4,76	12,70	0,8		●										○	

80° Rhombic inserts / Negative
Rhombische Wendeschneidplatten 80° / Negativ

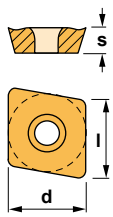

- i** Use classification / Einsatzbereich
- Continuous / Ununterbrochen
 - ◐ Slight interruption / Leicht unterbrochen
 - ⊕ Interruption / Unterbrochen
- i** Availability / Verfügbarkeit
- Standard item / Standard-Artikel
 - Check availability / Verfügbarkeit prüfen

	P	M	K	N	S	H													
Steel / Stahl	⊕	⊕	●	●	●	●													
Stainless / Rostfreier Stahl		⊕			●														
Cast iron / Guß			⊕		●														
Non ferrous materials / Nicht-Eisen-Metalle				●															
Heat-resistant alloys / Hitzebeständige Legierungen					●														
Hard materials / Harte Materialien																			



CNGP

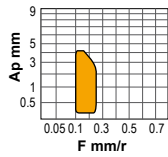

Reference / Bezeichnung	l	s	d	r	KM15	PM25	PM40	NC25	TN15	TN20	TN30	TN35	TK15	TS15	TS20	TIN25	ZR10
CNGP 120404	12,90	4,76	12,70	0,4											●		
CNGP 120408	12,90	4,76	12,70	0,8										●			

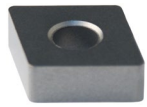

CNMA

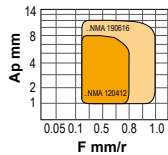

Reference / Bezeichnung	l	s	d	r	KM15	PM25	PM40	NC25	TN15	TN20	TN30	TN35	TK15	TS15	TS20	TIN25	ZR10
CNMA 120408	12,90	4,76	12,70	0,8										●			
CNMA 120412	12,90	4,76	12,70	1,2									○				

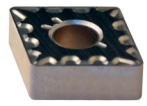

CNMG-CC

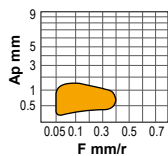

Reference / Bezeichnung	l	s	d	r	KM15	PM25	PM40	NC25	TN15	TN20	TN30	TN35	TK15	TS15	TS20	TIN25	ZR10
CNMG 120404-CC	12,90	4,76	12,70	0,4				●									
CNMG 120408-CC	12,90	4,76	12,70	0,8				●									

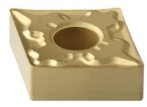

CNMG-FC

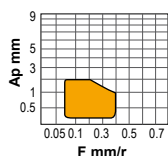

Reference / Bezeichnung	l	s	d	r	KM15	PM25	PM40	NC25	TN15	TN20	TN30	TN35	TK15	TS15	TS20	TIN25	ZR10
CNMG 090304-FC	9,65	3,18	9,52	0,4					●								
CNMG 090308-FC	9,65	3,18	9,52	0,8					●								
CNMG 120404-FC	12,90	4,76	12,70	0,4					●		●						

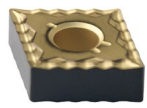

CNMG-FMC

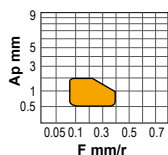

Reference / Bezeichnung	l	s	d	r	KM15	PM25	PM40	NC25	TN15	TN20	TN30	TN35	TK15	TS15	TS20	TIN25	ZR10
CNMG 120404-FMC	12,90	4,76	12,70	0,4					●								



55° Rhombic inserts / Positive Rhombische Wendeschneidplatten 55° / Positiv

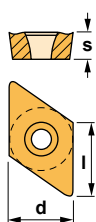

- i** Use classification / Einsatzbereich
- Continuous / Ununterbrochen
 - ◐ Slight interruption / Leicht unterbrochen
 - ⊕ Interruption / Unterbrochen
- i** Availability / Verfügbarkeit
- Standard item / Standard-Artikel
 - Check availability / Verfügbarkeit prüfen

	P	M	K	N	S	H													
P	Steel Stahl																		
M	Stainless Rostfreier Stahl																		
K	Cast iron Guß																		
N	Non ferrous materials Nicht-Eisen-Metalle																		
S	Heat-resistant alloys Hitzebeständige Legierungen																		
H	Hard materials Harte Materialien																		

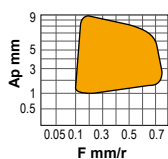

DCGT-AL



Reference / Bezeichnung	l	s	d	r	KM15	PM25	PM40	NC25	TN15	TN20	TN30	TN35	TK15	TS15	TS20	TIN25	ZR10
DCGT 070202-AL	7,75	2,38	6,35	0,2	●												○
DCGT 070204-AL	7,75	2,38	6,35	0,4	●												○
DCGT 11T302-AL	11,60	3,97	9,52	0,2	●												○
DCGT 11T304-AL	11,60	3,97	9,52	0,4	●												○
DCGT 11T308-AL	11,60	3,97	9,52	0,8	●												○

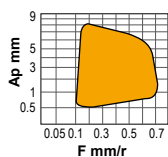

DCGT-AP



Reference / Bezeichnung	l	s	d	r	KM15	PM25	PM40	NC25	TN15	TN20	TN30	TN35	TK15	TS15	TS20	TIN25	ZR10
DCGT 070202-AP	7,75	2,38	6,35	0,2	●												○
DCGT 070204-AP	7,75	2,38	6,35	0,4	●												○
DCGT 11T302-AP	11,60	3,97	9,52	0,2	●												○
DCGT 11T304-AP	11,60	3,97	9,52	0,4	●												○
DCGT 11T308-AP	11,60	3,97	9,52	0,8	●												○

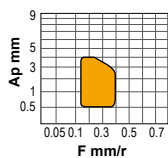

DCMT



Reference / Bezeichnung	l	s	d	r	KM15	PM25	PM40	NC25	TN15	TN20	TN30	TN35	TK15	TS15	TS20	TIN25	ZR10
DCMT 070204	7,75	2,38	6,35	0,4		●		●	●		●	●					
DCMT 11T304	11,60	3,97	9,52	0,4				●	●		●	●					
DCMT 11T308	11,60	3,97	9,52	0,8				●	●		●	●					
DCMT 150408	15,50	4,76	12,70	0,8					●								

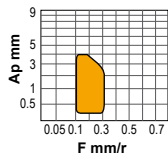
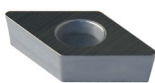

DCMW



Reference / Bezeichnung	l	s	d	r	KM15	PM25	PM40	NC25	TN15	TN20	TN30	TN35	TK15	TS15	TS20	TIN25	ZR10
DCMW 11T304	11,60	3,97	9,52	0,4	●												
DCMW 11T308	11,60	3,97	9,52	0,8	●												
DCMW 150408	15,50	4,76	12,70	0,8	●												

55° Rhombic inserts / Negative
Rhombische Wendeschneidplatten 55° / Negativ

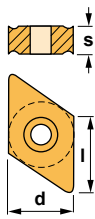

- i** Use classification / Einsatzbereich
- Continuous / Ununterbrochen
 - ◐ Slight interruption / Leicht unterbrochen
 - ⊕ Interruption / Unterbrochen
- i** Availability / Verfügbarkeit
- Standard item / Standard-Artikel
 - Check availability / Verfügbarkeit prüfen

	P	M	K	N	S	H														
P	Steel Stahl																			
M	Stainless Rostfreier Stahl																			
K	Cast iron Guß																			
N	Non ferrous materials Nicht-Eisen-Metalle																			
S	Heat-resistant alloys Hitzebeständige Legierungen																			
H	Hard materials Harte Materialien																			

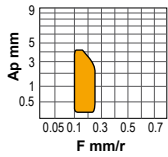

DNGP

Reference / Bezeichnung	l	s	d	r	KM15	PM25	PM40	NC25	TN15	TN20	TN30	TN35	TK15	TS15	TS20	TIN25	ZR10
DNGP 150404	15,50	4,76	12,70	0,4													
DNGP 150408	15,50	4,76	12,70	0,8													

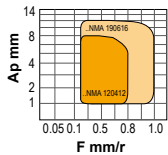
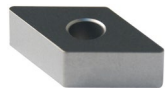

DNMA

Reference / Bezeichnung	l	s	d	r	KM15	PM25	PM40	NC25	TN15	TN20	TN30	TN35	TK15	TS15	TS20	TIN25	ZR10
DNMA 150608	15,50	6,35	12,70	0,8													
DNMA 150612	15,50	6,35	12,70	1,2													

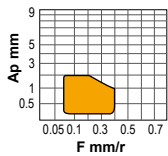

DNMG-FC

Reference / Bezeichnung	l	s	d	r	KM15	PM25	PM40	NC25	TN15	TN20	TN30	TN35	TK15	TS15	TS20	TIN25	ZR10
DNMG 110404-FC	11,60	4,76	9,52	0,4													
DNMG 110408-FC	11,60	4,76	9,52	0,8													
DNMG 150404-FC	15,50	4,76	12,70	0,4													
DNMG 150604-FC	15,50	6,35	12,70	0,4													

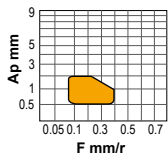

DNMG-FMC

Reference / Bezeichnung	l	s	d	r	KM15	PM25	PM40	NC25	TN15	TN20	TN30	TN35	TK15	TS15	TS20	TIN25	ZR10
DNMG 150404-FMC	15,50	4,76	12,70	0,4													
DNMG 150604-FMC	15,50	6,35	12,70	0,4													

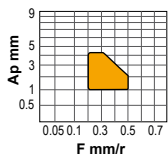

DNMG-KC

Reference / Bezeichnung	l	s	d	r	KM15	PM25	PM40	NC25	TN15	TN20	TN30	TN35	TK15	TS15	TS20	TIN25	ZR10
DNMG 150608-KC	15,50	6,35	12,70	0,8													
DNMG 150612-KC	15,50	6,35	12,70	1,2													



55° Rhombic inserts / Negative Rhombische Wendeschneidplatten 55° / Negativ

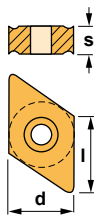

- i** Use classification / Einsatzbereich
- Continuous / Ununterbrochen
 - ◐ Slight interruption / Leicht unterbrochen
 - ⊕ Interruption / Unterbrochen
- i** Availability / Verfügbarkeit
- Standard item / Standard-Artikel
 - Check availability / Verfügbarkeit prüfen

	P	M	K	N	S	H														
P	Steel Stahl																			
M	Stainless Rostfreier Stahl																			
K	Cast iron Guß																			
N	Non ferrous materials Nicht-Eisen-Metalle																			
S	Heat-resistant alloys Hitzebeständige Legierungen																			
H	Hard materials Harte Materialien																			

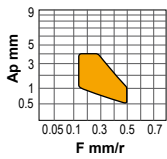

DNMG-MC

Reference / Bezeichnung	l	s	d	r	KM15	PM25	PM40	NC25	TN15	TN20	TN30	TN35	TK15	TS15	TS20	TIN25	ZR10	
DNMG 110408-MC	11,60	4,76	9,52	0,8														
DNMG 150408-MC	15,50	4,76	12,70	0,8														
DNMG 150608-MC	15,50	6,35	12,70	0,8														

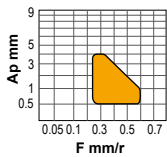

DNMG-MFC

Reference / Bezeichnung	l	s	d	r	KM15	PM25	PM40	NC25	TN15	TN20	TN30	TN35	TK15	TS15	TS20	TIN25	ZR10	
DNMG 150608-MFC	15,50	6,35	12,70	0,8														

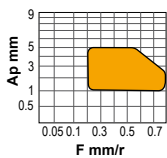

DNMG-MHC

Reference / Bezeichnung	l	s	d	r	KM15	PM25	PM40	NC25	TN15	TN20	TN30	TN35	TK15	TS15	TS20	TIN25	ZR10	
DNMG 150408-MHC	15,50	4,76	12,70	0,8														
DNMG 150608-MHC	15,50	6,35	12,70	0,8														
DNMG 150612-MHC	15,50	6,35	12,70	1,2														
DNMG 190608-MHC	19,40	6,35	15,88	0,8														
DNMG 190612-MHC	19,40	6,35	15,88	1,2														

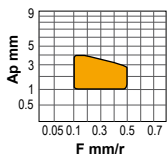

DNMG-TC

Reference / Bezeichnung	l	s	d	r	KM15	PM25	PM40	NC25	TN15	TN20	TN30	TN35	TK15	TS15	TS20	TIN25	ZR10	
DNMG 150608-TC	15,50	6,35	12,70	0,8														

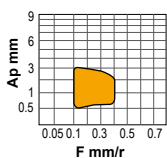

DNMX

Reference / Bezeichnung	l	s	d	r	KM15	PM25	PM40	NC25	TN15	TN20	TN30	TN35	TK15	TS15	TS20	TIN25	ZR10	
DNMX 150604R-22	15,50	6,35	12,70	0,4														
DNMX 150608R-22	15,50	6,35	12,70	0,8														

Square inserts / Negative
Vierkant-Wendeschneidplatten / Negativ

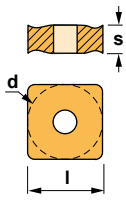

- i** Use classification / Einsatzbereich
- Continuous / Ununterbrochen
 - Slight interruption / Leicht unterbrochen
 - ⊕ Interruption / Unterbrochen
- i** Availability / Verfügbarkeit
- Standard item / Standard-Artikel
 - Check availability / Verfügbarkeit prüfen

	P	M	K	N	S	H													
P	Steel Stahl																		
M	Stainless Rostfreier Stahl																		
K	Cast iron Guß																		
N	Non ferrous materials Nicht-Eisen-Metalle																		
S	Heat-resistant alloys Hitzebeständige Legierungen																		
H	Hard materials Harte Materialien																		



SNMG-TC

Reference / Bezeichnung

l s d r

KM15 PM25 PM40 NC25 TN15 TN20 TN30 TN35 TK15 TS15 TS20 TIN25 ZR10

SNMG 120408-TC 12,70 4,76 12,70 0,8

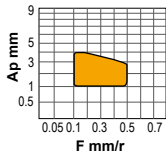

SNMM

Reference / Bezeichnung

l s d r

KM15 PM25 PM40 NC25 TN15 TN20 TN30 TN35 TK15 TS15 TS20 TIN25 ZR10

SNMM 190616 19,05 6,35 19,05 1,6

SNMM 250724 25,40 7,94 25,40 2,4

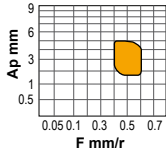



Square inserts / Positive Vierkant-Wendeschneidplatten / Positiv

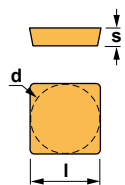

- i** Use classification / Einsatzbereich
- Continuous / Ununterbrochen
 - Slight interruption / Leicht unterbrochen
 - ⊕ Interruption / Unterbrochen
- i** Availability / Verfügbarkeit
- Standard item / Standard-Artikel
 - Check availability / Verfügbarkeit prüfen

	P	M	K	N	S	H													
P	Steel Stahl																		
M	Stainless Rostfreier Stahl																		
K	Cast iron Guß																		
N	Non ferrous materials Nicht-Eisen-Metalle																		
S	Heat-resistant alloys Hitzebeständige Legierungen																		
H	Hard materials Harte Materialien																		

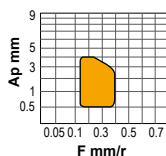

SPMR



Reference / Bezeichnung	l	s	d	r	KM15	PM25	PM40	NC25	TN15	TN20	TN30	TN35	TK15	TS15	TS20	TIN25	ZR10
SPMR 090308	9,52	3,18	9,52	0,8						●							
SPMR 120304	12,70	3,18	12,70	0,4					●								
SPMR 120308	12,70	3,18	12,70	0,8	●					●							

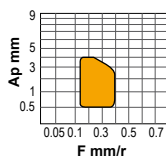

SPUN



Reference / Bezeichnung	l	s	d	r	KM15	PM25	PM40	NC25	TN15	TN20	TN30	TN35	TK15	TS15	TS20	TIN25	ZR10
SPUN 090304E	9,52	3,18	9,52	0,4		●										●	
SPUN 090308E	9,52	3,18	9,52	0,8		●										●	
SPUN 120304E	12,70	3,18	12,70	0,4		●										●	
SPUN 120308E	12,70	3,18	12,70	0,8		●										●	
SPUN 120308F	12,70	3,18	12,70	0,8	●											●	
SPUN 120312E	12,70	3,18	12,70	1,2			●									●	
SPUN 120408E	12,70	4,76	12,70	0,8		○											
SPUN 150408E	15,88	4,76	15,88	0,8		●											
SPUN 150412E	15,88	4,76	15,88	1,2		○											
SPUN 190412E	19,05	4,76	19,05	1,2		○											



Triangular inserts / Negative Dreikant-Wendeschneidplatten / Negativ

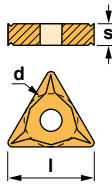

- i** Use classification / Einsatzbereich
- Continuous / Ununterbrochen
- ◐ Slight interruption / Leicht unterbrochen
- ⊕ Interruption / Unterbrochen
- i** Availability / Verfügbarkeit
- Standard item / Standard-Artikel
- Check availability / Verfügbarkeit prüfen

	P	M	K	N	S	H														
P	Steel Stahl																			
M	Stainless Rostfreier Stahl																			
K	Cast iron Guß																			
N	Non ferrous materials Nicht-Eisen-Metalle																			
S	Heat-resistant alloys Hitzebeständige Legierungen																			
H	Hard materials Harte Materialien																			

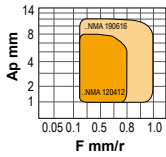
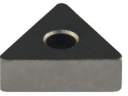

TNMA

Reference / Bezeichnung	l	s	d	r	KM15	PM25	PM40	NC25	TN15	TN20	TN30	TN35	TK15	TS15	TS20	TIN25	ZR10
TNMA 160408	16,50	4,76	9,52	0,8													
TNMA 220408	22,00	4,76	12,70	0,8													
TNMA 220412	22,00	4,76	12,70	1,2													
TNMA 220416	22,00	4,76	12,70	1,6													

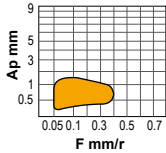

TNMG-CC

Reference / Bezeichnung	l	s	d	r	KM15	PM25	PM40	NC25	TN15	TN20	TN30	TN35	TK15	TS15	TS20	TIN25	ZR10
TNMG 160404-CC	16,50	4,76	9,52	0,4				●									
TNMG 160408-CC	16,50	4,76	9,52	0,8				●									

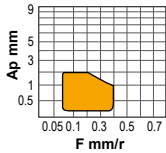

TNMG-FC

Reference / Bezeichnung	l	s	d	r	KM15	PM25	PM40	NC25	TN15	TN20	TN30	TN35	TK15	TS15	TS20	TIN25	ZR10
TNMG 160404-FC	16,50	4,76	9,52	0,4					●		●						
TNMG 220404-FC	22,00	4,76	12,70	0,4					●								

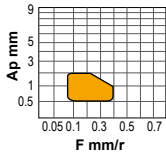
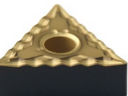

TNMG-FMC

Reference / Bezeichnung	l	s	d	r	KM15	PM25	PM40	NC25	TN15	TN20	TN30	TN35	TK15	TS15	TS20	TIN25	ZR10
TNMG 160404-FMC	16,50	4,76	9,52	0,4					●								

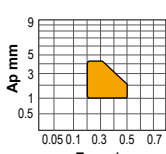
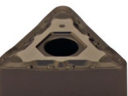

TNMG-KC

Reference / Bezeichnung	l	s	d	r	KM15	PM25	PM40	NC25	TN15	TN20	TN30	TN35	TK15	TS15	TS20	TIN25	ZR10
TNMG 160408-KC	16,50	4,76	9,52	0,8									●				
TNMG 160412-KC	16,50	4,76	9,52	1,2									●				
TNMG 220408-KC	22,00	4,76	12,70	0,8									●				

35° Rhombic inserts / Positive
Rhombische Wendeschneidplatten 35° / Positiv

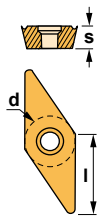

- i** Use classification / Einsatzbereich
- Continuous / Ununterbrochen
 - ◐ Slight interruption / Leicht unterbrochen
 - ⊕ Interruption / Unterbrochen
- i** Availability / Verfügbarkeit
- Standard item / Standard-Artikel
 - Check availability / Verfügbarkeit prüfen

	P	M	K	N	S	H														
P	Steel Stahl																			
M	Stainless Rostfreier Stahl																			
K	Cast iron Guß																			
N	Non ferrous materials Nicht-Eisen-Metalle																			
S	Heat-resistant alloys Hitzebeständige Legierungen																			
H	Hard materials Harte Materialien																			

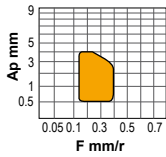

VBMT



Reference / Bezeichnung	l	s	d	r
VBMT 160404	16,50	4,76	9,52	0,4
VBMT 160408	16,50	4,76	9,52	0,8

	KM15	PM25	PM40	NC25	TN15	TN20	TN30	TN35	TK15	TS15	TS20	TIN25	ZR10
VBMT 160404					●								
VBMT 160408					●								

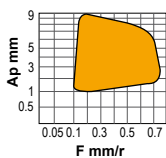
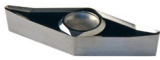

VCGT-AL



Reference / Bezeichnung	l	s	d	r
VCGT 160404-AL	16,50	4,76	9,52	0,4
VCGT 160408-AL	16,50	4,76	9,52	0,8
VCGT 160412-AL	16,50	4,76	9,52	1,2
VCGT 220530-AL	22,10	5,56	12,70	3,0

	KM15	PM25	PM40	NC25	TN15	TN20	TN30	TN35	TK15	TS15	TS20	TIN25	ZR10
VCGT 160404-AL	●												○
VCGT 160408-AL	●												○
VCGT 160412-AL	●												○
VCGT 220530-AL	●												○

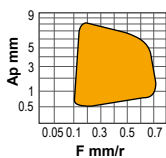

VCGT-AP



Reference / Bezeichnung	l	s	d	r
VCGT 160404-AP	16,50	4,76	9,52	0,4
VCGT 160408-AP	16,50	4,76	9,52	0,8
VCGT 160412-AP	16,50	4,76	9,52	1,2
VCGT 220530-AP	22,10	5,56	12,70	3,0

	KM15	PM25	PM40	NC25	TN15	TN20	TN30	TN35	TK15	TS15	TS20	TIN25	ZR10
VCGT 160404-AP	●												○
VCGT 160408-AP	●												○
VCGT 160412-AP	●												○
VCGT 220530-AP	●												○

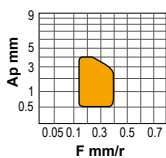

VCMT



Reference / Bezeichnung	l	s	d	r
VCMT 110304	11,00	3,18	6,35	0,4
VCMT 130304	13,00	3,18	7,94	0,4
VCMT 160404	16,50	4,76	9,52	0,4
VCMT 160408	16,50	4,76	9,52	0,8

	KM15	PM25	PM40	NC25	TN15	TN20	TN30	TN35	TK15	TS15	TS20	TIN25	ZR10
VCMT 110304					●								
VCMT 130304					●								
VCMT 160404					●			●					
VCMT 160408						●		●					

Turning insert wear and tool life

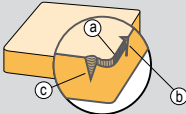
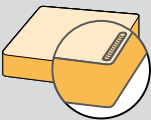
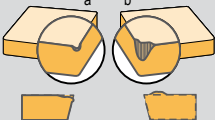
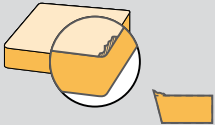
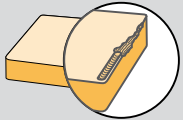
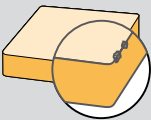
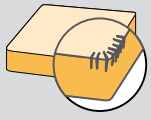
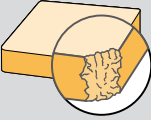
	Problem	Cause and remedy
<p>Flank and notch wear</p> 	<ul style="list-style-type: none"> ▼ Rapid flank wear causing poor surface finish or out of tolerance (a). ▼ Notch wear causing poor surface finish and risk of edge breakage. 	<ul style="list-style-type: none"> ▲ A too high cutting speed or insufficient wear resistance (a). ▲ Oxidation or excessive attrition wear caused by a hard surface (b,c). <p>Reduce the cutting speed. Select a more wear resistant grade. Select an Al₂O₃ coated grade for steel machining. For work hardening materials select a larger lead angle or a more wear resistant grade.</p>
<p>Crater wear</p> 	<ul style="list-style-type: none"> ▼ Excessive crater wear causing a weakened edge. Cutting edge break through on the trailing edge causes poor surface finish. 	<ul style="list-style-type: none"> ▲ Diffusion wear due to too high cutting temperatures on the rake face. <p>Select an Al₂O₃ coated grade. Select a positive insert geometry. Obtain a lower temperature by reducing the feed and speed.</p>
<p>Plastic deformation</p> 	<ul style="list-style-type: none"> ▼ Plastic deformation (edge depression (a) or flank impression (b)) leading to poor chip control and poor surface finish. Risk of excessive flank wear leading to insert breakage. 	<ul style="list-style-type: none"> ▲ A too high cutting temperature in combination with a high pressure. <p>Select a harder grade with better resistance to plastic deformation. (a) Reduce cutting speed. (b) Reduce feed.</p>
<p>Built-up edge</p> 	<ul style="list-style-type: none"> ▼ Built-up edge (B.U.E.) causing poor surface finish and cutting edge chattering when the B.U.E. is torn away. 	<ul style="list-style-type: none"> ▲ Workpiece material is welded to the insert due to: <ul style="list-style-type: none"> - low cutting speed. - negative cutting geometry. - "sticky" material, e.g. certain stainless steels and pure aluminium. <p>Increase cutting speed. Select a positive geometry. Increase cutting speed drastically. If tool life turns out to be short, apply coolant in large quantities.</p>
<p>Chip hammering</p> 	<ul style="list-style-type: none"> ▼ The part of the cutting edge not in cut is damaged through chip hammering. Both the top side and the support for the insert, can be damaged. 	<ul style="list-style-type: none"> ▲ The chips are of an excessive length and are deflected against the cutting edge. <p>Change the feed slightly. Select an alternative insert geometry. Change the lead angle of the holder.</p>
<p>Frittering</p> 	<ul style="list-style-type: none"> ▼ Small cutting edge fractures (frittering) causing poor surface finish and excessive flank wear. 	<ul style="list-style-type: none"> ▲ Grade too brittle. ▲ Insert geometry too weak. ▲ Built-up edge. <p>Select a tougher grade. Select an insert with a stronger geometry. Increase cutting speed or select a positive geometry.</p>
<p>Thermal cracks</p> 	<ul style="list-style-type: none"> ▼ Small cracks perpendicular to the cutting edge causing frittering and poor surface finish. 	<ul style="list-style-type: none"> ▲ Thermal cracks due to temperature variations caused by: <ul style="list-style-type: none"> - Intermittent machining. - Varying coolant supply. <p>Select a tougher grade with better resistant to thermal shocks. Coolant should be applied copiously or not at all.</p>
<p>Insert breakage</p> 	<ul style="list-style-type: none"> ▼ Insert breakage that damages not only the insert but also the shim and workpiece. 	<ul style="list-style-type: none"> ▲ Grade too brittle. ▲ Excessive load on the insert. ▲ Insert geometry too weak. ▲ Insert size is too small. <p>Select a tougher grade. Reduce the feed and/or the depth of the cut. Select a stronger geometry, preferably a single sided insert. Select a thicker/larger insert.</p>



Verschleiß und Standzeit der Dreh-Wendeschnidplatten

	Problem	Ursache und Maßnahmen
<p>Freiflächen- und Kerbverschleiß</p>	<ul style="list-style-type: none"> ▼ Schneller Freiflächenverschleiß, was eine schlechte Oberflächengüte oder eine schlechte Maßgenauigkeit verursacht (a). ▼ Kerbverschleiß, was eine schlechte Oberflächengüte und Gefahr von Schneidkantenbruch verursacht (b, c). 	<ul style="list-style-type: none"> ▲ Zu hohe Schnittgeschwindigkeit oder ungenügende Verschleißfestigkeit (a). ▲ Oxidation oder zu hoher Abriebverschleiß wegen einer harten Oberfläche (b, c). Schnittgeschwindigkeit reduzieren. Eine verschleißfestere Sorte wählen. Eine Al₂O₃ beschichtete Sorte für Stahlbearbeitung wählen. Um kaltverfestigendes Material zu bearbeiten, einen kleineren Einstellwinkel oder eine verschleißfestere Sorte wählen.
<p>Kolkverschleiß</p>	<ul style="list-style-type: none"> ▼ Schneller Kolkverschleiß, was eine schwache Schneidkante verursacht. Die Schneidkante bricht an der Nebenschneide, was eine schlechte Oberflächengüte verursacht. 	<ul style="list-style-type: none"> ▲ Diffusionsverschleiß wegen zu hoher Schnitttemperatur im Spanwinkel. Eine Al₂O₃ beschichtete Sorte wählen. Eine positive Schneidengeometrie wählen. Eine niedrigere Temperatur erreichen, indem man Vorschub und Geschwindigkeit reduziert.
<p>Plastische Verformung</p>	<ul style="list-style-type: none"> ▼ Plastische Verformung (a-Schneidkante, b-Freifläche), was schlechte Spankontrolle und eine schlechte Oberflächengüte verursacht. Es gibt ein Risiko zu übermäßigem Freiflächenverschleiß, was Wendeplattenbruch verursacht. 	<ul style="list-style-type: none"> ▲ Zu hohe Schneidtemperatur zusammen mit zu hohem Druck. Eine härtere Sorte mit besserem Widerstand gegen plastische Verformung wählen. Für a) - Schnittgeschwindigkeit reduzieren. Für b) - Vorschub reduzieren.
<p>Aufbauschneide</p>	<ul style="list-style-type: none"> ▼ Schneidenaufbau, der eine schlechte Oberflächengüte und Kantenausbrüche verursacht, wenn man den Schneidenaufbau abreißt. 	<ul style="list-style-type: none"> ▲ Das Werkstückmaterial verschleißt sich mit der Wendeschnidplatte wegen: - zu niedrige Schnittgeschwindigkeit. - negative Schneidengeometrie. - klebriges Material, z.B. einige rostfreie Stähle und Aluminium. Schnittgeschwindigkeit erhöhen. Eine positive Schneidengeometrie wählen. Schnittgeschwindigkeit drastisch erhöhen und wenn die Dauerhaftigkeit sehr klein ist, Kühlmittel reichlich anwenden.
<p>Späneschlag</p>	<ul style="list-style-type: none"> ▼ Der nicht schneidende Teil der Schneidkante ist von den Spänen geschlagen und beschädigt. Dadurch können Spanfläche und Plattensitz beschädigt werden. 	<ul style="list-style-type: none"> ▲ Die Späne sind zu lang und werden gegen die Schneidkante abgelenkt. Vorschub leicht ändern. Eine andere Geometrie wählen. Den Einstellwinkel des Werkzeugs ändern.
<p>Kantenausbrüche</p>	<ul style="list-style-type: none"> ▼ Kleine Ausbrüche längs der Schneidkante, was eine schlechte Oberflächengüte und einen schnelleren Freiflächenverschleiß verursacht. 	<ul style="list-style-type: none"> ▲ Zu verschleißfeste Sorte. ▲ Zu schwache Geometrie. ▲ Schneidenaufbau. Eine zähere Sorte wählen. Eine Wendeschnidplatte mit einer stärkeren Geometrie wählen. Schnittgeschwindigkeit erhöhen oder eine positive Geometrie wählen.
<p>Kammrisse</p>	<ul style="list-style-type: none"> ▼ Kleine Risse senkrecht zur Schneidkante, was Kantenausbruch und eine schlechte Oberflächengüte verursachen. 	<ul style="list-style-type: none"> ▲ Kammrisse wegen Wärmewechselbelastungen aufgrund von: - Unterbrochenem Schnitt. - Ungleichmässiger Kühlmittelzufuhr. Eine zähere Sorte mit höherem Widerstand gegen Wärmewechselbelastungen wählen. Kühlmittel soll reichlich oder überhaupt nicht zugeführt werden.
<p>Plattenbruch</p>	<ul style="list-style-type: none"> ▼ Plattenbruch, der nicht nur die Wendeschnidplatte selbst, sondern auch den Plattensitz und das Werkstück beschädigt. 	<ul style="list-style-type: none"> ▲ Zu verschleißfeste Sorte. ▲ Zu hohe Belastung der Wendeschnidplatte. ▲ Zu schwache Wendeschnidplattengeometrie. ▲ Zu kleine Wendeschnidplatte. Eine zähere Sorte wählen. Vorschub und/oder Schnitttiefe reduzieren. Eine stärkere Geometrie wählen, vorzugsweise eine einseitige Wendeplatte. Eine dickere/größere Wendeschnidplatte wählen.

Ceramic inserts
Keramik-Wendeschneidplatten

USE CLASSIFICATION

- Continuous
- ◐ Slight interruption
- ⊕ Interruption

AVAILABILITY

- Standard item
- Check availability

EINSATZBEREICH

- Ununterbrochen
- ◐ Leicht unterbrochen
- ⊕ Unterbrochen

VERFÜGBARKEIT

- Standard-Artikel
- Verfügbarkeit prüfen

Material Werkstoff	Grade Sorte	● Continuous Ununterbrochen	◐ Slight interruption Leicht unterbrochen	⊕ Interruption Unterbrochen
K Cast iron Guß	CC2	→		
	CX6	→		→
	CW1	→		→
S Heat-resistant alloys Hitzebeständige Legierungen	CX9	→		→
	CW1	→		→
H Hard materials Harte Materialien	CC7	→		

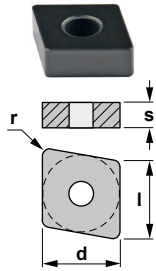

CNGA

80° rhombic negative insert.
80° rhombische negative Wendeschneidplatte.

Reference / Bezeichnung	l	s	d	r	CX6	CX9	CC2	CC7	CW1
CNGA 120404	12,90	4,76	12,70	0,4				●	
CNGA 120408	12,90	4,76	12,70	0,8	●			●	
CNGA 120412	12,90	4,76	12,70	1,2	●			●	

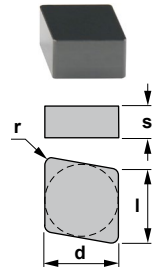

CNGN

80° rhombic negative insert.
80° rhombische negative Wendeschneidplatte.

Reference / Bezeichnung	l	s	d	r	CX6	CX9	CC2	CC7	CW1
CNGN 120408	12,90	4,76	12,70	0,8				●	●
CNGN 120412	12,90	4,76	12,70	1,2				●	●
CNGN 120708	12,90	7,94	12,70	0,8				●	●
CNGN 120712	12,90	7,94	12,70	1,2				●	●
CNGN 120716	12,90	7,94	12,70	1,6				●	●

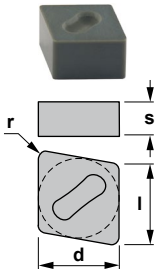

CNGX

80° rhombic negative insert.
80° rhombische negative Wendeschneidplatte.

Reference / Bezeichnung	l	s	d	r	CX6	CX9	CC2	CC7	CW1
CNGX 120708	12,90	7,94	12,70	0,8	●	●			
CNGX 120712	12,90	7,94	12,70	1,2	●	●			
CNGX 120716	12,90	7,94	12,70	1,6	●	●			
CNGX 160712	16,10	7,94	15,87	1,2	●				
CNGX 160716	16,10	7,94	15,87	1,6	●	●			

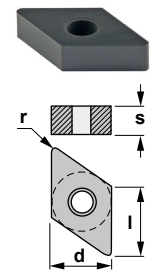

DNGA

55° rhombic negative insert.
55° rhombische negative Wendeschneidplatte.

Reference / Bezeichnung	l	s	d	r	CX6	CX9	CC2	CC7	CW1
DNGA 150404	12,90	4,76	12,70	0,4				●	
DNGA 150408	12,90	4,76	12,70	0,8	●			●	
DNGA 150412	12,90	4,76	12,70	1,2	●			●	

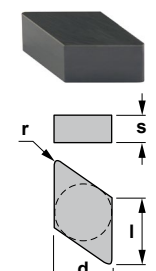

DNGN

55° rhombic negative insert.
55° rhombische negative Wendeschneidplatte.

Reference / Bezeichnung	l	s	d	r	CX6	CX9	CC2	CC7	CW1
DNGN 150708	15,50	7,94	12,70	0,8				●	●
DNGN 150712	15,50	7,94	12,70	1,2				●	●
DNGN 150716	15,50	7,94	12,70	1,6				●	



Ceramic inserts Keramik-Wendeschneidplatten

USE CLASSIFICATION

- Continuous
- ◐ Slight interruption
- ⊕ Interruption

AVAILABILITY

- Standard item
- Check availability

EINSATZBEREICH

- Ununterbrochen
- ◐ Leicht unterbrochen
- ⊕ Unterbrochen

VERFÜGBARKEIT

- Standard-Artikel
- Verfügbarkeit prüfen

Material Werkstoff	Grade Sorte	● Continuous Ununterbrochen	◐ Slight interruption Leicht unterbrochen	⊕ Interruption Unterbrochen
K Cast iron Guß	CC2	▶		
	CX6	▶		▶
	CW1	▶		
S Heat-resistant alloys Hitzebeständige Legierungen	CX9	▶		▶
	CW1	▶		
H Hard materials Harte Materialien	CC7	▶		

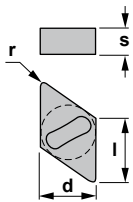
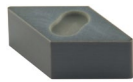

DNGX

55° rhombic negative insert.
55° rhombische negative Wendeschneidplatte.

Reference / Bezeichnung	l	s	d	r	CX6	CX9	CC2	CC7	CW1
DNGX 120708	12,20	7,94	10,00	0,8	●				
DNGX 120712	12,20	7,94	10,00	1,2	●				
DNGX 120716	12,20	7,94	10,00	1,6	●				
DNGX 150708	15,50	7,94	12,70	0,8	●				
DNGX 150712	15,50	7,94	12,70	1,2	●	●			
DNGX 150716	15,50	7,94	12,70	1,6	●	●			

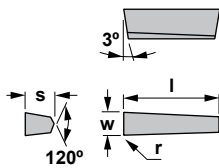

GWG

Positive insert.
Positive Wendeschneidplatte.

Reference / Bezeichnung	l	s	w	r	CX6	CX9	CC2	CC7	CW1
GWG 04 M	12,00	5,00	4,00	0,5	○				
GWG 05 M	12,00	5,00	5,00	0,8	○				
GWG 06 M	15,00	7,50	6,00	0,8	○				
GWG 07	15,00	7,50	7,00	0,8	○				
GWG 08	15,00	7,50	8,00	0,8	○				
GWG 10	15,00	7,50	10,00	0,8	○				

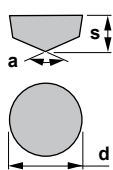

RCGX

Round positive insert.
Runde positive Wendeschneidplatte.

Reference / Bezeichnung	s	d	a	CX6	CX9	CC2	CC7	CW1
RCGX 060700	7,94	6,35	120°			●		●
RCGX 090700	7,94	9,52	120°		●	●		●
RCGX 120700	7,94	12,70	120°		●	●		●
RCGX 151000	10,00	15,87	120°			●		●
RCGX 191000	10,00	19,05	120°		●	●		●
RCGX 251200	12,00	25,40	140°			●		

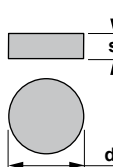
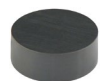

RNGN

Round negative inserts.
Runde negative Wendeschneidplatte.

Reference / Bezeichnung	s	d	CX6	CX9	CC2	CC7	CW1
RNGN 120400	4,76	12,70		●		●	●
RNGN 120700	7,94	12,70		●		●	●

**Ceramic inserts
Keramik-Wendeschneidplatten**

USE CLASSIFICATION

- Continuous
- ◐ Slight interruption
- ⊕ Interruption

AVAILABILITY

- Standard item
- Check availability

EINSATZBEREICH

- Ununterbrochen
- ◐ Leicht unterbrochen
- ⊕ Unterbrochen

VERFÜGBARKEIT

- Standard-Artikel
- Verfügbarkeit prüfen

Material Werkstoff	Grade Sorte	● Continuous Ununterbrochen	◐ Slight interruption Leicht unterbrochen	⊕ Interruption Unterbrochen
K Cast iron Guß	CC2	●	◐	⊕
	CX6	●	◐	⊕
	CW1	●	◐	⊕
S Heat-resistant alloys Hitzebeständige Legierungen	CX9	●	◐	⊕
	CW1	●	◐	⊕
H Hard materials Harte Materialien	CC7	●	◐	⊕

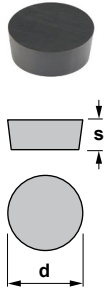

RPGN

Round negative inserts.
Runde negative Wendeschneidplatte.

Reference / Bezeichnung	s	d	CX6	CX9	CC2	CC7	CW1
RPGN 060200	2,38	6,35		●			
RPGN 090300	3,18	9,52		●			
RPGN 120400	4,76	12,70		●			

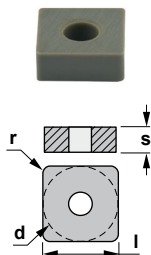

SNGA

Square negative insert.
Vierkantige negative Wendeschneidplatte.

Reference / Bezeichnung	l	s	d	r	CX6	CX9	CC2	CC7	CW1
SNGA 120408	12,70	4,76	12,70	0,8				●	
SNGA 120412	12,70	4,76	12,70	1,2	●			●	
SNGA 120416	12,70	4,76	12,70	1,6	●			●	

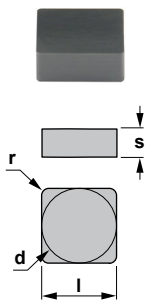

SNGN

Square negative insert.
Vierkantige negative Wendeschneidplatte.

Reference / Bezeichnung	l	s	d	r	CX6	CX9	CC2	CC7	CW1
SNGN 120404	12,70	4,76	12,70	0,4			●		
SNGN 120408	12,70	4,76	12,70	0,8			●		
SNGN 120412	12,70	4,76	12,70	1,2			●		
SNGN 120416	12,70	4,76	12,70	1,6			●		
SNGN 120420	12,70	4,76	12,70	2,0			○		
SNGN 120424	12,70	4,76	12,70	2,4			○		
SNGN 120708	12,70	7,94	12,70	0,8		●	●		●
SNGN 120712	12,70	7,94	12,70	1,2		●	●		●
SNGN 120716	12,70	7,94	12,70	1,6		●	●		●
SNGN 120720	12,70	7,94	12,70	2,0			○		

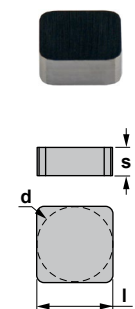

SNGN

Square negative insert.
Vierkantige negative Wendeschneidplatte.

Reference / Bezeichnung	l	s	d	CX6	CX9	CC2	CC7	CW1
SNGN 1204ENT	12,70	4,76	12,70		●			



Ceramic inserts Keramik-Wendeschneidplatten

USE CLASSIFICATION

- Continuous
- ◐ Slight interruption
- ⊕ Interruption

AVAILABILITY

- Standard item
- Check availability

EINSATZBEREICH

- Ununterbrochen
- ◐ Leicht unterbrochen
- ⊕ Unterbrochen

VERFÜGBARKEIT

- Standard-Artikel
- Verfügbarkeit prüfen

Material Werkstoff	Grade Sorte	● Continuous Ununterbrochen	◐ Slight interruption Leicht unterbrochen	⊕ Interruption Unterbrochen
K Cast iron Guß	CC2	→		
	CX6	→		→
	CW1	→		
S Heat-resistant alloys Hitzebeständige Legierungen	CX9	→		→
	CW1	→		
H Hard materials Harte Materialien	CC7	→		

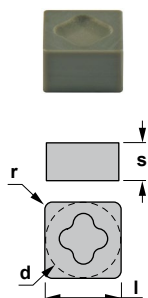

SNGX

Square negative insert.
Vierkantige negative Wendeschneidplatte.

Reference / Bezeichnung	l	s	d	r	CX6	CX9	CC2	CC7	CW1
SNGX 120708	12,70	7,94	12,70	0,8	●				
SNGX 120712	12,70	7,94	12,70	1,2	●				
SNGX 120716	12,70	7,94	12,70	1,6	●				
SNGX 150708	15,87	7,94	15,87	0,8	○				
SNGX 150712	15,87	7,94	15,87	1,2	●	●			
SNGX 150716	15,87	7,94	15,87	1,6	●	●			

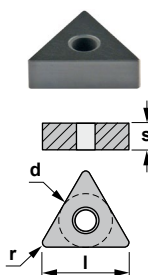

TNGA

Triangular negative insert.
Dreikantige negative Wendeschneidplatte.

Reference / Bezeichnung	l	s	d	r	CX6	CX9	CC2	CC7	CW1
TNGA 160404	16,50	4,76	9,52	0,4				●	
TNGA 160408	16,50	4,76	9,52	0,8				●	
TNGA 160412	16,50	4,76	9,52	1,2				●	
TNGA 160416	16,50	4,76	9,52	1,6				○	

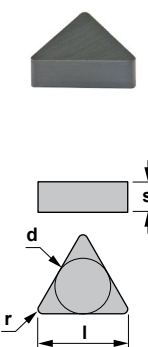

TNGN

Triangular negative insert.
Dreikantige negative Wendeschneidplatte.

Reference / Bezeichnung	l	s	d	r	CX6	CX9	CC2	CC7	CW1
TNGN 160408	16,50	4,76	9,52	0,8			●		
TNGN 160412	16,50	4,76	9,52	1,2			●		
TNGN 160416	16,50	4,76	9,52	1,6			●		
TNGN 160708	16,50	7,94	9,52	0,8			●		
TNGN 160712	16,50	7,94	9,52	1,2			○		

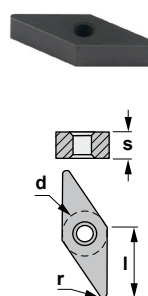

VNGA

35° rhombic negative insert.
35° rhombische negative Wendeschneidplatte.

Reference / Bezeichnung	l	s	d	r	CX6	CX9	CC2	CC7	CW1
VNGA 160404	16,50	4,76	9,52	0,4				●	
VNGA 160408	16,50	4,76	9,52	0,8				●	
VNGA 160412	16,50	4,76	9,52	1,2				●	

Ceramic inserts Keramik-Wendeschneidplatten

USE CLASSIFICATION

- Continuous
- Slight interruption
- ⊕ Interruption

AVAILABILITY

- Standard item
- Check availability

EINSATZBEREICH

- Ununterbrochen
- Leicht unterbrochen
- ⊕ Unterbrochen

VERFÜGBARKEIT

- Standard-Artikel
- Verfügbarkeit prüfen

Material Werkstoff

Grade
Sorte

● Continuous
Ununterbrochen

● Slight interruption
Leicht unterbrochen

⊕ Interruption
Unterbrochen

Material	Grade	Continuous	Slight interruption	Interruption
K Cast iron Guß	CC2	●		
	CX6			⊕
	CW1			⊕
S Heat-resistant alloys Hitzebeständige Legierungen	CX9			⊕
	CW1			⊕
H Hard materials Harte Materialien	CC7	●		

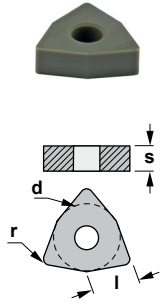

WNGA

80° trigon negative insert.
80° trigon negative Wendeschneidplatte.

Reference / Bezeichnung	l	s	d	r	CX6	CX9	CC2	CC7	CW1
WNGA 080408	8,14	4,76	12,70	0,8	●			●	
WNGA 080412	8,14	4,76	12,70	1,2	●			●	



CBN/PCD Inserts CBN/PCD Wenseschneidplatten

- USE CLASSIFICATION**
- Continuous
 - Slight interruption
 - ⊕ Interruption
- AVAILABILITY**
- Standard item
 - Check availability
- EINSATZBEREICH**
- Ununterbrochen
 - Leicht unterbrochen
 - ⊕ Unterbrochen
- VERFÜGBARKEIT**
- Standard-Artikel
 - Verfügbarkeit prüfen

Material Werkstoff	Grade Sorte	● Continuous Ununterbrochen	● Slight interruption Leicht unterbrochen	⊕ Interruption Unterbrochen
K Cast iron Guß	CBN			
H Hard materials Harte Materialien	CBN			
N Non ferrous materials Nicht-Eisen-Metalle	PCD			

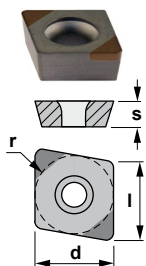

CCMW

80° rhombic positive insert.
80° rhombische positive Wenseschneidplatte.

Reference / Bezeichnung	l	s	d	r	CBN	PCD
CCMW 060202	6,50	2,38	6,35	0,2	○	
CCMW 060204	6,50	2,38	6,35	0,4	●	
CCMW 09T304	9,70	3,97	9,52	0,4	●	
CCMW 09T308	9,70	3,97	9,52	0,8	●	

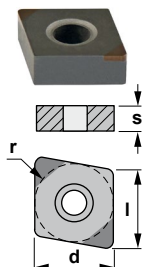

CNGA

80° rhombic negative insert.
80° rhombische negative Wenseschneidplatte.

Reference / Bezeichnung	l	s	d	r	CBN	PCD
CNGA 120404	12,90	4,76	12,70	0,4	●	
CNGA 120408	12,90	4,76	12,70	0,8	●	
CNGA 120412	12,90	4,76	12,70	1,2	○	

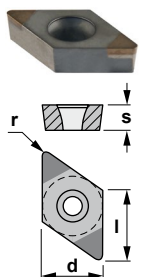

DCMW

55° rhombic positive insert.
55° rhombische positive Wenseschneidplatte.

Reference / Bezeichnung	l	s	d	r	CBN	PCD
DCMW 070202	7,80	2,38	6,35	0,2	○	
DCMW 070204	7,80	2,38	6,35	0,4	●	
DCMW 11T302	11,60	3,97	9,52	0,2	○	
DCMW 11T304	11,60	3,97	9,52	0,4	●	
DCMW 11T308	11,60	3,97	9,52	0,8	●	

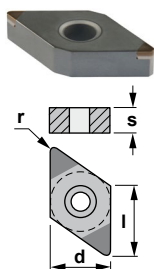

DNGA

55° rhombic negative insert.
55° rhombische negative Wenseschneidplatte.

Reference / Bezeichnung	l	s	d	r	CBN	PCD
DNGA 150404	15,50	4,76	12,70	0,4	●	
DNGA 150408	15,50	4,76	12,70	0,8	●	
DNGA 150412	15,50	4,76	12,70	1,2	○	

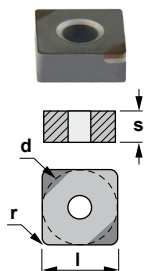

SNGA

Square negative insert.
Vierkantige negative Wenseschneidplatte.

Reference / Bezeichnung	l	s	d	r	CBN	PCD
SNGA 120404	12,70	4,76	12,70	0,4	○	
SNGA 120408	12,70	4,76	12,70	0,8	○	
SNGA 120412	12,70	4,76	12,70	1,2	○	

CBN/PCD Inserts
CBN/PCD Wendeschneidplatten

- USE CLASSIFICATION**
- Continuous
 - ◐ Slight interruption
 - ⊕ Interruption
- AVAILABILITY**
- Standard item
 - Check availability
- EINSATZBEREICH**
- Ununterbrochen
 - ◐ Leicht unterbrochen
 - ⊕ Unterbrochen
- VERFÜGBARKEIT**
- Standard-Artikel
 - Verfügbarkeit prüfen

Material Werkstoff	Grade Sorte	● Continuous Ununterbrochen	◐ Slight interruption Leicht unterbrochen	⊕ Interruption Unterbrochen
K Cast iron Guß	CBN			
H Hard materials Harte Materialien	CBN			
N Non ferrous materials Nicht-Eisen-Metalle	PCD			

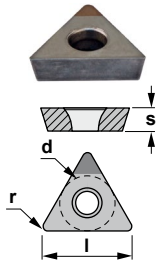

TCMW

Triangular positive insert.
Dreikantige positive Wendeschneidplatte.

Reference / Bezeichnung	l	s	d	r	CBN	PCD
TCMW 110204	11,00	2,38	6,35	0,4	●	
TCMW 16T304	16,50	3,97	9,52	0,4	●	
TCMW 16T308	16,50	3,97	9,52	0,8	●	

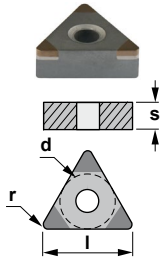

TNGA

Triangular negative insert.
Dreikantige negative Wendeschneidplatte.

Reference / Bezeichnung	l	s	d	r	CBN	PCD
TNGA 160404	16,50	4,76	9,52	0,4	●	
TNGA 160408	16,50	4,76	9,52	0,8	●	
TNGA 160412	16,50	4,76	9,52	1,2	○	

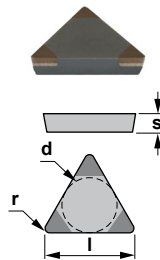

TPMN

Triangular positive insert.
Dreikantige positive Wendeschneidplatte.

Reference / Bezeichnung	l	s	d	r	CBN	PCD
TPMN 110304	11,00	3,18	6,35	0,4	●	
TPMN 110308	11,00	3,18	6,35	0,8	●	
TPMN 160304	16,50	3,18	9,52	0,4	●	
TPMN 160308	16,50	3,18	9,52	0,8	●	
TPMN 160312	16,50	3,18	9,52	1,2	●	



TOOLHOLDERS KLEMMHALTER

Clamping systems Klemmsysteme	A62
Code system (ISO) Kodifizierung (ISO)	A63
Applications index Anwendungen	A64-67
Dimple lock toolholders Klemmhalter mit Dimple Lock-Klemmung	A68-79
Wedge clamp toolholders / Double lock toolholders Klemmhalter mit Prätzen-Klemmung / Klemmhalter mit Doppel-Klemmung	A80-93
Lever lock toolholders Klemmhalter mit Kniehebel-Klemmung	A94-113
Top clamp toolholders Klemmhalter mit oberer Klemmung	A114-127
Center screw toolholders Klemmhalter mit Zentralschrauben-Klemmung	A128-165
Cutting data Schnittdaten	A166-167

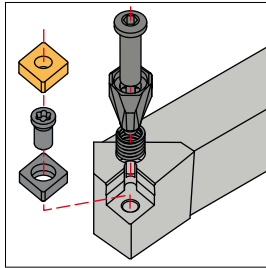

(D) Dimple lock

The "D" clamping system avoids insert movement during high feed or heavily interrupted machining, due to its accurate indexing that holds the insert securely clamped.

Das "D"-Klemmsystem vermeidet die Bewegung der Wendeschneidplatte bei hohem Vorschub oder bei stark unterbrochener Bearbeitung dank der genauen Positionierung, die die Wendeschneidplatte sicher befestigt.

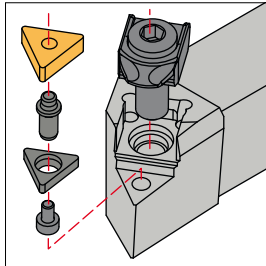
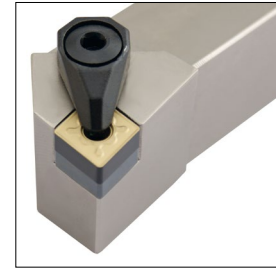

**(M) Wedge clamp
(M) Prätzen-Klemmung**

Negative inserts require good clamping force for heavy duty work, for this purpose we have designed our "M" system, one of the strongest and safest available.

Die negativen Wendepalten für sehr schwere Zerspanungsarbeiten benötigen eine gute Klemmung, dafür bieten wir unser "M" Klemmsystem, das eines der stärksten und sichersten ist.

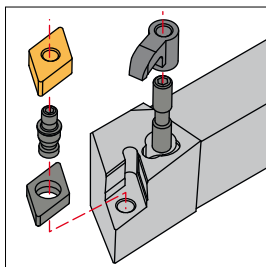
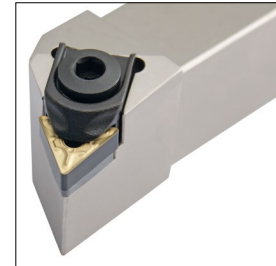

**(M-K) Double lock
(M-K) Doppel-Klemmung**

The double lock system offers good rigidity in negative inserts clamping. It is the first choice for center hole negative ceramic and cermet inserts.

Das doppelte Klemmsystem bietet eine gute Unbeweglichkeit bei der Klemmung von negativen Wendeschneidplatten. Es ist die erste Wahl für negative Keramik-Wendeschneidplatten mit zentralem Loch und auch für Cermet-Wendeschneidplatten.

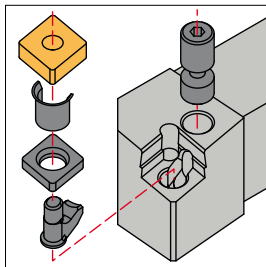

**(P) Lever lock
(P) Kniehebel-Klemmung**

The classic lever lock system allows a wide range of applications. It is the first choice for general purpose turning toolholders.

Das klassische Hebel-System erlaubt eine breite Reihe von Anwendungen. Es ist die erste Wahl für allgemeine Drehoperationen.

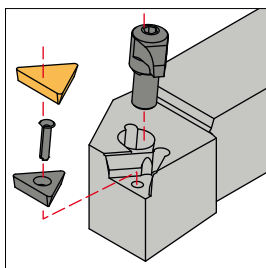

**(C) Top clamp
(C) Obere Klemmung**

The classic positive insert clamping system is designed to hold flat positive inserts, both with additional or sintered chipbreaker.

Dieses klassische Klemmsystem von positiven Wendepalten erlaubt die Verwendung von allen Wendepalten dieses Typs, in üblicher Sinterausführung sowohl als auch mit Spanbrecher.

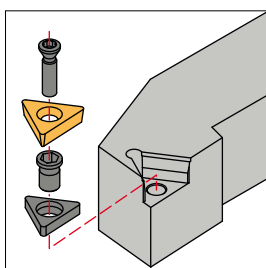
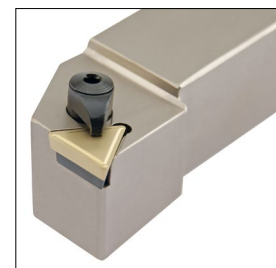

**(S) Center screw
(S) Zentralschrauben-Klemmung**

Since the advent of the TORX screw it has been possible to hold with complete safety positive inserts with center hole. Our range covers all the screw fixing permutations.

Seit der Einführung der Torx-Schraube ist es möglich, die positiven Wendeschneidplatten mit zentralem Loch zu klemmen. Unser Programm bietet alle Klemmmöglichkeiten mit Schraube.



Code system / Kodifizierung (ISO)

P	C	L	N	R	25	25	M	12
1	2	3	4	5	6	7	8	9

1 Clamping method of insert
Klemmsystem

2 Insert shape
Wendeschneidplatten-Form

C	D	E	K
R	S	T	V
W			

4 Clearance angle of insert
Wendeschneidplatten-Freiwinkel

B	C	N	P
---	---	---	---

5 Hand
Bearbeitungsrichtung

6 Shank height, mm
Schafthöhe mm.

7 Shank width, mm
Schaftbreite, mm.

3 Holder style
Einstellwinkel

A	B	C
D	E	F
G	H	J
K	L	M
N	Q	R
S	T	V
X	Z	

8 Tool length, mm
Werkzeuglänge, mm.

D	60	P	170
E	70	R	200
F	80	S	250
H	100	T	300
K	125	U	350
L	140	V	400
M	150	X	Special Sonder

9 Cutting edge length, mm
Schneidkantenlänge, mm.

NEGATIVE TOOLHOLDERS / NEGATIVE KLEMMHALTER

Dimple lock toolholders Klemmhalter mit Dimple Lock-Klemmung

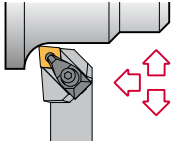
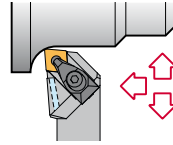
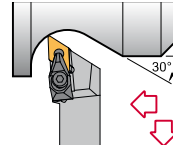
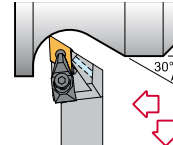
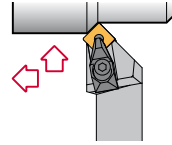
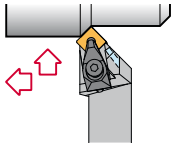
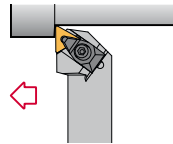
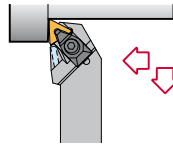
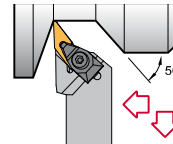
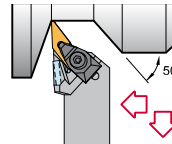
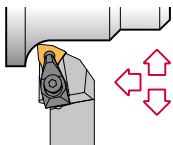
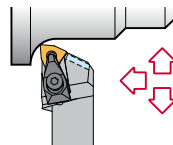
<p>DCLN 95°-N</p>  <p>Page Seite A68</p> <p>CN.. 1204.. CN.. 1906..</p>	<p>DCLN 95°-A</p>  <p>Page Seite A69</p> <p>CN.. 1204.. CN.. 1906..</p>	<p>DDJN 93°-N</p>  <p>Page Seite A70</p> <p>DN.. 1104.. DN.. 1506..</p>	<p>DDJN 93°-A</p>  <p>Page Seite A71</p> <p>DN.. 1104.. DN.. 1506..</p>	<p>DSSN 45°-N</p>  <p>Page Seite A72</p> <p>SNM.. 1204.. SNM.. 1906..</p>
<p>DSSN 45°-A</p>  <p>Page Seite A73</p> <p>SNM.. 1204.. SNM.. 1906..</p>	<p>DTGN 90°-N</p>  <p>Page Seite A74</p> <p>TNM.. 1604.. TNM.. 2204..</p>	<p>DTJN 93°-A</p>  <p>Page Seite A75</p> <p>TNM.. 1604..</p>	<p>DVJN 93°-N</p>  <p>Page Seite A76</p> <p>VN.. 1604..</p>	<p>DVJN 93°-A</p>  <p>Page Seite A77</p> <p>VN.. 1604..</p>
<p>DWLN 95°-N</p>  <p>Page Seite A78</p> <p>WNMG 0804..</p>	<p>DWLN 95°-A</p>  <p>Page Seite A79</p> <p>WNMG 0604.. WNMG 0804..</p>			

Wedge clamp / Double lock toolholders Klemmhalter mit Pratzen- und Doppel-Klemmung

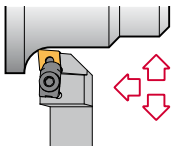
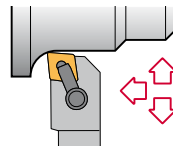
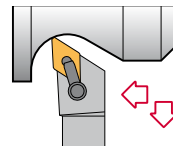
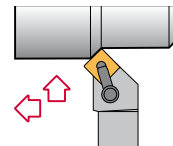
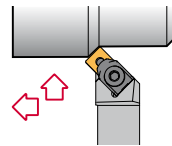
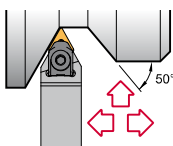
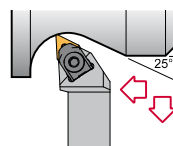
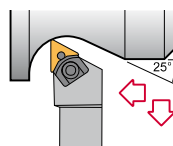
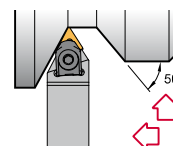
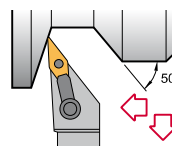
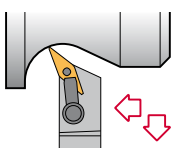
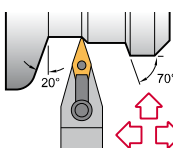
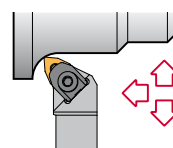
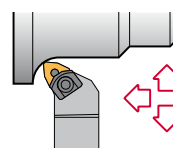
<p>MCLN 95°</p>  <p>Page Seite A80</p> <p>CN.. 1204.. CN.. 1906..</p>	<p>MCLN-K 95°</p>  <p>Page Seite A81</p> <p>CN.. 1204.. CN.. 1906..</p>	<p>MDJN-K 93°</p>  <p>Page Seite A82</p> <p>DN.. 1506..</p>	<p>MSSN-K 45°</p>  <p>Page Seite A83</p> <p>SNM.. 1204..</p>	<p>MSSN 45°</p>  <p>Page Seite A84</p> <p>SNM.. 1204.. SNM.. 1906..</p>
<p>MTEN 60°</p>  <p>Page Seite A85</p> <p>TNM.. 1604.. TNM.. 2204..</p>	<p>MTJN 93°</p>  <p>Page Seite A86</p> <p>TNM.. 1604.. TNM.. 2204..</p>	<p>MTJN-K 93°</p>  <p>Page Seite A87</p> <p>TNM.. 1604.. TNM.. 2204..</p>	<p>MTNN 63°</p>  <p>Page Seite A88</p> <p>TNM.. 1604.. TNM.. 2204..</p>	<p>MVJN-K 93°</p>  <p>Page Seite A89</p> <p>VN.. 1604..</p>
<p>MVQN-K 117°30'</p>  <p>Page Seite A90</p> <p>VN.. 1604..</p>	<p>MVVN-K 72°30'</p>  <p>Page Seite A91</p> <p>VN.. 1604..</p>	<p>MWLN 95°</p>  <p>Page Seite A92</p> <p>WNM.. 0604.. WNM.. 0804..</p>	<p>MWLN-K 95°</p>  <p>Page Seite A93</p> <p>WNM.. 0804..</p>	



NEGATIVE TOOLHOLDERS / NEGATIVE KLEMMHALTER

Lever lock toolholders Klemmhalter mit Kniehebel-Klemmung

<p>PCBN 75°</p> <p>Page Seite A94</p> <p>CN.. 1204.. CN.. 1606.. CN.. 1906.. CN.. 2509..</p>	<p>PCFN 90°</p> <p>Page Seite A95</p> <p>CN.. 1204.. CN.. 1606.. CN.. 1906..</p>	<p>PCKN 75°</p> <p>Page Seite A96</p> <p>CN.. 1204.. CN.. 1906.. CN.. 2509..</p>	<p>PCLN 95°</p> <p>Page Seite A97</p> <p>CN.. 0903.. .. CN.. 2509..</p>	<p>PCMN 50°</p> <p>Page Seite A98</p> <p>CN.. 1204.. CN.. 1906..</p>
<p>PCSN 45°</p> <p>Page Seite A99</p> <p>CN.. 1204.. CN.. 1606.. CN.. 1906..</p>	<p>PDJN 93°</p> <p>Page Seite A100</p> <p>DN.. 1104.. DN.. 1504.. DN.. 1506..</p>	<p>PDNN 63°</p> <p>Page Seite A101</p> <p>DN.. 1504.. DN.. 1506..</p>	<p>PRDC</p> <p>Page Seite A102</p> <p>RC.. 1003.. .. RC.. 3209..</p>	<p>PRSC</p> <p>Page Seite A103</p> <p>RC.. 1003.. .. RC.. 3209..</p>
<p>PRSN</p> <p>Page Seite A104</p> <p>RNMG 0903.. .. RNMG 2509..</p>	<p>PSBN 75°</p> <p>Page Seite A105</p> <p>SNM.. 0903.. SNM.. 2507..</p>	<p>PSDN 45°</p> <p>Page Seite A106</p> <p>SNM.. 0903.. SNM.. 2507..</p>	<p>PSKN 75°</p> <p>Page Seite A107</p> <p>SNM.. 0903.. .. SNM.. 2507..</p>	<p>PSSN 45°</p> <p>Page Seite A108</p> <p>SNM.. 0903.. SNM.. 2507..</p>
<p>PTDN 45°</p> <p>Page Seite A109</p> <p>TNM.. 2204..</p>	<p>PTFN 90°</p> <p>Page Seite A110</p> <p>TNM.. 1604.. .. TNM.. 2706..</p>	<p>PTGN 90°</p> <p>Page Seite A111</p> <p>TNM.. 1604.. .. TNM.. 3307..</p>	<p>PTTN 60°</p> <p>Page Seite A112</p> <p>TNM.. 1604.. TNM.. 2204..</p>	<p>PWLN 95°</p> <p>Page Seite A113</p> <p>WNM.. 0604.. WNM.. 0804..</p>

POSITIVE TOOLHOLDERS / POSITIVE KLEMMHALTER

Top clamp toolholders Klemmhalter mit oberer Klemmung

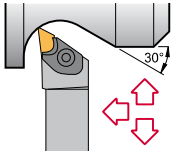
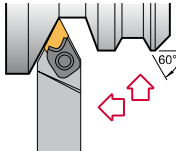
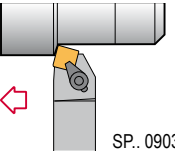
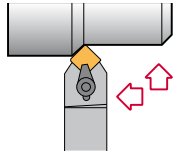
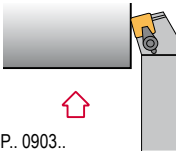
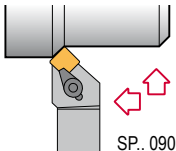
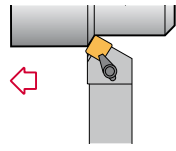
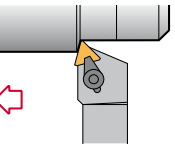
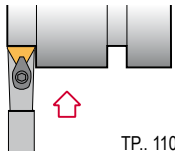
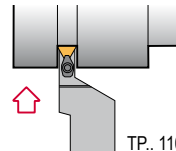
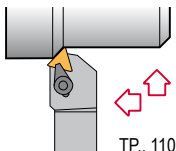
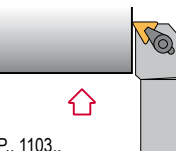
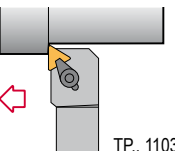
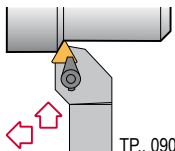
<p>CKJN 93°</p>  <p>Page Seite A114</p> <p>KNUX 1604..</p>	<p>CKNN 63°</p>  <p>Page Seite A115</p> <p>KNUX 1604..</p>	<p>CSBP 75°</p>  <p>Page Seite A116</p> <p>SP.. 0903.. SP.. 1203.. SP.. 1904..</p>	<p>CSDP 45°</p>  <p>Page Seite A117</p> <p>SP.. 0903.. SP.. 1203..</p>	<p>CSKP 75°</p>  <p>Page Seite A118</p> <p>SP.. 0903.. SP.. 1203.. SP.. 1904..</p>
<p>CSSP 45°</p>  <p>Page Seite A119</p> <p>SP.. 0903.. SP.. 1203.. SP.. 1904..</p>	<p>CSTP 60°</p>  <p>Page Seite A120</p> <p>SP.. 0903.. SP.. 1203..</p>	<p>CTBP 75°</p>  <p>Page Seite A121</p> <p>TP.. 1103.. TP.. 1603..</p>	<p>CTCPN 90°</p>  <p>Page Seite A122</p> <p>TP.. 1103.. TP.. 1603.. TP.. 2204..</p>	<p>CTCP 90°</p>  <p>Page Seite A123</p> <p>TP.. 1103.. TP.. 1603.. TP.. 2204..</p>
<p>CTDP 45°</p>  <p>Page Seite A124</p> <p>TP.. 1103.. TP.. 1603.. TP.. 2204..</p>	<p>CTFP 90°</p>  <p>Page Seite A125</p> <p>TP.. 1103.. TP.. 1603.. TP.. 2204..</p>	<p>CTGP 90°</p>  <p>Page Seite A126</p> <p>TP.. 1103.. TP.. 1603.. TP.. 2204..</p>	<p>CTTP 60°</p>  <p>Page Seite A127</p> <p>TP.. 0902.. TP.. 1103.. TP.. 1603..</p>	

Center screw toolholders Klemmhalter mit Zentralschrauben-Klemmung

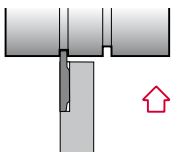
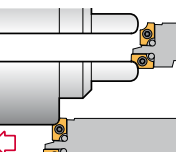
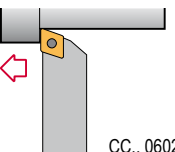
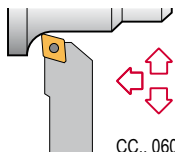
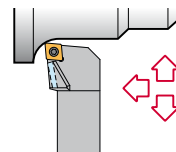
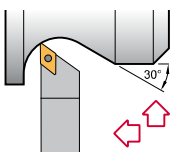
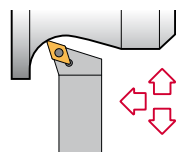
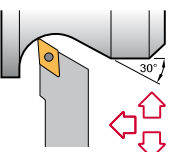
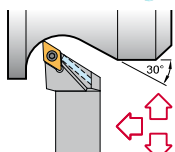
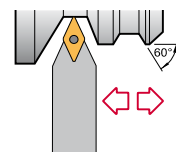
<p>STHE</p>  <p>Page Seite A128</p> <p>GI..</p>	<p>SAGD 90°</p>  <p>Page Seite A129</p> <p>ADMT.. 1503..</p>	<p>SCAC 90°</p>  <p>Page Seite A130-131</p> <p>CC.. 0602.. CC.. 09T3.. CC.. 1204..</p>	<p>SCLC 95°</p>  <p>Page Seite A132,134</p> <p>CC.. 0602.. CC.. 09T3.. CC.. 1204..</p>	<p>SCLC 95°-A</p>  <p>Page Seite A133</p> <p>CC.. 09T3..</p>
<p>SDAC 90°</p>  <p>Page Seite A135</p> <p>DC.. 0702.. DC.. 11T3..</p>	<p>SDHC 107,5°</p>  <p>Page Seite A136</p> <p>DC.. 11T3..</p>	<p>SDJC 93°</p>  <p>Page Seite A137,139</p> <p>DC.. 0702.. DC.. 11T3..</p>	<p>SDJC 93°-A</p>  <p>Page Seite A138</p> <p>DC.. 11T3..</p>	<p>SDNC 62° 30'</p>  <p>Page Seite A140-141</p> <p>DC.. 0702.. DC.. 11T3..</p>



POSITIVE TOOLHOLDERS / POSITIVE KLEMMHALTER

Center screw toolholders Klemmhalter mit Zentralschrauben-Klemmung

<p>SRDC</p> <p>RC.. 0602.. Page .. Seite A142 RC.. 1204..</p>	<p>SSBC 75°</p> <p>Page .. Seite A143 SC.. 09T3.. SC.. 1204..</p>	<p>SSDC 45°</p> <p>Page .. Seite A144 SC.. 09T3.. SC.. 1204..</p>	<p>SSSC 45°</p> <p>Page .. Seite A145 SC.. 09T3.. SC.. 1204..</p>	<p>STAC 90°</p> <p>TC.. 0902.. Page .. Seite A146 TC.. 1102.. TC.. 16T3..</p>
<p>STDC 45°</p> <p>TC.. 0902.. Page .. Seite A147 TC.. 1102.. TC.. 16T3..</p>	<p>STFC 90°</p> <p>TC.. 0902.. Page .. Seite A148 TC.. 1102.. TC.. 16T3..</p>	<p>STGC 90°</p> <p>Page .. Seite A149 TC.. 0902.. TC.. 1102.. TC.. 16T3..</p>	<p>STJC 93°</p> <p>Page .. Seite A150-151 TC.. 0902.. TC.. 1102.. TC.. 16T3..</p>	<p>STTC 60°</p> <p>Page .. Seite A152 TC.. 0902.. TC.. 1102.. TC.. 16T3..</p>
<p>STXC 10°-80°</p> <p>Page .. Seite A153 ADMT 1503.. TCMT 16T3..</p>	<p>SVAC 90°</p> <p>Page .. Seite A154 VC.. 1103.. VC.. 1604..</p>	<p>SVHC 107°30'</p> <p>Page .. Seite A155 VC.. 1604.. VC.. 2205..</p>	<p>SVJB 93°</p> <p>Page .. Seite A156 VBMT 1604..</p>	<p>SVJC 93°</p> <p>Page .. Seite A157,159 VC.. 1103.. VC.. 1604..</p>
<p>SVJC 93°-A</p> <p>Page .. Seite A158 VC.. 1103.. VC.. 1604..</p>	<p>SVLC 95°</p> <p>Page .. Seite A160 VCMT 1303..</p>	<p>SVVB 72°30'</p> <p>Page .. Seite A161 VBMT 1604..</p>	<p>SVVC 72°30'</p> <p>Page .. Seite A162-163 VC.. 1103.. VC.. 1604..</p>	<p>SVXC 113°</p> <p>Page .. Seite A164 VCMT 1303..</p>
<p>SVZC 100°</p> <p>Page .. Seite A165 VC.. 1604..</p>				



Characteristics:

Multipurpose toolholder equipped with rhombic negative double-sided insert (angle 80°).
For low powered machines and small pieces choose toolholder Ref. SCLC (Page: A132).

Axial -6,5°
Radial -6,5°

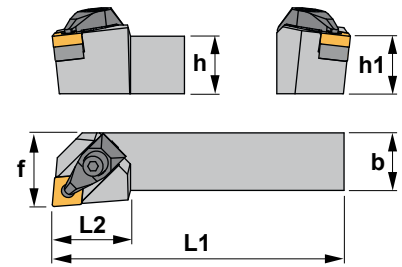

Eigenschaften:

Multifunktions-Werkzeuge mit doppelseitigen rhombischen negativen Wendeschneidplatten (Winkel 80°).
Für Niederleistungsmaschinen und kleine Werkstücke, wählen Sie Klemmhalter SCLC (Seite: A132).

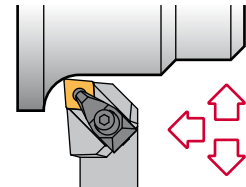

DCLN 95°-N

Reference Bezeichnung	h=h1	b	L1	L2	f	Insert size Wendeschneidplatte	kg
DCLN R/L 2020 K12-N	20	20	125	34	25	CN.. 1204..	0,400
DCLN R/L 2525 M12-N	25	25	150	34	32	CN.. 1204..	0,750
DCLN R/L 3232 P12-N	32	32	170	34	40	CN.. 1204..	1,300
DCLN R/L 3232 P19-N	32	32	170	42	40	CN.. 1906..	1,300
DCLN R/L 4040 S19-N	40	40	250	45	50	CN.. 1906..	3,050

Reference Bezeichnung							Nm
DCLN R/L 2020 K12-N	ICSN-442	1766	2712	1696	4295	5004	3.5
DCLN R/L 2525 M12-N	ICSN-442	1766	2712	1696	4295	5004	3.5
DCLN R/L 3232 P12-N	ICSN-442	1766	2712	1696	4295	5004	3.5
DCLN R/L 3232 P19-N	ICSN-633	1770	2719	1696	4295	5004	3.5
DCLN R/L 4040 S19-N	ICSN-633	1770	2719	1696	4295	5004	3.5

CN..

80° rhombic negative inserts.
80° rhombische negative WSP. A32-34

Reference / Bez.	l	s	d
CN.. 1204..	12,90	4,76	12,70
CN.. 1906..	19,30	6,35	19,05

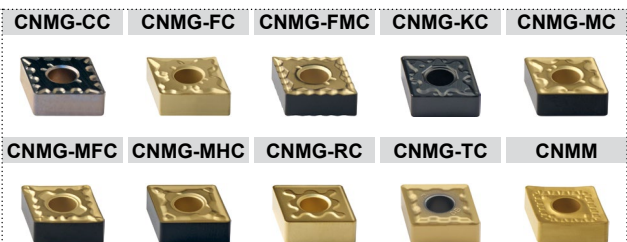
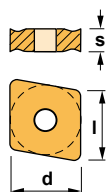

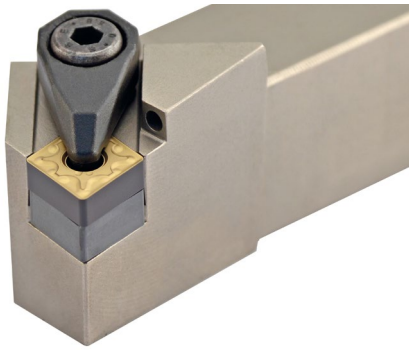

Characteristics:

Multipurpose toolholder equipped with rhombic negative double-sided insert (angle 80°).
For low powered machines and small pieces choose toolholder Ref. SCLC-A (Page: A133).

Axial -6,5°
Radial -6,5°

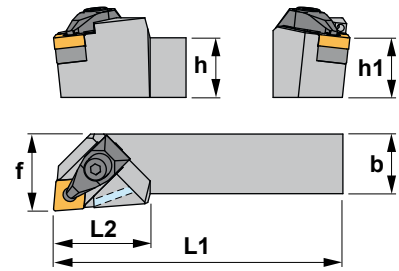

Eigenschaften:

Multifunktions-Werkzeuge mit doppelseitigen rhombischen negativen Wendeschneiplatten (Winkel 80°).
Für Niederleistungsmaschinen und kleine Werkstücke, wählen Sie Klemmhalter SCLC-A (Seite: A133).

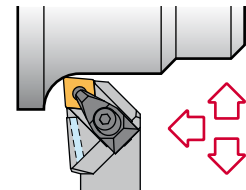

DCLN 95°-A

Reference Bezeichnung	h=h1	b	L1	L2	f	Insert size Wendeschneidplatte	
DCLN R/L 2020 K12-A	20	20	125	34	25	CN.. 1204..	0,400
DCLN R/L 2525 M12-A	25	25	150	34	32	CN.. 1204..	0,750
DCLN R/L 3232 P12-A	32	32	170	34	40	CN.. 1204..	1,300
DCLN R/L 3232 P16-A	32	32	170	42	40	CN.. 1606..	1,250

Reference Bezeichnung							Nm
DCLN R/L 2020 K12-A	ICSN-442	1766	2712	1696	4295	5004	3.5
DCLN R/L 2525 M12-A	ICSN-442	1766	2712	1696	4295	5004	3.5
DCLN R/L 3232 P12-A	ICSN-442	1766	2712	1696	4295	5004	3.5
DCLN R/L 3232 P16-A	ICSN-533	1768	2716	1696	4295	5004	3.5

CN..

80° rhombic negative inserts. A32-34
80° rhombische negative WSP.

Reference / Bez.	l	s	d
CN.. 1204..	12,90	4,76	12,70
CN.. 1606..	16,10	6,35	15,88

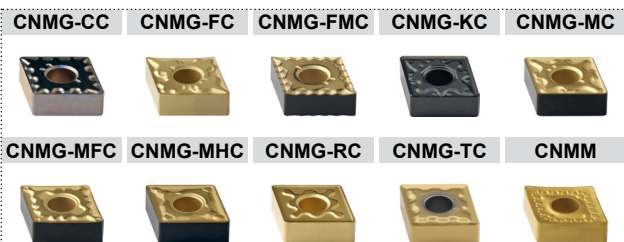
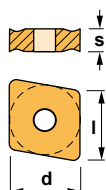



Characteristics:

Turning and profiling toolholder equipped with rhombic negative double-sided insert (angle 55°).

For low powered machines and small pieces choose toolholder Ref. SDJC (Page: A137).

Axial 6,25°
Radial -6,75°

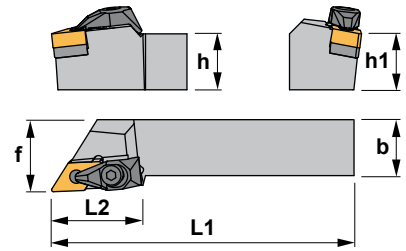

Eigenschaften:

Klemmhalter zum Drehen und Kopierdrehen mit doppelseitigen rhombischen negativen Wendeschneiplatten (Winkel 55°).

Für Niederleistungsmaschinen und kleine Werkstücke, wählen Sie Klemmhalter SDJC (Seite: A137).

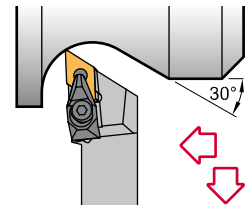

DDJN 93°-N

Reference Bezeichnung	h=h1	b	L1	L2	f	Insert size Wendeschneidplatte	KG
DDJN R/L 2020 K11-N	20	20	125	34	25	DN.. 1104..	0,400
DDJN R/L 2020 K15-N	20	20	125	42	25	DN.. 1506..	0,400
DDJN R/L 2525 M15-N	25	25	150	42	32	DN.. 1506..	0,750
DDJN R/L 3232 P15-N	32	32	170	42	40	DN.. 1506..	1,300

Reference Bezeichnung							Nm
DDJN R/L 2020 K11-N	IDSN-322	1764	2708	1695	4294	5004	3.5
DDJN R/L 2020 K15-N	IDSN-432	1766	2712	1696	4295	5004	3.5
DDJN R/L 2525 M15-N	IDSN-432	1766	2712	1696	4295	5004	3.5
DDJN R/L 3232 P15-N	IDSN-432	1766	2712	1696	4295	5004	3.5

DN.. 55° rhombic negative inserts. A36-37
55° rhombische negative Wendeschneidplatten.

Reference / Bez.	l	s	d
DN.. 1104..	11,60	4,76	9,52
DN.. 1506..	15,50	6,35	12,70

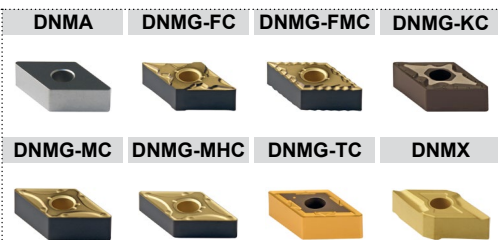
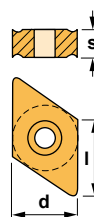

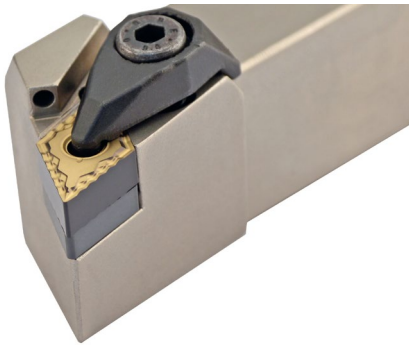

Characteristics:

Turning and profiling toolholder equipped with rhombic negative double-sided insert (angle 55°).

For low powered machines and small pieces choose toolholder Ref. SDJC-A (Page: A138).

Axial 6,25°
Radial -6,75°

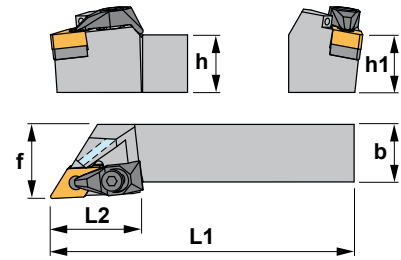

Eigenschaften:

Klemmhalter zum Drehen und Kopierdrehen mit doppelseitigen rhombischen negativen Wendeschneiplatten (Winkel 55°).

Für Niederleistungsmaschinen und kleine Werkstücke, wählen Sie Klemmhalter SDJC-A (Seite: A138).

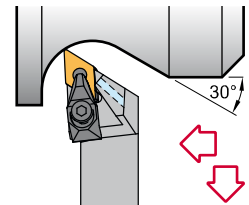

DDJN 93°-A

Reference Bezeichnung	h=h1	b	L1	L2	f	Insert size Wendeschneidplatte	KG
DDJN R/L 2020 K11-A	20	20	125	34	25	DN.. 1104..	0,400
DDJN R/L 2020 K15-A	20	20	125	42	25	DN.. 1506..	0,400
DDJN R/L 2525 M15-A	25	25	150	42	32	DN.. 1506..	0,750
DDJN R/L 3232 P15-A	32	32	170	42	40	DN.. 1506..	1,300

Reference Bezeichnung							Nm
DDJN R/L 2020 K11-A	IDSN-322	1764	2708	1695	4294	5004	3.5
DDJN R/L 2020 K15-A	IDSN-432	1766	2712	1696	4295	5004	3.5
DDJN R/L 2525 M15-A	IDSN-432	1766	2712	1696	4295	5004	3.5
DDJN R/L 3232 P15-A	IDSN-432	1766	2712	1696	4295	5004	3.5

DN.. 55° rhombic negative inserts. A36-37
55° rhombische negative Wendeschneidplatten.

Reference / Bez.	l	s	d
DN.. 1104..	11,60	4,76	9,52
DN.. 1506..	15,50	6,35	12,70

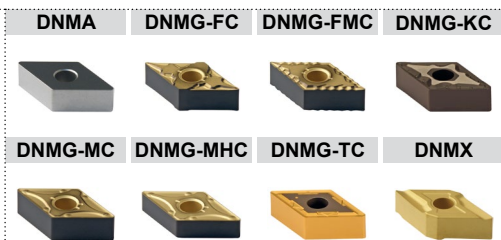
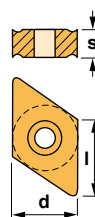

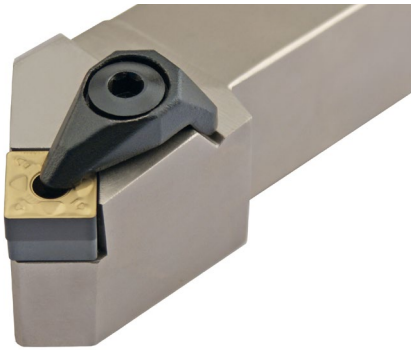

Characteristics:

Toolholder for external turning and chamfering applications equipped with square negative inserts.

For low powered machines and small pieces choose toolholder Ref. CSSP (Page: A119) or SSSC (Page: A145).

Axial -5,75°
Radial -5,75°

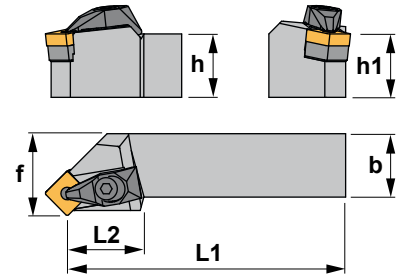

Eigenschaften:

Klemmhalter zum Außendrehen und Abschrägen mit vierkantigen negativen Wendeschneidplatten.

Für Niederleistungsmaschinen und kleine Werkstücke, wählen Sie Klemmhalter CSSP (Seite: A119) oder SSSC (Seite: A145).

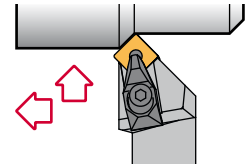

DSSN 45°-N

Reference Bezeichnung	h=h1	b	L1	L2	f	Insert size Wendeschneidplatte	kg
DSSNR/L2020K12-N	20	20	125	28	25	SNM.. 1204..	0,400
DSSNR/L2525M12-N	25	25	150	28	32	SNM.. 1204..	0,750
DSSNR/L3232P19-N	32	32	170	45	40	SNM.. 1906..	1,300

Reference Bezeichnung							Nm
DSSNR/L2020K12-N	ISSN-442	1766	2712	1696	4295	5004	3.5
DSSNR/L2525M12-N	ISSN-442	1766	2712	1696	4295	5004	3.5
DSSNR/L3232P19-N	ISSN-633	1770	2719	1696	4295	5004	3.5

SNM..

Square negative inserts. A41-42
Vierkantige negative Wendeschneidplatten.

Reference / Bez.	l	s	d
SNM.. 1204..	12,70	4,76	12,70
SNM.. 1906..	19,05	6,35	19,05

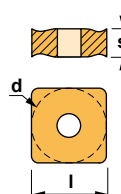

SNMG-FMC



SNMG-KC



SNMG-MHC



SNMG-RC



SNMG-TC



SNMM



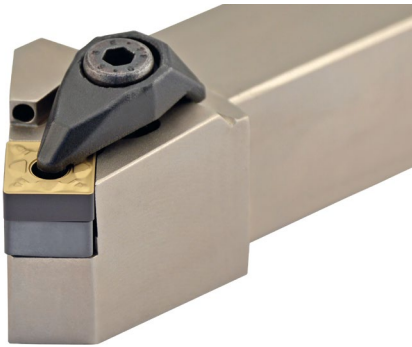

Characteristics:

Toolholder for external turning and chamfering applications equipped with square negative inserts.

For low powered machines and small pieces choose toolholder Ref. CSSP (Page: A119) or SSSC (Page: A145).

Axial -5,75°
Radial -5,75°

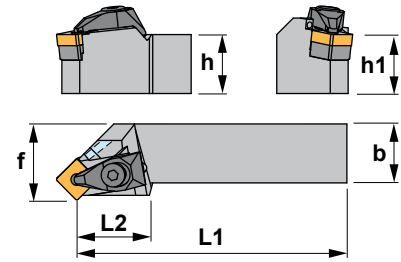

Eigenschaften:

Klemmhalter zum Außendrehen und Abschrägen mit vierkantigen negativen Wendeschneidplatten.

Für Niederleistungsmaschinen und kleine Werkstücke, wählen Sie Klemmhalter CSSP (Seite: A119) oder SSSC (Seite: A145).

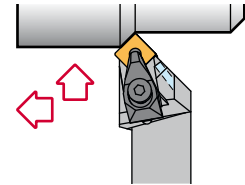

DSSN 45°-A

Reference Bezeichnung	h=h1	b	L1	L2	f	Insert size Wendeschneidplatte	
DSSN R/L 2020 K12-A	20	20	125	28	25	SNM.. 1204..	0,400
DSSN R/L 2525 M12-A	25	25	150	28	32	SNM.. 1204..	0,750
DSSN R/L 3232 P19-A	32	32	170	38	40	SNM.. 1906..	1,300

Reference Bezeichnung							Nm
DSSN R/L 2020 K12-A	ISSN-442	1766	2712	1696	4295	5004	3.5
DSSN R/L 2525 M12-A	ISSN-442	1766	2712	1696	4295	5004	3.5
DSSN R/L 3232 P19-A	ISSN-633	1770	2719	1696	4295	5004	3.5

SNM.. <small>Square negative inserts. Vierkantige negative Wendeschneidplatten. A41-42</small>												
Reference / Bez.	l	s	d									
SNM.. 1204..	12,70	4,76	12,70			<table border="1"> <tr> <td></td> <td></td> <td></td> </tr> <tr> <td></td> <td></td> <td></td> </tr> </table>						
SNM.. 1906..	19,05	6,35	19,05									

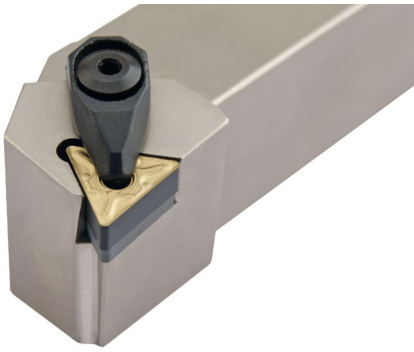

Characteristics:

Toolholder for external turning applications equipped with triangular negative inserts. For low powered machines and small pieces choose toolholder Ref. CTGP (Page: A126) or STGC (Page: A149).

Axial -6°
Radial -6°

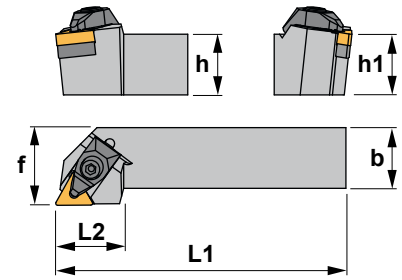

Eigenschaften:

Klemmhalter zum Außendrehen mit dreikantigen negativen Wendschneidplatten. Für Niederleistungsmaschinen und kleine Werkstücke, wählen Sie Klemmhalter CTGP (Seite: A126) oder STGC (Seite: A149).

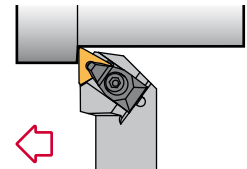

DTGN 90°-N

Reference Bezeichnung	h=h1	b	L1	L2	f	Insert size Wendschneidplatte	Kg
DTGN R/L 2020 K16-N	20	20	125	28	25	TNM.. 1604..	0,400
DTGN R/L 2525 M16-N	25	25	150	28	32	TNM.. 1604..	0,750
DTGN R/L 2525 M22-N	25	25	150	34	32	TNM.. 2204..	0,750
DTGN R/L 3232 P22-N	32	32	170	34	40	TNM.. 2204..	1,300

Reference Bezeichnung							Nm
DTGN R/L 2020 K16-N	ITSN-342	1764	2708	1695	4294	5004	3.5
DTGN R/L 2525 M16-N	ITSN-342	1764	2708	1695	4294	5004	3.5
DTGN R/L 2525 M22-N	ITSN-443	1766	2712	1696	4295	5004	3.5
DTGN R/L 3232 P22-N	ITSN-443	1766	2712	1696	4295	5004	3.5

TNM..

Triangular negative inserts.
Dreikantige negative WSP. A45-46

Reference / Bez.	l	s	d
TNM.. 1604..	16,50	4,76	9,52
TNM.. 2204..	22,00	4,76	12,70

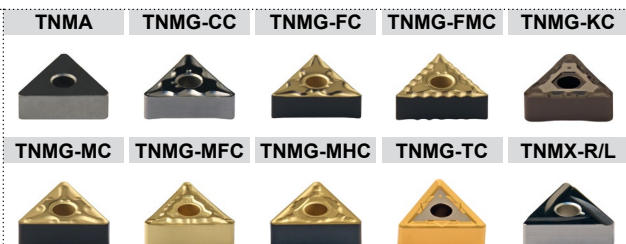
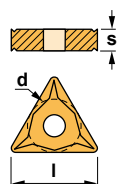

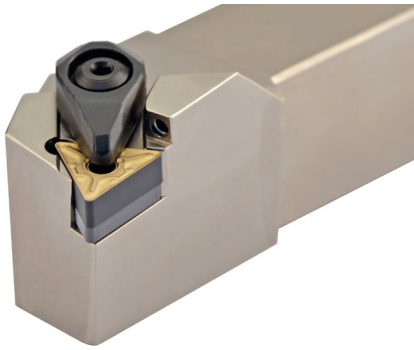

Characteristics:

Multipurpose toolholder equipped with triangular negative double-sided inserts (angle 60°).

For specific applications, roughing, semi-finishing and finishing.

Axial -6°
Radial -6°

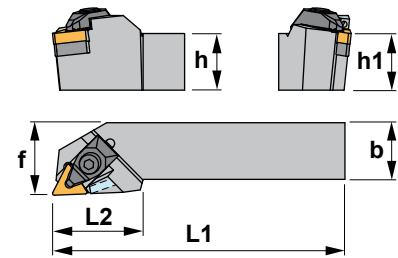

Eigenschaften:

Multifunktions-Klemmhalter mit doppelseitigen negativen dreieckigen Wendschneidplatten (Winkel 60°).

Für spezifische Anwendungen, Schruppen, Vorschlichten und Schlichten.

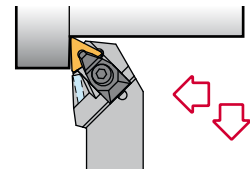

DTJN 93°-A

Reference Bezeichnung	h=h1	b	L1	L2	f	Insert size Wendschneidplatte	Kg
DTJN R/L 2020 K16-A	20	20	125	32	25	TNM.. 1604..	0,400
DTJN R/L 2525 M16-A	25	25	150	32	32	TNM.. 1604..	0,700

Reference Bezeichnung							Nm
DTJN R/L 2020 K16-A	ITSN-342	1764	2708	1695	4294	5004	3.5
DTJN R/L 2525 M16-A	ITSN-342	1764	2708	1695	4294	5004	3.5

TNM..				Triangular negative inserts. Dreieckige negative WSP. A45-46	
Reference / Bez.	l	s	d		
TNM.. 1604..	16,50	4,76	9,52		

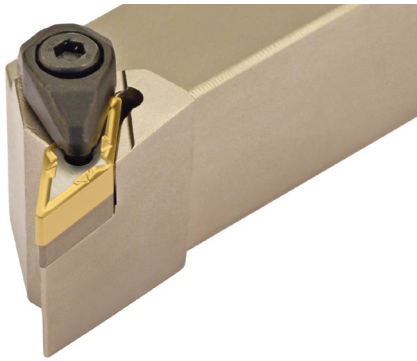

Characteristics: Toolholder for very specific operations equipped with rhombic negative inserts (angle 35°).

For low powered or poor rigid machines and small pieces, it is recommended to choose toolholder Ref. SVJC (Page: A157).

Axial -13°
Radial -4°

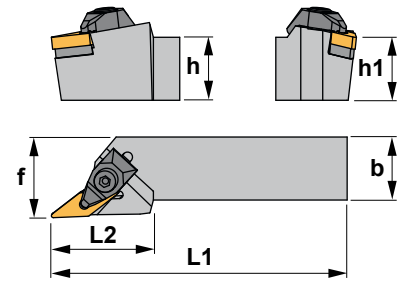

Eigenschaften:

Klemmhalter für sehr spezifische Anwendungen, bestückt mit rhombischen negativen Wendeschneidplatten (Winkel 35°). Für nicht stabile Maschinen, Maschinen mit einer niedrigen Leistung und für kleine Werkstücke empfehlen wir den Klemmhalter SVJC (Seite: A157).

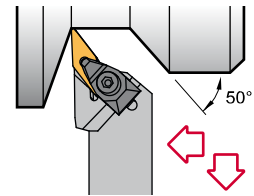

DVJN 93°-N

Reference Bezeichnung	h=h1	b	L1	L2	f	Insert size Wendeschneidplatte	Kg
DVJN R/L 2020 K16-N	20	20	125	44	25	VN.. 1604..	0,400
DVJN R/L 2525 M16-N	25	25	150	44	32	VN.. 1604..	0,700
DVJN R/L 3232 P16-N	32	32	170	44	40	VN.. 1604..	1,250

Reference Bezeichnung							Nm
DVJN R/L 2020 K16-N	IVSN-322	1764	2708	1695	4294	5004	3.5
DVJN R/L 2525 M16-N	IVSN-322	1764	2708	1695	4294	5004	3.5
DVJN R/L 3232 P16-N	IVSN-322	1764	2708	1695	4294	5004	3.5

VN..

35° rhombic negative inserts. A49
35° rhombische negative Wendeschneidplatten.

Reference / Bez.	l	s	d
VN.. 1604..	16,50	4,76	9,52

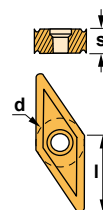

VNGP



VNMG



VNMG-TC



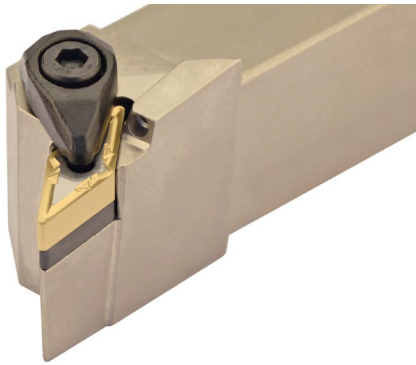

Characteristics: Toolholder for very specific operations equipped with rhombic negative inserts (angle 35°).

For low powered or poor rigid machines and small pieces, it is recommended to choose toolholder Ref. SVJC-A (Page: A158).

Axial -13°
Radial -4°

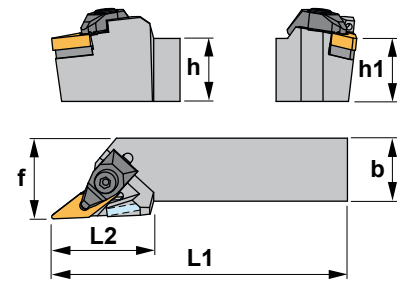

Eigenschaften:

Klemmhalter für sehr spezifische Anwendungen, bestückt mit rhombischen negativen Wendeschneidplatten (Winkel 35°). Für nicht stabile Maschinen, Maschinen mit einer niedrigen Leistung und für kleine Werkstücke empfehlen wir den Klemmhalter SVJC-A (Seite: A158).

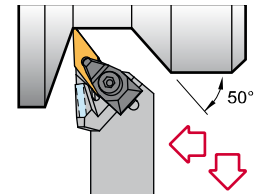

DVJN 93°-A

Reference Bezeichnung	h=h1	b	L1	L2	f	Insert size Wendeschneidplatte	Kg
DVJN R/L 2020 K16-A	20	20	125	44	25	VN.. 1604..	0,400
DVJN R/L 2525 M16-A	25	25	150	44	32	VN.. 1604..	0,700
DVJN R/L 3232 P16-A	32	32	170	44	40	VN.. 1604..	1,250

Reference Bezeichnung							Nm
DVJN R/L 2020 K16-A	IVSN-322	1764	2708	1695	4294	5004	3.5
DVJN R/L 2525 M16-A	IVSN-322	1764	2708	1695	4294	5004	3.5
DVJN R/L 3232 P16-A	IVSN-322	1764	2708	1695	4294	5004	3.5

VN..

35° rhombic negative inserts. A49
35° rhombische negative Wendeschneidplatten.

Reference / Bez.	l	s	d
VN.. 1604..	16,50	4,76	9,52

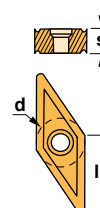

VNGP



VNMG



VNMG-TC





Characteristics:

Multipurpose toolholder equipped with trigon negative double-sided insert (angle 80°).

For top clamp toolholder see Ref. MWLN (Page: A92) or MWLN-K (Page: A93).

Axial -6°
Radial -6°

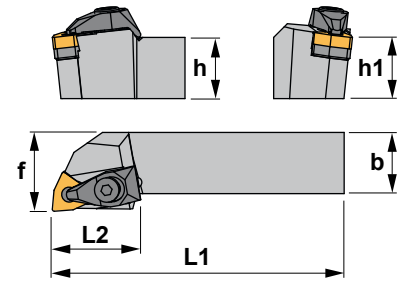

Eigenschaften:

Multifunktions-Klemmhalter mit doppelseitigen Trigon negativen Wendeschneidplatten (Winkel 80°).

Für Klemmhalter mit oberer Klemmung siehe MWLN (Seite: A92) oder MWLN-K (Seite: A93).

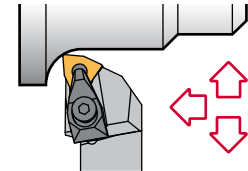

DWLN 95°-N

Reference Bezeichnung	h=h1	b	L1	L2	f	Insert size Wendeschneidplatte	
DWLN R/L 2020 K06-N	20	20	125	34	25	WNMG 0604..	0,400
DWLN R/L 2525 M06-N	25	25	150	34	25	WNMG 0604..	0,700
DWLN R/L 2020 K08-N	20	20	125	34	25	WNMG 0804..	0,400
DWLN R/L 2525 M08-N	25	25	150	34	32	WNMG 0804..	0,750
DWLN R/L 3232 P08-N	32	32	170	34	40	WNMG 0804..	1,300

Reference Bezeichnung							Nm
DWLN R/L 2020 K06-N	IWSN-322	1764	2708	1695	4294	5004	3.5
DWLN R/L 2525 M06-N	IWSN-322	1764	2708	1695	4294	5004	3.5
DWLN R/L 2020 K08-N	IWSN-433	1766	2712	1696	4295	5004	3.5
DWLN R/L 2525 M08-N	IWSN-433	1766	2712	1696	4295	5004	3.5
DWLN R/L 3232 P08-N	IWSN-433	1766	2712	1696	4295	5004	3.5

WNMG

80° trigon negative inserts.
80° trigon negative Wendeschneidplatten. A50-51

Reference / Bez.	l	s	d
WNMG 0604..	6,45	4,76	9,52
WNMG 0804..	8,14	4,76	12,70

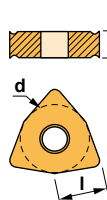

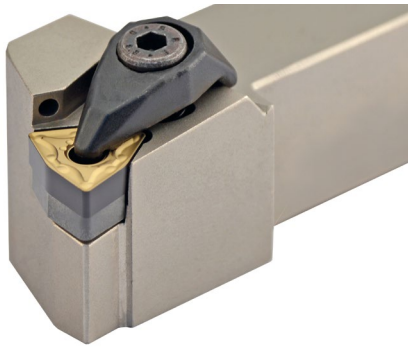

Characteristics:

Multipurpose toolholder equipped with trigon negative double-sided insert (angle 80°).

For top clamp toolholder see Ref. MWLN (Page: A92) or MWLN-K (Page: A93).

Axial -6°
Radial -6°

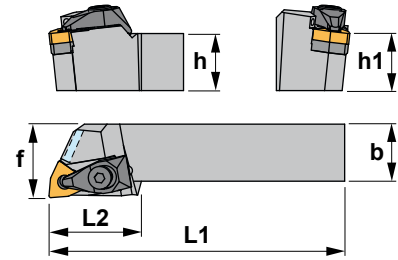

Eigenschaften:

Multifunktions-Klemmhalter mit doppelseitigen Trigon negativen Wendeschneidplatten (Winkel 80°).

Für Klemmhalter mit oberer Klemmung siehe MWLN (Seite: A92) oder MWLN-K (Seite: A93).

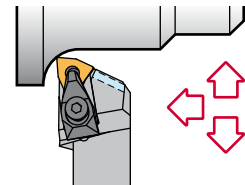

DWLN 95°-A

Reference Bezeichnung	h=h1	b	L1	L2	f	Insert size Wendeschneidplatte	kg
DWLN R/L 2020 K06-A	20	20	125	32	25	WNMG 0604..	0,400
DWLN R/L 2020 K08-A	20	20	125	32	25	WNMG 0804..	0,400
DWLN R/L 2525 M08-A	25	25	150	32	32	WNMG 0804..	0,700
DWLN R/L 3232 P08-A	32	32	170	32	38	WNMG 0804..	1,250

Reference Bezeichnung							Nm
DWLN R/L 2020 K06-A	IWSN-322	1764	2708	1695	4294	5004	3.5
DWLN R/L 2020 K08-A	IWSN-433	1766	2712	1696	4295	5004	3.5
DWLN R/L 2525 M08-A	IWSN-433	1766	2712	1696	4295	5004	3.5
DWLN R/L 3232 P08-A	IWSN-433	1766	2712	1696	4295	5004	3.5

WNMG

80° trigon negative inserts. A50-51
80° trigon negative Wendeschneidplatten.

Reference / Bez.	l	s	d
WNMG 0604..	6,45	4,76	9,52
WNMG 0804..	8,14	4,76	12,70

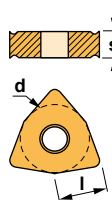



Characteristics:

Multipurpose toolholder equipped with rhombic negative double-sided insert (angle 80°).
For low powered machines and small pieces choose toolholder Ref. SCLC (Page: A132).

Axial -8°
Radial -6,5°

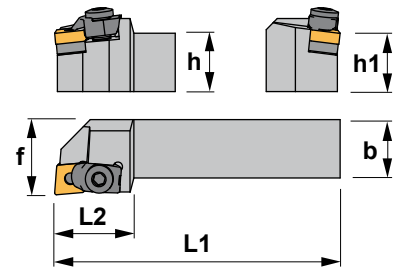

Eigenschaften:

Multifunktions-Klemmhalter mit doppelseitigen rhombischen negativen Wendeschneidplatten (Winkel 80°).
Für Niederleistungsmaschinen und kleine Werkstücke, wählen Sie Klemmhalter SCLC (Seite: A132).

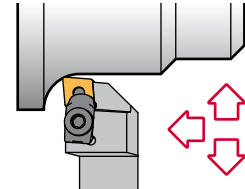

MCLN 95°

Reference Bezeichnung	h=h1	b	L1	L2	f	Insert size Wendeschneidplatte	kg
MCLN R/L 2020 K12	20	20	125	34	25	CN.. 1204..	0,450
MCLN R/L 2525 M12	25	25	150	34	32	CN.. 1204..	0,800
MCLN R/L 3225 P12	32	25	170	34	32	CN.. 1204..	1,200
MCLN R/L 2525 M19	25	25	150	42	32	CN.. 1906..	0,800
MCLN R/L 3225 P19	32	25	170	42	32	CN.. 1906..	1,200
MCLN R/L 4040 S19	40	40	250	45	50	CN.. 1906..	3,100

Reference Bezeichnung						Nm
MCLN R/L 2020 K12	2015	5005	ICSN-432	1661	1394	4.0
MCLN R/L 2525 M12	2015	5005	ICSN-432	1661	1394	4.0
MCLN R/L 3225 P12	2015	5005	ICSN-432	1661	1394	4.0
MCLN R/L 2525 M19	2024	5005	3619	1682	1296	4.0
MCLN R/L 3225 P19	2024	5005	3619	1682	1296	4.0
MCLN R/L 4040 S19	2024	5005	3619	1682	1296	4.0

CN..

80° rhombic negative inserts. A32-34
80° rhombische negative WSP.

Reference / Bez.	l	s	d
CN.. 1204..	12,90	4,76	12,70
CN.. 1906..	19,30	6,35	19,05

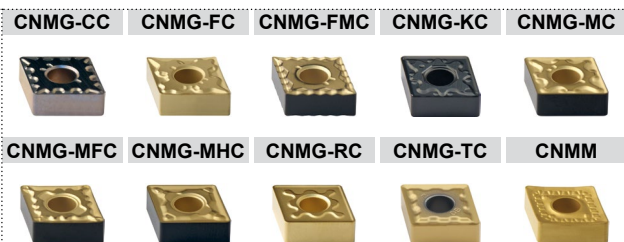
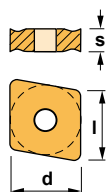

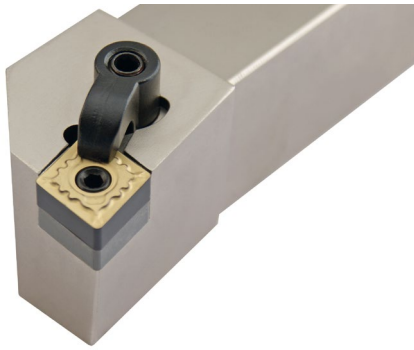

Characteristics:

Multipurpose toolholder equipped with rhombic negative double-sided insert (angle 80°).
For low powered machines and small pieces choose toolholder Ref. SCLC (Page: A132).

Axial -8°
Radial -6,25°

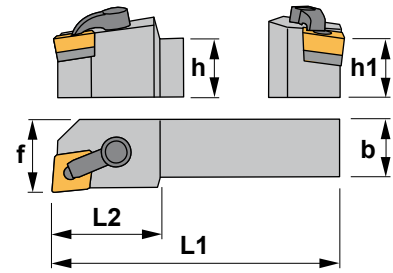

Eigenschaften:

Multifunktions-Klemmhalter mit doppelseitigen rhombischen negativen Wendeschneidplatten (Winkel 80°).
Für Niederleistungsmaschinen und kleine Werkstücke, wählen Sie Klemmhalter SCLC (Seite: A132).

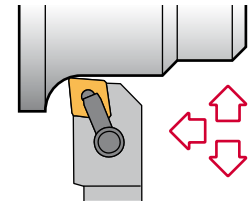

MCLN-K 95°

Reference Bezeichnung	h=h1	b	L1	L2	f	Insert size Wendeschneidplatte	Kg
MCLN R/L 2020 K12-K	20	20	125	28	25	CN.. 1204..	0,450
MCLN R/L 2525 M12-K	25	25	150	34	32	CN.. 1204..	0,800
MCLN R/L 3225 P12-K	32	25	170	34	32	CN.. 1204..	1,200
MCLN R/L 2525 M19-K	25	25	150	42	32	CN.. 1906..	0,800
MCLN R/L 3232 P19-K	32	32	170	42	40	CN.. 1906..	1,400

Reference Bezeichnung							Nm
MCLN R/L 2020 K12-K	2613	1086	5003	ICSN-432	1656	5025	3.0
MCLN R/L 2525 M12-K	2613	1086	5003	ICSN-432	1656	5025	3.0
MCLN R/L 3225 P12-K	2613	1086	5003	ICSN-432	1656	5025	3.0
MCLN R/L 2525 M19-K	2621	1098	5004	ICSN-633	1670	5004	3.5
MCLN R/L 3232 P19-K	2621	1098	5004	ICSN-633	1670	5004	3.5

CN..

80° rhombic negative inserts.
80° rhombische negative WSP. A32-34

Reference / Bez.	l	s	d
CN.. 1204..	12,90	4,76	12,70
CN.. 1906..	19,30	6,35	19,05

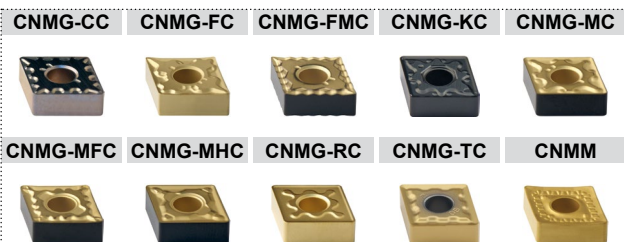
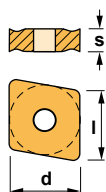



Characteristics:

Turning and profiling toolholder equipped with rhombic negative double-sided insert (angle 55°).

For low powered machines and small pieces choose toolholder Ref. SDJC (Page: A137).

Axial -6°
Radial -7°

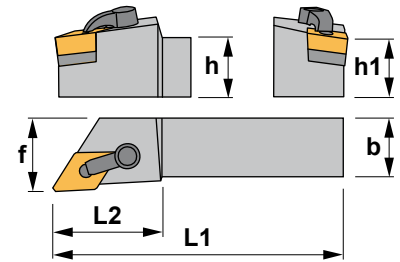

Eigenschaften:

Klemmhalter zum Drehen und Profildrehen mit doppelseitigen rhombischen negativen Wendeschneidplatten (Winkel 55°).

Für Niederleistungsmaschinen und kleine Werkstücke wählen Sie Klemmhalter SDJC (Seite: A137).

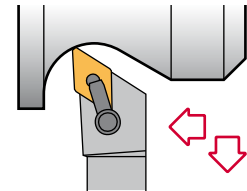

MDJN-K 93°

Reference Bezeichnung	h=h1	b	L1	L2	f	Insert size Wendeschneidplatte	Kg
MDJN R/L 2020 K15-K	20	20	125	42	25	DN.. 1506..	0,450
MDJN R/L 2525 M15-K	25	25	150	42	32	DN.. 1506..	0,800
MDJN R/L 3225 P15-K	32	25	170	42	32	DN.. 1506..	1,200

Reference Bezeichnung						Nm
MDJN R/L 2020 K15-K	2614	1086	5003	IDSN-432	1666 5025	3.0
MDJN R/L 2525 M15-K	2614	1086	5003	IDSN-432	1666 5025	3.0
MDJN R/L 3225 P15-K	2614	1086	5003	IDSN-432	1666 5025	3.0

DN.. 55° rhombic negative inserts. A36-37
55° rhombische negative Wendeschneidplatten.

Reference / Bez.	l	s	d
DN.. 1506..	15,50	6,35	12,70

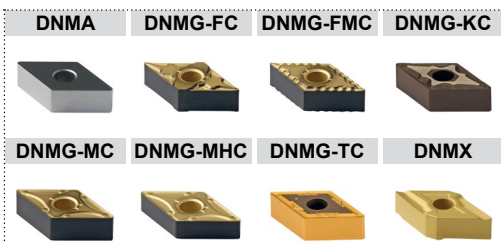
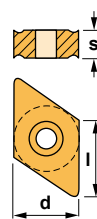

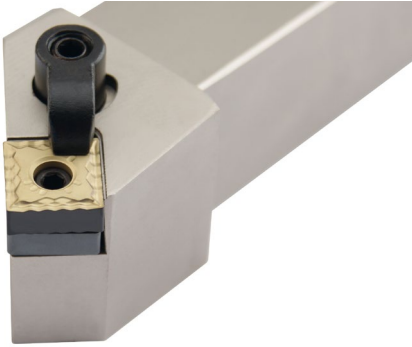

Characteristics: Toolholder for external turning and chamfering applications equipped with square negative inserts.
For low powered machines and small pieces choose toolholder Ref. CSSP (Page: A119) or SSSC (Page: A145).

Axial -6°
Radial -6°

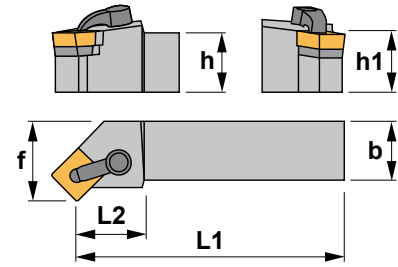

Eigenschaften:

Klemmhalter zum Außendrehen und Abschrägen mit vierkantigen Wendeschneidplatten.

Für Niederleistungsmaschinen und kleine Werkstücke, wählen Sie Klemmhalter CSSP (Seite: A119) oder SSSC (Seite: A145).

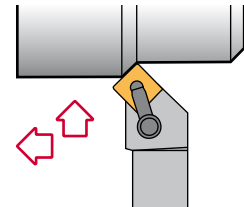

MSSN-K 45°

Reference Bezeichnung	h=h1	b	L1	L2	f	Insert size Wendeschneidplatte	kg
MSSN R/L 2020 K12-K	20	20	125	28	27	SNM.. 1204..	0,450
MSSN R/L 2525 M12-K	25	25	150	28	32	SNM.. 1204..	0,800

Reference Bezeichnung						Nm
MSSN R/L 2020 K12-K	2613	1086	5003	ISSN-432	1656 5025	3.0
MSSN R/L 2525 M12-K	2613	1086	5003	ISSN-432	1656 5025	3.0

SNM.. <small>Square negative inserts. Vierkantige negative Wendeschneidplatten. A41-42</small>						
Reference / Bez.	l	s	d			
SNM.. 1204..	12,70	4,76	12,70			

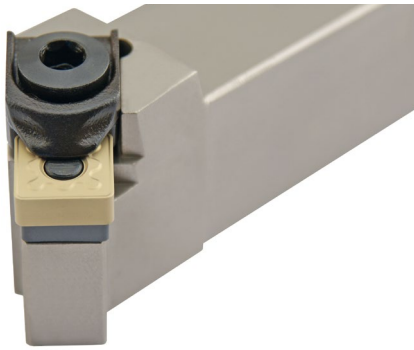

Characteristics:

Toolholder for external turning and chamfering applications equipped with square negative inserts.

For low powered machines and small pieces choose toolholder Ref. CSSP (Page: A119) or SSSC (Page: A145).

Axial -6°
Radial -6°

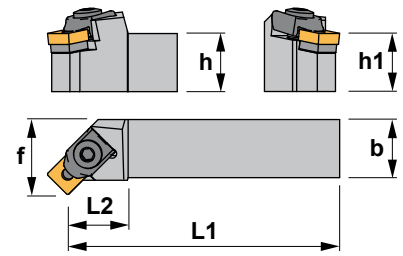

Eigenschaften:

Klemmhalter zum Außendrehen und Abschrägen mit vierkantigen negativen Wendeschneidplatten.

Für Niederleistungsmaschinen und kleine Werkstücke, wählen Sie Klemmhalter CSSP (Seite: A119) oder SSSC (Seite: A145).

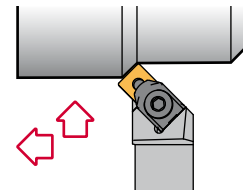

MSSN 45°

Reference Bezeichnung	h=h1	b	L1	L2	f	Insert size Wendeschneidplatte	
MSSN R/L 2020 K12	20	20	125	34	27	SNM.. 1204..	0,450
MSSN R/L 2525 M12	25	25	150	34	32	SNM.. 1204..	0,800
MSSN R/L 3225 P12	32	25	170	34	32	SNM.. 1204..	1,200
MSSN R/L 2525 M19	25	25	150	42	32	SNM.. 1906..	0,800
MSSN R/L 3225 P19	32	25	170	42	32	SNM.. 1906..	1,200
MSSN R/L 3232 P19	32	32	170	42	40	SNM.. 1906..	1,400
MSSN R/L 4040 S19	40	40	250	42	50	SNM.. 1906..	3,100

Reference Bezeichnung						Nm
MSSN R/L 2020 K12	2014	5005	3514	1661	1394	4.0
MSSN R/L 2525 M12	2014	5005	3514	1661	1394	4.0
MSSN R/L 3225 P12	2014	5005	3514	1661	1394	4.0
MSSN R/L 2525 M19	2024	5005	3519	1682	1296	4.0
MSSN R/L 3225 P19	2024	5005	3519	1682	1296	4.0
MSSN R/L 3232 P19	2024	5005	3519	1682	1296	4.0
MSSN R/L 4040 S19	2024	5005	3519	1682	1296	4.0

SNM..

Square negative inserts. A41-42
Vierkantige negative Wendeschneidplatten.

Reference / Bez.	l	s	d
SNM.. 1204..	12,70	4,76	12,70
SNM.. 1906..	19,05	6,35	19,05

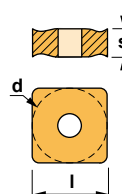

SNMG-FMC



SNMG-KC



SNMG-MHC



SNMG-RC



SNMG-TC



SNMM



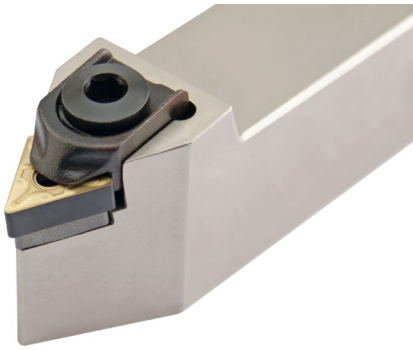

Characteristics:
Profiling toolholder equipped with triangular negative double-sided insert (angle 60°).
For general applications, roughing, semi-finishing and finishing.

Axial -8,25°
Radial -2,25°

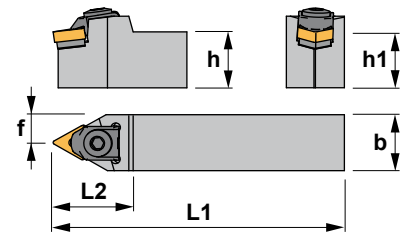

Eigenschaften:
Klemmhalter zum Profildrehen mit doppelseitigen dreikantigen negativen Wendeschneidplatten (Winkel 60°).
Für allgemeine Anwendungen, Schruppen, Vorschlichten und Schlichten.

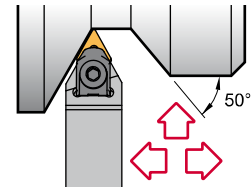

MTEN 60°

Reference Bezeichnung	h=h1	b	L1	L2	f	Insert size Wendeschneidplatte	kg
MTEN R/L/N 2020 K16	20	20	125	34	10,5	TNM.. 1604..	0,450
MTEN R/L/N 2525 M16	25	25	150	34	13,0	TNM.. 1604..	0,800
MTEN R/L/N 3225 P16	32	25	170	34	13,0	TNM.. 1604..	1,200
MTEN R/L/N 2525 M22	25	25	150	42	13,0	TNM.. 2204..	0,800
MTEN R/L/N 3225 P22	32	25	170	42	13,0	TNM.. 2204..	1,200
MTEN R/L/N 3232 P22	32	32	170	42	16,5	TNM.. 2204..	1,400
MTEN R/L/N 4025 R22	40	25	200	42	13,0	TNM.. 2204..	1,500
MTEN R/L/N 5032 S22	50	32	250	50	16,5	TNM.. 2204..	2,950

Reference Bezeichnung						Nm
MTEN R/L/N 2020 K16	2014	5005	3414	1642	1393	4.0
MTEN R/L/N 2525 M16	2014	5005	3414	1642	1393	4.0
MTEN R/L/N 3225 P16	2014	5005	3414	1642	1393	4.0
MTEN R/L/N 2525 M22	2024	5005	ITSN-433	1661	1394	4.0
MTEN R/L/N 3225 P22	2024	5005	ITSN-433	1661	1394	4.0
MTEN R/L/N 3232 P22	2024	5005	ITSN-433	1661	1394	4.0
MTEN R/L/N 4025 R22	2024	5005	ITSN-433	1661	1394	4.0
MTEN R/L/N 5032 S22	2024	5005	ITSN-433	1661	1394	4.0

TNM.. <small>Triangular negative inserts. Dreikantige negative WSP. A45-46</small>									
Reference / Bez.	l	s	d		TNMA	TNMG-CC	TNMG-FC	TNMG-FMC	TNMG-KC
TNM.. 1604..	16,50	4,76	9,52						
TNM.. 2204..	22,00	4,76	12,70						



Characteristics:

Turning and profiling toolholder equipped with triangular negative double-sided insert. For low powered machines and small pieces choose toolholder Ref. STJC (Page: A150).

Axial -6°
Radial -6°

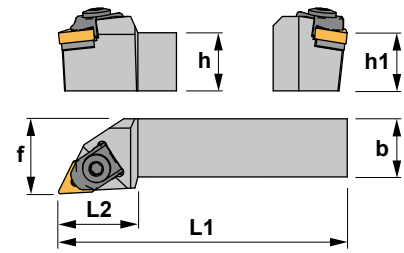

Eigenschaften:

Klemmhalter zum Drehen und Profildrehen mit doppelseitigen dreikantigen negativen Wendeschneidplatten.

Für Niederleistungsmaschinen und kleine Werkstücke, wählen Sie Klemmhalter STJC (Seite: A150).

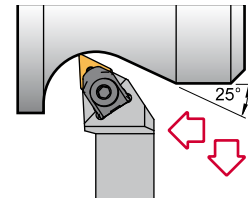

MTJN 93°

Reference Bezeichnung	h=h1	b	L1	L2	f	Insert size Wendeschneidplatte	Kg
MTJN R/L 2020 K16	20	20	125	34	25	TNM.. 1604..	0,450
MTJN R/L 2525 M16	25	25	150	34	32	TNM.. 1604..	0,800
MTJN R/L 3225 P16	32	25	170	34	32	TNM.. 1604..	1,200
MTJN R/L 2525 M22	25	25	150	38	32	TNM.. 2204..	0,800
MTJN R/L 3225 P22	32	25	170	42	32	TNM.. 2204..	1,200
MTJN R/L 3232 P22	32	32	170	42	40	TNM.. 2204..	1,400
MTJN R/L 4025 R22	40	25	200	42	32	TNM.. 2204..	1,500
MTJN R/L 5032 S22	50	32	250	42	40	TNM.. 2204..	2,950

Reference Bezeichnung						Nm
MTJN R/L 2020 K16	2014	5005	3414	1642	1393	4.0
MTJN R/L 2525 M16	2014	5005	3414	1642	1393	4.0
MTJN R/L 3225 P16	2014	5005	3414	1642	1393	4.0
MTJN R/L 2525 M22	2024	5005	ITSN-433	1661	1394	4.0
MTJN R/L 3225 P22	2024	5005	ITSN-433	1661	1394	4.0
MTJN R/L 3232 P22	2024	5005	ITSN-433	1661	1394	4.0
MTJN R/L 4025 R22	2024	5005	ITSN-433	1661	1394	4.0
MTJN R/L 5032 S22	2024	5005	ITSN-433	1661	1394	4.0

TNM..

Triangular negative inserts.
Dreikantige negative WSP. A45-46

Reference / Bez.	l	s	d
TNM.. 1604..	16,50	4,76	9,52
TNM.. 2204..	22,00	4,76	12,70

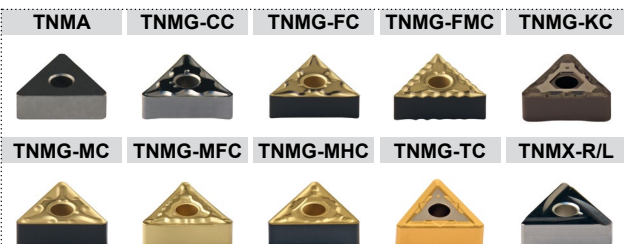
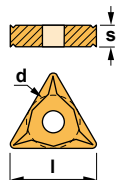

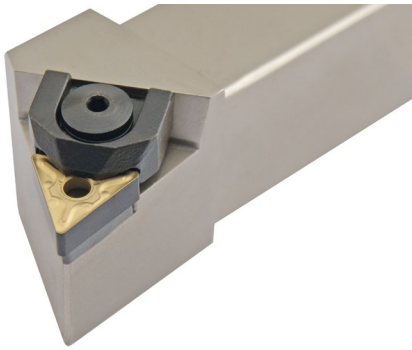

Characteristics:

Turning and profiling toolholder equipped with triangular negative double-sided insert. For low powered machines and small pieces choose toolholder Ref. STJC (Page: A150).

Axial -6°
Radial -6°

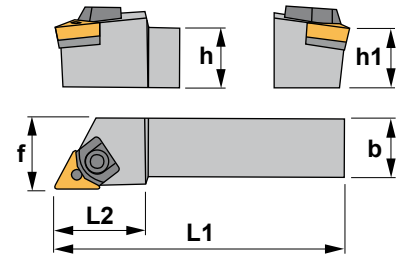

Eigenschaften:

Klemmhalter zum Drehen und Profildrehen mit doppelseitigen dreikantigen negativen Wendeschneidplatten.

Für Niederleistungsmaschinen und kleine Werkstücke, wählen Sie Klemmhalter STJC (Seite: A150).

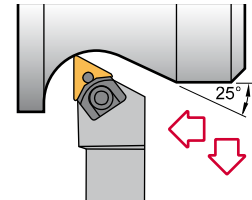

MTJN-K 93°

Reference Bezeichnung	h=h1	b	L1	L2	f	Insert size Wendeschneidplatte	Kg
MTJN R/L 2020 K16-K	20	20	125	34	25	TNM.. 1604..	0,450
MTJN R/L 2525 M16-K	25	25	150	34	32	TNM.. 1604..	0,800
MTJN R/L 2525 M22-K	25	25	150	34	32	TNM.. 2204..	0,800
MTJN R/L 3225 P22-K	32	25	170	34	32	TNM.. 2204..	1,200
MTJN R/L 3232 P22-K	32	32	170	42	40	TNM.. 2204..	1,400
MTJN R/L 4025 R22-K	40	25	200	34	32	TNM.. 2204..	1,500
MTJN R/L 5032 S22-K	50	32	250	34	40	TNM.. 2204..	2,950

Reference Bezeichnung						Nm
MTJN R/L 2020 K16-K	2017	5025	3414	1642	1393	2.0
MTJN R/L 2525 M16-K	2017	5025	3414	1642	1393	2.0
MTJN R/L 2525 M22-K	2023	5003	ITSN-433	1642	1393	3.0
MTJN R/L 3225 P22-K	2023	5003	ITSN-433	1661	1394	3.0
MTJN R/L 3232 P22-K	2023	5003	ITSN-433	1661	1394	3.0
MTJN R/L 4025 R22-K	2023	5003	ITSN-433	1661	1394	3.0
MTJN R/L 5032 S22-K	2023	5003	ITSN-433	1661	1394	3.0

TNM..				Triangular negative inserts. Dreikantige negative WSP. A45-46					
Reference / Bez.	l	s	d		TNMA	TNMG-CC	TNMG-FC	TNMG-FMC	TNMG-KC
TNM.. 1604..	16,50	4,76	9,52						
TNM.. 2204..	22,00	4,76	12,70						



Characteristics:

Profiling toolholder equipped with triangular negative double-sided insert (angle 60°).

For general applications, roughing, semi-finishing and finishing.

Axial -8°
Radial -2,5°

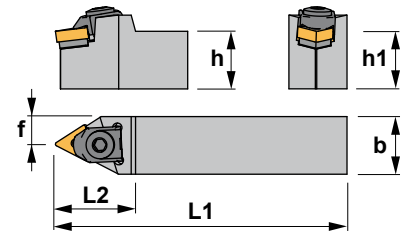

Eigenschaften:

Klemmhalter zum Profildrehen mit doppelseitigen dreikantigen Wendeschneidplatten (Winkel 60°). Für allgemeine Anwendungen, Schruppen, Vorschlichten und Schlichten.

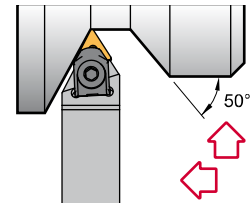

MTNN 63°

Reference Bezeichnung	h=h1	b	L1	L2	f	Insert size Wendeschneidplatte	Kg
MTNN R/L 2020 K16	20	20	125	34	10,0	TNM.. 1604..	0,450
MTNN R/L 2525 M16	25	25	150	34	12,5	TNM.. 1604..	0,800
MTNN R/L 3225 P16	32	25	170	34	12,5	TNM.. 1604..	1,200
MTNN R/L 2525 M22	25	25	150	42	12,5	TNM.. 2204..	0,800
MTNN R/L 3225 P22	32	25	170	42	12,5	TNM.. 2204..	1,200
MTNN R/L 3232 P22	32	32	170	42	16,0	TNM.. 2204..	1,400
MTNN R/L 4025 R22	40	25	200	42	12,5	TNM.. 2204..	1,500
MTNN R/L 5032 S22	50	32	250	50	16,0	TNM.. 2204..	2,950

Reference Bezeichnung						Nm
MTNN R/L 2020 K16	2014	5005	3414	1642	1393	4.0
MTNN R/L 2525 M16	2014	5005	3414	1642	1393	4.0
MTNN R/L 3225 P16	2014	5005	3414	1642	1393	4.0
MTNN R/L 2525 M22	2024	5005	ITSN-433	1661	1394	4.0
MTNN R/L 3225 P22	2024	5005	ITSN-433	1661	1394	4.0
MTNN R/L 3232 P22	2024	5005	ITSN-433	1661	1394	4.0
MTNN R/L 4025 R22	2024	5005	ITSN-433	1661	1394	4.0
MTNN R/L 5032 S22	2024	5005	ITSN-433	1661	1394	4.0

TNM..

Triangular negative inserts.
Dreikantige negative WSP. A45-46

Reference / Bez.	l	s	d
TNM.. 1604..	16,50	4,76	9,52
TNM.. 2204..	22,00	4,76	12,70

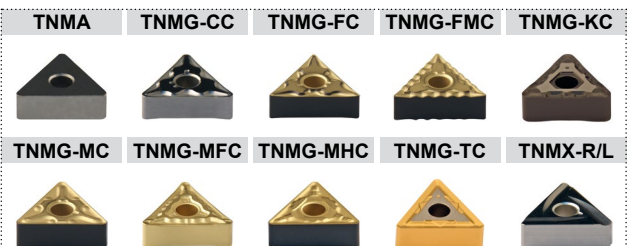
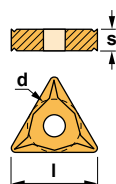



Characteristics:

External turning and profiling toolholder equipped with rhombic negative double-sided insert (angle 35°).

For low powered machines and small pieces choose toolholder Ref. SVJC (Page: A157).

Axial -6°
Radial -6°

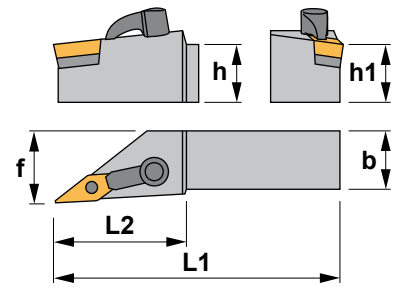

Eigenschaften:

Klemmhalter zum Außendrehe und Profildrehen mit doppelseitigen rhombischen negativen Wendeschneidplatten (Winkel 35°).

Für Niederleistungsmaschinen und kleine Werkstücke, wählen Sie Klemmhalter SVJC (Seite: A157).

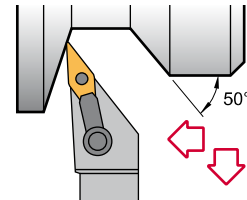

MVJN-K 93°

Reference Bezeichnung	h=h1	b	L1	L2	f	Insert size Wendeschneidplatte	kg
MVJN R/L 2020 K16-K	20	20	125	42	25	VN.. 1604..	0,450
MVJN R/L 2525 M16-K	25	25	150	42	32	VN.. 1604..	0,800
MVJN R/L 3225 P16-K	32	25	170	42	32	VN.. 1604..	1,200

Reference Bezeichnung							Nm
MVJN R/L 2020 K16-K	2616	1086	5003	IVSN-322	1665	5002	3.0
MVJN R/L 2525 M16-K	2616	1086	5003	IVSN-322	1665	5002	3.0
MVJN R/L 3225 P16-K	2616	1086	5003	IVSN-322	1665	5002	3.0

VN.. 35° rhombic negative inserts. A49
35° rhombische negative Wendeschneidplatten.

Reference / Bez.	l	s	d
VN.. 1604..	16,50	4,76	9,52

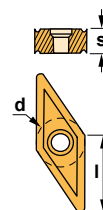

VNGP	VNMG
VNMG-TC	

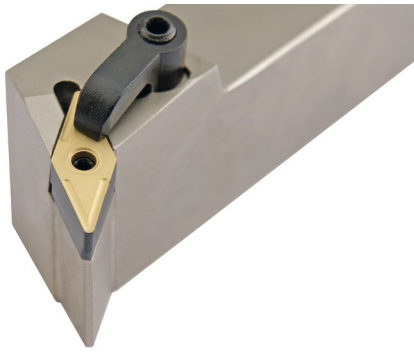

Characteristics:

Turning and profiling toolholder equipped with rhombic negative double-sided insert (angle 35°).

For general applications, roughing, semi-finishing and finishing.

Axial -8°
Radial -10°

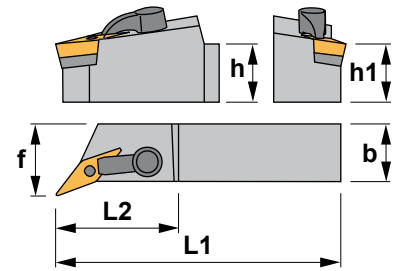

Eigenschaften:





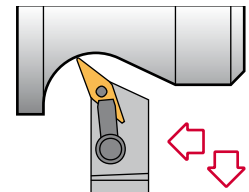

Klemmhalter zum Drehen und Profildrehen mit doppelseitigen rhombischen negativen Wendeschneidplatten (Winkel 35°).

Für allgemeine Anwendungen, Schruppen, Vorschlichten und Schlichten.



MVQN-K 117°30'

Reference Bezeichnung	h=h1	b	L1	L2	f	Insert size Wendeschneidplatte	
MVQN R/L 2020 K16-K	20	20	125	42	25	VN.. 1604..	0,450
MVQN R/L 2525 M16-K	25	25	150	42	32	VN.. 1604..	0,800
MVQN R/L 3225 P16-K	32	25	170	42	32	VN.. 1604..	1,200

Reference Bezeichnung							Nm
MVQN R/L 2020 K16-K	2616	1086	5003	IVSN-322	1665	5002	3.0
MVQN R/L 2525 M16-K	2616	1086	5003	IVSN-322	1665	5002	3.0
MVQN R/L 3225 P16-K	2616	1086	5003	IVSN-322	1665	5002	3.0

VN..

35° rhombic negative inserts.  A49
35° rhombische negative Wendeschneidplatten.

Reference / Bez.	l	s	d
VN.. 1604..	16,50	4,76	9,52

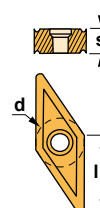

VNGP



VNMG



VNMG-TC





Characteristics:

Profiling toolholder equipped with rhombic negative double-sided insert (angle 35°).

For low powered machines and small pieces choose toolholder Ref. SVVC (Page: A162).

Axial 6°
Radial 0°

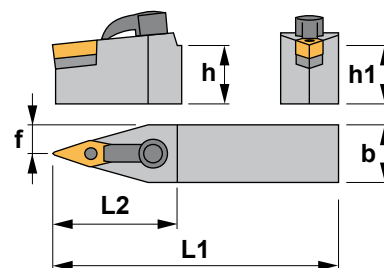

Eigenschaften:

Klemmhalter zum Drehen und Profildrehen mit doppelseitigen rhombischen negativen Wendeschneidplatten (Winkel 35°).

Für Niederleistungsmaschinen und kleine Werkstücke, wählen Sie Klemmhalter SVVC (Seite: A162).

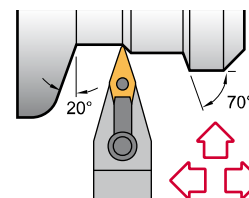

MVVN-K 72°30'

Reference Bezeichnung	h=h1	b	L1	L2	f	Insert size Wendeschneidplatte	Kg
MVVN N 2020 K16-K	20	20	125	42	10,0	VN.. 1604..	0,450
MVVN N 2525 M16-K	25	25	150	42	12,5	VN.. 1604..	0,800

Reference Bezeichnung							Nm
MVVN N 2020 K16-K	2616	1086	5003	IVSN-322	1665	5002	3.0
MVVN N 2525 M16-K	2616	1086	5003	IVSN-322	1665	5002	3.0

VN.. 35° rhombic negative inserts. A49
35° rhombische negative Wendeschneidplatten.

Reference / Bez.	l	s	d
VN.. 1604..	16,50	4,76	9,52

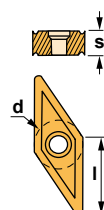

VNGP

VNMG



VNMG-TC



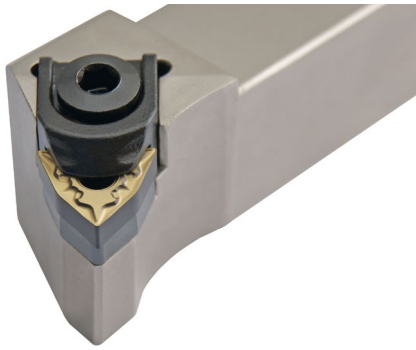

Characteristics:

Multipurpose toolholder equipped with trigon negative double-sided insert (angle 80°).

Not suitable for cermet, ceramic or K10 and P10 grade inserts.

Axial -6,5°
Radial -6,5°

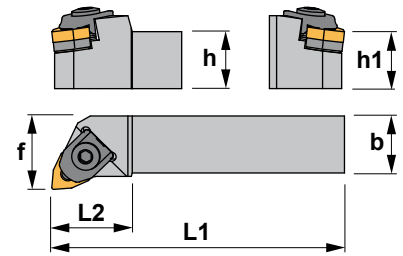

Eigenschaften:

Multifunktions-Klemmhalter mit doppelseitigen Trigon negativen Wendeschneidplatten (80° Winkel).

Nicht geeignet für Cermet, Keramik oder K10 und P10 Wendeschneidplatten.

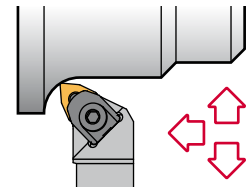

MWLN 95°

Reference Bezeichnung	h=h1	b	L1	L2	f	Insert size Wendeschneidplatte	kg
MWLN R/L 1616 H06	16	16	100	15	20	WNMG 0604..	0,200
MWLN R/L 2020 K06	20	20	125	22	25	WNMG 0604..	0,450
MWLN R/L 2525 M06	25	25	150	28	32	WNMG 0604..	0,800
MWLN R/L 2020 K08	20	20	125	34	25	WNMG 0804..	0,450
MWLN R/L 2525 M08	25	25	150	34	32	WNMG 0804..	0,800
MWLN R/L 3225 P08	32	25	170	34	32	WNMG 0804..	1,200
MWLN R/L 3232 P08	32	32	170	34	40	WNMG 0804..	1,400

Reference Bezeichnung						Nm
MWLN R/L 1616 H06	2006	5025	3006	1644	1393	2.0
MWLN R/L 2020 K06	2006	5025	3006	1642	1393	2.0
MWLN R/L 2525 M06	2006	5025	3006	1642	1393	2.0
MWLN R/L 2020 K08	2011	5005	IWSN-433	1661	1394	4.0
MWLN R/L 2525 M08	2011	5005	IWSN-433	1661	1394	4.0
MWLN R/L 3225 P08	2011	5005	IWSN-433	1661	1394	4.0
MWLN R/L 3232 P08	2011	5005	IWSN-433	1661	1394	4.0

WNMG 80° trigon negative inserts. A50-51
80° trigon negative Wendeschneidplatten.

Reference / Bez.	l	s	d
WNMG 0604..	6,45	4,76	9,52
WNMG 0804..	8,14	4,76	12,70

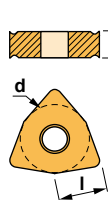

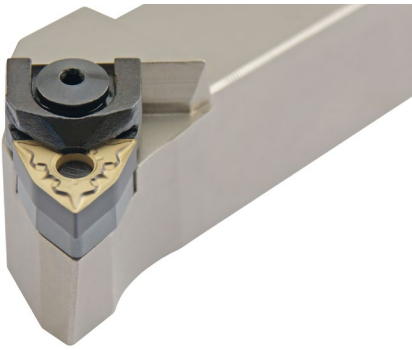

Characteristics:

Multipurpose toolholder equipped with trigon negative double-sided insert (angle 80°). Especially recommended for cermet, ceramic or K10 and P10 grade inserts.

Axial -5,5°
Radial -6,5°

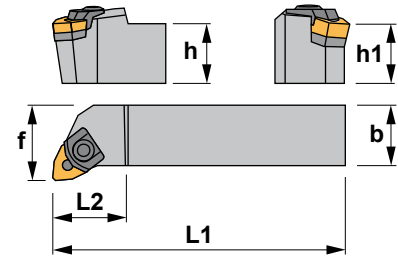

Eigenschaften:

Multifunktions-Klemmhalter mit doppelseitigen Trigon negativen Wendeschneidplatten (80° Winkel).

Besonders empfohlen für Cermet, Keramik oder K10 und P10 Wendeschneidplatten.

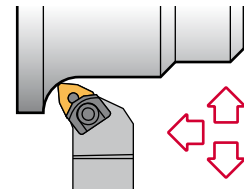

MWLN-K 95°

Reference Bezeichnung	h=h1	b	L1	L2	f	Insert size Wendeschneidplatte	kg
MWLN R/L 2020 K08-K	20	20	125	34	25	WNM.. 0804..	0,450
MWLN R/L 2525 M08-K	25	25	150	34	32	WNM.. 0804..	0,800
MWLN R/L 3232 P08-K	32	32	170	34	40	WNM.. 0804..	1,400

Reference Bezeichnung						Nm
MWLN R/L 2020 K08-K	2018	5025	IWSN-433	1661	1394	2.0
MWLN R/L 2525 M08-K	2018	5025	IWSN-433	1661	1394	2.0
MWLN R/L 3232 P08-K	2018	5025	IWSN-433	1661	1394	2.0

WNMG 80° trigon negative inserts. A50-51
80° trigon negative Wendeschneidplatten.

Reference / Bez.	l	s	d
WNMG 0804..	8,14	4,76	12,70

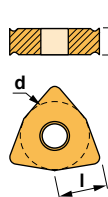



Characteristics:

Toolholder for external turning applications equipped with rhombic negative inserts (angle 80°).

For general applications, roughing, semi-finishing and finishing.

Axial -7,25°
Radial -4,25°

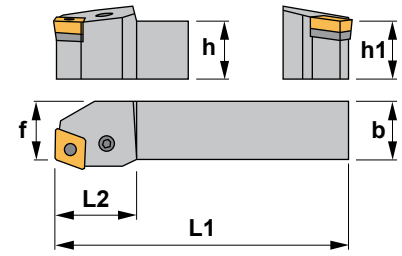

Eigenschaften:

Klemmhalter zum Außendrehen mit rhombischen negativen Wendeschneidplatten (80° Winkel).

Für allgemeine Anwendungen, Schruppen, Vorschlichten und Schlichten.

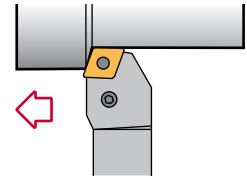

PCBN 75°

Reference Bezeichnung	h=h1	b	L1	L2	f	Insert size Wendeschneidplatte	
PCBN R/L 2020 K12	20	20	125	28	17	CN.. 1204..	0,400
PCBN R/L 2525 M12	25	25	150	28	22	CN.. 1204..	0,750
PCBN R/L 3225 P12	32	25	170	34	22	CN.. 1204..	0,750
PCBN R/L 2525 M16	25	25	150	34	22	CN.. 1606..	0,750
PCBN R/L 3225 P16	32	25	170	34	22	CN.. 1606..	1,050
PCBN R/L 3232 P16	32	32	170	34	27	CN.. 1606..	1,300
PCBN R/L 3225 P19	32	25	170	38	22	CN.. 1906..	1,050
PCBN R/L 3232 P19	32	32	170	42	27	CN.. 1906..	1,300
PCBN R/L 4040 S19	40	40	250	48	35	CN.. 1906..	3,050
PCBN R/L 4040 S25	40	40	250	48	41	CN.. 2509..	3,050
PCBN R/L 5050 T25	50	50	300	50	51	CN.. 2509..	5,800

Reference Bezeichnung							Nm
PCBN R/L 2020 K12	8012	1608	5003	3612	4112	0012	3.0
PCBN R/L 2525 M12	8012	1608	5003	3612	4112	0012	3.0
PCBN R/L 3225 P12	8012	1608	5003	3612	4112	0012	3.0
PCBN R/L 2525 M16	8016	1618	5003	3616	4115	0015	3.0
PCBN R/L 3225 P16	8016	1618	5003	3616	4115	0015	3.0
PCBN R/L 3232 P16	8016	1618	5003	3616	4115	0015	3.0
PCBN R/L 3225 P19	8019	1610	5004	3619	4119	0019	3.5
PCBN R/L 3232 P19	8019	1610	5004	3619	4119	0019	3.5
PCBN R/L 4040 S19	8019	1610	5004	3619	4119	0019	3.5
PCBN R/L 4040 S25	8025	1612	5005	3625	4125	0025	4.0
PCBN R/L 5050 T25	8025	1612	5005	3625	4125	0025	4.0

CN..

80° rhombic negative inserts. A32-34
80° rhombische negative WSP.

Reference / Bez.	l	s	d
CN.. 1204..	12,90	4,76	12,70
CN.. 1606..	16,10	6,35	15,88
CN.. 1906..	19,30	6,35	19,05
CN.. 2509..	25,80	9,52	25,40

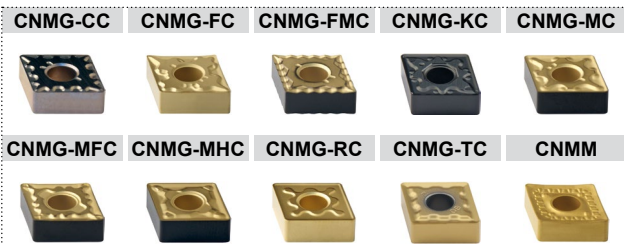
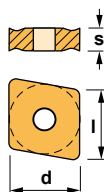

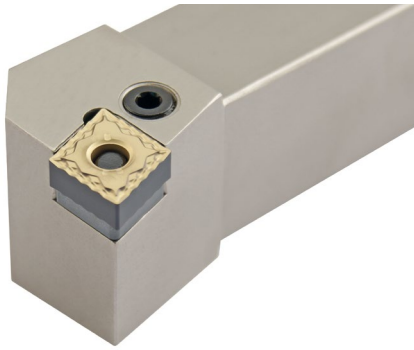

Characteristics:

Toolholder for face turning applications equipped with rhombic negative inserts (angle 80°).

For general applications, roughing, semi-finishing and finishing.

Axial -6°
Radial -6°

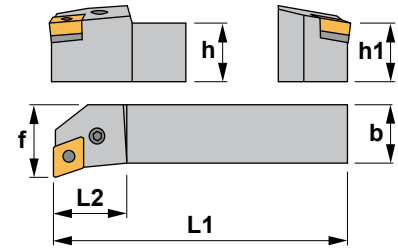

Eigenschaften:

Klemmhalter zum Plandrehen mit doppelseitigen rhombischen negativen Wendschneidplatten (80° Winkel).

Für allgemeine Anwendungen, Schruppen, Vorschlichten und Schlichten.



PCFN 90°

Reference Bezeichnung	h=h1	b	L1	L2	f	Insert size Wendschneidplatte	
PCFN R/L 2525 M12	25	25	150	28	32	CN.. 1204..	0,750
PCFN R/L 2525 M16	25	25	150	34	32	CN.. 1606..	0,750
PCFN R/L 3225 P16	32	25	170	34	32	CN.. 1606..	1,050
PCFN R/L 3232 P16	32	32	170	34	40	CN.. 1606..	1,300
PCFN R/L 3225 P19	32	25	170	34	32	CN.. 1906..	1,050
PCFN R/L 3232 P19	32	32	170	42	40	CN.. 1906..	1,300
PCFN R/L 4040 S19	40	40	250	45	50	CN.. 1906..	3,050

Reference Bezeichnung							Nm
PCFN R/L 2525 M12	8012	1608	5003	3612	4112	0012	3.0
PCFN R/L 2525 M16	8016	1618	5003	3616	4115	0015	3.0
PCFN R/L 3225 P16	8016	1618	5003	3616	4115	0015	3.0
PCFN R/L 3232 P16	8016	1618	5003	3616	4115	0015	3.0
PCFN R/L 3225 P19	8019	1610	5004	3619	4119	0019	3.5
PCFN R/L 3232 P19	8019	1610	5004	3619	4119	0019	3.5
PCFN R/L 4040 S19	8019	1610	5004	3619	4119	0019	3.5

CN..

80° rhombic negative inserts.
80° rhombische negative WSP. A32-34

Reference / Bez.	l	s	d
CN.. 1204..	12,90	4,76	12,70
CN.. 1606..	16,10	6,35	15,88
CN.. 1906..	19,30	6,35	19,05

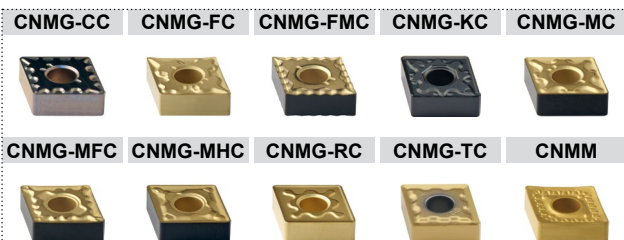
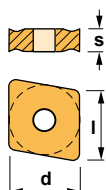



Characteristics:

Toolholder for face turning applications equipped with rhombic negative inserts (angle 80°).

For general applications, roughing, semi-finishing and finishing.

Axial -6,5°
Radial -5,5°

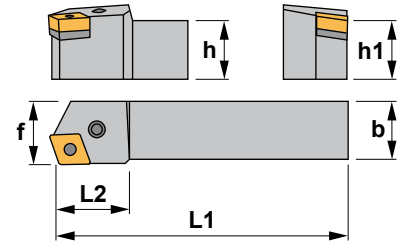

Eigenschaften:

Klemmhalter zum Plandrehen mit doppelseitigen rhombischen negativen Wendeschneidplatten (80° Winkel).

Für allgemeine Anwendungen, Schruppen, Vorschlichten und Schlichten.



PCKN 75°

Reference Bezeichnung	h=h1	b	L1	L2	f	Insert size Wendeschneidplatte	
PCKN R/L 2020 K12	20	20	125	28	25	CN.. 1204..	0,400
PCKN R/L 2525 M12	25	25	150	28	32	CN.. 1204..	0,750
PCKN R/L 3225 P12	32	25	170	28	32	CN.. 1204..	1,050
PCKN R/L 3232 P19	32	32	170	34	40	CN.. 1906..	1,300
PCKN R/L 4040 S19	40	40	250	45	50	CN.. 1906..	3,050
PCKN R/L 4040 S25	40	40	250	45	50	CN.. 2509..	3,050
PCKN R/L 5050 T25	50	50	300	45	60	CN.. 2509..	5,850

Reference Bezeichnung							Nm
PCKN R/L 2020 K12	8012	1608	5003	3612	4112	0012	3.0
PCKN R/L 2525 M12	8012	1608	5003	3612	4112	0012	3.0
PCKN R/L 3225 P12	8012	1608	5003	3612	4112	0012	3.0
PCKN R/L 3232 P19	8019	1610	5004	3619	4119	0019	3.5
PCKN R/L 4040 S19	8019	1610	5004	3619	4119	0019	3.5
PCKN R/L 4040 S25	8025	1612	5005	3625	4125	0025	4.0
PCKN R/L 5050 T25	8025	1612	5005	3625	4125	0025	4.0

CN..

80° rhombic negative inserts. A32-34
80° rhombische negative WSP.

Reference / Bez.	l	s	d
CN.. 1204..	12,90	4,76	12,70
CN.. 1906..	19,30	6,35	19,05
CN.. 2509..	25,80	9,52	25,40

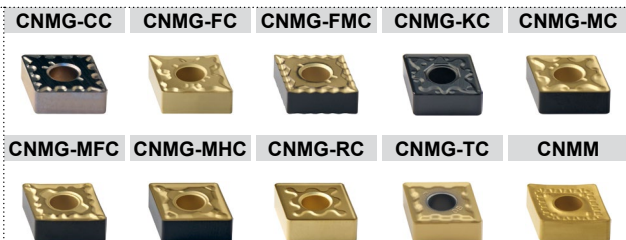
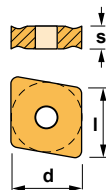



Characteristics:

Multipurpose toolholder equipped with rhombic negative double-sided insert (angle 80°).
For low powered machines and small pieces choose toolholder Ref. SCLC (Page: A132).

Axial -6,5°
Radial -6,5°

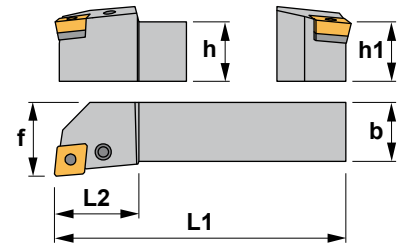

Eigenschaften:

Multifunktions-Klemmhalter mit doppelseitigen rhombischen negativen Wendeschneidplatten (80° Winkel). Für Niederleistungsmaschinen und kleine Werkstücke, wählen Sie Klemmhalter SCLC (Seite: A132).

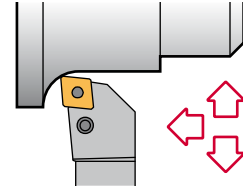

PCLN 95°

Reference Bezeichnung	h=h1	b	L1	L2	f	Insert size Wendeschneidplatte	Kg
PCLN R/L 1616 H09	16	16	100	25	20	CN.. 0903..	0,250
PCLN R/L 2020 K09	20	20	125	28	25	CN.. 0903..	0,400
PCLN R/L 2525 M09	25	25	150	28	32	CN.. 0903..	0,750
PCLN R/L 1616 H12	16	16	100	25	20	CN.. 1204..	0,250
PCLN R/L 2020 K12	20	20	125	28	25	CN.. 1204..	0,400
PCLN R/L 2525 M12	25	25	150	28	32	CN.. 1204..	0,750
PCLN R/L 3225 P12	32	25	170	28	32	CN.. 1204..	1,050
PCLN R/L 3232 P12	32	32	170	28	40	CN.. 1204..	1,300
PCLN R/L 2525 M16	25	25	150	34	32	CN.. 1606..	0,750
PCLN R/L 3225 P16	32	25	170	34	32	CN.. 1606..	1,050
PCLN R/L 3232 P16	32	32	170	34	40	CN.. 1606..	1,300
PCLN R/L 4040 S16	40	40	250	45	50	CN.. 1606..	3,050
PCLN R/L 2525 M19	25	25	150	42	32	CN.. 1906..	0,750
PCLN R/L 3225 P19	32	25	170	42	32	CN.. 1906..	1,050
PCLN R/L 3232 P19	32	32	170	42	40	CN.. 1906..	1,300
PCLN R/L 4040 S19	40	40	250	45	50	CN.. 1906..	3,050
PCLN R/L 5050 T19	50	50	300	50	60	CN.. 1906..	3,050
PCLN R/L 4040 S25	40	40	250	45	50	CN.. 2509..	3,050
PCLN R/L 5050 T25	50	50	300	50	60	CN.. 2509..	5,850

Reference Bezeichnung							Nm
PCLN R/L.....09	8009	1606	5025	3609	4109	0009	2.0
PCLN R/L.....H12	8312	1648	5003	3612	4112	0012	3.0
PCLN R/L.....12	8012	1608	5003	3612	4112	0012	3.0
PCLN R/L.....16	8016	1618	5003	3616	4115	0015	3.0
PCLN R/L.....19	8019	1610	5004	3619	4119	0019	3.5
PCLN R/L.....25	8025	1612	5005	3625	4125	0025	4.0

CN..

80° rhombic negative inserts.
80° rhombische negative WSP. A32-34

Reference / Bez.	l	s	d
CN.. 0903..	9,65	3,18	9,52
CN.. 1204..	12,90	4,76	12,70
CN.. 1606..	16,10	6,35	15,88
CN.. 1906..	19,30	6,35	19,05
CN.. 2509..	25,80	9,52	25,40

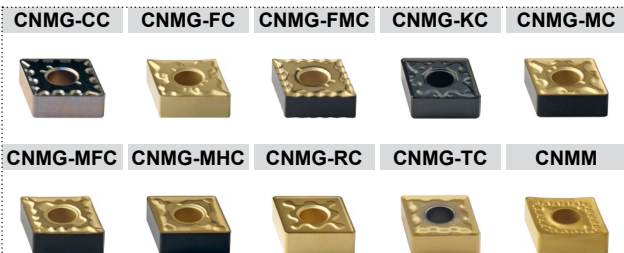
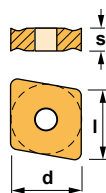



Characteristics:

Profiling toolholder equipped with rhombic negative double-sided insert (angle 80°).
For general applications, roughing, semi-finishing and finishing.

Axial -6°
Radial 0°

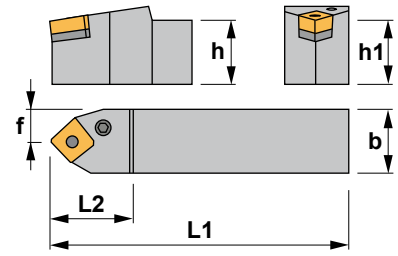

Eigenschaften:

Klemmhalter zum Profildrehen mit doppelseitigen rhombischen negativen Wendeschneidplatten (80° Winkel).

Für allgemeine Anwendungen, Schruppen, Vorschlichten und Schlichten.

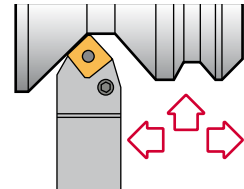

PCMN 50°

Reference Bezeichnung	h=h1	b	L1	L2	f	Insert size Wendeschneidplatte	Kg
PCMN N 2020 K12	20	20	125	34	10,0	CN.. 1204..	0,400
PCMN N 2525 M12	25	25	150	34	12,5	CN.. 1204..	0,750
PCMN N 3225 P12	32	25	170	34	12,5	CN.. 1204..	1,050
PCMN N 3232 P19	32	32	170	42	16,0	CN.. 1906..	1,300
PCMN N 4040 S19	40	40	250	48	20,0	CN.. 1906..	3,050

Reference Bezeichnung							Nm
PCMN N 2020 K12	8012	1608	5003	3612	4112	0012	3.0
PCMN N 2525 M12	8012	1608	5003	3612	4112	0012	3.0
PCMN N 3225 P12	8012	1608	5003	3612	4112	0012	3.0
PCMN N 3232 P19	8019	1610	5004	3619	4119	0019	3.5
PCMN N 4040 S19	8019	1610	5004	3619	4119	0019	3.5

CN..

80° rhombic negative inserts. A32-34
80° rhombische negative WSP.

Reference / Bez.	l	s	d
CN.. 1204..	12,90	4,76	12,70
CN.. 1906..	19,30	6,35	19,05

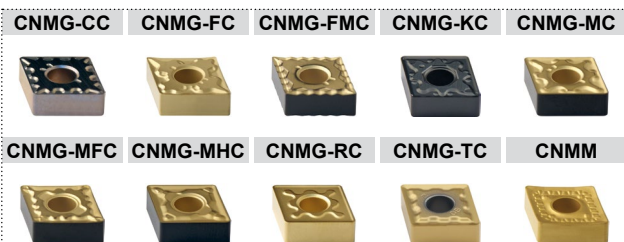
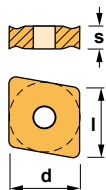



Characteristics:

Toolholder for external turning applications equipped with rhombic negative inserts (angle 80°).

For general applications, roughing, semi-finishing and finishing.

Axial -5,75°
Radial -5,75°

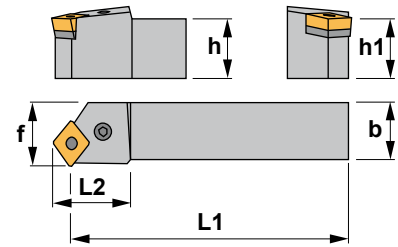

Eigenschaften:

Klemmhalter zum Außendrehen mit rhombischen negativen Wendeschneidplatten (80° Winkel).

Für allgemeine Anwendungen, Schruppen, Vorschlichten und Schlichten.

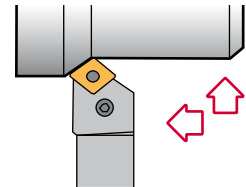

PCSN 45°

Reference Bezeichnung	h=h1	b	L1	L2	f	Insert size Wendeschneidplatte	Kg
PCSN R/L 2020 K12	20	20	125	28	25	CN.. 1204..	0,400
PCSN R/L 2525 M12	25	25	150	28	32	CN.. 1204..	0,750
PCSN R/L 2525 M16	25	25	150	34	32	CN.. 1606..	0,750
PCSN R/L 3225 P16	32	25	170	34	32	CN.. 1606..	1,050
PCSN R/L 3232 P16	32	32	170	42	40	CN.. 1606..	1,300
PCSN R/L 3225 P19	32	25	170	42	32	CN.. 1906..	1,050
PCSN R/L 3232 P19	32	32	170	42	40	CN.. 1906..	1,300
PCSN R/L 4040 S19	40	40	250	42	50	CN.. 1906..	3,050

Reference Bezeichnung							Nm
PCSN R/L 2020 K12	8012	1608	5003	3612	4112	0012	3.0
PCSN R/L 2525 M12	8012	1608	5003	3612	4112	0012	3.0
PCSN R/L 2525 M16	8016	1618	5003	3616	4115	0015	3.0
PCSN R/L 3225 P16	8016	1618	5003	3616	4115	0015	3.0
PCSN R/L 3232 P16	8016	1618	5003	3616	4115	0015	3.0
PCSN R/L 3225 P19	8019	1610	5004	3619	4119	0019	3.5
PCSN R/L 3232 P19	8019	1610	5004	3619	4119	0019	3.5
PCSN R/L 4040 S19	8019	1610	5004	3619	4119	0019	3.5

CN..

80° rhombic negative inserts.
80° rhombische negative WSP. A32-34

Reference / Bez.	l	s	d
CN.. 1204..	12,90	4,76	12,70
CN.. 1606..	16,10	6,35	15,88
CN.. 1906..	19,30	6,35	19,05

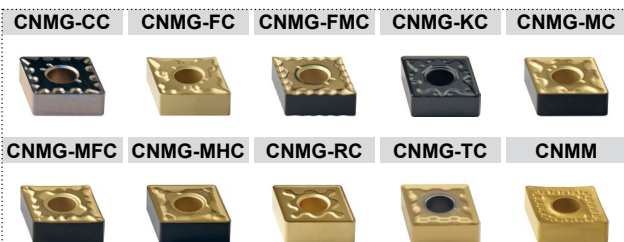
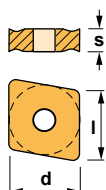



Characteristics:

Turning and profiling toolholder equipped with rhombic negative double-sided insert (angle 55°).

For low powered machines and small pieces choose toolholder Ref. SDJC (Page: A137).

Axial 6,25°
Radial -6,75°

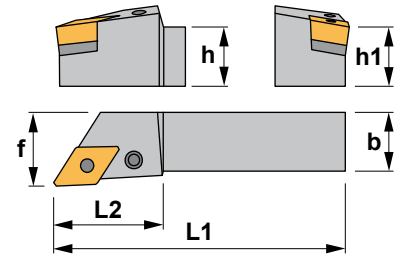

Eigenschaften:

Klemmhalter zum Profildrehen mit doppelseitigen rhombischen negativen Wendeschneidplatten (55° Winkel).

Für Niederleistungsmaschinen und kleine Werkstücke, wählen Sie Klemmhalter SDJC (Seite: A137).

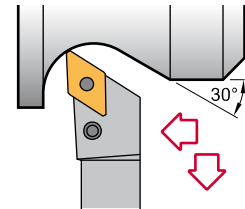

PDJN 93°

Reference Bezeichnung	h=h1	b	L1	L2	f	Insert size Wendeschneidplatte	kg
PDJN R/L 1616 H11	16	16	100	25	20	DN.. 1104..	0,250
PDJN R/L 2020 K11	20	20	125	28	25	DN.. 1104..	0,400
PDJN R/L 2525 M11	25	25	150	28	32	DN.. 1104..	0,750
PDJN R/L 3225 P11	32	25	170	28	32	DN.. 1104..	1,050
PDJN R/L 2020 K15	20	20	125	34	25	DN.. 1506..	0,400
PDJN R/L 2525 M15	25	25	150	34	32	DN.. 1506..	0,750
PDJN R/L 3225 P15	32	25	170	34	32	DN.. 1506..	1,050
PDJN R/L 3232 P15	32	32	170	34	40	DN.. 1506..	1,300
PDJN R/L 4025 R15	40	25	200	34	32	DN.. 1506..	1,850
PDJN R/L 5032 S15	50	32	250	34	40	DN.. 1506..	2,900

Reference Bezeichnung									Nm
PDJN R/L 1616 H11	8009	1606	5025	3711	4109	0009	-	-	2.0
PDJN R/L 2020 K11	8009	1606	5025	3711	4109	0009	-	-	2.0
PDJN R/L 2525 M11	8009	1606	5025	3711	4109	0009	-	-	2.0
PDJN R/L 3225 P11	8009	1606	5025	3711	4109	0009	-	-	2.0
PDJN R/L 2020 K15	8415	1638	5003	3715	4112	0012	3725	4135	3.0
PDJN R/L 2525 M15	8415	1638	5003	3715	4112	0012	3725	4135	3.0
PDJN R/L 3225 P15	8415	1638	5003	3715	4112	0012	3725	4135	3.0
PDJN R/L 3232 P15	8415	1638	5003	3715	4112	0012	3725	4135	3.0
PDJN R/L 4025 R15	8415	1638	5003	3715	4112	0012	3725	4135	3.0
PDJN R/L 5032 S15	8415	1638	5003	3715	4112	0012	3725	4135	3.0

For inserts DNM.. 1504
Für Wendeschneidplatten DNM.. 1504

DN.. 55° rhombic negative inserts. 55° rhombische negative Wendeschneidplatten. A36-37

Reference / Bez.	l	s	d
DN.. 1104..	11,60	4,76	9,52
DN.. 1504..	15,50	4,76	12,70
DN.. 1506..	15,50	6,35	12,70

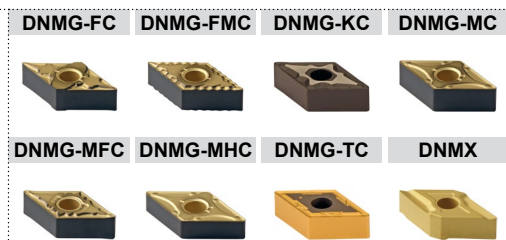
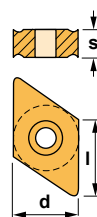



Characteristics:

Profiling toolholder equipped with rhombic negative double-sided insert (angle 55°).

For low powered machines and small pieces choose toolholder Ref. SDNC (Page: A140).

Axial -8°
Radial -2,5°

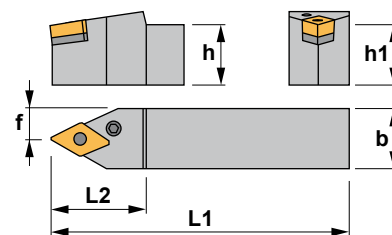

Eigenschaften:

Klemmhalter zum Profildrehen mit doppelseitigen rhombischen negativen Wendeschneidplatten (55° Winkel).

Für Niederleistungsmaschinen und kleine Werkstücke, wählen Sie Klemmhalter SDNC (Seite: A140).

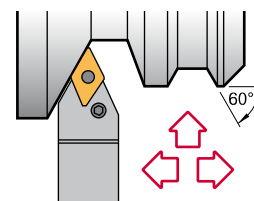

PDNN 63°

Reference Bezeichnung	h=h1	b	L1	L2	f	Insert size Wendeschneidplatte	Kg
PDNN R/L/N 2020 K15	20	20	125	34	10,0	DN.. 1506..	0,400
PDNN R/L/N 2525 M15	25	25	150	34	12,5	DN.. 1506..	0,750
PDNN R/L/N 3225 P15	32	25	170	34	12,5	DN.. 1506..	1,050
PDNN R/L/N 3232 P15	32	32	170	34	16,0	DN.. 1506..	1,300
PDNN R/L/N 4025 S15	40	25	250	34	12,5	DN.. 1506..	1,850
PDNN R/L/N 5032 S15	50	32	250	34	16,0	DN.. 1506..	2,900

Reference Bezeichnung									Nm
PDNN R/L/N 2020 K15	8415	1638	5003	3715	4112	0012	3725	4135	3.0
PDNN R/L/N 2525 M15	8415	1638	5003	3715	4112	0012	3725	4135	3.0
PDNN R/L/N 3225 P15	8415	1638	5003	3715	4112	0012	3725	4135	3.0
PDNN R/L/N 3232 P15	8415	1638	5003	3715	4112	0012	3725	4135	3.0
PDNN R/L/N 4025 S15	8415	1638	5003	3715	4112	0012	3725	4135	3.0
PDNN R/L/N 5032 S15	8415	1638	5003	3715	4112	0012	3725	4135	3.0

For inserts DNM.. 1504
Für Wendeschneidplatten DNM.. 1504

DN.. 55° rhombic negative inserts. A36-37
55° rhombische negative Wendeschneidplatten.

Reference / Bez.	l	s	d
DN.. 1504..	15,50	4,76	12,70
DN.. 1506..	15,50	6,35	12,70

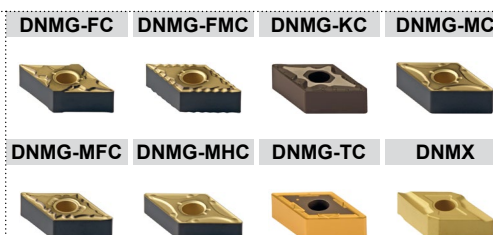
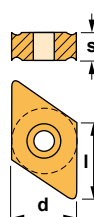

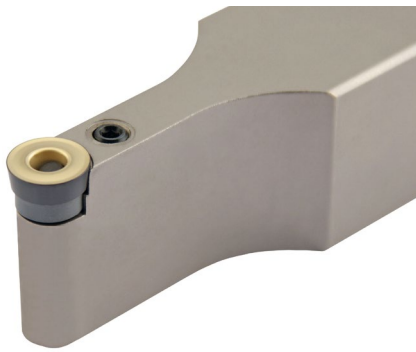

Characteristics:

Profiling toolholder equipped with round positive insert.

For screw type toolholders see Ref. SRDC (Page: A142).

Axial 0°
Radial 0°

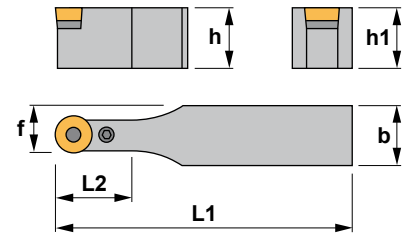

Eigenschaften:

Klemmhalter zum Profildrehen mit runden positiven Wendeschneidplatten.

Für Klemmhalter mit Schraubenklemmung, siehe SRDC (Seite: A142).

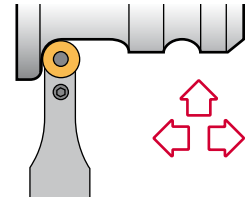

PRDC

Reference Bezeichnung	h=h1	b	L1	L2	f	Insert size Wendeschneidplatte	Kg
PRDC N 2020 K10	20	20	125	22	15,0	RC.. 1003M0	0,400
PRDC N 2525 M10	25	25	150	22	18,5	RC.. 1003M0	0,750
PRDC N 3225 P10	32	25	170	22	18,5	RC.. 1003M0	1,050
PRDC N 2020 K12	20	20	125	28	16,0	RC.. 1204M0	0,400
PRDC N 2525 M12	25	25	150	28	18,5	RC.. 1204M0	0,750
PRDC N 3225 P12	32	25	170	28	18,5	RC.. 1204M0	1,050
PRDC N 3232 P12	32	32	170	28	22,0	RC.. 1204M0	1,300
PRDC N 4025 S12	40	25	250	28	18,5	RC.. 1204M0	1,850
PRDC N 3225 P16	32	25	170	34	20,5	RC.. 1606M0	1,050
PRDC N 3232 P16	32	32	170	34	24,0	RC.. 1606M0	1,300
PRDC N 3232 P20	32	32	170	42	26,0	RC.. 2006M0	1,300
PRDC N 4040 S20	40	40	250	42	30,0	RC.. 2006M0	3,050
PRDC N 4040 S25	40	40	250	45	32,5	RC.. 2507M0	3,050
PRDC N 4040 U25	40	40	350	45	32,5	RC.. 2507M0	3,050
PRDC N 5050 U25	50	50	350	45	37,5	RC.. 2507M0	5,850
PRDC N 5050 V32	50	50	400	52	41,0	RC.. 3209M0	5,850

Reference Bezeichnung							Nm
PRDC N.....10	8110	1705	5002	3810	4110	0009	1.4
PRDC N.....12	8112	1606	5025	3812	4110	0009	2.0
PRDC N.....16	8116	1706	5025	3816	4116	0012	2.0
PRDC N.....20	8120	1708	5003	3820	4115	0015	3.0
PRDC N.....25	8125	1710	5004	3825	4119	0019	3.5
PRDC N.....32	8132	1612	5005	3832	4125	0025	4.0

RC..

Round positive inserts with 7° clearance. A38-39
Runde positive Wendeschneidplatten mit 7° Freiwinkel.

Reference / Bez.	s	d
RC.. 1003M0	3,18	10,00
RC.. 1204M0	4,76	12,00
RC.. 1606M0	6,35	16,00
RC.. 2006M0	6,35	20,00
RC.. 2507M0	7,94	25,00
RC.. 3209M0	9,52	32,00

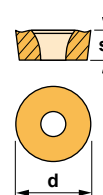

RCGT-AL



RCGT-AP



RCMT





Characteristics:

Profiling multipurpose turning toolholder equipped with round positive insert.
For general applications, roughing, semi-finishing and finishing.

Axial 0°
Radial 0°

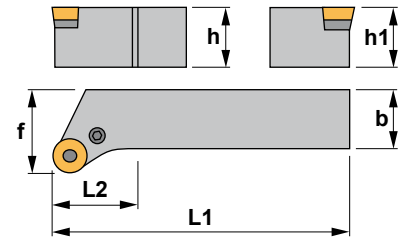

Eigenschaften:

Klemmhalter zum Profildrehen mit runden positiven Wendeschneidplatten.
Für allgemeine Anwendungen, Schruppen, Vorschlichten und Schlichten.

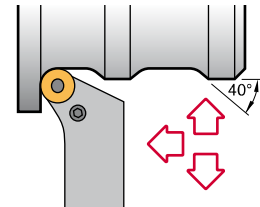

PRSC

Reference Bezeichnung	h=h1	b	L1	L2	f	Insert size Wendeschneidplatte	KG
PRSC R/L 2020 K10	20	20	125	28	25	RC.. 1003M0	0,400
PRSC R/L 2525 M10	25	25	150	28	32	RC.. 1003M0	0,750
PRSC R/L 3225 P10	32	25	170	28	32	RC.. 1003M0	1,050
PRSC R/L 2020 K12	20	20	125	28	25	RC.. 1204M0	0,400
PRSC R/L 2525 M12	25	25	150	28	32	RC.. 1204M0	0,750
PRSC R/L 3225 P12	32	25	170	28	32	RC.. 1204M0	1,050
PRSC R/L 2525 M16	25	25	150	34	32	RC.. 1606M0	0,750
PRSC R/L 3225 P16	32	25	170	34	32	RC.. 1606M0	1,050
PRSC R/L 3232 P20	32	32	170	42	40	RC.. 2006M0	1,300
PRSC R/L 4040 S20	40	40	250	48	50	RC.. 2006M0	3,050
PRSC R/L 4040 S25	40	40	250	48	50	RC.. 2507M0	3,050
PRSC R/L 5050 T32	50	50	300	50	63	RC.. 3209M0	5,850

Reference Bezeichnung							Nm
PRSC R/L 2020 K10	8110	1705	5002	3810	4110	0009	1.4
PRSC R/L 2525 M10	8110	1705	5002	3810	4110	0009	1.4
PRSC R/L 3225 P10	8110	1705	5002	3810	4110	0009	1.4
PRSC R/L 2020 K12	8112	1606	5025	3812	4110	0009	2.0
PRSC R/L 2525 M12	8112	1606	5025	3812	4110	0009	2.0
PRSC R/L 3225 P12	8112	1606	5025	3812	4110	0009	2.0
PRSC R/L 2525 M16	8116	1706	5025	3816	4116	0012	2.0
PRSC R/L 3225 P16	8116	1706	5025	3816	4116	0012	2.0
PRSC R/L 3232 P20	8120	1708	5003	3820	4115	0015	3.0
PRSC R/L 4040 S20	8120	1708	5003	3820	4115	0015	3.0
PRSC R/L 4040 S25	8125	1710	5004	3825	4119	0019	3.5
PRSC R/L 5050 T32	8132	1612	5005	3832	4125	0025	4.0

RC..

Round positive inserts with 7° clearance. A38-39
Runde positive Wendeschneidplatten mit 7° Freiwinkel.

Reference / Bez.	s	d
RC.. 1003M0	3,18	10,00
RC.. 1204M0	4,76	12,00
RC.. 1606M0	6,35	16,00
RC.. 2006M0	6,35	20,00
RC.. 2507M0	7,94	25,00
RC.. 3209M0	9,52	32,00

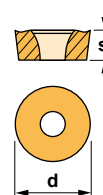

RCGT-AL



RCGT-AP



RCMT



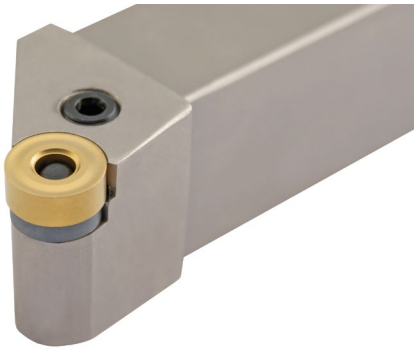

Characteristics:

Profiling multipurpose turning toolholder equipped with round negative insert. For general applications, roughing, semi-finishing and finishing.

Axial -6°
Radial -6°

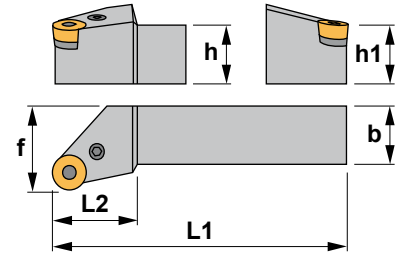

Eigenschaften:

Multifunktions-Klemmhalter zum Profildrehen mit runden negativen Wendeschneidplatten. Für allgemeine Anwendungen, Schruppen, Vorschlichten und Schlichten.

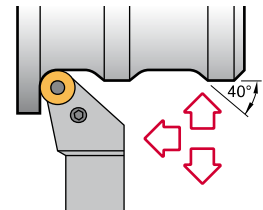

PRSN

Reference Bezeichnung	h=h1	b	L1	L2	f	Insert size Wendeschneidplatte	kg
PRSN R/L 2020 K09	20	20	125	22	25	RNMG 090300	0,400
PRSN R/L 2525 M12	25	25	150	28	32	RNMG 120400	0,750
PRSN R/L 3225 P15	32	25	170	34	32	RNMG 150600	1,050
PRSN R/L 3232 P19	32	32	170	42	40	RNMG 190600	1,300
PRSN R/L 4040 S25	40	40	250	45	50	RNMG 250900	3,050

Reference Bezeichnung							Nm
PRSN R/L 2020 K09	8009	1606	5025	3909	4110	0009	2.0
PRSN R/L 2525 M12	8012	1608	5003	3912	4112	0012	3.0
PRSN R/L 3225 P15	8015	1708	5003	3915	4115	0015	3.0
PRSN R/L 3232 P19	8019	1610	5004	3919	4119	0019	3.5
PRSN R/L 4040 S25	8025	1612	5005	3925	4125	0025	4.0

RNMG

Round negative inserts.
Runde negative Wendeschneidplatte. A39

Reference / Bez.

s

d

RNMG 090300

3,18

9,52

RNMG 120400

4,76

12,70

RNMG 150600

6,35

15,88

RNMG 190600

6,35

19,05

RNMG 250900

9,52

25,40

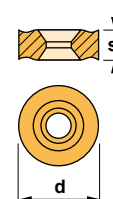

RNMG



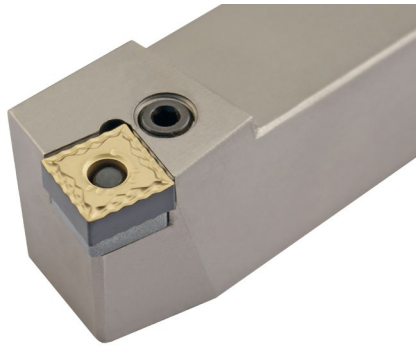

Characteristics:

Toolholder for external turning applications equipped with square negative inserts.

For low powered machines and small pieces choose toolholder Ref. CSBP (Page: A116) or SSBC (Page: A143).

Axial -7,25°
Radial -4,25°

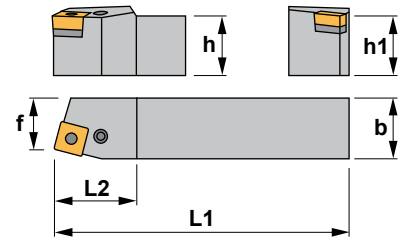

Eigenschaften:

Klemmhalter zum Außendrehen mit vierkantigen negativen Wendeschneidplatten.

Für Niederleistungsmaschinen und kleine Werkstücke, wählen Sie Klemmhalter Bez. CSBP (Seite: A116) oder SSBC (Seite: A143).

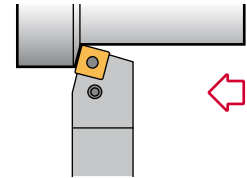

PSBN 75°

Reference Bezeichnung	h=h1	b	L1	L2	f	Insert size Wendeschneidplatte	Kg
PSBN R/L 1212 F09	12	12	80	18	11	SNM.. 0903..	0,100
PSBN R/L 1616 H09	16	16	100	22	13	SNM.. 0903..	0,250
PSBN R/L 2020 K09	20	20	125	22	17	SNM.. 0903..	0,400
PSBN R/L 2020 K12	20	20	125	28	17	SNM.. 1204..	0,400
PSBN R/L 2525 M12	25	25	150	28	22	SNM.. 1204..	0,750
PSBN R/L 3225 P12	32	25	170	28	22	SNM.. 1204..	1,050
PSBN R/L 2525 M15	25	25	150	34	22	SNM.. 1506..	0,750
PSBN R/L 3232 P15	32	32	170	34	27	SNM.. 1506..	1,300
PSBN R/L 3232 P19	32	32	170	42	27	SNM.. 1906..	1,300
PSBN R/L 4040 S19	40	40	250	48	35	SNM.. 1906..	3,050
PSBN R/L 5050 T19	50	50	300	50	43	SNM.. 1906..	3,050
PSBN R/L 4040 S25	40	40	250	48	35	SNM.. 2507..	3,050
PSBN R/L 5050 T25	50	50	300	50	43	SNM.. 2507..	5,850

Reference Bezeichnung							Nm
PSBN R/L 1212 F09	8005	1715	5002	-	-	-	1.4
PSBN R/L 1616 H09	8009	1606	5025	3509	4110	0009	2.0
PSBN R/L 2020 K09	8009	1606	5025	3509	4110	0009	2.0
PSBN R/L 2020 K12	8012	1608	5003	3512	4112	0012	3.0
PSBN R/L 2525 M12	8012	1608	5003	3512	4112	0012	3.0
PSBN R/L 3225 P12	8012	1608	5003	3512	4112	0012	3.0
PSBN R/L 2525 M15	8016	1618	5003	3515	4115	0015	3.0
PSBN R/L 3232 P15	8016	1618	5003	3515	4115	0015	3.0
PSBN R/L 3232 P19	8019	1610	5004	3519	4119	0019	3.5
PSBN R/L 4040 S19	8019	1610	5004	3519	4119	0019	3.5
PSBN R/L 5050 T19	8019	1610	5004	3519	4119	0019	3.5
PSBN R/L 4040 S25	8025	1612	5005	3525	4125	0025	4.0
PSBN R/L 5050 T25	8025	1612	5005	3525	4125	0025	4.0

SNM..

Square negative inserts.
Vierkantige negative Wendeschneidplatten. A41-42

Reference / Bez.	l	s	d
SNM.. 0903..	9,52	3,18	9,52
SNM.. 1204..	12,70	4,76	12,70
SNM.. 1506..	15,88	6,35	15,88
SNM.. 1906..	19,05	6,35	19,05
SNM.. 2507..	25,40	7,94	25,40

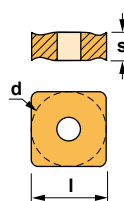

SNMG-FMC SNMG-KC SNMG-MHC



SNMG-RC SNMG-TC SNMM





Characteristics:

Toolholder for external turning and chamfering applications equipped with square negative inserts. For low powered machines and small pieces choose toolholder Ref. CSDP (Page: A117) or SSSC (Page: A145).

Axial -7°
Radial 0°

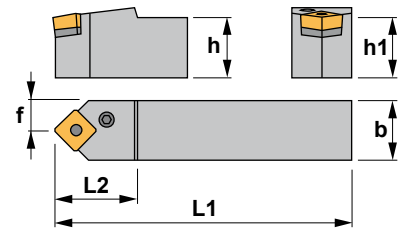

Eigenschaften:

Klemmhalter zum Außendreihen und Abschrägen mit vierkantigen negativen Wendschneidplatten. Für Niederleistungsmaschinen und kleine Werkstücke, wählen Sie Klemmhalter Bez. CSDP (Seite: A117) oder SSSC (Seite: A145).

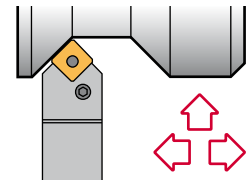

PSDN 45°

Reference Bezeichnung	h=h1	b	L1	L2	f	Insert size Wendschneidplatte	KG
PSDN N 1010 E09	10	10	70	16	5,0	SNM.. 0903..	0,070
PSDN N 1212 F09	12	12	80	20	6,0	SNM.. 0903..	0,100
PSDN N 1616 H09	16	16	100	22	8,0	SNM.. 0903..	0,250
PSDN N 2020 K12	20	20	125	28	10,0	SNM.. 1204..	0,400
PSDN N 2525 M12	25	25	150	28	12,5	SNM.. 1204..	0,750
PSDN N 3225 P12	32	25	170	34	12,5	SNM.. 1204..	1,050
PSDN N 3232 P12	32	32	170	34	16,0	SNM.. 1204..	1,300
PSDN N 3225 P19	32	25	170	34	12,5	SNM.. 1906..	1,050
PSDN N 3232 P19	32	32	170	42	16,0	SNM.. 1906..	1,300
PSDN N 4040 S25	40	40	250	48	20,0	SNM.. 2507..	3,050
PSDN N 5050 T25	50	50	300	50	25,0	SNM.. 2507..	5,850

Reference Bezeichnung							Nm
PSDN N 1010 E09	8005	1715	5002	-	-	-	1.4
PSDN N 1212 F09	8005	1715	5002	-	-	-	1.4
PSDN N 1616 H09	8009	1606	5025	3509	4110	0009	2.0
PSDN N 2020 K12	8012	1608	5003	3512	4112	0012	3.0
PSDN N 2525 M12	8012	1608	5003	3512	4112	0012	3.0
PSDN N 3225 P12	8012	1608	5003	3512	4112	0012	3.0
PSDN N 3232 P12	8012	1608	5003	3512	4112	0012	3.0
PSDN N 3225 P19	8019	1610	5004	3519	4119	0019	3.5
PSDN N 3232 P19	8019	1610	5004	3519	4119	0019	3.5
PSDN N 4040 S25	8025	1612	5005	3525	4125	0025	4.0
PSDN N 5050 T25	8025	1612	5005	3525	4125	0025	4.0

SNM..

Square negative inserts. A41-42
Vierkantige negative Wendschneidplatten.

Reference / Bez.	l	s	d
SNM.. 0903..	9,52	3,18	9,52
SNM.. 1204..	12,70	4,76	12,70
SNM.. 1906..	19,05	6,35	19,05
SNM.. 2507..	25,40	7,94	25,40

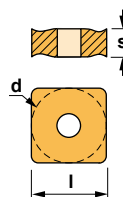

SNMG-FMC



SNMG-KC



SNMG-MHC



SNMG-RC



SNMG-TC



SNMM





Characteristics:

Toolholder for face turning applications equipped with square negative inserts.

For low powered machines and small pieces choose toolholder Ref. CSKP (Page: A118).

Axial -4,25°
Radial -7,25°

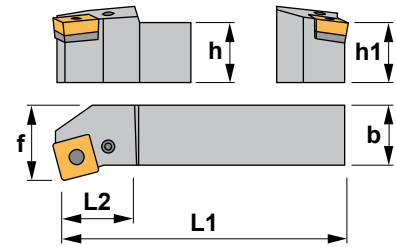

Eigenschaften:

Klemmhalter zum Plandrehen mit vierkantigen negativen Wendeschneidplatten.

Für Niederleistungsmaschinen und kleine Werkstücke, wählen Sie Klemmhalter Bez. CSKP (Seite: A118).

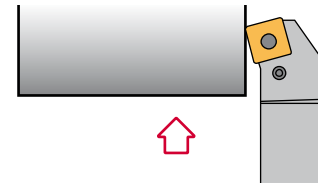

PSKN 75°

Reference Bezeichnung	h=h1	b	L1	L2	f	Insert size Wendeschneidplatte	KG
PSKN R/L 1616 H09	16	16	100	22	20	SNM.. 0903..	0,250
PSKN R/L 2020 K09	20	20	125	22	25	SNM.. 0903..	0,400
PSKN R/L 2020 K12	20	20	125	28	25	SNM.. 1204..	0,400
PSKN R/L 2525 M12	25	25	150	28	32	SNM.. 1204..	0,750
PSKN R/L 3225 P12	32	25	170	34	32	SNM.. 1204..	1,050
PSKN R/L 2525 M15	25	25	150	34	32	SNM.. 1506..	0,750
PSKN R/L 3232 P15	32	32	170	42	40	SNM.. 1506..	1,300
PSKN R/L 3232 P19	32	32	170	42	40	SNM.. 1906..	1,300
PSKN R/L 4040 S19	40	40	250	45	50	SNM.. 1906..	3,050
PSKN R/L 4040 S25	40	40	250	45	50	SNM.. 2507..	3,050
PSKN R/L 5050 T25	50	50	300	50	60	SNM.. 2507..	5,850

Reference Bezeichnung							Nm
PSKN R/L 1616 H09	8009	1606	5025	3509	4110	0009	2.0
PSKN R/L 2020 K09	8009	1606	5025	3509	4110	0009	2.0
PSKN R/L 2020 K12	8012	1608	5003	3512	4112	0012	3.0
PSKN R/L 2525 M12	8012	1608	5003	3512	4112	0012	3.0
PSKN R/L 3225 P12	8012	1608	5003	3512	4112	0012	3.0
PSKN R/L 2525 M15	8016	1618	5003	3515	4115	0015	3.0
PSKN R/L 3232 P15	8016	1618	5003	3515	4115	0015	3.0
PSKN R/L 3232 P19	8019	1610	5004	3519	4119	0019	3.5
PSKN R/L 4040 S19	8019	1610	5004	3519	4119	0019	3.5
PSKN R/L 4040 S25	8025	1612	5005	3525	4125	0025	4.0
PSKN R/L 5050 T25	8025	1612	5005	3525	4125	0025	4.0

SNM..

Square negative inserts.
Vierkantige negative Wendeschneidplatten. A41-42

Reference / Bez.	l	s	d
SNM.. 0903..	9,52	3,18	9,52
SNM.. 1204..	12,70	4,76	12,70
SNM.. 1506..	15,88	6,35	15,88
SNM.. 1906..	19,05	6,35	19,05
SNM.. 2507..	25,40	7,94	25,40

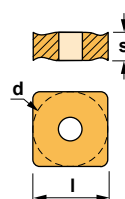

SNMG-FMC SNMG-KC SNMG-MHC



SNMG-RC SNMG-TC SNMM



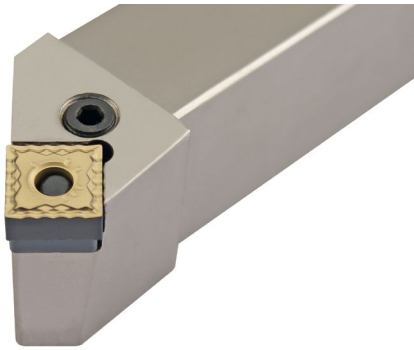

Characteristics: Toolholder for external turning and chamfering applications equipped with square negative inserts. For low powered machines and small pieces choose toolholder Ref. CSSP (Page: A119) or SSSC (Page: A145).

Axial -5,75°
Radial -5,75°

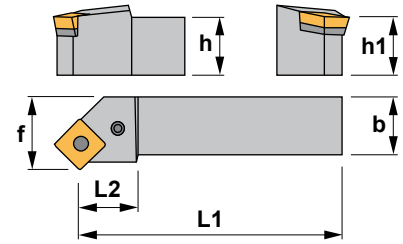

Eigenschaften: Klemmhalter zum Außendrehen und Abschrägen mit vierkantigen negativen Wendschneidplatten.

Für Niederleistungsmaschinen und kleine Werkstücke, wählen Sie Klemmhalter Bez. CSSP (Seite: A119) oder SSSC (Seite: A145).

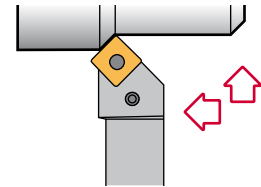

PSSN 45°

Reference Bezeichnung	h=h1	b	L1	L2	f	Insert size Wendschneidplatte	Kg
PSSN R/L 1616 H09	16	16	100	22	20	SNM.. 0903..	0,250
PSSN R/L 2020 K09	20	20	125	25	25	SNM.. 0903..	0,400
PSSN R/L 2020 K12	20	20	125	28	25	SNM.. 1204..	0,400
PSSN R/L 2525 M12	25	25	150	28	32	SNM.. 1204..	0,750
PSSN R/L 3225 P12	32	25	170	28	32	SNM.. 1204..	1,050
PSSN R/L 2525 M15	25	25	150	34	32	SNM.. 1506..	0,750
PSSN R/L 3225 P15	32	25	170	42	32	SNM.. 1506..	1,050
PSSN R/L 3232 P15	32	32	170	42	40	SNM.. 1506..	1,300
PSSN R/L 3232 P19	32	32	170	45	40	SNM.. 1906..	1,300
PSSN R/L 4040 S19	40	40	250	45	50	SNM.. 1906..	3,050
PSSN R/L 5050 T19	50	50	300	50	60	SNM.. 1906..	5,850
PSSN R/L 4040 S25	40	40	250	45	50	SNM.. 2507..	3,050
PSSN R/L 5050 T25	50	50	300	50	60	SNM.. 2507..	5,850

Reference Bezeichnung							Nm
PSSN R/L 1616 H09	8009	1606	5025	3509	4110	0009	2.0
PSSN R/L 2020 K09	8009	1606	5025	3509	4110	0009	2.0
PSSN R/L 2020 K12	8012	1608	5003	3512	4112	0012	3.0
PSSN R/L 2525 M12	8012	1608	5003	3512	4112	0012	3.0
PSSN R/L 3225 P12	8012	1608	5003	3512	4112	0012	3.0
PSSN R/L 2525 M15	8016	1618	5003	3515	4115	0015	3.0
PSSN R/L 3225 P15	8016	1618	5003	3515	4115	0015	3.0
PSSN R/L 3232 P15	8016	1618	5003	3515	4115	0015	3.0
PSSN R/L 3232 P19	8019	1610	5004	3519	4119	0019	3.5
PSSN R/L 4040 S19	8019	1610	5004	3519	4119	0019	3.5
PSSN R/L 5050 T19	8019	1610	5004	3519	4119	0019	3.5
PSSN R/L 4040 S25	8025	1612	5005	3525	4125	0025	4.0
PSSN R/L 5050 T25	8025	1612	5005	3525	4125	0025	4.0

SNM..

Square negative inserts.
Vierkantige negative Wendschneidplatten. A41-42

Reference / Bez.	l	s	d
SNM.. 0903..	9,52	3,18	9,52
SNM.. 1204..	12,70	4,76	12,70
SNM.. 1506..	15,88	6,35	15,88
SNM.. 1906..	19,05	6,35	19,05
SNM.. 2507..	25,40	7,94	25,40

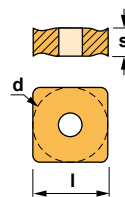

SNMG-FMC



SNMG-KC



SNMG-MHC



SNMG-RC



SNMG-TC



SNMM





Characteristics:

Toolholder for external turning and chamfering applications equipped with triangular negative inserts.

For low powered machines and small pieces choose toolholder Ref. CTD (Page: A124).

Axial -5°
Radial -5°

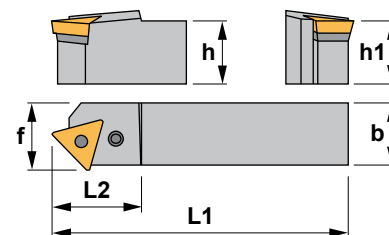

Eigenschaften:

Klemmhalter zum Außendrehen und Abschrägen mit dreikantigen negativen Wendeschneidplatten.

Für Niederleistungsmaschinen und kleine Werkstücke, wählen Sie Klemmhalter Bez. CTD (Seite: A124).

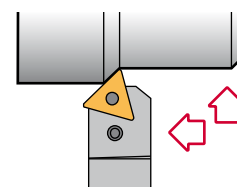

PTDN 45°

Reference Bezeichnung	h=h1	b	L1	L2	f	Insert size Wendeschneidplatte	KG
PTDN R/L 2525 M22	25	25	150	34	27	TNM.. 2204..	0,750
PTDN R/L 3225 P22	32	25	170	34	27	TNM.. 2204..	1,050

Reference Bezeichnung							Nm
PTDN R/L 2525 M22	8012	1608	5003	3422	4112	0012	3.0
PTDN R/L 3225 P22	8012	1608	5003	3422	4112	0012	3.0

TNM.. Triangular negative inserts. A45-46
Dreikantige negative Wendeschneidplatten.

Reference / Bez.	l	s	d
TNM.. 2204..	22,00	4,76	12,70

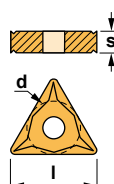



Characteristics:

Toolholder for face turning applications equipped with triangular negative inserts. For low powered machines and small pieces choose toolholder Ref. CTFP (Page: A125) or STFC (Page: A148).

Axial -6°
Radial -6°

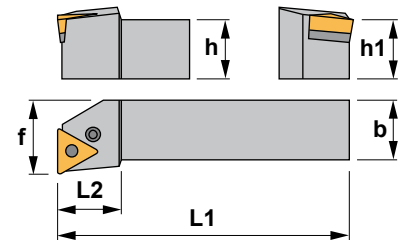

Eigenschaften:

Klemmhalter zum Plandrehen mit dreieckigen negativen Wendeschneidplatten.

Für Niederleistungsmaschinen und kleine Werkstücke, wählen Sie Klemmhalter Bez. CTFP (Seite: A125) oder STFC (Seite: A148).

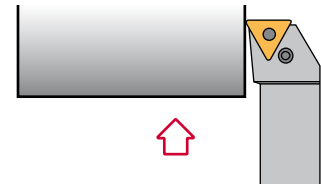

PTFN 90°

Reference Bezeichnung	h=h1	b	L1	L2	f	Insert size Wendeschneidplatte	
PTFN R/L 1616 H16	16	16	100	22	20	TNM.. 1604..	0,250
PTFN R/L 2020 K16	20	20	125	22	25	TNM.. 1604..	0,400
PTFN R/L 2525 M16	25	25	150	28	32	TNM.. 1604..	0,750
PTFN R/L 3225 P16	32	25	170	28	32	TNM.. 1604..	1,050
PTFN R/L 2525 M22	25	25	150	28	32	TNM.. 2204..	0,750
PTFN R/L 3225 P22	32	25	170	28	32	TNM.. 2204..	1,050
PTFN R/L 3232 P22	32	32	170	28	40	TNM.. 2204..	1,300
PTFN R/L 3232 P27	32	32	170	42	40	TNM.. 2706..	1,300
PTFN R/L 4040 S27	40	40	250	45	50	TNM.. 2706..	3,050

Reference Bezeichnung							Nm
PTFN R/L 1616 H16	8009	1606	5025	3416	4109	0009	2.0
PTFN R/L 2020 K16	8009	1606	5025	3416	4109	0009	2.0
PTFN R/L 2525 M16	8009	1606	5025	3416	4109	0009	2.0
PTFN R/L 3225 P16	8009	1606	5025	3416	4109	0009	2.0
PTFN R/L 2525 M22	8012	1608	5003	3422	4112	0012	3.0
PTFN R/L 3225 P22	8012	1608	5003	3422	4112	0012	3.0
PTFN R/L 3232 P22	8012	1608	5003	3422	4112	0012	3.0
PTFN R/L 3232 P27	8015	1708	5003	3427	4115	0015	3.0
PTFN R/L 4040 S27	8015	1708	5003	3427	4115	0015	3.0

TNM..

Triangular negative inserts.
Dreikantige negative WSP. A45-46

Reference / Bez.	l	s	d
TNM.. 1604..	16,50	4,76	9,52
TNM.. 2204..	22,00	4,76	12,70
TNM.. 2706..	27,50	6,35	15,88

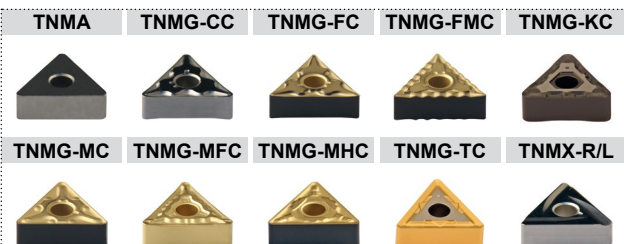
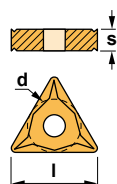



Characteristics:

Toolholder for external turning applications equipped with triangular negative inserts.

For low powered machines and small pieces choose toolholder Ref. CTGP (Page: A126) or STGC (Page: A149).

Axial -6°
Radial -6°

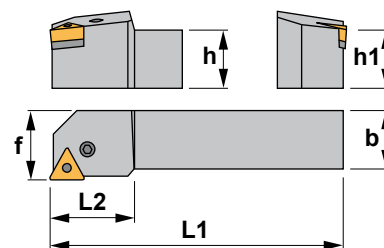

Eigenschaften:

Klemmhalter zum Außendrehen mit dreieckigen negativen Wendeschneidplatten.

Für Niederleistungsmaschinen und kleine Werkstücke, wählen Sie Klemmhalter Bez. CTGP (Seite: A126) oder STGC (Seite: A149).

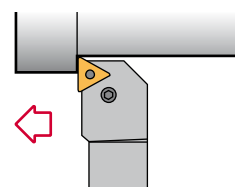

PTGN 90°

Reference Bezeichnung	h=h1	b	L1	L2	f	Insert size Wendeschneidplatte	⚖️
PTGN R/L 1616 H16	16	16	100	22	20	TNM.. 1604..	0,250
PTGN R/L 2020 K16	20	20	125	22	25	TNM.. 1604..	0,400
PTGN R/L 2525 M16	25	25	150	28	32	TNM.. 1604..	0,750
PTGN R/L 3225 P16	32	25	170	28	32	TNM.. 1604..	1,050
PTGN R/L 2525 M22	25	25	150	28	32	TNM.. 2204..	0,750
PTGN R/L 3225 P22	32	25	170	28	32	TNM.. 2204..	1,050
PTGN R/L 3232 P22	32	32	170	28	40	TNM.. 2204..	1,300
PTGN R/L 4040 S22	40	40	250	45	50	TNM.. 2204..	3,050
PTGN R/L 3232 P27	32	32	170	42	40	TNM.. 2706..	1,300
PTGN R/L 4040 S27	40	40	250	45	50	TNM.. 2706..	3,050
PTGN R/L 5050 T33	50	50	300	50	60	TNM.. 3307..	5,850

Reference Bezeichnung							Nm
PTGN R/L 1616 H16	8009	1606	5025	3416	4109	0009	2.0
PTGN R/L 2020 K16	8009	1606	5025	3416	4109	0009	2.0
PTGN R/L 2525 M16	8009	1606	5025	3416	4109	0009	2.0
PTGN R/L 3225 P16	8009	1606	5025	3416	4109	0009	2.0
PTGN R/L 2525 M22	8012	1608	5003	3422	4112	0012	3.0
PTGN R/L 3225 P22	8012	1608	5003	3422	4112	0012	3.0
PTGN R/L 3232 P22	8012	1608	5003	3422	4112	0012	3.0
PTGN R/L 4040 S22	8012	1608	5003	3422	4112	0012	3.0
PTGN R/L 3232 P27	8015	1708	5003	3427	4115	0015	3.0
PTGN R/L 4040 S27	8015	1708	5003	3427	4115	0015	3.0
PTGN R/L 5050 T33	8019	1610	5004	3433	4133	0019	3.5

TNM..

Triangular negative inserts.
Dreieckige negative WSP. **i** A45-46

Reference / Bez.	l	s	d
TNM.. 1604..	16,50	4,76	9,52
TNM.. 2204..	22,00	4,76	12,70
TNM.. 2706..	27,50	6,35	15,88
TNM.. 3307..	33,00	7,93	19,05

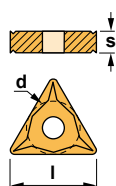



Characteristics: Toolholder for external turning and chamfering applications equipped with triangular negative inserts. For low powered machines and small pieces choose toolholder Ref. CTTT (Page: A127) or STTC (Page: A152).

Axial -8°
Radial -2,25°

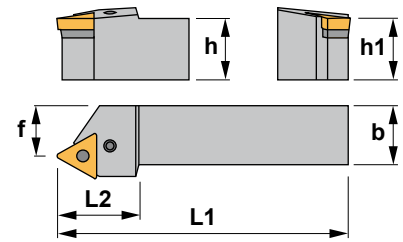

Eigenschaften:

Klemmhalter zum Außendrehen und Abschrägen mit dreieckigen negativen Wendeschneidplatten.
Für Niederleistungsmaschinen und kleine Werkstücke, wählen Sie Klemmhalter Bezeichnung CTTT (Seite: A127) oder STTC (Seite: A152).

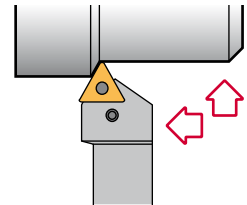

PTTN 60°

Reference Bezeichnung	h=h1	b	L1	L2	f	Insert size Wendeschneidplatte	
PTTN R/L 1616 H16	16	16	100	25	13	TNM.. 1604..	0,250
PTTN R/L 2020 K16	20	20	125	28	17	TNM.. 1604..	0,400
PTTN R/L 2525 M16	25	25	150	28	22	TNM.. 1604..	0,750
PTTN R/L 2525 M22	25	25	150	34	22	TNM.. 2204..	0,750
PTTN R/L 3225 P22	32	25	170	34	22	TNM.. 2204..	1,050

Reference Bezeichnung							Nm
PTTN R/L 1616 H16	8009	1606	5025	3416	4109	0009	2.0
PTTN R/L 2020 K16	8009	1606	5025	3416	4109	0009	2.0
PTTN R/L 2525 M16	8009	1606	5025	3416	4109	0009	2.0
PTTN R/L 2525 M22	8012	1608	5003	3422	4112	0012	3.0
PTTN R/L 3225 P22	8012	1608	5003	3422	4112	0012	3.0

TNM..

Triangular negative inserts.
Dreikantige negative WSP. A45-46

Reference / Bez.	l	s	d
TNM.. 1604..	16,50	4,76	9,52
TNM.. 2204..	22,00	4,76	12,70

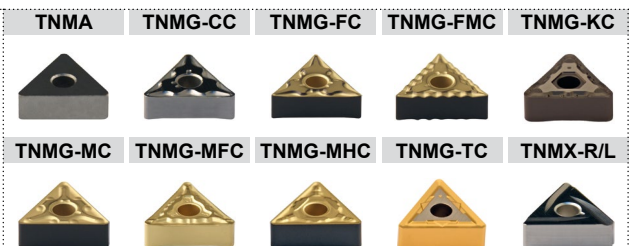
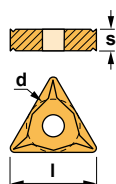

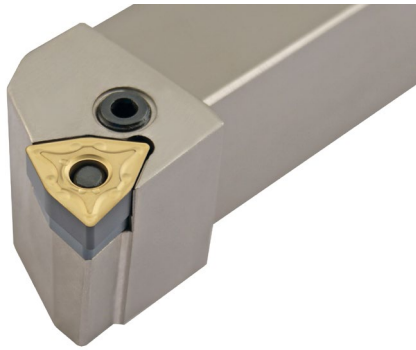

Characteristics:

Multipurpose toolholder equipped with trigon negative double-sided insert (angle 80°).
For top clamp toolholder see Ref. MWLN (Page: A92) or MWLN-K (Page: A93).

Axial -6°
Radial -6°

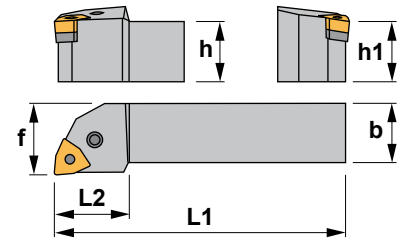

Eigenschaften:

Multifunktions-Klemmhalter mit doppelseitigen Trigon negativen Wendeschneidplatten (Winkel 80°).

Für Klemmhalter mit oberer Pratte siehe MWLN (Seite: A92) oder MWLN-K (Seite: A93).

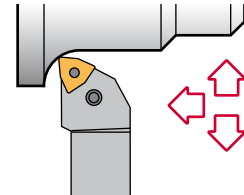

PWLN 95°

Reference Bezeichnung	h=h1	b	L1	L2	f	Insert size Wendeschneidplatte	
PWLN R/L 1616 H06	16	16	100	22	20	WNM.. 0604..	0,250
PWLN R/L 2020 K06	20	20	125	22	25	WNM.. 0604..	0,400
PWLN R/L 2525 M06	25	25	150	25	32	WNM.. 0604..	0,750
PWLN R/L 2020 K08	20	20	125	28	25	WNM.. 0804..	0,400
PWLN R/L 2525 M08	25	25	150	28	32	WNM.. 0804..	0,750
PWLN R/L 3225 P08	32	25	170	34	32	WNM.. 0804..	1,050
PWLN R/L 3232 P08	32	32	170	34	40	WNM.. 0804..	1,300

Reference Bezeichnung							Nm
PWLN R/L 1616 H06	8009	1606	5025	3007	4109	0009	2.0
PWLN R/L 2020 K06	8009	1606	5025	3007	4109	0009	2.0
PWLN R/L 2525 M06	8009	1606	5025	3007	4109	0009	2.0
PWLN R/L 2020 K08	8012	1608	5003	3008	4112	0012	3.0
PWLN R/L 2525 M08	8012	1608	5003	3008	4112	0012	3.0
PWLN R/L 3225 P08	8012	1608	5003	3008	4112	0012	3.0
PWLN R/L 3232 P08	8012	1608	5003	3008	4112	0012	3.0

WNMG

80° trigon negative inserts. A50-51
80° trigon negative Wendeschneidplatten.

Reference / Bez.	l	s	d
WNMG 0604..	6,45	4,76	9,52
WNMG 0804..	8,14	4,76	12,70

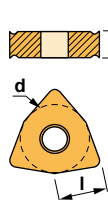

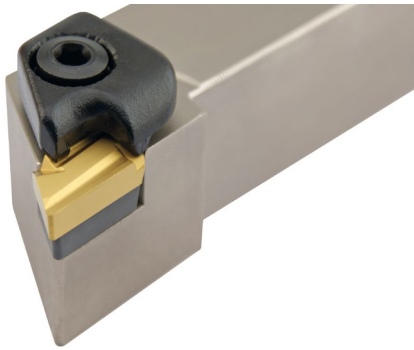

Characteristics:

Toolholder for turning and profiling operations equipped with KNUX negative insert.
For semi-finishing and finishing operations.

Axial 0°
Radial -6°

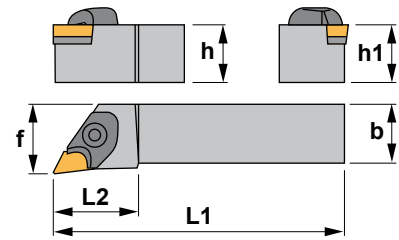

Eigenschaften:

Klemmhalter zum Plan- und Profildrehen mit negativen KNUX Wendeschneidplatten ausgerüstet, die wenig Schnittkraft erzeugen.
Zum Halbschlichten und Schlichten.

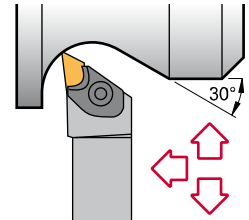

CKJN 93°

Reference Bezeichnung	h=h1	b	L1	L2	f	Insert size Wendeschneidplatte	Kg
CKJN R/L 2020 K16	20	20	125	34	30	KNUX 1604..	0,390
CKJN R/L 2525 M16	25	25	150	34	32	KNUX 1604..	0,700
CKJN R/L 3225 P16	32	25	170	34	32	KNUX 1604..	1,000
CKJN R/L 3232 P16	32	32	170	34	40	KNUX 1604..	1,250
CKJN R/L 4025 R16	40	25	200	38	32	KNUX 1604..	1,500

Reference Bezeichnung								Nm
CKJN R 2020 K16	2316	1614	5004	4295	4203	3226	4012	3.5
CKJN R 2525 M16	2316	1614	5004	4295	4204	3226	4012	3.5
CKJN R 3225 P16	2316	1614	5004	4295	4204	3226	4012	3.5
CKJN R 3232 P16	2316	1614	5004	4295	4204	3226	4012	3.5
CKJN R 4025 R16	2316	1614	5004	4295	4204	3226	4012	3.5
CKJN L 2020 K16	2326	1614	5004	4295	4203	3236	4012	3.5
CKJN L 2525 M16	2326	1614	5004	4295	4204	3236	4012	3.5
CKJN L 3225 P16	2326	1614	5004	4295	4204	3236	4012	3.5
CKJN L 3232 P16	2326	1614	5004	4295	4204	3236	4012	3.5
CKJN L 4025 R16	2326	1614	5004	4295	4204	3236	4012	3.5

KNUX

KNUX negative insert.
Negative KNUX Wendeschneidplatte. A38

Reference / Bezeichnung	l	s	d
KNUX 1604..	16,00	4,76	9,52

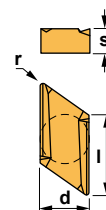

KNUX





Characteristics:

Toolholder for turning and profiling operations equipped with KNUX negative insert.
For semi-finishing and finishing operations.

Axial $-2,75^\circ$
Radial $-5,25^\circ$

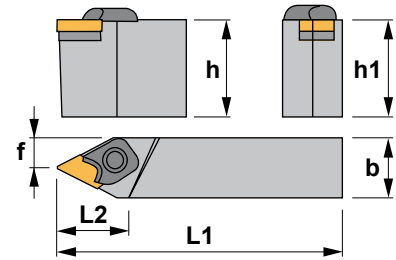

Eigenschaften:

Klemmhalter zum Plan- und Profildrehen mit negativen KNUX Wendeschneidplatten ausgerüstet, die wenig Schnittkraft erzeugen. Zum Halbschlichten und Schlichten.

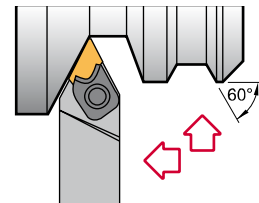

CKNN 63°

Reference Bezeichnung	h=h1	b	L1	L2	f	Insert size Wendeschneidplatte	
CKNN R/L 4025 R16	40	25	200	37	14,3	KNUX 1604..	1,500
CKNN R/L 5032 S16	50	32	250	37	16,8	KNUX 1604..	3,000

Reference Bezeichnung								Nm
CKNN R 4025 R16	2316	1614	5004	4295	4204	3226	4012	3.5
CKNN R 5032 S16	2316	1614	5004	4295	4204	3226	4012	3.5
CKNN L 4025 R16	2326	1614	5004	4295	4204	3236	4012	3.5
CKNN L 5032 S16	2326	1614	5004	4295	4204	3236	4012	3.5

KNUX

KNUX negative insert. A38
Negative KNUX Wendeschneidplatte.

Reference / Bezeichnung	l	s	d
KNUX 1604..	16,00	4,76	9,52

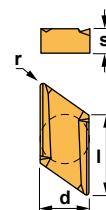

KNUX





Characteristics:

Toolholder for external turning applications equipped with square positive inserts.
For all kind of materials. The workpiece should be stable.

Axial 1,50°
Radial 5,75°

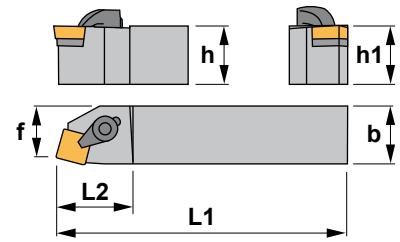

Eigenschaften:

Klemmhalter zum Außendrehen mit vierkantigen positiven Wendeschneidplatten.
Geeignet für alle Materialien. Das Werkstück muß stabil sein.

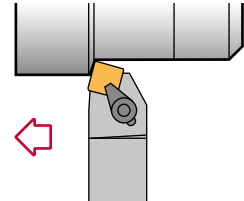

CSBP 75°

Reference Bezeichnung	h=h1	b	L1	L2	f	Insert size Wendeschneidplatte	KG
CSBP R/L 1212 F09	12	12	80	20	11	SP..0903..	0,070
CSBP R/L 1616 H09	16	16	100	22	13	SP..0903..	0,200
CSBP R/L 2020 K09	20	20	125	22	17	SP..0903..	0,400
CSBP R/L 2020 K12	20	20	125	34	17	SP..1203..	0,400
CSBP R/L 2525 M12	25	25	150	34	22	SP..1203..	0,700
CSBP R/L 3225 P12	32	25	170	34	22	SP..1203..	1,000
CSBP R/L 3232 P19	32	32	170	42	27	SP..1904..	1,250
CSBP R/L 4040 S19	40	40	250	48	35	SP..1904..	3,000
CSBP R/L 5050 T19	50	50	300	50	43	SP..1904..	5,650

Reference Bezeichnung					Nm
CSBP R/L 1212 F09	2207	5025	3109	4002	2.0
CSBP R/L 1616 H09	2207	5025	3109	4002	2.0
CSBP R/L 2020 K09	2207	5025	3109	4002	2.0
CSBP R/L 2020 K12	2209	5003	3112	4002	3.0
CSBP R/L 2525 M12	2209	5003	3112	4002	3.0
CSBP R/L 3225 P12	2209	5003	3112	4002	3.0
CSBP R/L 3232 P19	2211	5004	3119	4012	3.5
CSBP R/L 4040 S19	2211	5004	3119	4012	3.5
CSBP R/L 5050 T19	2211	5004	3119	4012	3.5

SP..

Square positive inserts with 11° clearance. A43
Vierkantige positive Wendeschneidplatten mit 11° Freiwinkel.

Reference / Bezeichnung	l	s	d
SP.. 0903..	9,52	3,18	9,52
SP.. 1203..	12,70	3,18	12,70
SP.. 1904..	19,05	4,76	19,05

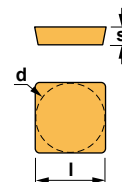

SPMR



SPUN



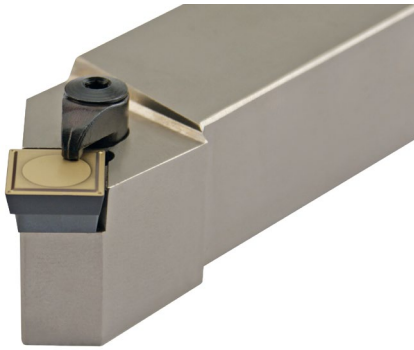

Characteristics:

Toolholder for external turning applications equipped with square positive inserts.
For interrupted cut choose toolholder Ref. PSDN (Page: A106).

Axial 4,25°
Radial 4,25°

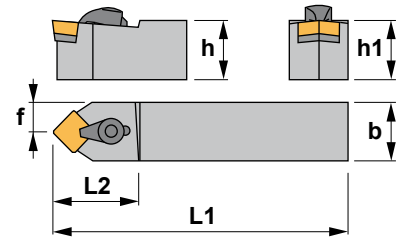

Eigenschaften:

Klemmhalter zum Außendreihen und Abschrägen mit vierkantigen positiven Wendeschneidplatten.

Für unterbrochenen Schnitt wählen Sie Klemmhalter PSDN (Seite: A106).

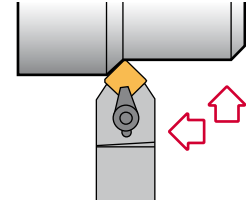

CSDP 45°

Reference Bezeichnung	h=h1	b	L1	L2	f	Insert size Wendeschneidplatte	kg
CSDP R/L 1010 E09	10	10	70	22	5,6	SP.. 0903..	0,030
CSDP R/L 1212 F09	12	12	80	22	7,6	SP.. 0903..	0,070
CSDP R/L 1616 H09	16	16	100	22	11,6	SP.. 0903..	0,200
CSDP R/L 2020 K12	20	20	125	28	14,0	SP.. 1203..	0,400
CSDP R/L 2525 M12	25	25	150	28	19,0	SP.. 1203..	0,700
CSDP N 1010 E09	10	10	70	22	5,0	SP.. 0903..	0,030
CSDP N 1212 F09	12	12	80	22	6,0	SP.. 0903..	0,070
CSDP N 1616 H09	16	16	100	22	8,0	SP.. 0903..	0,200
CSDP N 2020 K12	20	20	125	28	10,0	SP.. 1203..	0,400
CSDP N 2525 M12	25	25	150	28	12,5	SP.. 1203..	0,700

Reference Bezeichnung					Nm
CSDP R/L 1010 E09	2107	5025	-	-	2.0
CSDP R/L 1212 F09	2207	5025	3109	4002	2.0
CSDP R/L 1616 H09	2207	5025	3109	4002	2.0
CSDP R/L 2020 K12	2209	5003	3112	4002	3.0
CSDP R/L 2525 M12	2209	5003	3112	4002	3.0
CSDP N 1010 E09	2107	5025	-	-	2.0
CSDP N 1212 F09	2207	5025	3109	4002	2.0
CSDP N 1616 H09	2207	5025	3109	4002	2.0
CSDP N 2020 K12	2209	5003	3112	4002	3.0
CSDP N 2525 M12	2209	5003	3112	4002	3.0

SP..

Square positive inserts with 11° clearance. A43
Vierkantige positive Wendeschneidplatten mit 11° Freiwinkel.

Reference / Bezeichnung	l	s	d
SP.. 0903..	9,52	3,18	9,52
SP.. 1203..	12,70	3,18	12,70

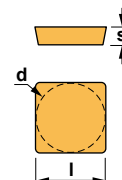

SPMR



SPUN





Characteristics:

Toolholder for face turning applications equipped with square positive inserts.
For interrupted cut choose toolholder Ref. PSKN (Page: A107).

Axial 5,75°
Radial 1,5°

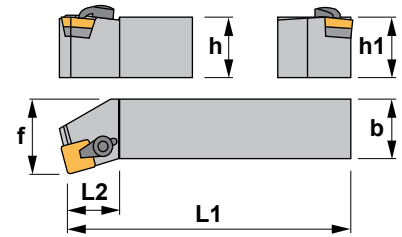

Eigenschaften:

Klemmhalter zum Plandrehen mit vierkantigen positiven Wendeschneidplatten.
Für unterbrochenen Schnitt wählen Sie Klemmhalter PSKN (Seite: A107).

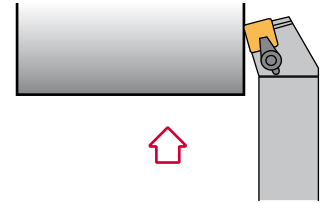

CSKP 75°

Reference Bezeichnung	h=h1	b	L1	L2	f	Insert size Wendeschneidplatte	Kg
CSKP R/L 1212 F09	12	12	80	18	16	SP..0903..	0,070
CSKP R/L 1616 H09	16	16	100	22	20	SP..0903..	0,200
CSKP R/L 2020 K09	20	20	125	25	25	SP..0903..	0,400
CSKP R/L 2020 K12	20	20	125	28	25	SP..1203..	0,400
CSKP R/L 2525 M12	25	25	150	28	32	SP..1203..	0,700
CSKP R/L 3225 P12	32	25	170	34	32	SP..1203..	1,000
CSKP R/L 3232 P19	32	32	170	42	40	SP..1904..	1,250
CSKP R/L 4040 S19	40	40	250	42	50	SP..1904..	3,000
CSKP R/L 5050 T19	50	50	300	50	60	SP..1904..	5,650

Reference Bezeichnung					Nm
CSKP R/L 1212 F09	2207	5025	3109	4002	2.0
CSKP R/L 1616 H09	2207	5025	3109	4002	2.0
CSKP R/L 2020 K09	2207	5025	3109	4002	2.0
CSKP R/L 2020 K12	2209	5003	3112	4002	3.0
CSKP R/L 2525 M12	2209	5003	3112	4002	3.0
CSKP R/L 3225 P12	2209	5003	3112	4002	3.0
CSKP R/L 3232 P19	2211	5004	3119	4012	3.5
CSKP R/L 4040 S19	2211	5004	3119	4012	3.5
CSKP R/L 5050 T19	2211	5004	3119	4012	3.5

SP..

Square positive inserts with 11° clearance. A43
Vierkantige positive Wendeschneidplatten mit 11° Freiwinkel.

Reference / Bezeichnung	l	s	d
SP.. 0903..	9,52	3,18	9,52
SP.. 1203..	12,70	3,18	12,70
SP.. 1904..	19,05	4,76	19,05

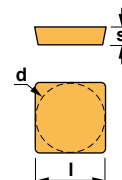

SPMR



SPUN



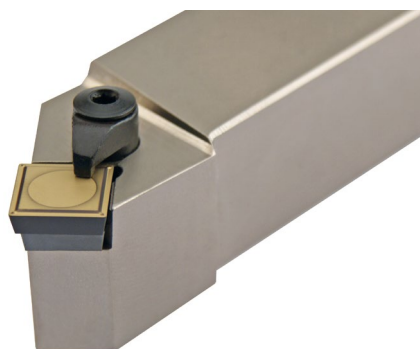

Characteristics:

Toolholder for external turning and chamfering applications equipped with square positive inserts.

For interrupted cut choose toolholder Ref. PSSN (Page: A108).

Axial 4,25°
Radial 4,25°

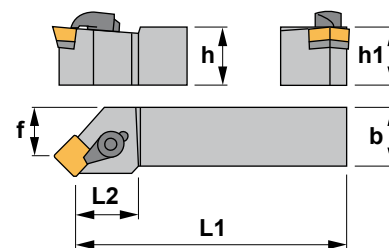

Eigenschaften:

Klemmhalter zum Außendreien und Abschrägen mit vierkantigen positiven Wendeschneidplatten.

Für unterbrochenen Schnitt wählen Sie Klemmhalter PSSN (Seite: A108).

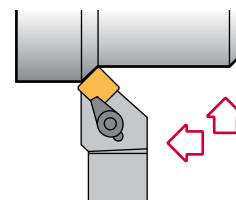

CSSP 45°

Reference Bezeichnung	h=h1	b	L1	L2	f	Insert size Wendeschneidplatte	Kg
CSSP R/L 1212 F09	12	12	80	20	16	SP.. 0903..	0,070
CSSP R/L 1616 H09	16	16	100	22	20	SP.. 0903..	0,200
CSSP R/L 2020 K12	20	20	125	25	25	SP.. 1203..	0,400
CSSP R/L 2525 M12	25	25	150	28	32	SP.. 1203..	0,700
CSSP R/L 3225 P12	32	25	170	28	32	SP.. 1203..	1,000
CSSP R/L 3232 P19	32	32	170	42	40	SP.. 1904..	1,250
CSSP R/L 4040 S19	40	40	250	42	50	SP.. 1904..	3,000

Reference Bezeichnung					Nm
CSSP R/L 1212 F09	2207	5025	3109	4002	2.0
CSSP R/L 1616 H09	2207	5025	3109	4002	2.0
CSSP R/L 2020 K12	2209	5003	3112	4002	3.0
CSSP R/L 2525 M12	2209	5003	3112	4002	3.0
CSSP R/L 3225 P12	2209	5003	3112	4002	3.0
CSSP R/L 3232 P19	2211	5004	3119	4012	3.5
CSSP R/L 4040 S19	2211	5004	3119	4012	3.5

SP..

Square positive inserts with 11° clearance. A43
Vierkantige positive Wendeschneidplatten mit 11° Freiwinkel.

Reference / Bezeichnung	l	s	d
SP.. 0903..	9,52	3,18	9,52
SP.. 1203..	12,70	3,18	12,70
SP.. 1904..	19,05	4,76	19,05

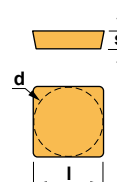

SPMR



SPUN





Characteristics:

Toolholder for external turning applications equipped with square positive inserts.
For interrupted cut choose toolholder Ref. PSBN (Page: A105).

Axial 3°
Radial 5,25°

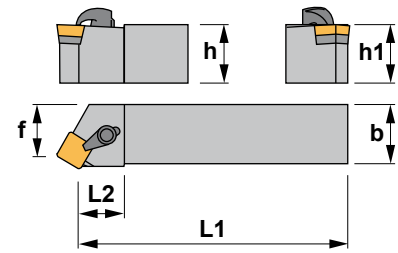

Eigenschaften:

Klemmhalter zum Außendreien mit vierkantigen positiven Wendeschneidplatten.
Für unterbrochenen Schnitt wählen Sie Klemmhalter PSBN (Seite: A105).

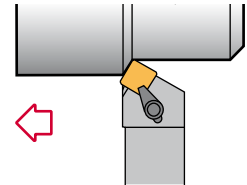

CSTP 60°

Reference Bezeichnung	h=h1	b	L1	L2	f	Insert size Wendeschneidplatte	Kg
CSTP R/L 1616 H09	16	16	100	22	13	SP..0903..	0,200
CSTP R/L 2020 K09	20	20	125	28	17	SP..0903..	0,350
CSTP R/L 2020 K12	20	20	125	28	17	SP..1203..	0,400
CSTP R/L 2525 M12	25	25	150	28	22	SP..1203..	0,700

Reference Bezeichnung					Nm
CSTP R/L 1616 H09	2207	5025	3109	4002	2.0
CSTP R/L 2020 K09	2207	5025	3109	4002	2.0
CSTP R/L 2020 K12	2209	5003	3112	4002	3.0
CSTP R/L 2525 M12	2209	5003	3112	4002	3.0

SP..

Square positive inserts with 11° clearance. A43
Vierkantige positive Wendeschneidplatten mit 11° Freiwinkel.

Reference / Bezeichnung	l	s	d
SP.. 0903..	9,52	3,18	9,52
SP.. 1203..	12,70	3,18	12,70

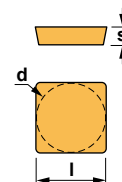

SPMR



SPUN



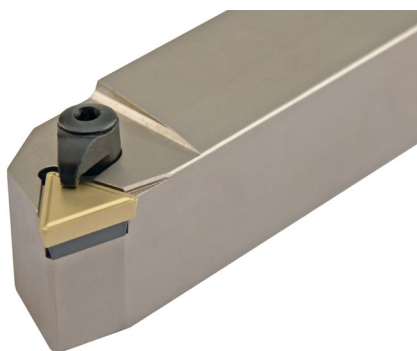

Characteristics:

Toolholder for external turning applications equipped with triangular positive inserts. For all kind of materials. The workpiece should be stable.

Axial 1,5°
Radial 5,75°

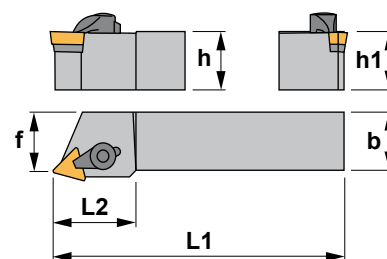

Eigenschaften:

Klemmhalter zum Außendreien mit dreikantigen positiven Wendeschneidplatten. Geeignet für alle Materialien. Das Werkstück muß stabil sein.

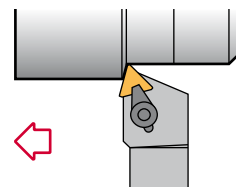

CTBP 75°

Reference Bezeichnung	h=h1	b	L1	L2	f	Insert size Wendeschneidplatte	kg
CTBP R/L 1212 F11	12	12	80	20	11	TP.. 1103..	0,070
CTBP R/L 1616 H11	16	16	100	22	13	TP.. 1103..	0,200
CTBP R/L 2020 K16	20	20	125	28	17	TP.. 1603..	0,400
CTBP R/L 2525 M16	25	25	150	28	22	TP.. 1603..	0,700

Reference Bezeichnung					Nm
CTBP R/L 1212 F11	2207	5025	-	-	2.0
CTBP R/L 1616 H11	2207	5025	-	-	2.0
CTBP R/L 2020 K16	2209	5003	3116	4002	3.0
CTBP R/L 2525 M16	2209	5003	3116	4002	3.0

TP.. Triangular positive inserts with 11° clearance. A47
Dreikantige positive Wendeschneidplatten mit 11° Freiwinkel.

Reference / Bez.	l	s	d
TP.. 1103..	11,00	3,18	6,35
TP.. 1603..	16,50	3,18	9,52

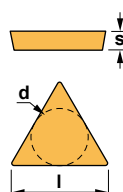

TPMN	TPMR	TPUN
TPUX-R	TPUX-L	

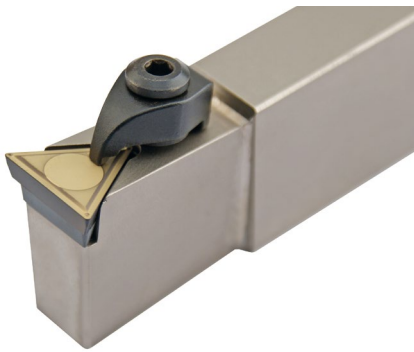

Characteristics:

Toolholder for face turning and grooving applications equipped with triangular positive inserts.

For all kind of materials. The workpiece should be stable.

Axial 6°
Radial 0°

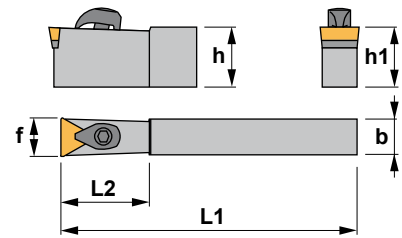

Eigenschaften:

Klemmhalter zum Plandrehen und Einstechen mit dreikantigen positiven Wendeschneidplatten.

Geeignet für alle Materialien. Das Werkstück muß stabil sein.

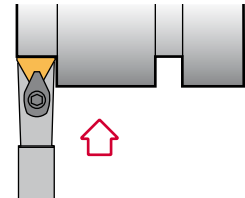

CTCPN 90°

Reference Bezeichnung	h=h1	b	L1	L2	f	Insert size Wendeschneidplatte	Kg
CTCP N 1009 E11	10	9	70	22	11	TP.. 1103..	0,040
CTCP N 2009 K11	20	9	125	22	11	TP.. 1103..	0,150
CTCP N 2509 R11	25	9	200	22	11	TP.. 1103..	0,350
CTCP N 2513 R16	25	13	200	28	16	TP.. 1603..	0,500
CTCP N 2518 R22	25	18	200	34	22	TP.. 2204..	0,650
CTCP N 4018 R22	40	18	200	34	22	TP.. 2204..	1,100

Reference Bezeichnung					Nm
CTCP N 1009 E11	2304	5025	-	-	2.0
CTCP N 2009 K11	2304	5025	-	-	2.0
CTCP N 2509 R11	2304	5025	-	-	2.0
CTCP N 2513 R16	2305	5003	3116	4002	3.0
CTCP N 2518 R22	2211	5004	3122	4012	3.5
CTCP N 4018 R22	2211	5004	3122	4012	3.5

TP.. Triangular positive inserts with 11° clearance. A47
Dreikantige positive Wendeschneidplatten mit 11° Freiwinkel.

Reference / Bez.	l	s	d
TP.. 1103..	11,00	3,18	6,35
TP.. 1603..	16,50	3,18	9,52
TP.. 2204..	22,00	4,76	12,70

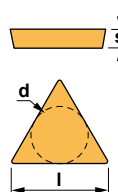

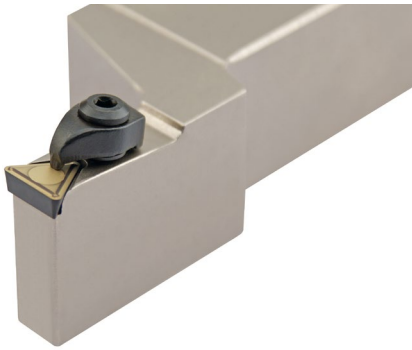

Characteristics:

Toolholder for face turning and grooving applications equipped with triangular positive inserts.

For all kind of materials. The workpiece should be stable.

Axial 6°
Radial 0°

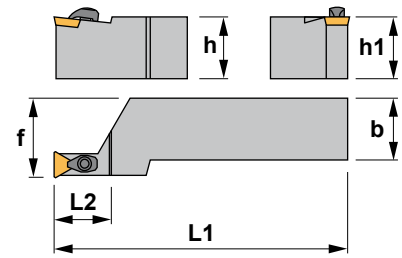

Eigenschaften:

Klemhalter zum Plandrehen und Einstechen mit dreikantigen positiven Wendeschneidplatten.

Geeignet für alle Materialien. Das Werkstück muß stabil sein.

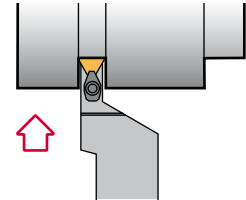

CTCP 90°

Reference Bezeichnung	h=h1	b	L1	L2	f	Insert size Wendeschneidplatte	Kg
CTCP R/L 1212 F11	12	12	80	22	16	TP.. 1103..	0,070
CTCP R/L 1616 H11	16	16	100	22	20	TP.. 1103..	0,200
CTCP R/L 2020 K11	20	20	125	22	25	TP.. 1103..	0,400
CTCP R/L 2525 M11	25	25	150	22	32	TP.. 1103..	0,700
CTCP R/L 3225 P16	32	25	170	28	32	TP.. 1603..	1,000
CTCP R/L 3232 P16	32	32	170	28	40	TP.. 1603..	1,250
CTCP R/L 3225 P22	32	25	170	34	32	TP.. 2204..	1,000
CTCP R/L 3232 P22	32	32	170	34	40	TP.. 2204..	1,250

Reference Bezeichnung					Nm
CTCP R/L 1212 F11	2304	5025	-	-	2.0
CTCP R/L 1616 H11	2304	5025	-	-	2.0
CTCP R/L 2020 K11	2304	5025	-	-	2.0
CTCP R/L 2525 M11	2304	5025	-	-	2.0
CTCP R/L 3225 P16	2305	5003	3116	4002	3.0
CTCP R/L 3232 P16	2305	5003	3116	4002	3.0
CTCP R/L 3225 P22	2211	5004	3122	4012	3.5
CTCP R/L 3232 P22	2211	5004	3122	4012	3.5

TP.. Triangular positive inserts with 11° clearance. A47
Dreikantige positive Wendeschneidplatten mit 11° Freiwinkel.

Reference / Bez.	l	s	d
TP.. 1103..	11,00	3,18	6,35
TP.. 1603..	16,50	3,18	9,52
TP.. 2204..	22,00	4,76	12,70

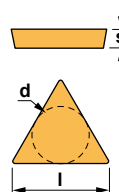



Characteristics:

Toolholder for external turning and chamfering turning applications equipped with triangular positive inserts. For interrupted cut choose toolholder Ref. PTDN (Page: A109).

Axial 4,25°
Radial 4,25°

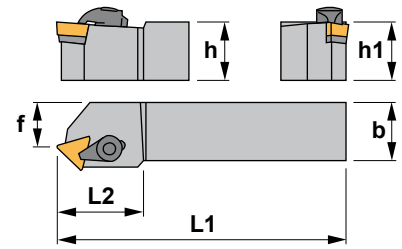

Eigenschaften:

Klemmhalter zum Außendreien und Abschrägen mit dreikantigen positiven Wendeschneidplatten.

Für unterbrochenen Schnitt wählen Sie Klemmhalter PTDN (Seite: A109).

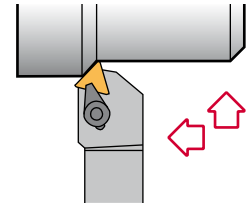

CTDP 45°

Reference Bezeichnung	h=h1	b	L1	L2	f	Insert size Wendeschneidplatte	Kg
CTDP R/L 1212 F11	12	12	80	20	6,3	TP.. 1103..	0,070
CTDP R/L 1616 H11	16	16	100	22	10,3	TP.. 1103..	0,200
CTDP R/L 2020 K16	20	20	125	28	12,2	TP.. 1603..	0,400
CTDP R/L 2525 M16	25	25	150	28	17,2	TP.. 1603..	0,700
CTDP R/L 3232 P16	32	32	170	28	23,5	TP.. 1603..	1,250
CTDP R/L 3232 P22	32	32	170	34	20,5	TP.. 2204..	1,250

Reference Bezeichnung						Nm
CTDP R/L 1212 F11	2207	5025	-	-	-	2.0
CTDP R/L 1616 H11	2207	5025	-	-	-	2.0
CTDP R/L 2020 K16	2209	5003	3116	4002	-	3.0
CTDP R/L 2525 M16	2209	5003	3116	4002	-	3.0
CTDP R/L 3232 P16	2209	5003	3116	4002	-	3.0
CTDP R/L 3232 P22	2211	5004	3122	4012	-	3.5

TP.. Triangular positive inserts with 11° clearance. A47
Dreikantige positive Wendeschneidplatten mit 11° Freiwinkel.

Reference / Bez.	l	s	d
TP.. 1103..	11,00	3,18	6,35
TP.. 1603..	16,50	3,18	9,52
TP.. 2204..	22,00	4,76	12,70

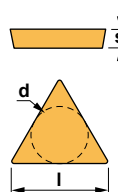



Characteristics:

Toolholder for face turning applications equipped with triangular positive inserts. For interrupted cut choose toolholder Ref. PTFN (Page: A110).

Axial 6°
Radial 0°

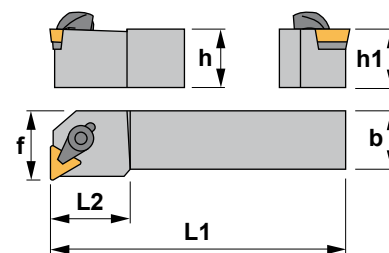

Eigenschaften:

Klemmhalter zum Plandrehen mit dreikantigen positiven Wendeschneidplatten. Für unterbrochenen Schnitt wählen Sie Klemmhalter PTFN (Seite: A110).



CTFP 90°

Reference Bezeichnung	h=h1	b	L1	L2	f	Insert size Wendeschneidplatte	KG
CTFP R/L 1010 E11	10	10	70	14	12	TP.. 1103..	0,030
CTFP R/L 1212 F11	12	12	80	20	16	TP.. 1103..	0,070
CTFP R/L 1616 H11	16	16	100	22	20	TP.. 1103..	0,200
CTFP R/L 2020 K11	20	20	125	22	25	TP.. 1103..	0,400
CTFP R/L 2020 K16	20	20	125	22	25	TP.. 1603..	0,400
CTFP R/L 2525 M16	25	25	150	25	32	TP.. 1603..	0,700
CTFP R/L 3225 P16	32	25	170	34	32	TP.. 1603..	1,000
CTFP R/L 3232 P16	32	32	170	34	40	TP.. 1603..	1,250
CTFP R/L 4040 S16	40	40	250	45	50	TP.. 1603..	3,000
CTFP R/L 5050 T16	50	50	300	50	60	TP.. 1603..	5,650
CTFP R/L 3232 P22	32	32	170	34	40	TP.. 2204..	1,250
CTFP R/L 4040 S22	40	40	250	45	50	TP.. 2204..	3,000
CTFP R/L 5050 T22	50	50	300	50	60	TP.. 2204..	5,650

Reference Bezeichnung					Nm
CTFP R/L 1010 E11	2000	5015	-	-	0.6
CTFP R/L 1212 F11	2207	5025	-	-	2.0
CTFP R/L 1616 H11	2207	5025	-	-	2.0
CTFP R/L 2020 K11	2207	5025	-	-	2.0
CTFP R/L 2020 K16	2209	5003	3116	4002	3.0
CTFP R/L 2525 M16	2209	5003	3116	4002	3.0
CTFP R/L 3225 P16	2209	5003	3116	4002	3.0
CTFP R/L 3232 P16	2209	5003	3116	4002	3.0
CTFP R/L 4040 S16	2209	5003	3116	4002	3.0
CTFP R/L 5050 T16	2209	5003	3116	4002	3.0
CTFP R/L 3232 P22	2211	5004	3122	4012	3.5
CTFP R/L 4040 S22	2211	5004	3122	4012	3.5
CTFP R/L 5050 T22	2211	5004	3122	4012	3.5

TP.. Triangular positive inserts with 11° clearance. Dreikantige positive Wendeschneidplatten mit 11° Freiwinkel. A47

Reference / Bez.	l	s	d
TP.. 1103..	11,00	3,18	6,35
TP.. 1603..	16,50	3,18	9,52
TP.. 2204..	22,00	4,76	12,70

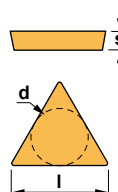

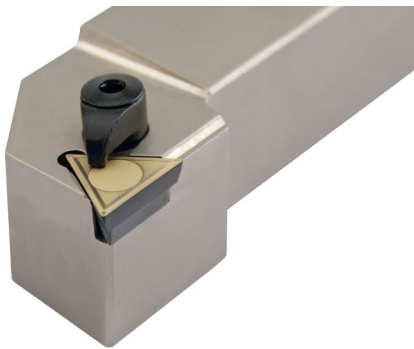

Characteristics:

Toolholder for external turning applications equipped with triangular positive inserts. For interrupted cut choose toolholder Ref. PTGN (Page: A111).

Axial 0°
Radial 6°

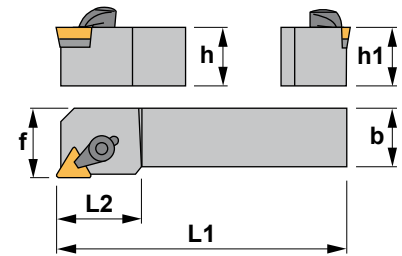

Eigenschaften:

Klemmhalter zum Außendrehen mit dreieckigen positiven Wendeschneidplatten. Für unterbrochenen Schnitt wählen Sie Klemmhalter PTGN (Seite: A111).

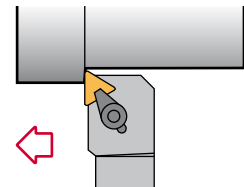

CTGP 90°

Reference Bezeichnung	h=h1	b	L1	L2	f	Insert size Wendeschneidplatte	Kg
CTGP R/L 1010 E11	10	10	70	16	12	TP.. 1103..	0,030
CTGP R/L 1212 F11	12	12	80	18	16	TP.. 1103..	0,070
CTGP R/L 1616 H11	16	16	100	18	20	TP.. 1103..	0,200
CTGP R/L 2020 K11	20	20	125	22	25	TP.. 1103..	0,400
CTGP R/L 2020 K16	20	20	125	28	25	TP.. 1603..	0,400
CTGP R/L 2525 M16	25	25	150	28	32	TP.. 1603..	0,700
CTGP R/L 3225 P16	32	25	170	34	32	TP.. 2204..	1,000
CTGP R/L 3232 P22	32	32	170	34	40	TP.. 2204..	1,250
CTGP R/L 4040 S22	40	40	250	45	50	TP.. 2204..	3,000
CTGP R/L 5050 T22	50	50	300	50	60	TP.. 2204..	5,650

Reference Bezeichnung					Nm
CTGP R/L 1010 E11	2000	5015	-	-	0.6
CTGP R/L 1212 F11	2207	5025	-	-	2.0
CTGP R/L 1616 H11	2207	5025	-	-	2.0
CTGP R/L 2020 K11	2207	5025	-	-	2.0
CTGP R/L 2020 K16	2209	5003	3116	4002	3.0
CTGP R/L 2525 M16	2209	5003	3116	4002	3.0
CTGP R/L 3225 P16	2209	5003	3116	4002	3.0
CTGP R/L 3232 P22	2211	5004	3122	4012	3.5
CTGP R/L 4040 S22	2211	5004	3122	4012	3.5
CTGP R/L 5050 T22	2211	5004	3122	4012	3.5

TP.. Triangular positive inserts with 11° clearance. A47
Dreieckige positive Wendeschneidplatten mit 11° Freiwinkel.

Reference / Bez.	l	s	d
TP.. 1103..	11,00	3,18	6,35
TP.. 1603..	16,50	3,18	9,52
TP.. 2204..	22,00	4,76	12,70

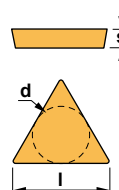

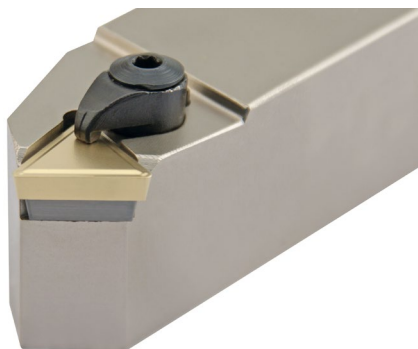

Characteristics:

Toolholder for external turning and chamfering turning applications equipped with triangular positive inserts.

For interrupted cut choose toolholder Ref. PTTN (Page: A112).

Axial 3°
Radial 5,25°

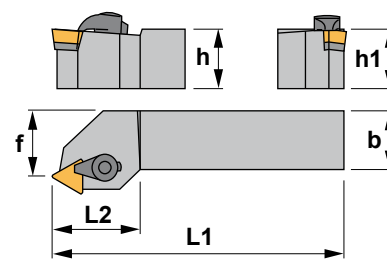

Eigenschaften:

Klemmhalter zum Außendrehen und Abschrägen mit dreikantigen positiven Wendeschneidplatten.

Für unterbrochenen Schnitt wählen Sie Klemmhalter PTTN (Seite: A112).

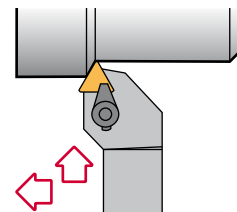

CTTP 60°

Reference Bezeichnung	h=h1	b	L1	L2	f	Insert size Wendeschneidplatte	Kg
CTTP R/L 0808 D09	8	8	60	16	7	TP.. 0902..	0,020
CTTP R/L 1010 E09	10	10	70	16	9	TP.. 0902..	0,030
CTTP R/L 1010 E11	10	10	70	16	9	TP.. 1103..	0,030
CTTP R/L 1212 F11	12	12	80	20	11	TP.. 1103..	0,070
CTTP R/L 1616 H11	16	16	100	22	13	TP.. 1103..	0,200
CTTP R/L 2020 K11	20	20	125	22	17	TP.. 1103..	0,400
CTTP R/L 2020 K16	20	20	125	28	17	TP.. 1603..	0,400
CTTP R/L 2525 M16	25	25	150	28	22	TP.. 1603..	0,700

Reference Bezeichnung					Nm
CTTP R/L 0808 D09	2000	5015	-	-	0.6
CTTP R/L 1010 E09	2000	5015	-	-	0.6
CTTP R/L 1010 E11	2000	5015	-	-	0.6
CTTP R/L 1212 F11	2207	5025	-	-	2.0
CTTP R/L 1616 H11	2207	5025	-	-	2.0
CTTP R/L 2020 K11	2207	5025	-	-	2.0
CTTP R/L 2020 K16	2209	5003	3116	4002	3.0
CTTP R/L 2525 M16	2209	5003	3116	4002	3.0

TP.. Triangular positive inserts with 11° clearance. A47
Dreikantige positive Wendeschneidplatten mit 11° Freiwinkel.

Reference / Bez.	l	s	d
TP.. 0902..	9,62	2,38	5,55
TP.. 1103..	11,00	3,18	6,35
TP.. 1603..	16,50	3,18	9,52

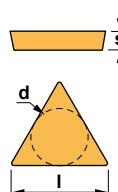

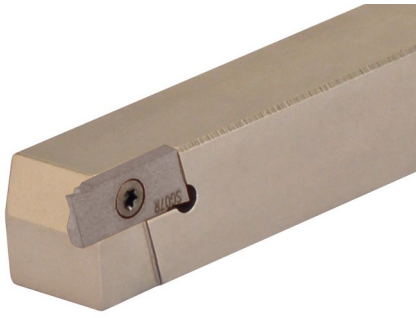

Characteristics:
Multipurpose mini-toolholders for grooving, threading and turning. For precision turning.

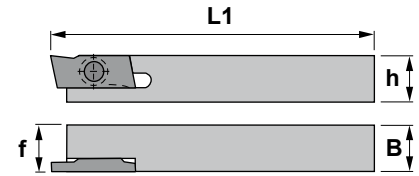

Eigenschaften:
Multifunktions-Mini-Klemmhalter zum Nuteinstecken, Gewindedrehen und Drehen. Zum Präzisionsdrehen.

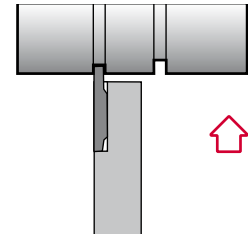

STHE

Reference Bezeichnung	h	h1	B	L	f	Insert size Wendschneidplatte	kg
STHER/L0808M07	8	8	8	150	8	Gl..	0,070
STHER/L1010M07	10	10	10	150	10	Gl..	0,110
STHER/L1212M07	12	12	12	150	12	Gl..	0,150
STHER/L1616M07	16	16	16	150	16	Gl..	0,280

Reference Bezeichnung			Nm
STHER/L0808M07	1230	5508	1.2
STHER/L1010M07	1230	5508	1.2
STHER/L1212M07	1230	5508	1.2
STHER/L1616M07	1230	5508	1.2

GI

B06

Reference / Bez.	l	s	d
Gl..	17,00	2,00	7,00

GIGP - Grooving and cut-off inserts
GIGW - Threading inserts
GISG - Grooving inserts
GIST - Turning inserts

GIGP - Ein- und Abstechplatten
GIGW - Gewindedrehplatten
GISG - Stechdrehplatten
GIST - Drehplatten

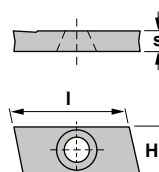

GIGP

GIGW



GISG

GIST



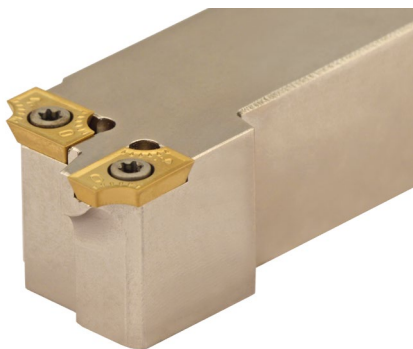

Characteristics:
Toolholder for turning convex radius on internal and external diameters in manual machines.

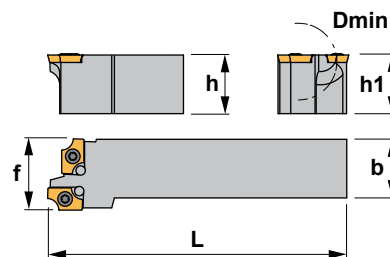

Eigenschaften:
Werkzeug um konvexen Radien in Innen- und Aussendurchmessern bei manuellen Maschinen zu drehen.

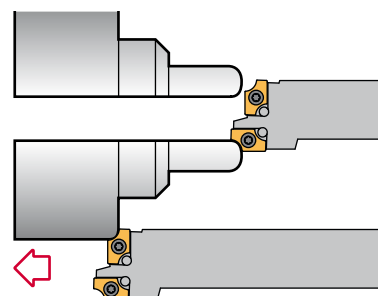

SAGD 90°

Reference Bezeichnung	h=h1	b	L	f	Dmin	Insert size Wendeschneidplatte	KG
SAGD R 1616 H15	16	16	100	30	20	ADMT 1503..	0,260
SAGD R 2020 K15	20	20	125	30	20	ADMT 1503..	0,450
SAGD R 2525 M15	25	25	150	30	20	ADMT 1503..	0,650

Reference Bezeichnung			Nm
SAGD R 1616 H15	1240	5515	3.0
SAGD R 2020 K15	1240	5515	3.0
SAGD R 2525 M15	1240	5515	3.0

ADMT-R

Parallelogram positive inserts with 15° clearance.
Parallelogramme positive WSP mit 15° Freiwinkel. A30

Reference / Bezeichnung	r	s	d
ADMT 1503R1.0	1.0	3,18	9,52
ADMT 1503R1.5	1.5	3,18	9,52
ADMT 1503R2.0	2.0	3,18	9,52
ADMT 1503R2.5	2.5	3,18	9,52
ADMT 1503R3.0	3.0	3,18	9,52
ADMT 1503R3.5	3.5	3,18	9,52
ADMT 1503R4.0	4.0	3,18	9,52
ADMT 1503R4.5	4.5	3,18	9,52
ADMT 1503R5.0	5.0	3,18	9,52

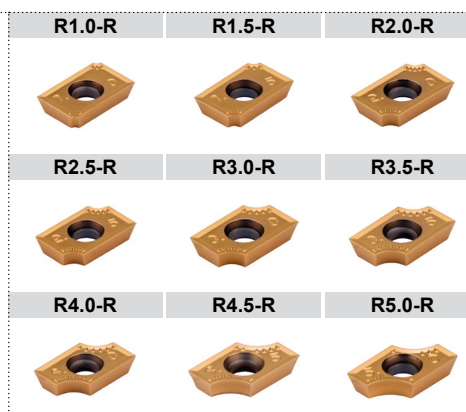
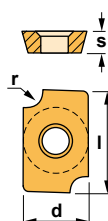

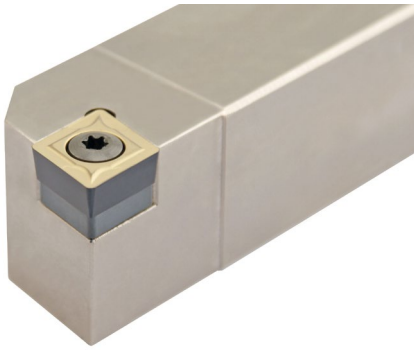

Characteristics:

Toolholder for external turning applications equipped with rhombic positive inserts (angle 80°).

For all kind of materials. The workpiece should be stable.

Axial 0°
Radial 0°

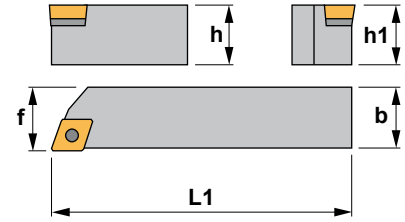

Eigenschaften:

Klemmhalter zum Außendrehen mit rhombischen positiven Wendeschneidplatten (80° Winkel). Geeignet für alle Materialien. Das Werkstück muß stabil sein.

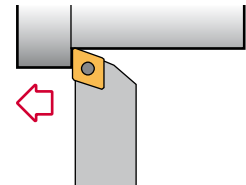

SCAC 90°

Reference Bezeichnung	h=h1	b	L1	f	Insert size Wendeschneidplatte	Kg
SCAC R/L 0808 D06	8	8	60	8,5	CC.. 0602..	0,050
SCAC R/L 1010 E06	10	10	70	10,5	CC.. 0602..	0,070
SCAC R/L 1212 F09	12	12	80	12,5	CC.. 09T3..	0,100
SCAC R/L 1616 H09	16	16	100	16,5	CC.. 09T3..	0,200
SCAC R/L 2020 K12	20	20	125	20,5	CC.. 1204..	0,400
SCAC R/L 2525 M12	25	25	150	25,5	CC.. 1204..	0,700

Reference Bezeichnung					Nm
SCAC R/L 0808 D06	1225	5507	-	-	0.9
SCAC R/L 1010 E06	1225	5507	-	-	0.9
SCAC R/L 1212 F09	1240	5515	-	-	3.0
SCAC R/L 1616 H09	1240	5515	-	-	3.0
SCAC R/L 2020 K12	1540	5517	3614	1760	3.0
SCAC R/L 2525 M12	1540	5517	3614	1760	3.0

CC.. 80° rhombic positive inserts with 7° clearance. A30-31
80° rhombische positive Wendeschneidplatten mit 7° Freiwinkel.

Reference / Bez.	l	s	d
CC.. 0602..	6,45	2,38	6,35
CC.. 09T3..	9,65	3,97	9,52
CC.. 1204..	12,90	4,76	12,70

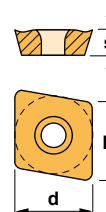

CCGT-AL



CCGT-AP



CCMT



CCMW





Characteristics:
Toolholder for external turning applications equipped with rhombic positive inserts (angle 80°).
For all kind of materials. The workpiece should be stable.

Axial 0°
Radial 0°

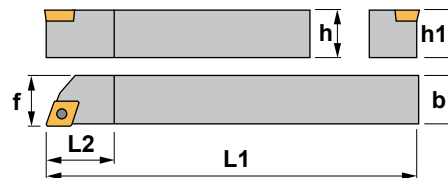

Eigenschaften:
Klemmhalter zum Drehen mit rhombischen positiven Wendeschneidplatten (80° Winkel). Für alle Materialien geeignet. Das Werkstück sollte stabil sein.

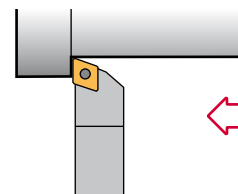

SCAC 90° Automatic lathes Drehautomaten

Reference Bezeichnung	h=h1	b	L1	L2	f	Insert size Wendeschneidplatte	KG
SCAC R/L 0808 M06	8	8	150	8	8	CC.. 0602..	0,070
SCAC R/L 1010 M06	10	10	150	10	10	CC.. 0602..	0,110
SCAC R/L 1212 M06	12	12	150	12	12	CC.. 0602..	0,150
SCAC R/L 1616 M06	16	16	150	16	16	CC.. 0602..	0,280
SCAC R/L 1212 M09	12	12	150	12	12	CC.. 09T3..	0,150
SCAC R/L 1616 M09	16	16	150	16	16	CC.. 09T3..	0,280

Reference Bezeichnung			Nm
SCAC R/L 0808 M06	1225	5507	0.9
SCAC R/L 1010 M06	1225	5507	0.9
SCAC R/L 1212 M06	1225	5507	0.9
SCAC R/L 1616 M06	1225	5507	0.9
SCAC R/L 1212 M09	1240	5515	3.0
SCAC R/L 1616 M09	1240	5515	3.0

CC.. 80° rhombic positive inserts with 7° clearance. A30-31
80° rhombische positive Wendeschneidplatten mit 7° Freiwinkel.

Reference / Bez.	l	s	d
CC.. 0602..	6,45	2,38	6,35
CC.. 09T3..	9,65	3,97	9,52

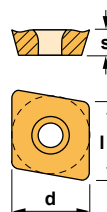

CCGT-AL



CCGT-AP



CCMT



CCMW





Characteristics:

Multipurpose toolholder equipped with rhombic positive insert (angle 80°).

For toolholders with negative inserts see Ref. MCLN-K (Page: A81) or MCLN (Page: A80) or PCLN (Page: A97).

Axial 0°
Radial 0°

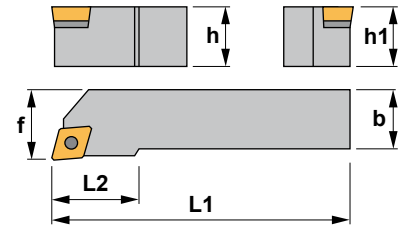

Eigenschaften: Multifunktions-Klemmhalter mit rhombischen positiven Wendeschneidplatten (80° Winkel).

Für Klemmhalter mit negativen Wendeschneidplatten, siehe MCLN-K (Seite: A81) oder MCLN (Seite: A80) oder PCLN (Seite: A97).

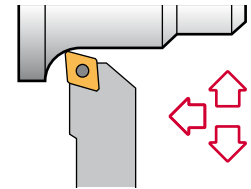

SCLC 95°

Reference Bezeichnung	h=h1	b	L1	L2	f	Insert size Wendeschneidplatte	
SCLC R/L 0808 D06	8	8	60	12	10	CC.. 0602..	0,050
SCLC R/L 1010 E06	10	10	70	14	12	CC.. 0602..	0,070
SCLC R/L 1212 F09	12	12	80	16	16	CC.. 09T3..	0,100
SCLC R/L 1616 H09	16	16	100	18	20	CC.. 09T3..	0,200
SCLC R/L 2020 K09	20	20	125	22	25	CC.. 09T3..	0,400
SCLC R/L 2020 K12	20	20	125	22	25	CC.. 1204..	0,400
SCLC R/L 2525 M12	25	25	150	28	32	CC.. 1204..	0,700

Reference Bezeichnung					Nm
SCLC R/L 0808 D06	1225	5507	-	-	0.9
SCLC R/L 1010 E06	1225	5507	-	-	0.9
SCLC R/L 1212 F09	1240	5515	-	-	3.0
SCLC R/L 1616 H09	1240	5515	-	-	3.0
SCLC R/L 2020 K09	1240	5515	-	-	3.0
SCLC R/L 2020 K12	1540	5517	3614	1760	3.0
SCLC R/L 2525 M12	1540	5517	3614	1760	3.0

CC.. 80° rhombic positive inserts with 7° clearance. A30-31
80° rhombische positive Wendeschneidplatten mit 7° Freiwinkel.

Reference / Bez.	l	s	d
CC.. 0602..	6,45	2,38	6,35
CC.. 09T3..	9,65	3,97	9,52
CC.. 1204..	12,90	4,76	12,70

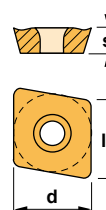

CCGT-AL



CCGT-AP



CCMT



CCMW



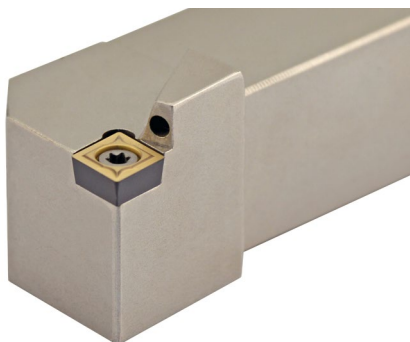

Characteristics:

Multipurpose toolholder equipped with rhombic positive insert (angle 80°).

For toolholders with negative inserts see Ref. MCLN-K (Page: A81) or MCLN (Page: A80) or PCLN (Page: A97).

Axial 0°
Radial 0°

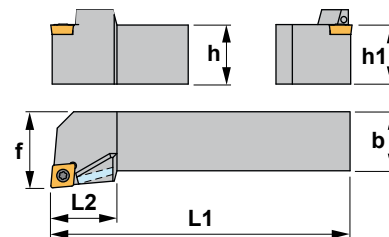

Eigenschaften:

Multifunktions-Klemmhalter mit rhombischen positiven Wendeschneidplatten (80° Winkel).

Für Klemmhalter mit negativen Wendeschneidplatten, siehe MCLN-K (Seite: A81) oder MCLN (Seite: A80) oder PCLN (Seite: A97).

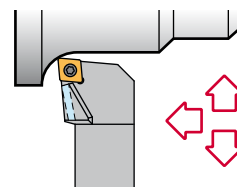

SCLC 95°-A

Reference Bezeichnung	h=h1	b	L1	L2	f	Insert size Wendeschneidplatte	
SCLC R/L 2020 K09-A	20	20	125	22	25	CC.. 09T3..	0,400
SCLC R/L 2525 M09-A	25	25	125	28	32	CC.. 09T3..	0,750

Reference Bezeichnung			Nm
SCLC R/L 2020 K09-A	1240	5515	3.0
SCLC R/L 2525 M09-A	1240	5515	3.0

CC.. 80° rhombic positive inserts with 7° clearance. A30-31
80° rhombische positive Wendeschneidplatten mit 7° Freiwinkel.

Reference / Bez.	l	s	d
CC.. 09T3..	9,65	3,97	9,52

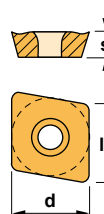

CCGT-AL



CCGT-AP



CCMT



CCMW



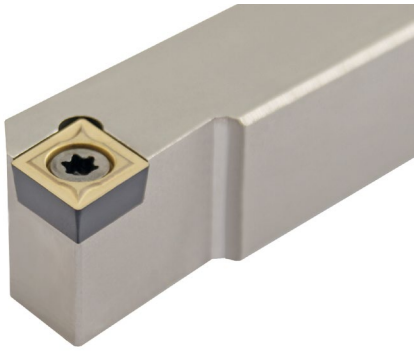

Characteristics:
Multipurpose toolholder equipped with rhombic positive insert (angle 80°).
For general applications, roughing, semi-finishing and finishing.

Axial 0°
Radial 0°

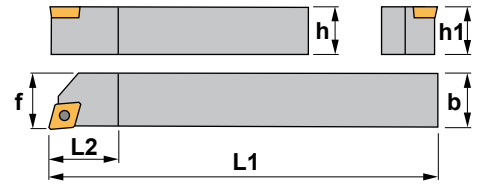

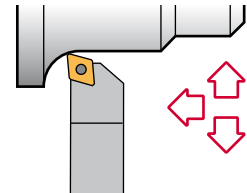

Eigenschaften:
Klemmhalter zum Drehen mit rhombischen positiven Wendeschneidplatte (80° Winkel).
Für allgemeine Anwendungen geeignet (Schlichten, Medium und Schruppen).



SCLC 95° Automatic lathes Drehautomaten

Reference Bezeichnung	h=h1	b	L1	L2	f	Insert size Wendeschneidplatte	
SCLC R/L 0808 M06	8	8	150	8	8	CC.. 0602..	0,070
SCLC R/L 1010 M06	10	10	150	10	10	CC.. 0602..	0,110
SCLC R/L 1212 M06	12	12	150	12	12	CC.. 0602..	0,150
SCLC R/L 1616 M06	16	16	150	16	16	CC.. 0602..	0,280
SCLC R/L 1212 M09	12	12	150	12	12	CC.. 09T3..	0,150
SCLC R/L 1616 M09	16	16	150	16	16	CC.. 09T3..	0,280

Reference Bezeichnung			Nm
SCLC R/L 0808 M06	1225	5507	0.9
SCLC R/L 1010 M06	1225	5507	0.9
SCLC R/L 1212 M06	1225	5507	0.9
SCLC R/L 1616 M06	1225	5507	0.9
SCLC R/L 1212 M09	1240	5515	3.0
SCLC R/L 1616 M09	1240	5515	3.0

CC.. 80° rhombic positive inserts with 7° clearance. A30-31

Reference / Bez.	l	s	d
CC.. 0602..	6,45	2,38	6,35
CC.. 09T3..	9,65	3,97	9,52



CCGT-AL



CCGT-AP



CCMT



CCMW





Characteristics:
Multipurpose toolholder equipped with rhombic positive insert (angle 55°).
For general applications, roughing, semi-finishing and finishing.

Axial 0°
Radial 0°

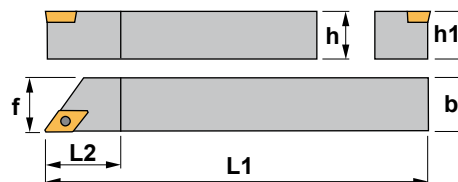

Eigenschaften:
Klemmhalter zum Drehen mit rhombischen positiven Wendeschneidplatte (55° Winkel).
Für allgemeine Anwendungen geeignet (Schlichten, Medium und Schruppen).

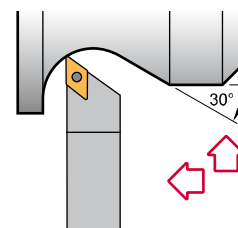

SDAC 90° Automatic lathes Drehautomaten

Reference Bezeichnung	h=h1	b	L1	L2	f	Insert size Wendeschneidplatte	kg
SDAC R/L 0808 M07	8	8	150	12,7	8	DC.. 0702..	0,070
SDAC R/L 1010 M07	10	10	150	15,0	10	DC.. 0702..	0,110
SDAC R/L 1212 M07	12	12	150	15,0	12	DC.. 0702..	0,150
SDAC R/L 1616 M07	16	16	150	16,0	16	DC.. 0702..	0,280
SDAC R/L 1212 M11	12	12	150	18,0	12	DC.. 11T3..	0,150
SDAC R/L 1616 M11	16	16	150	20,0	16	DC.. 11T3..	0,280

Reference Bezeichnung			Nm
SDAC R/L 0808 M07	1225	5507	0.9
SDAC R/L 1010 M07	1225	5507	0.9
SDAC R/L 1212 M07	1225	5507	0.9
SDAC R/L 1616 M07	1225	5507	0.9
SDAC R/L 1212 M11	1240	5515	3.0
SDAC R/L 1616 M11	1240	5515	3.0

DC.. 55° rhombic positive inserts with 7° clearance. A35
55° rhombische positive Wendeschneidplatten mit 7° Freiwinkel.

Reference / Bez.	l	s	d
DC.. 0702..	7,75	2,38	6,35
DC.. 11T3..	11,60	3,97	9,52

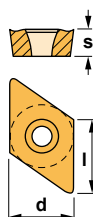

DCGT-AL



DCGT-AP



DCMT



DCMW

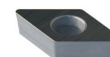

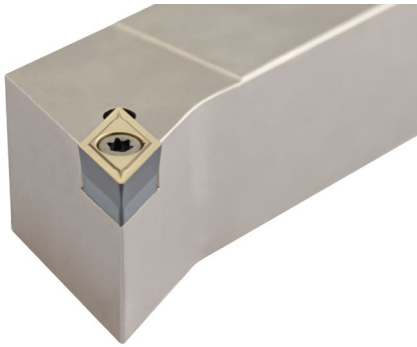

Characteristics:

Multipurpose profiling toolholder equipped with rhombic positive insert (angle 55°).

Axial 0°
Radial 0°

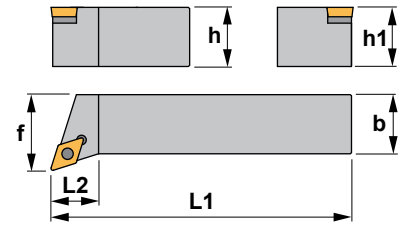

Eigenschaften:

Multifunktions-Klemmhalter zum Profildrehen mit rhombischen positiven Wendeschneidplatten (55° Winkel).

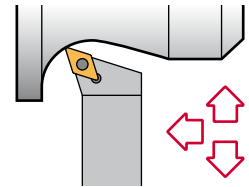

SDHC 107,5°

Reference Bezeichnung	h=h1	b	L1	L2	f	Insert size Wendeschneidplatte	kg
SDHC R/L 1616 H11	16	16	100	20	20	DC.. 11T3..	0,200
SDHC R/L 2020 K11	20	20	125	20	25	DC.. 11T3..	0,400
SDHC R/L 2525 M11	25	25	150	20	32	DC.. 11T3..	0,700

Reference Bezeichnung					Nm
SDHC R/L 1616 H11	1335	5516	3714	1750	3.0
SDHC R/L 2020 K11	1335	5516	3714	1750	3.0
SDHC R/L 2525 M11	1335	5516	3714	1750	3.0

DC.. 55° rhombic positive inserts with 7° clearance. A35
55° rhombische positive Wendeschneidplatten mit 7° Freiwinkel.

Reference / Bez.	l	s	d
DC.. 11T3..	11,60	3,97	9,52

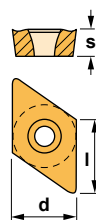

DCGT-AL



DCGT-AP



DCMT



DCMW

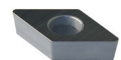



Characteristics:

Multipurpose profiling toolholder equipped with rhombic positive insert (angle 55°).
For toolholders with negative inserts see Ref. MDJN-K (Page: A82) or PDJN (Page: A100).

Axial 0°
Radial 0°

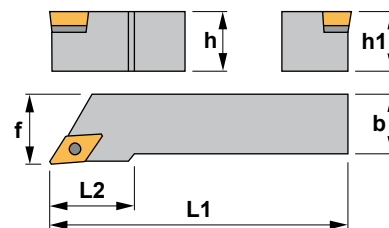

Eigenschaften:

Multifunktions-Klemmhalter zum Profildrehen mit rhombischen positiven Wendeschneidplatten (55° Winkel).

Für Klemmhalter mit negativen Wendeschneidplatten, siehe MDJN-K (Seite: A82) oder PDJN (Seite: A100).

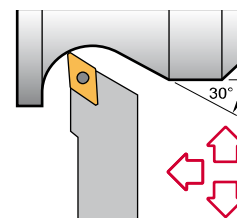

SDJC 93°

Reference Bezeichnung	h=h1	b	L1	L2	f	Insert size Wendeschneidplatte	Kg
SDJC R/L 1010 E07	10	10	70	14	12	DC.. 0702..	0,070
SDJC R/L 1212 F07	12	12	80	16	16	DC.. 0702..	0,100
SDJC R/L 1616 H07	16	16	100	16	20	DC.. 0702..	0,150
SDJC R/L 1212 F11	12	12	80	18	16	DC.. 11T3..	0,100
SDJC R/L 1616 H11	16	16	100	18	20	DC.. 11T3..	0,200
SDJC R/L 2020 K11	20	20	125	22	25	DC.. 11T3..	0,400
SDJC R/L 2525 M11	25	25	150	28	32	DC.. 11T3..	0,700

Reference Bezeichnung					Nm
SDJC R/L 1010 E07	1225	5507	-	-	0.9
SDJC R/L 1212 F07	1225	5507	-	-	0.9
SDJC R/L 1616 H07	1225	5507	-	-	0.9
SDJC R/L 1212 F11	1240	5515	-	-	3.0
SDJC R/L 1616 H11	1335	5516	3714	1750	3.0
SDJC R/L 2020 K11	1335	5516	3714	1750	3.0
SDJC R/L 2525 M11	1335	5516	3714	1750	3.0

DC.. 55° rhombic positive inserts with 7° clearance. A35
55° rhombische positive Wendeschneidplatten mit 7° Freiwinkel.

Reference / Bez.	l	s	d
DC.. 0702..	7,75	2,38	6,35
DC.. 11T3..	11,60	3,97	9,52

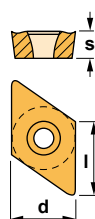

DCGT-AL



DCGT-AP



DCMT



DCMW

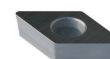

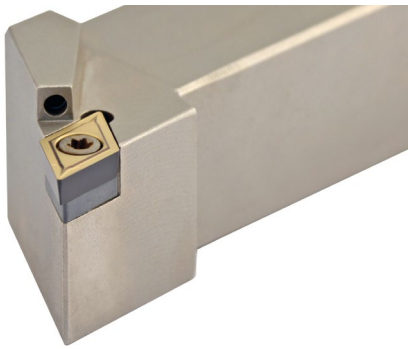

Characteristics:

Multipurpose profiling toolholder equipped with rhombic positive insert (angle 55°).
For toolholders with negative inserts see Ref. MDJN-K (Page: A82) or PDJN (Page: A100).

Axial 0°
Radial 0°

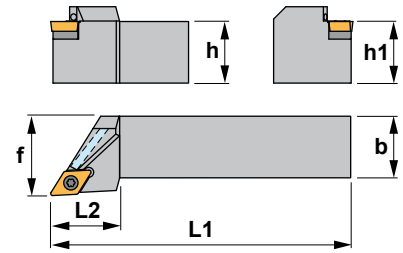

Eigenschaften:

Multifunktions-Klemmhalter zum Profildrehen mit rhombischen positiven Wendeschneidplatten (55° Winkel).

Für Klemmhalter mit negativen Wendeschneidplatten, siehe MDJN-K (Seite: A82) oder PDJN (Seite: A100).

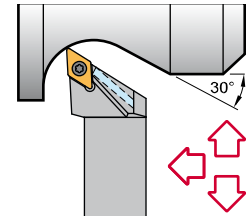

SDJC 93°-A

Reference Bezeichnung	h=h1	b	L1	L2	f	Insert size Wendeschneidplatte	
SDJC R/L 2020 K11-A	20	20	125	22	25	DC.. 11T3..	0,400
SDJC R/L 2525 M11-A	25	25	150	28	32	DC.. 11T3..	0,700

Reference Bezeichnung					Nm
SDJC R/L 2020 K11-A	1335	5516	3714	1750	3.0
SDJC R/L 2525 M11-A	1335	5516	3714	1750	3.0

DC.. 55° rhombic positive inserts with 7° clearance. A35
55° rhombische positive Wendeschneidplatten mit 7° Freiwinkel.

Reference / Bez.	l	s	d
DC.. 11T3..	11,60	3,97	9,52

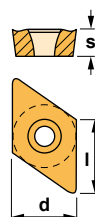

DCGT-AL



DCGT-AP



DCMT



DCMW

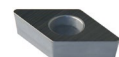



Characteristics:
Multipurpose profiling toolholder equipped with rhombic positive insert (angle 55°).
For general applications, roughing, semi-finishing and finishing.

Axial 0°
Radial 0°

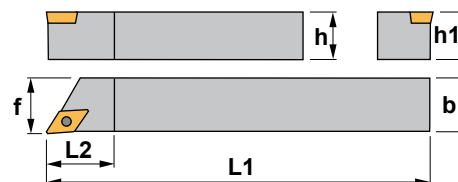

Eigenschaften:
Multifunktions-Klemmhalter zum Profildrehen mit rhombischen positiven Wendeschneidplatten (55° Winkel).
Für allgemeine Anwendungen geeignet (Schlichten, Medium und Schruppen).

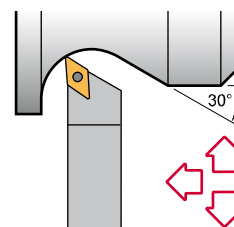

SDJC 93° Automatic lathes Drehautomaten

Reference Bezeichnung	h=h1	b	L1	L2	f	Insert size Wendeschneidplatte	/kg
SDJC R/L 0808 M07	8	8	150	8	8	DC.. 0702..	0,070
SDJC R/L 1010 M07	10	10	150	10	10	DC.. 0702..	0,110
SDJC R/L 1212 M07	12	12	150	12	12	DC.. 0702..	0,150
SDJC R/L 1616 M07	16	16	150	16	16	DC.. 0702..	0,280
SDJC R/L 1212 M11	12	12	150	12	12	DC.. 11T3..	0,150
SDJC R/L 1616 M11	16	16	150	16	16	DC.. 11T3..	0,280

Reference Bezeichnung			Nm
SDJC R/L 0808 M07	1225	5507	0.9
SDJC R/L 1010 M07	1225	5507	0.9
SDJC R/L 1212 M07	1225	5507	0.9
SDJC R/L 1616 M07	1225	5507	0.9
SDJC R/L 1212 M11	1240	5515	3.0
SDJC R/L 1616 M11	1240	5515	3.0

DC.. 55° rhombic positive inserts with 7° clearance. A35
55° rhombische positive Wendeschneidplatten mit 7° Freiwinkel.

Reference / Bez.	l	s	d
DC.. 0702..	7,75	2,38	6,35
DC.. 11T3..	11,60	3,97	9,52

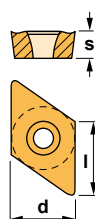

DCGT-AL



DCGT-AP



DCMT



DCMW

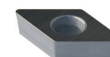

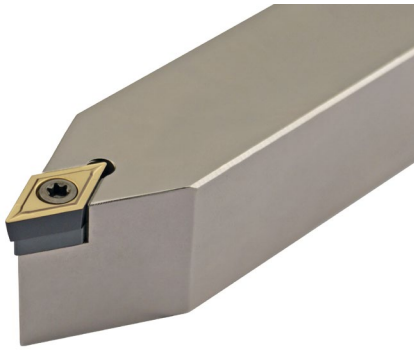

Characteristics:

Multipurpose profiling toolholder equipped with rhombic positive insert (angle 55°).
For toolholders with negative inserts see Ref. PDNN (Page: A101).

Axial 0°
Radial 0°

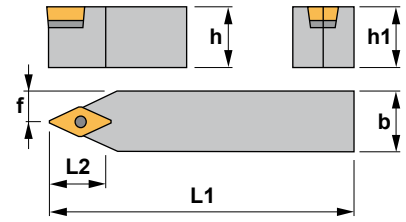

Eigenschaften: Multifunktions-Klemmhalter zum Profildrehen mit rhombischen positiven Wendeschneidplatten (55° Winkel).
Für Klemmhalter mit negativen Wendeschneidplatten, siehe PDNN (Seite: A101).

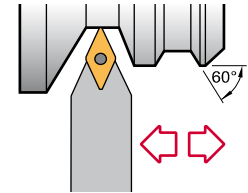

SDNC 62°30'

Reference Bezeichnung	h=h1	b	L1	L2	f	Insert size Wendeschneidplatte	Kg
SDNC N 0808 D07	8	8	60	16	4,0	DC.. 0702..	0,050
SDNC N 1010 E07	10	10	70	16	5,0	DC.. 0702..	0,070
SDNC N 1212 F07	12	12	80	18	6,0	DC.. 0702..	0,100
SDNC N 1616 H11	16	16	100	22	8,0	DC.. 11T3..	0,200
SDNC N 2020 K11	20	20	125	22	10,0	DC.. 11T3..	0,400
SDNC N 2525 M11	25	25	150	22	12,5	DC.. 11T3..	0,700

Reference Bezeichnung					Nm
SDNC N 0808 D07	1225	5507	-	-	0.9
SDNC N 1010 E07	1225	5507	-	-	0.9
SDNC N 1212 F07	1225	5507	-	-	0.9
SDNC N 1616 H11	1335	5516	3714	1750	3.0
SDNC N 2020 K11	1335	5516	3714	1750	3.0
SDNC N 2525 M11	1335	5516	3714	1750	3.0

DC.. 55° rhombic positive inserts with 7° clearance. A35
55° rhombische positive Wendeschneidplatten mit 7° Freiwinkel.

Reference / Bez.	l	s	d
DC.. 0702..	7,75	2,38	6,35
DC.. 11T3..	11,60	3,97	9,52

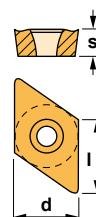

DCGT-AL



DCGT-AP



DCMT



DCMW

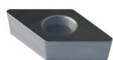



Characteristics:
Multipurpose external turning toolholder equipped with rhombic positive insert (angle 55°).
For general applications, roughing, semi-finishing and finishing.

Axial 0°
Radial 0°

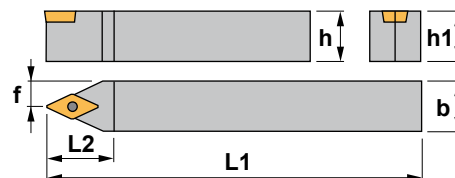

Eigenschaften:
Klemmhalter zum Drehen mit rhombischen positiven Wendeschneidplatte (55° Winkel).
Für allgemeine Anwendungen geeignet (Schlichten, Medium und Schruppen).

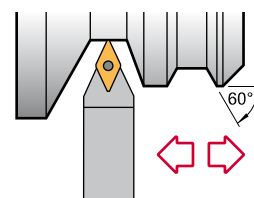

SDNC 62°30' i Automatic lathes Drehautomaten

Reference Bezeichnung	h=h1	b	L1	L2	f	Insert size Wendeschneidplatte	kg
SDNC N 1010 M07	10	10	150	15	5,2	DC.. 0702..	0,100
SDNC N 1212 M11	12	12	150	21	6,2	DC.. 11T3..	0,140
SDNC N 1616 M11	16	16	150	21	8,6	DC.. 11T3..	0,270

Reference Bezeichnung			Nm
SDNC N 1010 M07	1225	5507	0.9
SDNC N 1212 M11	1240	5515	3.0
SDNC N 1616 M11	1240	5515	3.0

DC.. 55° rhombic positive inserts with 7° clearance. i A35
55° rhombische positive Wendeschneidplatten mit 7° Freiwinkel.

Reference / Bez.	l	s	d
DC.. 0702..	7,75	2,38	6,35
DC.. 11T3..	11,60	3,97	9,52

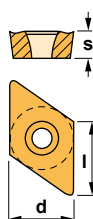

DCGT-AL



DCGT-AP



DCMT



DCMW

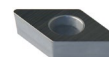

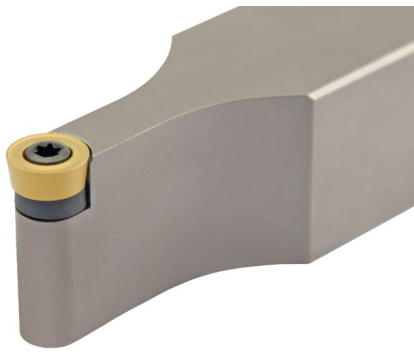

Characteristics:

Profiling toolholder equipped with round positive insert.
For lever lock toolholders see Ref. PRDC (Page: A102).

Axial 0°
Radial 0°

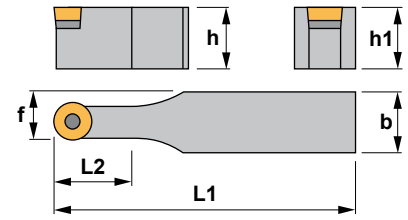

Eigenschaften:

Klemmhalter zum Profildrehen mit runden positiven Wendeschneidplatten.
Für Klemmhalter mit Kniehebel-Klemmung, siehe PRDC (Seite: A102).

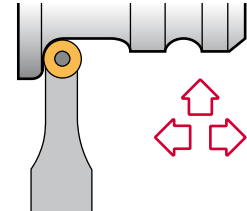

SRDC

Reference Bezeichnung	h=h1	b	L1	L2	f	Insert size Wendeschneidplatte	
SRDC N 1010 E06	10	10	70	10	8,0	RC.. 0602M0	0,070
SRDC N 1212 F06	12	12	80	12	11,0	RC.. 0602M0	0,100
SRDC N 1616 H06	16	16	100	16	13,0	RC.. 0602M0	0,200
SRDC N 2020 K06	20	20	125	20	15,0	RC.. 0602M0	0,400
SRDC N 2525 M06	25	25	150	25	17,5	RC.. 0602M0	0,700
SRDC N 1616 H08	16	16	100	16	13,0	RC.. 0803M0	0,200
SRDC N 2020 K08	20	20	125	20	15,0	RC.. 0803M0	0,400
SRDC N 2525 M08	25	25	150	25	17,5	RC.. 0803M0	0,700
SRDC N 2020 K10	20	20	125	22	15,0	RC.. 10T3M0	0,400
SRDC N 2525 M10	25	25	150	22	17,5	RC.. 10T3M0	0,700
SRDC N 2020 K12	20	20	125	28	16,0	RC.. 1204M0	0,400
SRDC N 2525 M12	25	25	150	28	18,5	RC.. 1204M0	0,700
SRDC N 3225 P12	32	25	170	28	18,5	RC.. 1204M0	0,900
SRDC N 3232 P12	32	32	170	28	22,0	RC.. 1204M0	1,200

Reference Bezeichnung					Nm
SRDC N.....06	1225	5507	-	-	0.9
SRDC N.....08	1230	5508	-	-	1.2
SRDC N.....10	1335	5516	3811	1750	3.0
SRDC N.....12	1335	5516	3814	1750	3.0

RC..

Round positive inserts with 7° clearance. A38-39
Runde positive Wendeschneidplatten mit 7° Freiwinkel.

Reference / Bez.	s	d
RC.. 0602M0	2,38	6,00
RC.. 0803M0	3,18	8,00
RC.. 10T3M0	3,97	10,00
RC.. 1204M0	4,76	12,00

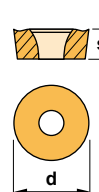

RCGT-AL



RCGT-AP



RCMT



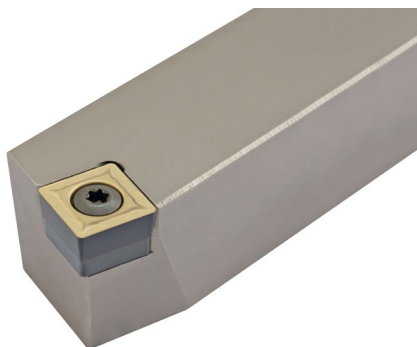

Characteristics:

Toolholder for external turning applications equipped with square positive inserts.

For toolholders with negative inserts see Ref. PSBN (Page: A105).

Axial 0°
Radial 0°

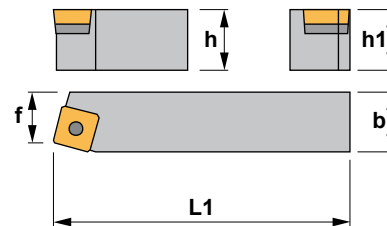

Eigenschaften:

Klemhalter zum Außendreihen mit vierkantigen positiven Wendeschneidplatten.

Für Klemhalter mit negativen Wendeschneidplatten, siehe PSBN (Seite: A105).

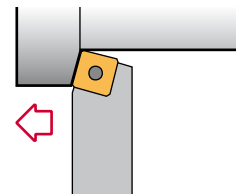

SSBC 75°

Reference Bezeichnung	h=h1	b	L1	f	Insert size Wendeschneidplatte	kg
SSBC R/L 1212 F09	12	12	80	11	SC.. 09T3..	0,100
SSBC R/L 1616 H09	16	16	100	13	SC.. 09T3..	0,200
SSBC R/L 2020 K12	20	20	125	17	SC.. 1204..	0,400
SSBC R/L 2525 M12	25	25	150	22	SC.. 1204..	0,700

Reference Bezeichnung					Nm
SSBC R/L 1212 F09	1240	5515	-	-	3.0
SSBC R/L 1616 H09	1240	5515	-	-	3.0
SSBC R/L 2020 K12	1540	5517	3514	1760	3.0
SSBC R/L 2525 M12	1540	5517	3514	1760	3.0

SC..

Square positive inserts with 7° clearance. A40
Vierkantige positive Wendeschneidplatten mit 7° Freiwinkel.

Reference / Bez.	l	s	d
SC.. 09T3..	9,52	3,97	9,52
SC.. 1204..	12,70	4,76	12,70

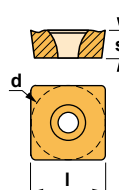

SCGT-AL



SCMT



SCMT-39



SCMW



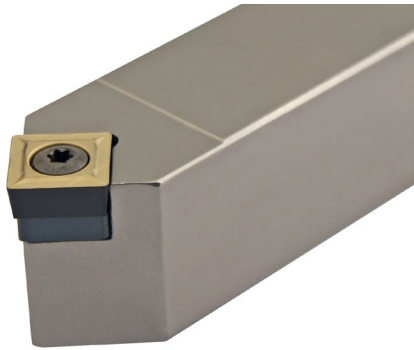

Characteristics:

Toolholder for external turning and chamfering applications equipped with square positive inserts.

For toolholders with negative inserts see Ref. PSDN (Page: A106).

Axial 0°
Radial 0°

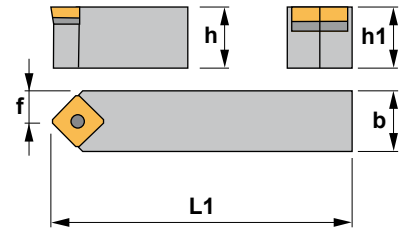

Eigenschaften:

Klemhalter zum Außendrehen und Abschrägen mit vierkantigen positiven Wendeschneidplatten.

Für Klemhalter mit negativen Wendeschneidplatten, siehe PSDN (Seite: A106).

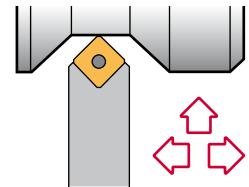

SSDC 45°

Reference Bezeichnung	h=h1	b	L1	f	Insert size Wendeschneidplatte	
SSDC N 1212 F09	12	12	80	6,0	SC.. 09T3..	0,100
SSDC N 1616 H09	16	16	100	8,0	SC.. 09T3..	0,200
SSDC N 2020 K12	20	20	125	10,0	SC.. 1204..	0,400
SSDC N 2525 M12	25	25	150	12,5	SC.. 1204..	0,700

Reference Bezeichnung					Nm
SSDC N 1212 F09	1240	5515	-	-	3.0
SSDC N 1616 H09	1240	5515	-	-	3.0
SSDC N 2020 K12	1540	5517	3514	1760	3.0
SSDC N 2525 M12	1540	5517	3514	1760	3.0

SC.. Square positive inserts with 7° clearance. A40
Vierkantige positive Wendeschneidplatten mit 7° Freiwinkel.

Reference / Bez.	l	s	d
SC.. 09T3..	9,52	3,97	9,52
SC.. 1204..	12,70	4,76	12,70

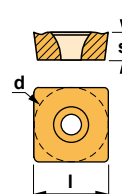

SCGT-AL



SCMT



SCMT-39



SCMW





Characteristics:

Toolholder for external turning and chamfering applications equipped with square positive inserts.

For toolholders with negative inserts see Ref. PSSN (Page: A108).

Axial 0°
Radial 0°

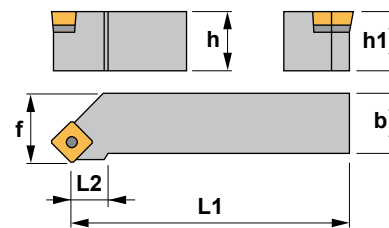

Eigenschaften:

Klemmhalter zum Außendreifen und Abschrägen mit vierkantigen positiven Wendeschneidplatten.

Für Klemmhalter mit negativen Wendeschneidplatten, siehe PSSN (Seite: A108).

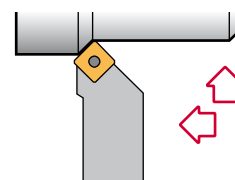

SSSC 45°

Reference Bezeichnung	h=h1	b	L1	L2	f	Insert size Wendeschneidplatte	kg
SSSC R/L 1212 F09	12	12	80	20	16	SC.. 09T3..	0,100
SSSC R/L 1616 H09	16	16	100	22	20	SC.. 09T3..	0,200
SSSC R/L 2020 K12	20	20	125	25	25	SC.. 1204..	0,400
SSSC R/L 2525 M12	25	25	150	28	32	SC.. 1204..	0,700

Reference Bezeichnung					Nm
SSSC R/L 1212 F09	1240	5515	-	-	3.0
SSSC R/L 1616 H09	1240	5515	-	-	3.0
SSSC R/L 2020 K12	1540	5517	3514	1760	3.0
SSSC R/L 2525 M12	1540	5517	3514	1760	3.0

SC..

Square positive inserts with 7° clearance. A40
Vierkantige positive Wendeschneidplatten mit 7° Freiwinkel.

Reference / Bez.	l	s	d
SC.. 09T3..	9,52	3,97	9,52
SC.. 1204..	12,70	4,76	12,70

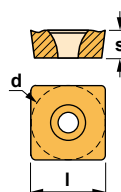

SCGT-AL



SCMT



SCMT-39



SCMW





Characteristics:

Toolholder for external turning applications equipped with triangular positive inserts. For all kind of materials. The workpiece should be stable.

Axial 0°
Radial 0°

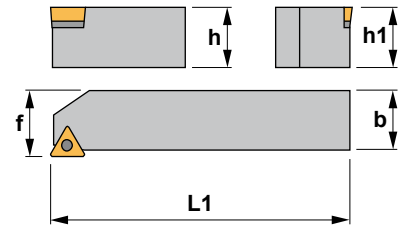

Eigenschaften:

Klemmhalter zum Außendrehen mit dreikantigen positiven Wendeschneidplatten. Geeignet für alle Materialien. Das Werkstück muß stabil sein.

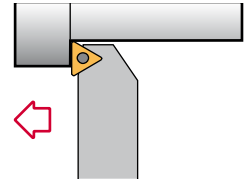

STAC 90°

Reference Bezeichnung	h=h1	b	L1	f	Insert size Wendeschneidplatte	Kg
STAC R/L 0808 D09	8	8	60	8,5	TC.. 0902..	0,050
STAC R/L 1010 E09	10	10	70	10,5	TC.. 0902..	0,070
STAC R/L 1212 F11	12	12	80	12,5	TC.. 1102..	0,100
STAC R/L 1616 H11	16	16	100	16,5	TC.. 1102..	0,200
STAC R/L 1616 H16	16	16	100	16,5	TC.. 16T3..	0,200
STAC R/L 2020 K16	20	20	125	20,5	TC.. 16T3..	0,400
STAC R/L 2525 M16	25	25	150	25,5	TC.. 16T3..	0,700

Reference Bezeichnung					Nm
STAC R/L 0808 D09	1222	5506	-	-	0.6
STAC R/L 1010 E09	1222	5506	-	-	0.6
STAC R/L 1212 F11	1225	5507	-	-	0.9
STAC R/L 1616 H11	1225	5507	-	-	0.9
STAC R/L 1616 H16	1335	5516	3414	1750	3.0
STAC R/L 2020 K16	1335	5516	3414	1750	3.0
STAC R/L 2525 M16	1335	5516	3414	1750	3.0

TC..

Triangular positive inserts with 7° clearance. A44
Dreikantige positive Wendeschneidplatten mit 7° Freiwinkel.

Reference / Bez.	l	s	d
TC.. 0902..	9,62	2,38	5,55
TC.. 1102..	11,00	2,38	6,35
TC.. 16T3..	16,50	3,97	9,52

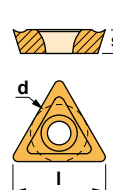

TCGT-AL



TCMT



TCMW

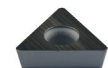

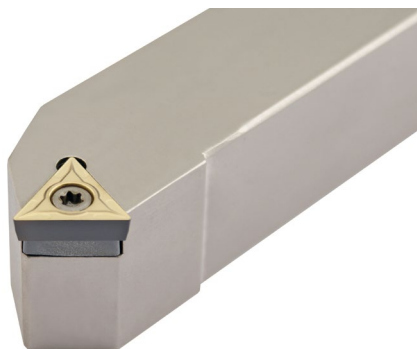

Characteristics:

Toolholder for external turning and chamfering applications equipped with triangular positive inserts.

For toolholders with negative inserts see Ref. PTDN (Page: A109).

Axial 0°
Radial 0°

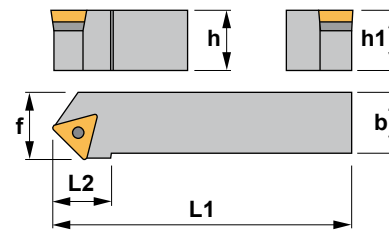

Eigenschaften:

Klemmhalter zum Außendreihen und Abschrägen mit dreikantigen positiven Wendeschneidplatten.

Für Klemmhalter mit negativen Wendeschneidplatten, siehe PTDN (Seite: A109).

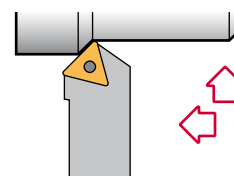

STDC 45°

Reference Bezeichnung	h=h1	b	L1	L2	f	Insert size Wendeschneidplatte	
STDC R/L 0808 D09	8	8	60	12	10	TC.. 0902..	0,050
STDC R/L 1010 E09	10	10	70	14	11	TC.. 0902..	0,070
STDC R/L 1212 F11	12	12	80	16	13	TC.. 1102..	0,100
STDC R/L 1616 H11	16	16	100	18	17	TC.. 1102..	0,200
STDC R/L 1212 F16	12	12	80	18	17	TC.. 16T3..	0,100
STDC R/L 1616 H16	16	16	100	18	17	TC.. 16T3..	0,200
STDC R/L 2020 K16	20	20	125	22	22	TC.. 16T3..	0,400
STDC R/L 2525 M16	25	25	150	28	27	TC.. 16T3..	0,700

Reference Bezeichnung					Nm
STDC R/L 0808 D09	1222	5506	-	-	0.6
STDC R/L 1010 E09	1222	5506	-	-	0.6
STDC R/L 1212 F11	1225	5507	-	-	0.9
STDC R/L 1616 H11	1225	5507	-	-	0.9
STDC R/L 1212 F16	1240	5515	-	-	3.0
STDC R/L 1616 H16	1335	5516	3414	1750	3.0
STDC R/L 2020 K16	1335	5516	3414	1750	3.0
STDC R/L 2525 M16	1335	5516	3414	1750	3.0

TC..

Triangular positive inserts with 7° clearance. A44
Dreikantige positive Wendeschneidplatten mit 7° Freiwinkel.

Reference / Bez.	l	s	d
TC.. 0902..	9,62	2,38	5,55
TC.. 1102..	11,00	2,38	6,35
TC.. 16T3..	16,50	3,97	9,52

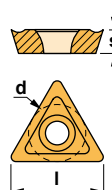

TCGT-AL



TCMT



TCMW





Characteristics:

Toolholder for face turning applications equipped with triangular positive inserts. For toolholders with negative inserts see Ref. PTFN (Page: A110).

Axial 0°
Radial 0°

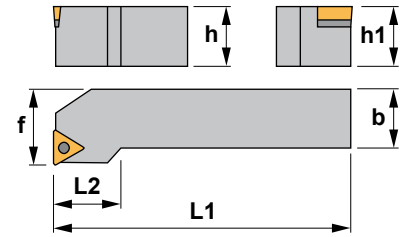

Eigenschaften:

Klemmhalter zum Plandrehen mit dreikantigen positiven Wendeschneidplatten. Für Klemmhalter mit negativen Wendeschneidplatten, siehe PTFN (Seite: A110).

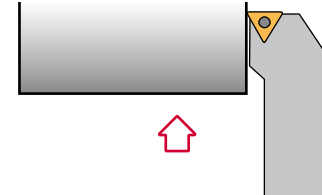

STFC 90°

Reference Bezeichnung	h=h1	b	L1	L2	f	Insert size Wendeschneidplatte	KG
STFC R/L 0808 D09	8	8	60	12	10	TC.. 0902..	0,050
STFC R/L 1010 E09	10	10	70	14	12	TC.. 0902..	0,070
STFC R/L 1212 F11	12	12	80	16	16	TC.. 1102..	0,100
STFC R/L 1616 H11	16	16	100	18	20	TC.. 1102..	0,200
STFC R/L 1212 F16	12	12	80	16	16	TC.. 16T3..	0,100
STFC R/L 1616 H16	16	16	100	22	20	TC.. 16T3..	0,200
STFC R/L 2020 K16	20	20	125	22	25	TC.. 16T3..	0,400
STFC R/L 2525 M16	25	25	150	28	32	TC.. 16T3..	0,700

Reference Bezeichnung					Nm
STFC R/L 0808 D09	1222	5506	-	-	0.6
STFC R/L 1010 E09	1222	5506	-	-	0.6
STFC R/L 1212 F11	1225	5507	-	-	0.9
STFC R/L 1616 H11	1225	5507	-	-	0.9
STFC R/L 1212 F16	1240	5515	-	-	3.0
STFC R/L 1616 H16	1335	5516	3414	1750	3.0
STFC R/L 2020 K16	1335	5516	3414	1750	3.0
STFC R/L 2525 M16	1335	5516	3414	1750	3.0

TC.. Triangular positive inserts with 7° clearance. A44
Dreikantige positive Wendeschneidplatten mit 7° Freiwinkel.

Reference / Bez.	l	s	d
TC.. 0902..	9,62	2,38	5,55
TC.. 1102..	11,00	2,38	6,35
TC.. 16T3..	16,50	3,97	9,52

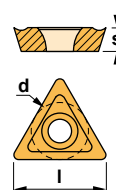

TCGT-AL



TCMT



TCMW

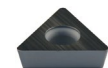



Characteristics:

Toolholder for external turning applications equipped with triangular positive inserts. For toolholders with negative inserts see Ref. PTGN (Page: A111).

Axial 0°
Radial 0°

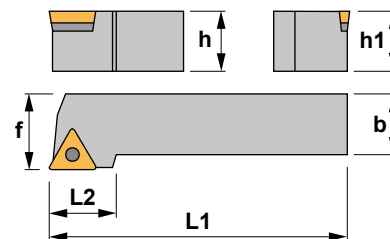

Eigenschaften:

Klemmhalter zum Außendrehen mit dreikantigen positiven Wendeschneidplatten. Für Klemmhalter mit negativen Wendeschneidplatten, siehe PTGN (Seite: A111).

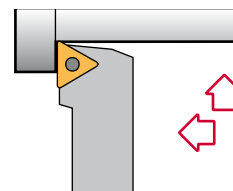

STGC 90°

Reference Bezeichnung	h=h1	b	L1	L2	f	Insert size Wendeschneidplatte	kg
STGC R/L 0808 D09	8	8	60	12	10	TC.. 0902..	0,050
STGC R/L 1010 E09	10	10	70	14	12	TC.. 0902..	0,070
STGC R/L 1212 F11	12	12	80	16	16	TC.. 1102..	0,100
STGC R/L 1616 H11	16	16	100	18	20	TC.. 1102..	0,200
STGC R/L 1212 F16	12	12	80	18	16	TC.. 16T3..	0,100
STGC R/L 1616 H16	16	16	100	18	20	TC.. 16T3..	0,200
STGC R/L 2020 K16	20	20	125	22	25	TC.. 16T3..	0,400
STGC R/L 2525 M16	25	25	150	28	32	TC.. 16T3..	0,700

Reference Bezeichnung					Nm
STGC R/L 0808 D09	1222	5506	-	-	0.6
STGC R/L 1010 E09	1222	5506	-	-	0.6
STGC R/L 1212 F11	1225	5507	-	-	0.9
STGC R/L 1616 H11	1225	5507	-	-	0.9
STGC R/L 1212 F16	1240	5515	-	-	3.0
STGC R/L 1616 H16	1335	5516	3414	1750	3.0
STGC R/L 2020 K16	1335	5516	3414	1750	3.0
STGC R/L 2525 M16	1335	5516	3414	1750	3.0

TC.. <small>Triangular positive inserts with 7° clearance. Dreikantige positive Wendeschneidplatten mit 7° Freiwinkel. A44</small>			
Reference / Bez.	l	s	d
TC.. 0902..	9,62	2,38	5,55
TC.. 1102..	11,00	2,38	6,35
TC.. 16T3..	16,50	3,97	9,52

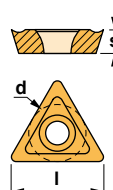

TCGT-AL



TCMT



TCMW

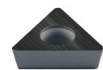

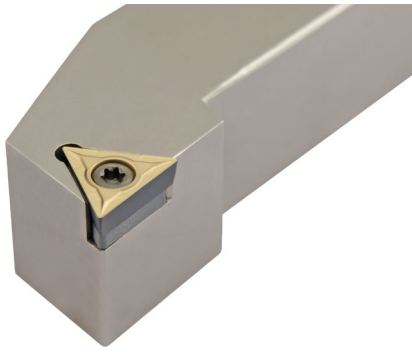

Characteristics:

Toolholder for external and face turning applications equipped with triangular positive inserts.

For toolholders with negative inserts see Ref. MTJN (Page: A86) or MTJN-K (Page: A87).

Axial 0°
Radial 0°

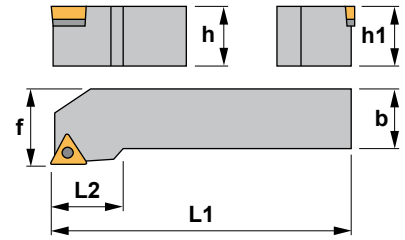

Eigenschaften:

Klemmhalter zum Außen- und Plandrehen mit dreikantigen positiven Wendeschneidplatten.

Für Klemmhalter mit negativen Wendeschneidplatten, siehe MTJN (Seite: A86) oder MTJN-K (Seite: A87).

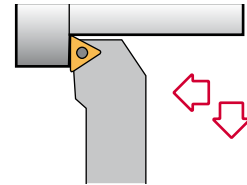

STJC 93°

Reference Bezeichnung	h=h1	b	L1	L2	f	Insert size Wendeschneidplatte	
STJC R/L 0808 D09	8	8	60	12	10	TC.. 0902..	0,050
STJC R/L 1010 E09	10	10	70	14	12	TC.. 0902..	0,070
STJC R/L 1212 F11	12	12	80	16	16	TC.. 1102..	0,100
STJC R/L 1616 H11	16	16	100	18	20	TC.. 1102..	0,200
STJC R/L 1212 F16	12	12	80	18	16	TC.. 16T3..	0,100
STJC R/L 1616 H16	16	16	100	18	20	TC.. 16T3..	0,200
STJC R/L 2020 K16	20	20	125	22	25	TC.. 16T3..	0,400
STJC R/L 2525 M16	25	25	150	28	32	TC.. 16T3..	0,700

Reference Bezeichnung					Nm
STJC R/L 0808 D09	1222	5506	-	-	0.6
STJC R/L 1010 E09	1222	5506	-	-	0.6
STJC R/L 1212 F11	1225	5507	-	-	0.9
STJC R/L 1616 H11	1225	5507	-	-	0.9
STJC R/L 1212 F16	1240	5515	-	-	3.0
STJC R/L 1616 H16	1335	5516	3414	1750	3.0
STJC R/L 2020 K16	1335	5516	3414	1750	3.0
STJC R/L 2525 M16	1335	5516	3414	1750	3.0

TC..

Triangular positive inserts with 7° clearance. A44
Dreikantige positive Wendeschneidplatten mit 7° Freiwinkel.

Reference / Bez.	l	s	d
TC.. 0902..	9,62	2,38	5,55
TC.. 1102..	11,00	2,38	6,35
TC.. 16T3..	16,50	3,97	9,52

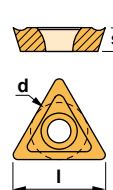

TCGT-AL



TCMT



TCMW

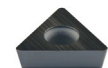

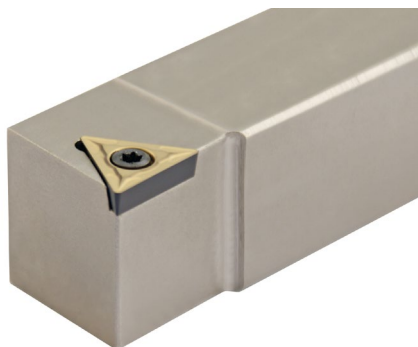

Characteristics:

Toolholder for external and face turning applications equipped with triangular positive inserts.

For all kind of materials. The workpiece should be stable.

Axial 0°
Radial 0°

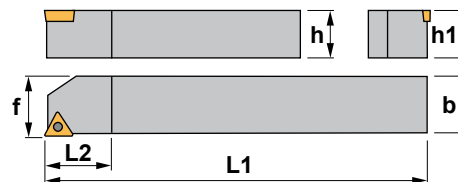

Eigenschaften:

Klemmhalter zum Drehen und Plandrehen mit dreikantigen positiven Wendeschneidplatten.

Für alle Materialien geeignet.

Das Werkstück sollte stabil sein.

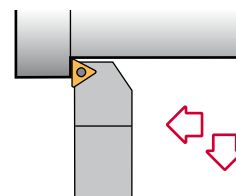

STJC 93°

i Automatic lathes
Drehautomaten

Reference Bezeichnung	h=h1	b	L1	L2	f	Insert size Wendeschneidplatte	kg
STJC R/L 1010 M11	10	10	150	16	10	TC.. 1102..	0,110
STJC R/L 1212 M11	12	12	150	16	12	TC.. 1102..	0,150
STJC R/L 1616 M11	16	16	150	16	16	TC.. 1102..	0,280

Reference Bezeichnung			Nm
STJC R/L 1010 M11	1225	5507	0.9
STJC R/L 1212 M11	1225	5507	0.9
STJC R/L 1616 M11	1225	5507	0.9

TC.. <small>Triangular positive inserts with 7° clearance. i A44</small> <small>Dreikantige positive Wendeschneidplatten mit 7° Freiwinkel.</small>					
Reference / Bez.	l	s	d	TCGT-AL	TCMT
TC.. 1102..	11,00	2,38	6,35		
				TCMW	

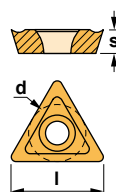



Characteristics:

Toolholder for external turning and chamfering applications equipped with triangular positive inserts.

For toolholders with negative inserts see Ref. PTTN (Page: A112).

Axial 0°
Radial 0°

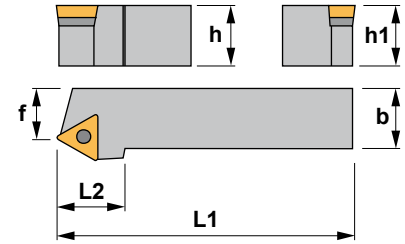

Eigenschaften:

Klemmhalter zum Außendrehen und Abschrägen mit dreikantigen positiven Wendeschneidplatten.

Für Klemmhalter mit negativen Wendeschneidplatten, siehe PTTN (Seite: A112).

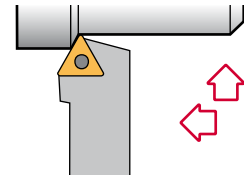

STTC 60°

Reference Bezeichnung	h=h1	b	L1	L2	f	Insert size Wendeschneidplatte	Kg
STTC R/L 0808 D09	8	8	60	12	7	TC.. 0902..	0,050
STTC R/L 1010 E09	10	10	70	14	9	TC.. 0902..	0,070
STTC R/L 1212 F11	12	12	80	16	11	TC.. 1102..	0,100
STTC R/L 1616 H11	16	16	100	18	13	TC.. 1102..	0,200
STTC R/L 1212 F16	12	12	80	18	11	TC.. 16T3..	0,100
STTC R/L 1616 H16	16	16	100	18	13	TC.. 16T3..	0,200
STTC R/L 2020 K16	20	20	125	22	17	TC.. 16T3..	0,400
STTC R/L 2525 M16	25	25	150	28	22	TC.. 16T3..	0,700

Reference Bezeichnung					Nm
STTC R/L 0808 D09	1222	5506	-	-	0.6
STTC R/L 1010 E09	1222	5506	-	-	0.6
STTC R/L 1212 F11	1225	5507	-	-	0.9
STTC R/L 1616 H11	1225	5507	-	-	0.9
STTC R/L 1212 F16	1240	5515	-	-	3.0
STTC R/L 1616 H16	1335	5516	3414	1750	3.0
STTC R/L 2020 K16	1335	5516	3414	1750	3.0
STTC R/L 2525 M16	1335	5516	3414	1750	3.0

TC..

Triangular positive inserts with 7° clearance. A44
Dreikantige positive Wendeschneidplatten mit 7° Freiwinkel.

Reference / Bez.	l	s	d
TC.. 0902..	9,62	2,38	5,55
TC.. 1102..	11,00	2,38	6,35
TC.. 16T3..	16,50	3,97	9,52

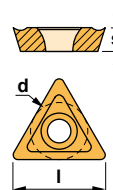

TCGT-AL



TCMT



TCMW

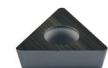

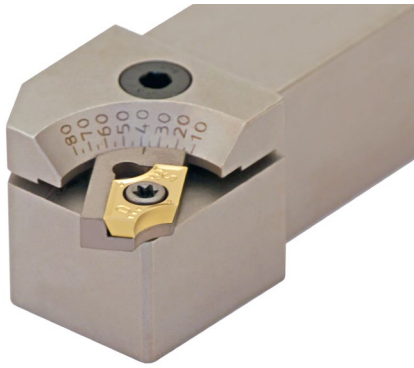

Characteristics:

Toolholder equipped with parallelogram and triangular positive inserts.
For chamfering applications.

Axial 0°
Radial 0°

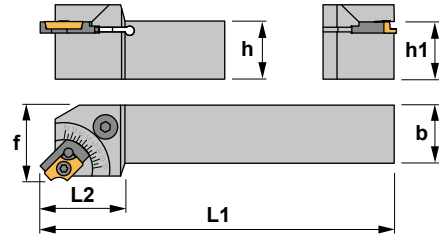

Eigenschaften:

Klemmhalter zum Abschrägen mit parallelogramme und dreikantigen positiven Wendeschneidplatten.

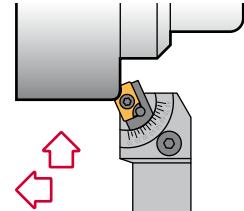

STXC 10°- 80°

Reference Bezeichnung	h=h1	b	L1	L2	f	Insert size Wendeschneidplatte	Kg
STXC R 2020 K16	20	20	125	27	25	ADMT 1503.. / TCMT 16T3..	0,620
STXC R 2525 M16	25	25	150	27	32	ADMT 1503.. / TCMT 16T3..	0,790

Reference Bezeichnung							Nm ¹	Nm ²
STXC R 2020 K16	1240	5515	1496	5004	6925	6926	3.0	3.5
STXC R 2525 M16	1240	5515	1496	5004	6925	6926	3.0	3.5

ADMT-R

Parallelogram positive inserts with 15° clearance. A30
Parallelogramme positive WSP mit 15° Freiwinkel.

Reference / Bezeichnung	r	s	d
ADMT 1503R1.0	1.0	3,18	9,52
ADMT 1503R1.5	1.5	3,18	9,52
ADMT 1503R2.0	2.0	3,18	9,52
ADMT 1503R2.5	2.5	3,18	9,52
ADMT 1503R3.0	3.0	3,18	9,52
ADMT 1503R3.5	3.5	3,18	9,52
ADMT 1503R4.0	4.0	3,18	9,52
ADMT 1503R4.5	4.5	3,18	9,52
ADMT 1503R5.0	5.0	3,18	9,52

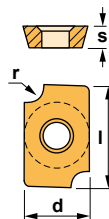

TCMT

Triangular positive insert with 7° clearance. A44
Dreikantige positive Wendeschneidplatte mit 7° Freiwinkel.

Reference / Bez.	l	s	d
TCMT 16T3..	16,50	3,97	9,52

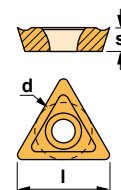

TCMT



Characteristics:

Multipurpose profiling toolholder equipped with rhombic positive insert (angle 55°).

For general applications, roughing, semi-finishing and finishing.

Axial 0°
Radial 0°

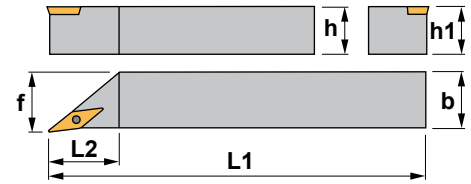

Eigenschaften:

Multifunktions-Klemmhalter zum Profildrehen mit rhombischen positiven Wendeschneidplatten (55° Winkel).

Für allgemeine Anwendungen geeignet (Schlichten, Medium und Schruppen).

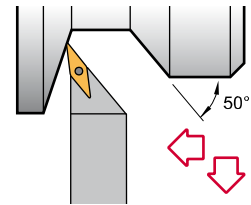

SVAC 90°

i Automatic lathes
Drehautomaten

Reference Bezeichnung	h=h1	b	L1	L2	f	Insert size Wendeschneidplatte	Kg
SVAC R/L 0808 M11	8	8	150	26	8	VC.. 1103..	0,070
SVAC R/L 1010 M11	10	10	150	26	10	VC.. 1103..	0,100
SVAC R/L 1212 M11	12	12	150	26	12	VC.. 1103..	0,140
SVAC R/L 1616 M11	16	16	150	26	16	VC.. 1103..	0,270
SVAC R/L 1212 M16	12	12	150	40	12	VC.. 1604..	0,140
SVAC R/L 1616 M16	16	16	150	40	16	VC.. 1604..	0,270

Reference Bezeichnung			Nm
SVAC R/L 0808 M11	1225	5507	0.9
SVAC R/L 1010 M11	1225	5507	0.9
SVAC R/L 1212 M11	1225	5507	0.9
SVAC R/L 1616 M11	1225	5507	0.9
SVAC R/L 1212 M16	1240	5515	3.0
SVAC R/L 1616 M16	1240	5515	3.0

VC.. 35° rhombic positive inserts with 7° clearance. **i** A48
35° rhombische positive Wendeschneidplatten mit 7° Freiwinkel.

Reference / Bez.	l	s	d
VC.. 1103..	11,00	3,18	6,35
VC.. 1604..	16,50	4,76	9,52

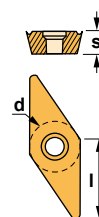

VC GT-AL



VC GT-AP



VC MT



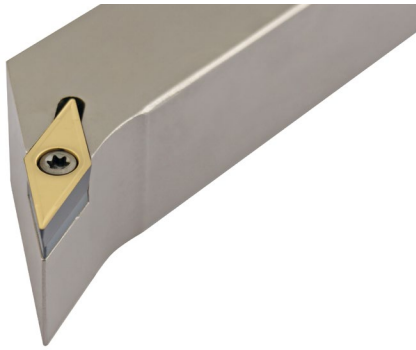

Characteristics:

Multipurpose profiling toolholder equipped with rhombic positive insert (angle 35°).
For general applications, semi-finishing and finishing.

Axial 0°
Radial 0°

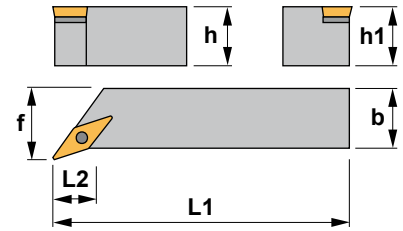

Eigenschaften:

Multifunktions-Klemmhalter zum Profildrehen mit rhombischen positiven Wendeschneidplatten (35° Winkel).

Für allgemeine Anwendungen, Schruppen, Vorschlichten und Schlichten.

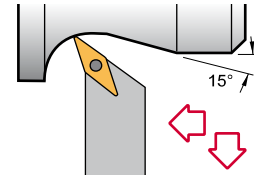

SVHC 107°30'

Reference Bezeichnung	h=h1	b	L1	L2	f	Insert size Wendeschneidplatte	Kg
SVHC R/L 2020 K16	20	20	125	28	25	VC.. 1604..	0,400
SVHC R/L 2525 M16	25	25	150	28	32	VC.. 1604..	0,700
SVHC R/L 3225 P16	32	25	170	34	32	VC.. 1604..	0,900
SVHC R/L 2525 M22	25	25	150	28	32	VC.. 2205..	0,700
SVHC R/L 3225 P22	32	25	170	34	32	VC.. 2205..	0,900

Reference Bezeichnung					Nm
SVHC R/L 2020 K16	1335	5516	3718	1750	3.0
SVHC R/L 2525 M16	1335	5516	3718	1750	3.0
SVHC R/L 3225 P16	1335	5516	3718	1750	3.0
SVHC R/L 2525 M22	1540	5520	3722	1760	3.0
SVHC R/L 3225 P22	1540	5520	3722	1760	3.0

VC.. 35° rhombic positive inserts with 7° clearance. A48
35° rhombische positive Wendeschneidplatten mit 7° Freiwinkel.

Reference / Bez.	l	s	d
VC.. 1604..	16,50	4,76	9,52
VC.. 2205..	22,10	5,56	12,70

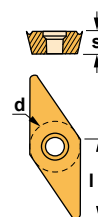

VCGT-AL



VCGT-AP



VCMT





Characteristics:

Multipurpose profiling toolholder equipped with rhombic 5° positive insert (angle 35°). For toolholders with negative inserts see Ref. MVJN-K (Page: A89).

Axial 0°
Radial 0°

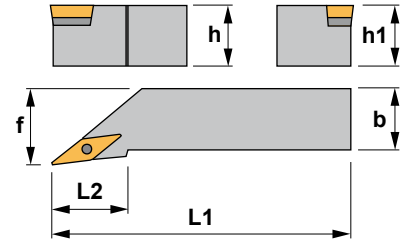

Eigenschaften:

Multifunktions-Klemmhalter zum Profildrehen mit 5° rhombischen positiven Wendeschneidplatten (35° Winkel).

Für Klemmhalter mit negativen Wendeschneidplatten, siehe MVJN-K (Seite: A89).

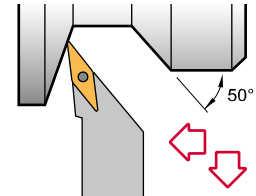

SVJB 93°

Reference Bezeichnung	h=h1	b	L1	L2	f	Insert size Wendeschneidplatte	Kg
SVJB R/L 2020 K16	20	20	125	34	25	VBMT 1604..	0,400
SVJB R/L 2525 M16	25	25	150	34	32	VBMT 1604..	0,700
SVJB R/L 3225 P16	32	25	170	38	32	VBMT 1604..	0,900

Reference Bezeichnung					Nm
SVJB R/L 2020 K16	1335	5516	3718	1750	3.0
SVJB R/L 2525 M16	1335	5516	3718	1750	3.0
SVJB R/L 3225 P16	1335	5516	3718	1750	3.0

VBMT

35° rhombic positive insert with 5° clearance. A48
35° rhombische positive Wendeschneidplatte mit 5° Freiwinkel. A48

Reference / Bez.	l	s	d
VBMT 1604..	16,50	4,76	9,52

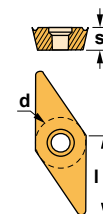

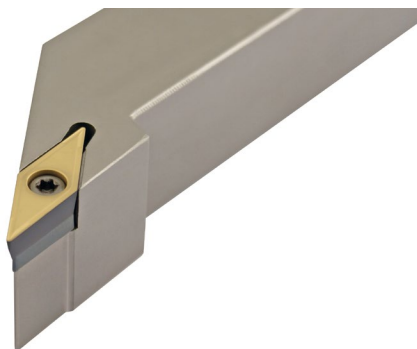

Characteristics:

Multipurpose profiling toolholder equipped with rhombic positive insert (angle 35°). For toolholders with negative inserts see Ref. MVJN-K (Page: A89).

Axial 0°
Radial 0°

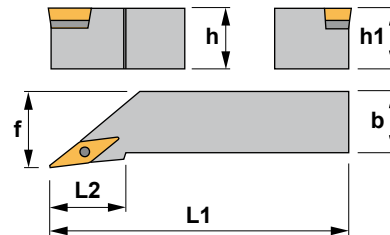

Eigenschaften:

Multifunktions-Klemmhalter zum Profildrehen mit rhombischen positiven Wendschneidplatten (35° Winkel). Für Klemmhalter mit negativen Wendschneidplatten, siehe MVJN-K (Seite: A89).

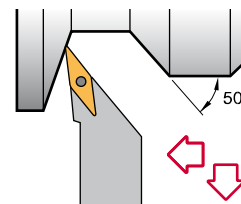

SVJC 93°

Reference Bezeichnung	h=h1	b	L1	L2	f	Insert size Wendschneidplatte	Kg
SVJC R/L 1212 F11	12	12	80	20	16	VC.. 1103..	0,100
SVJC R/L 1616 H11	16	16	100	25	20	VC.. 1103..	0,200
SVJC R/L 2020 K11	20	20	125	28	25	VC.. 1103..	0,400
SVJC R/L 2525 M11	25	25	150	28	32	VC.. 1103..	0,700
SVJC R/L 2020 K16	20	20	125	34	25	VC.. 1604..	0,400
SVJC R/L 2525 M16	25	25	150	34	32	VC.. 1604..	0,700
SVJC R/L 3225 P16	32	25	170	34	32	VC.. 1604..	0,900

Reference Bezeichnung					Nm
SVJC R/L 1212 F11	1225	5507	-	-	0.9
SVJC R/L 1616 H11	1225	5507	-	-	0.9
SVJC R/L 2020 K11	1225	5507	-	-	0.9
SVJC R/L 2525 M11	1225	5507	-	-	0.9
SVJC R/L 2020 K16	1335	5516	3718	1750	3.0
SVJC R/L 2525 M16	1335	5516	3718	1750	3.0
SVJC R/L 3225 P16	1335	5516	3718	1750	3.0

VC.. 35° rhombic positive inserts with 7° clearance. A48
35° rhombische positive Wendschneidplatten mit 7° Freiwinkel.

Reference / Bez.	l	s	d
VC.. 1103..	11,00	3,18	6,35
VC.. 1604..	16,50	4,76	9,52

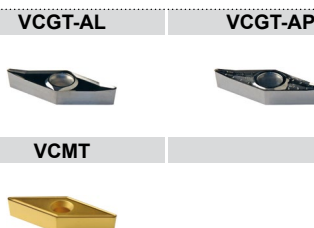
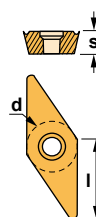

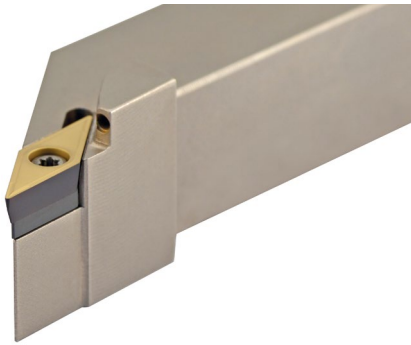

Characteristics:

Multipurpose profiling toolholder equipped with rhombic positive insert (angle 35°). For toolholders with negative inserts see Ref. MVJN-K (Page: A89).

Axial 0°
Radial 0°

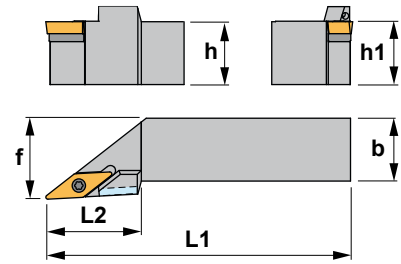

Eigenschaften:

Multifunktions-Klemmhalter zum Profildrehen mit rhombischen positiven Wendschneidplatten (35° Winkel). Für Klemmhalter mit negativen Wendschneidplatten, siehe MVJN-K (Seite: A89).

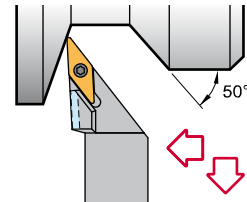

SVJC 93°-A

Reference Bezeichnung	h=h1	b	L1	L2	f	Insert size Wendschneidplatte	Kg
SVJC R/L 2020 K11-A	20	20	125	28	25	VC.. 1103..	0,400
SVJC R/L 2020 K16-A	20	20	125	34	25	VC.. 1604..	0,400
SVJC R/L 2525 M16-A	25	25	150	34	32	VC.. 1604..	0,700

Reference Bezeichnung					Nm
SVJC R/L 2020 K11-A	1225	5507	-	-	0.9
SVJC R/L 2020 K16-A	1335	5516	3718	1750	3.0
SVJC R/L 2525 M16-A	1335	5516	3718	1750	3.0

VC.. 35° rhombic positive inserts with 7° clearance. A48
35° rhombische positive Wendschneidplatten mit 7° Freiwinkel.

Reference / Bez.	l	s	d
VC.. 1103..	11,00	3,18	6,35
VC.. 1604..	16,50	4,76	9,52

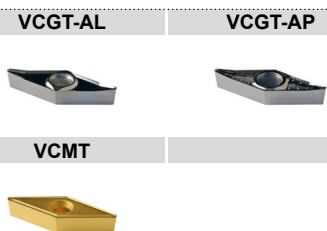
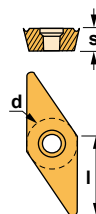



Characteristics:
Multipurpose profiling toolholder equipped with rhombic positive insert (angle 35°).
For general applications, roughing, semi-finishing and finishing.

Axial 0°
Radial 0°

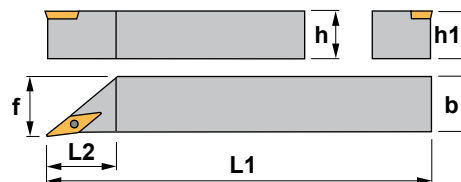

Eigenschaften:
Multifunktions-Klemmhalter zum Profildrehen mit rhombischen positiven Wendeschneidplatten (35° Winkel).
Für allgemeine Anwendungen geeignet (Schlichten, Medium und Schruppen).

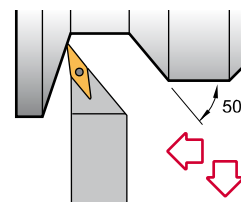

SVJC 93°

i Automatic lathes
Drehautomaten

Reference Bezeichnung	h=h1	b	L1	L2	f	Insert size Wendeschneidplatte	kg
SVJC R/L 0808 M11	8	8	150	26	8	VC.. 1103..	0,070
SVJC R/L 1010 M11	10	10	150	26	10	VC.. 1103..	0,100
SVJC R/L 1212 M11	12	12	150	26	12	VC.. 1103..	0,140
SVJC R/L 1616 M11	16	16	150	26	16	VC.. 1103..	0,270
SVJC R/L 1212 M16	12	12	150	40	12	VC.. 1604..	0,140
SVJC R/L 1616 M16	16	16	150	40	16	VC.. 1604..	0,270

Reference Bezeichnung			Nm
SVJC R/L 0808 M11	1225	5507	0.9
SVJC R/L 1010 M11	1225	5507	0.9
SVJC R/L 1212 M11	1225	5507	0.9
SVJC R/L 1616 M11	1225	5507	0.9
SVJC R/L 1212 M16	1240	5515	3.0
SVJC R/L 1616 M16	1240	5515	3.0

VC.. 35° rhombic positive inserts with 7° clearance. **i** A48
35° rhombische positive Wendeschneidplatten mit 7° Freiwinkel.

Reference / Bez.	l	s	d
VC.. 1103..	11,00	3,18	6,35
VC.. 1604..	16,50	4,76	9,52

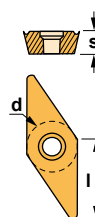

VCGT-AL



VCGT-AP



VCMT



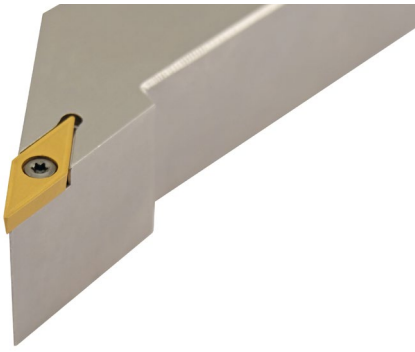

Characteristics:

Multipurpose profiling toolholder equipped with rhombic positive insert (angle 35°).
For general applications, semi-finishing and finishing.

Axial 0°
Radial 0°

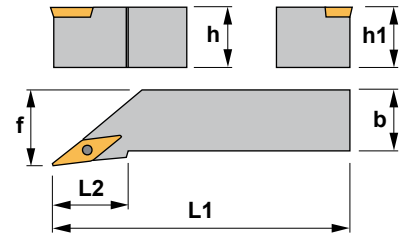

Eigenschaften:

Multifunktions-Klemmhalter zum Profildrehen mit positiven rhombischen Wendeschneidplatten (35° Winkel).

Für allgemeine Anwendungen, Schruppen, Vorschlichten und Schlichten.

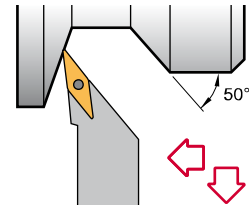

SVLC 95°

Reference Bezeichnung	h=h1	b	L1	L2	f	Insert size Wendeschneidplatte	Kg
SVLC R/L 1212 G13	12	12	90	25	16	VCMT 1303..	0,100
SVLC R/L 1616 H13	16	16	100	25	20	VCMT 1303..	0,200
SVLC R/L 2020 K13	20	20	125	28	25	VCMT 1303..	0,400
SVLC R/L 2525 M13	25	25	150	28	32	VCMT 1303..	0,700

Reference Bezeichnung			Nm
SVLC R/L 1212 G13	1230	5508	1.2
SVLC R/L 1616 H13	1230	5508	1.2
SVLC R/L 2020 K13	1230	5508	1.2
SVLC R/L 2525 M13	1230	5508	1.2

VCMT

35° rhombic positive insert with 7° clearance. A48
35° rhombische positive Wendeschneidplatte mit 7° Freiwinkel.

Reference / Bez.	l	s	d
VCMT 1303..	13,00	3,18	8,00

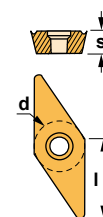

VCMT





Characteristics:

Multipurpose profiling toolholder equipped with rhombic 5° positive insert (angle 35°). For toolholders with negative inserts see Ref. MVVN-K (Page: A91).

Axial 0°
Radial 0°

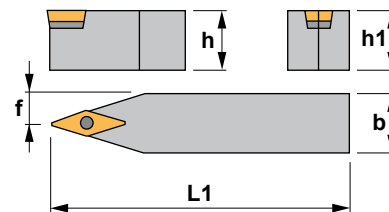

Eigenschaften:

Multifunktions-Klemmhalter zum Profildrehen mit 5° rhombischen positiven Wendeschneidplatten (35° Winkel). Für Klemmhalter mit negativen Wendeschneidplatten, siehe MVVN-K (Seite: A91).

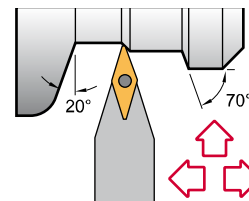

SVVB 72°30'

Reference Bezeichnung	h=h1	b	L1	f	Insert size Wendeschneidplatte	kg
SVVB N 2020 K16	20	20	125	10,6	VBMT 1604..	0,400
SVVB N 2525 M16	25	25	150	13,1	VBMT 1604..	0,700
SVVB N 3225 P16	32	25	170	13,1	VBMT 1604..	0,900

Reference Bezeichnung					Nm
SVVB N 2020 K16	1335	5516	3718	1750	3.0
SVVB N 2525 M16	1335	5516	3718	1750	3.0
SVVB N 3225 P16	1335	5516	3718	1750	3.0

VBMT

35° rhombic positive insert with 5° clearance. A48
35° rhombische positive Wendeschneidplatte mit 5° Freiwinkel. A48

Reference / Bez.

l

s

d

VBMT 1604..

16,50

4,76

9,52

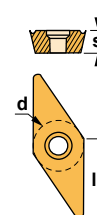

VBMT





Characteristics:

Multipurpose profiling toolholder equipped with rhombic positive insert (angle 35°).
For toolholders with negative inserts see Ref. MVVN-K (Page: A91).

Axial 0°
Radial 0°

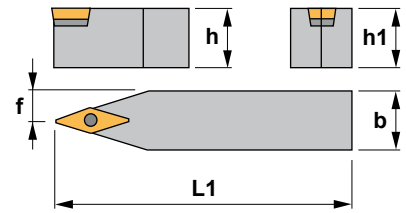

Eigenschaften:

Multifunktions-Klemmhalter zum Profildrehen mit rhombischen positiven Wendeschneidplatten (35° Winkel).

Für Klemmhalter mit negativen Wendeschneidplatten, siehe MVVN-K (Seite: A91).

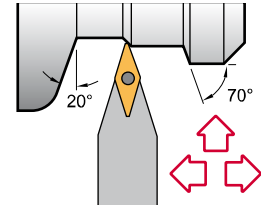

SVVC 72°30'

Reference Bezeichnung	h=h1	b	L1	f	Insert size Wendeschneidplatte	kg
SVVC N 1212 F11	12	12	80	6,6	VC.. 1103..	0,100
SVVC N 1616 H11	16	16	100	8,6	VC.. 1103..	0,200
SVVC N 2020 K11	20	20	125	10,6	VC.. 1103..	0,400
SVVC N 2020 K16	20	20	125	10,6	VC.. 1604..	0,400
SVVC N 2525 M16	25	25	150	13,1	VC.. 1604..	0,700
SVVC N 3225 P16	32	25	170	13,1	VC.. 1604..	0,900

Reference Bezeichnung					Nm
SVVC N 1212 F11	1225	5507	-	-	0.9
SVVC N 1616 H11	1225	5507	-	-	0.9
SVVC N 2020 K11	1225	5507	-	-	0.9
SVVC N 2020 K16	1335	5516	3718	1750	3.0
SVVC N 2525 M16	1335	5516	3718	1750	3.0
SVVC N 3225 P16	1335	5516	3718	1750	3.0

VC.. 35° rhombic positive inserts with 7° clearance. A48
35° rhombische positive Wendeschneidplatten mit 7° Freiwinkel.

Reference / Bez.	l	s	d
VC.. 1103..	11,00	3,18	6,35
VC.. 1604..	16,50	4,76	9,52

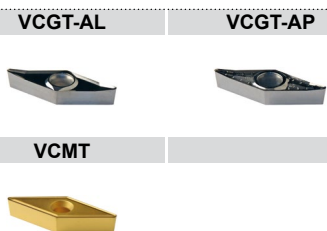
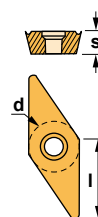

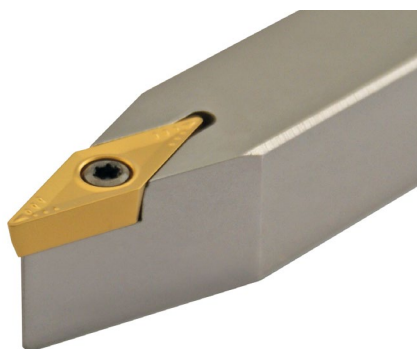

Characteristics:
Multipurpose profiling toolholder equipped with rhombic 5° positive insert (angle 35°).
For general applications, roughing, semi-finishing and finishing.

Axial 0°
Radial 0°

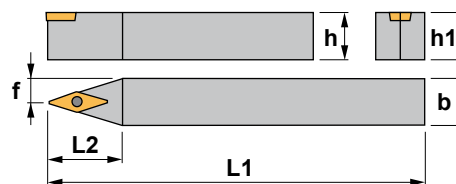

Eigenschaften:
Multifunktions-Klemmhalter zum Profildrehen mit 5° rhombischen positiven Wendeschneidplatten (35° Winkel).
Für allgemeine Anwendungen geeignet (Schlichten, Medium und Schruppen).

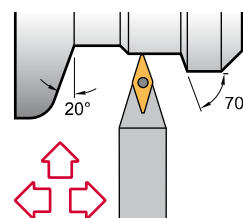

SVVC 72°30'

i Automatic lathes
Drehautomaten

Reference Bezeichnung	h=h1	b	L1	L2	f	Insert size Wendeschneidplatte	Kg
SVVC N 0808 M11	8	8	150	21	4,3	VC.. 1103..	0,070
SVVC N 1010 M11	10	10	150	21	5,3	VC.. 1103..	0,100
SVVC N 1212 M11	12	12	150	21	6,3	VC.. 1103..	0,140
SVVC N 1616 M11	16	16	150	21	8,3	VC.. 1103..	0,260

Reference Bezeichnung			Nm
SVVC N 0808 M11	1225	5507	0.9
SVVC N 1010 M11	1225	5507	0.9
SVVC N 1212 M11	1225	5507	0.9
SVVC N 1616 M11	1225	5507	0.9

VC.. 35° rhombic positive inserts with 7° clearance. **i** A48
35° rhombische positive Wendeschneidplatten mit 7° Freiwinkel.

Reference / Bez.	l	s	d
VC.. 1103..	11,00	3,18	6,35

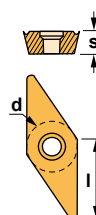

VCGT-AL **VCGT-AP**



VCMT



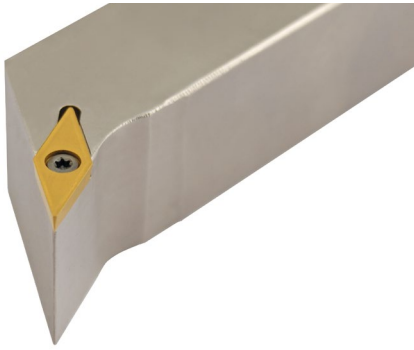

Characteristics:

Multipurpose profiling toolholder equipped with rhombic positive insert (angle 35°). For general applications, semi-finishing and finishing.

Axial 0°
Radial 0°

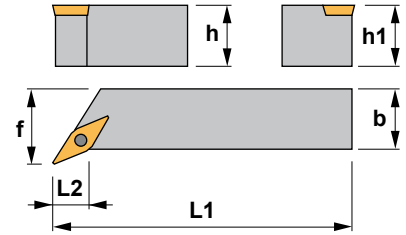

Eigenschaften:

Multifunktions-Klemmhalter zum Profildrehen mit rhombischen positiven Wendeschneidplatten (35° Winkel).

Für allgemeine Anwendungen, Schruppen, Vorschlichten und Schlichten.

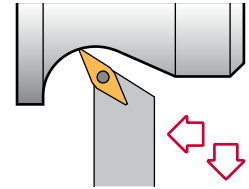

SVXC 113°

Reference Bezeichnung	h=h1	b	L1	L2	f	Insert size Wendeschneidplatte	Kg
SVXC R/L 1212 G13	12	12	90	11,5	16	VCMT 1303..	0,100
SVXC R/L 1616 H13	16	16	100	13,8	20	VCMT 1303..	0,200
SVXC R/L 2020 K13	20	20	125	28,0	25	VCMT 1303..	0,400
SVXC R/L 2525 M13	25	25	150	28,0	32	VCMT 1303..	0,700

Reference Bezeichnung			Nm
SVXC R/L 1212 G13	1230	5508	1.2
SVXC R/L 1616 H13	1230	5508	1.2
SVXC R/L 2020 K13	1230	5508	1.2
SVXC R/L 2525 M13	1230	5508	1.2

VCMT

35° rhombic positive insert with 7° clearance. A48
35° rhombische positive Wendeschneidplatte mit 7° Freiwinkel.

Reference / Bez.

l

s

d

VCMT 1303..

13,00

3,18

8,00

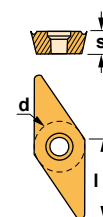

VCMT



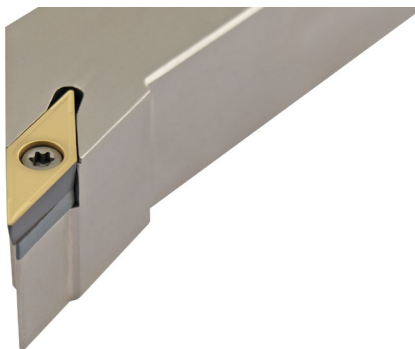

Characteristics:

Multipurpose profiling toolholder equipped with rhombic positive insert (angle 35°).
For general applications, semi-finishing and finishing.

Axial 0°
Radial 0°

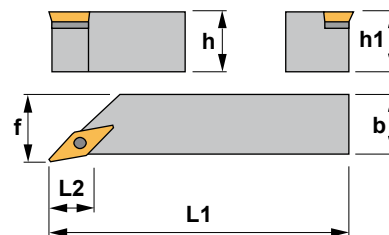

Eigenschaften:

Multifunktions-Klemmhalter zum Profildrehen mit rhombischen positiven Wendeschneidplatten (35° Winkel).

Für allgemeine Anwendungen, Schruppen, Vorschlichten und Schlichten.

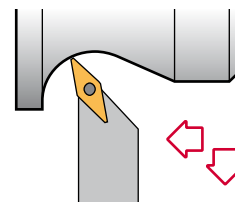

SVZC 100°

Reference Bezeichnung	h=h1	b	L1	L2	f	Insert size Wendeschneidplatte	Kg
SVZC R/L 2020 K16	20	20	125	28	25	VC.. 1604..	0,400
SVZC R/L 2525 M16	25	25	150	34	32	VC.. 1604..	0,700
SVZC R/L 3225 P16	32	25	170	34	32	VC.. 1604..	0,900

Reference Bezeichnung					Nm
SVZC R/L 2020 K16	1335	5516	3718	1750	3.0
SVZC R/L 2525 M16	1335	5516	3718	1750	3.0
SVZC R/L 3225 P16	1335	5516	3718	1750	3.0

VC.. 35° rhombic positive inserts with 7° clearance. A48
35° rhombische positive Wendeschneidplatten mit 7° Freiwinkel.

Reference / Bez.	l	s	d
VC.. 1604..	16,50	4,76	9,52

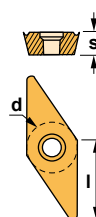

VCGT-AL	VCGT-AP
VCMT	



Nominal cutting speed and feed values for toolholders

Material	P	HB	Condition	Cutting speed m/min.						Specific cutting force Kc 0,4
				PM25	PM40	NC25	TN15	TN20	TN30	
				0.3-0.6-1.2		0.1-0.3	0.1-0.4-0.8	0.1-0.4-0.8	0.2-0.5-1.2	
Unalloyed steel	125	C=0.15% C=0.35% C=0.60%		150 115 80		350 280	480 345 250	440 300 205	330 230 110	1900
	150			145 105 70		270 230	440 315 230	400 275 190	300 210 150	2100
	200			115 90 65		240 190	385 275 200	350 240 165	260 185 130	2250
Low alloyed steel	180	Annealed Hardened Hardened Hardened		90 70 45		300 260	380 265 195	320 220 170	200 140 100	2100
	275			65 45 30		220 140	260 180 130	215 150 115	140 100 70	2600
	300			60 40 25		230 180	240 165 120	200 135 105	125 90 60	2700
	350			50 35 20		220 140	210 145 105	170 120 90	110 75 55	2850
High alloyed steel	200	Annealed Hardened		80 60 45		200 160	350 230 170	280 185 135	175 115 80	2600
	325			40 25 20		200 160	170 110	120 80 60	85 55 40	3900
Stainless steel	200	Martensitic / ferritic		110 95 75		270 130	295 240 190	275 210 165	225 180 145	2300
Steel castings	180	Unalloyed Low alloyed High alloyed		60 50 35		300 260	260 185 145	230 160 120	135 105 75	2000
	200			50 45 30		230 180	230 160 120	190 125 85	120 90 60	2500
	225			40 30 20		220 140	190 130 95	170 115 80	95 70 55	2700

Material	M	HB	Condition	Cutting speed m/min.						Specific cutting force Kc 0,4		
				PM25	NC25	TN15	TN20	TN30	TN35		TS15	TS20
				0.1-0.3	0.1-0.3	0.1-0.4-0.8		0.2-0.4-0.6	0.2-0.4-0.6		0.1-0.3	
Stainless steel annealed	180	Austenitic Ni > 8%, Cr 12-25% austenitic/ ferritic, austenitic/ ferritic, low S		240 200	180 150 120			190 160 130	190 160 130	240 200	120 180	2450
				160 130	180 150 120			190 160 100	190 160 130	160 130	130 220	
				160 130	180 150 120			140 110	160 130 100	160 130	120 180	

Material	K	HB	Condition	Cutting speed m/min.						Specific cutting force Kc 0,4
				KM15	NC25	TN15	TN20	TK15	ZR10	
				0.2-0.5-1.0	0.2-0.5	0.2-0.5-1.0		0.2-0.5-1.0	0.2-0.5-1.0	
Hardened steel	350	Hardened steel Manganese steel 12%		27 16 10		175 145 100		180 150 110		4500
	250			65 40 16		120 85 50		120 90 60		3600
Malleable cast iron	130	Ferritic Pearlitic		105 75 45		225 150 90		250 180 100		1100
	230			80 60 30		155 95 55		160 100 60		1100
Cast iron	180	Low tensile strength High tensile strength		135 95 60	300 200	165 110 70		180 120 80		1100
	260			95 65 40	250 180	120 90 55		140 105 60		1500
Nodular SG iron	160	Ferritic Pearlitic		115 80 45	250 180			220 180 100		1100
	250			80 50 30	180 120			150 100 50		1800
Chilled cast iron	400			17 11				17 11		3000

Material	N	HB	Condition	Cutting speed m/min.						Specific cutting force Kc 0,4
				KM15	TK15	NC25	TN15	TN20	ZR10	
				0.2-0.5-1.0	0.2-0.5-1.0	0.2-0.5	0.2-0.5-1.0		0.2-0.5-1.0	
Aluminium alloys	60	Non heat treatable Heat treatable		1750 1280 800					1750 1280 800	500
	100			510 370 250					510 370 250	800
Aluminium alloys (cast)	75	Non heat treatable Heat treatable		460 285 175					460 285 175	750
	90			300 180 110					300 180 110	900
Bronze-brass alloys	110	Lead alloys, Pb>1% Brass and bronze Inc. electrolytic copper		610 430 295					610 430 295	700
	90			310 250 195					310 250 195	750
	100			225 160 115					225 160 115	1750
Other materials		Hard plastics Fibre Hard rubber		380 240					380 240	
				190 120					190 120	
				225 160					225 160	

Material	S	HB	Condition	Cutting speed m/min.						Specific cutting force Kc 0,4
				KM15	NC25	TN15	TS15	TS20	ZR10	
				0.2-0.5-1.0	0.2-0.5	0.2-0.5-1.0			0.2-0.5-1.0	
Heat-resistant alloys		Fe-base Nickel or cobalt base Nickel or cobalt base Nickel or cobalt base						80 120		
							60 100			
							35 90			
							30 50			
Titanium alloys		Titanium					70 120			



Nennschnittgeschwindigkeit und Vorschub-Werte für Klemmhalter

Materialien	P	HB	Beschaffenheit	Schnittgeschwindigkeit m/min.					Spezifische Schnittkraft Kc 0,4	
				PM25	PM40	NC25	TN15	TN20		TN30
				0.3-0.6-1.2		0.1-0.3	0.1-0.4-0.8	0.1-0.4-0.8		0.2-0.5-1.2
Unlegierter Stahl	125	C=0.15%		150 115 80		350 280	480 345 250	440 300 205	330 230 110	1900
	150	C=0.35%		145 105 70		270 230	440 315 230	400 275 190	300 210 150	2100
	200	C=0.60%		115 90 65		240 190	385 275 200	350 240 165	260 185 130	2250
Niedriglegierter Stahl	180	Geglüht		90 70 45		300 260	380 265 195	320 220 170	200 140 100	2100
	275	Vergütet		65 45 30		220 140	260 180 130	215 150 115	140 100 70	2600
	300	Vergütet		60 40 25		230 180	240 165 120	200 135 105	125 90 60	2700
	350	Vergütet		50 35 20		220 140	210 145 105	170 120 90	110 75 55	2850
Hochlegierter Stahl	200	Geglüht		80 60 45		200 160	350 230 170	280 185 135	175 115 80	2600
	325	Vergütet		40 25 20		200 160	170 110	120 80 60	85 55 40	3900
Rostfreier Stahl	200	Martensitisch/ Ferritisch		110 95 75		270 130	295 240 190	275 210 165	225 180 145	2300
Stahlguß	180	Unlegiert		60 50 35		300 260	260 185 145	230 160 120	135 105 75	2000
	200	Niedriglegiert		50 45 30		230 180	230 160 120	190 125 85	120 90 60	2500
	225	Hochlegiert		40 30 20		220 140	190 130 95	170 115 80	95 70 55	2700

Materialien	M	HB	Beschaffenheit	Schnittgeschwindigkeit m/min.						Spezifische Schnittkraft Kc 0,4		
				PM25	NC25	TN15	TN20	TN30	TN35		TS15	TS20
				0.1-0.3	0.1-0.3	0.1-0.4-0.8		0.2-0.4-0.6	0.2-0.4-0.6		0.1-0.3	
Rostfreier Stahl, geglüht	180	Austenitisch Ni > 8%, Cr 12-25% Austenitisch/ Ferritisch, Austenitisch/ Ferritisch, niedriger S-Anteil		240 200	180 150 120			190 160 130	190 160 130	240 200	120 180	2450
				160 130	180 150 120			190 160 100	190 160 130	160 130	130 220	
				160 130	180 150 120			140 110	160 130 100	160 130	120 180	

Materialien	K	HB	Beschaffenheit	Schnittgeschwindigkeit m/min.						Spezifische Schnittkraft Kc 0,4
				KM15	NC25	TN15	TN20	TK15	ZR10	
				0.2-0.5-1.0	0.2-0.5	0.2-0.5-1.0		0.2-0.5-1.0	0.2-0.5-1.0	
Gehärteter Stahl	350	Vergüteter Stahl		27 16 10		175 145 100		180 150 110		4500
			250	Mangan-Stahl 12%	65 40 16		120 85 50		120 90 60	
Temperguß	130	Ferritisch		105 75 45		225 150 90		250 180 100		1100
			230	Perlitisch	80 60 30		155 95 55		160 100 60	
Guß	180	Niedrige Zugfestigkeit		135 95 60	300 200	165 110 70		180 120 80		1100
			260	Hohe Zugfestigkeit	95 65 40	250 180	120 90 55		140 105 60	
SG-Kugelgraphitguß	160	Ferritisch		115 80 45	250 180			220 180 100		1100
			250	Perlitisch	80 50 30	180 120			150 100 50	
Kaltverfestigender Guß	400			17 11				17 11		3000

Materialien	N	HB	Beschaffenheit	Schnittgeschwindigkeit m/min.						Spezifische Schnittkraft Kc 0,4	
				KM15	TK15	NC25	TN15	TN20	ZR10		
				0.2-0.5-1.0	0.2-0.5-1.0	0.2-0.5	0.2-0.5-1.0		0.2-0.5-1.0		
Aluminium-Legierungen	60	Nicht wärmebehandelbar		1750 1280 800					1750 1280 800	500	
			100	Wärmebehandelbar	510 370 250					510 370 250	800
Gegossene Aluminium-Legierungen	75	Nicht wärmebehandelbar		460 285 175					460 285 175	750	
			90	Wärmebehandelbar	300 180 110					300 180 110	900
Bronze- und Messinglegierungen	110	Bleilegierungen, Pb>1%		610 430 295					610 430 295	700	
			90	Messing, Bronze		310 250 195				310 250 195	750
					100	Elektrolytkupfer	225 160 115				225 160 115
Andere Materialien		Hartkunststoff		380 240					380 240		
			Faser		190 120					190 120	
				Hartgummi	225 160					225 160	

Materialien	S	HB	Beschaffenheit	Schnittgeschwindigkeit m/min.					Spezifische Schnittkraft Kc 0,4	
				KM15	NC25	TN15	TS15	TS20		ZR10
				0.2-0.5-1.0	0.2-0.5	0.2-0.5-1.0				0.2-0.5-1.0
Wärmefeste Legierungen			Fe-Basis Nickel- und Kobalthaltig Nickel- und Kobalthaltig Nickel- und Kobalthaltig					80 120		
								60 100		
								35 90		
								30 50		
Titan-Legierungen			Titan				70 120			

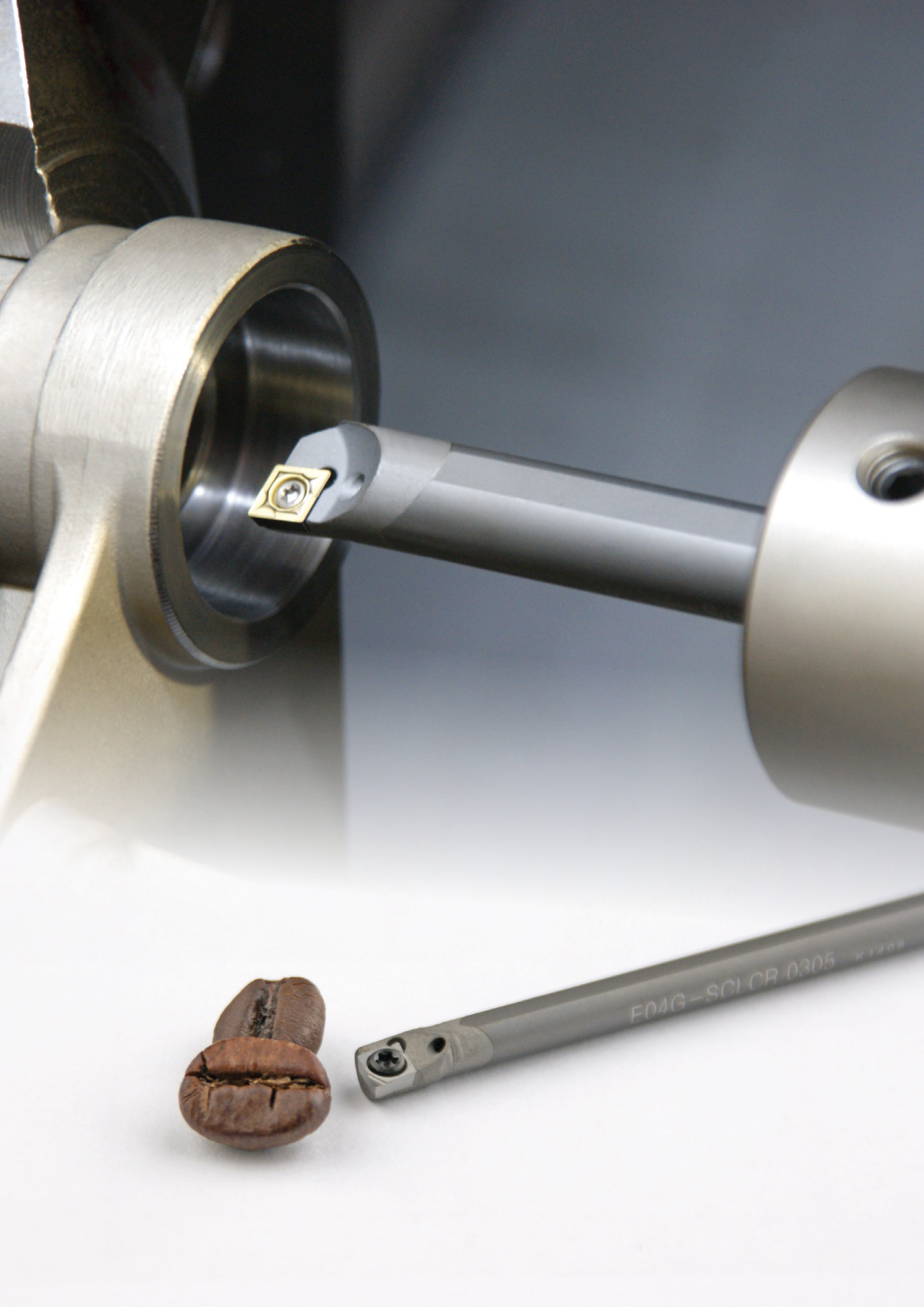



BORING BARS BOHRSTANGEN

Clamping systems Klemmsysteme	A170
Code system (ISO) Kodifizierung (ISO)	A171
Applications index Anwendungen	A172-174
Dimple lock boring bars Bohrstangen mit Dimple Lock-Klemmung	A176-177
Wedge clamp boring bars / Double lock boring bars Bohrstangen mit Prätzen-Klemmung / Bohrstangen mit Doppel-Klemmung	A178-186
Lever lock boring bars Bohrstangen mit Kniehebel-Klemmung	A187-199
Top clamp boring bars Bohrstangen mit oberer Klemmung	A200-203
Center screw boring bars Bohrstangen mit Zentralschrauben-Klemmung	A204-236
Anti-vibration tools Schwingungsgedämpfte Bohrstangen	A237-246
Cutting data Schnittdaten	A247-248

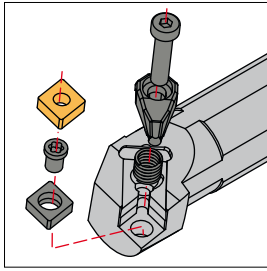
**(D) Dimple lock**

The "D" clamping system avoids insert movement during high feed or heavily interrupted machining, due to its accurate indexing that holds the insert securely clamped.
Das "D"-Klemmsystem vermeidet die Bewegung der Wendschneidplatte bei hohem Vorschub oder bei stark unterbrochener Bearbeitung dank der genauen Positionierung, die die Wendschneidplatte sicher befestigt.

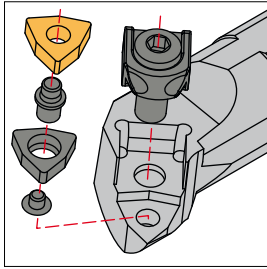
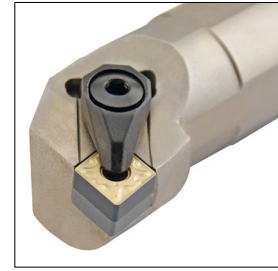
**(M) Wedge clamp
(M) Prätzen-Klemmung**

Negative inserts require good clamping force for heavy duty work, for this purpose we have designed our "M" system, one of the strongest and safest available.

Die negativen Wendeplatten für sehr schwere Zerspanungsarbeiten benötigen eine gute Klemmung, dafür bieten wir unser "M" Klemmsystem, das eines der stärksten und sichersten ist.

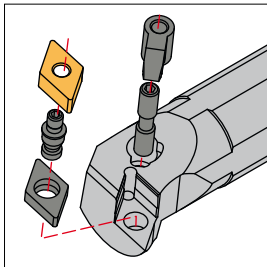
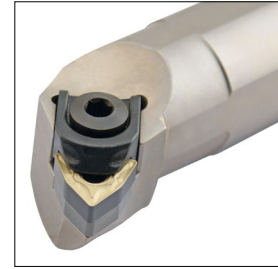
**(M-K) Double lock
(M-K) Doppel-Klemmung**

The double lock system offers good rigidity in negative inserts clamping. It is the first choice for center hole negative ceramic and cermet inserts.

Das doppelte Klemmsystem bietet eine gute Unbeweglichkeit bei der Klemmung von negativen Wendschneidplatten. Es ist die erste Wahl für negative Keramik-Wendschneidplatten mit zentralem Loch und auch für Cermet-Wendschneidplatten.

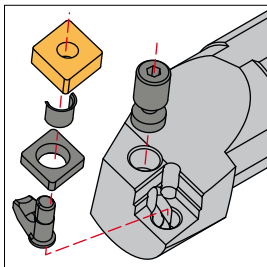
**(P) Lever lock
(P) Kniehebel-Klemmung**

The classic lever lock system allows a wide range of applications. It is the first choice for general purpose turning toolholders.

Das klassische Hebel-System erlaubt eine breite Reihe von Anwendungen. Es ist die erste Wahl für allgemeine Drehoperationen

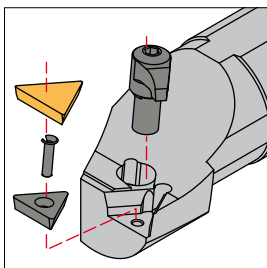
**(C) Top clamp
(C) Obere Klemmung**

The classic positive insert clamping system is designed to hold flat positive inserts, both with additional or sintered chipbreaker.

Dieses klassische Klemmsystem von positiven Wendeplatten erlaubt die Verwendung von allen Wendeplatten dieses Typs, in üblicher Sinterausführung sowohl als auch mit Spanbrecher.

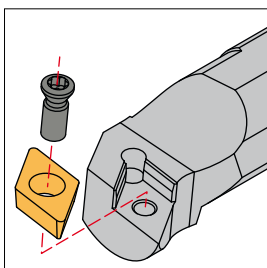
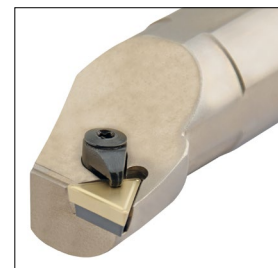
**(S) Center screw
(S) Zentralschrauben-Klemmung**

Since the advent of the TORX screw it has been possible to hold with complete safety positive inserts with center hole. Our range covers all the screw fixing permutations.

Seit der Einführung der Torx-Schraube ist es möglich, die positiven Wendschneidplatten mit zentralem Loch zu klemmen. Unser Programm bietet alle Klemmmöglichkeiten mit Schraube.





Code system / Kodifizierung (ISO)

S	25	T	S	D	U	C	R	11	-EX
1	2	3	4	5	6	7	8	9	10

1 Type of bar Schaft-Ausführung

A	Steel shank with internal coolant. Bohrstange aus Stahl mit Kühlmittelzufuhr.	
E	Anti-vibration shank (carbide) with internal coolant. Schwingungsgedämpfte Bohrstange (Hartmetall) mit Kühlmittelzufuhr.	
S	Steel shank Bohrstange aus Stahl	

2

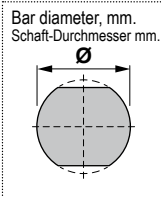

3 Bar length, mm Werkzeuglänge, mm

	H 100	T 300
	J 110	U 350
	K 125	V 400
	L 140	W 450
	M 150	Y 600
	Q 180	X Special Sonder
	R 200	
	S 250	

4 Clamping method of insert Klemmsystem

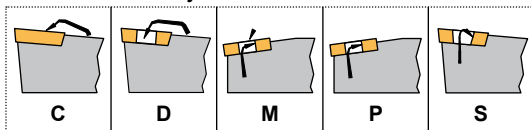

5 Insert shape Wendeschneidplatten-Form

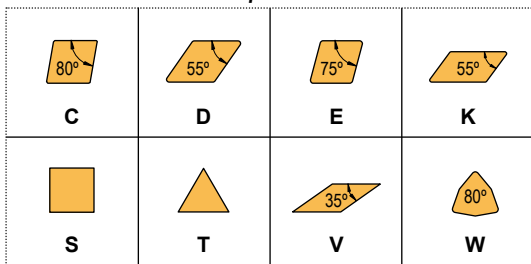

6 Holder style Einstellwinkel

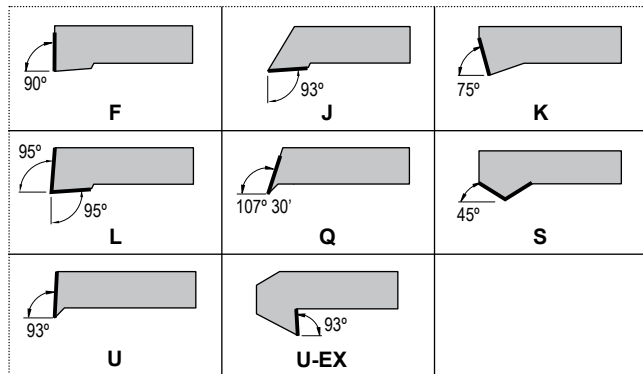

7 Clearance angle of insert Wendeschneidplatten-Freiwinkel

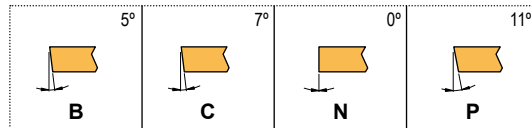

8 Hand Bearbeitungsrichtung

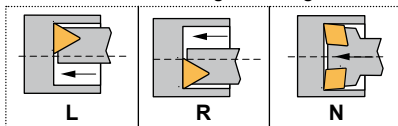

9 Cutting edge length, mm Schneidkantenlänge, mm.

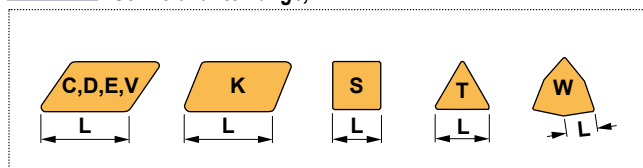

10

Manufacturer's option.
Herstellervahl.

NEGATIVE BORING BARS / NEGATIVE BOHRSTANGEN

■ Dimple lock boring bars Bohrstangen mit Dimple Lock-Klemmung

DCLN 95°-N

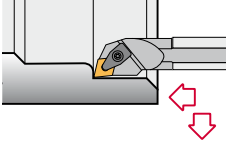

Page
Seite A176 CN.. 1204..

DDUN 93°-N

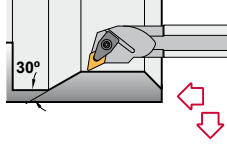

Page
Seite A177 DN.. 1506..

■ Wedge clamp / Double lock boring bars Bohrstangen mit Prätzen- und Doppel-Klemmung

MCLN-K 95°

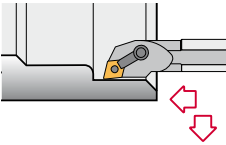

Page
Seite A178 CN.. 1204..

MDUN-K 93°

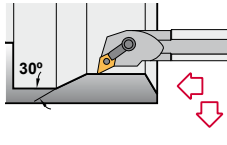

Page
Seite A179 DN.. 1506..

MSKN-K 75°

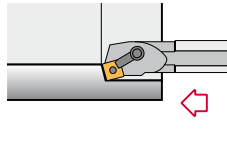

Page
Seite A180 SNM.. 1204..

MTFN 90°

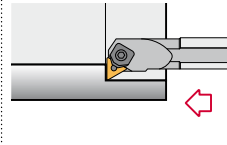

Page
Seite A181 TNM.. 1604..
TNM.. 2204..

MTFN-K 90°

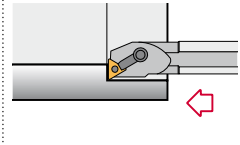

Page
Seite A182 TNM.. 1604..
TNM.. 2204..

MTUN 93°

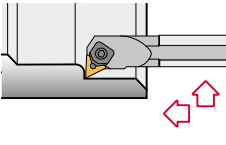

Page
Seite A183 TNM.. 1604..
TNM.. 2204..

MVUN-K 93°

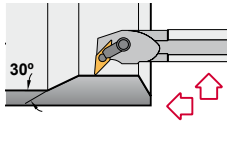

Page
Seite A184 VN.. 1604..

MWLN 95°

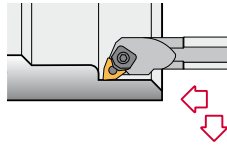

Page
Seite A185 WNM.. 0604..
WNM.. 0804..

MWLN-K 95°

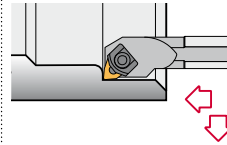

Page
Seite A186 WNMG 0804..

■ Lever lock boring bars Bohrstangen mit Kniehebel-Klemmung

PCKN 75°

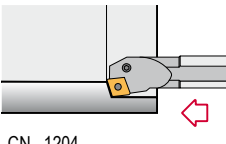

CN.. 1204..
CN.. 1606..
CN.. 1906.. Page
Seite A187

PCLN 95°

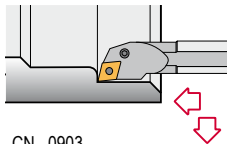

CN.. 0903..
.. Page
CN.. 1906.. Seite A188

A-PCLN 95°

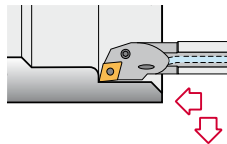

Page
Seite A189 CN.. 0903..
CN.. 1204..

PDUN 93°

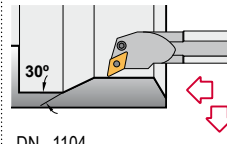

DN.. 1104..
DN.. 1504..
DN.. 1506.. Page
Seite A190

A-PDUN 93°

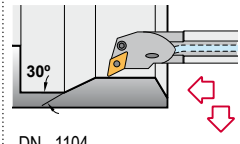

DN.. 1104..
DN.. 1504..
DN.. 1506.. Page
Seite A191

PDUN 93°-EX

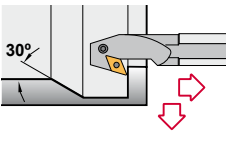

Page
Seite A192 DN.. 1504..
DN.. 1506..

PSKN 75°

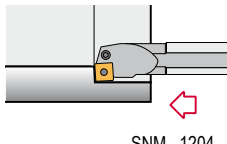

Page
Seite A193 SNM.. 1204..
SNM.. 1506..
SNM.. 1906..

A-PSKN 75°

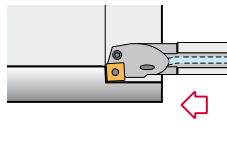

Page
Seite A194 SNM.. 1204..

A-PSSN 45°

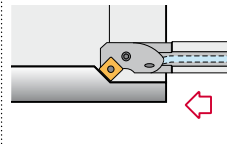

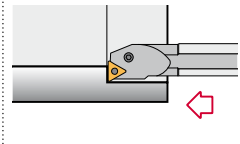

Page
Seite A195 SNM.. 1204..

PTFN 90°

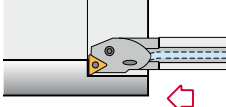
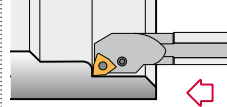

Page
Seite A196 TNM.. 1604..
TNM.. 2204..

Lever lock boring bars Bohrstangen mit Kniehebel-Klemmung

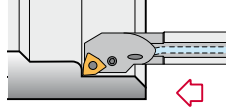





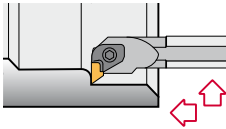
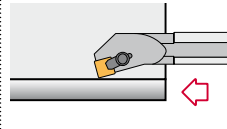
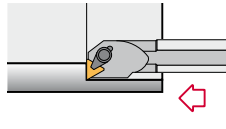
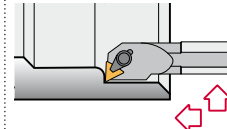



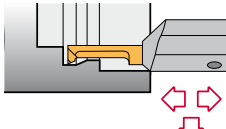
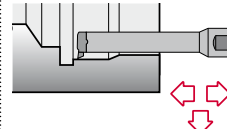
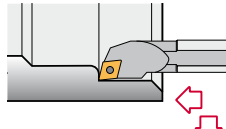

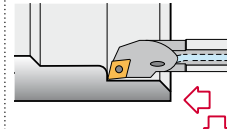

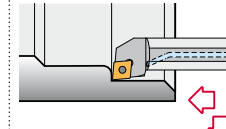
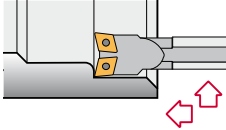
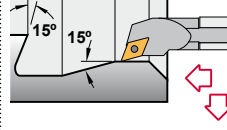
<p>A-PTFN 90° </p>  <p>Page TNM.. 1604.. Seite A197 TNM.. 2204..</p>	<p>PWLN 95°</p>  <p>Page WNM.. 0604.. Seite A198 WNM.. 0804..</p>	<p>A-PWLN 95° </p>  <p>Page WNM.. 0604.. Seite A199 WNM.. 0804..</p>		
---	---	---	--	--

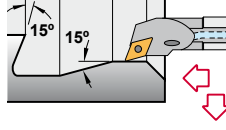
POSITIVE BORING BARS / POSITIVE BOHRSTANGEN

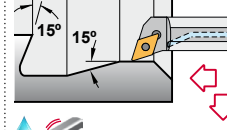
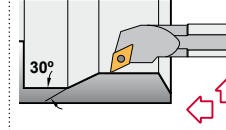
Top clamp boring bars Bohrstangen mit oberer Klemmung

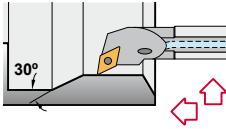

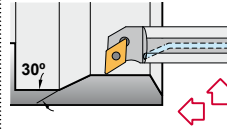
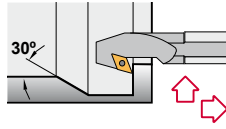
<p>CKUN 93°</p>  <p>Page KNUX 1604.. Seite A200</p>	<p>CSKP 75°</p>  <p>Page SP.. 0903.. Seite A201 SP.. 1203.. SP.. 1904..</p>	<p>CTFP 90°</p>  <p>Page TP.. 0902.. Seite A202 TP.. 2204..</p>	<p>CTUP 93°</p>  <p>Page TP.. 0902.. Seite A203 TP.. 2204..</p>	
--	--	--	---	--

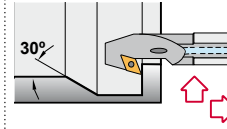
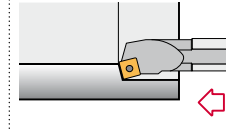
Center screw boring bars Bohrstangen mit Zentralschrauben-Klemmung

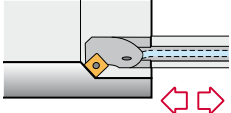
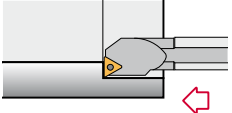
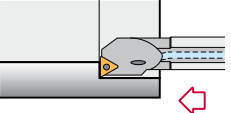
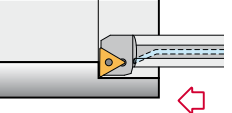
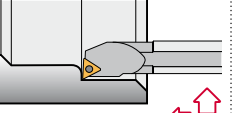
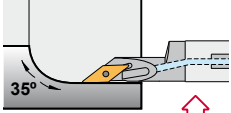
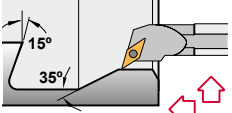

<p>00.30</p>  <p>Page CTI 04.. Seite A204 CTI 06..</p>	<p>608.00</p>  <p>Page R/LS 08.. Seite A206 R/LS 16..</p>	<p>SCLC 95°</p>  <p>Page CC.. 0602.. Seite A207 CC.. 09T3.. CC.. 1204..</p>	<p>A-SCLC 95° </p>  <p>Page CC.. 0602.. Seite A208 CC.. 09T3.. CC.. 1204..</p>	<p>E-SCLC 95°  </p>  <p>Page CC.. 0301.. Seite A210 CC.. 09T3..</p>
<p>SCLCN 95°</p>  <p>Page CC.. 0602.. Seite A212 CC.. 09T3.. CC.. 1204..</p>	<p>SDQC 107°30'</p>  <p>Page DC.. 0702.. Seite A213 DC.. 11T3..</p>	<p>A-SDQC 107°30' </p>  <p>Page DC.. 0702.. Seite A214 DC.. 11T3..</p>	<p>E-SDQC 107°30'  </p>  <p>Page DC.. 0702.. Seite A216 DC.. 11T3..</p>	<p>SDUC 93°</p>  <p>Page DC.. 0702.. Seite A217 DC.. 11T3..</p>
<p>A-SDUC 93° </p>  <p>Page DC.. 0702.. Seite A218 DC.. 11T3..</p>	<p>E-SDUC 93°  </p>  <p>Page DC.. 0702.. Seite A220 DC.. 11T3..</p>	<p>SDUC 93°-EX</p>  <p>Page DC.. 0702.. Seite A221 DC.. 11T3..</p>	<p>A-SDUC 93°-EX </p>  <p>Page DC.. 0702.. Seite A222 DC.. 11T3..</p>	<p>SSKC 75°</p>  <p>Page SC.. 09T3.. Seite A223 SC.. 1204..</p>

POSITIVE BORING BARS / POSITIVE BOHRSTANGEN

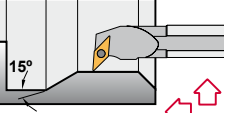
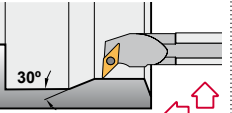
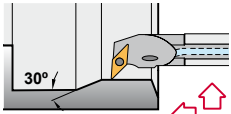
**Center screw boring bars
Bohrstangen mit Zentralschrauben-Klemmung**

<p>A-SSSC 45°</p>  <p>Page Seite A224 SC.. 09T3..</p>	<p>STFC 90°</p>  <p>TC.. 0902.. Page Seite A225 TC.. 1102.. TC.. 16T3..</p>	<p>A-STFC 90°</p>  <p>TC.. 0902.. Page Seite A226 TC.. 1102.. TC.. 16T3..</p>	<p>E-STFC 90°</p>  <p>Page Seite A228 TC.. 1102..</p>	<p>STUC 93°</p>  <p>Page Seite A229 TC.. 1102.. TC.. 16T3..</p>
<p>A-SVJC 93°</p>  <p>VC.. 1103.. Page Seite A230 VC.. 1604..</p>	<p>SVQC 107°30'</p>  <p>VC.. 1103.. Page Seite A232 VC.. 1303.. VC.. 1604..</p>	<p>A-SVQC 107°30'</p>  <p>Page Seite A233 VC.. 1103.. VC.. 1604..</p>	<p>SVUB 93°</p>  <p>Page Seite A234 VBMT 1604..</p>	<p>SVUC 93°</p>  <p>Page Seite A235 VC.. 1103.. VC.. 1604..</p>
<p>A-SVUC 93°</p>  <p>Page Seite A236 VC.. 1103.. VC.. 1604..</p>				

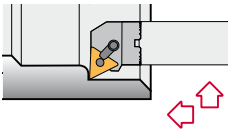
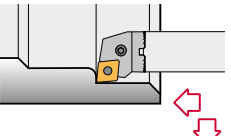
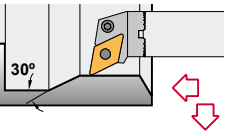
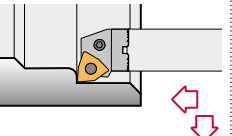
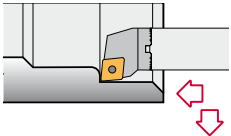
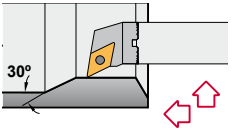
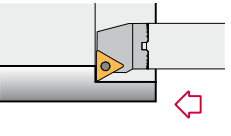
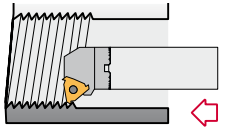
**Anti-vibration tools
Schwingungsgedämpfte Bohrstangen**

<p>J..</p>  <p>Page Seite A237</p>	<p>MTUN 93°</p>  <p>Page Seite A238 TNM.. 1604.. TNM.. 2204..</p>	<p>PCLN 95°</p>  <p>Page Seite A239 CN.. 1204.. CN.. 1606..</p>	<p>PDUN 93°</p>  <p>Page Seite A240 DN.. 1504.. DN.. 1506..</p>	<p>PWLN 95°</p>  <p>Page Seite A241 WNM.. 0804..</p>
<p>SCLC 95°</p>  <p>Page Seite A242 CC.. 09T3.. CC.. 1204..</p>	<p>SDUC 93°</p>  <p>Page Seite A243 DC.. 11T3..</p>	<p>STFC 90°</p>  <p>Page Seite A244 TC.. 16T3..</p>	<p>SXFN 90°</p>  <p>Page Seite A245 16 NR/L.. 22 NR/L..</p>	<p>J..-A..</p>  <p>Page Seite A246</p>



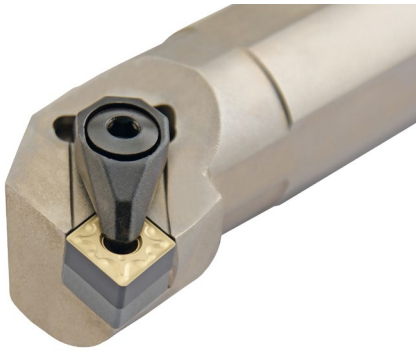

Characteristics:

Boring bar for internal turning applications equipped with rhombic negative inserts (angle 80°).

For low powered machines and small pieces choose boring bars Ref. SCLC (Page: A207).

Axial -5°
Radial -13.5°

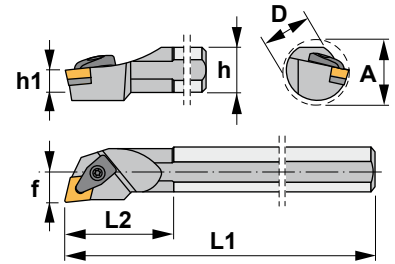

Eigenschaften:

Bohrstange zum Innendrehen mit rhombischen negativen Wendeschneidplatten (80° Winkel).

Für Niederleistungsmaschinen und kleine Werkstücke, wählen Sie Bohrstanen Bez. SCLC (Seite: A207).

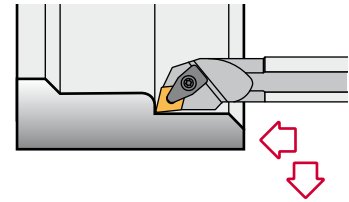

DCLN 95°-N

Reference Bezeichnung	D	h	h1	L1	L2	f	A	Insert size Wendeschneidplatte	Kg
S25T DCLN R/L 12-N	25	23	11,5	300	40	17	31	CN.. 1204..	0,700
S32U DCLN R/L 12-N	32	30	15,0	350	45	22	39	CN.. 1204..	2,050
S40V DCLN R/L 12-N	40	37	18,5	400	50	27	48	CN.. 1204..	3,750

Reference Bezeichnung							Nm
S25T DCLN R/L 12-N	ICSN-422	1766	2712	1696	4295	5004	3.5
S32U DCLN R/L 12-N	ICSN-422	1766	2712	1696	4295	5004	3.5
S40V DCLN R/L 12-N	ICSN-422	1766	2712	1696	4295	5004	3.5

CN..

80° rhombic negative inserts. A32-34
80° rhombische negative WSP.

Reference / Bez.	l	s	d
CN.. 1204..	12,90	4,76	12,70

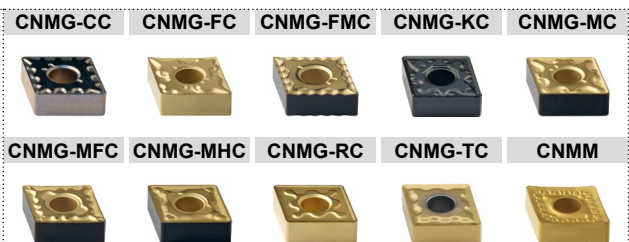
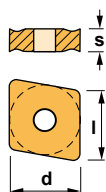

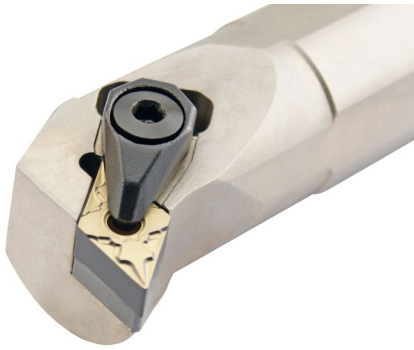

Characteristics:

Boring bar for internal turning and profiling applications equipped with rhombic negative inserts (angle 55°).

For low powered machines and small pieces choose boring bars Ref. SDUC (Page: A217).

Axial -6°
Radial -14°

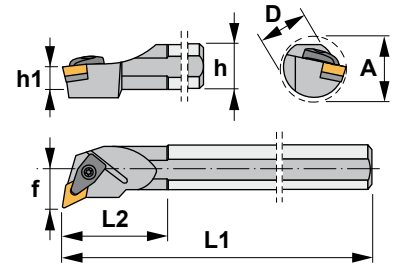

Eigenschaften:

Bohrstange zum Innen- und Profildrehen mit rhombischen negativen Wendeschneidplatten (55° Winkel).

Für Niederleistungsmaschinen und kleine Werkstücke, wählen Sie Bohrstanen SDUC (Seite: A217).

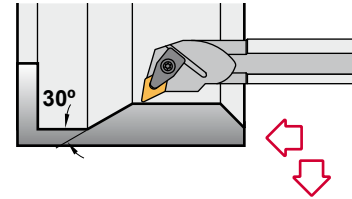

DDUN 93°-N

Reference Bezeichnung	D	h	h1	L1	L2	f	A	Insert size Wendeschneidplatte	Kg
S32U DDUN R/L 15-N	32	30	15,0	350	45	22	39	DN.. 1506..	2,050
S40V DDUN R/L 15-N	40	37	18,5	400	50	27	48	DN.. 1506..	3,750

Reference Bezeichnung							Nm
S32U DDUN R/L 15-N	IDSN-432	1766	2712	1696	4295	5004	3.5
S40V DDUN R/L 15-N	IDSN-432	1766	2712	1696	4295	5004	3.5

DN.. 55° rhombic negative inserts. A36-37
55° rhombische negative Wendeschneidplatten.

Reference / Bez.	l	s	d
DN.. 1506..	15,50	6,35	12,70

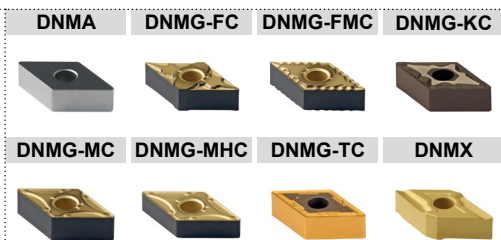
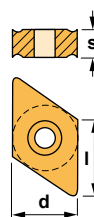



Characteristics:

Multipurpose boring bar equipped with rhombic negative double-sided insert (angle 80°).
For low powered machines and small pieces choose boring bars Ref. SCLC (Page: A207).

Axial -5°
Radial -13.5°

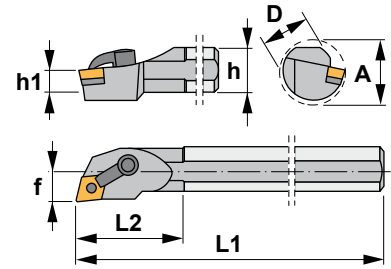

Eigenschaften:

Multifunktions-Bohrstange mit doppelseitigen rhombischen negativen Wendeschneidplatten (80° Winkel).
Für Niederleistungsmaschinen und kleine Werkstücke, wählen Sie Bohrstangen SCLC (Seite: A207).

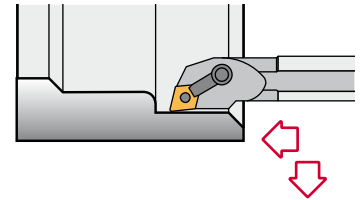

MCLN-K 95°

Reference Bezeichnung	D	h	h1	L1	L2	f	A	Insert size Wendeschneidplatte	Kg
S25T MCLN R/L 12-K	25	23	11,5	300	40	17	31	CN.. 1204..	0,700
S32U MCLN R/L 12-K	32	30	15,0	350	45	22	39	CN.. 1204..	2,050
S40V MCLN R/L 12-K	40	37	18,5	400	50	27	48	CN.. 1204..	3,750

Reference Bezeichnung								Nm
S25T MCLN R/L 12-K	2613	1186	5003	-	1686	5025	3.0	
S32U MCLN R/L 12-K	2613	1086	5003	ICSN-432	1656	5025	3.0	
S40V MCLN R/L 12-K	2613	1086	5003	ICSN-432	1656	5025	3.0	

CN..

80° rhombic negative inserts. A32-34
80° rhombische negative WSP.

Reference / Bez.	l	s	d
CN.. 1204..	12,90	4,76	12,70

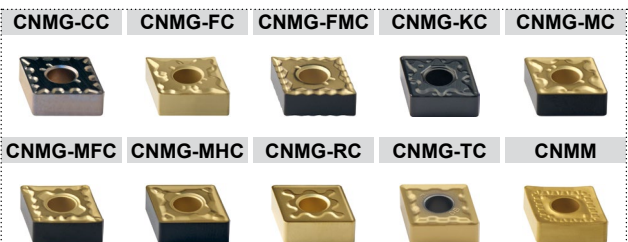
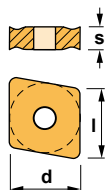



Characteristics:

Internal turning and profiling boring bar equipped with rhombic negative double-sided insert (angle 55°).

For low powered machines and small pieces choose boring bars Ref. SDUC (Page: A217).

Axial -6°
Radial -12°

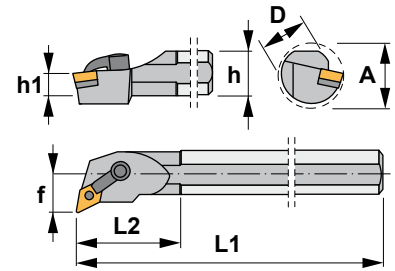

Eigenschaften:

Bohrstange zum Innen- und Profildrehen mit doppelseitigen rhombischen negativen Wendeschneidplatten (55° Winkel).

Für Niederleistungsmaschinen und kleine Werkstücke, wählen Sie Bohrstanen SDUC (Seite: A217).

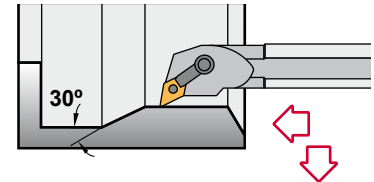

MDUN-K 93°

Reference Bezeichnung	D	h	h1	L1	L2	f	A	Insert size Wendeschneidplatte	KG
S25T MDUN R/L 15-K	25	23	11,5	300	40	17	31	DN.. 1506..	0,700
S32U MDUN R/L 15-K	32	30	15,0	350	45	22	39	DN.. 1506..	2,050
S40V MDUN R/L 15-K	40	37	18,5	400	50	27	48	DN.. 1506..	3,750

Reference Bezeichnung							Nm
S25T MDUN R/L 15-K	2614	1186	5003	-	1686	5025	3.0
S32U MDUN R/L 15-K	2614	1086	5003	IDSN-432	1666	5025	3.0
S40V MDUN R/L 15-K	2614	1086	5003	IDSN-432	1666	5025	3.0

DN..	55° rhombic negative inserts. A36-37		
	55° rhombische negative Wendeschneidplatten.		
	Reference / Bez.	l	s
DN.. 1506..	15,50	6,35	12,70

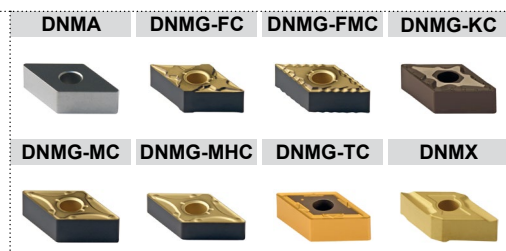
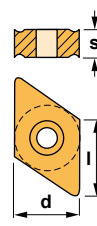



Characteristics:

Boring bar for internal turning applications equipped with square negative inserts. For low powered machines and small pieces choose boring bars Ref. CSKP (Page: A201) or SSKC (Page: A223).

Axial -3.25°
Radial -11°

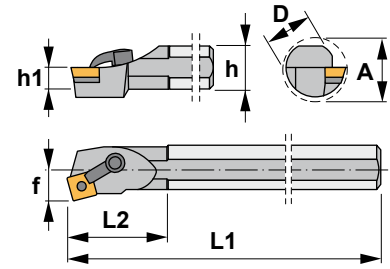

Eigenschaften:

Bohrstange zum Innendrehen mit vierkantigen negativen Wendschneidplatten. Für Niederleistungsmaschinen und kleine Werkstücke, wählen Sie Bohrstanen CSKP (Seite: A201) oder SSKC (Seite: A223).

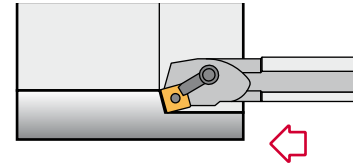

MSKN-K 75°

Reference Bezeichnung	D	h	h1	L1	L2	f	A	Insert size Wendschneidplatte	KG
S32U MSKN R/L 12-K	32	33	15,0	350	45	22	39	SNM.. 1204..	2,050
S40V MSKN R/L 12-K	40	37	18,5	400	50	27	48	SNM.. 1204..	3,750

Reference Bezeichnung							Nm
S32U MSKN R/L 12-K	2613	1086	5003	ISSN-432	1656	5025	3.0
S40V MSKN R/L 12-K	2613	1086	5003	ISSN-432	1656	5025	3.0

SNM.. Reference / Bez.	Square negative inserts. Vierkantige negative Wendschneidplatten. A41-42				SNMG-FMC	SNMG-KC	SNMG-MHC
	l	s	d				
SNM.. 1204..	12,70	4,76	12,70		SNMG-RC	SNMG-TC	SNMM



Characteristics:

Internal turning and profiling boring bar equipped with triangular negative double-sided insert.

For low powered machines and small pieces choose boring bars Ref. CTFP (Page: A202) or STFC (page: A225).

Axial -6°
Radial -12°

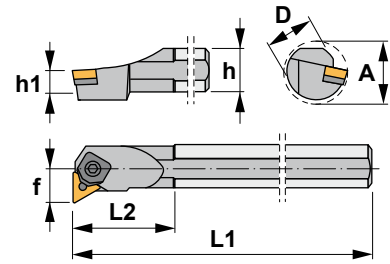

Eigenschaften:

Bohrstange zum Innen- und Profildrehen mit doppelseitigen dreikantigen negativen Wendeschneidplatten.

Für Niederleistungsmaschinen und kleine Werkstücke, wählen Sie Bohrstanen CTFP (Seite: A202) oder STFC (Seite: A225).

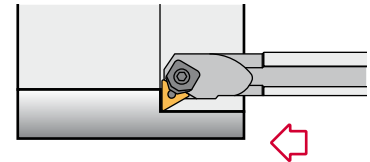

MTFN 90°

Reference Bezeichnung	D	h	h1	L1	L2	f	A	Insert size Wendeschneidplatte	Kg
S25T MTFN R/L 16	25	23	11,5	300	40	17	34	TNM.. 1604..	0,700
S32U MTFN R/L 16	32	30	15,0	350	45	22	39	TNM.. 1604..	2,050
S40V MTFN R/L 16	40	37	18,5	400	50	27	48	TNM.. 1604..	3,750
S50W MTFN R/L 16	50	47	23,5	450	60	35	61	TNM.. 1604..	6,500
S60Y MTFN R/L 16	60	57	28,5	600	75	43	80	TNM.. 1604..	12,600
S40V MTFN R/L 22	40	37	18,5	400	50	27	48	TNM.. 2204..	3,750
S50W MTFN R/L 22	50	47	23,5	450	60	35	61	TNM.. 2204..	6,500
S60Y MTFN R/L 22	60	57	28,5	600	75	43	80	TNM.. 2204..	12,600

Reference Bezeichnung						Nm
S25T MTFN R/L 16	2014	5005	3414	1644	1813	4.0
S32U MTFN R/L 16	2014	5005	3414	1644	1393	4.0
S40V MTFN R/L 16	2014	5005	3414	1644	1393	4.0
S50W MTFN R/L 16	2014	5005	3414	1644	1393	4.0
S60Y MTFN R/L 16	2014	5005	3414	1644	1393	4.0
S40V MTFN R/L 22	2024	5005	ITSN-433	1661	1394	4.0
S50W MTFN R/L 22	2024	5005	ITSN-433	1661	1394	4.0
S60Y MTFN R/L 22	2024	5005	ITSN-433	1661	1394	4.0

TNM.. Triangular negative inserts. Dreikantige negative WSP. A45-46	Reference / Bez.	l	s	d		TNMA	TNMG-CC	TNMG-FC	TNMG-FMC	TNMG-KC
	TNM.. 1604..	16,50	4,76	9,52						
	TNM.. 2204..	22,00	4,76	12,70		TNMG-MC	TNMG-MFC	TNMG-MHC	TNMG-TC	TNMX-R/L

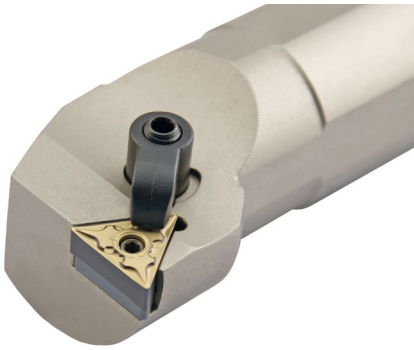

Characteristics:

Internal turning and profiling boring bar equipped with triangular negative double-sided insert.

For low powered machines and small pieces choose boring bars Ref. CTFP (Page: A202) or STFC (Page: A225).

Axial -6°
Radial -11°

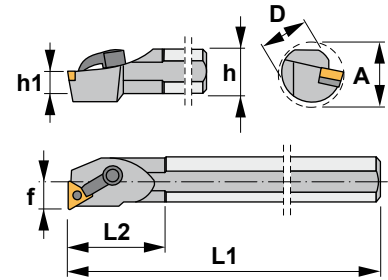

Eigenschaften:

Bohrstange zum Innen- und Profildrehen mit doppelseitigen dreikantigen negativen Wendeschneidplatten.

Für Niederleistungsmaschinen und kleine Werkstücke, wählen Sie Bohrstanen CTFP (Seite: A202) oder STFC (Seite: A225).

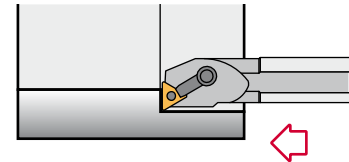

MTFN-K 90°

Reference Bezeichnung	D	h	h1	L1	L2	f	A	Insert size Wendeschneidplatte	KG
S25T MTFN R/L 16-K	25	23	11,5	300	40	17	31	TNM.. 1604..	0,700
S32U MTFN R/L 16-K	32	30	15,0	350	45	22	39	TNM.. 1604..	2,050
S40V MTFN R/L 16-K	40	37	18,5	400	50	27	48	TNM.. 1604..	3,750

Reference Bezeichnung							Nm ¹	Nm ²
S25T MTFN R/L 16-K	2613	1086	5003	ITSN-322	1665	5002	3.0	1.4
S32U MTFN R/L 16-K	2613	1086	5003	ITSN-322	1665	5002	3.0	1.4
S40V MTFN R/L 16-K	2613	1086	5003	ITSN-322	1665	5002	3.0	1.4

TNM..

Triangular negative inserts.
Dreikantige negative WSP. A45-46

Reference / Bez.	l	s	d
TNM.. 1604..	16,50	4,76	9,52
TNM.. 2204..	22,00	4,76	12,70

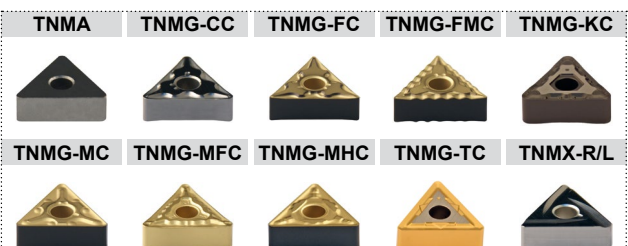
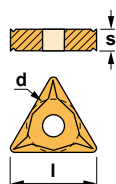

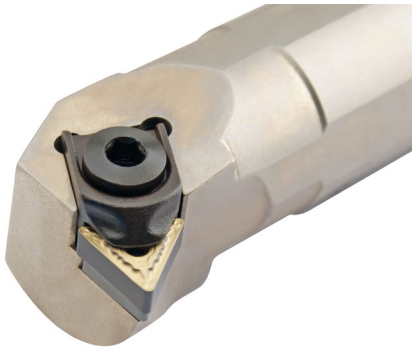

Characteristics:

Internal turning and profiling boring bar equipped with triangular negative double-sided insert.

For low powered machines and small pieces choose boring bars Ref. CTUP (Page: A203) or STUC (Page: A229).

Axial -6°
Radial -11°

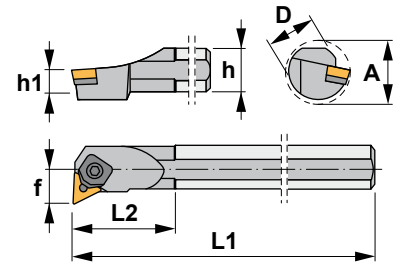

Eigenschaften:

Bohrstange zum Innen- und Profildrehen mit doppelseitigen dreikantigen negativen Wendeschneidplatten.

Für Niederleistungsmaschinen und kleine Werkstücke, wählen Sie Bohrstan- gen CTUP (Seite: A203) oder STUC (Seite: A229).

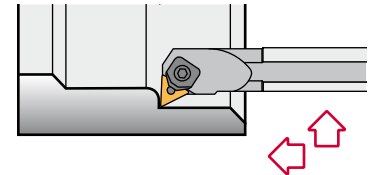

MTUN 93°

Reference Bezeichnung	D	h	h1	L1	L2	f	A	Insert size Wendeschneidplatte	Kg
S25T MTUN R/L 16	25	23	11,5	300	40	17	34	TNM.. 1604..	0,700
S32U MTUN R/L 16	32	30	15,0	350	45	22	39	TNM.. 1604..	2,050
S40V MTUN R/L 16	40	37	18,5	400	50	27	48	TNM.. 1604..	3,750
S50W MTUN R/L 16	50	47	23,5	450	60	35	61	TNM.. 1604..	6,500
S40V MTUN R/L 22	40	37	18,5	400	50	27	48	TNM.. 2204..	3,750
S50W MTUN R/L 22	50	47	23,5	450	60	35	61	TNM.. 2204..	6,500

Reference Bezeichnung						Nm
S25T MTUN R/L 16	2014	5005	3414	1644	1813	4.0
S32U MTUN R/L 16	2014	5005	3414	1644	1393	4.0
S40V MTUN R/L 16	2014	5005	3414	1644	1393	4.0
S50W MTUN R/L 16	2014	5005	3414	1644	1393	4.0
S40V MTUN R/L 22	2024	5005	ITSN-433	1661	1394	4.0
S50W MTUN R/L 22	2024	5005	ITSN-433	1661	1394	4.0

TNM..	Triangular negative inserts. A45-46 Dreikantige negative WSP.				TNMA	TNMG-CC	TNMG-FC	TNMG-FMC	TNMG-KC
	Reference / Bez.	l	s		d				
	TNM.. 1604..	16,50	4,76	9,52					
	TNM.. 2204..	22,00	4,76	12,70					

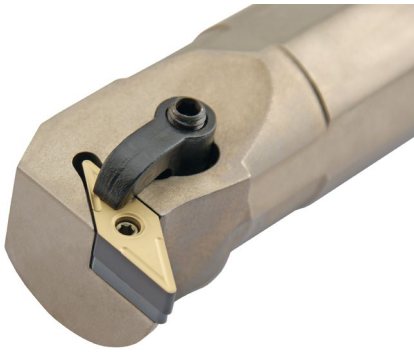

Characteristics:

Internal turning and profiling boring bar equipped with rhombic negative double-sided insert (angle 35°).

For low powered machines and small pieces choose boring bars Ref. SVUC (Page: A235).

Axial -5°
Radial -15°

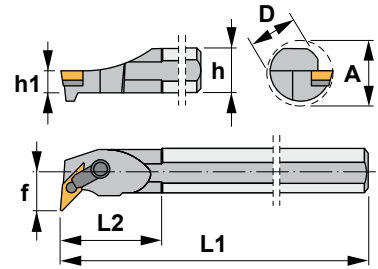

Eigenschaften:





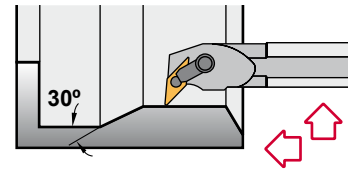

Bohrstange zum Innen- und Profildrehen mit doppelseitigen rhombischen negativen Wendeschneidplatten (35° Winkel).

Für Niederleistungsmaschinen und kleine Werkstücke, wählen Sie Bohrstangen SVUC (Seite: A235).



MVUN-K 93°

Reference Bezeichnung	D	h	h1	L1	L2	f	A	Insert size Wendeschneidplatte	KG
S25T MVUN R/L 16-K	25	23	11,5	300	40	17	31	VN.. 1604..	0,700
S32U MVUN R/L 16-K	32	30	15,0	350	45	22	39	VN.. 1604..	2,050
S40V MVUN R/L 16-K	40	37	18,5	400	50	27	48	VN.. 1604..	3,750

Reference Bezeichnung							Nm ¹	Nm ²
S25T MVUN R/L 16-K	2614	1186	5003	IVSN-322	1665	5002	3.0	1.4
S32U MVUN R/L 16-K	2614	1086	5003	IVSN-322	1665	5002	3.0	1.4
S40V MVUN R/L 16-K	2614	1086	5003	IVSN-322	1665	5002	3.0	1.4

VN..

35° rhombic negative inserts.  A49
35° rhombische negative Wendeschneidplatten.

Reference / Bez.	l	s	d
VN.. 1604..	16,50	4,76	9,52

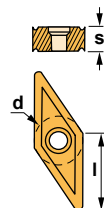

VNGP



VNMG



VNMG-TC





Characteristics:

Multipurpose boring bar equipped with trigon negative double-sided insert (angle 80°).

Not suitable for cermet, ceramic or K10, P10 grade inserts.

Axial -5°
Radial -11.5°

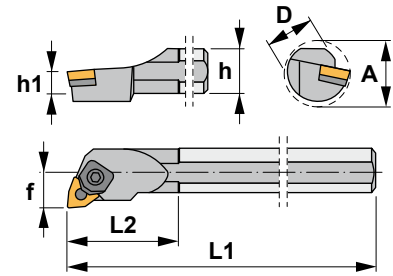

Eigenschaften:

Multifunktions-Bohrstange mit doppelseitigen negativen Trigon Wendeschneidplatten (80° Winkel).

Nicht geeignet für Cermet, Keramik oder K10 und P10 Wendeschneidplatten.

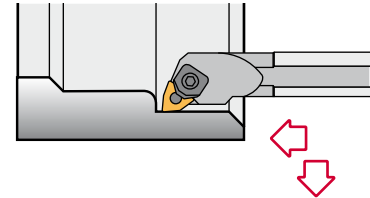

MWLN 95°

Reference Bezeichnung	D	h	h1	L1	L2	f	A	Insert size Wendeschneidplatte	kg
S20S MWLN R/L 06	20	18	9,0	250	35	13	27	WNM.. 0604..	0,550
S25T MWLN R/L 06	25	23	11,5	300	40	17	31	WNM.. 0604..	0,700
S32U MWLN R/L 06	32	30	15,0	350	45	22	39	WNM.. 0604..	2,050
S25T MWLN R/L 08	25	23	11,5	300	40	17	31	WNM.. 0804..	0,700
S32U MWLN R/L 08	32	30	15,0	350	45	22	39	WNM.. 0804..	2,050
S40V MWLN R/L 08	40	37	18,5	400	50	27	48	WNM.. 0804..	3,750
S50W MWLN R/L 08	50	47	23,5	450	60	35	61	WNM.. 0804..	6,500
S60Y MWLN R/L 08	60	57	28,5	600	75	43	80	WNM.. 0804..	12,600

Reference Bezeichnung						Nm
S20S MWLN R/L 06	2006	5025	-	1643	1813	2.0
S25T MWLN R/L 06	2006	5025	3006	1644	1813	2.0
S32U MWLN R/L 06	2006	5025	3006	1644	1813	2.0
S25T MWLN R/L 08	2011	5005	-	1647	1814	4.0
S32U MWLN R/L 08	2011	5005	IWSN-433	1661	1814	4.0
S40V MWLN R/L 08	2011	5005	IWSN-433	1661	1814	4.0
S50W MWLN R/L 08	2011	5005	IWSN-433	1661	1814	4.0
S60Y MWLN R/L 08	2011	5005	IWSN-433	1661	1814	4.0

WNMG 80° trigon negative inserts. A50-51
80° trigon negative Wendeschneidplatten.

Reference / Bez.	l	s	d
WNMG 0604..	6,45	4,76	9,52
WNMG 0804..	8,14	4,76	12,70

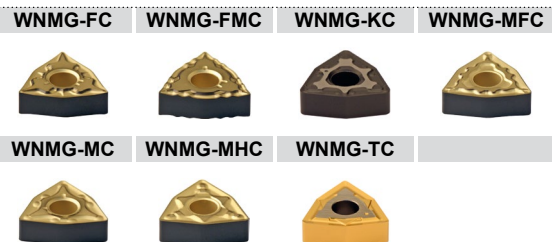
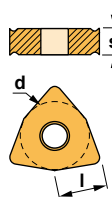



Characteristics:

Multipurpose boring bar equipped with trigon negative double-sided insert (angle 80°). Especially recommended for cermet, ceramic or K10, P10 grade inserts.

Axial -5°
Radial -11.5°

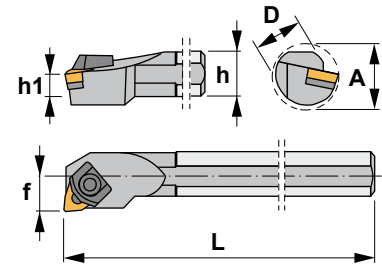

Eigenschaften:

Multifunktions-Bohrstange mit doppelseitigen negativen Trigon Wendeschneidplatten (80° Winkel).

Besonders geeignet für Cermet, Keramik oder K10 und P10 Wendeschneidplatten.

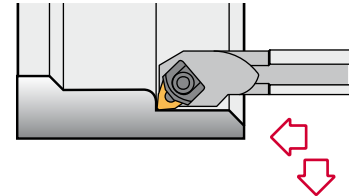

MWLN-K 95°

Reference Bezeichnung	D	h	h1	L1	L2	f	A	Insert size Wendeschneidplatte	kg
S25T MWLN R/L 08-K	25	23	11,5	300	40	17	31	WNMG 0804..	0,700
S32U MWLN R/L 08-K	32	30	15,0	350	45	22	39	WNMG 0804..	2,050
S40V MWLN R/L 08-K	40	37	18,5	400	50	27	48	WNMG 0804..	3,750
S50W MWLN R/L 08-K	50	47	23,5	450	60	35	61	WNMG 0804..	6,500

Reference Bezeichnung						Nm
S25T MWLN R/L 08-K	2018	-	1647	5025	1814	2.0
S32U MWLN R/L 08-K	2018	IWSN-433	1661	5025	1814	2.0
S40V MWLN R/L 08-K	2018	IWSN-433	1661	5025	1814	2.0
S50W MWLN R/L 08-K	2018	IWSN-433	1661	5025	1814	2.0

WNMG 80° trigon negative inserts. A50-51
80° trigon negative Wendeschneidplatten.

Reference / Bez.	l	s	d
WNMG 0804..	8,14	4,76	12,70

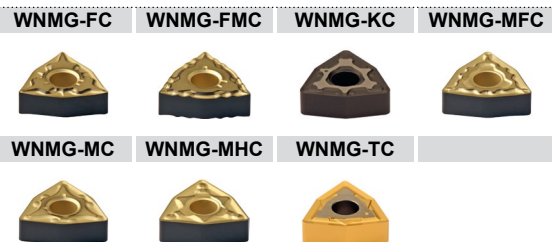
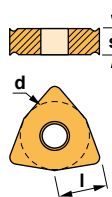

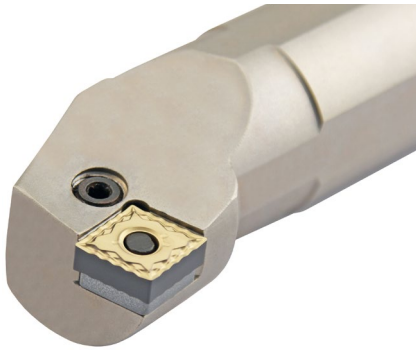

Characteristics:

Boring bar for internal turning applications equipped with rhombic negative inserts (angle 80°).

For general applications, roughing, semi-finishing and finishing.

Axial -3°
Radial -11.5°

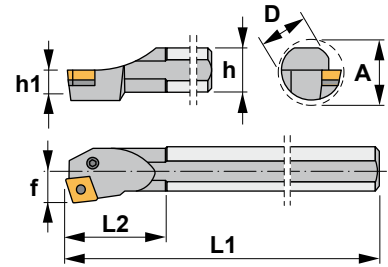

Eigenschaften:

Bohrstange zum Innendreien mit rhombischen negativen Wendeschneidplatten (80° Winkel).

Für allgemeine Anwendungen, Schruppen, Vorschlichten und Schlichten.

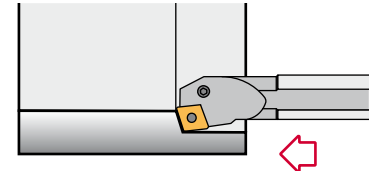

PCKN 75°

Reference Bezeichnung	D	h	h1	L1	L2	f	A	Insert size Wendeschneidplatte	kg
S25T PCKN R/L 12	25	23	11,5	300	40	17	31	CN.. 1204..	0,700
S32U PCKN R/L 12	32	30	15,0	350	45	22	39	CN.. 1204..	2,050
S40V PCKN R/L 12	40	37	18,5	400	50	27	48	CN.. 1204..	3,750
S50W PCKN R/L 12	50	47	23,5	450	60	35	61	CN.. 1204..	6,500
S60Y PCKN R/L 12	60	57	28,5	600	75	43	80	CN.. 1204..	12,600
S40V PCKN R/L 16	40	37	18,5	400	50	27	48	CN.. 1606..	3,750
S50W PCKN R/L 16	50	47	23,5	450	60	35	61	CN.. 1606..	6,500
S60Y PCKN R/L 16	60	57	28,5	600	75	43	80	CN.. 1606..	12,600
S50W PCKN R/L 19	50	47	23,5	450	60	35	61	CN.. 1906..	6,500
S60Y PCKN R/L 19	60	57	28,5	600	75	43	80	CN.. 1906..	12,600

Reference Bezeichnung							Nm
S25T PCKN R/L 12	8212	1626	5025	-	-	-	2.0
S32U PCKN R/L 12	8312	1648	5003	3612	4112	0012	3.0
S40V PCKN R/L 12	8012	1608	5003	3612	4112	0012	3.0
S50W PCKN R/L 12	8012	1608	5003	3612	4112	0012	3.0
S60Y PCKN R/L 12	8012	1608	5003	3612	4112	0012	3.0
S40V PCKN R/L 16	8016	1618	5003	3616	4115	0015	3.0
S50W PCKN R/L 16	8016	1618	5003	3616	4115	0015	3.0
S60Y PCKN R/L 16	8016	1618	5003	3616	4115	0015	3.0
S50W PCKN R/L 19	8219	1610	5004	3619	4119	0019	3.5
S60Y PCKN R/L 19	8219	1610	5004	3619	4119	0019	3.5

CN..

80° rhombic negative inserts.
80° rhombische negative WSP. A32-34

Reference / Bez.	l	s	d
CN.. 1204..	12,90	4,76	12,70
CN.. 1606..	16,10	6,35	15,88
CN.. 1906..	19,30	6,35	19,05

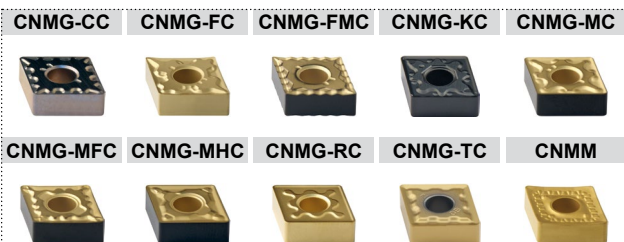
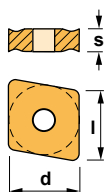



Characteristics:

Boring bar for internal turning applications equipped with rhombic negative inserts (angle 80°).

For low powered machines and small pieces choose boring bars Ref. SCLC (Page: A207).

Axial -5°
Radial -13.5°

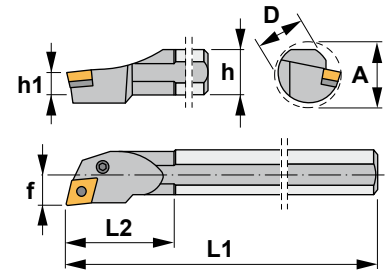

Eigenschaften:

Bohrstange zum Innendrehen mit rhombischen negativen Wendeschneidplatten (80° Winkel).

Für Niederleistungsmaschinen und kleine Werkstücke, wählen Sie Bohrstanngen SCLC (Seite: A207).

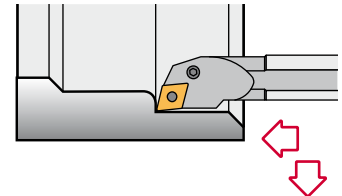

PCLN 95°

Reference Bezeichnung	D	h	h1	L1	L2	f	A	Insert size Wendeschneidplatte	Kg
S16R PCLN R/L 09	16	15	7,5	200	30	11	20	CN.. 0903..	0,300
S20S PCLN R/L 09	20	18	9,0	250	35	13	25	CN.. 0903..	0,550
S25T PCLN R/L 09	25	23	11,5	300	40	17	32	CN.. 0903..	0,700
S25T PCLN R/L 12	25	23	11,5	300	40	17	31	CN.. 1204..	0,700
S32U PCLN R/L 12	32	30	15,0	350	45	22	39	CN.. 1204..	2,050
S40V PCLN R/L 12	40	37	18,5	400	50	27	48	CN.. 1204..	3,750
S50W PCLN R/L 12	50	47	23,5	450	60	35	61	CN.. 1204..	6,500
S60Y PCLN R/L 12	60	57	28,5	600	75	43	80	CN.. 1204..	12,600
S40V PCLN R/L 16	40	37	18,5	400	50	27	48	CN.. 1606..	3,750
S50W PCLN R/L 16	50	47	23,5	450	60	35	61	CN.. 1606..	6,500
S60Y PCLN R/L 16	60	57	28,5	600	75	43	80	CN.. 1606..	12,600
S50W PCLN R/L 19	50	47	23,5	450	60	35	61	CN.. 1906..	6,500
S60Y PCLN R/L 19	60	57	28,5	600	75	43	80	CN.. 1906..	12,600

Reference Bezeichnung							Nm
S16R PCLN R/L 09	8005	1605	5002	-	-	-	1.4
S20S PCLN R/L 09	8005	1605	5002	-	-	-	1.4
S25T PCLN R/L 09	8009	1626	5025	3609	4109	0009	2.0
S25T PCLN R/L 12	8212	1626	5025	-	-	-	2.0
S32U PCLN R/L 12	8312	1648	5003	3612	4112	0012	3.0
S40V PCLN R/L 12	8012	1608	5003	3612	4112	0012	3.0
S50W PCLN R/L 12	8012	1608	5003	3612	4112	0012	3.0
S60Y PCLN R/L 12	8012	1608	5003	3612	4112	0012	3.0
S40V PCLN R/L 16	8016	1618	5003	3616	4115	0015	3.0
S50W PCLN R/L 16	8016	1618	5003	3616	4115	0015	3.0
S60Y PCLN R/L 16	8016	1618	5003	3616	4115	0015	3.0
S50W PCLN R/L 19	8219	1610	5004	3619	4129	0019	3.5
S60Y PCLN R/L 19	8219	1610	5004	3619	4129	0019	3.5

CN..

80° rhombic negative inserts.
80° rhombische negative WSP. A32-34

Reference / Bez.	l	s	d
CN.. 0903..	9,65	3,18	9,52
CN.. 1204..	12,90	4,76	12,70
CN.. 1606..	16,10	6,35	15,88
CN.. 1906..	19,30	6,35	19,05

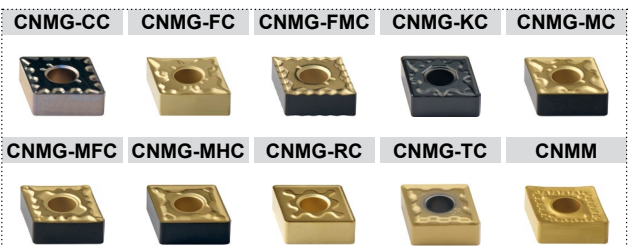
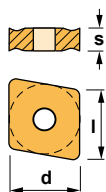



Characteristics:

Boring bar for internal turning applications equipped with rhombic negative inserts (angle 80°).

For low powered machines and small pieces choose boring bars Ref. A-SCLC (Page: A208).

Axial -5°
Radial -13.5°

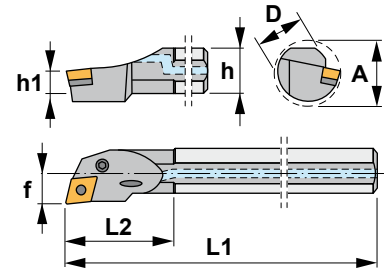

Eigenschaften:

Bohrstange zum Innendreien mit rhombischen negativen Wendeschneidplatten (80° Winkel).

Für Niederleistungsmaschinen und kleine Werkstücke, wählen Sie Bohrstanen A-SCLC (Seite: A208).

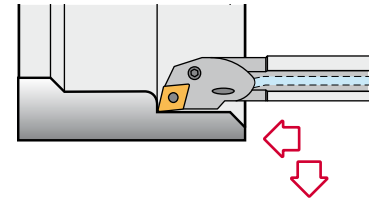

A-PCLN 95°

Reference Bezeichnung	D	h	h1	L1	L2	f	A	Insert size Wendeschneidplatte	kg
A16M PCLN R/L 09	16	15	7,5	150	30	11	20	CN.. 0903..	0,200
A20Q PCLN R/L 09	20	18	9,0	180	35	13	25	CN.. 0903..	0,400
A25R PCLN R/L 12	25	23	11,5	200	40	17	31	CN.. 1204..	0,700
A32S PCLN R/L 12	32	30	15,0	250	45	22	39	CN.. 1204..	1,400
A40T PCLN R/L 12	40	37	18,5	300	50	27	48	CN.. 1204..	2,650

Reference Bezeichnung							Nm
A16M PCLN R/L 09	8005	1605	5002	-	-	-	1.4
A20Q PCLN R/L 09	8005	1605	5002	-	-	-	1.4
A25R PCLN R/L 12	8212	1626	5025	-	-	-	2.0
A32S PCLN R/L 12	8312	1648	5003	3612	4112	0012	3.0
A40T PCLN R/L 12	8012	1608	5003	3612	4112	0012	3.0

CN.. <small>80° rhombic negative inserts. 80° rhombische negative WSP. A32-34</small>								
Reference / Bez.	l	s	d					
CN.. 0903..	9,65	3,18	9,52					
CN.. 1204..	12,90	4,76	12,70					

CNMG-CC

CNMG-FC

CNMG-FMC

CNMG-KC

CNMG-MC

CNMG-MFC

CNMG-MHC

CNMG-RC

CNMG-TC

CNMM



Characteristics:

Boring bar for internal turning and profiling applications equipped with rhombic negative inserts (angle 55°).

For low powered machines and small pieces choose boring bars Ref. SDUC (Page: A217).

Axial -6°
Radial -14°

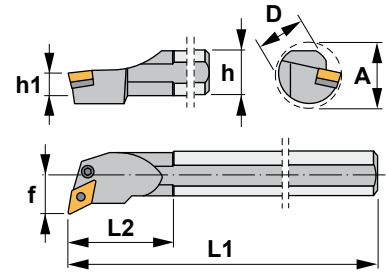

Eigenschaften:

Bohrstange zum Innen- und Profildrehen mit rhombischen negativen Wendeschneidplatten (55° Winkel).

Für Niederleistungsmaschinen und kleine Werkstücke, wählen Sie Bohrstanen SDUC (Seite: A217).

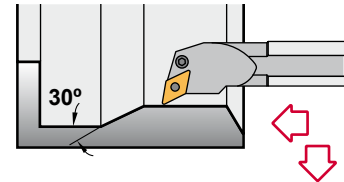

PDUN 93°

Reference Bezeichnung	D	h	h1	L1	L2	f	A	Insert size Wendeschneidplatte	KG
S20S PDUN R/L 11	20	18	9,0	250	35	13	20	DN.. 1104..	0,550
S25T PDUN R/L 11	25	23	11,5	300	40	17	31	DN.. 1104..	0,700
S32U PDUN R/L 11	32	30	15,0	350	45	22	39	DN.. 1104..	2,050
S32U PDUN R/L 15	32	30	15,0	350	45	22	39	DN.. 1506..	2,050
S40V PDUN R/L 15	40	37	18,5	400	50	27	48	DN.. 1506..	3,750
S50W PDUN R/L 15	50	47	23,5	450	60	35	61	DN.. 1506..	6,500
S60Y PDUN R/L 15	60	57	28,5	600	75	43	80	DN.. 1506..	12,600

Reference Bezeichnung									Nm
S20S PDUN R/L 11	8216	1605	5002	-	-	-	-	-	1.4
S25T PDUN R/L 11	8009	1606	5025	3711	4109	0009	-	-	2.0
S32U PDUN R/L 11	8009	1606	5025	3711	4109	0009	-	-	2.0
S32U PDUN R/L 15	8415	1648	5003	3715	4112	0012	3725	4135	3.0
S40V PDUN R/L 15	8415	1638	5003	3715	4112	0012	3725	4135	3.0
S50W PDUN R/L 15	8415	1638	5003	3715	4112	0012	3725	4135	3.0
S60Y PDUN R/L 15	8415	1638	5003	3715	4112	0012	3725	4135	3.0

For DNM.. 1504.. inserts
Für Wendeschneidplatten DNM.. 1504..

DN.. 55° rhombic negative inserts. A36-37
55° rhombische negative Wendeschneidplatten.

Reference / Bez.	l	s	d
DN.. 1104..	11,60	4,76	9,52
DN.. 1504..	15,50	4,76	12,70
DN.. 1506..	15,50	6,35	12,70

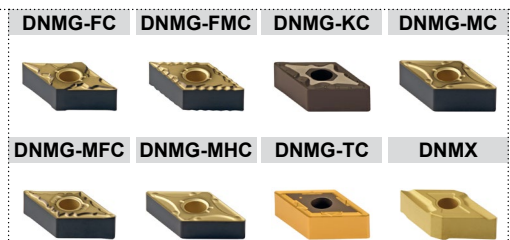
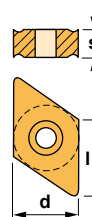



Characteristics:

Boring bar for internal turning and profiling applications equipped with rhombic negative inserts (angle 55°).

For low powered machines and small pieces choose boring bars Ref. A-SDUC (Page: A218).

Axial -6°
Radial -14°

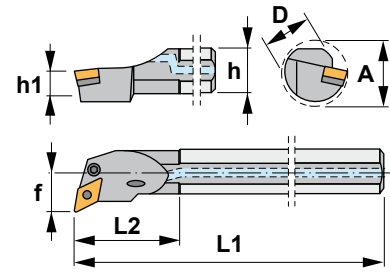

Eigenschaften:

Bohrstange zum Innen- und Profildrehen mit rhombischen negativen Wendeschneidplatten (55° Winkel).

Für Niederleistungsmaschinen und kleine Werkstücke, wählen Sie Bohrstanen A-SDUC (Seite: A218).

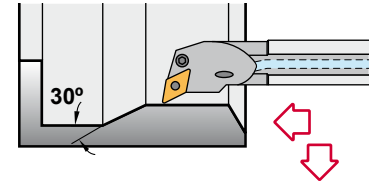

A-PDUN 93°

Reference Bezeichnung	D	h	h1	L1	L2	f	A	Insert size Wendeschneidplatte	Kg
A25R PDUN R/L 11	25	23	11,5	200	40	17	31	DN.. 1104..	0,700
A32S PDUN R/L 15	32	30	15,0	250	45	22	39	DN.. 1506..	1,400
A40T PDUN R/L 15	40	37	18,5	300	50	27	48	DN.. 1506..	2,650

Reference Bezeichnung										Nm
A25R PDUN R/L 11	8009	1606	5025	3711	4109	0009	-	-	-	2.0
A32S PDUN R/L 15	8415	1648	5003	3715	4112	0012	3725	4135	-	3.0
A40T PDUN R/L 15	8415	1638	5003	3715	4112	0012	3725	4135	-	3.0

For DNM.. 1504.. inserts
Für Wendeschneidplatten DNM.. 1504..

Reference / Bez.	55° rhombic negative inserts. 55° rhombische negative Wendeschneidplatten. A36-37		
	l	s	d
DN.. 1104..	11,60	4,76	9,52
DN.. 1504..	15,50	4,76	12,70
DN.. 1506..	15,50	6,35	12,70

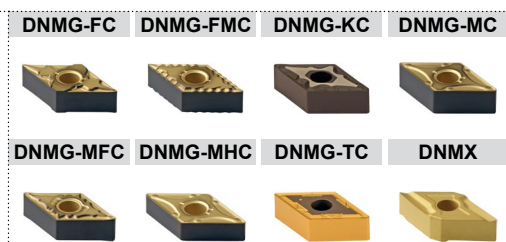
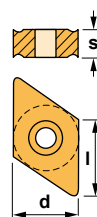



Characteristics:

Backwards boring bar for internal turning and profiling applications equipped with rhombic negative inserts (angle 55°).

For low powered machines and small pieces choose boring bars Ref. SDUC-EX (Page: A221).

Axial -6°
Radial -14°

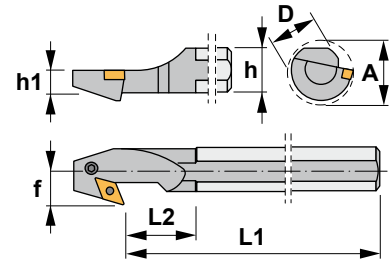

Eigenschaften:

Rückwärts-Bohrstange zum Innen- und Profildrehen mit rhombischen negativen Wendeschneidplatten (55° Winkel).

Für Niederleistungsmaschinen und kleine Werkstücke, wählen Sie Bohrstanen SDUC-EX (Seite: A221).

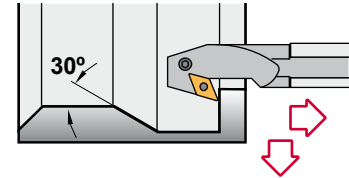

PDUN 93°-EX

Reference Bezeichnung	D	h	h1	L1	L2	f	A	Insert size Wendeschneidplatte	KG
S32U PDUN R/L 15-EX	32	30	15,0	350	50	22	39	DN.. 1506..	2,050
S40V PDUN R/L 15-EX	40	37	18,5	400	60	27	48	DN.. 1506..	3,750
S50W PDUN R/L 15-EX	50	47	23,5	450	65	35	61	DN.. 1506..	6,500

Reference Bezeichnung									Nm
S32U PDUN R/L 15-EX	8415	1648	5003	-	-	-	-	-	3.0
S40V PDUN R/L 15-EX	8415	1638	5003	3715	4112	0012	3725	4135	3.0
S50W PDUN R/L 15-EX	8415	1638	5003	3715	4112	0012	3725	4135	3.0

For DNM.. 1504.. inserts
Für Wendeschneidplatten DNM.. 1504..

DN.. 55° rhombic negative inserts.  A36-37
55° rhombische negative Wendeschneidplatten.

Reference / Bez.	l	s	d
DN.. 1504..	15,50	4,76	12,70
DN.. 1506..	15,50	6,35	12,70

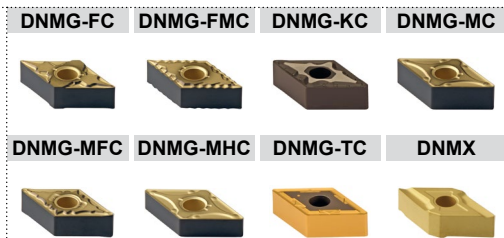
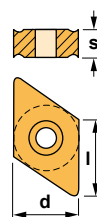



Characteristics:

Boring bar for internal turning applications equipped with square negative inserts. For low powered machines and small pieces choose boring bars Ref. CSKP (Page: A201) or SSKC (Page: A223).

Axial -3°
Radial -11°

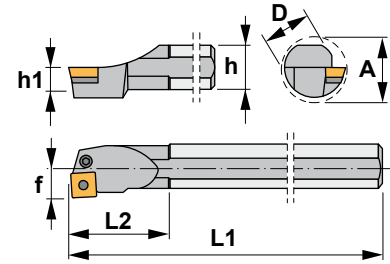

Eigenschaften:

Bohrstange zum Innendrehen mit vierkantigen negativen Wendeschneidplatten. Für Niederleistungsmaschinen und kleine Werkstücke, wählen Sie Bohrstanen CSKP (Seite: A201) oder SSKC (Seite: A223).

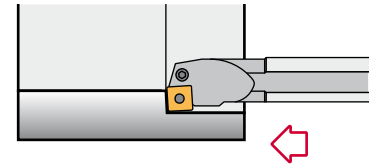

PSKN 75°

Reference Bezeichnung	D	h	h1	L1	L2	f	A	Insert size Wendeschneidplatte	kg
S25T PSKN R/L 12	25	23	11,5	300	40	17	31	SNM.. 1204..	0,700
S32U PSKN R/L 12	32	30	15,0	350	45	22	39	SNM.. 1204..	2,050
S40V PSKN R/L 12	40	37	18,5	400	50	27	48	SNM.. 1204..	3,750
S40V PSKN R/L 15	40	37	18,5	400	50	27	48	SNM.. 1506..	3,750
S50W PSKN R/L 15	50	47	23,5	450	60	35	61	SNM.. 1506..	6,500
S50W PSKN R/L 19	50	47	23,5	450	60	35	61	SNM.. 1906..	6,500
S60Y PSKN R/L 19	60	57	28,5	600	75	43	80	SNM.. 1906..	12,600

Reference Bezeichnung							Nm
S25T PSKN R/L 12	8212	1626	5025	-	-	-	2.0
S32U PSKN R/L 12	8312	1648	5003	3512	4112	0012	3.0
S40V PSKN R/L 12	8012	1608	5003	3512	4112	0012	3.0
S40V PSKN R/L 15	8012	1608	5003	3512	4112	0012	3.0
S50W PSKN R/L 15	8016	1618	5003	3515	4115	0015	3.0
S50W PSKN R/L 19	8219	1710	5004	3519	4129	0019	3.5
S60Y PSKN R/L 19	8219	1710	5004	3519	4129	0019	3.5

SNM..

Square negative inserts. A41-42
Vierkantige negative Wendeschneidplatten.

Reference / Bez.	l	s	d
SNM.. 1204..	12,70	4,76	12,70
SNM.. 1506..	15,88	6,35	15,88
SNM.. 1906..	19,05	6,35	19,05

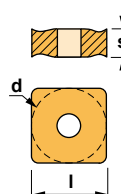

SNMG-FMC



SNMG-KC



SNMG-MHC



SNMG-RC



SNMG-TC



SNMM





Characteristics:

Boring bar for internal turning applications equipped with square negative inserts. For low powered machines and small pieces choose boring bars Ref. CSKP (Page: A201) or SSKC (Page: A223).

Axial -3°
Radial -11°

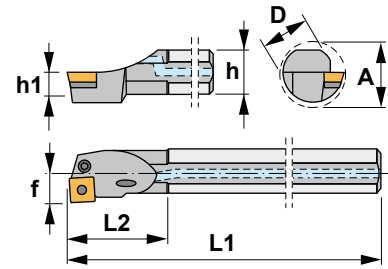

Eigenschaften:

Bohrstange zum Innendrehen mit vierkantigen negativen Wendschneidplatten.

Für Niederleistungsmaschinen und kleine Werkstücke, wählen Sie Bohrstangen CSKP (Seite: A201) oder SSKC (Seite: A223).

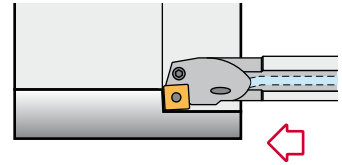

A-PSKN 75°

Reference Bezeichnung	D	h	h1	L1	L2	f	A	Insert size Wendschneidplatte	
A25R PSKN R/L 12	25	23	11,5	200	40	17	31	SNM.. 1204..	0,700
A32S PSKN R/L 12	32	30	15,0	250	45	22	39	SNM.. 1204..	1,400
A40T PSKN R/L 12	40	37	18,5	300	50	27	48	SNM.. 1204..	2,650

Reference Bezeichnung							Nm
A25R PSKN R/L 12	8212	1626	5025	-	-	-	2.0
A32S PSKN R/L 12	8312	1648	5003	3512	4112	0012	3.0
A40T PSKN R/L 12	8012	1608	5003	3512	4112	0012	3.0

SNM.. Square negative inserts. Vierkantige negative Wendschneidplatten. A41-42				SNMG-FMC	SNMG-KC	SNMG-MHC	
	Reference / Bez.	l	s	d			
	SNM.. 1204..	12,70	4,76	12,70			



Characteristics:

Boring bar for internal turning applications equipped with square negative inserts. For low powered machines and small pieces choose boring bars Ref. A-SSSC (Page: A224).

Axial -3°
Radial -11°

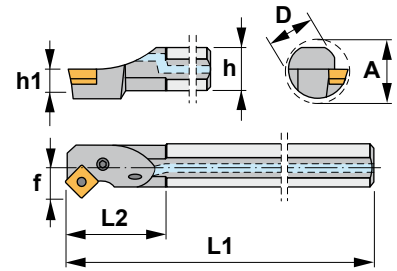

Eigenschaften:

Bohrstange zum Innendreien mit vierkantigen negativen Wendschneidplatten. Für Niederleistungsmaschinen und kleine Werkstücke, wählen Sie Bohrstanen A-SSSC (Seite: A224).

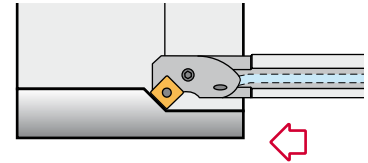

A-PSSN 45°

Reference Bezeichnung	D	h	h1	L1	L2	f	A	Insert size Wendschneidplatte	
A25R PSSN R/L 12	25	23	11,5	200	40	17	31	SNM.. 1204..	0,700
A32S PSSN R/L 12	32	30	15,0	250	45	22	39	SNM.. 1204..	2,050

Reference Bezeichnung							Nm
A25R PSSN R/L 12	8212	1626	5025	-	-	-	2.0
A32S PSSN R/L 12	8312	1648	5003	3512	4112	0012	3.0

SNM.. <small>Square negative inserts. Vierkantige negative Wendschneidplatten. A41-42</small>						
Reference / Bez.	l	s	d	SNMG-FMC	SNMG-KC	SNMG-MHC
SNM.. 1204..	12,70	4,76	12,70			
				SNMG-RC	SNMG-TC	SNMM



Characteristics:

Boring bar for internal turning applications equipped with triangular negative inserts. For low powered machines and small pieces choose boring bars Ref. CTFP (Page: A202) or STFC (Page: A225).

Axial -6°
Radial -11°

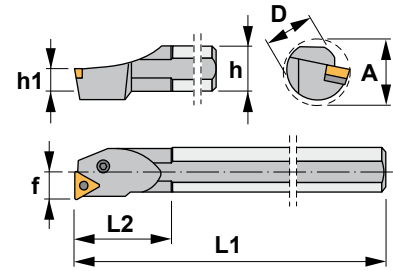

Eigenschaften:

Bohrstange zum Innendrehen mit dreikantigen negativen Wendeschneidplatten.

Für Niederleistungsmaschinen und kleine Werkstücke, wählen Sie Bohrstangen CTFP (Seite: A202) oder STFC (Seite: A225).

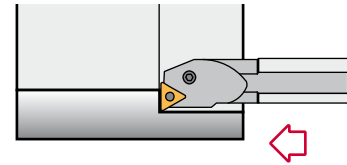

PTFN 90°

Reference Bezeichnung	D	h	h1	L1	L2	f	A	Insert size Wendeschneidplatte	Kg
S25T PTFN R/L 16	25	23	11,5	300	40	17	31	TNM.. 1604..	0,700
S32U PTFN R/L 16	32	30	15,0	350	45	22	39	TNM.. 1604..	2,050
S40V PTFN R/L 16	40	37	18,5	400	50	27	48	TNM.. 1604..	3,750
S50W PTFN R/L 16	50	47	23,5	450	60	35	61	TNM.. 1604..	6,500
S40V PTFN R/L 22	40	37	18,5	400	50	27	48	TNM.. 2204..	3,750
S50W PTFN R/L 22	50	47	23,5	450	60	35	61	TNM.. 2204..	6,500

Reference Bezeichnung							Nm
S25T PTFN R/L 16	8216	1605	5002	-	-	-	1.4
S32U PTFN R/L 16	8009	1606	5025	3416	4109	0009	2.0
S40V PTFN R/L 16	8009	1606	5025	3416	4109	0009	2.0
S50W PTFN R/L 16	8009	1606	5025	3416	4109	0009	2.0
S40V PTFN R/L 22	8012	1608	5003	3422	4112	0012	3.0
S50W PTFN R/L 22	8012	1608	5003	3422	4112	0012	3.0

TNM..

Triangular negative inserts.
Dreikantige negative WSP. A45-46

Reference / Bez.	l	s	d
TNM.. 1604..	16,50	4,76	9,52
TNM.. 2204..	22,00	4,76	12,70

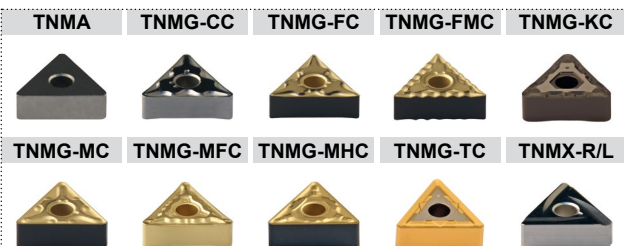
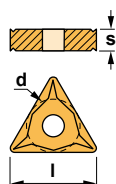



Characteristics:

Boring bar for internal turning applications equipped with triangular negative inserts. For low powered machines and small pieces choose boring bars Ref. CTFP (Page: A202) or A-STFC (Page: A226).

Axial -6°
Radial -11°

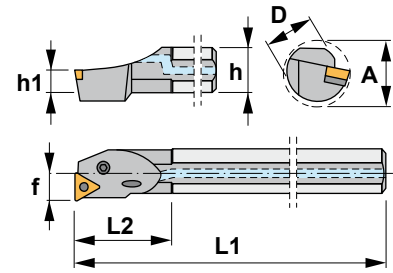

Eigenschaften:

Bohrstange zum Innendrehen mit dreikantigen negativen Wendeschneidplatten.

Für Niederleistungsmaschinen und kleine Werkstücke, wählen Sie Bohrstangen CTFP (Seite: A202) oder A-STFC (Seite: A226).

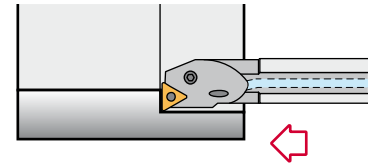

A-PTFN 90°

Reference Bezeichnung	D	h	h1	L1	L2	f	A	Insert size Wendeschneidplatte	
A25R PTFN R/L 16	25	23	11,5	200	40	17	31	TNM.. 1604..	0,700
A32S PTFN R/L 16	32	30	15,0	250	45	22	39	TNM.. 1604..	1,400
A40T PTFN R/L 22	40	37	18,5	300	50	27	48	TNM.. 2204..	2,650

Reference Bezeichnung							Nm
A25R PTFN R/L 16	8216	1605	5002	-	-	-	1.4
A32S PTFN R/L 16	8009	1606	5025	3416	4109	0009	2.0
A40T PTFN R/L 22	8012	1608	5003	3422	4112	0012	3.0

TNM..				Triangular negative inserts. A45-46 Dreikantige negative WSP.					
Reference / Bez.	l	s	d		TNMA	TNMG-CC	TNMG-FC	TNMG-FMC	TNMG-KC
TNM.. 1604..	16,50	4,76	9,52						
TNM.. 2204..	22,00	4,76	12,70						



Characteristics:

Boring bar for internal turning applications equipped with trigon negative inserts (angle 80°).

For general applications, roughing, semi-finishing and finishing.

Axial -6°
Radial -13.5°

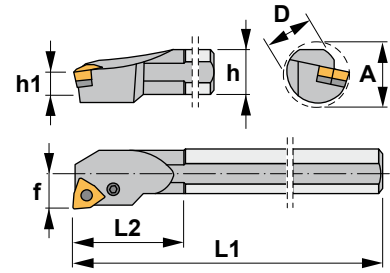

Eigenschaften:

Bohrstangen zum Innendrehen mit negativen Trigon Wendeschneidplatten (80° Winkel). Für allgemeine Anwendungen, Schruppen, Vorschlichten und Schlichten.

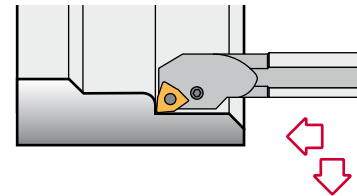

PWLN 95°

Reference Bezeichnung	D	h	h1	L1	L2	f	A	Insert size Wendeschneidplatte	Kg
S16R PWLN R/L 06	16	15	7,5	200	30	11	20	WNM.. 0604..	0,300
S20S PWLN R/L 06	20	18	9,0	250	35	13	27	WNM.. 0604..	0,550
S25T PWLN R/L 06	25	23	11,5	300	40	17	31	WNM.. 0604..	0,700
S25T PWLN R/L 08	25	23	11,5	300	40	17	31	WNM.. 0804..	0,700
S32U PWLN R/L 08	32	30	15,0	350	45	22	39	WNM.. 0804..	2,050
S40V PWLN R/L 08	40	37	18,5	400	50	27	48	WNM.. 0804..	3,750

Reference Bezeichnung							Nm
S16R PWLN R/L 06	8216	1605	5002	-	-	-	1.4
S20S PWLN R/L 06	8216	1605	5002	-	-	-	1.4
S25T PWLN R/L 06	8009	1606	5025	3007	4109	0009	2.0
S25T PWLN R/L 08	8212	1626	5025	-	-	-	2.0
S32U PWLN R/L 08	8012	1608	5003	3008	4112	0012	3.0
S40V PWLN R/L 08	8012	1608	5003	3008	4112	0012	3.0

WNMG 80° trigon negative inserts. A50-51
80° trigon negative Wendeschneidplatten.

Reference / Bez.	l	s	d
WNMG 0604..	6,45	4,76	9,52
WNMG 0804..	8,14	4,76	12,70

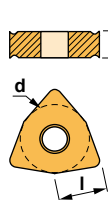



Characteristics:

Boring bar for internal turning applications equipped with trigon negative inserts (angle 80°).

For general applications, roughing, semi-finishing and finishing.

Axial -6°
Radial -13.5°

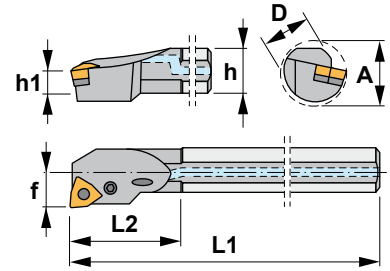

Eigenschaften:

Bohrstangen zum Innendrehen mit negativen Trigon Wendeschneidplatten (80° Winkel). Für allgemeine Anwendungen, Schruppen, Vorschlichten und Schlichten.

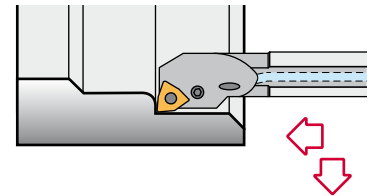

A-PWLN 95°

Reference Bezeichnung	D	h	h1	L1	L2	f	A	Insert size Wendeschneidplatte	Kg
A16M PWLN R/L 06	16	15	7,5	150	30	11	20	WNM.. 0604..	0,200
A20Q PWLN R/L 06	20	18	9,0	180	35	13	27	WNM.. 0604..	0,400
A25R PWLN R/L 06	25	23	11,5	200	40	17	31	WNM.. 0604..	0,700
A32S PWLN R/L 06	32	30	15,0	250	45	22	39	WNM.. 0604..	1,400
A25R PWLN R/L 08	25	23	11,5	200	40	17	31	WNM.. 0804..	0,700
A32S PWLN R/L 08	32	30	15,0	250	45	22	39	WNM.. 0804..	1,400
A40T PWLN R/L 08	40	37	18,5	300	50	27	48	WNM.. 0804..	2,650

Reference Bezeichnung							Nm
A16M PWLN R/L 06	8216	1605	5002	-	-	-	1.4
A20Q PWLN R/L 06	8216	1605	5002	-	-	-	1.4
A25R PWLN R/L 06	8009	1606	5025	3007	4109	0009	2.0
A32S PWLN R/L 06	8009	1606	5025	3007	4109	0009	2.0
A25R PWLN R/L 08	8212	1626	5025	-	-	-	2.0
A32S PWLN R/L 08	8012	1608	5003	3008	4112	0012	3.0
A40T PWLN R/L 08	8012	1608	5003	3008	4112	0012	3.0

WNMG

80° trigon negative inserts. A50-51
80° trigon negative Wendeschneidplatten.

Reference / Bez.	l	s	d
WNMG 0604..	6,45	4,76	9,52
WNMG 0804..	8,14	4,76	12,70

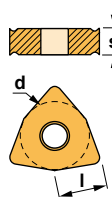

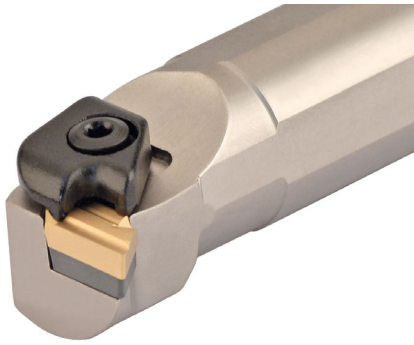

Characteristics:

Boring bar for internal turning and profiling operations equipped with KNUX negative insert.

For semi-finishing and finishing operations.

Axial -6°
Radial -10°

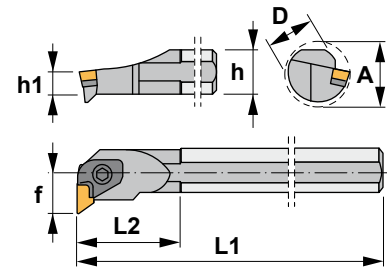

Eigenschaften:

Bohrstange zum Innen- und Profildrehen mit negativen KNUX Wendeschneidplatten.
Zum Vorschlichten und Schlichten.

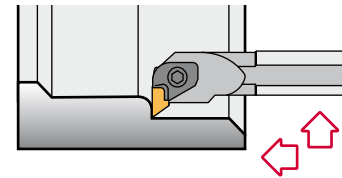

CKUN 93°

Reference Bezeichnung	D	h	h1	L1	L2	f	A	Insert size Wendeschneidplatte	Kg
S25T CKUN R/L 16	25	23	11,5	300	40	20,5	37	KNUX 1604..	0,700
S32U CKUN R/L 16	32	30	15,0	350	45	22,0	39	KNUX 1604..	2,050
S40V CKUN R/L 16	40	37	18,5	400	50	27,0	48	KNUX 1604..	3,750
S50W CKUN R/L 16	50	47	23,5	450	60	35,0	61	KNUX 1604..	6,500

Reference Bezeichnung								Nm
S25T CKUN L 16	2316	1614	5004	4295	4201	-	-	3.5
S32U CKUN L 16	2316	1614	5004	4295	4202	3226	4012	3.5
S40V CKUN L 16	2316	1614	5004	4295	4204	3226	4012	3.5
S50W CKUN L 16	2316	1614	5004	4295	4204	3226	4012	3.5
S25T CKUN R 16	2326	1614	5004	4295	4201	-	-	3.5
S32U CKUN R 16	2326	1614	5004	4295	4202	3236	4012	3.5
S40V CKUN R 16	2326	1614	5004	4295	4204	3236	4012	3.5
S50W CKUN R 16	2326	1614	5004	4295	4204	3236	4012	3.5

KNUX

KNUX negative insert.
KNUX negative Wendeschneidplatte. A38

Reference / Bezeichnung	l	s	d
KNUX 1604..	16,00	4,76	9,52

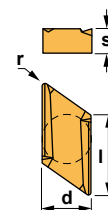

KNUX





Characteristics:

Boring bar for internal turning applications equipped with square positive inserts.
For interrupted cut choose boring bars Ref. PSKN (Page: A193).

Axial 6.5°
Radial -1.25°

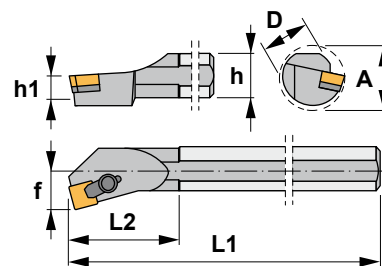

Eigenschaften:

Bohrstange zum Innendrehen mit vierkantigen positiven Wendeschneidplatten.
Für unterbrochenen Schnitt wählen Sie Bohrstanen PSKN (Seite: A193).

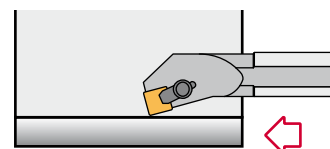

CSKP 75°

Reference Bezeichnung	D	h	h1	L1	L2	f	A	Insert size Wendeschneidplatte	kg
S16R CSKP R/L 09	16	15	7,5	200	30	11	20	SP.. 0903..	0,300
S20S CSKP R/L 09	20	18	9,0	250	35	13	24	SP.. 0903..	0,550
S25T CSKP R/L 12	25	23	11,5	300	40	17	31	SP.. 1203..	1,050
S32U CSKP R/L 12	32	30	15,0	350	45	22	39	SP.. 1203..	2,050
S40V CSKP R/L 12	40	37	18,5	400	50	27	48	SP.. 1203..	3,750
S50W CSKP R/L 12	50	47	23,5	450	60	35	61	SP.. 1203..	6,500
S50W CSKP R/L 19	50	47	23,5	450	60	35	61	SP.. 1904..	6,500

Reference Bezeichnung					Nm
S16R CSKP R/L 09	2107	5025	-	-	2.0
S20S CSKP R/L 09	2107	5025	-	-	2.0
S25T CSKP R/L 12	2109	5003	-	-	3.0
S32U CSKP R/L 12	2209	5003	3112	4002	3.0
S40V CSKP R/L 12	2209	5003	3112	4002	3.0
S50W CSKP R/L 12	2209	5003	3112	4002	3.0
S50W CSKP R/L 19	2211	5004	3119	4012	3.5

SP..

Square positive inserts with 11° clearance. Vierkantige positive Wendeschneidplatten mit 11° Freiwinkel. A43

Reference / Bezeichnung	l	s	d
SP.. 0903..	9,52	3,18	9,52
SP.. 1203..	12,70	3,18	12,70
SP.. 1904..	19,05	4,76	19,05

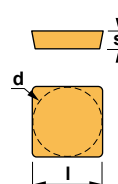

SPMR



SPUN



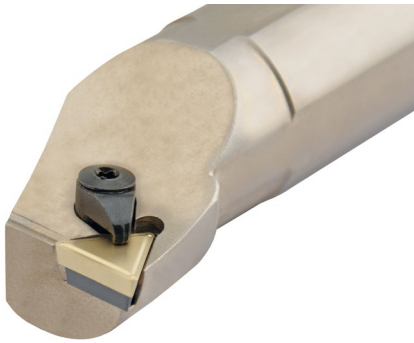

Characteristics:

Boring bar for internal turning applications equipped with triangular positive inserts. For interrupted cut choose boring bars Ref. MTFN (Page: A181) or PTFN (Page: A196).

Axial 6°
Radial 0°

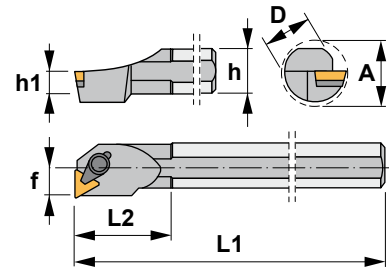

Eigenschaften:

Bohrstange zum Innendrehen mit dreieckigen positiven Wendeschneidplatten. Für unterbrochenen Schnitt wählen Sie Bohrstanen MTFN (Seite: A181) oder PTFN (Seite: A196).

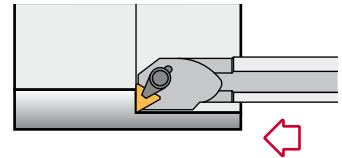

CTFP 90°

Reference Bezeichnung	D	h	h1	L1	L2	f	A	Insert size Wendeschneidplatte	
S10M CTFP R/L 09	10	9	4,5	150	22	7	13	TP.. 0902..	0,060
S12M CTFP R/L 09	12	11	5,5	150	25	9	16	TP.. 0902..	0,150
S12M CTFP R/L 11	12	11	5,5	150	25	9	16	TP.. 1103..	0,150
S16R CTFP R/L 11	16	15	7,5	200	30	11	20	TP.. 1103..	0,300
S20S CTFP R/L 11	20	18	9,0	250	35	13	24	TP.. 1103..	0,550
S16R CTFP R/L 16	16	15	7,5	200	30	11	20	TP.. 1603..	0,300
S20S CTFP R/L 16	20	18	9,0	250	35	13	24	TP.. 1603..	0,550
S25T CTFP R/L 16	25	23	11,5	300	40	17	31	TP.. 1603..	0,700
S32U CTFP R/L 16	32	30	15,0	350	45	22	39	TP.. 1603..	2,050
S40V CTFP R/L 16	40	37	18,5	400	50	27	48	TP.. 1603..	3,750
S50W CTFP R/L 16	50	47	23,5	450	60	35	61	TP.. 1603..	6,500
S40V CTFP R/L 22	40	37	18,5	400	50	27	48	TP.. 2204..	3,750
S50W CTFP R/L 22	50	47	23,5	450	60	35	61	TP.. 2204..	6,500

Reference Bezeichnung							Nm
S10M CTFP R/L 09	2000	5015	-	-	-	-	0.6
S12M CTFP R/L 09	2000	5015	-	-	-	-	0.6
S12M CTFP R/L 11	2304	5025	-	-	-	-	2.0
S16R CTFP R/L 11	2107	5025	-	-	-	-	2.0
S20S CTFP R/L 11	2107	5025	-	-	-	-	2.0
S16R CTFP R/L 16	2119	5003	-	-	-	-	3.0
S20S CTFP R/L 16	2119	5003	-	-	-	-	3.0
S25T CTFP R/L 16	2109	5003	-	-	-	-	3.0
S32U CTFP R/L 16	2209	5003	3116	4002	-	-	3.0
S40V CTFP R/L 16	2209	5003	3116	4002	-	-	3.0
S50W CTFP R/L 16	2209	5003	3116	4002	-	-	3.0
S40V CTFP R/L 22	2211	5004	3122	4012	-	-	3.5
S50W CTFP R/L 22	2211	5004	3122	4012	-	-	3.5

TP.. Triangular positive inserts with 11° clearance. A47
Dreieckige positive Wendeschneidplatten mit 11° Freiwinkel.

Reference / Bez.	l	s	d
TP.. 0902..	9,62	2,38	5,55
TP.. 1103..	11,00	3,18	6,35
TP.. 1603..	16,50	3,18	9,52
TP.. 2204..	22,00	4,76	12,70

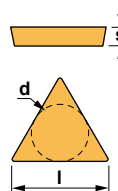

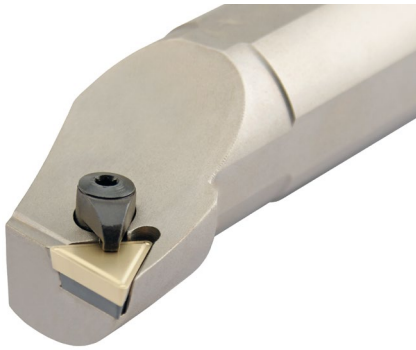

Characteristics:

Boring bar for internal turning applications equipped with triangular positive inserts. For interrupted cut choose boring bars Ref. MTUN (Page: A183).

Axial 0°
Radial -6°

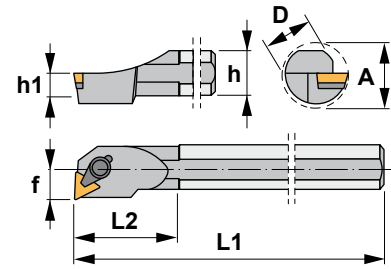

Eigenschaften:

Bohrstange zum Innendrehen mit dreikantigen positiven Wendschneidplatten. Für unterbrochenen Schnitt wählen Sie Bohrstanen MTUN (Seite: A183).

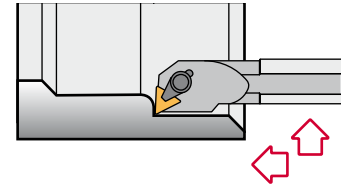

CTUP 93°

Reference Bezeichnung	D	h	h1	L1	L2	f	A	Insert size Wendschneidplatte	⚖️ Kg
S10M CTUP R/L 09	10	9	4,5	150	22	7	13	TP.. 0902..	0,060
S12M CTUP R/L 09	12	11	5,5	150	25	9	16	TP.. 0902..	0,150
S12M CTUP R/L 11	12	11	5,5	150	25	9	16	TP.. 1103..	0,150
S16R CTUP R/L 11	16	15	7,5	200	30	11	20	TP.. 1103..	0,300
S20S CTUP R/L 11	20	18	9,0	250	35	13	24	TP.. 1103..	0,550
S16R CTUP R/L 16	16	15	7,5	200	30	11	20	TP.. 1603..	0,300
S20S CTUP R/L 16	20	18	9,0	250	35	13	24	TP.. 1603..	0,550
S25T CTUP R/L 16	25	23	11,5	300	40	17	31	TP.. 1603..	0,700
S32U CTUP R/L 16	32	30	15,0	350	45	22	39	TP.. 1603..	2,050
S40V CTUP R/L 16	40	37	18,5	400	50	27	48	TP.. 1603..	3,750
S50W CTUP R/L 16	50	47	23,5	450	60	35	61	TP.. 1603..	6,500
S40V CTUP R/L 22	40	37	18,5	400	50	27	48	TP.. 2204..	3,750
S50W CTUP R/L 22	50	47	23,5	450	60	35	61	TP.. 2204..	6,500

Reference Bezeichnung					Nm
S10M CTUP R/L 09	2000	5015	-	-	0.6
S12M CTUP R/L 09	2000	5015	-	-	0.6
S12M CTUP R/L 11	2304	5025	-	-	2.0
S16R CTUP R/L 11	2107	5025	-	-	2.0
S20S CTUP R/L 11	2107	5025	-	-	2.0
S16R CTUP R/L 16	2119	5003	-	-	3.0
S20S CTUP R/L 16	2119	5003	-	-	3.0
S25T CTUP R/L 16	2109	5003	-	-	3.0
S32U CTUP R/L 16	2209	5003	3116	4002	3.0
S40V CTUP R/L 16	2209	5003	3116	4002	3.0
S50W CTUP R/L 16	2209	5003	3116	4002	3.0
S40V CTUP R/L 22	2211	5004	3122	4012	3.5
S50W CTUP R/L 22	2211	5004	3122	4012	3.5

TP.. Triangular positive inserts with 11° clearance. Dreikantige positive Wendschneidplatten mit 11° Freiwinkel. A47

Reference / Bez.	l	s	d
TP.. 0902..	9,62	2,38	5,55
TP.. 1103..	11,00	3,18	6,35
TP.. 1603..	16,50	3,18	9,52
TP.. 2204..	22,00	4,76	12,70

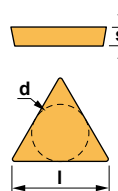

TPMN	TPMR	TPUN
TPUX-R	TPUX-L	



Characteristics:
Multipurpose boring bar for grooving,
threading and turning.
For smaller diameters from 4,2 mm.

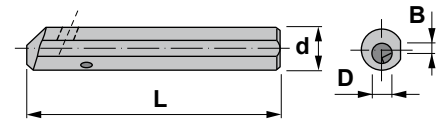

Eigenschaften:
Multifunktions-Bohrstange zum Stechen,
Gewindedrehen und Drehen.
Für kleinere Durchmesser ab 4,2 mm.

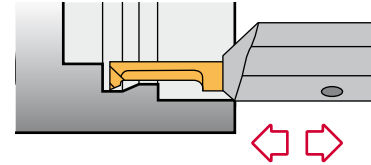

00.30

Reference Bezeichnung	L	d	B	D	Tool size Werkzeug	
00.30.12.04	100	12	2,35	2,5 / 4,2	CTI 04..	0,070
00.30.16.06	120	16	2,80	8,2	CTI 06..	0,150

Reference Bezeichnung			Nm
00.30.12.04	1505	5025	2.0
00.30.16.06	1506	5003	3.0

Characteristics:
Turning tool.
Eigenschaften:
Drehwerkzeuge.



AR

Reference Bezeichnung	L	d	B	Dmin	r
CTI 0402 AR	15	4	0,8	4,2	0,2
CTI 0602 AR	20	6	1,8	6,2	0,2

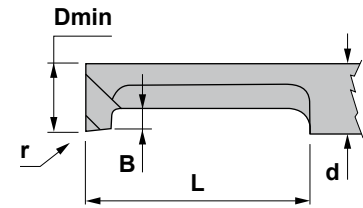

Characteristics:
Copying tool.
Eigenschaften:
Kopierwerkzeuge.



BR

Reference Bezeichnung	L	d	B	Dmin	r
CTI 0402 BR	15	4	0,8	4,2	0,2
CTI 0602 BR	20	6	1,8	6,2	0,2

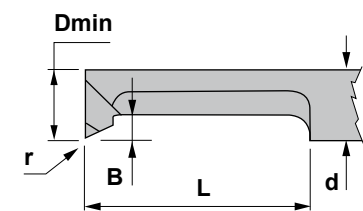

Characteristics:
Threading tool.
Eigenschaften:
Gewindewerkzeuge.



CR

Reference Bezeichnung	L	d	B	Dmin
CTI 0400 CR	15	4	0,8	M5
CTI 0600 CR	20	6	1,8	M8

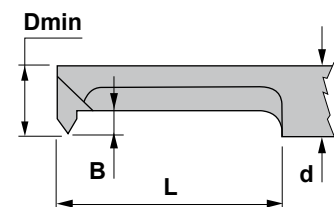

Characteristics:
Grooving tool.
Eigenschaften:
Stechwerkzeuge.



DR

Reference Bezeichnung	L	d	B	Dmin
CTI 0410 DR	15	4	1,0	4,2
CTI 0615 DR	20	6	1,8	6,2

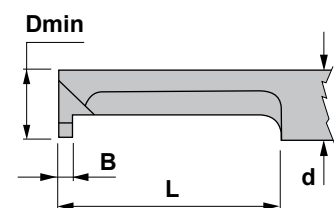



Characteristics: Multipurpose boring bar for grooving, threading and turning.
For smaller diameters from 8 mm.

Eigenschaften: Multifunktions-Bohrstange zum Stechen, Gewindedrehen und Drehen.
Für kleinere Durchmesser ab 8 mm.

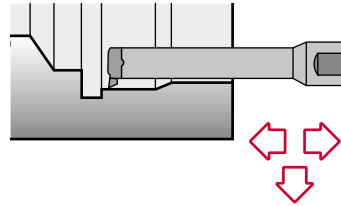
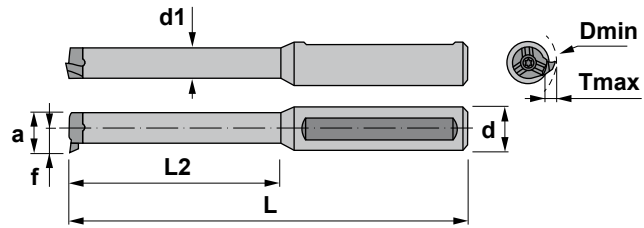

608.00

Reference Bezeichnung	Dmin	d	d1	L	L2	a	f	Tmax	Insert size Wendeschneidplatte	kg
608.0012.2 HM	8	12	6	90	30	7,8	4,8	1,0	R/LS08	0,090
611.0012.2 HM	11	12	8	110	42	10,7	6,7	2,3	R/LS11	0,090
614.0012.2 HM	14	12	11	110	45	13,8	9,0	4,0	R/LS14	0,130
616.0012.2 HM	16	12	11	130	56	15,7	10,2	4,3	R/LS16	0,265

Reference Bezeichnung			Nm
608.0012.2 HM	1226	5508	1.2
611.0012.2 HM	1535	5510	2.0
614.0012.2 HM	1244	5515	3.0
616.0012.2 HM	1255	5520	4.0

R/LS..

B11-15

Reference / Bez.	d
R/LS.. 08..	6,0
R/LS.. 11..	8,0
R/LS.. 14..	9,0
R/LS.. 16..	11,0

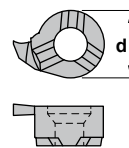

R/LS

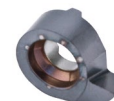

Insert for turning
WSP zum Drehen

R/LS

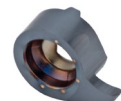

Insert for grooving with radius
WSP zum Vollradius-Stecken

R/LS

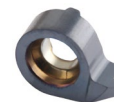

Insert for threading
WSP zum Gewindedrehen

R/LS



Insert for grooving
WSP zum Stecken



Characteristics:
Multipurpose boring bar equipped with rhombic positive insert (angle 80°).
For boring bars with negative inserts see Ref. MCLN-K (Page: A178) or PCLN (Page: A188).

Axial 0°
Radial -6°

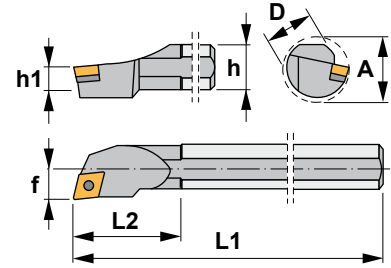

Eigenschaften:
Multifunktions-Bohrstange mit rhombischen positiven Wendeschneidplatten (80° Winkel).
Für Bohrstanen mit negativen Wendeschneidplatten siehe MCLN-K (Seite: A178) oder PCLN (Seite: A188).

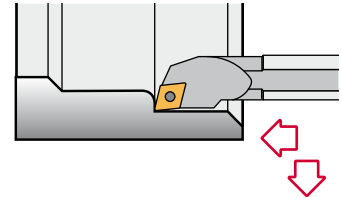

SCLC 95°

Reference Bezeichnung	D	h	h1	L1	L2	f	A	Insert size Wendeschneidplatte	Kg
S08K SCLC R/L 06	8	7	3,5	125	16	5	11	CC.. 0602..	0,040
S10M SCLC R/L 06	10	9	4,5	150	22	7	13	CC.. 0602..	0,060
S12M SCLC R/L 06	12	11	5,5	150	25	9	16	CC.. 0602..	0,150
S12M SCLC R/L 09	12	11	5,5	150	25	9	16	CC.. 09T3..	0,150
S12Q SCLC R/L 09	12	11	5,5	180	25	9	16	CC.. 09T3..	0,150
S16R SCLC R/L 09	16	15	7,5	200	30	11	20	CC.. 09T3..	0,300
S20S SCLC R/L 09	20	18	9,0	250	35	13	24	CC.. 09T3..	0,550
S25T SCLC R/L 09	25	23	11,5	300	40	17	31	CC.. 09T3..	0,550
S20S SCLC R/L 12	20	18	9,0	250	35	13	24	CC.. 1204..	0,550
S25T SCLC R/L 12	25	23	11,5	300	40	17	31	CC.. 1204..	0,700
S32U SCLC R/L 12	32	30	15,0	350	45	22	39	CC.. 1204..	2,050
S40V SCLC R/L 12	40	37	18,5	400	50	27	48	CC.. 1204..	3,750
S50W SCLC R/L 12	50	47	23,5	450	60	35	61	CC.. 1204..	6,500

Reference Bezeichnung					Nm
S08K SCLC R/L 06	1425	5507	-	-	0.9
S10M SCLC R/L 06	1425	5507	-	-	0.9
S12M SCLC R/L 06	1425	5507	-	-	0.9
S12M SCLC R/L 09	1440	5515	-	-	3.0
S12Q SCLC R/L 09	1440	5515	-	-	3.0
S16R SCLC R/L 09	1440	5515	-	-	3.0
S20S SCLC R/L 09	1440	5515	-	-	3.0
S25T SCLC R/L 09	1240	5515	-	-	3.0
S20S SCLC R/L 12	1250	5520	-	-	4.0
S25T SCLC R/L 12	1250	5520	-	-	4.0
S32U SCLC R/L 12	1540	5517	3614	1760	3.0
S40V SCLC R/L 12	1540	5517	3614	1760	3.0
S50W SCLC R/L 12	1540	5517	3614	1760	3.0

CC.. 80° rhombic positive inserts with 7° clearance. A30-31
80° rhombische positive Wendeschneidplatten mit 7° Freiwinkel.

Reference / Bez.	l	s	d
CC.. 0602..	6,45	2,38	6,35
CC.. 09T3..	9,65	3,97	9,52
CC.. 1204..	12,90	4,76	12,70

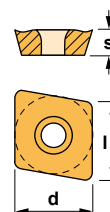

CCGT-AL **CCGT-AP**



CCMT

CCMW





Characteristics:

Multipurpose boring bar equipped with rhombic positive insert (angle 80°).

For boring bars with negative inserts see Ref. MCLN-K (Page: A178) or A-PCLN (Page: A189).

Axial 0°
Radial -6°

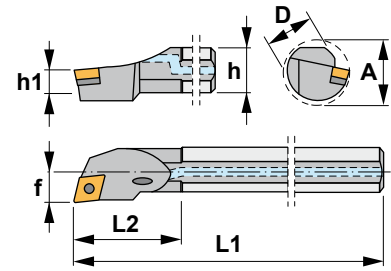

Eigenschaften:

Multifunktions-Bohrstange mit rhombischen positiven Wendeschneidplatten (80° Winkel).

Für Bohrstanen mit negativen Wendeschneidplatten siehe MCLN-K (Seite: A178) oder A-PCLN (Seite: A189).

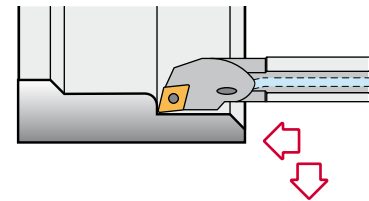

A-SCLC 95°

Reference Bezeichnung	D	h	h1	L1	L2	f	A	Insert size Wendeschneidplatte	
A08F SCLC R/L 06	8	7	3,5	80	20	5	11	CC.. 0602..	0,030
A10H SCLC R/L 06	10	9	4,5	100	20	7	13	CC.. 0602..	0,040
A12K SCLC R/L 06	12	11	5,5	125	25	9	16	CC.. 0602..	0,100
A16M SCLC R/L 09	16	15	7,5	150	30	11	20	CC.. 09T3..	0,200
A20Q SCLC R/L 09	20	18	9,0	180	35	13	24	CC.. 09T3..	0,400
A25R SCLC R/L 09	25	23	11,5	200	40	17	31	CC.. 09T3..	0,700
A32S SCLC R/L 12	32	30	15,0	250	45	22	39	CC.. 1204..	1,400
A40T SCLC R/L 12	40	37	18,5	300	50	27	48	CC.. 1204..	2,650

Reference Bezeichnung					Nm
A08F SCLC R/L 06	1425	5507	-	-	0.9
A10H SCLC R/L 06	1425	5507	-	-	0.9
A12K SCLC R/L 06	1425	5507	-	-	0.9
A16M SCLC R/L 09	1440	5515	-	-	3.0
A20Q SCLC R/L 09	1440	5515	-	-	3.0
A25R SCLC R/L 09	1440	5515	-	-	3.0
A32S SCLC R/L 12	1540	5517	3614	1760	3.0
A40T SCLC R/L 12	1540	5517	3614	1760	3.0

CC.. 80° rhombic positive inserts with 7° clearance. A30-31
80° rhombische positive Wendeschneidplatten mit 7° Freiwinkel.

Reference / Bez.	l	s	d
CC.. 0602..	6,45	2,38	6,35
CC.. 09T3..	9,65	3,97	9,52
CC.. 1204..	12,90	4,76	12,70

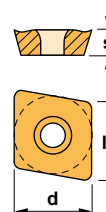

CCGT-AL **CCGT-AP**



CCMT

CCMW





Characteristics:

Set of multipurpose boring bars equipped with rhombic positive insert (angle 80°). For boring bars with negative inserts see Ref. A-PCLN (Page: A189).

Axial 0°
Radial -6°

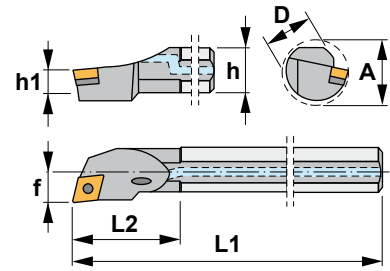

Eigenschaften: Multifunktions-Bohrstangen-Satz mit rhombischen positiven Wendeschneidplatten (80° Winkel). Für Bohrstangen mit negativen Wendeschneidplatten siehe A-PCLN (Seite: A189).

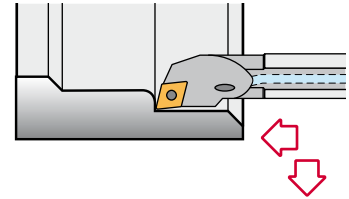

SET SCLC 95°

Reference Bezeichnung	D	d	L1	L2	f	A	h	Insert size Wendeschneidplatte	Kg
A0608H SCLC R/L 06	8	6	100	25	4	10	7	CC.. 0602..	0,400
A0810J SCLC R/L 06	10	8	110	32	6	12	9	CC.. 0602..	
A1012K SCLC R/L 06	12	10	125	38	7	14	11	CC.. 0602..	
A1216M SCLC R/L 06	16	12	150	50	9	18	15	CC.. 0602..	

Reference Bezeichnung			Nm	
A0608H SCLC R/L 06		1425	5507	0.9
A0810J SCLC R/L 06		1425	5507	0.9
A1012K SCLC R/L 06		1225	5507	0.9
A1216M SCLC R/L 06		1225	5507	0.9

CC.. 80° rhombic positive inserts with 7° clearance. A30-31
80° rhombische positive Wendeschneidplatten mit 7° Freiwinkel.

Reference / Bez.	l	s	d
CC.. 0602..	6,45	2,38	6,35

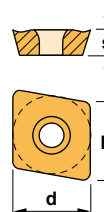

CCGT-AL



CCGT-AP



CCMT



CCMW





Characteristics:

Carbide boring bar equipped with rhombic positive insert (angle 80°).
Range starting at Ø4 mm and minimum bore diameter of 5 mm.

Axial 0°
Radial -6°

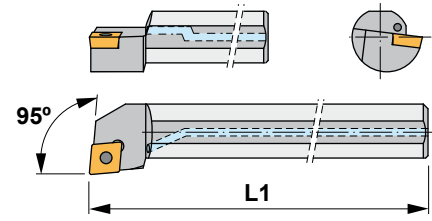

Eigenschaften:

Hartmetall-Bohrstange mit rhombischen positiven Wendeschneidplatten (80° Winkel).

Das Sortiment fängt ab Ø4 mm an, für eine 5 mm Mindestbohrung.

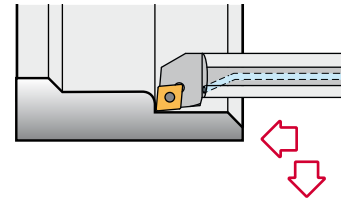

E-SCLC 95°



Reference Bezeichnung	L1 Total length (mm) L1 Gesamtlänge (mm)	Ø min. (mm)	Insert size Wendeschneidplatte	
E04G SCLCR 0305	90	5	CC.. 0301..	0,035
E05H SCLCR 0306	100	6	CC.. 0301..	0,040
E06J SCLCR 0307	110	7	CC.. 0301..	0,050
E07K SCLCR 0408	125	8	CC.. 0401..	0,070
E08K SCLCL 06	125	11	CC.. 0602..	0,085
E08K SCLCR 06	125	11	CC.. 0602..	0,085
E10M SCLCL 06	150	14	CC.. 0602..	0,160
E10M SCLCR 06	150	14	CC.. 0602..	0,160
E12Q SCLCL 06	180	17	CC.. 0602..	0,270
E12Q SCLCR 06	180	17	CC.. 0602..	0,270
E16R SCLCL 09	200	21	CC.. 09T3..	0,520
E16R SCLCR 09	200	21	CC.. 09T3..	0,520
E20S SCLCL 09	250	25	CC.. 09T3..	0,990
E20S SCLCR 09	250	25	CC.. 09T3..	0,990

Reference Bezeichnung			Nm
E04G SCLCR 0305	1415	5506	0.6
E05H SCLCR 0306	1415	5506	0.6
E06J SCLCR 0307	1415	5506	0.6
E07K SCLCR 0408	1420	5506	0.6
E08K SCLCL 06	1425	5507	0.9
E08K SCLCR 06	1425	5507	0.9
E10M SCLCL 06	1425	5507	0.9
E10M SCLCR 06	1425	5507	0.9
E12Q SCLCL 06	1425	5507	0.9
E12Q SCLCR 06	1425	5507	0.9
E16R SCLCL 09	1440	5515	3.0
E16R SCLCR 09	1440	5515	3.0
E20S SCLCL 09	1440	5515	3.0
E20S SCLCR 09	1440	5515	3.0

CC.. 80° rhombic positive inserts with 7° clearance. A30-31
80° rhombische positive WSP mit 7° Freiwinkel.

Reference / Bez.	l	s	d
CC.. 0301..	3,60	1,39	3,50
CC.. 0401..	4,40	1,79	4,30
CC.. 0602..	6,45	2,38	6,35
CC.. 09T3..	9,65	3,97	9,52

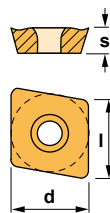

CCET	CCGT-AL	CCGT-AP
CCMT	CCMW	



E-SCLC 95°

Features

- Better rigidity than steel bars.
- Excellent cutting performance in a wide range of boring sizes even at vibration cutting condition.
- Longer tool life and excellent surface finish.
- Range starting at \varnothing 4 mm. and minimum bore diameter of 5 mm.

Besonderheiten

- Bessere Festigkeit als die Stahl-Bohrstangen.
- Hervorragende Schnittleistung in einer breiten Palette von Bohrdurchmessern, auch bei schwingenden Schnittbedingungen.
- Längere Standzeiten und ausgezeichnete Oberflächengüte.
- Die Auswahl beginnt mit \varnothing 4 mm und minimum Bohrdurchmesser 5 mm.

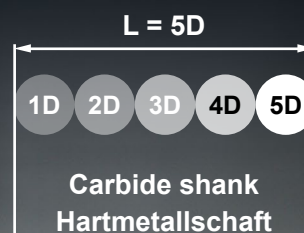
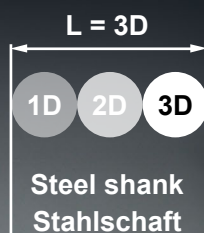

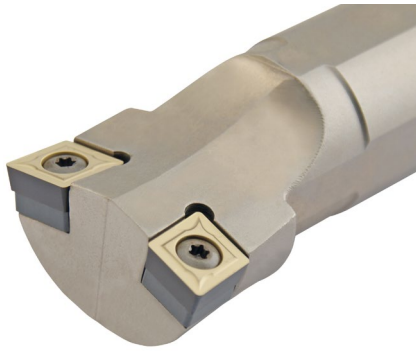

Characteristics:

Multipurpose internal and external boring bar equipped with rhombic positive insert (angle 80°).

For general applications, roughing, semi-finishing and finishing.

Axial 0°
Radial -9°

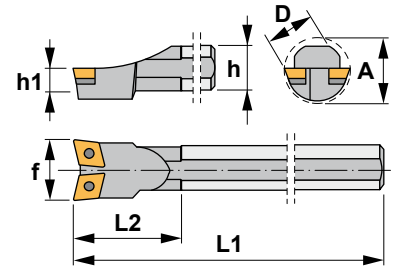

Eigenschaften:



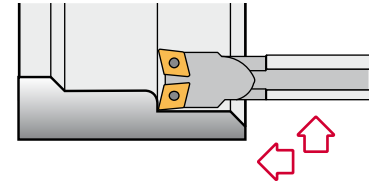

Multifunktions-Bohrstange zum Innen- und Außendrehen mit rhombischen positiven Wendeschneidplatten (80° Winkel).

Für allgemeine Anwendungen, Schruppen, Vorschlichten und Schlichten.



SCLCN 95°

Reference Bezeichnung	D	h	h1	L1	L2	f	A	Insert size Wendeschneidplatte	Ⓚ Kg
S12M SCLC N 06	12	11	5,5	150	25	18	20	CC.. 0602..	0,150
S16R SCLC N 06	16	15	7,5	200	30	22	25	CC.. 0602..	0,300
S20S SCLC N 06	20	18	9,0	250	35	26	30	CC.. 0602..	0,550
S25T SCLC N 09	25	23	11,5	300	40	34	40	CC.. 09T3..	0,700
S32U SCLC N 12	32	30	15,0	350	45	44	50	CC.. 1204..	2,050
S40V SCLC N 12	40	37	18,5	400	50	54	60	CC.. 1204..	3,750
S50W SCLC N 12	50	47	23,5	450	60	62	68	CC.. 1204..	6,500

Reference Bezeichnung					Nm
S12M SCLC N 06	1425	5507	-	-	0.9
S16R SCLC N 06	1225	5507	-	-	0.9
S20S SCLC N 06	1225	5507	-	-	0.9
S25T SCLC N 09	1440	5515	-	-	3.0
S32U SCLC N 12	1540	5517	3614	1760	3.0
S40V SCLC N 12	1540	5517	3614	1760	3.0
S50W SCLC N 12	1540	5517	3614	1760	3.0

CC.. 80° rhombic positive inserts with 7° clearance.  A30-31
80° rhombische positive Wendeschneidplatten mit 7° Freiwinkel.

Reference / Bez.	l	s	d
CC.. 0602..	6,45	2,38	6,35
CC.. 09T3..	9,65	3,97	9,52
CC.. 1204..	12,90	4,76	12,70

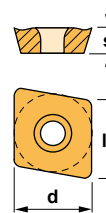

CCGT-AL



CCGT-AP



CCMT



CCMW





Characteristics:

Multipurpose profiling boring bar equipped with rhombic positive insert (angle 55°). For general applications, roughing, semi-finishing and finishing.

Axial 0°
Radial -6°

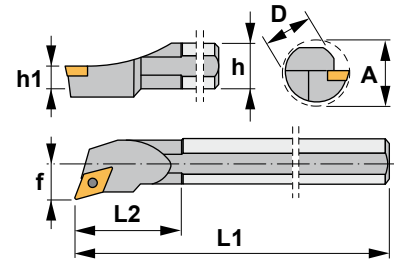

Eigenschaften:

Multifunktions-Bohrstange zum Profildrehen mit rhombischen positiven Wendeschneidplatten (55° Winkel).

Für allgemeine Anwendungen, Schruppen, Vorschlichten und Schlichten.

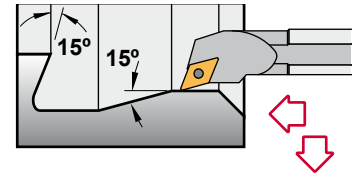

SDQC 107°30'

Reference Bezeichnung	D	h	h1	L1	L2	f	A	Insert size Wendeschneidplatte	kg
S10M SDQC R/L 07	10	9	4,5	150	22	7	13	DC.. 0702..	0,060
S12M SDQC R/L 07	12	11	5,5	150	25	9	16	DC.. 0702..	0,150
S16R SDQC R/L 07	16	15	7,5	200	30	11	20	DC.. 0702..	0,300
S20S SDQC R/L 07	20	18	9,0	250	35	13	24	DC.. 0702..	0,550
S20S SDQC R/L 11	20	18	9,0	250	35	13	24	DC.. 11T3..	0,550
S25T SDQC R/L 11	25	23	11,5	300	40	17	31	DC.. 11T3..	0,700
S32U SDQC R/L 11	32	30	15,0	350	45	22	39	DC.. 11T3..	2,050
S40V SDQC R/L 11	40	37	18,5	400	50	27	48	DC.. 11T3..	3,750

Reference Bezeichnung					Nm
S10M SDQC R/L 07	1425	5507	-	-	0.9
S12M SDQC R/L 07	1225	5507	-	-	0.9
S16R SDQC R/L 07	1225	5507	-	-	0.9
S20S SDQC R/L 07	1225	5507	-	-	0.9
S20S SDQC R/L 11	1240	5515	-	-	3.0
S25T SDQC R/L 11	1240	5515	-	-	3.0
S32U SDQC R/L 11	1335	5516	3714	1750	3.0
S40V SDQC R/L 11	1335	5516	3714	1750	3.0

DC.. 55° rhombic positive inserts with 7° clearance. A35
55° rhombische positive Wendeschneidplatten mit 7° Freiwinkel.

Reference / Bez.	l	s	d
DC.. 0702..	7,75	2,38	6,35
DC.. 11T3..	11,60	3,97	9,52

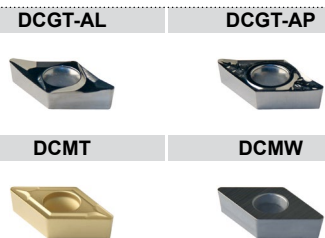
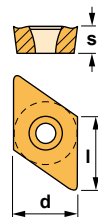



Characteristics:

Multipurpose profiling boring bar equipped with rhombic positive insert (angle 55°). For general applications, roughing, semi-finishing and finishing.

Axial 0°
Radial -6°

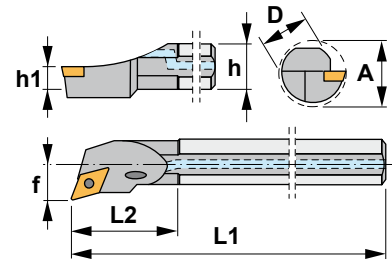

Eigenschaften:

Multifunktions-Bohrstange zum Profildrehen mit rhombischen positiven Wendeschneidplatten (55° Winkel).

Für allgemeine Anwendungen, Schruppen, Vorschlichten und Schlichten.

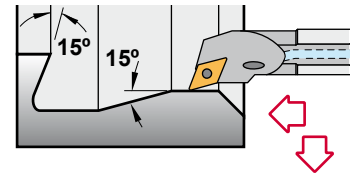

A-SDQC 107°30'

Reference Bezeichnung	D	h	h1	L1	L2	f	A	Insert size Wendeschneidplatte	Kg
A12K SDQC R/L 07	12	11	5,5	125	25	9	16	DC.. 0702..	0,100
A16M SDQC R/L 07	16	15	7,5	150	30	11	20	DC.. 0702..	0,200
A20Q SDQC R/L 11	20	18	9,0	180	35	13	24	DC.. 11T3..	0,400
A25R SDQC R/L 11	25	23	11,5	200	40	17	31	DC.. 11T3..	0,700
A32S SDQC R/L 11	32	30	15,0	250	45	22	39	DC.. 11T3..	1,400
A40T SDQC R/L 11	40	37	18,5	300	50	27	48	DC.. 11T3..	2,650

Reference Bezeichnung					Nm
A12K SDQC R/L 07	1225	5507	-	-	0.9
A16M SDQC R/L 07	1225	5507	-	-	0.9
A20Q SDQC R/L 11	1240	5515	-	-	3.0
A25R SDQC R/L 11	1240	5515	-	-	3.0
A32S SDQC R/L 11	1335	5516	3714	1750	3.0
A40T SDQC R/L 11	1335	5516	3714	1750	3.0

DC.. 55° rhombic positive inserts with 7° clearance. A35
55° rhombische positive Wendeschneidplatten mit 7° Freiwinkel.

Reference / Bez.	l	s	d
DC.. 0702..	7,75	2,38	6,35
DC.. 11T3..	11,60	3,97	9,52

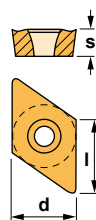

DCGT-AL **DCGT-AP**



DCMT

DCMW

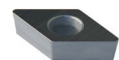



Characteristics:

Set of multipurpose profiling boring bars equipped with rhombic positive insert (angle 55°).

For general applications, roughing, semi-finishing and finishing.

Axial 0°
Radial -6°

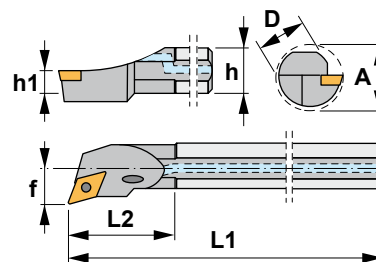

Eigenschaften:

Multifunktions-Bohrstangen-Satz zum Profildrehen mit rhombischen positiven Wendeschneidplatten (55° Winkel).

Für allgemeine Anwendungen, Schruppen, Vorschlichten und Schlichten.

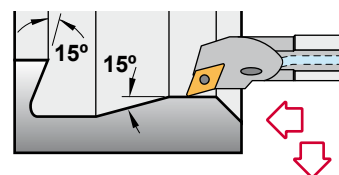

SET SDQC 107°30'

Reference Bezeichnung	D	d	L1	L2	f	A	h	Insert size Wendeschneidplatte	Kg
A0810J SDQC R/L 07	10	8	110	32	7	12,5	9	DC.. 0702..	0,350
A1012K SDQC R/L 07	12	10	125	38	9	15,5	11	DC.. 0702..	
A1216M SDQC R/L 07	16	12	150	50	11	19,5	15	DC.. 0702..	

Reference Bezeichnung			Nm	
A0810J SDQC R/L 07		1225	5507	0.9
A1012K SDQC R/L 07		1225	5507	0.9
A1216M SDQC R/L 07		1225	5507	0.9

DC.. 55° rhombic positive inserts with 7° clearance. A35
55° rhombische positive Wendeschneidplatten mit 7° Freiwinkel.

Reference / Bez.	l	s	d
DC.. 0702..	7,75	2,38	6,35

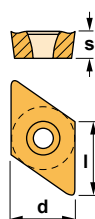

DCGT-AL



DCGT-AP



DCMT



DCMW

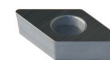



Characteristics:

Carbide boring bar equipped with rhombic positive insert (angle 55°). Range starting at Ø10 mm and minimum bore diameter of 14 mm.

Axial 0°
Radial -6°

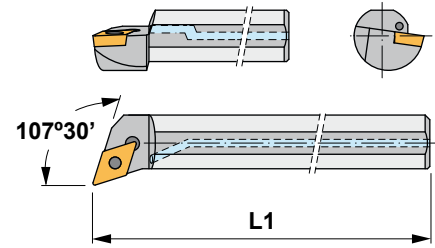

Eigenschaften:

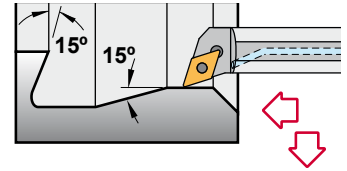

Hartmetall-Bohrstange mit rhombischen positiven Wendeschneidplatten (55° Winkel).

Das Sortiment fängt ab Ø10 mm an, für eine 14 mm Mindestbohrung.



E-SDQC 107°30'  

Reference Bezeichnung	L1 Total length (mm) L1 Gesamtlänge (mm)	Ø min. (mm)	Insert size Wendeschneidplatte	
E10M SDQCL 07	150	14	DC.. 0702..	0,165
E10M SDQCR 07	150	14	DC.. 0702..	0,165
E12Q SDQCL 07	180	17	DC.. 0702..	0,270
E12Q SDQCR 07	180	17	DC.. 0702..	0,270
E16R SDQCL 07	200	21	DC.. 0702..	0,520
E16R SDQCR 07	200	21	DC.. 0702..	0,520
E20S SDQCR 07	250	25	DC.. 0702..	0,800
E25T SDQCR 11	300	25	DC.. 11T3..	1,000

Reference Bezeichnung			Nm
E10M SDQCL 07	1425	5507	0.9
E10M SDQCR 07	1425	5507	0.9
E12Q SDQCL 07	1225	5507	0.9
E12Q SDQCR 07	1225	5507	0.9
E16R SDQCL 07	1225	5507	0.9
E16R SDQCR 07	1225	5507	0.9
E20S SDQCR 07	1225	5507	0.9
E25T SDQCR 11	1240	5515	3.0

DC.. 55° rhombic positive inserts with 7° clearance.  A35
55° rhombische positive Wendeschneidplatten mit 7° Freiwinkel.

Reference / Bez.	l	s	d
DC.. 0702..	7,75	2,38	6,35
DC.. 11T3..	11,60	3,97	9,52

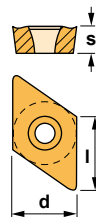

DCGT-AL



DCGT-AP



DCMT



DCMW

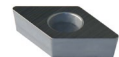



Characteristics:

Multipurpose profiling boring bar equipped with rhombic positive insert (angle 55°). For boring bars with negative inserts see Ref. MDUN-K (Page: A179) or PDUN (Page: A190).

Axial 0°
Radial -6°

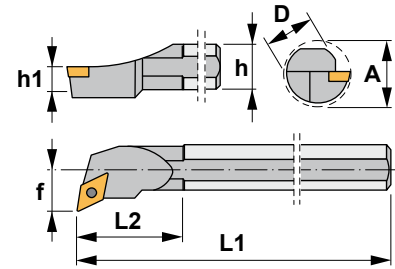

Eigenschaften:

Multifunktions-Bohrstange zum Profildrehen mit rhombischen positiven Wendeschneidplatten (55° Winkel). Für Bohrstanen mit negativen Wendeschneidplatten siehe MDUN-K (Seite: A179) oder PDUN (Seite: A190).

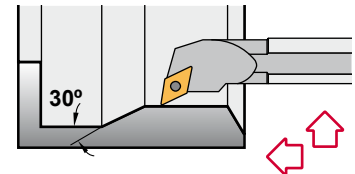

SDUC 93°

Reference Bezeichnung	D	h	h1	L1	L2	f	A	Insert size Wendeschneidplatte	kg
S10M SDUC R/L 07	10	9	4,5	150	22	7	13	DC.. 0702..	0,060
S12M SDUC R/L 07	12	11	5,5	150	25	9	16	DC.. 0702..	0,150
S12Q SDUC R/L 07	12	11	5,5	180	25	9	16	DC.. 0702..	0,150
S16R SDUC R/L 07	16	15	7,5	200	30	11	20	DC.. 0702..	0,300
S20S SDUC R/L 07	20	18	9,0	250	35	13	24	DC.. 0702..	0,550
S20S SDUC R/L 11	20	18	9,0	250	35	13	24	DC.. 11T3..	0,550
S25T SDUC R/L 11	25	23	11,5	300	40	17	31	DC.. 11T3..	0,700
S32U SDUC R/L 11	32	30	15,0	350	45	22	39	DC.. 11T3..	2,050
S40V SDUC R/L 11	40	37	18,5	400	50	27	48	DC.. 11T3..	3,750

Reference Bezeichnung					Nm
S10M SDUC R/L 07	1425	5507	-	-	0.9
S12M SDUC R/L 07	1225	5507	-	-	0.9
S12Q SDUC R/L 07	1225	5507	-	-	0.9
S16R SDUC R/L 07	1225	5507	-	-	0.9
S20S SDUC R/L 07	1225	5507	-	-	0.9
S20S SDUC R/L 11	1240	5515	-	-	3.0
S25T SDUC R/L 11	1240	5515	-	-	3.0
S32U SDUC R/L 11	1335	5516	3714	1750	3.0
S40V SDUC R/L 11	1335	5516	3714	1750	3.0

DC.. 55° rhombic positive inserts with 7° clearance. A35
55° rhombische positive Wendeschneidplatten mit 7° Freiwinkel.

Reference / Bez.	l	s	d
DC.. 0702..	7,75	2,38	6,35
DC.. 11T3..	11,60	3,97	9,52

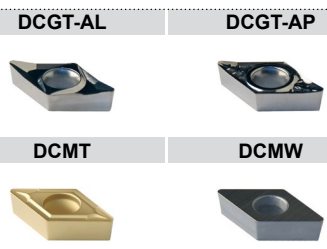
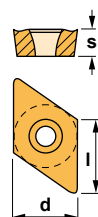



Characteristics:

Multipurpose profiling boring bar equipped with rhombic positive insert (angle 55°). For boring bars with negative inserts see Ref. MDUN-K (Page: A179) or A-PDUN (Page: A191).

Axial 0°
Radial -6°

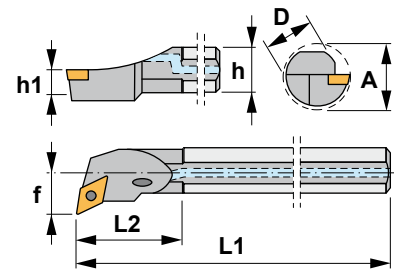

Eigenschaften:

Multifunktions-Bohrstange zum Profildrehen mit rhombischen positiven Wendeschneidplatten (55° Winkel). Für Bohrstanen mit negativen Wendeschneidplatten siehe MDUN-K (Seite: A179) oder A-PDUN (Seite: A191).

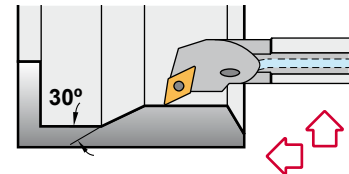

A-SDUC 93°

Reference Bezeichnung	D	h	h1	L1	L2	f	A	Insert size Wendeschneidplatte	
A12K SDUC R/L 07	12	11	5,5	125	25	9	16	DC.. 0702..	0,100
A16M SDUC R/L 07	16	15	7,5	150	30	11	20	DC.. 0702..	0,200
A20Q SDUC R/L 11	20	18	9,0	180	35	13	24	DC.. 11T3..	0,400
A25R SDUC R/L 11	25	23	11,5	200	40	17	31	DC.. 11T3..	0,700
A32S SDUC R/L 11	32	30	15,0	250	45	22	39	DC.. 11T3..	1,400
A40T SDUC R/L 11	40	37	18,5	300	50	27	48	DC.. 11T3..	2,650

Reference Bezeichnung					Nm
A12K SDUC R/L 07	1225	5507	-	-	0.9
A16M SDUC R/L 07	1225	5507	-	-	0.9
A20Q SDUC R/L 11	1440	5515	-	-	3.0
A25R SDUC R/L 11	1240	5515	-	-	3.0
A32S SDUC R/L 11	1335	5516	3714	1750	3.0
A40T SDUC R/L 11	1335	5516	3714	1750	3.0

DC.. 55° rhombic positive inserts with 7° clearance. A35
55° rhombische positive Wendeschneidplatten mit 7° Freiwinkel.

Reference / Bez.	l	s	d
DC.. 0702..	7,75	2,38	6,35
DC.. 11T3..	11,60	3,97	9,52

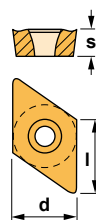

DCGT-AL



DCGT-AP



DCMT



DCMW

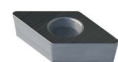



Characteristics:

Set of multipurpose profiling boring bars equipped with rhombic positive insert (angle 55°).

For boring bars with negative inserts see Ref. A-PDUN (Page: A191).

Axial 0°
Radial -6°

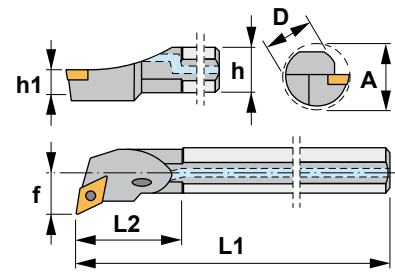

Eigenschaften:

Multifunktions-Bohrstangen-Satz zum Profildrehen mit rhombischen positiven Wendeschneidplatten (55° Winkel).

Für Bohrstangen mit negativen Wendeschneidplatten siehe A-PDUN (Seite: A191).

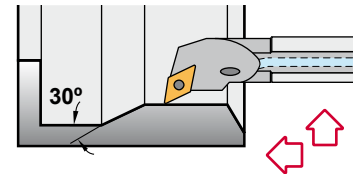

SET SDUC 93°

Reference Bezeichnung	D	d	L1	L2	f	A	h	Insert size Wendeschneidplatte	
A0810J SDUC R/L 07	10	8	110	32	7	12,5	9	DC.. 0702..	0,350
A1012K SDUC R/L 07	12	10	125	38	9	15,5	11	DC.. 0702..	
A1216M SDUC R/L 07	16	12	150	50	11	19,5	15	DC.. 0702..	

Reference Bezeichnung			Nm
A0810J SDUC R/L 07	1225	5507	0.9
A1012K SDUC R/L 07	1225	5507	0.9
A1216M SDUC R/L 07	1225	5507	0.9

DC.. 55° rhombic positive inserts with 7° clearance. A35
55° rhombische positive Wendeschneidplatten mit 7° Freiwinkel.

Reference / Bez.	l	s	d
DC.. 0702..	7,75	2,38	6,35

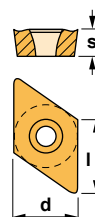

DCGT-AL



DCGT-AP



DCMT



DCMW

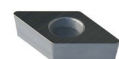

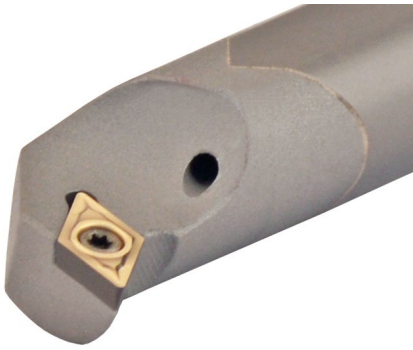

Characteristics:

Carbide boring bar equipped with rhombic positive insert (angle 55°).
Range starting at Ø10 mm and minimum bore diameter of 14 mm.

Axial 0°
Radial -6°

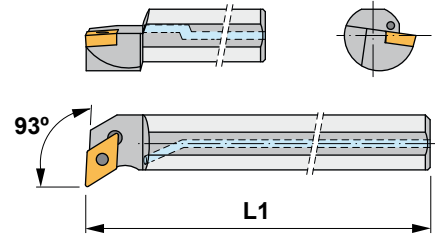

Eigenschaften:

Hartmetall-Bohrstange mit rhombischen positiven Wendeschneidplatten (55° Winkel).

Das Sortiment fängt ab Ø10 mm an, für eine 14 mm Mindestbohrung.

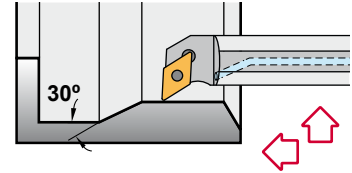

E-SDUC 93°



Reference Bezeichnung	L1 Total length (mm) L1 Gesamtlänge (mm)	Ø min. (mm)	Insert size Wendeschneidplatte	kg
E10M SDUCL 07	150	14	DC.. 0702..	0,165
E10M SDUCR 07	150	14	DC.. 0702..	0,165
E12Q SDUCL 07	180	17	DC.. 0702..	0,265
E12Q SDUCR 07	180	17	DC.. 0702..	0,265
E16R SDUCL 07	200	21	DC.. 0702..	0,525
E16R SDUCR 07	200	21	DC.. 0702..	0,525
E20S SDUCL 11	250	25	DC.. 11T3..	1,000
E20S SDUCR 11	250	25	DC.. 11T3..	1,000
E25T SDUCR 11	300	32	DC.. 11T3..	1,250

Reference Bezeichnung			Nm
E10M SDUCL 07	1425	5507	0.9
E10M SDUCR 07	1425	5507	0.9
E12Q SDUCL 07	1225	5507	0.9
E12Q SDUCR 07	1225	5507	0.9
E16R SDUCL 07	1225	5507	0.9
E16R SDUCR 07	1225	5507	0.9
E20S SDUCL 11	1240	5515	3.0
E20S SDUCR 11	1240	5515	3.0
E25T SDUCR 11	1240	5515	3.0

DC.. 55° rhombic positive inserts with 7° clearance. A35
55° rhombische positive Wendeschneidplatten mit 7° Freiwinkel.

Reference / Bez.	l	s	d
DC.. 0702..	7,75	2,38	6,35
DC.. 11T3..	11,60	3,97	9,52

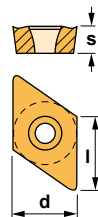

DCGT-AL



DCGT-AP



DCMT



DCMW

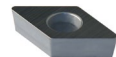



Characteristics:

Backwards multipurpose profiling boring bar equipped with rhombic positive insert (angle 55°).

For boring bars with negative inserts see Ref. PDUN-EX (Page: A192).

Axial 0°
Radial -6°

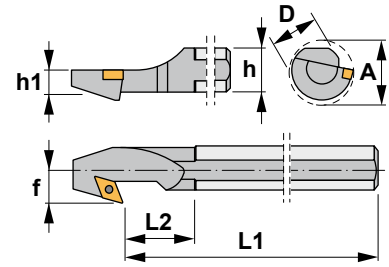

Eigenschaften:

Rückwärts-Multifunktions-Bohrstange zum Profildrehen mit rhombischen positiven Wendeschneidplatten (55° Winkel).

Für Bohrstanen mit negativen Wendeschneidplatten siehe PDUN-EX (Seite: A192).

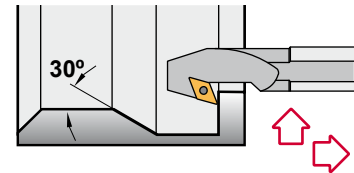

SDUC 93°-EX

Reference Bezeichnung	D	h	h1	L1	L2	f	A	Insert size Wendeschneidplatte	kg
S12MSDUC R/L 07-EX	12	11	5,5	150	25	9	16	DC.. 0702..	0,150
S16R SDUC R/L 07-EX	16	15	7,5	200	30	11	20	DC.. 0702..	0,300
S20S SDUC R/L 07-EX	20	18	9,0	250	35	13	24	DC.. 0702..	0,550
S20S SDUC R/L 11-EX	20	18	9,0	250	35	13	24	DC.. 11T3..	0,550
S25T SDUC R/L 11-EX	25	23	11,5	300	40	17	31	DC.. 11T3..	0,700
S32U SDUC R/L 11-EX	32	30	15,0	350	50	22	39	DC.. 11T3..	2,050
S40V SDUC R/L 11-EX	40	37	18,5	400	60	27	48	DC.. 11T3..	3,750

Reference Bezeichnung					Nm
S12MSDUC R/L 07-EX	1225	5507	-	-	0.9
S16R SDUC R/L 07-EX	1225	5507	-	-	0.9
S20S SDUC R/L 07-EX	1225	5507	-	-	0.9
S20S SDUC R/L 11-EX	1240	5515	-	-	3.0
S25T SDUC R/L 11-EX	1240	5515	-	-	3.0
S32U SDUC R/L 11-EX	1335	5516	3714	1750	3.0
S40V SDUC R/L 11-EX	1335	5516	3714	1750	3.0

DC.. 55° rhombic positive inserts with 7° clearance. A35
55° rhombische positive Wendeschneidplatten mit 7° Freiwinkel.

Reference / Bez.	l	s	d
DC.. 0702..	7,75	2,38	6,35
DC.. 11T3..	11,60	3,97	9,52

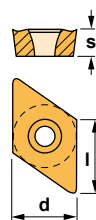

DCGT-AL



DCGT-AP



DCMT



DCMW

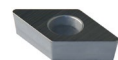



Characteristics:

Backwards multipurpose profiling boring bar equipped with rhombic positive insert (angle 55°).

For boring bars with negative inserts see Ref. PDUN-EX (Page: A192).

Axial 0°
Radial -6°

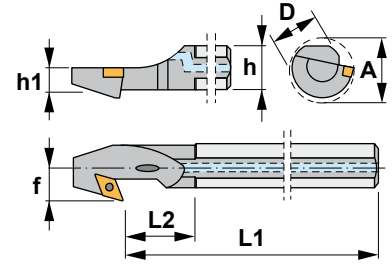

Eigenschaften:

Rückwärts-Multifunktions-Bohrstange zum Profildrehen mit rhombischen positiven Wendeschneidplatten (55° Winkel).

Für Bohrstan gen mit negativen Wendeschneidplatten siehe PDUN-EX (Seite: A192).

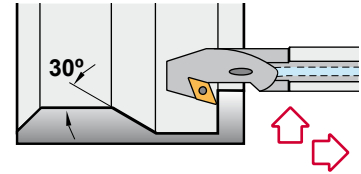

A-SDUC 93°-EX



Reference Bezeichnung	D	h	h1	L1	L2	f	A	Insert size Wendeschneidplatte	Kg
A12K SDUC R/L 07-EX	12	11	5,5	125	25	9	16	DC.. 0702..	0,100
A16M SDUC R/L 07-EX	16	15	7,5	150	30	11	20	DC.. 0702..	0,200
A20Q SDUC R/L 11-EX	20	18	9,0	180	35	13	24	DC.. 11T3..	0,400
A25R SDUC R/L 11-EX	25	23	11,5	200	40	17	31	DC.. 11T3..	0,700

Reference Bezeichnung			Nm
A12K SDUC R/L 07-EX	1225	5507	0.9
A16M SDUC R/L 07-EX	1225	5507	0.9
A20Q SDUC R/L 11-EX	1240	5515	3.0
A25R SDUC R/L 11-EX	1240	5515	3.0

DC.. 55° rhombic positive inserts with 7° clearance. A35
55° rhombische positive Wendeschneidplatten mit 7° Freiwinkel.

Reference / Bez.	l	s	d
DC.. 0702..	7,75	2,38	6,35
DC.. 11T3..	11,60	3,97	9,52

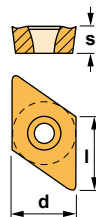

DCGT-AL



DCGT-AP



DCMT



DCMW

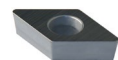



Characteristics:

Multipurpose boring bar equipped with square positive insert.

For boring bars with negative inserts see Ref. MSKN-K (Page: A180) or PSKN (Page: A193).

Axial 0°
Radial -8°

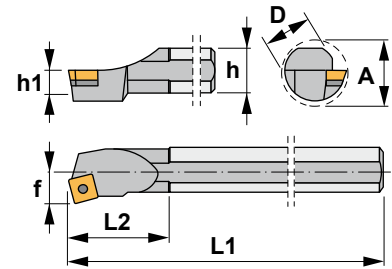

Eigenschaften:

Multifunktions-Bohrstange mit vierkantigen positiven Wendeschneidplatten.

Für Bohrstanen mit negativen Wendeschneidplatten siehe MSKN-K (Seite: A180) oder PSKN (Seite: A193).

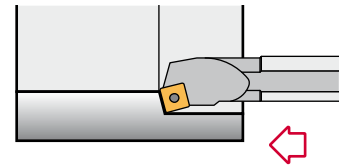

SSKC 75°

Reference Bezeichnung	D	h	h1	L1	L2	f	A	Insert size Wendeschneidplatte	Kg
S16R SSKC R/L 09	16	15	7,5	200	30	11	20	SC.. 09T3..	0,300
S20S SSKC R/L 09	20	18	9,0	250	35	13	24	SC.. 09T3..	0,550
S25T SSKC R/L 09	25	23	11,5	300	40	17	31	SC.. 09T3..	0,700
S32U SSKC R/L 12	32	30	15,0	350	45	22	39	SC.. 1204..	2,050
S40V SSKC R/L 12	40	37	18,5	400	50	27	48	SC.. 1204..	3,750
S50W SSKC R/L 12	50	47	23,5	450	60	35	61	SC.. 1204..	6,500

Reference Bezeichnung					Nm
S16R SSKC R/L 09	1440	5515	-	-	3.0
S20S SSKC R/L 09	1240	5515	-	-	3.0
S25T SSKC R/L 09	1240	5515	-	-	3.0
S32U SSKC R/L 12	1540	5517	3514	1760	3.0
S40V SSKC R/L 12	1540	5517	3514	1760	3.0
S50W SSKC R/L 12	1540	5517	3514	1760	3.0

SC.. Square positive inserts with 7° clearance. A40
Vierkantige positive Wendeschneidplatten mit 7° Freiwinkel.

Reference / Bez.	l	s	d
SC.. 09T3..	9,52	3,97	9,52
SC.. 1204..	12,70	4,76	12,70

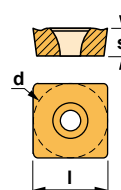

SCGT-AL



SCMT



SCMT-39



SCMW





Characteristics:

Multipurpose boring bar equipped with square positive insert.
For boring bars with negative inserts see Ref. A-PSSN (Page: A195).

Axial 0°
Radial -8°

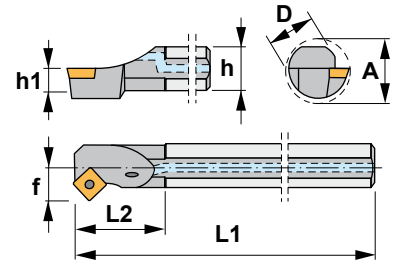

Eigenschaften:

Multifunktions-Bohrstange mit vierkantigen positiven Wendeschneidplatten.
Für Bohrstanen mit negativen Wendeschneidplatten siehe A-PSSN (Seite: A195).

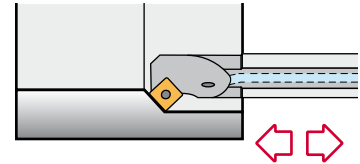

A-SSSC 45°

Reference Bezeichnung	D	h	h1	L1	L2	f	A	Insert size Wendeschneidplatte	
A16M SSSC R/L 09	16	15	7,5	150	30	11	20	SC.. 09T3..	0,300
A20Q SSSC R/L 09	20	18	9,0	180	35	13	24	SC.. 09T3..	0,550
A25R SSSC R/L 09	25	23	11,5	200	40	17	31	SC.. 09T3..	0,700

Reference Bezeichnung			Nm
A16M SSSC R/L 09	1440	5515	3.0
A20Q SSSC R/L 09	1440	5515	3.0
A25R SSSC R/L 09	1240	5515	3.0

SC.. Square positive inserts with 7° clearance. A40
Vierkantige positive Wendeschneidplatten mit 7° Freiwinkel.

Reference / Bez.	l	s	d
SC.. 09T3..	9,52	3,97	9,52

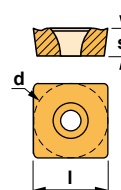

SCGT-AL



SCMT



SCMT-39



SCMW





Characteristics:

Multipurpose boring bar equipped with triangular positive insert.

For boring bars with negative inserts see Ref. MTFN (Page: A181), MTFN-K (Page: A182) or PTFN (Page: A196).

Axial 0°
Radial -6°

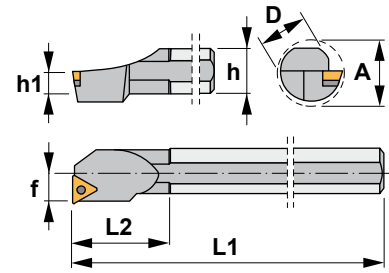

Eigenschaften:



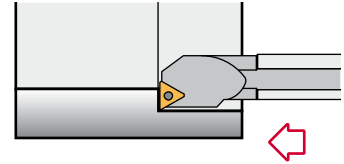

Multifunktions-Bohrstange mit dreikantigen positiven Wendeschneidplatten.

Für Bohrstanen mit negativen Wendeschneidplatten siehe MTFN (Seite: A181), MTFN-K (Seite: A182) oder PTFN (Seite: A196).



STFC 90°

Reference Bezeichnung	D	h	h1	L1	L2	f	A	Insert size Wendeschneidplatte	kg
S10M STFC R/L 09	10	9	4,5	150	22	7	13	TC.. 0902..	0,060
S12M STFC R/L 09	12	11	5,5	150	25	9	16	TC.. 0902..	0,150
S12M STFC R/L 11	12	11	5,5	150	25	9	16	TC.. 1102..	0,150
S12Q STFC R/L 11	12	11	5,5	180	25	9	16	TC.. 1102..	0,050
S16R STFC R/L 11	16	15	7,5	200	30	11	20	TC.. 1102..	0,300
S20S STFC R/L 11	20	18	9,0	250	35	13	24	TC.. 1102..	0,550
S20S STFC R/L 16	20	18	9,0	250	35	13	24	TC.. 16T3..	0,550
S25T STFC R/L 16	25	23	11,5	300	40	17	31	TC.. 16T3..	0,700
S32U STFC R/L 16	32	30	15,0	350	45	22	39	TC.. 16T3..	2,050
S40V STFC R/L 16	40	37	18,5	400	50	27	48	TC.. 16T3..	3,750

Reference Bezeichnung					Nm
S10M STFC R/L 09	1222	5506	-	-	0.6
S12M STFC R/L 09	1222	5506	-	-	0.6
S12M STFC R/L 11	1225	5507	-	-	0.9
S12Q STFC R/L 11	1225	5507	-	-	0.9
S16R STFC R/L 11	1225	5507	-	-	0.9
S20S STFC R/L 11	1225	5507	-	-	0.9
S20S STFC R/L 16	1240	5515	-	-	3.0
S25T STFC R/L 16	1240	5515	-	-	3.0
S32U STFC R/L 16	1335	5516	3414	1750	3.0
S40V STFC R/L 16	1335	5516	3414	1750	3.0

TC.. Triangular positive inserts with 7° clearance.  A44
Dreikantige positive Wendeschneidplatten mit 7° Freiwinkel.

Reference / Bez.	l	s	d
TC.. 0902..	9,62	2,38	5,55
TC.. 1102..	11,00	2,38	6,35
TC.. 16T3..	16,50	3,97	9,52

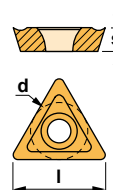

TCGT-AL



TCMT



TCMW

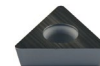



Characteristics:

Multipurpose boring bar equipped with triangular positive insert.

For boring bars with negative inserts see Ref. MTFN (Page: A181), MTFN-K (Page: A182) or A-PTFN (Page: A197).

Axial 0°
Radial -6°

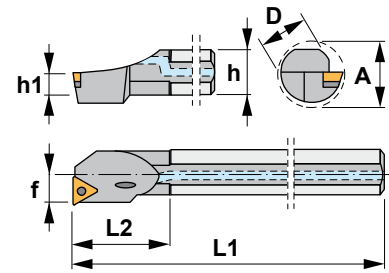

Eigenschaften:

Multifunktions-Bohrstange mit dreikantigen positiven Wendeschneidplatten.

Für Bohrstanen mit negativen Wendeschneidplatten siehe MTFN (Seite: A181), MTFN-K (Seite: A182) oder A-PTFN (Seite: A197).

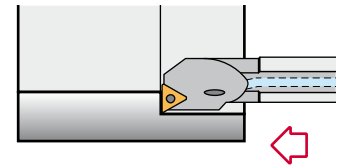

A-STFC 90°

Reference Bezeichnung	D	h	h1	L1	L2	f	A	Insert size Wendeschneidplatte	kg
A10H STFC R/L 09	10	9	4,5	100	20	7	13	TC.. 0902..	0,040
A12K STFC R/L 11	12	11	5,5	125	25	9	16	TC.. 1102..	0,100
A16M STFC R/L 11	16	15	7,5	150	30	11	20	TC.. 1102..	0,200
A20Q STFC R/L 11	20	18	9,0	180	35	13	24	TC.. 1102..	0,400
A25R STFC R/L 16	25	23	11,5	200	40	17	31	TC.. 16T3..	0,700
A32S STFC R/L 16	32	30	15,0	250	45	22	39	TC.. 16T3..	1,400
A40T STFC R/L 16	40	37	18,5	300	50	27	48	TC.. 16T3..	2,650

Reference Bezeichnung					Nm
A10H STFC R/L 09	1222	5506	-	-	0.6
A12K STFC R/L 11	1225	5507	-	-	0.9
A16M STFC R/L 11	1225	5507	-	-	0.9
A20Q STFC R/L 11	1225	5507	-	-	0.9
A25R STFC R/L 16	1240	5515	-	-	3.0
A32S STFC R/L 16	1335	5516	3414	1750	3.0
A40T STFC R/L 16	1335	5516	3414	1750	3.0

TC.. Triangular positive inserts with 7° clearance. A44
Dreikantige positive Wendeschneidplatten mit 7° Freiwinkel.

Reference / Bez.	l	s	d
TC.. 0902..	9,62	2,38	5,55
TC.. 1102..	11,00	2,38	6,35
TC.. 16T3..	16,50	3,97	9,52

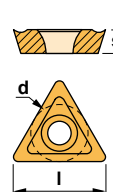

TCGT-AL



TCMT



TCMW

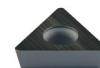



Characteristics:

Set of multipurpose boring bars equipped with triangular positive insert.

For boring bars with negative inserts see Ref. A-PTFN (Page: A197).

Axial 0°
Radial -6°

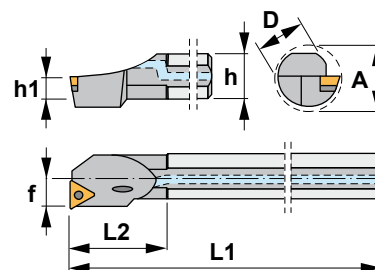

Eigenschaften:

Multifunktions-Bohrstangen-Satz mit dreikantigen positiven Wendeschneidplatten. Für Bohrstangen mit negativen Wendeschneidplatten siehe A-PTFN (Seite: A197).

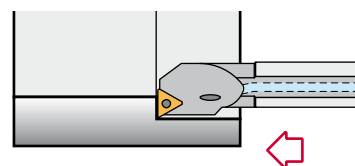

SET STFC 90°

Reference Bezeichnung	D	d	L1	L2	f	A	h	Insert size Wendeschneidplatte	
A0810J STFC R/L 11	10	8	110	32	7	12,5	9	TC.. 1102..	0,350
A1012K STFC R/L 11	12	10	125	38	9	15,5	11	TC.. 1102..	
A1216M STFC R/L 11	16	12	150	50	11	19,5	15	TC.. 1102..	

Reference Bezeichnung			Nm
A0810J STFC R/L 11	1425	5507	0.9
A1012K STFC R/L 11	1225	5507	0.9
A1216M STFC R/L 11	1225	5507	0.9

TC.. Triangular positive inserts with 7° clearance. A44
Dreikantige positive Wendeschneidplatten mit 7° Freiwinkel.

Reference / Bez.	l	s	d
TC.. 1102..	11,00	2,38	6,35

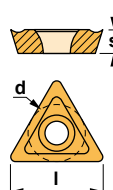

TCGT-AL



TCMT



TCMW



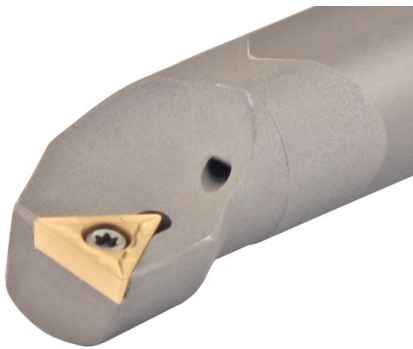

Characteristics:

Carbide boring bar equipped with triangular positive insert.
Range starting at Ø12 mm and minimum bore diameter of 17 mm.

Axial 0°
Radial -6°

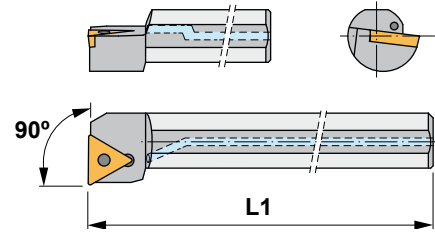

Eigenschaften:

Hartmetall-Bohrstange mit dreikantigen positiven Wendeschneidplatten.
Das Sortiment fängt ab Ø12 mm an, für eine 17 mm Mindestbohrung.

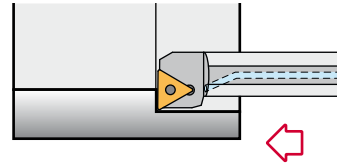

E-STFC 90°



Reference Bezeichnung	L1 Total length (mm) L1 Gesamtlänge (mm)	Ø min. (mm)	Insert size Wendeschneidplatte	
E12Q STFCL 11	180	17	TC.. 1102..	0,270
E12Q STFCR 11	180	17	TC.. 1102..	0,270
E16R STFCL 11	200	21	TC.. 1102..	0,510
E16R STFCR 11	200	21	TC.. 1102..	0,510
E20S STFCL 11	250	25	TC.. 1102..	1,000
E20S STFCR 11	250	25	TC.. 1102..	1,000

Reference Bezeichnung			Nm
E12Q STFCL 11	1225	5507	0.9
E12Q STFCR 11	1225	5507	0.9
E16R STFCL 11	1225	5507	0.9
E16R STFCR 11	1225	5507	0.9
E20S STFCL 11	1225	5507	0.9
E20S STFCR 11	1225	5507	0.9

TC.. Triangular positive inserts with 7° clearance. A44
Dreikantige positive Wendeschneidplatten mit 7° Freiwinkel.

Reference / Bez.	l	s	d
TC.. 1102..	11,00	2,38	6,35

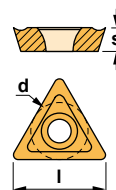

TCGT-AL



TCMT



TCMW





Characteristics:

Multipurpose boring bar equipped with triangular positive insert.
For boring bars with negative inserts see Ref. MTUN (Page: A183).

Axial 0°
Radial -4°

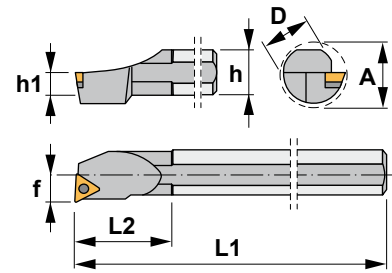

Eigenschaften:

Multifunktions-Bohrstange mit dreikantigen positiven Wendeschneidplatten.
Für Bohrstanen mit negativen Wendeschneidplatten siehe MTUN (Seite: A183).

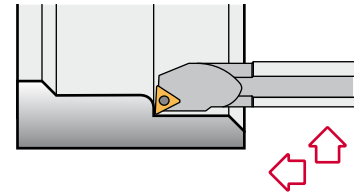

STUC 93°

Reference Bezeichnung	D	h	h1	L1	L2	f	A	Insert size Wendeschneidplatte	Kg
S12M STUC R/L 11	12	11	5,5	150	25	9	16	TC.. 1102..	0,150
S16R STUC R/L 16	16	15	7,5	200	30	11	20	TC.. 16T3..	0,300
S20S STUC R/L 16	20	18	9,0	250	35	13	24	TC.. 16T3..	0,550
S25T STUC R/L 16	25	23	11,5	300	40	17	31	TC.. 16T3..	0,700
S32U STUC R/L 16	32	30	15,0	350	45	22	39	TC.. 16T3..	2,050

Reference Bezeichnung					Nm
S12M STUC R/L 11	1225	5507	-	-	0.9
S16R STUC R/L 16	1240	5515	-	-	3.0
S20S STUC R/L 16	1240	5515	-	-	3.0
S25T STUC R/L 16	1240	5515	-	-	3.0
S32U STUC R/L 16	1335	5516	3414	1750	3.0

TC.. <small>Triangular positive inserts with 7° clearance. Dreikantige positive Wendeschneidplatten mit 7° Freiwinkel. A44</small>						TCGT-AL	TCMT
Reference / Bez.	l	s	d				
TC.. 1102..	11,00	2,38	6,35				
TC.. 16T3..	16,50	3,97	9,52				



Characteristics:

Multipurpose profiling boring bar equipped with rhombic positive insert (angle 35°). For general applications, roughing, semi-finishing and finishing.

Axial 0°
Radial -6°

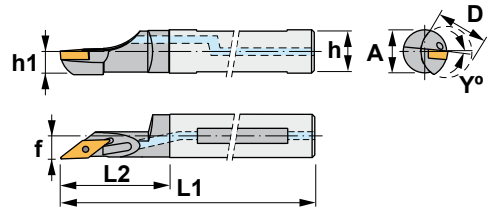

Eigenschaften:

Multifunktions-Bohrstange zum Profildrehen mit rhombischen positiven Wendschneidplatten (35° Winkel).

Für allgemeine Anwendungen, Schruppen, Vorschlichten und Schlichten.

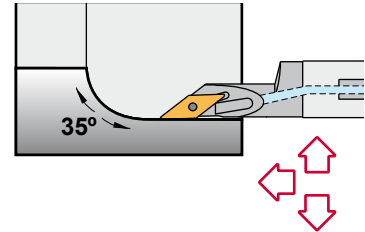

A-SVJC 93°

Reference Bezeichnung	D	h	h1	L1	L2	f	A	Y°	Insert size Wendschneidplatte	kg
A16M SVJC R/L 11	16	15	7,5	150	30	2	22	22	VC.. 1103..	0,190
A20Q SVJC R/L 11	20	18	9,0	180	35	2	25	25	VC.. 1103..	0,350
A25R SVJC R/L 16	25	23	11,5	200	40	2	28	28	VC.. 1604..	0,590

Reference Bezeichnung			Nm
A16M SVJC R/L 11	1225	5507	0.9
A20Q SVJC R/L 11	1225	5507	0.9
A25R SVJC R/L 16	1240	5515	3.0

VC..

35° rhombic positive inserts with 7° clearance. A48
Rhombische positive WSP (35° Winkel) mit Freiwinkel 7°.

Reference / Bez.	l	s	d
VC.. 1103..	11,00	3,18	6,35
VC.. 1604..	16,50	4,76	9,52

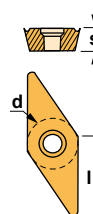

VCGT-AL



VCGT-AP



VCMT





Application of A-SVJC 93° Anwendung von A-SVJC 93°

Application range / Anwendungsbereich

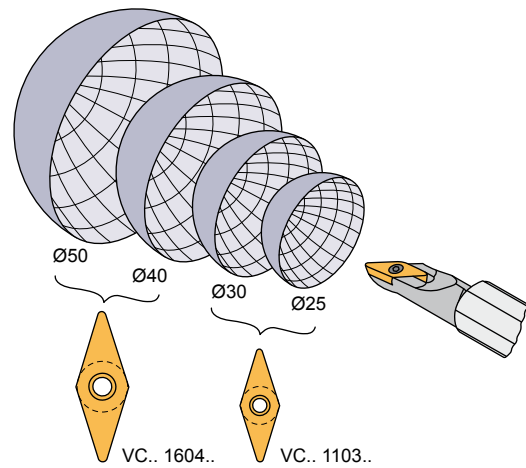
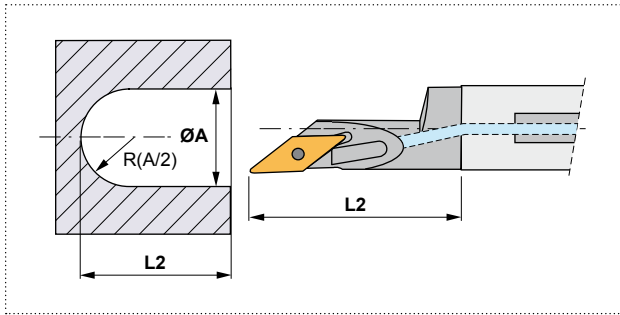

Machining method / Bearbeitungsmethode

Case with no existing hole / Ohne vorgebohrte Bohrung

Spherical machining Kugelförmige Bearbeitung

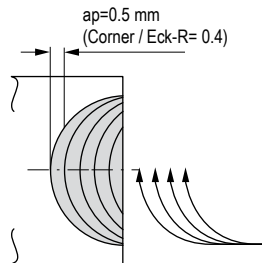

Internal facing Innen-Plandrehen

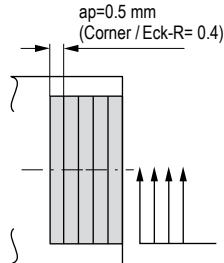

*Note: Feed rate shall be under 0.05 mm/rev at internal facing.
*Bemerkung: Vorschub muß bei Innen-Plandrehen unter 0.05 mm/U sein.

Finishing / Schlichten

Spherical machining Kugelförmige Bearbeitung

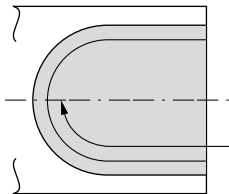

Internal facing Innen-Plandrehen

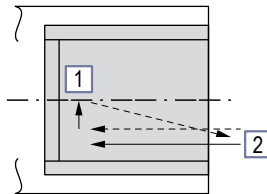

*Machining process / *Bearbeitungsvorgang
1 Finish the internal face first / Zuerst Bohrungsgrund schlichten.
2 Next, finish the internal diameter / Anschließend Bohrungsdurchmesser schlichten.

Case with drilled hole / Mit vorgebohrte Bohrung

Drilled hole / Vorgebohrte Bohrung

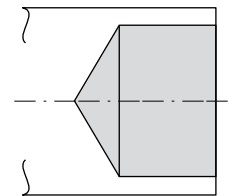

Spherical machining / Kugelförmige Bearbeitung

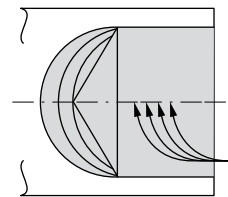

Internal facing / Innen-Plandrehen

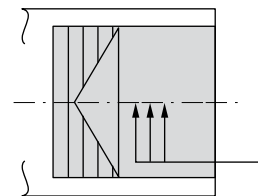

*Note: Feed rate shall be under 0.05 mm/rev at internal facing.
*Bemerkung: Vorschub muß bei Innen-Plandrehen unter 0.05 mm/U sein.

Caution / Vorsicht

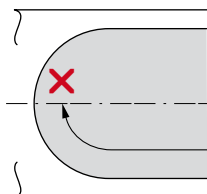

When machining past the center of the workpiece, insert breakage may occur.
Bei Bearbeitung über die Mitte des Werkstücks hinaus kann die Wendschneidplatte brechen.

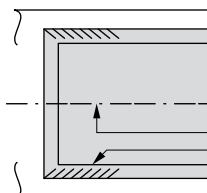

Machining of this kind is possible, but the oblique part may be scratched by chips.
Eine solche Bearbeitung ist zwar möglich, jedoch kann Spanschlag die Oberfläche aufrauen.

Poor finish
Schlechte Oberfläche

Fix the insert edge at the center of the workpiece.
Kante der Wendschneidplatte auf die Werkstückmitte setzen.

Adjust the machining program of radius smaller by corner-R(r_c) value.
Bearbeitungsprogramm auf Kurvenradius abzüglich Eckradiuswert (r_c) einstellen.

For internal profiling, a_p should be less than the value of corner-R(r_c).
Zum Innenprofilieren sollte a_p kleiner sein als der Eckradius(r_c).

Burrs may occur, if a_p is bigger than corner-R.
Wenn a_p größer als der Eckradius ist, kann dies zu Gratbildung führen.



Characteristics:

Multipurpose profiling boring bar equipped with rhombic positive insert (angle 35°).

For general applications, roughing, semi-finishing and finishing.

Axial 0°
Radial -6°

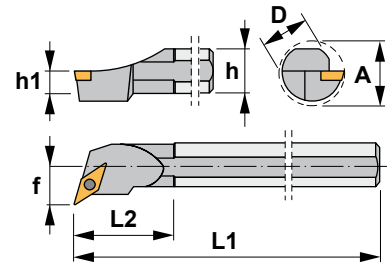

Eigenschaften:

Multifunktions-Bohrstange zum Profildrehen mit rhombischen positiven Wendeschneidplatten (35° Winkel).

Für allgemeine Anwendungen, Schruppen, Vorschlichten und Schlichten.

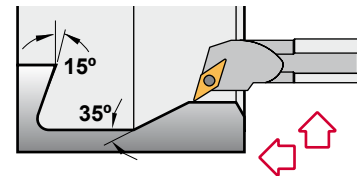

SVQC 107°30'

Reference Bezeichnung	D	h	h1	L1	L2	f	A	Insert size Wendeschneidplatte	kg
S16R SVQC R/L 11	16	15	7,5	200	30	11	20	VC.. 1103..	0,300
S20S SVQC R/L 11	20	18	9,0	250	35	13	24	VC.. 1103..	0,550
S16R SVQC R/L 13	16	15	7,5	200	30	13	22	VC.. 1303..	0,300
S20S SVQC R/L 13	20	18	9,0	250	35	13	24	VC.. 1303..	0,550
S25T SVQC R/L 16	25	23	11,5	300	40	17	31	VC.. 1604..	0,700

Reference Bezeichnung					Nm
S16R SVQC R/L 11	1225	5507	-	-	0.9
S20S SVQC R/L 11	1225	5507	-	-	0.9
S16R SVQC R/L 13	1230	5508	-	-	1.2
S20S SVQC R/L 13	1230	5508	-	-	1.2
S25T SVQC R/L 16	1335	5516	3718	1750	3.0

VC..

35° rhombic positive inserts with 7° clearance. A48
Rhombische positive WSP (35° Winkel) mit Freiwinkel 7°.

Reference / Bez.	l	s	d
VC.. 1103..	11,00	3,18	6,35
VC.. 1303..	13,00	3,18	7,94
VC.. 1604..	16,50	4,76	9,52

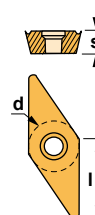

VC GT-AL



VC GT-AP



VC MT





Characteristics:

Multipurpose profiling boring bar equipped with rhombic positive insert (angle 35°).
For general applications, roughing, semi-finishing and finishing.

Axial 0°
Radial -6°

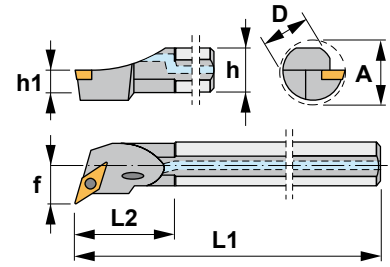

Eigenschaften:

Multifunktions-Bohrstange zum Profildrehen mit rhombischen positiven Wendeschneidplatten (35° Winkel).

Für allgemeine Anwendungen, Schruppen, Vorschlichten und Schlichten.

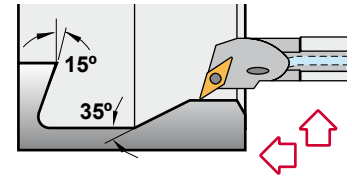

A-SVQC 107°30'

Reference Bezeichnung	D	h	h1	L1	L2	f	A	Insert size Wendeschneidplatte	
A16M SVQC R/L 11	16	15	7,5	150	30	11	20	VC.. 1103..	0,200
A20Q SVQC R/L 11	20	18	9,0	180	35	13	24	VC.. 1103..	0,400
A25R SVQC R/L 16	25	23	11,5	200	40	17	31	VC.. 1604..	0,700
A32S SVQC R/L 16	32	30	15,0	250	45	22	39	VC.. 1604..	1,400
A40T SVQC R/L 16	40	37	18,5	300	50	27	48	VC.. 1604..	2,650

Reference Bezeichnung					Nm
A16M SVQC R/L 11	1225	5507	-	-	0.9
A20Q SVQC R/L 11	1225	5507	-	-	0.9
A25R SVQC R/L 16	1335	5516	3718	1750	3.0
A32S SVQC R/L 16	1335	5516	3718	1750	3.0
A40T SVQC R/L 16	1335	5516	3718	1750	3.0

VC.. 35° rhombic positive inserts with 7° clearance. Rhombische positive WSP (35° Winkel) mit Freiwinkel 7°. A48

Reference / Bez.	l	s	d
VC.. 1103..	11,00	3,18	6,35
VC.. 1604..	16,50	4,76	9,52

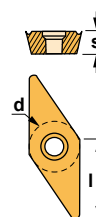

VCGT-AL



VCGT-AP



VCMT



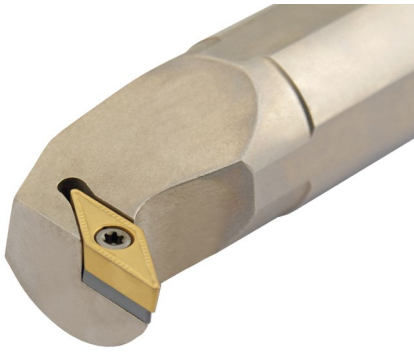

Characteristics:

Multipurpose profiling boring bar equipped with rhombic positive insert (angle 35°). For boring bars with negative inserts see Ref. MVUN-K (Page: A184).

Axial 0°
Radial -5°

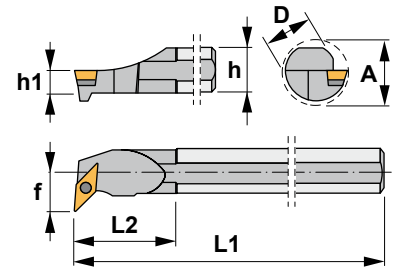

Eigenschaften:

Multifunktions-Bohrstange zum Profildrehen mit rhombischen positiven Wendeschneidplatten (35° Winkel). Für Bohrstan- gen mit negativen Wendeschneidplatten siehe MVUN-K (Seite: A184).

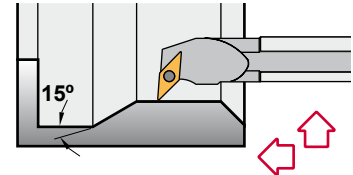

SVUB 93°

Reference Bezeichnung	D	h	h1	L1	L2	f	A	Insert size Wendeschneidplatte	kg
S25T SVUB R/L 16	25	23	11,5	300	40	17	31	VBMT 1604..	0,700
S32U SVUB R/L 16	32	30	15,0	350	45	22	39	VBMT 1604..	2,050
S40V SVUB R/L 16	40	37	18,5	400	50	27	48	VBMT 1604..	3,750

Reference Bezeichnung					Nm
S25T SVUB R/L 16	1335	5516	3718	1750	3.0
S32U SVUB R/L 16	1335	5516	3718	1750	3.0
S40V SVUB R/L 16	1335	5516	3718	1750	3.0

VBMT

35° rhombic positive insert with 5° clearance. A48
35° rhombische positive Wendeschneidplatte mit 5° Freiwinkel. A48

Reference / Bez.

VBMT 1604..

l

16,50

s

4,76

d

9,52

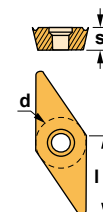

VBMT





Characteristics:

Multipurpose profiling boring bar equipped with rhombic positive insert (angle 35°). For boring bars with negative inserts see Ref. MVUN-K (Page: A184).

Axial 0°
Radial -5°

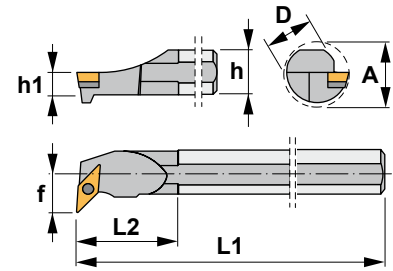

Eigenschaften:

Multifunktions-Bohrstange zum Profildrehen mit rhombischen positiven Wendeschneidplatten (35° Winkel). Für Bohrstanen mit negativen Wendeschneidplatten siehe MVUN-K (Seite: A184).

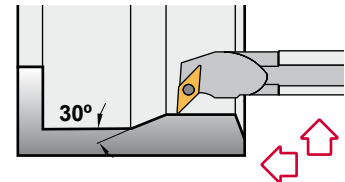

SVUC 93°

Reference Bezeichnung	D	h	h1	L1	L2	f	A	Insert size Wendeschneidplatte	kg
S16R SVUC R/L 11	16	15	7,5	200	30	11	20	VC.. 1103..	0,300
S20S SVUC R/L 11	20	18	9,0	250	35	13	24	VC.. 1103..	0,550
S25T SVUC R/L 16	25	23	11,5	300	40	17	31	VC.. 1604..	0,700
S32U SVUC R/L 16	32	30	15,0	350	45	22	39	VC.. 1604..	2,050
S40V SVUC R/L 16	40	37	18,5	400	50	27	48	VC.. 1604..	3,750

Reference Bezeichnung					Nm
S16R SVUC R/L 11	1225	5507	-	-	0.9
S20S SVUC R/L 11	1225	5507	-	-	0.9
S25T SVUC R/L 16	1335	5516	3718	1750	3.0
S32U SVUC R/L 16	1335	5516	3718	1750	3.0
S40V SVUC R/L 16	1335	5516	3718	1750	3.0

VC..

35° rhombic positive inserts with 7° clearance. A48
Rhombische positive WSP (35° Winkel) mit Freiwinkel 7°.

Reference / Bez.	l	s	d
VC.. 1103..	11,00	3,18	6,35
VC.. 1604..	16,50	4,76	9,52

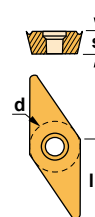

VCGT-AL



VCGT-AP



VCMT





Characteristics:

Multipurpose profiling boring bar equipped with rhombic positive insert (angle 35°). For boring bars with negative inserts see Ref. MVUN-K (Page: A184).

Axial 0°
Radial -5°

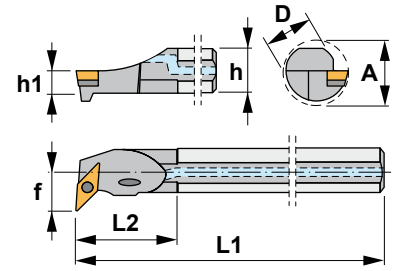

Eigenschaften:

Multifunktions-Bohrstange zum Profildrehen mit rhombischen positiven Wendeschneidplatten (35° Winkel). Für Bohrstanen mit negativen Wendeschneidplatten siehe MVUN-K (Seite: A184).

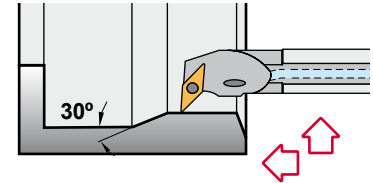

A-SVUC 93°

Reference Bezeichnung	D	h	h1	L1	L2	f	A	Insert size Wendeschneidplatte	kg
A16M SVUC R/L 11	16	15	7,5	150	30	11	20	VC.. 1103..	0,200
A20Q SVUC R/L 11	20	18	9,0	180	35	13	24	VC.. 1103..	0,400
A25R SVUC R/L 16	25	23	11,5	200	40	17	31	VC.. 1604..	0,700
A32S SVUC R/L 16	32	30	15,0	250	45	22	39	VC.. 1604..	1,400
A40T SVUC R/L 16	40	37	18,5	300	50	27	48	VC.. 1604..	2,650

Reference Bezeichnung					Nm
A16M SVUC R/L 11	1225	5507	-	-	0.9
A20Q SVUC R/L 11	1225	5507	-	-	0.9
A25R SVUC R/L 16	1335	5516	3718	1750	3.0
A32S SVUC R/L 16	1335	5516	3718	1750	3.0
A40T SVUC R/L 16	1335	5516	3718	1750	3.0

VC..

35° rhombic positive inserts with 7° clearance. A48
Rhombische positive WSP (35° Winkel) mit Freiwinkel 7°.

Reference / Bez.	l	s	d
VC.. 1103..	11,00	3,18	6,35
VC.. 1604..	16,50	4,76	9,52

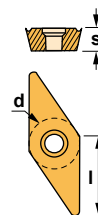

VCGT-AL



VCGT-AP



VCMT







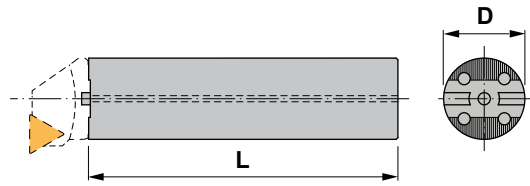

Characteristics:
Anti-vibration shank with internal coolant.
Max. cutting depth: 7 x Diameter









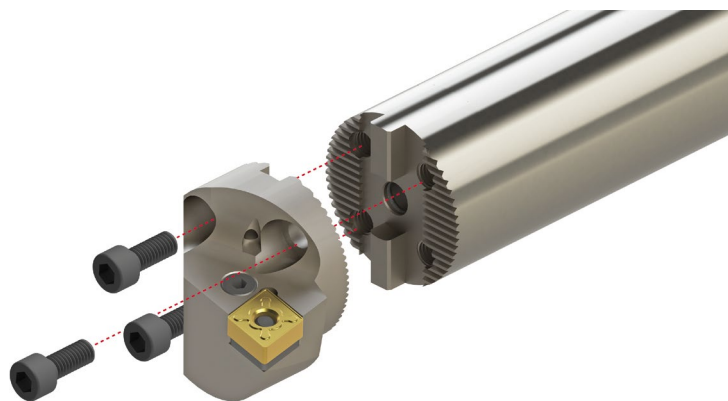

Eigenschaften:
Schwingungsgedämpfter Schaft mit Innenkühlung.
Maximale Schnitttiefe: 7 x Durchmesser



Reference Bezeichnung		D	L	Thread Gewinde	
J25/300	25	25	300	1/4 GAS	1,200
J32/350	32	32	350	3/8 GAS	2,200
J40/400	40	40	400	1/2 GAS	4,000
J50/550	50	50	550	1/2 GAS	8,500
J60/650	60	60	650	3/4 GAS	14,400
J80/1000	60	80	1000	3/4 GAS	39,500
J100/1200	60	100	1200	3/4 GAS	74,000

Reference Bezeichnung			Nm
J25/300	1924	5025	2.0
J32/350	1925	5003	3.0
J40/400	1926	5004	3.5
J50/550	1928	5005	4.0
J60/650	1928	5005	4.0
J80/1000	1928	5005	4.0
J100/1200	1928	5005	4.0



MTUN 93°-N 	PCLN 95°-N 	PDUN 93°-N 	PWLN 95°-N 
SCLC 95°-N 	SDUC 93°-N 	STFC 90°-N 	SXFN 90°-N 

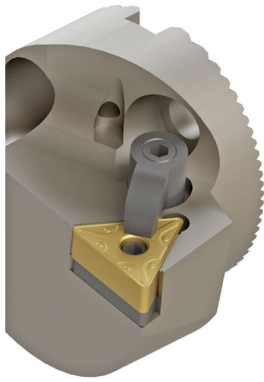

Characteristics:

Internal turning and profiling boring head equipped with triangular negative double-sided insert.

For general applications, roughing, semi-finishing and finishing.

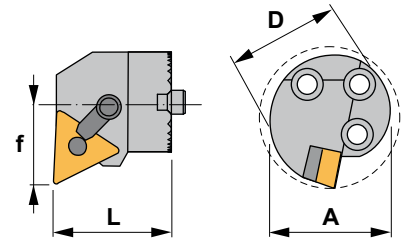

Eigenschaften:

Bohrkopf zum Innen- und Profildrehen mit doppelseitigen dreikantigen negativen Wendeschneidplatten.

Für allgemeine Anwendungen, Schruppen, Vorschlichten und Schlichten.

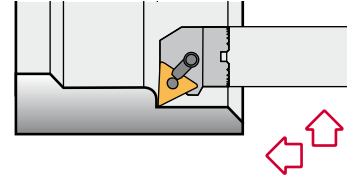

MTUN 93°-N

Reference Bezeichnung	D	L	f	A	Insert size Wendeschneidplatte	kg
A32X MTUN R/L 16-N	32	30	22	40	TNM.. 1604..	0,150
A40X MTUN R/L 16-N	40	30	27	50	TNM.. 1604..	0,300
A50X MTUN R/L 16-N	50	30	35	63	TNM.. 1604..	0,650
A50X MTUN R/L 22-N	50	40	35	63	TNM.. 2204..	0,650
A60X MTUN R/L 22-N	60	40	43	80	TNM.. 2204..	0,850

Reference Bezeichnung									Nm ¹	Nm ²
A32X MTUN R/L 16-N	2613	-	5003	ITSN-322	1086	1665	-	5002	3.0	1.4
A40X MTUN R/L 16-N	2613	-	5003	ITSN-322	1086	1665	-	5002	3.0	1.4
A50X MTUN R/L 16-N	2613	-	5003	ITSN-322	1086	1665	-	5002	3.0	1.4
A50X MTUN R/L 22-N	-	2024	5005	ITSN-433	1394	-	1661	-	4.0	-
A60X MTUN R/L 22-N	-	2024	5005	ITSN-433	1394	-	1661	-	4.0	-

TNM..

Triangular negative inserts.
Dreikantige negative WSP. A45-46

Reference / Bez.	l	s	d
TNM.. 1604..	16,50	4,76	9,52
TNM.. 2204..	22,00	4,76	12,70

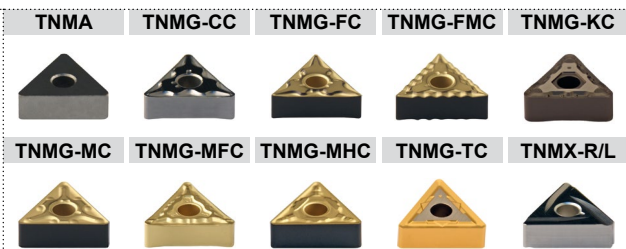
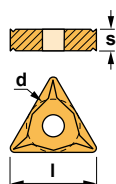

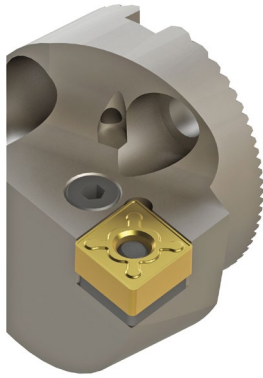

Characteristics:

Boring head for internal turning applications equipped with rhombic negative inserts (angle 80°). For low powered machines and small pieces choose boring bars Ref. A-SCLC (Page: A208).

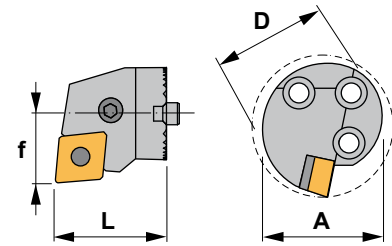

Eigenschaften:

Bohrkopf zum Innendreien mit rhombischen negativen Wendeschneidplatten (80° Winkel).

Für Niederleistungsmaschinen und kleine Werkstücke, wählen Sie Bohrstanen A-SCLC (Seite: A208).

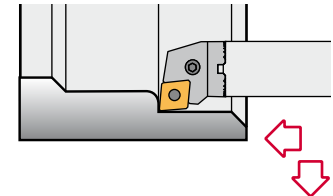

PCLN 95°-N

Reference Bezeichnung	D	L	f	A	Insert size Wendeschneidplatte	kg
A25X PCLN R/L 12-N	25	25	17	32	CN.. 1204..	0,050
A32X PCLN R/L 12-N	32	30	22	40	CN.. 1204..	0,150
A40X PCLN R/L 12-N	40	30	27	50	CN.. 1204..	0,300
A50X PCLN R/L 12-N	50	30	35	63	CN.. 1204..	0,600
A50X PCLN R/L 16-N	50	40	35	63	CN.. 1606..	0,600
A60X PCLN R/L 16-N	60	40	43	80	CN.. 1606..	0,800

Reference Bezeichnung							Nm
A25X PCLN R/L 12-N	8212	1626	5025	-	-	-	2.0
A32X PCLN R/L 12-N	8312	1648	5003	3612	4112	0012	3.0
A40X PCLN R/L 12-N	8012	1608	5003	3612	4112	0012	3.0
A50X PCLN R/L 12-N	8012	1608	5003	3612	4112	0012	3.0
A50X PCLN R/L 16-N	8016	1618	5003	3616	4115	0015	3.0
A60X PCLN R/L 16-N	8016	1618	5003	3616	4115	0015	3.0

CN..

80° rhombic negative inserts. A32-34
80° rhombische negative WSP.

Reference / Bez.	l	s	d
CN.. 1204..	12,90	4,76	12,70
CN.. 1606..	16,10	6,35	15,88

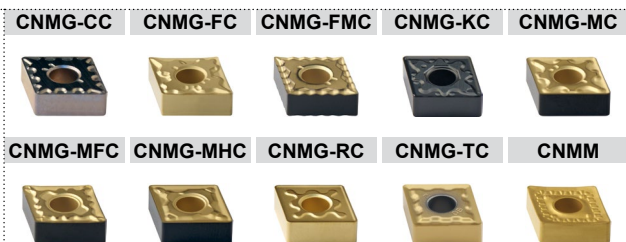
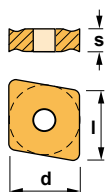



Characteristics:

Boring head for internal turning and profiling applications equipped with rhombic negative inserts (angle 55°). For low powered machines and small pieces choose boring bars Ref. A-SDUC (Page: A218).

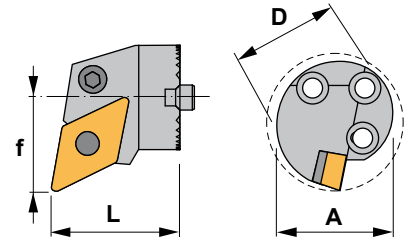

Eigenschaften:

Bohrkopf zum Innen- und Profildrehen mit rhombischen negativen Wendeschneidplatten (55° Winkel).

Für Niederleistungsmaschinen und kleine Werkstücke, wählen Sie Bohrstanen A-SDUC (Seite: A218).

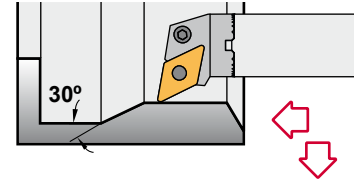

PDUN 93°-N

Reference Bezeichnung	D	L	f	A	Insert size Wendeschneidplatte	KG
A32X PDUN R/L 15-N	32	30	22	40	DN.. 1506..	0,150
A40X PDUN R/L 15-N	40	30	27	50	DN.. 1506..	0,300
A50X PDUN R/L 15-N	50	40	35	63	DN.. 1506..	0,600
A60X PDUN R/L 15-N	60	40	43	80	DN.. 1506..	0,800

Reference Bezeichnung								Nm
A32X PDUN R/L 15-N	8415	1648	5003	3715	4112	0012	3725 4135	3.0
A40X PDUN R/L 15-N	8415	1638	5003	3715	4112	0012	3725 4135	3.0
A50X PDUN R/L 15-N	8415	1638	5003	3715	4112	0012	3725 4135	3.0
A60X PDUN R/L 15-N	8415	1638	5003	3715	4112	0012	3725 4135	3.0

For DNM.. 1504.. inserts
Für Wendeschneidplatten DNM.. 1504..

DN.. 55° rhombic negative inserts. A36-37
55° rhombische negative Wendeschneidplatten.

Reference / Bez.	l	s	d
DN.. 1504..	15,50	4,76	12,70
DN.. 1506..	15,50	6,35	12,70

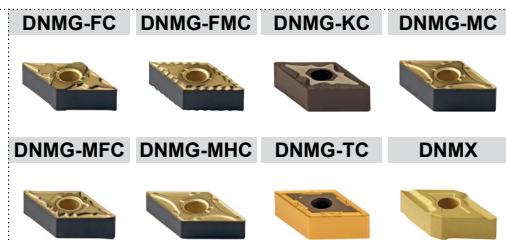
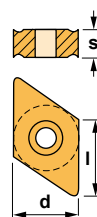



Characteristics:

Boring head for internal turning applications equipped with trigon negative inserts (angle 80°). For general applications, roughing, semi-finishing and finishing.

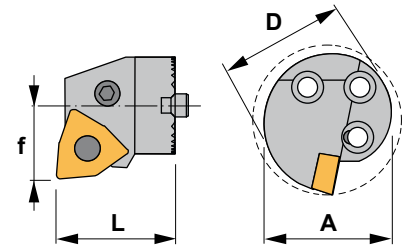

Eigenschaften:

Bohrkopf zum Innendrehen mit negativen Trigon Wendeschneidplatten (80° Winkel). Für allgemeine Anwendungen, Schruppen, Vorschlichten und Schlichten.

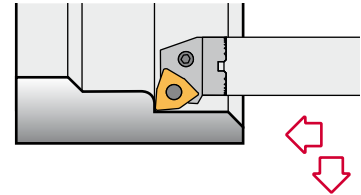

PWLN 95°-N

Reference Bezeichnung	D	L	f	A	Insert size Wendeschneidplatte	kg
A32X PWLN R/L 08-N	32	30	22	40	WNM.. 0804..	0,150
A40X PWLN R/L 08-N	40	30	27	50	WNM.. 0804..	0,300
A50X PWLN R/L 08-N	50	40	35	63	WNM.. 0804..	0,600
A60X PWLN R/L 08-N	60	40	43	80	WNM.. 0804..	0,800

Reference Bezeichnung							Nm
A32X PWLN R/L 08-N	8312	1648	5003	3008	4112	0012	3.0
A40X PWLN R/L 08-N	8012	1608	5003	3008	4112	0012	3.0
A50X PWLN R/L 08-N	8012	1608	5003	3008	4112	0012	3.0
A60X PWLN R/L 08-N	8012	1608	5003	3008	4112	0012	3.0

WNMG 80° trigon negative inserts. A50-51
80° trigon negative Wendeschneidplatten.

Reference / Bez.	l	s	d
WNMG 0804..	8,14	4,76	12,70

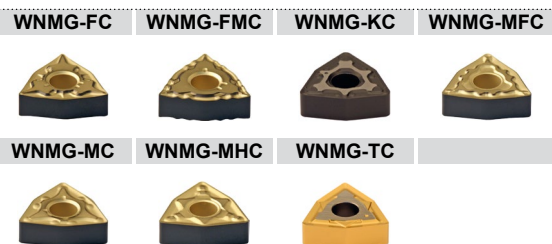
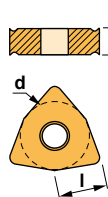

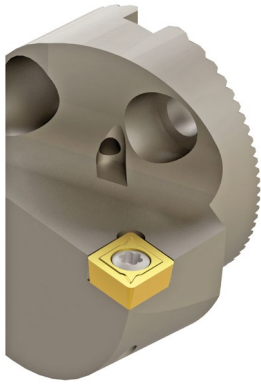

Characteristics:

Multipurpose boring head equipped with rhombic positive insert (angle 80°).

For boring bars with negative inserts see Ref. A-PCLN (Page: A189).

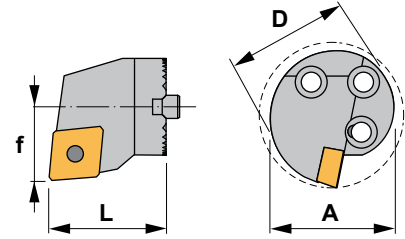

Eigenschaften:

Multifunktions-Bohrkopf mit rhombischen positiven Wendeschneidplatten (80° Winkel).

Für Bohrstangen mit negativen Wendeschneidplatten, siehe A-PCLN (Seite: A189).

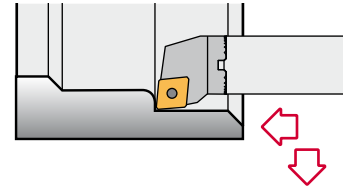

SCLC 95°-N

Reference Bezeichnung	D	L	f	A	Insert size Wendeschneidplatte	
A25X SCLC R/L 09-N	25	25	17	32	CC.. 09T3..	0,070
A32X SCLC R/L 12-N	32	30	22	40	CC.. 1204..	0,150
A40X SCLC R/L 12-N	40	30	27	50	CC.. 1204..	0,250
A50X SCLC R/L 12-N	50	40	35	63	CC.. 1204..	0,650
A60X SCLC R/L 12-N	60	40	43	80	CC.. 1204..	0,850

Reference Bezeichnung					Nm
A25X SCLC R/L 09-N	1440	5515	-	-	3.0
A32X SCLC R/L 12-N	1540	5517	3614	1760	3.0
A40X SCLC R/L 12-N	1540	5517	3614	1760	3.0
A50X SCLC R/L 12-N	1540	5517	3614	1760	3.0
A60X SCLC R/L 12-N	1540	5517	3614	1760	3.0

CC.. 80° rhombic positive inserts with 7° clearance. A30-31
80° rhombische positive Wendeschneidplatten mit 7° Freiwinkel.

Reference / Bez.	l	s	d
CC.. 09T3..	9,65	3,97	9,52
CC.. 1204..	12,90	4,76	12,70

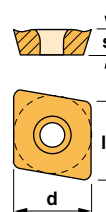

CCGT-AL



CCGT-AP



CCMT



CCMW





Characteristics:

Multipurpose profiling boring head equipped with rhombic positive insert (angle 55°).

For boring bars with negative inserts see Ref. A-PDUN (Page: A191).

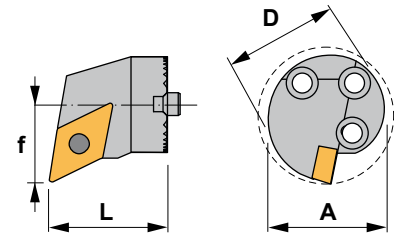

Eigenschaften:

Multifunktions-Bohrkopf zum Profildrehen mit rhombischen positiven Wendeschneidplatten (55° Winkel).

Für Bohrstangen mit negativen Wendeschneidplatten siehe A-PDUN (Seite: A191).

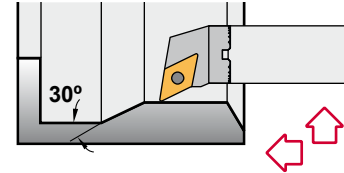

SDUC 93°-N

Reference Bezeichnung	D	L	f	A	Insert size Wendeschneidplatte	KG
A25X SDUC R/L 11-N	25	25	17	32	DC.. 11T3..	0,070
A32X SDUC R/L 11-N	32	30	22	40	DC.. 11T3..	0,150
A40X SDUC R/L 11-N	40	30	27	50	DC.. 11T3..	0,250
A50X SDUC R/L 11-N	50	40	35	63	DC.. 11T3..	0,650
A60X SDUC R/L 11-N	60	40	43	80	DC.. 11T3..	0,850

Reference Bezeichnung					Nm
A25X SDUC R/L 11-N	1240	5515	-	-	3.0
A32X SDUC R/L 11-N	1335	5516	3714	1750	3.0
A40X SDUC R/L 11-N	1335	5516	3714	1750	3.0
A50X SDUC R/L 11-N	1335	5516	3714	1750	3.0
A60X SDUC R/L 11-N	1335	5516	3714	1750	3.0

DC.. 55° rhombic positive inserts with 7° clearance. A35
55° rhombische positive Wendeschneidplatten mit 7° Freiwinkel.

Reference / Bez.	l	s	d
DC.. 11T3..	11,60	3,97	9,52

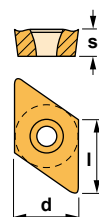

DCGT-AL 	DCGT-AP
DCMT 	DCMW



Characteristics:
Multipurpose boring head equipped with triangular positive insert.
For general applications, roughing, semi-finishing and finishing.

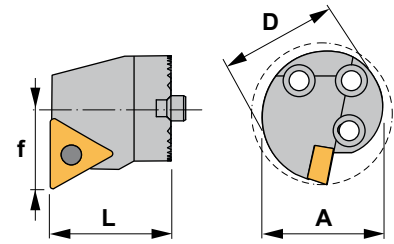

Eigenschaften:
Multifunktions-Bohrkopf mit dreikantigen positiven Wendeschneidplatten.
Für allgemeine Anwendungen, Schruppen, Vorschlichten und Schlichten.

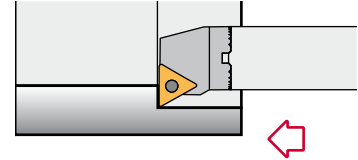

STFC 90°-N



Reference Bezeichnung	D	L	f	A	Insert size Wendeschneidplatte	Kg
A25X STFC R/L 16-N	25	25	17	32	TC.. 16T3..	0,070
A32X STFC R/L 16-N	32	30	22	40	TC.. 16T3..	0,150
A40X STFC R/L 16-N	40	30	27	50	TC.. 16T3..	0,250
A50X STFC R/L 16-N	50	40	35	63	TC.. 16T3..	0,650
A60X STFC R/L 16-N	60	40	43	80	TC.. 16T3..	0,850

Reference Bezeichnung					Nm
A25X STFC R/L 16-N	1240	5515	-	-	3.0
A32X STFC R/L 16-N	1335	5516	3414	1750	3.0
A40X STFC R/L 16-N	1335	5516	3414	1750	3.0
A50X STFC R/L 16-N	1335	5516	3414	1750	3.0
A60X STFC R/L 16-N	1335	5516	3414	1750	3.0

TC.. Triangular positive inserts with 7° clearance. A44
Dreikantige positive Wendeschneidplatten mit 7° Freiwinkel.

Reference / Bez.	l	s	d
TC.. 16T3..	16,50	3,97	9,52

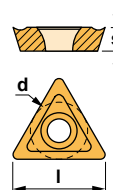

TCGT-AL



TCMT



TCMW

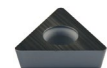

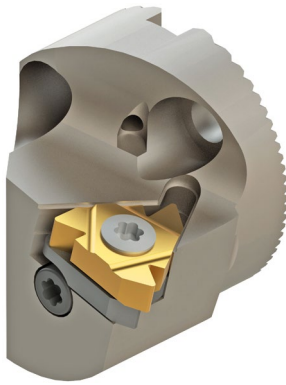

Characteristics:
Boring head for internal threading equipped with triangular negative insert.

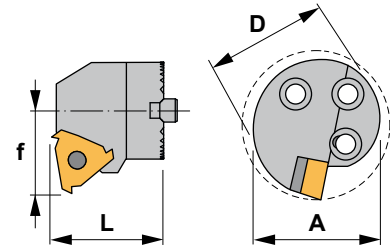

Eigenschaften:
Multifunktions-Bohrkopf zum Gewindedrehen mit dreikantigen negativen Wendschneidplatten.

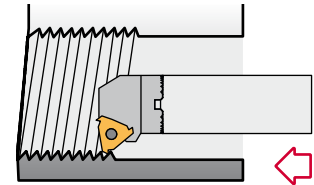

SXFN 90°-N

Reference Bezeichnung	D	L	f	A	Insert size Wendschneidplatte	Kg
A25X SXFN R/L 16-N	25	25	16,30	32	16 NR/L..	0,070
A32X SXFN R/L 16-N	32	30	19,60	40	16 NR/L..	0,150
A32X SXFN R/L 22-N	32	32	21,50	40	22 NR/L..	0,150
A40X SXFN R/L 22-N	40	32	25,80	50	22 NR/L..	0,250
A50X SXFN R/L 22-N	50	40	31,40	63	22 NR/L..	0,650
A60X SXFN R/L 22-N	60	40	36,40	80	22 NR/L..	0,850

Reference Bezeichnung						Nm
A25X SXFN R/L 16-N	SA3	5510	YE3	YI3	SY3	2.0
A32X SXFN R/L 16-N	SA3	5510	YE3	YI3	SY3	2.0
A32X SXFN R/L 22-N	SA4	5520	YE4	YI4	SY4	4.0
A40X SXFN R/L 22-N	SA4	5520	YE4	YI4	SY4	4.0
A50X SXFN R/L 22-N	SA4	5520	YE4	YI4	SY4	4.0
A60X SXFN R/L 22-N	SA4	5520	YE4	YI4	SY4	4.0

N R/L

Triangular negative inserts for internal threading.
Dreikantige negative WSP zum Innen-Gewindedrehen. C04, C06-07, C09-10

Reference / Bez.

l

d

16 NR/L..

16,00

9,52

22 NR/L..

22,00

12,70

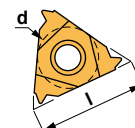

N R/L



N R/L TD





Characteristics:

Adaptor for anti-vibration shank with internal coolant.

To adapt the new boring heads to the old model of anti-vibration shanks.

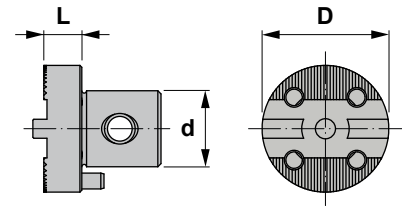



Eigenschaften:

Adapter für schwingungsgedämpfte Schäfte mit Innenkühlung.





Um die neue Bohrköpfe an das alte Modell der schwingungsgedämpften Schäfte zu montieren.

J..-A..  

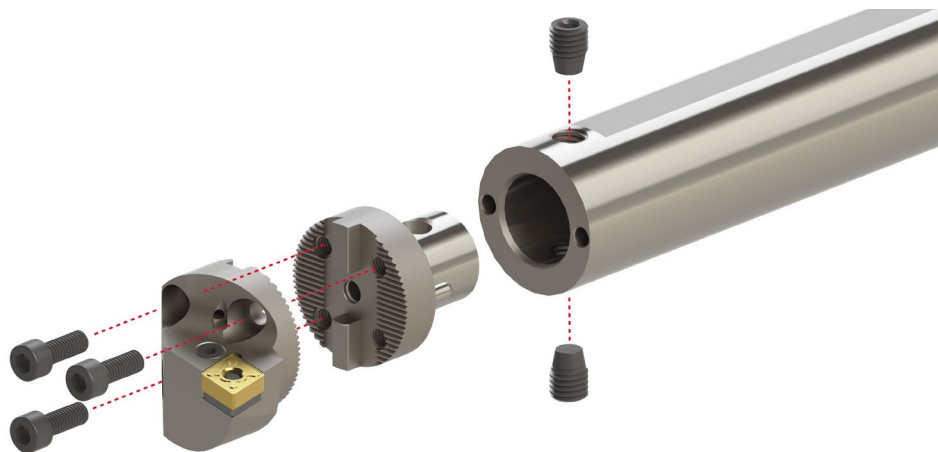
Reference Bezeichnung	D	L	d	
J25-A25	25	10	15	0,060
J32-A32	32	10	20	0,100
J40-A40	40	12	24	0,180
J50-A50	54	16	28	0,350
J60-A60	60	16	28	0,460

Reference Bezeichnung			Nm
J25-A25	1924	5025	2.0
J32-A32	1925	5003	3.0
J40-A40	1926	5004	3.5
J50-A50	1928	5005	4.0
J60-A60	1928	5005	4.0



MTUN 93°-N 	PCLN 95°-N 	PDUN 93°-N 	PWLN 95°-N 
SCLC 95°-N 	SDUC 93°-N 	STFC 90°-N 	SXFN 90°-N 



Nominal cutting speed and feed values for boring bars

Material	P	HB	Condition	Cutting speed m/min.					Specific cutting force Kc 0,4	
				PM25	PM40	NC25	TN15	TN20		TN30
				0.3-0.6-1.2		0.1-0.3	0.1-0.4-0.8	0.1-0.4-0.8		0.2-0.5-1.2
Unalloyed steel	125	C=0.15%		150 115 80		350 280	480 345 250	440 300 205	330 230 110	1900
	150	C=0.35%		145 105 70		270 230	440 315 230	400 275 190	300 210 150	2100
	200	C=0.60%		115 90 65		240 190	385 275 200	350 240 165	260 185 130	2250
Low alloyed steel	180	Annealed		90 70 45		300 260	380 265 195	320 220 170	200 140 100	2100
	275	Hardened		65 45 30		220 140	260 180 130	215 150 115	140 100 70	2600
	300	Hardened		60 40 25		230 180	240 165 120	200 135 105	125 90 60	2700
	350	Hardened		50 35 20		220 140	210 145 105	170 120 90	110 75 55	2850
High alloyed steel	200	Annealed		80 60 45		200 160	350 230 170	280 185 135	175 115 80	2600
	325	Hardened		40 25 20		200 160	170 110	120 80 60	85 55 40	3900
Stainless steel	200	Martensitic / ferritic		110 95 75		270 130	295 240 190	275 210 165	225 180 145	2300
Steel castings	180	Unalloyed		60 50 35		300 260	260 185 145	230 160 120	135 105 75	2000
	200	Low alloyed		50 45 30		230 180	230 160 120	190 125 85	120 90 60	2500
	225	High alloyed		40 30 20		220 140	190 130 95	170 115 80	95 70 55	2700

Material	M	HB	Condition	Cutting speed m/min.					Specific cutting force Kc 0,4			
				PM25	NC25	TN15	TN20	TN30		TS15	TS20	
				0.1-0.3	0.1-0.3	0.1-0.4-0.8		0.2-0.4-0.6		0.2-0.4-0.6	0.1-0.3	
Stainless steel annealed	180	Austenitic Ni > 8%, Cr 12-25% austenitic/ferritic, austenitic/ferritic, low S		240 200	180 150 120			190 160 130	190 160 130	240 200	120 180	2450
				160 130	180 150 120			190 160 120	190 160 130	160 130	130 220	
				160 130	180 150 120			140 110	160 130 100	160 130	120 180	

Material	K	HB	Condition	Cutting speed m/min.					Specific cutting force Kc 0,4	
				KM15	NC25	TN15	TN20	TK15		ZR10
				0.2-0.5-1.0	0.2-0.5	0.2-0.5-1.0		0.2-0.5-1.0		0.2-0.5-1.0
Hardened steel	350	Hardened steel		27 16 10		175 145 100		180 150 110		4500
	250	Manganese steel 12%		65 40 16		120 85 50		120 90 60		3600
Malleable cast iron	130	Ferritic		105 75 45		225 150 90		250 180 100		1100
	230	Pearlitic		80 60 30		155 95 55		160 100 60		1100
Cast iron	180	Low tensile strength		135 95 60	300 200	165 110 70		180 120 80		1100
	260	High tensile strength		95 65 40	250 180	120 90 55		140 105 60		1500
Nodular SG iron	160	Ferritic		115 80 45	250 180			220 180 100		1100
	250	Pearlitic		80 50 30	180 120			150 100 50		1800
Chilled cast iron	400			17 11				17 11		3000

Material	N	HB	Condition	Cutting speed m/min.					Specific cutting force Kc 0,4	
				KM15	TK15	NC25	TN15	TN20		ZR10
				0.2-0.5-1.0	0.2-0.5-1.0	0.2-0.5	0.2-0.5-1.0			0.2-0.5-1.0
Aluminium alloys	60	Non heat treatable		1750 1280 800					1750 1280 800	500
	100	Heat treatable		510 370 250					510 370 250	800
Aluminium alloys (cast)	75	Non heat treatable		460 285 175					460 285 175	750
	90	Heat treatable		300 180 110					300 180 110	900
Bronze-brass alloys	110	Lead alloys, Pb>1%		610 430 295					610 430 295	700
	90	Brass and bronze		310 250 195					310 250 195	750
	100	Inc. electrolytic copper		225 160 115					225 160 115	1750
Other materials		Hard plastics		380 240					380 240	
		Fibre		190 120					190 120	
		Hard rubber		225 160					225 160	

Material	S	HB	Condition	Cutting speed m/min.					Specific cutting force Kc 0,4	
				KM15	NC25	TN15	TS15	TS20		ZR10
				0.2-0.5-1.0	0.2-0.5	0.2-0.5-1.0				0.2-0.5-1.0
Heat-resistant alloys			Fe-base					80 120		
			Nickel or cobalt base					60 100		
			Nickel or cobalt base					35 90		
			Nickel or cobalt base					30 50		
Titanium alloys			Titanium					70 120		

Nennschnittgeschwindigkeit und Vorschub-Werte für Bohrstangen

Materialien	P	HB	Beschaffenheit	Schnittgeschwindigkeit m/min.						Spezifische Schnittkraft Kc 0,4
				PM25	PM40	NC25	TN15	TN20	TN30	
				0.3-0.6-1.2		0.1-0.3	0.1-0.4-0.8	0.1-0.4-0.8	0.2-0.5-1.2	
Unlegierter Stahl		125 150 200	C=0.15% C=0.35% C=0.60%	150 115 80 145 105 70 115 90 65		350 280 270 230 240 190	480 345 250 440 315 230 385 275 200	440 300 205 400 275 190 350 240 165	330 230 110 300 210 150 260 185 130	1900 2100 2250
Niedriglegierter Stahl		180 275 300 350	Geglüht Vergütet Vergütet Vergütet	90 70 45 65 45 30 60 40 25 50 35 20		300 260 220 140 230 180 220 140	380 265 195 260 180 130 240 165 120 210 145 105	320 220 170 215 150 115 200 135 105 170 120 90	200 140 100 140 100 70 125 90 60 110 75 55	2100 2600 2700 2850
Hochlegierter Stahl		200 325	Geglüht Vergütet	80 60 45 40 25 20		200 160 200 160	350 230 170 170 110	280 185 135 120 80 60	175 115 80 85 55 40	2600 3900
Rostfreier Stahl		200	Martensitisch/ Ferritisch	110 95 75		270 130	295 240 190	275 210 165	225 180 145	2300
Stahlguß		180 200 225	Unlegiert Niedriglegiert Hochlegiert	60 50 35 50 45 30 40 30 20		300 260 230 180 220 140	260 185 145 230 160 120 190 130 95	230 160 120 190 125 85 170 115 80	135 105 75 120 90 60 95 70 55	2000 2500 2700

Materialien	M	HB	Beschaffenheit	Schnittgeschwindigkeit m/min.						Spezifische Schnittkraft Kc 0,4			
				PM25	NC25	TN15	TN20	TN30	TN35		TS15	TS20	
				0.1-0.3	0.1-0.3	0.1-0.4-0.8		0.2-0.4-0.6	0.2-0.4-0.6		0.1-0.3		
Rostfreier Stahl, geglüht		180	Austenitisch Ni > 8%, Cr 12-25% Austenitisch/ Ferritisch, Austenitisch/ Ferritisch, niedriger S-Anteil		240 200 160 130 160 130	180 150 120 180 150 120 180 150 120			190 160 130 190 160 130 140 110	190 160 130 190 160 130 160 130	240 200 160 130 160 130	120 180 130 220 120 180	2450

Materialien	K	HB	Beschaffenheit	Schnittgeschwindigkeit m/min.						Spezifische Schnittkraft Kc 0,4	
				KM15	NC25	TN15	TN20	TK15	ZR10		
				0.2-0.5-1.0	0.2-0.5	0.2-0.5-1.0		0.2-0.5-1.0	0.2-0.5-1.0		
Gehärteter Stahl		350 250	Vergüteter Stahl Mangan-Stahl 12%	27 16 10 65 40 16		175 145 100 120 85 50			180 150 110 120 90 60		4500 3600
Temperguß		130 230	Ferritisch Perlitisch	105 75 45 80 60 30		225 150 90 155 95 55			250 180 100 160 100 60		1100 1100
Guß		180 260	Niedrige Zugfestigkeit Hohe Zugfestigkeit	135 95 60 95 65 40	300 200 250 180	165 110 70 120 90 55			180 120 80 140 105 60		1100 1500
SG-Kugelgraphitguß		160 250	Ferritisch Perlitisch	115 80 45 80 50 30	250 180 180 120				220 180 100 150 100 50		1100 1800
Kaltverfestigender Guß		400		17 11					17 11		3000

Materialien	N	HB	Beschaffenheit	Schnittgeschwindigkeit m/min.						Spezifische Schnittkraft Kc 0,4	
				KM15	TK15	NC25	TN15	TN20	ZR10		
				0.2-0.5-1.0	0.2-0.5-1.0	0.2-0.5	0.2-0.5-1.0		0.2-0.5-1.0		
Aluminium-Legierungen		60 100	Nicht wärmebehandelbar Wärmebehandelbar	1750 1280 800 510 370 250						1750 1280 800 510 370 250	500 800
Gegossene Aluminium-Legierungen		75 90	Nicht wärmebehandelbar Wärmebehandelbar	460 285 175 300 180 110						460 285 175 300 180 110	750 900
Bronze- und Messinglegierungen		110 90 100	Bleilegierungen, Pb>1% Messing, Bronze Elektrolytkupfer	610 430 295 310 250 195 225 160 115						610 430 295 310 250 195 225 160 115	700 750 1750
Andere Materialien			Hartkunststoff Faser Hartgummi	380 240 190 120 225 160						380 240 190 120 225 160	

Materialien	S	HB	Beschaffenheit	Schnittgeschwindigkeit m/min.						Spezifische Schnittkraft Kc 0,4	
				KM15	NC25	TN15	TS15	TS20	ZR10		
				0.2-0.5-1.0	0.2-0.5	0.2-0.5-1.0			0.2-0.5-1.0		
Wärmefeste Legierungen			Fe-Basis Nickel- und Kobalthaltig Nickel- und Kobalthaltig Nickel- und Kobalthaltig						80 120 60 100 35 90 30 50		
Titan-Legierungen			Titan						70 120		

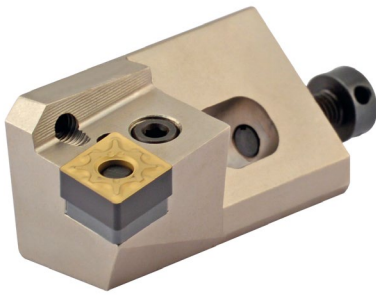

CARTRIDGES KURZKLEMMHALTER

Technical information Technische Auskünfte	A250-251
Code system (ISO) Kodifizierung (ISO)	A252
Applications index Anwendungen	A253
Lever lock cartridges Kurzklemmhalter mit Kniehebel	A254-258
Top clamp cartridges Kurzklemmhalter mit oberer Pratze	A259-262
Center screw cartridges Kurzklemmhalter mit Zentralschraube	A263-267

**Assembly dimensions
Einbauabmessungen**

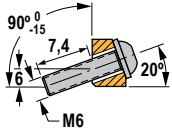
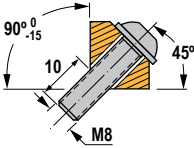
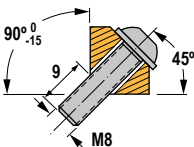
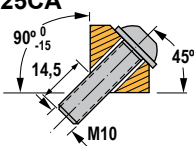
Cartridge size Abmessungen des Kurzklemmhalters	Cartridge code Bezeichnung	Dimensions / Abmessungen, mm											
		K _r	b _c	h ₁	h ₂₁	l ₈	l ₂₁	l ₂₂	l ₂₃	D _{m1} min	D _{m2} min	R max	ch max
12CA 	PSKN R/L 12CA-12	75°	14,0	12	16,0	35,0	36,5	56,5	52,0	50	-	5,0	0,4
	PSSN R/L 12CA-12	45°	14,0	12	16,0	27,0	32,0	52,0	40,5	50	-	5,0	0,4
	PTFN R/L 12CA-16	90°	14,0	12	16,0	35,0	33,0	53,0	49,0	50	-	5,0	0,4
	PTGN R/L 12CA-16	90°	14,0	12	16,0	35,0	30,5	50,5	45,0	50	75	5,0	0,4
	PTSN R/L 12CA-16	45°	14,0	12	16,0	27,0	33,5	53,5	49,0	50	-	5,0	0,4
	PTTN R/L 12CA-16	60°	14,0	12	16,0	35,0	30,5	50,5	49,0	50	75	5,0	0,4
	PTWN R/L 12CA-16	60°	14,0	12	16,0	27,0	30,5	50,5	46,0	50	-	5,0	0,4
16CA 	PCFN R/L 16CA-12	90°	17,5	16	20,5	38,0	34,0	59,0	55,0	55	-	6,0	0,4
	PCLN R/L 16CA-12	95°	17,5	16	20,5	38,0	32,0	57,0	54,0	55	75	6,0	0,4
	PSKN R/L 16CA-12	75°	17,5	16	20,5	38,0	38,5	63,5	55,0	55	-	6,0	0,4
	PSRN R/L 16CA-12	75°	19,0	16	20,5	38,0	27,5	52,5	51,0	60	75	6,0	0,4
	PSSN R/L 16CA-12	45°	17,0	16	20,5	28,0	31,5	56,5	41,0	55	75	6,0	0,4
	PTFN R/L 16CA-16	90°	17,5	16	21,5	38,0	35,0	60,0	54,0	55	-	6,0	0,4
	PTGN R/L 16CA-16	90°	18,5	16	20,5	38,0	32,0	57,0	55,0	60	75	6,0	0,4
	PTSN R/L 16CA-16	45°	17,0	16	20,5	28,0	32,5	57,5	54,0	55	-	6,0	0,4
	PTTN R/L 16CA-16	60°	15,3	16	20,5	25,0	36,0	61,0	54,0	55	75	6,0	0,4
PTWN R/L 16CA-16	60°	19,5	16	21,0	28,0	36,0	61,0	54,0	55	75	6,0	0,4	
20CA 	PCFN R/L 20CA-12	90°	16,0	20	26,0	40,0	-	-	61,0	-	-	6,0	0,4
	PCLN R/L 20CA-12	95°	15,6	20	25,0	40,0	-	-	61,0	-	-	6,0	0,4
	PSKN R/L 20CA-12	75°	16,5	20	26,0	40,0	41,0	71,0	64,0	-	-	6,0	0,4
	PSRN R/L 20CA-12	75°	21,5	20	25,0	40,0	33,0	63,0	68,0	-	90	6,0	0,4
	PSSN R/L 20CA-12	45°	18,2	20	27,0	30,0	35,0	65,0	60,0	70	-	6,0	0,4
	PTFN R/L 20CA-22	90°	15,5	20	27,0	40,0	37,0	67,0	61,0	70	-	6,0	0,4
	PTGN R/L 20CA-22	90°	16,0	20	25,0	40,0	32,5	62,5	56,7	70	90	6,0	0,4
	PTSN R/L 20CA-22	45°	15,5	20	25,0	30,0	37,0	67,0	62,0	70	-	6,0	0,4
	PTTN R/L 20CA-22	60°	18,1	20	26,0	22,5	-	-	61,5	-	-	6,0	0,4
PTWN R/L 20CA-22	60°	17,4	20	26,0	29,6	-	-	61,0	-	-	6,0	0,4	
25CA 	PCFN R/L 25CA-16	90°	24,0	25	32,9	50,0	-	-	88,5	-	-	8,0	0,7
	PCLN R/L 25CA-16	95°	24,6	25	32,9	50,0	41,5	91,5	90,6	100	115	8,0	0,7
	PSKN R/L 25CA-15	75°	24,0	25	31,9	49,0	-	-	93,5	-	-	8,0	0,7
	PTFN R/L 25CA-22	90°	21,5	25	32,9	50,0	-	-	88,5	-	-	8,0	0,7
	PTSN R/L 25CA-22	45°	23,7	25	32,9	39,0	-	-	72,8	-	-	8,0	0,7

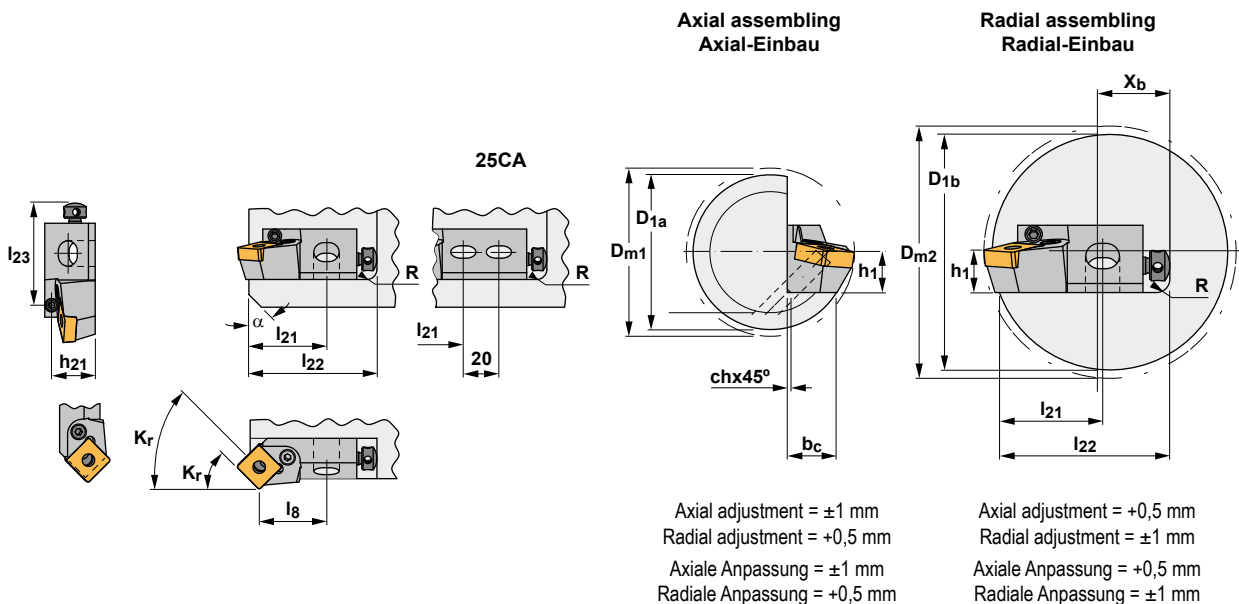



**Assembly dimensions
Einbaubmessungen**

Cartridge size Abmessungen des Kurzklemmhalters	Cartridge code Bezeichnung	Dimensions / Abmessungen, mm											
		K _r	b _c	h ₁	h ₂₁	l ₈	l ₂₁	l ₂₂	l ₂₃	D _{m1} min	D _{m2} min	R max	ch max
06CA 	SCFC R/L 06CA-06	90°	7,2	6	2,1	13	12,0	24,0	18,0	20	31	2,5	0,3
	SCLC R/L 06CA-06	95°	7,8	6	2,1	13	12,0	24,0	18,0	20	31	2,5	0,3
08CA 	SCFC R/L 08CA-06	90°	6,0	8	2,2	15	13,5	30,5	24,2	25	38	1,5	0,3
	SCLC R/L 08CA-06	95°	5,8	8	2,9	15	13,5	30,5	24,2	25	38	2,5	0,3
	STFC R/L 08CA-09	90°	6,5	8	2,2	15	13,5	30,5	24,2	25	38	2,5	0,3
	STFC R/L 08CA-11	90°	6,8	8	2,9	15	13,5	30,5	24,2	25	38	2,5	0,3
	STSC R/L 08CA-09	45°	6,0	8	2,5	11	13,5	30,5	21,5	25	38	2,5	0,3
	STSC R/L 08CA-11	45°	5,8	8	2,9	10	13,5	30,5	21,5	25	38	2,5	0,3
	STTC R/L 08CA-09	60°	6,0	8	2,5	15	12,2	29,2	21,5	25	37	2,5	0,3
	STTC R/L 08CA-11	60°	6,6	8	2,9	9,6	13,5	30,5	22,4	25	38	2,5	0,3
	STWC R/L 08CA-11	60°	5,8	8	2,9	9,8	13,5	30,5	23,9	25	38	2,5	0,3
10CA 	SCFC R/L 10CA-09	90°	9,0	10	3,0	30	27,5	47,5	39,5	40	55	2,5	0,3
	SCLC R/L 10CA-09	95°	10,0	10	3,0	30	28,5	48,5	39,0	40	55	4,0	0,4
	SSKC R/L 10CA-09	75°	9,8	10	3,0	30	28,5	48,5	39,0	40	55	4,0	0,4
	SSSC R/L 10CA-09	45°	10,0	10	3,0	30	28,5	48,5	37,5	40	55	4,0	0,4
	STFC R/L 10CA-11	90°	10,6	10	3,0	30	27,5	47,5	39,5	40	55	4,0	0,4
	STGC R/L 10CA-11	90°	9,0	10	3,0	30	26,5	46,5	39,5	40	55	4,0	0,4
	STSC R/L 10CA-11	45°	9,0	10	3,0	24	29,0	49,0	39,5	40	55	4,0	0,4
	STTC R/L 10CA-11	60°	9,0	10	3,0	30	28,0	48,0	39,5	40	55	4,0	0,4
	STWC R/L 10CA-11	60°	10,6	10	3,0	24	27,0	47,0	39,5	40	55	4,0	0,4
12CA 	SCFC R/L 12CA-12	90°	14,0	12	5,0	35	28,5	48,5	40,0	50	75	5,0	0,4
	SCLC R/L 12CA-12	95°	15,8	12	5,0	35	28,5	48,5	40,0	50	75	5,0	0,4
	SSKC R/L 12CA-12	75°	13,5	12	5,0	35	36,0	56,0	40,0	50	75	5,0	0,4
	SSSC R/L 12CA-12	45°	13,0	12	5,0	27	31,5	51,5	39,0	50	75	5,0	0,4
	STFC R/L 12CA-16	90°	13,0	12	5,0	35	33,2	53,2	40,0	50	75	5,0	0,4
	STGC R/L 12CA-16	90°	15,0	12	5,0	35	31,0	51,0	40,0	50	75	5,0	0,4
	STSC R/L 12CA-16	45°	13,0	12	5,0	27	35,0	55,0	43,0	50	75	5,0	0,4
	STTC R/L 12CA-16	60°	13,0	12	5,0	35	33,0	53,0	40,0	50	75	5,0	0,4
	STWC R/L 12CA-16	60°	13,0	12	5,0	27	32,0	52,0	40,0	50	75	5,0	0,4
16CA 	SSKC R/L 16CA-12	75°	16,5	16	5,0	38	34,0	60,0	49,0	55	-	6,0	0,4
	SSSC R/L 16CA-12	45°		16	5,0	28	36,0	61,0	42,0	55	75	6,0	0,4
	STFC R/L 16CA-16	90°	17,0	16	5,0	38	36,0	61,0	52,0	55	-	5,0	0,4
	STGC R/L 16CA-16	90°	18,5	16	5,0	38	32,0	57,0	48,0	60	75	6,0	0,4
	STSC R/L 16CA-16	45°	16,5	16	5,0	28	35,5	60,5	48,0	55	-	6,0	0,4
	STTC R/L 16CA-16	60°	17,5	16	5,0	38	35,5	60,5	48,0	60	75	6,0	0,4
STWC R/L 16CA-16	60°	16,5	16	5,0	28	32,5	57,5	46,0	55	-	6,0	0,4	

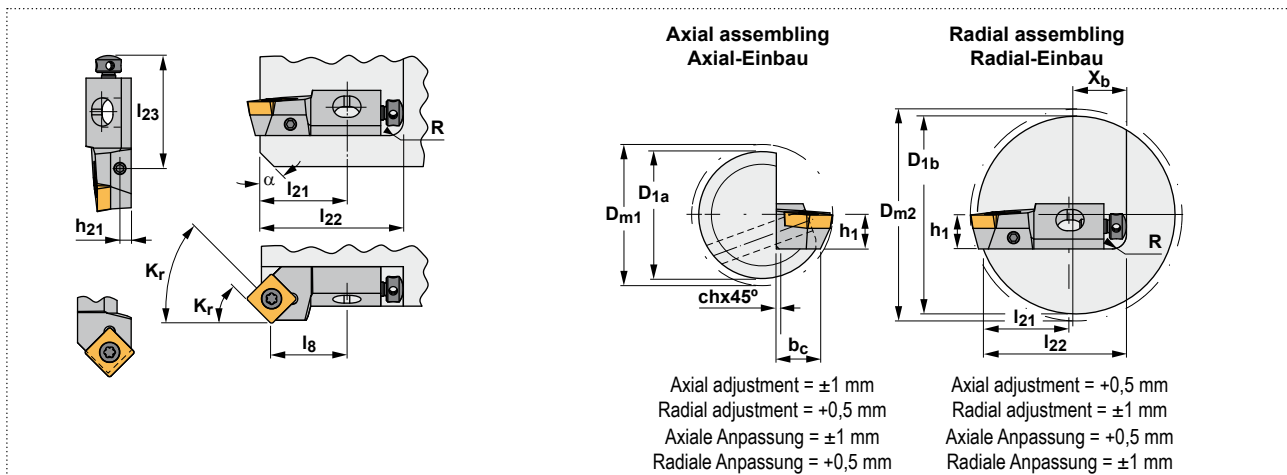

Code system / Kodifizierung (ISO)

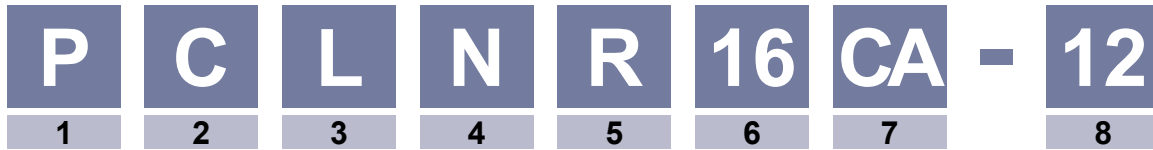

1 Clamping method of insert Klemmsystem

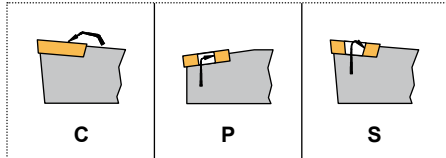

2 Insert shape Wendeschneidplatten-Form

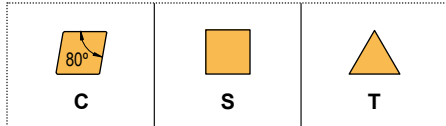

3 Holder style Einstellwinkel

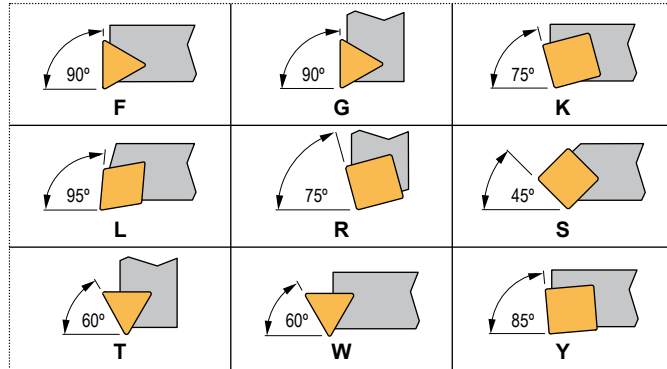

4 Clearance angle of insert Wendeschneidplatten-Freiwinkel

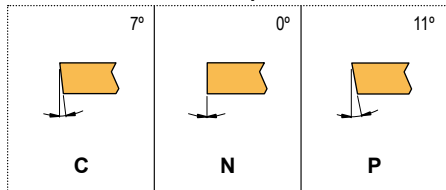

5 Hand Bearbeitungsrichtung

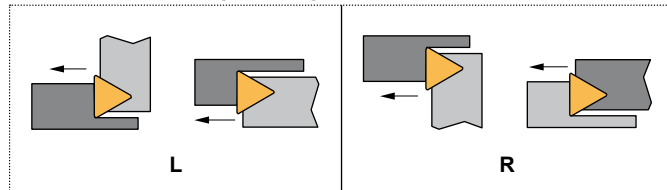

6 Cutting edge height Schneidkantenhöhe

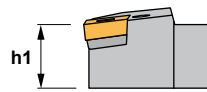

h1		
6	8	10
12	16	20
25		

7 Cartridge code Kurzklemmhalter Kode

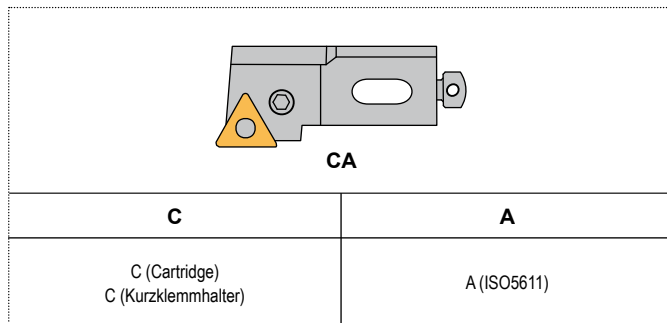

8 Cutting edge length Schneidkantenlänge

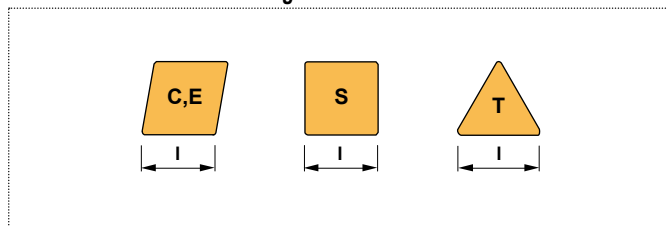

Lever lock cartridges Kurzklemmhalter mit Kniehebel

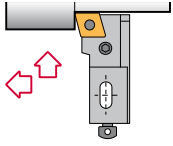
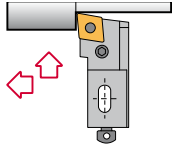
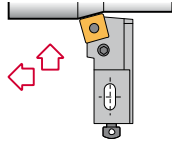
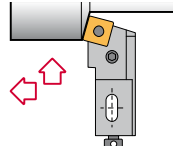
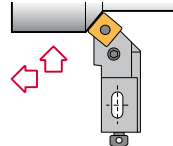
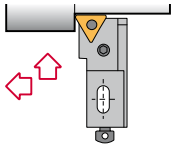
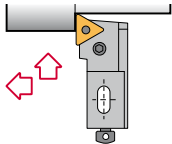
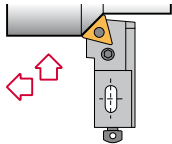
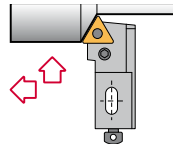
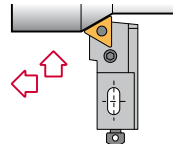
<p>PCFN 90°</p>  <p>Page CN.. 1204.. Seite A254 CN.. 1606..</p>	<p>PCLN 95°</p>  <p>Page CN.. 1204.. Seite A254 CN.. 1606..</p>	<p>PSKN 75°</p>  <p>Page SNM.. 1204.. Seite A255 SNM.. 1506..</p>	<p>PSRN 75°</p>  <p>Page SNM.. 1204.. Seite A255 SNM.. 1204..</p>	<p>PSSN 45°</p>  <p>Page SNM.. 1204.. Seite A256 SNM.. 1204..</p>
<p>PTFN 90°</p>  <p>Page TNM.. 1604.. Seite A256 TNM.. 2204..</p>	<p>PTGN 90°</p>  <p>Page TNM.. 1604.. Seite A257 TNM.. 2204..</p>	<p>PTSN 45°</p>  <p>Page TNM.. 1604.. Seite A257 TNM.. 2204..</p>	<p>PTTN 60°</p>  <p>Page TNM.. 1604.. Seite A258 TNM.. 2204..</p>	<p>PTWN 30°</p>  <p>Page TNM.. 1604.. Seite A258 TNM.. 2204..</p>

Top clamp cartridges Kurzklemmhalter mit oberer Pratzte

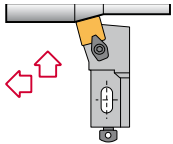
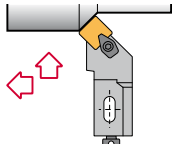
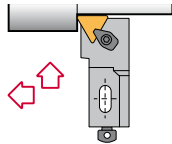
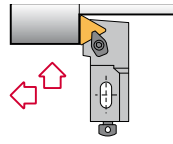
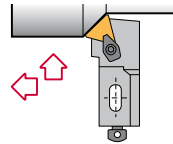
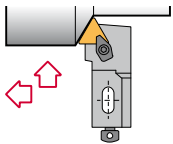
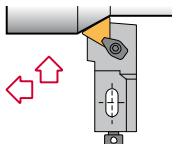
<p>CSKP 75°</p>  <p>Page SP.. 0903.. Seite A259 SP.. 1203..</p>	<p>CSSP 45°</p>  <p>Page SP.. 0903.. Seite A259 SP.. 1203..</p>	<p>CTFP 90°</p>  <p>Page TP.. 1103.. Seite A260 TP.. 1603..</p>	<p>CTGP 90°</p>  <p>Page TP.. 1103.. Seite A260 TP.. 1603..</p>	<p>CTSP 45°</p>  <p>Page TP.. 1103.. Seite A261 TP.. 1603..</p>
<p>CTTP 60°</p>  <p>Page TP.. 1103.. Seite A261 TP.. 1603..</p>	<p>CTWP 30°</p>  <p>Page TP.. 1103.. Seite A262 TP.. 1603..</p>			

Center screw cartridges Kurzklemmhalter mit Zentralschraube

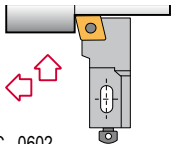
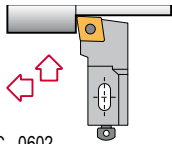
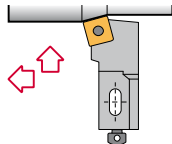
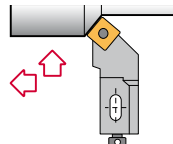
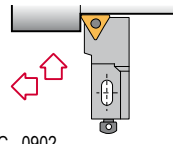
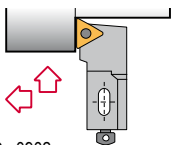
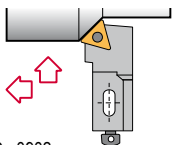
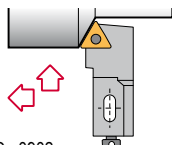
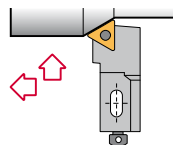
<p>SCFC 90°</p>  <p>CC.. 0602.. CC.. 09T3.. CC.. 1204.. Page Seite A263</p>	<p>SCLC 95°</p>  <p>CC.. 0602.. CC.. 09T3.. CC.. 1204.. Page Seite A263</p>	<p>SSKC 75°</p>  <p>Page SC.. 09T3.. Seite A264 SC.. 1204..</p>	<p>SSSC 45°</p>  <p>Page SC.. 09T3.. Seite A264 SC.. 1204..</p>	<p>STFC 90°</p>  <p>TC.. 0902.. TC.. 1102.. TC.. 16T3.. Page Seite A265</p>
<p>STGC 90°</p>  <p>TC.. 0902.. TC.. 1102.. TC.. 16T3.. Page Seite A265</p>	<p>STSC 45°</p>  <p>TC.. 0902.. TC.. 1102.. TC.. 16T3.. Page Seite A266</p>	<p>STTC 60°</p>  <p>TC.. 0902.. TC.. 1102.. TC.. 16T3.. Page Seite A266</p>	<p>STWC 60°</p>  <p>TC.. 1102.. TC.. 16T3.. Page Seite A267</p>	

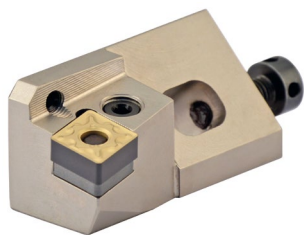

Characteristics:

Cartridge equipped with rhombic negative inserts (angle 80°) and strong cutting edges.
Axial -6°
Radial -8°

Eigenschaften:

Kurzklammhalter mit rhombischen negativen Wendeschneidplatten (80° Winkel) mit verstärkten Schnittkanten.

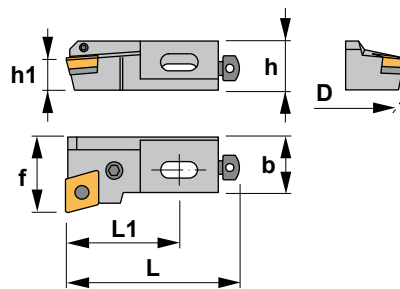

PCFN 90°

Reference Bezeichnung	D	h	h1	L	L1	f	b	Insert size Wendeschneidplatte	KG
PCFN R/L 16CA-12	60	25	16	63	38	25	20	CNM.. 1204..	0,140
PCFN R/L 20CA-12	70	30	20	70	40	25	20	CNM.. 1204..	0,170
PCFN R/L 25CA-16	100	35	25	100	50	32	25	CNM.. 1606..	0,380

Reference Bezeichnung													Nm
PCFN R/L 16CA-12	8312	1648	5003	3612	4112	1406	1505	0012	5025	2808	1808	5005	3.0
PCFN R/L 20CA-12	8012	1608	5003	3612	4112	1406	1506	0012	5003	2808	1808	5005	3.0
PCFN R/L 25CA-16	8016	1618	5003	3616	4115	1408	1508	0015	5004	2810	1810	5006	3.0

CN..

80° rhombic negative inserts.
80° rhombische negative WSP. A32-34

Reference / Bez.	l	s	d
CN.. 1204..	12,90	4,76	12,70
CN.. 1606..	16,10	6,35	15,88

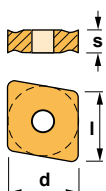

CNMG-CC	CNMG-FC	CNMG-MC	CNMG-MHC	CNMG-RC

More inserts / Andere Wendeschneidplatten: CNGP, CNMA, CNMG-KC, CNMG-FMC, CNMG-MFC, CNMG-TC, CNMM.



Characteristics:

Cartridge equipped with rhombic negative double-sided insert (angle 80°) with strong cutting edge.
Axial -6°
Radial -6°

Eigenschaften:

Kurzklammhalter mit rhombischen negativen doppelseitigen Wendeschneidplatten (80° Winkel) mit verstärkten Schnittkanten.

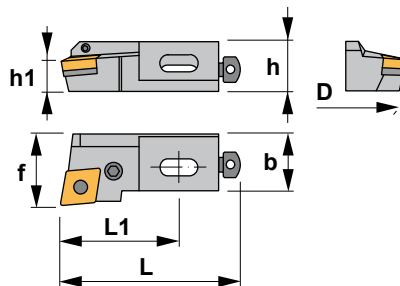

PCLN 95°

Reference Bezeichnung	D	h	h1	L	L1	f	b	Insert size Wendeschneidplatte	KG
PCLN R/L 16CA-12	60	25	16	63	38	25	20	CNM.. 1204..	0,135
PCLN R/L 20CA-12	70	30	20	70	40	25	20	CNM.. 1204..	0,160
PCLN R/L 25CA-16	100	35	25	100	50	32	25	CNM.. 1606..	0,375

Reference Bezeichnung													Nm
PCLN R/L 16CA-12	8312	1648	5003	3612	4112	1406	1505	0012	5025	2808	1808	5005	3.0
PCLN R/L 20CA-12	8012	1608	5003	3612	4112	1406	1506	0012	5003	2808	1808	5005	3.0
PCLN R/L 25CA-16	8016	1618	5003	3616	4115	1408	1508	0015	5004	2810	1810	5006	3.0

CN..

80° rhombic negative inserts.
80° rhombische negative WSP. A32-34

Reference / Bez.	l	s	d
CN.. 1204..	12,90	4,76	12,70
CN.. 1606..	16,10	6,35	15,88

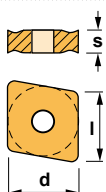

CNMG-CC	CNMG-FC	CNMG-MC	CNMG-MHC	CNMG-RC

More inserts / Andere Wendeschneidplatten: CNGP, CNMA, CNMG-KC, CNMG-FMC, CNMG-MFC, CNMG-TC, CNMM.

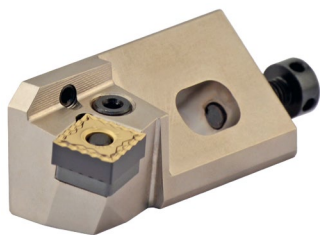

Characteristics:

Cartridge equipped with square negative inserts and strong cutting edges.

Axial -4°

Radial -4°

Eigenschaften:

Kurzklemmhalter mit vierkantigen negativen Wendeschneidplatten mit verstärkten Schnittkanten.

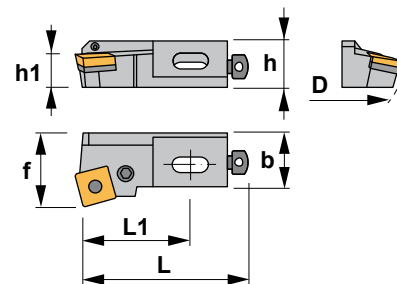

PSKN 75°

Reference Bezeichnung	D	h	h1	L	L1	f	b	Insert size Wendeschneidplatte	Kg
PSKN R/L 12CA-12	50	20	12	55	35	20	16	SNM.. 1204..	0,080
PSKN R/L 16CA-12	60	25	16	63	38	25	20	SNM.. 1204..	0,135
PSKN R/L 20CA-12	70	30	20	70	40	25	20	SNM.. 1204..	0,180
PSKN R/L 25CA-15	100	35	25	100	50	32	25	SNM.. 1506..	0,400

Reference Bezeichnung													Nm
PSKN R/L 12CA-12	8212	1626	5025	-	-	1405	1505	-	5025	2806	1806	5004	2.0
PSKN R/L 16CA-12	8312	1648	5003	3512	4112	1406	1505	0012	5025	2808	1808	5005	3.0
PSKN R/L 20CA-12	8012	1608	5003	3512	4112	1406	1506	0012	5003	2808	1808	5005	3.0
PSKN R/L 25CA-15	8016	1618	5003	3515	4115	1408	1508	0015	5004	2810	1810	5006	3.0

SNM..

Square negative inserts. A41-42
Vierkantige negative Wendeschneidplatten.

Reference / Bez.	l	s	d
SNM.. 1204..	12,70	4,76	12,70
SNM.. 1506..	15,88	6,35	15,88

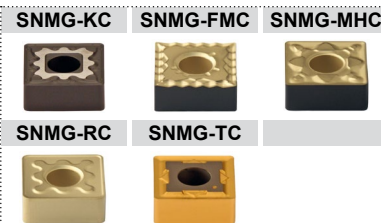
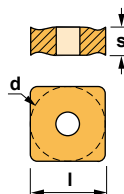

Characteristics:

Cartridge equipped with square negative inserts and strong cutting edges.

Axial -11,25°

Radial -3,25°

Eigenschaften:

Kurzklemmhalter mit vierkantigen negativen Wendeschneidplatten mit verstärkten Schnittkanten.

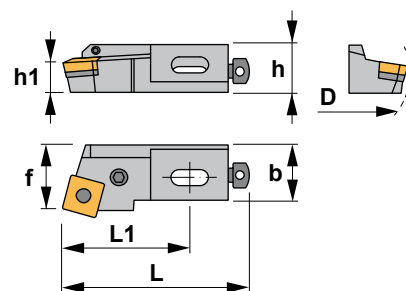

PSRN 75°

Reference Bezeichnung	D	h	h1	L	L1	f	b	Insert size Wendeschneidplatte	Kg
PSRN R/L 16CA-12	60	25	16	63	38	25	20	SNM.. 1204..	0,135
PSRN R/L 20CA-12	70	30	20	70	40	25	20	SNM.. 1204..	0,180

Reference Bezeichnung													Nm
PSRN R/L 16CA-12	8312	1648	5003	3512	4112	1406	1505	0012	5025	2808	1808	5005	3.0
PSRN R/L 20CA-12	8012	1608	5003	3512	4112	1406	1506	0012	5003	2808	1808	5005	3.0

SNM..

Square negative inserts. A41-42
Vierkantige negative Wendeschneidplatten.

Reference / Bez.	l	s	d
SNM.. 1204..	12,70	4,76	12,70

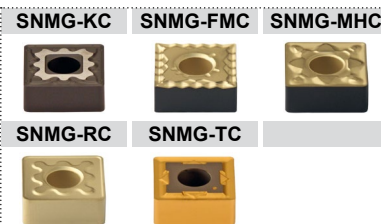
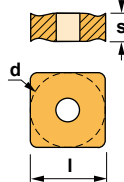



Characteristics:

Cartridge equipped with square negative inserts and strong cutting edges.

Axial -7°
Radial -7°

Eigenschaften:

Kurzklemmhalter mit vierkantigen negativen Wendschneidplatten mit verstärkten Schnittkanten.

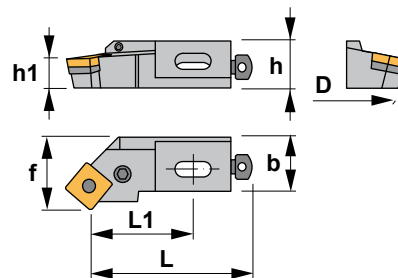

PSSN 45°

Reference Bezeichnung	D	h	h1	L	L1	f	b	Insert size Wendschneidplatte	
PSSN R/L 12CA-12	50	20	12	47	27	20	16	SNM.. 1204..	0,070
PSSN R/L 16CA-12	60	25	16	53	28	25	20	SNM.. 1204..	0,110
PSSN R/L 20CA-12	70	30	20	60	30	25	20	SNM.. 1204..	0,140

Reference Bezeichnung					Circular insert							Nm	
PSSN R/L 12CA-12	8212	1626	5025	-	-	1405	1505	-	5025	2806	1806	5004	2.0
PSSN R/L 16CA-12	8312	1648	5003	3512	4112	1406	1505	0012	5025	2808	1808	5005	3.0
PSSN R/L 20CA-12	8012	1608	5003	3512	4112	1406	1506	0012	5003	2808	1808	5005	3.0

SNM..

Square negative inserts.
Vierkantige negative Wendschneidplatten. A41-42

Reference / Bez.	l	s	d
SNM.. 1204..	12,70	4,76	12,70

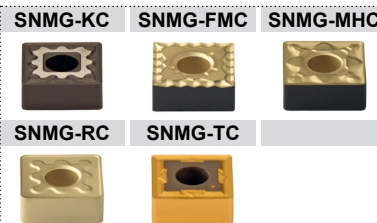
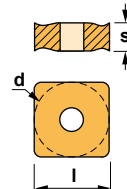

Characteristics:

Cartridge equipped with triangular negative inserts and strong cutting edges.

Axial -6°
Radial -8°

Eigenschaften:

Kurzklemmhalter mit dreikantigen negativen Wendschneidplatten mit verstärkten Schnittkanten.

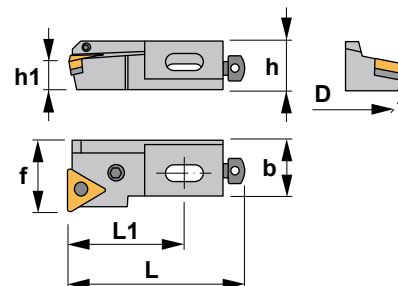

PTFN 90°

Reference Bezeichnung	D	h	h1	L	L1	f	b	Insert size Wendschneidplatte	
PTFN R/L 12CA-16	50	20	12	55	35	20	16	TNM.. 1604..	0,080
PTFN R/L 16CA-16	60	25	16	63	38	25	20	TNM.. 1604..	0,120
PTFN R/L 20CA-22	70	30	20	70	40	25	20	TNM.. 2204..	0,160
PTFN R/L 25CA-22	100	35	25	100	50	32	25	TNM.. 2204..	0,400

Reference Bezeichnung					Circular insert							Nm	
PTFN R/L 12CA-16	8216	1605	5002	-	-	1405	1505	-	5025	2806	1806	5004	1.4
PTFN R/L 16CA-16	8009	1606	5025	3416	4109	1406	1505	0009	5025	2808	1808	5005	2.0
PTFN R/L 20CA-22	8012	1608	5003	3422	4112	1406	1506	0012	5003	2808	1808	5005	3.0
PTFN R/L 25CA-22	8012	1608	5003	3422	4112	1408	1508	0012	5004	2810	1810	5006	3.0

TNM..

Triangular negative inserts.
Dreikantige negative Wendschneidplatten. A45-46

Reference / Bez.	l	s	d
TNM.. 1604..	16,50	4,76	9,52
TNM.. 2204..	22,00	4,76	12,70

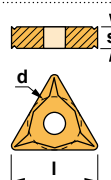

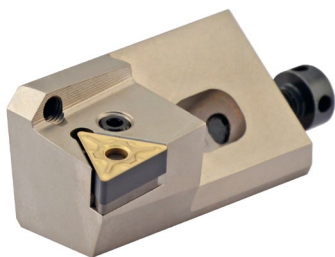

Characteristics:

Cartridge equipped with triangular negative inserts and strong cutting edges.

Axial -6°
Radial -10°

Eigenschaften:

Kurzklemmhalter mit dreieckigen negativen Wendeschneidplatten mit verstärkten Schnittkanten.

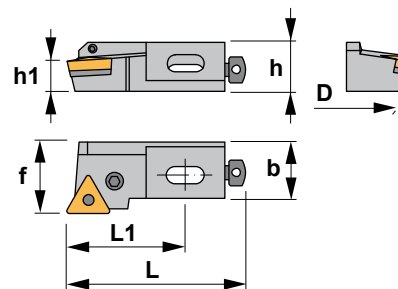

PTGN 90°

Reference Bezeichnung	D	h	h1	L	L1	f	b	Insert size Wendeschneidplatte	⚖️
PTGN R/L 12CA-16	50	20	12	55	35	20	16	TNM.. 1604..	0,080
PTGN R/L 16CA-16	60	25	16	63	38	25	20	TNM.. 1604..	0,120
PTGN R/L 20CA-22	70	30	20	70	40	25	20	TNM.. 2204..	0,160

Reference Bezeichnung	8216	1605	5002	-	-	1405	1505	-	5025	2806	1806	5004	Nm
PTGN R/L 12CA-16	8216	1605	5002	-	-	1405	1505	-	5025	2806	1806	5004	1.4
PTGN R/L 16CA-16	8009	1606	5025	3416	4109	1406	1505	0009	5025	2808	1808	5005	2.0
PTGN R/L 20CA-22	8012	1608	5003	3422	4112	1406	1506	0012	5003	2808	1808	5005	3.0

TNM..

Triangular negative inserts.
Dreieckige negative Wendeschneidplatten. ⓘ A45-46

Reference / Bez.	l	s	d
TNM.. 1604..	16,50	4,76	9,52
TNM.. 2204..	22,00	4,76	12,70

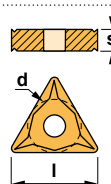

TNMG-FC	TNMG-MC
More inserts / Andere Wendeschneidplatten: TNMA, TNMG-CC, TNMG-FMC, TNMG-KC, TNMG-MFC, TNMG-MHC, TNMG-TC, TNMX.	



Characteristics:

Cartridge equipped with triangular negative inserts and strong cutting edges.

Axial -7,75°
Radial -7,75°

Eigenschaften:

Kurzklemmhalter mit dreieckigen negativen Wendeschneidplatten mit verstärkten Schnittkanten.

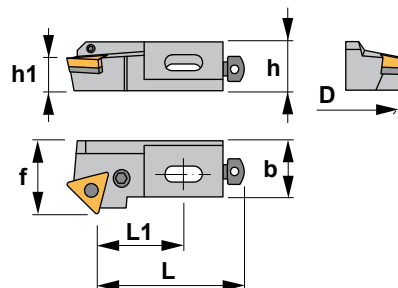

PTSN 45°

Reference Bezeichnung	D	h	h1	L	L1	f	b	Insert size Wendeschneidplatte	⚖️
PTSN R/L 12CA-16	50	20	12	47	27	20	16	TNM.. 1604..	0,070
PTSN R/L 16CA-16	60	25	16	53	28	25	20	TNM.. 1604..	0,130
PTSN R/L 20CA-22	70	30	20	60	30	25	20	TNM.. 2204..	0,165
PTSN R/L 25CA-22	100	35	25	67	37	32	25	TNM.. 2204..	0,330

Reference Bezeichnung	8216	1605	5002	-	-	1405	1505	-	5025	2806	1806	5004	Nm
PTSN R/L 12CA-16	8216	1605	5002	-	-	1405	1505	-	5025	2806	1806	5004	1.4
PTSN R/L 16CA-16	8009	1606	5025	3416	4109	1406	1505	0009	5025	2808	1808	5005	2.0
PTSN R/L 20CA-22	8012	1608	5003	3422	4112	1406	1506	0012	5003	2808	1808	5005	3.0
PTSN R/L 25CA-22	8012	1608	5003	3422	4112	1408	1508	0012	5004	2810	1810	5006	3.0

TNM..

Triangular negative inserts.
Dreieckige negative Wendeschneidplatten. ⓘ A45-46

Reference / Bez.	l	s	d
TNM.. 1604..	16,50	4,76	9,52
TNM.. 2204..	22,00	4,76	12,70

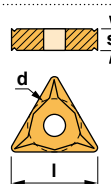

TNMG-FC	TNMG-MC
More inserts / Andere Wendeschneidplatten: TNMA, TNMG-CC, TNMG-FMC, TNMG-KC, TNMG-MFC, TNMG-MHC, TNMG-TC, TNMX.	



Characteristics:
Cartridge equipped with triangular negative inserts and strong cutting edges.
Axial -6°
Radial -10°

Eigenschaften:
Kurzklemmhalter mit dreieckigen negativen Wendeschneidplatten mit verstärkten Schnittkanten.

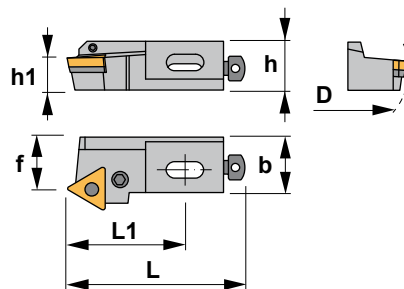

PTTN 60°

Reference Bezeichnung	D	h	h1	L	L1	f	b	Insert size Wendeschneidplatte	KG
PTTN R/L 12CA-16	50	20	12	55	35	13	16	TNM.. 1604..	0,135
PTTN R/L 16CA-16	60	25	16	63	38	15	20	TNM.. 1604..	0,120
PTTN R/L 20CA-22	70	30	20	70	40	15	20	TNM.. 2204..	0,160

Reference Bezeichnung													Nm
PTTN R/L 12CA-16	8216	1605	5002	-	-	1405	1505	-	5025	2806	1806	5004	1.4
PTTN R/L 16CA-16	8009	1606	5025	3416	4109	1406	1505	0009	5025	2808	1808	5005	2.0
PTTN R/L 20CA-22	8012	1608	5003	3422	4112	1406	1506	0012	5003	2808	1808	5005	3.0

TNM..

Triangular negative inserts.
Dreieckige negative Wendeschneidplatten. A45-46

Reference / Bez.	l	s	d
TNM.. 1604..	16,50	4,76	9,52
TNM.. 2204..	22,00	4,76	12,70

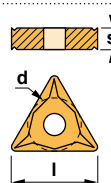

TNMG-FC

TNMG-MC



More inserts / Andere Wendeschneidplatten: TNMA, TNMG-CC, TNMG-FMC, TNMG-KC, TNMG-MFC, TNMG-MHC, TNMG-TC, TNMX.

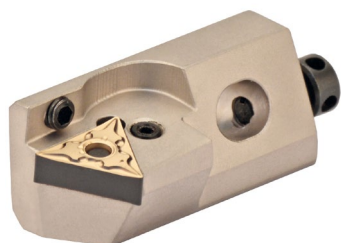

Characteristics:
Cartridge equipped with triangular negative inserts and strong cutting edges.
Axial -6°
Radial -10°

Eigenschaften:
Kurzklemmhalter mit dreieckigen negativen Wendeschneidplatten mit verstärkten Schnittkanten.

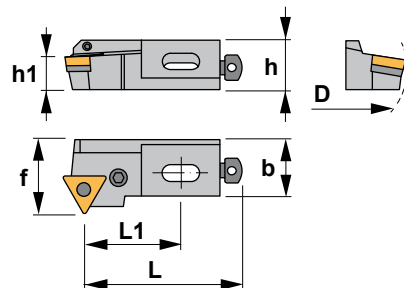

PTWN 30°

Reference Bezeichnung	D	h	h1	L	L1	f	b	Insert size Wendeschneidplatte	KG
PTWN R/L 12CA-16	50	20	12	47	27	20	16	TNM.. 1604..	0,080
PTWN R/L 16CA-16	60	25	16	53	28	25	20	TNM.. 1604..	0,130
PTWN R/L 20CA-22	70	30	20	60	30	25	20	TNM.. 2204..	0,165

Reference Bezeichnung													Nm
PTWN R/L 12CA-16	8216	1605	5002	-	-	1405	1505	-	5025	2806	1806	5004	1.4
PTWN R/L 16CA-16	8009	1606	5025	3416	4109	1406	1505	0009	5025	2808	1808	5005	2.0
PTWN R/L 20CA-22	8012	1608	5003	3422	4112	1406	1506	0012	5003	2808	1808	5005	3.0

TNM..

Triangular negative inserts.
Dreieckige negative Wendeschneidplatten. A45-46

Reference / Bez.	l	s	d
TNM.. 1604..	16,50	4,76	9,52
TNM.. 2204..	22,00	4,76	12,70

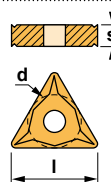

TNMG-FC

TNMG-MC



More inserts / Andere Wendeschneidplatten: TNMA, TNMG-CC, TNMG-FMC, TNMG-KC, TNMG-MFC, TNMG-MHC, TNMG-TC, TNMX.



Characteristics:

Cartridge equipped with square positive inserts and strong cutting edges.
Axial 5,75°
Radial 1,50°

Eigenschaften:

Kurzklemmhalter mit vierkantigen positiven Wendschneidplatten mit verstärkten Schnittkanten.

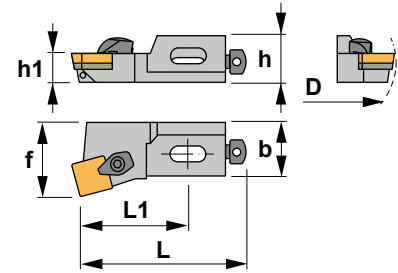

CSKP 75°

Reference Bezeichnung	D	h	h1	L	L1	f	b	Insert size Wendschneidplatte	Kg
CSKP R/L 10CA-09	40	15	10	50	30	14	11	SP..0903..	0,035
CSKP R/L 12CA-12	50	20	12	55	35	20	16	SP..1203..	0,075
CSKP R/L 16CA-12	55	25	16	63	38	25	20	SP..1203..	0,125

Reference Bezeichnung											Nm
CSKP R/L 10CA-09	2304	5025	-	-	1405	1504	5002	2806	1816	5004	2.0
CSKP R/L 12CA-12	2305	5003	-	-	1405	1505	5025	2806	1806	5004	3.0
CSKP R/L 16CA-12	2305	5003	3112	4002	1406	1505	5025	2808	1808	5005	3.0

SP.. Square positive inserts with 11° clearance. A43
Vierkantige positive Wendschneidplatten mit 11° Freiwinkel.

Reference / Bez.	l	s	d
SP.. 0903..	9,52	3,18	9,52
SP.. 1203..	12,70	3,18	12,70

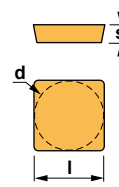

SPMR



SPUN

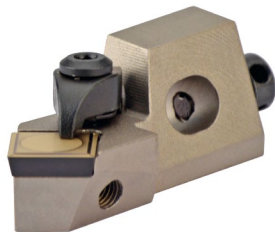

Characteristics:

Cartridge equipped with square positive inserts and strong cutting edges.
Axial 5°
Radial 0°

Eigenschaften:

Kurzklemmhalter mit vierkantigen positiven Wendschneidplatten mit verstärkten Schnittkanten.

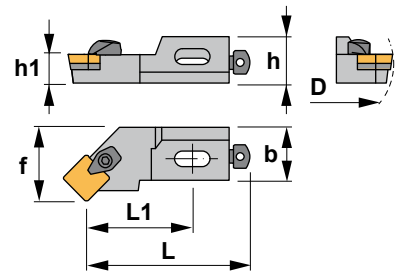

CSSP 45°

Reference Bezeichnung	D	h	h1	L	L1	f	b	Insert size Wendschneidplatte	Kg
CSSP R/L 10CA-09	40	15	10	44	24	14	11	SP..0903..	0,035
CSSP R/L 12CA-12	50	20	12	47	27	20	16	SP..1203..	0,065
CSSP R/L 16CA-12	55	25	16	53	28	25	20	SP..1203..	0,090

Reference Bezeichnung											Nm
CSSP R/L 10CA-09	2304	5025	-	-	1405	1504	5002	2806	1816	5004	2.0
CSSP R/L 12CA-12	2305	5003	-	-	1405	1505	5025	2806	1806	5004	3.0
CSSP R/L 16CA-12	2305	5003	3112	4002	1406	1505	5025	2808	1808	5005	3.0

SP.. Square positive inserts with 11° clearance. A43
Vierkantige positive Wendschneidplatten mit 11° Freiwinkel.

Reference / Bez.	l	s	d
SP.. 0903..	9,52	3,18	9,52
SP.. 1203..	12,70	3,18	12,70

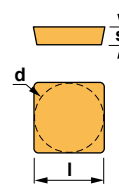

SPMR



SPUN





Characteristics:

Cartridge equipped with triangular positive inserts and strong cutting edges.

Axial 6°
Radial 0°

Eigenschaften:

Kurzklemmhalter mit dreikantigen positiven Wendeschneidplatten mit verstärkten Schnittkanten.

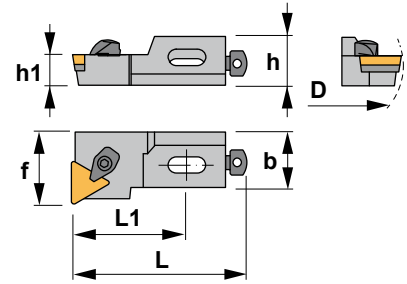

CTFP 90°

Reference Bezeichnung	D	h	h1	L	L1	f	b	Insert size Wendeschneidplatte	Kg
CTFP R/L 10CA-11	40	15	10	50	30	14	11	TP..1103..	0,035
CTFP R/L 12CA-16	50	20	12	55	35	20	16	TP..1603..	0,080
CTFP R/L 16CA-16	55	25	16	63	38	25	20	TP..1603..	0,120

Reference Bezeichnung											Nm
CTFP R/L 10CA-11	2304	5025	-	-	1405	1504	5002	2806	1816	5004	2.0
CTFP R/L 12CA-16	2305	5003	-	-	1405	1505	5025	2806	1806	5004	3.0
CTFP R/L 16CA-16	2305	5003	3116	4002	1406	1505	5025	2808	1808	5005	3.0

TP.. Triangular positive inserts with 11° clearance. A47
Dreikantige positive WSP mit 11° Freiwinkel.

Reference / Bez.	l	s	d
TP.. 1103..	11,00	3,18	6,35
TP.. 1603..	16,50	3,18	9,52

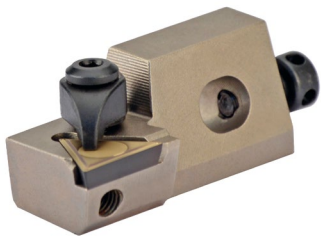
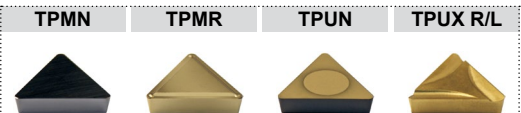
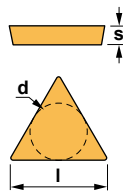

Characteristics:

Cartridge equipped with triangular positive inserts and strong cutting edges.

Axial 0°
Radial 4°

Eigenschaften:

Kurzklemmhalter mit dreikantigen positiven Wendeschneidplatten mit verstärkten Schnittkanten.

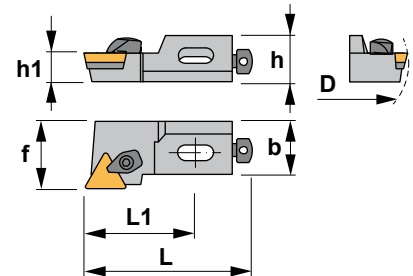

CTGP 90°

Reference Bezeichnung	D	h	h1	L	L1	f	b	Insert size Wendeschneidplatte	Kg
CTGP R/L 10CA-11	40	15	10	50	30	14	11	TP..1103..	0,035
CTGP R/L 12CA-16	50	20	12	55	35	20	16	TP..1603..	0,070
CTGP R/L 16CA-16	60	25	16	63	38	25	20	TP..1603..	0,115

Reference Bezeichnung											Nm
CTGP R/L 10CA-11	2304	5025	-	-	1405	1504	5002	2806	1816	5004	2.0
CTGP R/L 12CA-16	2305	5003	-	-	1405	1505	5025	2806	1806	5004	3.0
CTGP R/L 16CA-16	2305	5003	3116	4002	1406	1505	5025	2808	1808	5005	3.0

TP.. Triangular positive inserts with 11° clearance. A47
Dreikantige positive WSP mit 11° Freiwinkel.

Reference / Bez.	l	s	d
TP.. 1103..	11,00	3,18	6,35
TP.. 1603..	16,50	3,18	9,52

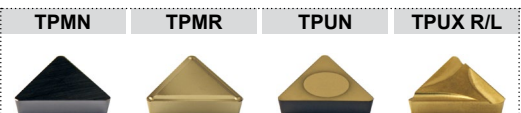
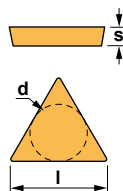



Characteristics:

Cartridge equipped with triangular positive inserts and strong cutting edges.
Axial 3,50°
Radial 3,50°

Eigenschaften:

Kurzklemmhalter mit dreikantigen positiven Wendeschneidplatten mit verstärkten Schnittkanten.

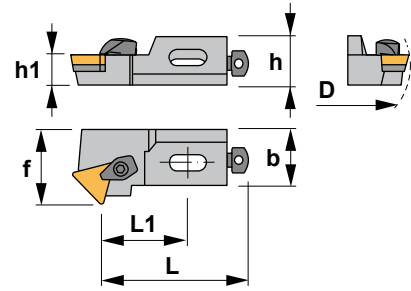

CTSP 45°

Reference Bezeichnung	D	h	h1	L	L1	f	b	Insert size Wendeschneidplatte	Kg
CTSP R/L 10CA-11	40	15	10	44	24	14	11	TP..1103..	0,035
CTSP R/L 12CA-16	50	20	12	47	27	20	16	TP..1603..	0,075
CTSP R/L 16CA-16	55	25	16	53	28	25	20	TP..1603..	0,140

Reference Bezeichnung											Nm
CTSP R/L 10CA-11	2304	5025	-	-	1405	1504	5002	2806	1816	5004	2.0
CTSP R/L 12CA-16	2305	5003	-	-	1405	1505	5025	2806	1806	5004	3.0
CTSP R/L 16CA-16	2305	5003	3116	4002	1406	1505	5025	2808	1808	5005	3.0

TP.. Triangular positive inserts with 11° clearance. A47
Dreikantige positive WSP mit 11° Freiwinkel.

Reference / Bez.	l	s	d
TP.. 1103..	11,00	3,18	6,35
TP.. 1603..	16,50	3,18	9,52

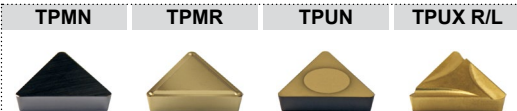
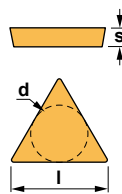

Characteristics:

Cartridge equipped with triangular positive inserts and strong cutting edges.
Axial 0°
Radial 4°

Eigenschaften:

Kurzklemmhalter mit dreikantigen positiven Wendeschneidplatten mit verstärkten Schnittkanten.

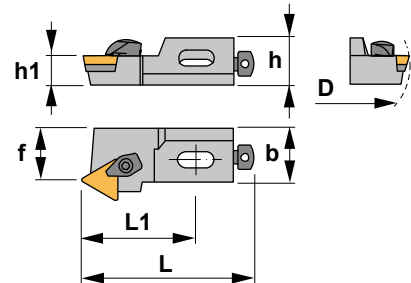

CTTP 60°

Reference Bezeichnung	D	h	h1	L	L1	f	b	Insert size Wendeschneidplatte	Kg
CTTP R/L 10CA-11	40	15	10	50	30	9	11	TP..1103..	0,040
CTTP R/L 12CA-16	50	20	12	55	35	13	16	TP..1603..	0,075
CTTP R/L 16CA-16	55	25	16	63	38	15	20	TP..1603..	0,115

Reference Bezeichnung											Nm
CTTP R/L 10CA-11	2304	5025	-	-	1405	1504	5002	2806	1816	5004	2.0
CTTP R/L 12CA-16	2305	5003	-	-	1405	1505	5025	2806	1806	5004	3.0
CTTP R/L 16CA-16	2305	5003	3116	4002	1406	1505	5025	2808	1808	5005	3.0

TP.. Triangular positive inserts with 11° clearance. A47
Dreikantige positive WSP mit 11° Freiwinkel.

Reference / Bez.	l	s	d
TP.. 1103..	11,00	3,18	6,35
TP.. 1603..	16,50	3,18	9,52

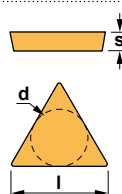

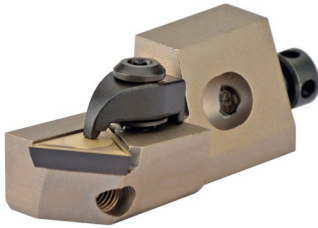

Characteristics:

Cartridge equipped with triangular positive inserts and strong cutting edges.

Axial 5,25°

Radial 3°

Eigenschaften:

Kurzklemmhalter mit dreikantigen positiven Wendeschneidplatten mit verstärkten Schnittkanten.

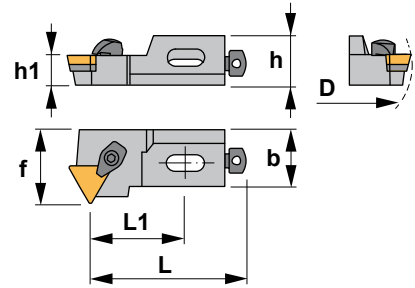

CTWP 30°

Reference Bezeichnung	D	h	h1	L	L1	f	b	Insert size Wendeschneidplatte	
CTWP R/L 10CA-11	40	15	10	44	24	14	11	TP..1103..	0,035
CTWP R/L 12CA-16	50	20	12	47	27	20	16	TP..1603..	0,065
CTWP R/L 16CA-16	55	25	16	53	28	25	20	TP..1603..	0,105

Reference Bezeichnung											Nm
CTWP R/L 10CA-11	2304	5025	-	-	1405	1504	5002	2806	1816	5004	2.0
CTWP R/L 12CA-16	2305	5003	-	-	1405	1505	5025	2806	1806	5004	3.0
CTWP R/L 16CA-16	2305	5003	3116	4002	1406	1505	5025	2808	1808	5005	3.0

TP.. Triangular positive inserts with 11° clearance. Dreikantige positive WSP mit 11° Freiwinkel. A47

Reference / Bez.	l	s	d
TP.. 1103..	11,00	3,18	6,35
TP.. 1603..	16,50	3,18	9,52

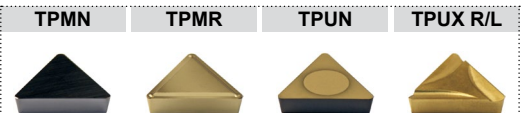
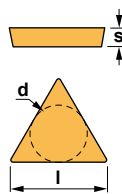



Characteristics:
Cartridge equipped with rhombic positive insert (angle 80°).
Axial 0°
Radial 0°

Eigenschaften:
Kurzklemmhalter mit rhombischen positiven Wendeschneidplatten (80° Winkel).

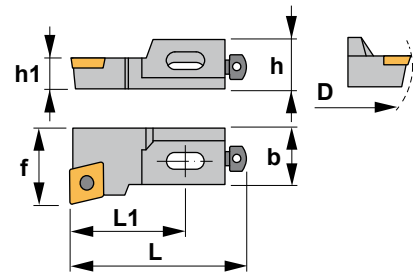

SCFC 90°

Reference Bezeichnung	D	h	h1	L	L1	f	b	Insert size Wendeschneidplatte	Kg
SCFC R/L 06CA-06	20	8	6	25	13,5	10	5,0	CCM.. 0602..	0,005
SCFC R/L 08CA-06	25	11	8	27	15,0	10	7,5	CCM.. 0602..	0,010
SCFC R/L 10CA-09	30	14	10	42	24,0	14	10,0	CCM.. 09T3..	0,030
SCFC R/L 12CA-12	40	16	12	47	35,0	20	14,0	CCM.. 1204..	0,060

Reference Bezeichnung									Nm
SCFC R/L 06CA-06	1425	5507	1403	1503	5015	2803	1803	5002	0.9
SCFC R/L 08CA-06	1425	5507	1404	1503	5015	2804	1804	5025	0.9
SCFC R/L 10CA-09	1440	5515	1405	1504	5002	2806	1806	5004	3.0
SCFC R/L 12CA-12	1250	5520	1405	1505	5025	2806	1806	5004	4.0

CC.. 80° rhombic positive inserts with 7° clearance. A30-31
80° rhombische positive WSP mit 7° Freiwinkel.

Reference / Bez.	l	s	d
CC.. 0602..	6,45	2,38	6,35
CC.. 09T3..	9,65	3,97	9,52
CC.. 1204..	12,90	4,76	12,70

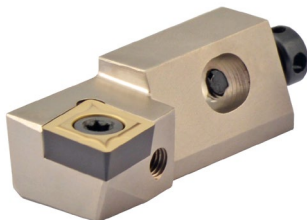
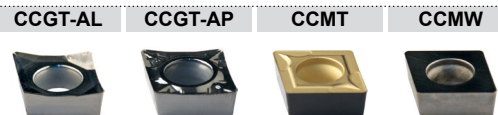
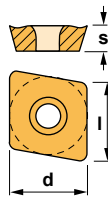

Characteristics:
Cartridge equipped with rhombic positive insert (angle 80°).
Axial 0°
Radial 0°

Eigenschaften:
Kurzklemmhalter mit rhombischen positiven Wendeschneidplatten (80° Winkel).

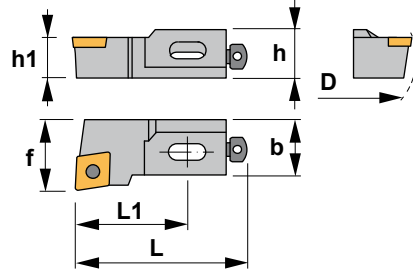

SCLC 95°

Reference Bezeichnung	D	h	h1	L	L1	f	b	Insert size Wendeschneidplatte	Kg
SCLC R/L 06CA-06	20	8	6	25	13,5	10	5,0	CCM.. 0602..	0,005
SCLC R/L 08CA-06	25	11	8	27	15,0	12	7,5	CCM.. 0602..	0,010
SCLC R/L 10CA-09	30	14	10	42	24,0	14	10,0	CCM.. 09T3..	0,030
SCLC R/L 12CA-12	40	16	12	47	35,0	20	14,0	CCM.. 1204..	0,060

Reference Bezeichnung									Nm
SCLC R/L 06CA-06	1425	5507	1403	1503	5015	2803	1803	5002	0.9
SCLC R/L 08CA-06	1425	5507	1404	1503	5015	2804	1804	5025	0.9
SCLC R/L 10CA-09	1440	5515	1405	1504	5002	2806	1806	5004	3.0
SCLC R/L 12CA-12	1250	5520	1405	1505	5025	2806	1806	5004	4.0

CC.. 80° rhombic positive inserts with 7° clearance. A30-31
80° rhombische positive WSP mit 7° Freiwinkel.

Reference / Bez.	l	s	d
CC.. 0602..	6,45	2,38	6,35
CC.. 09T3..	9,65	3,97	9,52
CC.. 1204..	12,90	4,76	12,70

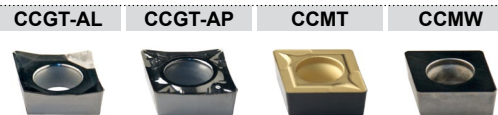
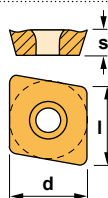



Characteristics:

Cartridge equipped with square positive inserts.

Axial -6°

Radial -10°

Eigenschaften:

Kurzklemmhalter mit vierkantigen positiven Wendeschneidplatten.

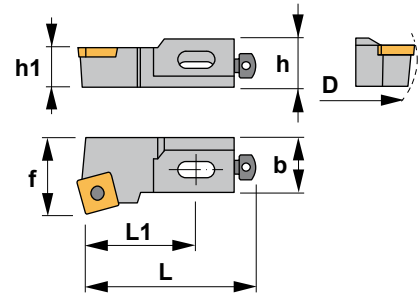

SSKC 75°

Reference Bezeichnung	D	h	h1	L	L1	f	b	Insert size Wendeschneidplatte	Kg
SSKC R/L 10CA-09	30	14	10	50	30	14	10,0	SC.. 09T3..	0,030
SSKC R/L 12CA-12	40	16	12	55	35	20	14,0	SC.. 1204..	0,065
SSKC R/L 16CA-12	50	20	16	63	38	25	17,5	SC.. 1204..	0,115

Reference Bezeichnung									Nm
SSKC R/L 10CA-09	1440	5515	1405	1504	5002	2806	1816	5004	3.0
SSKC R/L 12CA-12	1250	5520	1405	1505	5025	2806	1806	5004	4.0
SSKC R/L 16CA-12	1250	5520	1406	1505	5025	2808	1808	5005	4.0

SC..

Square positive inserts with 7° clearance.
Vierkantige positive WSP mit 7° Freiwinkel. A40

Reference / Bez.	l	s	d
SC.. 09T3..	9,52	3,97	9,52
SC.. 1204..	12,70	4,76	12,70

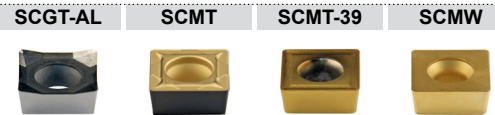
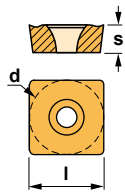

Characteristics:

Cartridge equipped with square positive inserts.

Axial -3,5°

Radial -3,5°

Eigenschaften:

Kurzklemmhalter mit vierkantigen positiven Wendeschneidplatten.

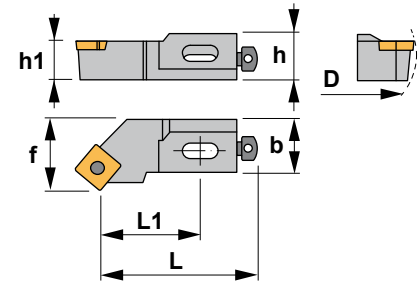

SSSC 45°

Reference Bezeichnung	D	h	h1	L	L1	f	b	Insert size Wendeschneidplatte	Kg
SSSC R/L 10CA-09	30	14	10	44	24	14	10,0	SC.. 09T3..	0,030
SSSC R/L 12CA-12	40	16	12	47	27	20	14,0	SC.. 1204..	0,055
SSSC R/L 16CA-12	50	20	16	53	28	25	17,5	SC.. 1204..	0,090

Reference Bezeichnung									Nm
SSSC R/L 10CA-09	1440	5515	1405	1504	5002	2806	1816	5004	3.0
SSSC R/L 12CA-12	1250	5520	1405	1505	5025	2806	1806	5004	4.0
SSSC R/L 16CA-12	1250	5520	1406	1505	5025	2808	1808	5005	4.0

SC..

Square positive inserts with 7° clearance.
Vierkantige positive WSP mit 7° Freiwinkel. A40

Reference / Bez.	l	s	d
SC.. 09T3..	9,52	3,97	9,52
SC.. 1204..	12,70	4,76	12,70

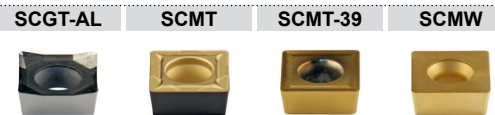
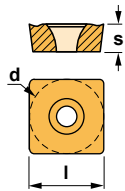



Characteristics:

Cartridge for face turning applications equipped with triangular positive inserts.

Axial 0°
Radial -3°

Eigenschaften:

Kurzklemmhalter zum Plandrehen mit dreikantigen positiven Wendeschneidplatten.

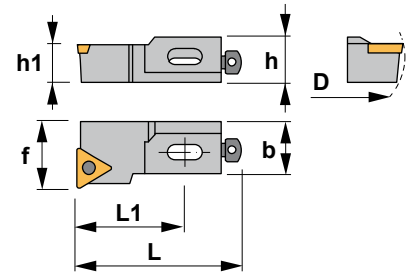

STFC 90°

Reference Bezeichnung	D	h	h1	L	L1	f	b	Insert size Wendeschneidplatte	
STFC R/L 08CA-09	25	11	8	32	15	10	7,5	TC.. 0902..	0,010
STFC R/L 08CA-11	25	11	8	32	15	11	7,5	TC.. 1102..	0,010
STFC R/L 10CA-11	30	14	10	50	30	14	10,0	TC.. 1102..	0,035
STFC R/L 12CA-16	40	16	12	55	35	20	14,0	TC.. 16T3..	0,065
STFC R/L 16CA-16	50	20	16	63	38	25	17,5	TC.. 16T3..	0,125

Reference Bezeichnung									Nm
STFC R/L 08CA-09	1222	5506	1404	1503	5015	2804	1804	5025	0.6
STFC R/L 08CA-11	1225	5507	1404	1503	5015	2804	1804	5025	0.9
STFC R/L 10CA-11	1225	5507	1405	1504	5002	2806	1816	5004	0.9
STFC R/L 12CA-16	1240	5515	1405	1505	5025	2806	1806	5004	3.0
STFC R/L 16CA-16	1240	5515	1406	1505	5025	2808	1808	5005	3.0



Characteristics:

Cartridge for face turning applications equipped with triangular positive inserts.

Axial 0°
Radial -3°

Eigenschaften:

Kurzklemmhalter zum Plandrehen mit dreikantigen positiven Wendeschneidplatten.

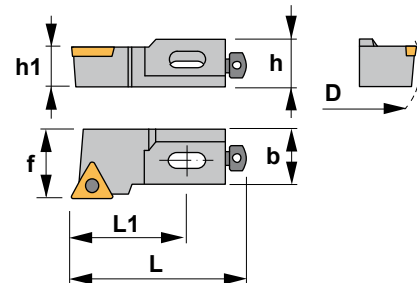

STGC 90°

Reference Bezeichnung	D	h	h1	L	L1	f	b	Insert size Wendeschneidplatte	
STGC R/L 10CA-11	30	14	10	50	30	14	10,0	TC.. 1102..	0,035
STGC R/L 12CA-16	40	16	12	55	35	20	14,0	TC.. 16T3..	0,065
STGC R/L 16CA-16	50	20	16	63	38	25	17,5	TC.. 16T3..	0,125

Reference Bezeichnung									Nm
STGC R/L 10CA-11	1225	5507	1405	1504	5002	2806	1816	5004	0.9
STGC R/L 12CA-16	1240	5515	1405	1505	5025	2806	1806	5004	3.0
STGC R/L 16CA-16	1240	5515	1406	1505	5025	2808	1808	5005	3.0

TC.. Triangular positive inserts with 7° clearance. Dreikantige positive WSP mit 7° Freiwinkel. A44

Reference / Bez.	l	s	d
TC.. 0902..	9,62	2,38	5,55
TC.. 1102..	11,00	2,38	6,35
TC.. 16T3..	16,50	3,97	9,52

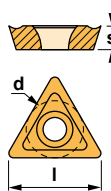

TCGT-AL

TCMT

TCMW





Characteristics:

Cartridge for face turning applications equipped with triangular positive inserts.

Axial -3,5°

Radial -3,5°

Eigenschaften:

Kurzklemmhalter zum Plandrehen mit dreikantigen positiven Wendeschneidplatten.

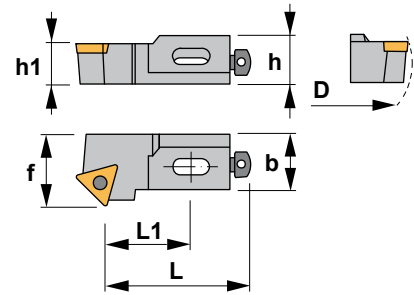

STSC 45°

Reference Bezeichnung	D	h	h1	L	L1	f	b	Insert size Wendeschneidplatte	
STSC R/L 08CA-09	25	11	8	28	11	10	7,5	TC.. 0902..	0,005
STSC R/L 08CA-11	25	11	8	27	10	11	7,5	TC.. 1102..	0,005
STSC R/L 10CA-11	30	14	10	44	24	14	10,0	TC.. 1102..	0,035
STSC R/L 12CA-16	40	16	12	47	27	20	14,0	TC.. 16T3..	0,065
STSC R/L 16CA-16	50	20	16	53	28	25	17,5	TC.. 16T3..	0,110

Reference Bezeichnung									Nm
STSC R/L 08CA-09	1222	5506	1404	1503	5015	2804	1804	5025	0.6
STSC R/L 08CA-11	1225	5507	1404	1503	5015	2804	1804	5025	0.9
STSC R/L 10CA-11	1225	5507	1405	1504	5002	2806	1816	5004	0.9
STSC R/L 12CA-16	1240	5515	1405	1505	5025	2806	1806	5004	3.0
STSC R/L 16CA-16	1240	5515	1406	1505	5025	2808	1808	5005	3.0



Characteristics:

Cartridge for face turning applications equipped with triangular positive inserts.

Axial -1,5°

Radial -2,5°

Eigenschaften:

Kurzklemmhalter zum Plandrehen mit dreikantigen positiven Wendeschneidplatten.

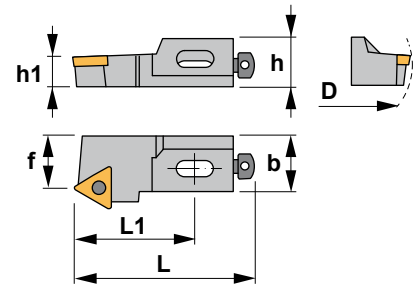

STTC 60°

Reference Bezeichnung	D	h	h1	L	L1	f	b	Insert size Wendeschneidplatte	
STTC R/L 08CA-09	25	11	8	32	15	6	7,5	TC.. 0902..	0,010
STTC R/L 08CA-11	25	11	8	32	15	6	7,5	TC.. 1102..	0,010
STTC R/L 10CA-11	30	14	10	50	30	14	10,0	TC.. 1102..	0,035
STTC R/L 12CA-16	40	16	12	55	35	13	14,0	TC.. 16T3..	0,065
STTC R/L 16CA-16	50	20	16	63	38	15	17,5	TC.. 16T3..	0,105

Reference Bezeichnung									Nm
STTC R/L 08CA-09	1222	5506	1404	1503	5015	2804	1804	5025	0.6
STTC R/L 08CA-11	1225	5507	1404	1503	5015	2804	1804	5025	0.9
STTC R/L 10CA-11	1225	5507	1405	1504	5002	2806	1816	5004	0.9
STTC R/L 12CA-16	1240	5515	1405	1505	5025	2806	1806	5004	3.0
STTC R/L 16CA-16	1240	5515	1406	1505	5025	2808	1808	5005	3.0

TC.. Triangular positive inserts with 7° clearance. Dreikantige positive WSP mit 7° Freiwinkel. A44

Reference / Bez.	l	s	d
TC.. 0902..	9,62	2,38	5,55
TC.. 1102..	11,00	2,38	6,35
TC.. 16T3..	16,50	3,97	9,52

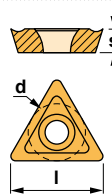

TCGT-AL

TCMT

TCMW





Characteristics:

Cartridge for face turning applications equipped with triangular positive inserts.
Axial -1,5°
Radial -2,5°

Eigenschaften:

Kurzklemmhalter zum Plandrehen mit dreikantigen positiven Wendeschneidplatten.

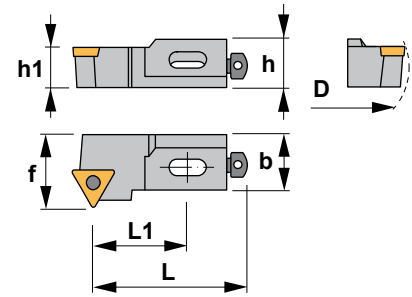

STWC 60°

Reference Bezeichnung	D	h	h1	L	L1	f	b	Insert size Wendeschneidplatte	KG
STWC R/L 08CA-11	25	11	8	27	10	10	7,5	TC.. 1102..	0,005
STWC R/L 10CA-11	30	14	10	44	24	14	10,0	TC.. 1102..	0,035
STWC R/L 12CA-16	40	16	12	47	27	20	14,0	TC.. 16T3..	0,065
STWC R/L 16CA-16	50	20	16	53	28	25	17,5	TC.. 16T3..	0,110

Reference Bezeichnung									Nm
STWC R/L 08CA-11	1225	5507	1404	1503	5015	2804	1804	5025	0.9
STWC R/L 10CA-11	1225	5507	1405	1504	5002	2806	1816	5004	0.9
STWC R/L 12CA-16	1240	5515	1405	1505	5025	2806	1806	5004	3.0
STWC R/L 16CA-16	1240	5515	1406	1505	5025	2808	1808	5005	3.0

TC.. Triangular positive inserts with 7° clearance.
Dreikantige positive WSP mit 7° Freiwinkel. A44

Reference / Bez.	l	s	d
TC.. 1102..	11,00	2,38	6,35
TC.. 16T3..	16,50	3,97	9,52

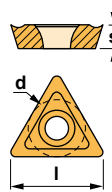

TCGT-AL

TCMT

TCMW

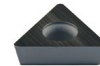





BRAZED TOOLS HM-GELÖTETE WERKZEUGE

Technical information **A270**
Technische Auskünfte

Applications index **A271**
Anwendungen

Toolholders **A272-274**
Drehmeißel

Boring bars **A275-276**
Innendrehmeißel

Uncoated inserts / Unbeschichtete Sorten

KM15

Finishing grade in the K10 range. This carbide grade is for use on cast iron, aluminium and heat-resistant alloys. This grade works well on cobalt based alloys and synthetic materials and is suitable for finishing on heat-resistant alloys.

Es ist eine Sorte zum Schlichten, im K10 Bereich. Diese Sorte ist für Guß, Aluminium und hitzebeständige Legierungen geeignet. Es hat gute Bearbeitungseigenschaften für Kobaltlegierungen und synthetische Materialien und ist für Schlichten in hitzebeständigen Legierungen besonders gut geeignet.

PM25

General purpose uncoated grade in the P30 range. This tough, economical grade is suitable for the machining of carbon steels, alloyed steels, tool steels and stainless steels.

PM25 provides toughness and resistance to deformation in roughing and semi-finishing operations.

Eine allgemeine unbeschichtete Sorte im P30 Bereich. Diese zähe und wirtschaftliche Sorte ist zur Bearbeitung von Kohlenstoffstahl, legiertem Stahl, Werkzeugstahl und rostfreiem Stahl gut geeignet.

PM25 hat eine gute Zähigkeit und Verschleißfestigkeit für Schrupp- und mittlere Schlichtarbeiten.

Grinding / Schleifen

In order to obtain a satisfactory result, it is necessary to have a steady grinding table or holder that can be set to the required angle by means of a graduated scale and by non-vibrating small spindles.

Rough grinding is normally carried out using a silicon carbide grinding wheel. The finish grind or lapping must always be made using a diamond wheel.

Longer life of the cutting edge and less breakage justify the increased cost of correct grinding.

The grinding wheel must be kept clean to ensure that cutting capacity is maintained.

Whenever possible, always grind perpendicular to the cutting edge.

Um ein erfolgreiches Ergebnis zu bekommen, braucht man stabile Auflagetische oder Halter, die man mit Hilfe eines Gradmessers im gewünschten Winkel einstellen kann, sowie schwingungsfreie Spindeln.

Zum Grobschleifen kann man eine Siliziumkarbidscheibe verwenden. Aber zum Feinschleifen und Lappen muß man immer eine Diamantscheibe verwenden. Längere Standzeit der Schneiden und wenige Kantenausbrüche gleichen die höheren Kosten von einem korrekten Schleifen aus.

Die Schleifscheibe muß man sauber halten, denn das beeinflusst wesentlich die Schneidleistung.

Wenn möglich, immer gegen die Schneidkante schleifen.

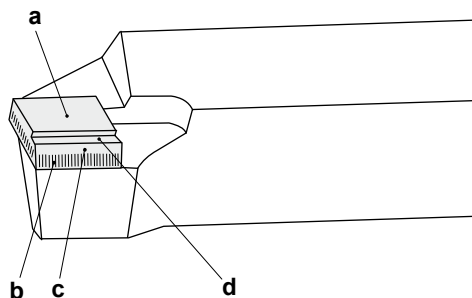

- a.- Top face / Spanflächen
- b.- Secondary clearances / Freiflächen
- c.- Lapped primary clearances / Läppfasen
- d.- Chipbreaker groove / Spanleitstufe

Toolholders Drehmeißel

ISO 2 45°

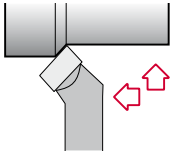

Page
Seite A272

ISO 6 90°

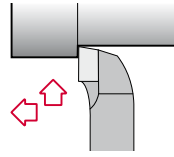

Page
Seite A272

ISO 7 90°

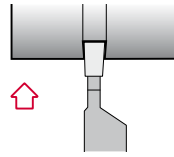

Page
Seite A273

ISO 351 80°

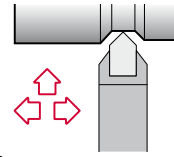

Page
Seite A273

UI 30 60°

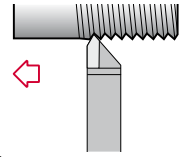

Page
Seite A274

Boring bars Innendrehmeißel

ISO 9 90°

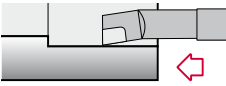

Page
Seite A275

UI 40 60°

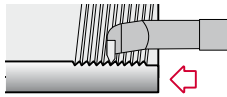

Page
Seite A275

UI 50 90°

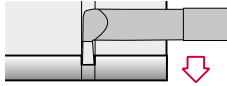

Page
Seite A276

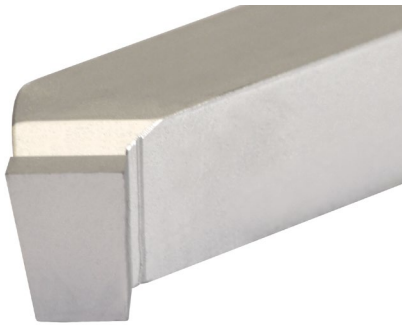

Characteristics:
Brazed toolholder.
DIN 4972

Eigenschaften:
HM-Gelöteter Drehmeißel.

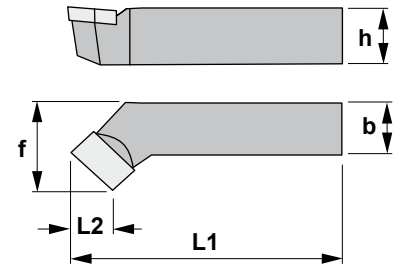
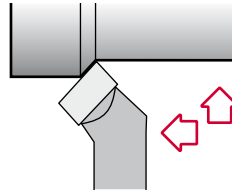

ISO 2 45°

Reference Bezeichnung	h	b	L1	L2	f	Insert size Wendeschnidplatte		KM15	PM25
ISO2 1010 R	10	10	90	8	14	C8	0,070	<input type="radio"/>	<input type="radio"/>
ISO2 1010 L	10	10	90	8	14	C8	0,070	<input type="radio"/>	<input type="radio"/>
ISO2 1212 R	12	12	100	10	17	ABC10	0,100	<input type="radio"/>	<input checked="" type="radio"/>
ISO2 1212 L	12	12	100	10	17	ABC10	0,100	<input type="radio"/>	<input checked="" type="radio"/>
ISO2 1616 R	16	16	110	12	22	ABC12	0,200	<input checked="" type="radio"/>	<input checked="" type="radio"/>
ISO2 1616 L	16	16	110	12	22	ABC12	0,200	<input checked="" type="radio"/>	<input checked="" type="radio"/>
ISO2 2020 R	20	20	125	16	28	ABC16	0,400	<input checked="" type="radio"/>	<input checked="" type="radio"/>
ISO2 2020 L	20	20	125	16	28	ABC16	0,400	<input checked="" type="radio"/>	<input checked="" type="radio"/>
ISO2 2525 R	25	25	140	20	35	ABC20	0,650	<input checked="" type="radio"/>	<input checked="" type="radio"/>
ISO2 2525 L	25	25	140	20	35	ABC20	0,650	<input checked="" type="radio"/>	<input checked="" type="radio"/>

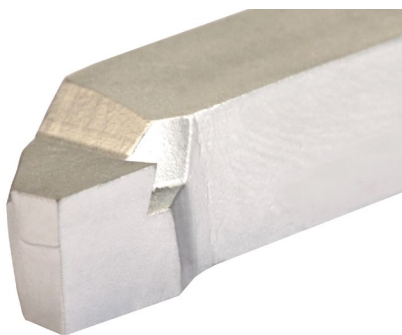

Characteristics:
Brazed toolholder.
DIN 4980

Eigenschaften:
HM-Gelöteter Drehmeißel.

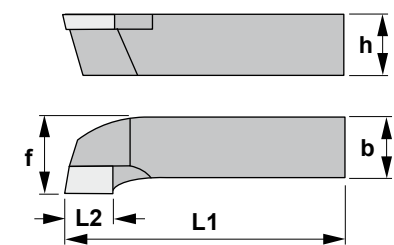
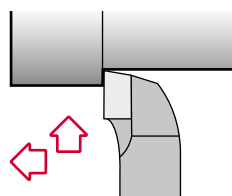

i AVAILABILITY / VERFÜGBARKEIT

- Standard item / Standard-Artikel
- Check availability / Verfügbarkeit prüfen

ISO 6 90°

Reference Bezeichnung	h	b	L1	L2	f	Insert size Wendeschnidplatte		KM15	PM25
ISO6 1010 R	10	10	90	8	14	C8	0,070	<input type="radio"/>	<input type="radio"/>
ISO6 1010 L	10	10	90	8	14	C8	0,070	<input type="radio"/>	<input type="radio"/>
ISO6 1212 R	12	12	100	10	17	ABC10	0,100	<input type="radio"/>	<input checked="" type="radio"/>
ISO6 1212 L	12	12	100	10	17	ABC10	0,100	<input type="radio"/>	<input checked="" type="radio"/>
ISO6 1616 R	16	16	110	12	22	ABC12	0,200	<input checked="" type="radio"/>	<input checked="" type="radio"/>
ISO6 1616 L	16	16	110	12	22	ABC12	0,200	<input checked="" type="radio"/>	<input checked="" type="radio"/>
ISO6 2020 R	20	20	125	16	28	ABC16	0,400	<input checked="" type="radio"/>	<input checked="" type="radio"/>
ISO6 2020 L	20	20	125	16	28	ABC16	0,400	<input checked="" type="radio"/>	<input checked="" type="radio"/>
ISO6 2525 R	25	25	140	20	35	ABC20	0,650	<input checked="" type="radio"/>	<input checked="" type="radio"/>
ISO6 2525 L	25	25	140	20	35	ABC20	0,650	<input checked="" type="radio"/>	<input checked="" type="radio"/>

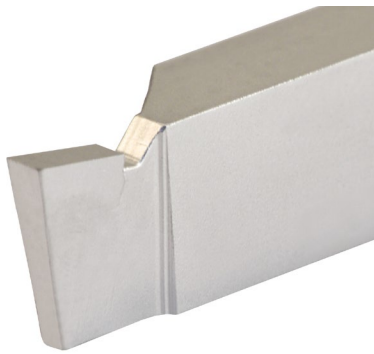

Characteristics:
Brazed toolholder.
DIN 4981

Eigenschaften:
HM-Gelöteter Drehmeißel.

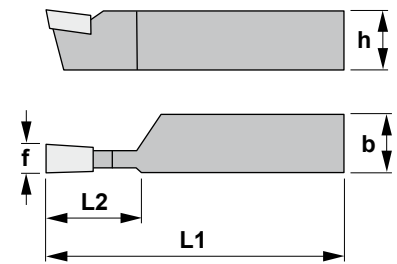
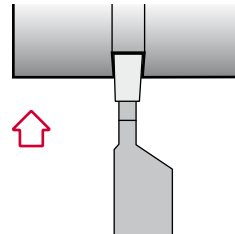

ISO 7 90°

Reference Bezeichnung	h	b	L1	L2	f	Insert size Wendeschneidplatte	⚖️ Kg	KM15	PM25
ISO7 1208 R	12	08	100	12	3	D3	0,070	○	●
ISO7 1208 L	12	08	100	12	3	D3	0,070	○	●
ISO7 1610 R	16	10	110	14	4	D4	0,150	●	●
ISO7 1610 L	16	10	110	14	4	D4	0,150	●	●
ISO7 2012 R	20	12	125	16	5	D5	0,200	●	●
ISO7 2012 L	20	12	125	16	5	D5	0,200	●	●
ISO7 2516 R	25	16	140	20	6	D6	0,400	●	●
ISO7 2516 L	25	16	140	20	6	D6	0,400	●	●
ISO7 3220 R	32	20	170	25	8	D8	0,750	●	●
ISO7 3220 L	32	20	170	25	8	D8	0,750	●	●

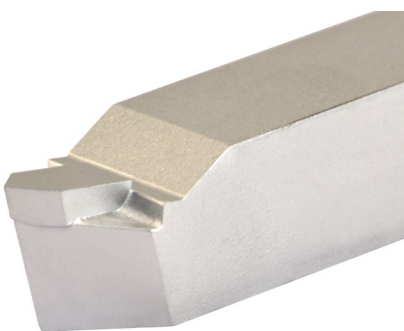

Characteristics:
Brazed toolholder.
DIN 4975

Eigenschaften:
HM-Gelöteter Drehmeißel.

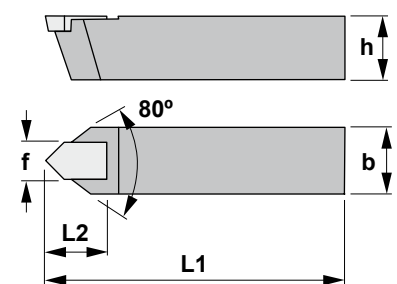
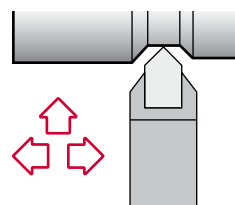

ISO 351 80°

Reference Bezeichnung	h	b	L1	L2	f	Insert size Wendeschneidplatte	⚖️ Kg	KM15	PM25
ISO351 1212 N	12	12	100	10	5	E5	0,100	○	○
ISO351 1616 N	16	16	110	12	6	E6	0,200	○	○
ISO351 2020 N	20	20	125	16	8	E8	0,400	○	○
ISO351 2525 N	25	25	140	18	10	E10	0,650	○	○

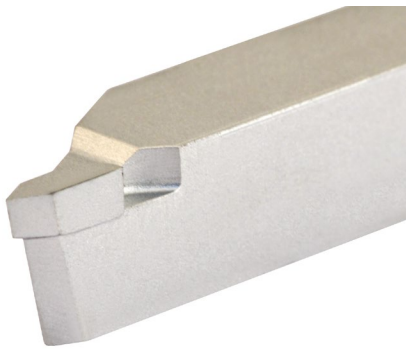

Characteristics:
Brazed toolholder.
ISO 352

Eigenschaften:
HM-Gelöteter Drehmeißel.

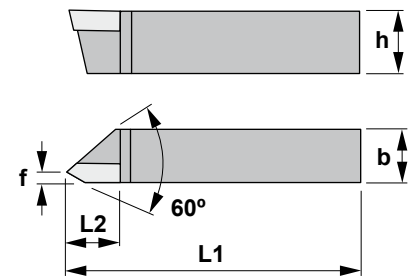
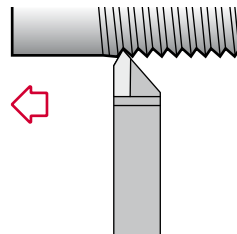

UI 30 60°

Reference Bezeichnung	h	b	L1	L2	f	Insert size Wendeschneidplatte		KM15	PM25
UI 30 60° 1212 R	12	12	100	12	1,8	E5	0,100	●	●
UI 30 60° 1616 R	16	16	110	14	2,0	E6	0,200	●	●
UI 30 60° 2020 R	20	20	125	16	2,5	E8	0,350	●	●
UI 30 60° 2525 R	25	25	140	18	3,0	E10	0,600	●	●



Characteristics:
Brazed boring bar.
UNI 4111

Eigenschaften:
HM-Gelöteter Innendrehmeißel.

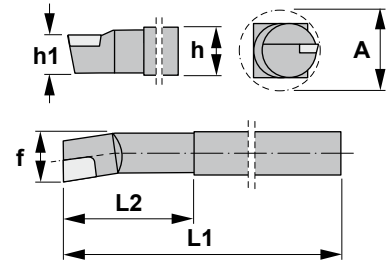
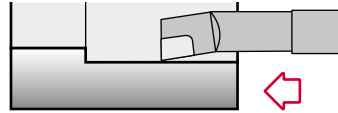

ISO 9 90°

Reference Bezeichnung	h=b	h1	L	b2	L2	f	A	Insert size Wendeschneidplatte		KM15	PM25
ISO9 0808 R	8	6,4	125	3,1	40	11	14	C7	0,060	●	●
ISO9 1010 R	10	8,0	150	4,0	50	14	18	C7	0,100	●	●
ISO9 1212 R	12	9,6	180	5,1	63	17	21	C8	0,250	●	●
ISO9 1616 R	16	12,8	210	6,2	80	22	27	ABC 10	0,400	●	●
ISO9 2020 R	20	16,0	250	8,3	100	28	34	ABC 12	0,700	●	●
ISO9 2525 R	25	20,0	300	10,0	125	35	43	ABC 16	1,300	●	●
ISO9 3232 R	32	25,6	355	12,0	160	44	52	ABC 20	2,500	●	●

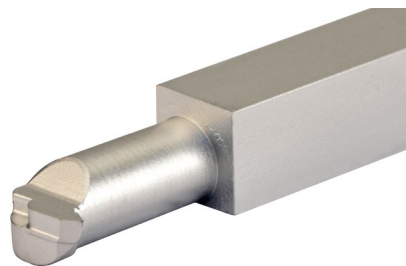

Characteristics:
Brazed boring bar.
ISO 353

Eigenschaften:
HM-Gelöteter
Innendrehmeißel.

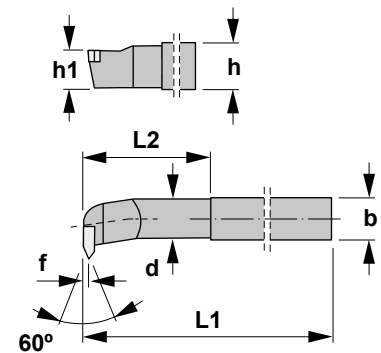
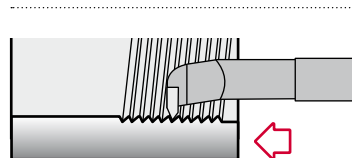

i AVAILABILITY / VERFÜGBARKEIT
 ● Standard item / Standard-Artikel
 ○ Check availability / Verfügbarkeit prüfen

UI 40 60°

Reference Bezeichnung	d	h=b	L	L2	f	Insert size Wendeschneidplatte		KM15	PM25
UI 40 60° 1010 R	10	10	100	26	1,8	E4	0,070	●	●
UI 40 60° 1212 R	12	12	110	26	1,8	E4	0,200	●	●
UI 40 60° 1616 R	16	16	140	33	2,0	E5	0,250	●	●
UI 40 60° 2020 R	20	20	160	41	2,0	E6	0,450	●	●
UI 40 60° 2525 R	25	25	180	49	2,5	E8	0,750	●	●

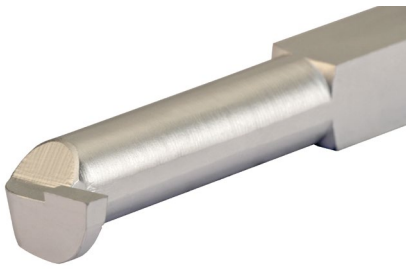

Characteristics:
Brazed boring bar.
ISO 354

Eigenschaften:
HM-Gelöteter Innendrehmeißel.

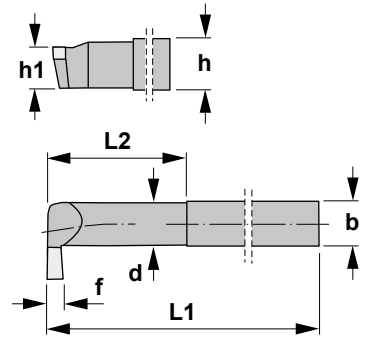
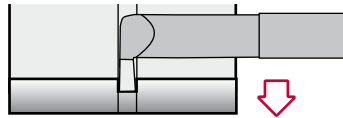

UI 50 90°

Reference Bezeichnung	d	h=b	L	L2	f	Insert size Wendeschneidplatte		KM15	PM25
UI 50 90° 1010 R	10	10	140	52	3	D3	0,100	●	●
UI 50 90° 1212 R	12	12	160	56	4	D4	0,200	●	●
UI 50 90° 1616 R	16	16	180	63	5	D5	0,350	●	●
UI 50 90° 2020 R	20	20	210	80	6	D6	0,700	●	●
UI 50 90° 2525 R	25	25	250	100	8	D8	1,250	●	●



PARTING AND GROOVING AB- UND EINSTECHDREHEN



Inserts for parting and grooving **B02-15**
Ab- und Einstechwendeschneidplatten

Applications index **B17**
Anwendungen

Toolholders **B18-43**
Klemmhalter

Boring bars **B44-47**
Bohrstangen

Tool blocks **B48**
Grundhalter

Blades **B49-53**
Stechschwerter

Top Notch tools **B54-57**
Top Notch Werkzeuge

Cutting data **B58-63**
Schnittdaten

CVD / PVD



CVD coated carbide

The CVD coatings are generated by a chemical reaction at high temperatures (700-1050°C). All CVD coatings provide a high wear resistance due to its excellent adhesion to cemented carbide.

CVD coatings are the first choice in a large turning range where wear resistance is important.

PVD coated carbide

PVD coatings offer wear resistance due to their hardness. The coating process involves the evaporation of metal, which reacts with nitrogen to form a hard nitride coating. The full process is made at relatively low temperatures (400-600°C).

PVD coatings are recommended when sharp cutting edges are needed.

Features of CVD and PVD coated carbide

	Grade	Colour	Coating composition	Definition
	TN15	●	TiN-TiC-TiN	CVD coating with TiN-TiC-TiN. The coating has a thickness of 3-5 microns for use on steel, alloyed steel and stainless steel, with or without coolant.
	TN30	●	TiCN+Al ₂ O ₃ +TiN	General purpose wear resistant CVD turning grade. The multi-layer coating includes aluminium oxide to add additional heat and wear resistance. It is used to machine steel at lower speeds than TN15. This turning grade is for demanding metal removal operations, including cutting through scale at low speeds through heavy interruption, and problem machining of stainless steel at low speed and poor rigidity.
	TL20	●	TiAlN	Carbide with TiAlN and lubricity layer PVD coating. It has a lower friction coefficient and a lower cutting energy during finishing. The sharper cutting edge reduces the built-up edge damage and gives the workpiece an excellent surface finish. Recommended for alloyed steel.
	TL30	●	TiAlN	The PVD universal high-performance grade for steel, austenitic steel, cast iron and heat-resistant alloys.
	TL40	●	TiAlN	Carbide with TiAlN and lubricity layer PVD coating. It has a lower friction coefficient and a lower cutting energy during finishing. The sharper cutting edge reduces the built-up edge damage and gives the workpiece an excellent surface finish. Recommended for alloyed steel.



CVD-beschichteter Hartmetall

Die CVD-Beschichtungen erfolgen durch eine chemische Reaktion bei hohen Temperaturen (700-1050°C). Alle CVD-Beschichtungen verfügen über eine hohe Verschleißfestigkeit, weil sie eine hervorragende Haftung auf dem Hartmetall haben.

Die CVD-Beschichtungen sind die erste Wahl bei einer breiten Drehpalette, bei der die Verschleißfestigkeit wichtig ist.

PVD-beschichteter Hartmetall

Aufgrund Ihrer Härte bieten PVD-Beschichtungen Verschleißfestigkeit an. Der Beschichtungsprozess beinhaltet die Verdampfung des Metalls, das mit Stickstoff reagiert, um eine harte Nitridbeschichtung auszubilden. Der ganze Prozess erfolgt bei relativ niedrigen Temperaturen (400-600°C).

PVD-Beschichtungen werden empfohlen, wenn man scharfe Schneidkanten braucht.

Eigenschaften von CVD und PVD-beschichtetem Hartmetall

Beschreibung	Zusammensetzung	Farbe	Sorte	
CVD-Beschichtung mit TiN-TiC-TiN. Die Dicke der Schicht ist 3-5 Mikron und ist zur Bearbeitung von Stahl, legierten Stahl und rostfreien Stahl geeignet, mit oder ohne Kühlung.	TiN-TiC-TiN	●	TN15	
Es ist eine allgemeine verschleißfeste Sorte zum CVD Drehen. Die mehrlagige Beschichtung enthält Aluminiumoxyd, um zusätzliche Wärme und Verschleißfestigkeit zu erreichen. Es wird für die Bearbeitung von Stahl bei niedrigeren Geschwindigkeiten als TN15 benutzt. Diese Sorte ist für Operationen mit großen Spanabfluß geeignet, auch mit unterbrochenen Schnitten und für die problematische Bearbeitung von rostfreiem Stahl bei niedrigen Geschwindigkeiten und ungünstigen Bedingungen.	TiCN+Al ₂ O ₃ +TiN	●	TN30	
PVD beschichtete Sorte mit TiAlN und einer Gleitschicht. Sie hat einen niedrigen Reibungswert und eine niedrige Schneidenenergie beim Schlichten. Die scharfe Schneidkante reduziert den Schneidenaufbau und erzeugt eine hervorragende Oberfläche. Empfohlen für legierten Stahl.	TiAlN	●	TL20	
Die PVD universell einsetzbare Hochleistungssorte für Stahlwerkstoffe, austenitischen Stahl, Gusswerkstoffe und hochwärmefeste Legierungen.	TiAlN	●	TL30	
PVD beschichtete Sorte mit TiAlN und einer Gleitschicht. Sie hat einen niedrigen Reibungswert und eine niedrige Schneidenenergie beim Schlichten. Die scharfe Schneidkante reduziert den Schneidenaufbau und erzeugt eine hervorragende Oberfläche. Empfohlen für legierten Stahl.	TiAlN	●	TL40	

UNCOATED CARBIDE

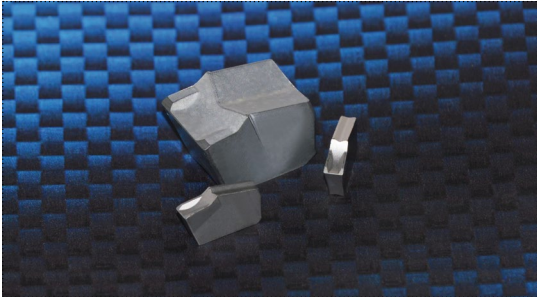

UNCOATED CARBIDE

- Excellent thermal crack resistance makes it possible to machine in wet cutting conditions.
- Cemented carbide can be applied for various workpieces.
- High toughness and low cutting force.
- Low affinity to workpiece.

Features of uncoated carbide

Material		Grade	Colour	Composition	Definition
P Steel		PM25		WC+TiC+TaC+Co	General purpose uncoated grade in the P30 range. This tough, economical grade is suitable to work carbon steels, alloyed steels, tool steels and stainless steels. PM25 provides toughness and resistance to deformation in roughing and semi-finishing applications.
		PM40		WC+TiC+TaC+Co	Roughing grade in the P35 range. This tough grade is for structural, cast and tool steels. It is recommended when toughness is more important than wear resistance.
K Cast iron		KM15		WC+Co	Finishing grade in the K10 range. This carbide grade is for use on cast iron, aluminium and heat-resistant alloys. This grade works well on cobalt based alloys and synthetic materials and is suitable for finishing on heat-resistant alloys.

Application

ISO	Composition	Features	Workpiece
P	WC+TiC+TaC+Co	Heat resistance, excellent plastic deformation resistance.	Carbon steel, alloyed steel, stainless steel.
M	WC+TiC+TaC+Co	General tools stable heat resistance with strength.	Carbon steel, alloyed steel, stainless steel, cast steel.
K	WC+Co	High strength and superior wear resistance.	Carbon iron, non-ferrous metal, plastic, etc.

Properties

Grade	Hardness (HRA)	TRS (Kgf/mm ²)	Young's modulus (103Kgf/mm ²)	Thermal expansion coefficient (10 ⁻⁶ /°C)	Thermal conductivity (cal/cm·sec·°C)
KM15	90.9	250	63	-	105
PM25	91.9	200	56	5.2	45
PM40	91.3	230	53	5.2	-



HARTMETALL

- Die hervorragende Wärmerißbeständigkeit ermöglicht eine Bearbeitung mit Kühlmittel.
- Unbeschichtetes Hartmetall eignet sich zur Bearbeitung von verschiedenen Werkstoffen.
- Hohe Zähfestigkeit und geringe Schneidkraft.
- Niedrige Affinität zum Werkstoff.

Eigenschaften von unbeschichtetem Hartmetall

Beschreibung	Zusammensetzung	Farbe	Sorte		Werkstoff
Allgemeine unbeschichtete Sorte im P30 Bereich. Diese zähe und wirtschaftliche Sorte ist zur Bearbeitung von Kohlenstoffstahl, legiertem Stahl, Werkzeugstahl und rostfreiem Stahl gut geeignet. PM25 hat eine gute Zähigkeit und Verschleißfestigkeit in Schrupp- und mittlere Schlichtarbeiten.	WC+TiC+TaC+Co		PM25		P Stahl
Es ist eine Sorte zum Schruppen im P35 Bereich. Diese zähe Sorte ist für Baustahl, Stahlguß und Werkzeugstahl geeignet, insbesondere wenn die Zähigkeit wichtiger als die Verschleißfestigkeit ist.	WC+TiC+TaC+Co		PM40		
Es ist eine Sorte zum Schlichten im K10 Bereich. Diese Sorte ist für Guß, Aluminium und hitzebeständigen Legierungen geeignet. Sie hat gute Bearbeitungseigenschaften für Kobaltlegierungen und synthetischen Materialien und ist für das Schlichten in hitzebeständigen Legierungen besonders gut geeignet.	WC+Co		KM15		K Guß

Anwendung

ISO	Zusammensetzung	Eigenschaften	Bearbeitungsstück
P	WC+TiC+TaC+Co	Hitzebeständigkeit, ausgezeichneter Widerstand gegen plastische Verformung.	Kohlenstoffstahl, legierter Stahl, rostfreier Stahl.
M	WC+TiC+TaC+Co	Stabile hitzebeständigkeit mit Stärke.	Kohlenstoffstahl, legierter Stahl, rostfreier Stahl, Stahlguß.
K	WC+Co	Hohe Festigkeit und hervorragende Verschleißfestigkeit.	Kohlenstoff-Eisen, Nicht-Eisen-Metall, Kunststoff, usw.

Sorteneigenschaften

Sorte	Härte (HRA)	TRS (Kgf/mm ²)	Youngscher Modul (103Kgf/mm ²)	Wärmeausdehnungs-Koeffizient (10 ⁻⁶ /°C)	Wärmeleitfähigkeit (cal/cm-sec-°C)
KM15	90.9	250	63	-	105
PM25	91.9	200	56	5.2	45
PM40	91.3	230	53	5.2	-

Inserts for parting and grooving
Ab- und Einstechwendeschneidplatten

USE CLASSIFICATION

- Continuous
- ◐ Slight interruption
- ✱ Interruption

AVAILABILITY

- Standard item
- Check availability

EINSATZBEREICH

- Ununterbrochen
- ◐ Leicht unterbrochen
- ✱ Unterbrochen

VERFÜGBARKEIT

- Standard-Artikel
- Verfügbarkeit prüfen

Grade Sorte	Continuous / Ununterbrochen	Slight interruption / Leicht unterbrochen	Interruption / Unterbrochen
TN15	●	◐	✱
TN30	●	◐	✱
TL20	●	◐	✱
TL30	●	◐	✱
TL40	●	◐	✱
PM25	●	◐	✱
PM40	●	◐	✱
KM15	●	◐	✱

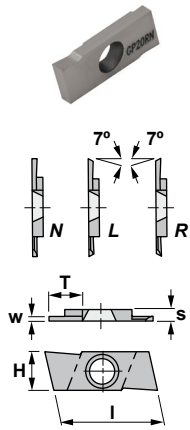

GIGP

Grooving and parting inserts.
Wendeschneidplatten zum Ein- und Abstechen.

Reference / Bezeichnung	I	s	H	T	w	KM15	PM25	TIN25	TL20
GIGP10RN	17,00	2,00	7,00	6,00	1,00	●			●
GIGP10RR	17,00	2,00	7,00	6,00	1,00	●			●
GIGP10LN	17,00	2,00	7,00	6,00	1,00	●			●
GIGP10LL	17,00	2,00	7,00	6,00	1,00	●			●
GIGP15RN	17,00	2,00	7,00	6,00	1,50	●			●
GIGP15RR	17,00	2,00	7,00	6,00	1,50	●			●
GIGP15LN	17,00	2,00	7,00	6,00	1,50	●			●
GIGP15LL	17,00	2,00	7,00	6,00	1,50	●			●
GIGP20RN	17,00	2,00	7,00	6,00	2,00	●			●
GIGP20RR	17,00	2,00	7,00	6,00	2,00	●			●
GIGP20LN	17,00	2,00	7,00	6,00	2,00	●			●
GIGP20LL	17,00	2,00	7,00	6,00	2,00	●			●

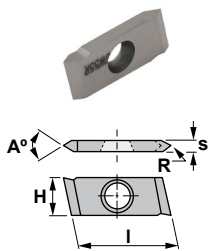

GIGW

Threading inserts.
Wendeschneidplatten zum Gewindedrehen.

Reference / Bezeichnung	I	s	H	T	w	KM15	PM25	TIN25	TL20
GIGW55R-L	17,00	2,00	7,00	6,00	1,00	●			●
GIGW60R-L	17,00	2,00	7,00	6,00	1,50	●			●

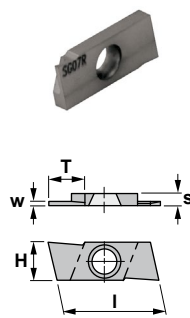

GISG

Standard grooving inserts.
Standard-Wendeschneidplatten zum Einstechen.

Reference / Bezeichnung	I	s	H	T	w	KM15	PM25	TIN25	TL20
GISG05R-L	17,00	2,00	7,00	2,54	0,50	●			●
GISG07R-L	17,00	2,00	7,00	2,54	0,70	●			●
GISG08R-L	17,00	2,00	7,00	2,54	0,80	●			●
GISG09R-L	17,00	2,00	7,00	2,54	0,90	●			●
GISG11R-L	17,00	2,00	7,00	6,00	1,10	●			●
GISG13R-L	17,00	2,00	7,00	6,00	1,30	●			●
GISG16R-L	17,00	2,00	7,00	6,00	1,60	●			●
GISG185R-L	17,00	2,00	7,00	6,00	1,85	●			●

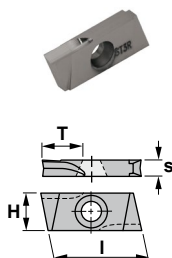

GIST

Turning inserts.
Wendeschneidplatten zum Drehen.

Reference / Bezeichnung	I	s	H	T	KM15	PM25	TIN25	TL20
GIST3R-L	17,00	3,17	7,00	6,00	●			●



Inserts for parting and grooving Ab- und Einstechwendeschneidplatten

USE CLASSIFICATION	EINSATZBEREICH	Grade	Continuous / Ununterbrochen	Slight interruption / Leicht unterbrochen	Interruption / Unterbrochen
		Sorte	●	●	✱
● Continuous	● Ununterbrochen	TN15	[Progressive bar chart]		
● Slight interruption	● Leicht unterbrochen	TN30	[Progressive bar chart]		
✱ Interruption	✱ Unterbrochen	TL20	[Progressive bar chart]		
		TL30	[Progressive bar chart]		
		TL40	[Progressive bar chart]		
		PM25	[Progressive bar chart]		
		PM40	[Progressive bar chart]		
		KM15	[Progressive bar chart]		

- USE CLASSIFICATION**
- Continuous
 - Slight interruption
 - ✱ Interruption
- AVAILABILITY**
- Standard item
 - Check availability

- EINSATZBEREICH**
- Ununterbrochen
 - Leicht unterbrochen
 - ✱ Unterbrochen
- VERFÜGBARKEIT**
- Standard-Artikel
 - Verfügbarkeit prüfen

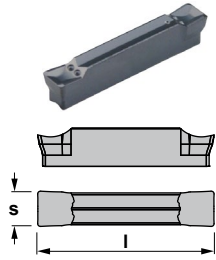

WDMG

Reference / Bez.	l	s	KM15	PM25	PM40	TN15	TN20	TN30	TK15	TL30	ZR10
WDMG 02	22	2,0								●	
WDMG 03	22	3,0								●	
WDMG 04	25	4,0								●	
WDMG 05	25	5,0								●	
WDMG 06	25	6,0								●	

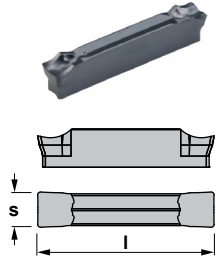

WDMP

Reference / Bez.	l	s	KM15	PM25	PM40	TN15	TN20	TN30	TK15	TL30	ZR10
WDMP 02	22	2,0								●	
WDMP 03	22	3,0								●	
WDMP 04	25	4,0								●	
WDMP 05	25	5,0								●	
WDMP 06	25	6,0								●	

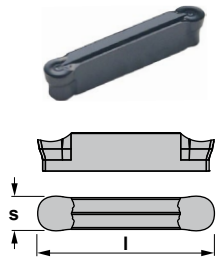

WDMR

Reference / Bez.	l	s	KM15	PM25	PM40	TN15	TN20	TN30	TK15	TL30	ZR10
WDMR 02	22	2,0								●	
WDMR 03	22	3,0								●	
WDMR 04	25	4,0								●	
WDMR 05	25	5,0								●	
WDMR 06	25	6,0								●	

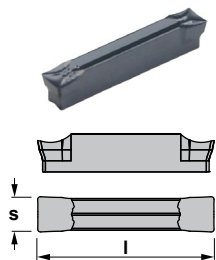

WDMT

Reference / Bez.	l	s	KM15	PM25	PM40	TN15	TN20	TN30	TK15	TL30	ZR10
WDMT 02	22	2,0								●	
WDMT 03	22	3,0								●	
WDMT 04	25	4,0								●	
WDMT 05	25	5,0								●	
WDMT 06	25	6,0								●	

Inserts for parting and grooving Ab- und Einstechwendeschneidplatten

- USE CLASSIFICATION**
- Continuous
 - ◐ Slight interruption
 - ✱ Interruption

- EINSATZBEREICH**
- Ununterbrochen
 - ◐ Leicht unterbrochen
 - ✱ Unterbrochen

- AVAILABILITY**
- Standard item
 - Check availability

- VERFÜGBARKEIT**
- Standard-Artikel
 - Verfügbarkeit prüfen

Grade Sorte	Continuous / Ununterbrochen	Slight interruption / Leicht unterbrochen	Interruption / Unterbrochen
TN15	●	◐	✱
TN30	●	◐	✱
TL20	●	◐	✱
TL30	●	◐	✱
TL40	●	◐	✱
PM25	●	◐	✱
PM40	●	◐	✱
KM15	●	◐	✱

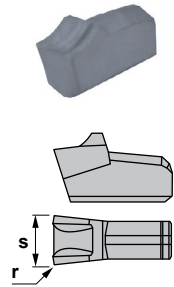

MRCN

Reference / Bezeichnung	s	r	KM15	PM25	PM40	TN15	TN20	TN30	TK15	TL40	ZR10
MRCN 1.6	1,6	0,15	●	●	●	●	●	●	●	●	●
MRCN 2.2	2,2	0,20	●	●	●	●	●	●	●	○	○
MRCN 3.0	3,0	0,20	●	●	●	●	●	●	●	○	○
MRCN 4.0	4,0	0,20	●	●	●	●	●	●	●	○	○
MRCN 5.0	5,0	0,30	●	●	●	●	●	●	●	○	○
MRCN 6.0	6,0	0,40	●	●	●	●	●	●	●	○	○

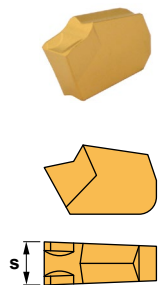

PTNT

Reference / Bezeichnung	s	KM15	PM25	PM40	TN15	TN20	TN30	TN21	TL40	ZR10
PTNT 02	2,10	●	●	●	●	●	●	●	●	●
PTNT 03	3,10	○	●	●	●	●	●	●	●	●
PTNT 04	4,10	○	●	●	●	●	●	●	●	●
PTNT 05	5,10	○	○	●	●	●	○	○	○	○
PTNT 06	6,10	○	○	○	○	○	○	○	○	○
PTNT 08	8,10	○	○	○	○	○	●	○	○	○
PTNT 09	9,10	○	○	○	○	○	●	○	○	○



Inserts for parting and grooving Ab- und Einstechwendeschneidplatten

USE CLASSIFICATION	EINSATZBEREICH	Grade	Continuous / Ununterbrochen	Slight interruption / Leicht unterbrochen	Interruption / Unterbrochen
		Sorte	●	●	✚
● Continuous	● Ununterbrochen	TN15	→	→	
● Slight interruption	● Leicht unterbrochen	TN30	→	→	→
✚ Interruption	✚ Unterbrochen	TL20		→	→
		TL30		→	→
		TL40		→	→
		PM25	→	→	
		PM40	→	→	→
		KM15	→	→	

- USE CLASSIFICATION**
- Continuous
 - Slight interruption
 - ✚ Interruption
- AVAILABILITY**
- Standard item
 - Check availability

- EINSATZBEREICH**
- Ununterbrochen
 - Leicht unterbrochen
 - ✚ Unterbrochen
- VERFÜGBARKEIT**
- Standard-Artikel
 - Verfügbarkeit prüfen

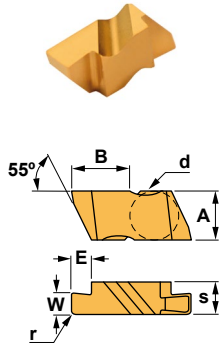

NG

Reference / Bez.	d	A	B	E	r	s	W	KM15	PM25	PM40	TN15	TN20	TN30	TK15	TL40	ZR10
NG2031R/L	4,76	5,56	6,86	1,27	0,05	3,81	0,79				○					
NG210R/L	4,76	5,56	6,86	1,27	0,05	3,81	0,99				○					
NG2041R/L	4,76	5,56	6,86	1,27	0,05	3,81	1,04				○					
NG2047R/L	4,76	5,56	6,86	1,27	0,05	3,81	1,19				○					
NG2058R/L	4,76	5,56	6,86	1,27	0,05	3,81	1,47				○					
NG2062R/L	4,76	5,56	6,86	2,79	0,05	3,81	1,57				○					
NG220R/L	4,76	5,56	6,86	2,79	0,05	3,81	2,01				○					
NG2094R/L	4,76	5,56	6,86	2,79	0,05	3,81	2,39				○					
NG230R/L	4,76	5,56	6,86	2,79	0,05	3,81	3,00				○					
NG2125R/L	4,76	5,56	6,86	2,79	0,05	3,81	3,18				○					
NG3031R/L	9,53	8,74	10,29	1,27	0,05	4,95	0,79				○					
NG310R/L	9,53	8,74	10,29	1,27	0,05	4,95	0,99				○					
NG3047R/L	9,53	8,74	10,29	1,91	0,05	4,95	1,19				○					
NG3062R/L	9,53	8,74	10,29	3,05	0,13	4,95	1,57				○					
NG3072R/L	9,53	8,74	10,29	3,05	0,13	4,95	1,83				○					
NG3078R/L	9,53	8,74	10,29	3,05	0,13	4,95	1,98				○					
NG320R/L	9,53	8,74	10,29	3,05	0,13	4,95	2,01				○					
NG3088R/L	9,53	8,74	10,29	3,05	0,13	4,95	2,24				○					
NG3094R/L	9,53	8,74	10,29	4,57	0,13	4,95	2,39				○					
NG3105R/L	9,53	8,74	10,29	4,57	0,13	4,95	2,67				○					
NG3110R/L	9,53	8,74	10,29	4,57	0,13	4,95	2,79				○					
NG330R/L	9,53	8,74	10,29	4,57	0,13	4,95	3,00				○					
NG3122R/L	9,53	8,74	10,29	4,57	0,13	4,95	3,10				○					
NG3125R/L	9,53	8,74	10,29	4,57	0,13	4,95	3,18				○					
NG3142R/L	9,53	8,74	10,29	4,57	0,13	4,95	3,61				○					
NG3156R/L	9,53	8,74	10,29	4,57	0,13	4,95	3,96				○					
NG340R/L	9,53	8,74	10,29	4,57	0,13	4,95	4,01				○					
NG3178R/L	9,53	8,74	10,29	4,57	0,13	4,95	4,52				○					
NG3185R/L	9,53	8,74	10,29	4,57	0,51	4,95	4,70				○					
NG3189R/L	9,53	8,74	10,29	4,57	0,51	4,95	4,80				○					
NG4125R/L	9,53	11,51	16,15	6,35	0,13	6,48	3,18				○					
NG4189R/L	9,53	11,51	16,15	6,35	0,51	6,48	4,80				○					
NG4213R/L	9,53	11,51	16,15	6,35	0,13	6,48	5,41				○					
NG4219R/L	9,53	11,51	16,15	6,35	0,51	6,48	5,56				○					
NG4250R/L	9,53	11,51	16,15	6,35	0,51	6,48	6,35				○					
NG4312R/L	9,53	11,51	16,15	6,35	0,76	6,48	7,92				○					
NG6281R/L	9,53	11,51	16,15	6,35	0,76	9,73	7,14				○					
NG6312R/L	9,53	11,51	16,15	6,35	0,76	9,73	7,92				○					
NG6375R/L	9,53	11,51	16,15	6,35	0,76	9,73	9,53				○					

**Inserts for parting and grooving
Ab- und Einstechwendeschneidplatten**

- USE CLASSIFICATION**
- Continuous
 - ◐ Slight interruption
 - ✚ Interruption

- EINSATZBEREICH**
- Ununterbrochen
 - ◐ Leicht unterbrochen
 - ✚ Unterbrochen

- AVAILABILITY**
- Standard item
 - Check availability

- VERFÜGBARKEIT**
- Standard-Artikel
 - Verfügbarkeit prüfen

Grade Sorte	Continuous / Ununterbrochen	Slight interruption / Leicht unterbrochen	Interruption / Unterbrochen
TN15	●	◐	✚
TN30	●	◐	✚
TL20	●	◐	✚
TL30	●	◐	✚
TL40	●	◐	✚
PM25	●	◐	✚
PM40	●	◐	✚
KM15	●	◐	✚

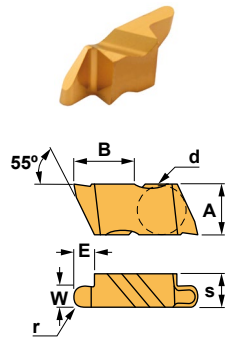

NR

Reference / Bez.	d	A	B	E	r	s	W	KM15	PM25	PM40	TN15	TN20	TN30	TK15	TL40	ZR10
NR2031R/L	4,76	5,56	6,81	2,79	0,79	3,81	1,57				○					
NR2047R/L	4,76	5,56	6,79	2,79	1,19	3,81	2,39				○					
NR2062R/L	4,76	5,56	6,77	2,79	1,57	3,81	3,18				○					
NR3031R/L	9,53	8,74	10,24	3,81	0,79	4,95	1,57				○					
NR3047R/L	9,53	8,74	10,22	3,81	1,19	4,95	2,39				○					
NR3062R/L	9,53	8,74	10,20	3,81	1,57	4,95	3,18				○					
NR3078R/L	9,53	8,74	10,18	3,81	1,98	4,95	3,96				○					
NR3094R/L	9,53	8,74	10,16	3,81	2,39	4,95	4,78				○					
NR4062R/L	9,53	11,51	16,07	6,35	1,57	6,48	3,18				○					
NR4094R/L	9,53	11,51	10,03	6,35	2,39	6,48	4,78				○					
NR4125R/L	9,53	11,51	15,98	6,35	3,18	6,48	6,35				○					

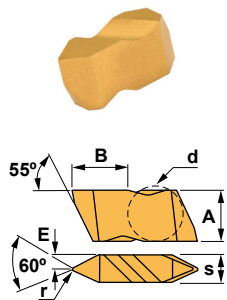

NT

Reference / Bez.	d	A	B	E	r	s	KM15	PM25	PM40	TN15	TN20	TN30	TK15	TL40	ZR10
NT2R/L	4,76	5,56	6,76	1,91	0,08	3,81				○					
NT3R/L	9,53	8,74	10,16	2,49	0,13	4,95				○					
NT4R/L	9,53	11,51	15,98	3,25	0,13	6,48				○					

Microturn

USE CLASSIFICATION

- Continuous
- ◐ Slight interruption
- ✚ Interruption

AVAILABILITY

- Standard item
- Check availability

EINSATZBEREICH

- Ununterbrochen
- ◐ Leicht unterbrochen
- ✚ Unterbrochen

VERFÜGBARKEIT

- Standard-Artikel
- Verfügbarkeit prüfen

Grade Sorte	Continuous / Ununterbrochen	Slight interruption / Leicht unterbrochen	Interruption / Unterbrochen
TN15	●	◐	✚
TN30	●	◐	✚
TL20	●	◐	✚
TL30	●	◐	✚
TL40	●	◐	✚
PM25	●	◐	✚
PM40	●	◐	✚
KM15	●	◐	✚

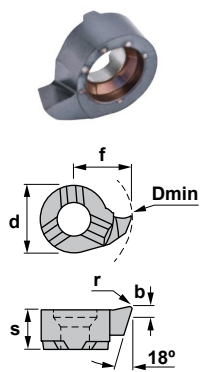

L

Insert for turning.
Wendeschneidplatte zum Drehen.

Reference / Bezeichnung	Dmin	b	f	s	d	r	KM15	PM25	TIN25	TL20
LS08.1846.02	7,8	3,3	4,65	3,5	6,0	0,2	●			●
LS11.1855.02	9,8	3,9	5,50	4,2	8,0	0,2	●			●
LS11.1867.02	11,0	3,9	6,70	4,2	8,0	0,2	●			●
LS14.1867.02	13,8	5,0	8,70	5,1	9,0	0,2	●			●
LS16.1897.02	15,5	5,0	9,70	5,4	11,0	0,2	●			●

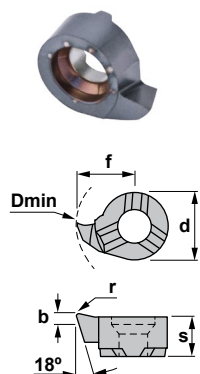

R

Insert for turning.
Wendeschneidplatte zum Drehen.

Reference / Bezeichnung	Dmin	b	f	s	d	r	KM15	PM25	TIN25	TL20
RS08.1846.02	7,8	3,3	4,65	3,5	6,0	0,2	●			●
RS11.1855.02	9,8	3,9	5,50	4,2	8,0	0,2	●			●
RS11.1867.02	11,0	3,9	6,70	4,2	8,0	0,2	●			●
RS14.1867.02	13,8	5,0	8,70	5,1	9,0	0,2	●			●
RS16.1897.02	15,5	5,0	9,70	5,4	11,0	0,2	●			●



Microturn

USE CLASSIFICATION

- Continuous
- ◐ Slight interruption
- ✱ Interruption

AVAILABILITY

- Standard item
- Check availability

EINSATZBEREICH

- Ununterbrochen
- ◐ Leicht unterbrochen
- ✱ Unterbrochen

VERFÜGBARKEIT

- Standard-Artikel
- Verfügbarkeit prüfen

Grade Sorte	Continuous / Ununterbrochen	Slight interruption / Leicht unterbrochen	Interruption / Unterbrochen
TN15	●	◐	✱
TN30	●	◐	✱
TL20	●	◐	✱
TL30	●	◐	✱
TL40	●	◐	✱
PM25	●	◐	✱
PM40	●	◐	✱
KM15	●	◐	✱

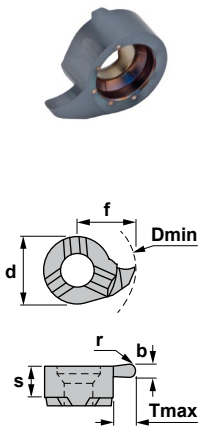

L

Insert for grooving with radius.
Wendeschneidplatten zum Vollradius-Einstechen.

Reference / Bezeichnung	Dmin	b	r	f	s	d	tmax	KM15	PM25	TIN25	TL20
LS08.008R04	8,0	0,8	0,4	4,8	3,3	6,0	1,0				●
LS08.012R06	8,0	1,2	0,6	4,8	3,3	6,0	1,0				●
LS08.018R09	8,0	1,8	0,9	4,8	3,3	6,0	1,0				●
LS11.008R04	11,0	0,8	0,4	6,7	4,2	8,0	2,3				●
LS11.012R06	11,0	1,2	0,6	6,7	4,2	8,0	2,3				●
LS11.018R09	11,0	1,8	0,9	6,7	4,2	8,0	2,3				●
LS11.020R10	11,0	2,0	1,0	6,7	4,2	8,0	2,3				●
LS11.030R15	11,0	3,0	1,5	6,7	4,2	8,0	2,3				●
LS14.012R06	14,0	1,2	0,6	9,0	4,0	9,0	4,0				●
LS14.018R09	14,0	1,8	0,9	9,0	4,0	9,0	4,0				●
LS14.020R10	14,0	2,0	1,0	9,0	4,0	9,0	4,0				●
LS14.022R11	14,0	2,2	1,1	9,0	4,0	9,0	4,0				●
LS14.030R15	14,0	3,0	1,5	9,0	4,0	9,0	4,0				●
LS16.018R09	16,0	1,8	0,9	10,2	5,4	11,0	4,3				●
LS16.022R11	16,0	2,2	1,1	10,2	5,4	11,0	4,3				●
LS16.030R15	16,0	3,0	1,5	10,2	5,4	11,0	4,3				●
LS16.040R20	16,0	4,0	2,0	10,2	5,4	11,0	4,3				●

R

Insert for grooving with radius.
Wendeschneidplatten zum Vollradius-Einstechen.

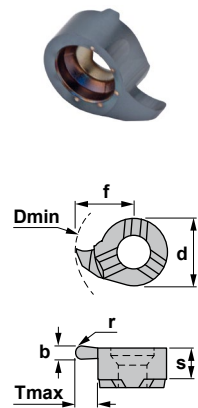

Reference / Bezeichnung	Dmin	b	r	f	s	d	tmax	KM15	PM25	TIN25	TL20
RS08.008R04	8,0	0,8	0,4	4,8	3,3	6,0	1,0				●
RS08.012R06	8,0	1,2	0,6	4,8	3,3	6,0	1,0				●
RS08.018R09	8,0	1,8	0,9	4,8	3,3	6,0	1,0				●
RS11.008R04	11,0	0,8	0,4	6,7	4,2	8,0	2,3				●
RS11.012R06	11,0	1,2	0,6	6,7	4,2	8,0	2,3				●
RS11.018R09	11,0	1,8	0,9	6,7	4,2	8,0	2,3				●
RS11.020R10	11,0	2,0	1,0	6,7	4,2	8,0	2,3				●
RS11.030R15	11,0	3,0	1,5	6,7	4,2	8,0	2,3				●
RS14.012R06	14,0	1,2	0,6	9,0	4,0	9,0	4,0				●
RS14.018R09	14,0	1,8	0,9	9,0	4,0	9,0	4,0				●
RS14.020R10	14,0	2,0	1,0	9,0	4,0	9,0	4,0				●
RS14.022R11	14,0	2,2	1,1	9,0	4,0	9,0	4,0				●
RS14.030R15	14,0	3,0	1,5	9,0	4,0	9,0	4,0				●
RS16.018R09	16,0	1,8	0,9	10,2	5,4	11,0	4,3				●
RS16.022R11	16,0	2,2	1,1	10,2	5,4	11,0	4,3				●
RS16.030R15	16,0	3,0	1,5	10,2	5,4	11,0	4,3				●
RS16.040R20	16,0	4,0	2,0	10,2	5,4	11,0	4,3				●

Microturn

- USE CLASSIFICATION**
- Continuous
 - ◐ Slight interruption
 - ⊕ Interruption

- AVAILABILITY**
- Standard item
 - Check availability

- EINSATZBEREICH**
- Ununterbrochen
 - ◐ Leicht unterbrochen
 - ⊕ Unterbrochen

- VERFÜGBARKEIT**
- Standard-Artikel
 - Verfügbarkeit prüfen

Grade Sorte	Continuous / Ununterbrochen	Slight interruption / Leicht unterbrochen	Interruption / Unterbrochen
TN15	●	◐	⊕
TN30	●	◐	⊕
TL20	●	◐	⊕
TL30	●	◐	⊕
TL40	●	◐	⊕
PM25	●	◐	⊕
PM40	●	◐	⊕
KM15	●	◐	⊕

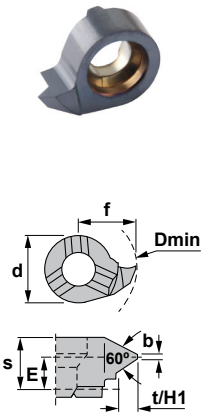

L

Insert for threading.
Wendeschneidplatte zum Gewindedrehen.

Reference / Bez.	Dmin	pitch.	t/H1	f	E	s	b	d	KM15	PM25	TIN25	TL20
LS08.0815.01	8,0	1,5 / 1,75	0,95	4,8	2,5	3,5	0,18	6,0				●
LS11.1020.01	11,0	2,0	1,08	6,7	3,0	4,3	0,25	8,0				●
LS11.1325.01	11,0	2,5	1,35	6,7	3,0	4,3	0,31	8,0				●
LS14.1020.01	14,0	2,0	1,08	9,0	4,2	5,4	0,25	9,0				●
LS14.1325.01	14,0	2,5	1,35	9,0	4,7	5,4	0,31	9,0				●
LS16.1325.01	16,0	2,5	1,35	10,2	4,2	5,5	0,31	11,0				●
LS08.0205.01	8,0	0,5 / 0,75	0,43	4,8	2,7	3,5	0,06	6,0				●
LS08.0510.01	8,0	1,0 / 1,25	0,70	4,8	2,7	3,5	0,12	6,0				●
LS11.0205.01	11,0	0,5 / 0,75	0,75	6,7	3,5	4,3	0,06	8,0				●
LS11.0510.01	11,0	1,0	0,55	6,7	3,5	4,3	0,12	8,0				●
LS11.0815.01	11,0	1,5	0,81	6,7	3,5	4,3	0,18	8,0				●
LS14.0510.01	14,0	1,0	0,55	9,0	4,7	5,4	0,12	9,0				●
LS14.0815.01	14,0	1,5	0,81	9,0	4,5	5,4	0,18	9,0				●
LS16.0510.01	16,0	1,0	0,55	10,2	4,7	5,5	0,12	11,0				●
LS16.0815.01	16,0	1,5	0,81	10,2	4,5	5,5	0,18	11,0				●
LS16.1020.01	16,0	2,0	1,08	10,2	4,2	5,5	0,25	11,0				●

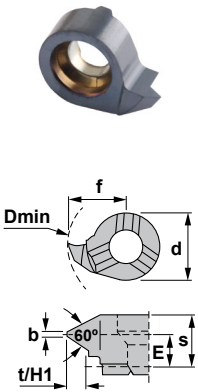

R

Insert for threading.
Wendeschneidplatte zum Gewindedrehen.

Reference / Bez.	Dmin	pitch.	t/H1	f	E	s	b	d	KM15	PM25	TIN25	TL20
RS08.0815.01	8,0	1,5 / 1,75	0,95	4,8	2,5	3,5	0,18	6,0				●
RS11.1020.01	11,0	2,0	1,08	6,7	3,0	4,3	0,25	8,0				●
RS11.1325.01	11,0	2,5	1,35	6,7	3,0	4,3	0,31	8,0				●
RS14.1020.01	14,0	2,0	1,08	9,0	4,2	5,4	0,25	9,0				●
RS14.1325.01	14,0	2,5	1,35	9,0	4,7	5,4	0,31	9,0				●
RS16.1325.01	16,0	2,5	1,35	10,2	4,2	5,5	0,31	11,0				●
RS08.0205.01	8,0	0,5 / 0,75	0,43	4,8	2,7	3,5	0,06	6,0				●
RS08.0510.01	8,0	1,0 / 1,25	0,70	4,8	2,7	3,5	0,12	6,0				●
RS11.0205.01	11,0	0,5 / 0,75	0,75	6,7	3,5	4,3	0,06	8,0				●
RS11.0510.01	11,0	1,0	0,55	6,7	3,5	4,3	0,12	8,0				●
RS11.0815.01	11,0	1,5	0,81	6,7	3,5	4,3	0,18	8,0				●
RS14.0510.01	14,0	1,0	0,55	9,0	4,7	5,4	0,12	9,0				●
RS14.0815.01	14,0	1,5	0,81	9,0	4,5	5,4	0,18	9,0				●
RS16.0510.01	16,0	1,0	0,55	10,2	4,7	5,5	0,12	11,0				●
RS16.0815.01	16,0	1,5	0,81	10,2	4,5	5,5	0,18	11,0				●
RS16.1020.01	16,0	2,0	1,08	10,2	4,2	5,5	0,25	11,0				●



Microturn

USE CLASSIFICATION

- Continuous
- ◐ Slight interruption
- ✚ Interruption

AVAILABILITY

- Standard item
- Check availability

EINSATZBEREICH

- Ununterbrochen
- ◐ Leicht unterbrochen
- ✚ Unterbrochen

VERFÜGBARKEIT

- Standard-Artikel
- Verfügbarkeit prüfen

Grade Sorte	● Continuous / Ununterbrochen	◐ Slight interruption / Leicht unterbrochen	✚ Interruption / Unterbrochen
TN15	●	◐	✚
TN30	●	◐	✚
TL20	●	◐	✚
TL30	●	◐	✚
TL40	●	◐	✚
PM25	●	◐	✚
PM40	●	◐	✚
KM15	●	◐	✚

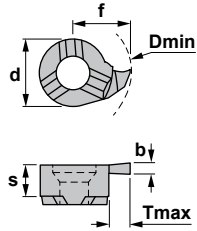
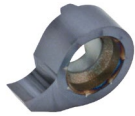

L

Insert for grooving.
Wendeschneidplatte zum Einstechen.

Reference / Bez.	Dmin	b	f	s	d	tmax	KM15	PM25	TN25	TL20
LS008.0070	8,0	0,73	4,8	3,3	6,0	1,0				●
LS008.0080	8,0	0,83	4,8	3,3	6,0	1,0				●
LS008.0090	8,0	0,93	4,8	3,3	6,0	1,0				●
LS008.0110	8,0	1,20	4,8	3,3	6,0	1,0				●
LS008.0130	8,0	1,40	4,8	3,3	6,0	1,0				●
LS008.0160	8,0	1,70	4,8	3,3	6,0	1,0				●
LS008.0100	8,0	1,00	4,8	3,3	6,0	1,0				●
LS008.0150	8,0	1,50	4,8	3,3	6,0	1,0				●
LS008.0200	8,0	2,00	4,8	3,3	6,0	1,0				●
LS011.0070	11,0	0,73	6,7	4,2	8,0	1,2				●
LS011.0080	11,0	0,83	6,7	4,2	8,0	1,3				●
LS011.0090	11,0	0,93	6,7	4,2	8,0	1,5				●
LS011.0110	11,0	1,20	6,7	4,2	8,0	2,3				●
LS011.0130	11,0	1,40	6,7	4,2	8,0	2,3				●
LS011.0160	11,0	1,70	6,7	4,2	8,0	2,3				●
LS011.0100	11,0	1,00	6,7	4,2	8,0	2,3				●
LS011.0150	11,0	1,50	6,7	4,2	8,0	2,3				●
LS011.0200	11,0	2,00	6,7	4,2	8,0	2,3				●
LS011.0250	11,0	2,50	6,7	4,2	8,0	2,3				●
LS011.0300	11,0	3,00	6,7	4,2	8,0	2,3				●
LS014.0070	14,0	0,73	9,0	5,3	9,0	1,2				●
LS014.0080	14,0	0,83	9,0	5,3	9,0	1,3				●
LS014.0090	14,0	0,93	9,0	5,3	9,0	1,5				●
LS014.0110	14,0	1,20	9,0	5,3	9,0	4,0				●
LS014.0130	14,0	1,40	9,0	5,3	9,0	4,0				●
LS014.0160	14,0	1,70	9,0	5,3	9,0	4,0				●
LS014.0150	14,0	1,50	9,0	5,3	9,0	4,0				●
LS014.0200	14,0	2,00	9,0	5,3	9,0	4,0				●
LS014.0250	14,0	2,50	9,0	5,3	9,0	4,0				●
LS014.0300	14,0	3,00	9,0	5,3	9,0	4,0				●
LS016.0070	16,0	0,73	10,2	5,4	11,0	1,2				●
LS016.0080	16,0	0,83	10,2	5,4	11,0	1,3				●
LS016.0090	16,0	0,93	10,2	5,4	11,0	1,5				●
LS016.0110	16,0	1,20	10,2	5,4	11,0	4,3				●
LS016.0130	16,0	1,40	10,2	5,4	11,0	4,3				●
LS016.0160	16,0	1,70	10,2	5,4	11,0	4,3				●
LS016.0150	16,0	1,50	10,2	5,4	11,0	4,3				●
LS016.0200	16,0	2,00	10,2	5,4	11,0	4,3				●
LS016.0250	16,0	2,50	10,2	5,4	11,0	4,3				●
LS016.0300	16,0	3,00	10,2	5,4	11,0	4,3				●
LS016.0350	16,0	3,50	10,2	5,4	11,0	4,3				●
LS016.0400	16,0	4,00	10,2	5,4	11,0	4,3				●

Microturn

- USE CLASSIFICATION**
- Continuous
 - ◐ Slight interruption
 - ✚ Interruption

- AVAILABILITY**
- Standard item
 - Check availability

- EINSATZBEREICH**
- Ununterbrochen
 - ◐ Leicht unterbrochen
 - ✚ Unterbrochen

- VERFÜGBARKEIT**
- Standard-Artikel
 - Verfügbarkeit prüfen

Grade Sorte	Continuous / Ununterbrochen	Slight interruption / Leicht unterbrochen	Interruption / Unterbrochen
TN15	●	◐	✚
TN30	●	◐	✚
TL20	●	◐	✚
TL30	●	◐	✚
TL40	●	◐	✚
PM25	●	◐	✚
PM40	●	◐	✚
KM15	●	◐	✚

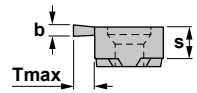
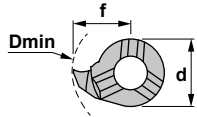
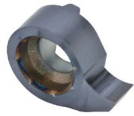

R

Insert for grooving.
Wendeschneidplatte zum Einstechen.

Reference / Bez.	Dmin	b	f	s	d	tmax	KM15	PM25	TIN25	TL20
RS008.0070	8,0	0,73	4,8	3,3	6,0	1,0				●
RS008.0080	8,0	0,83	4,8	3,3	6,0	1,0				●
RS008.0090	8,0	0,93	4,8	3,3	6,0	1,0				●
RS008.0110	8,0	1,20	4,8	3,3	6,0	1,0				●
RS008.0130	8,0	1,40	4,8	3,3	6,0	1,0				●
RS008.0160	8,0	1,70	4,8	3,3	6,0	1,0				●
RS008.0100	8,0	1,00	4,8	3,3	6,0	1,0				●
RS008.0150	8,0	1,50	4,8	3,3	6,0	1,0				●
RS008.0200	8,0	2,00	4,8	3,3	6,0	1,0				●
RS011.0070	11,0	0,73	6,7	4,2	8,0	1,2				●
RS011.0080	11,0	0,83	6,7	4,2	8,0	1,3				●
RS011.0090	11,0	0,93	6,7	4,2	8,0	1,5				●
RS011.0110	11,0	1,20	6,7	4,2	8,0	2,3				●
RS011.0130	11,0	1,40	6,7	4,2	8,0	2,3				●
RS011.0160	11,0	1,70	6,7	4,2	8,0	2,3				●
RS011.0100	11,0	1,00	6,7	4,2	8,0	2,3				●
RS011.0150	11,0	1,50	6,7	4,2	8,0	2,3				●
RS011.0200	11,0	2,00	6,7	4,2	8,0	2,3				●
RS011.0250	11,0	2,50	6,7	4,2	8,0	2,3				●
RS011.0300	11,0	3,00	6,7	4,2	8,0	2,3				●
RS014.0070	14,0	0,73	9,0	5,3	9,0	1,2				●
RS014.0080	14,0	0,83	9,0	5,3	9,0	1,3				●
RS014.0090	14,0	0,93	9,0	5,3	9,0	1,5				●
RS014.0110	14,0	1,20	9,0	5,3	9,0	4,0				●
RS014.0130	14,0	1,40	9,0	5,3	9,0	4,0				●
RS014.0160	14,0	1,70	9,0	5,3	9,0	4,0				●
RS014.0150	14,0	1,50	9,0	5,3	9,0	4,0				●
RS014.0200	14,0	2,00	9,0	5,3	9,0	4,0				●
RS014.0250	14,0	2,50	9,0	5,3	9,0	4,0				●
RS014.0300	14,0	3,00	9,0	5,3	9,0	4,0				●
RS016.0070	16,0	0,73	10,2	5,4	11,0	1,2				●
RS016.0080	16,0	0,83	10,2	5,4	11,0	1,3				●
RS016.0090	16,0	0,93	10,2	5,4	11,0	1,5				●
RS016.0110	16,0	1,20	10,2	5,4	11,0	4,3				●
RS016.0130	16,0	1,40	10,2	5,4	11,0	4,3				●
RS016.0160	16,0	1,70	10,2	5,4	11,0	4,3				●
RS016.0150	16,0	1,50	10,2	5,4	11,0	4,3				●
RS016.0200	16,0	2,00	10,2	5,4	11,0	4,3				●
RS016.0250	16,0	2,50	10,2	5,4	11,0	4,3				●
RS016.0300	16,0	3,00	10,2	5,4	11,0	4,3				●
RS016.0350	16,0	3,50	10,2	5,4	11,0	4,3				●
RS016.0400	16,0	4,00	10,2	5,4	11,0	4,3				●



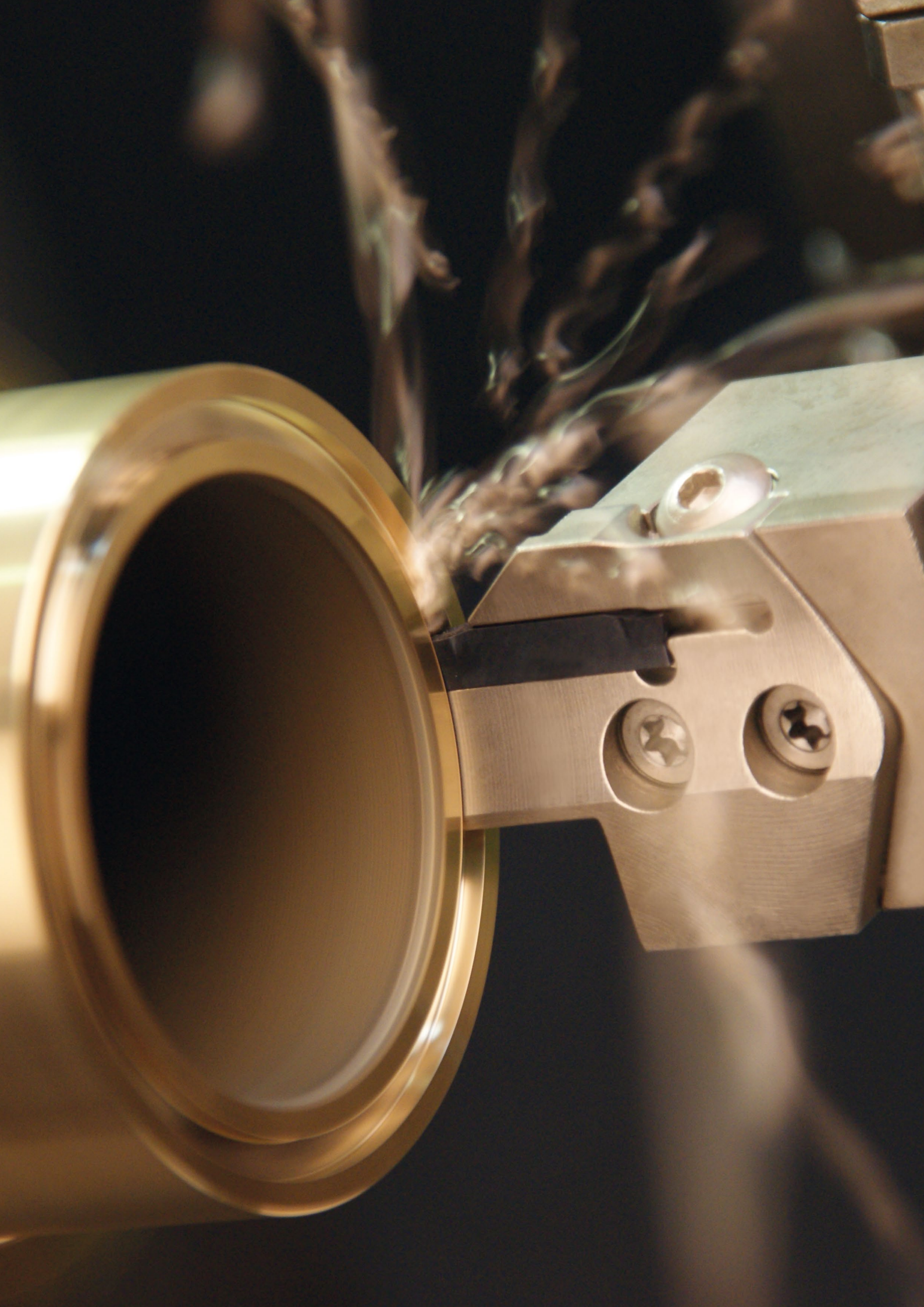



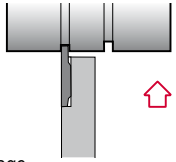
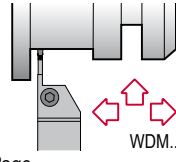
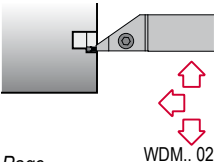
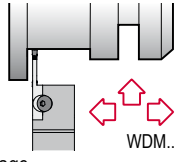
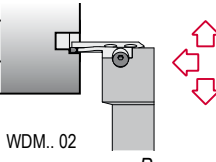
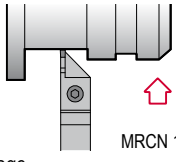
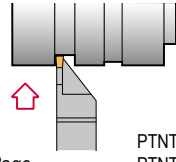

**Toolholders
Klemmhalter**

<p>STHE</p>  <p>Page Seite B18</p> <p>GL.</p>	<p>CZDP</p>  <p>Page Seite B20</p> <p>WDM.. 02 .. WDM.. 06</p>	<p>CZCD</p>  <p>Page Seite B21</p> <p>WDM.. 02 .. WDM.. 06</p>	<p>CZGD</p>  <p>Page Seite B22</p> <p>WDM.. 02 .. WDM.. 06</p>	<p>CZFD</p>  <p>WDM.. 02 .. WDM.. 06</p> <p>Page Seite B25</p>
<p>CZCB</p>  <p>Page Seite B42</p> <p>MRCN 1,6 .. MRCN 6,0</p>	<p>XLCF</p>  <p>Page Seite B43</p> <p>PTNT 02 PTNT 03 PTNT 04</p>			

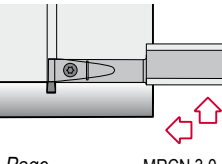
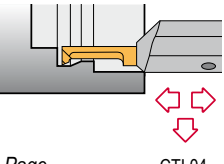
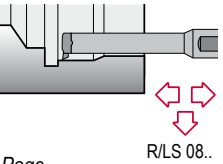
**Boring bars
Bohrstangen**

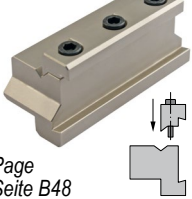
<p>CZGB</p>  <p>Page Seite B47</p> <p>MRCN 3,0 MRCN 4,0</p>	<p>00.30</p>  <p>Page Seite B44</p> <p>CTI 04.. CTI 06..</p>	<p>608.00</p>  <p>Page Seite B46</p> <p>R/LS 08.. R/LS 16..</p>	<p>CPTS</p>  <p>Page Seite B48</p>	<p>DPTS</p>  <p>Page Seite B48</p>
--	---	--	--	---

**Tool blocks
Grundhalter**

**Blades
Stechschwerter**

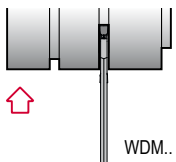
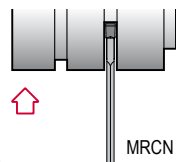
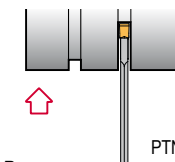
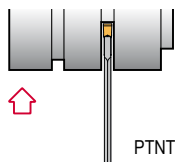
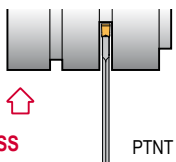
<p>CZDPN</p>  <p>Page Seite B49</p> <p>WDM.. 02 WDM.. 03 WDM.. 04</p>	<p>CRCFN</p>  <p>Page Seite B50</p> <p>MRCN 2,2 .. MRCN 6,0</p>	<p>XLCFN</p>  <p>Page Seite B51</p> <p>PTNT 02 .. PTNT 09</p>	<p>XLCTN</p>  <p>Page Seite B52</p> <p>PTNT 02 .. PTNT 06</p>	<p>XLCTN-HSS</p>  <p>HSS Page Seite B53</p> <p>PTNT 02 .. PTNT 04</p>
---	---	---	--	---

**Top Notch tools
Top Notch Werkzeuge**

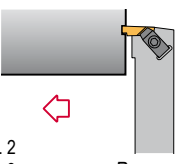
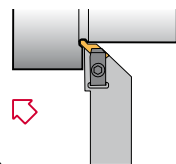
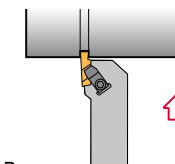
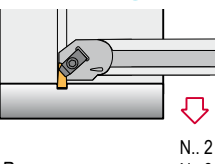
<p>NE 93°</p>  <p>N.. 2 N.. 3 N.. 4</p> <p>Page Seite B54</p>	<p>NR 45°</p>  <p>Page Seite B55</p> <p>N.. 3</p>	<p>NS 93°</p>  <p>Page Seite B56</p> <p>N.. 2 N.. 3 N.. 4</p>	<p>NNTO 93°</p>  <p>Page Seite B57</p> <p>N.. 2 N.. 3 N.. 4</p>	
---	---	---	--	--

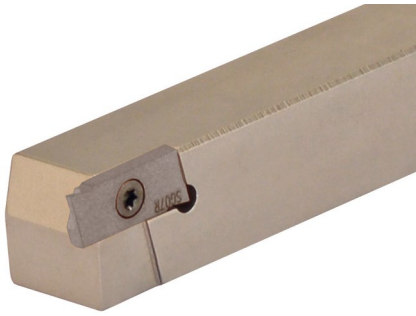

Characteristics:
Multipurpose toolholders for grooving,
threading and turning.
For precision turning.

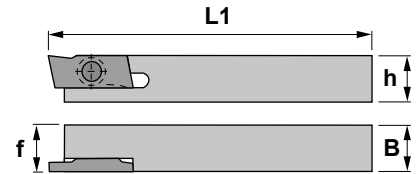

Eigenschaften:
Multifunktions-Mini-Klemhalter zum Einstechen,
Gewindedrehen und Drehen.
Zum Präzisionsdrehen.

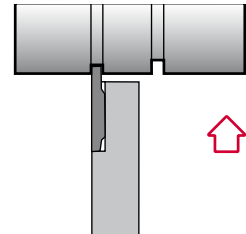

STHE

Reference Bezeichnung	h	h1	B	L	f	Insert size Wendeschneidplatte	kg
STHER/L0808M07	8	8	8	150	8	GI..	0,070
STHER/L1010M07	10	10	10	150	10	GI..	0,110
STHER/L1212M07	12	12	12	150	12	GI..	0,150
STHER/L1616M07	16	16	16	150	16	GI..	0,280

Reference Bezeichnung			Nm
STHER/L0808M07	1230	5508	1.2
STHER/L1010M07	1230	5508	1.2
STHER/L1212M07	1230	5508	1.2
STHER/L1616M07	1230	5508	1.2

GI

B06

Reference / Bez.	l	s	d
GI..	17,00	2,00	7,00

GIGP - Grooving and parting inserts / Ein- und Abstechplatten
GIGW - Threading inserts / Gewindedrehplatten
GISG - Grooving inserts / Einsteckplatten
GIST - Turning inserts / Drehplatten

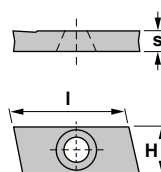

GIGP



GIGW



GISG



GIST





Grooving and parting / Ein- und Abstechen

Characteristics:

- High precision.
- Close tolerances.
- Wide variety of insert widths.

Eigenschaften:

- Hohe Genauigkeit.
- Enge Toleranzen.
- Große Auswahl an WSP-Breiten.

GIGP
Grooving and parting inserts
Ein- und Abstechplatten



GISG
Grooving inserts
Einstechplatten



Recommended starting value
Empfohlener Anfangswert

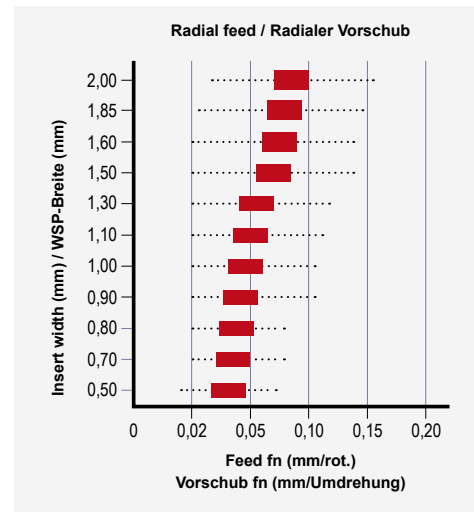

Recommended cutting conditions / Empfohlene Schnittdaten

Material Materialien	Cutting speed m/min. / Schnittgeschwindigkeit m/min.	
	TN30	
P	60-200	
M	60-180	
K	60-150	
S	20-50	

Threading / Gewindedrehen

Two types of threading:

- Partial profile 55°.
- Partial profile 60°.

Zwei Gewinde-Ausführungen:

- Teilprofil 55°.
- Teilprofil 60°.

GIGW
Threading inserts
Gewindedrehplatten

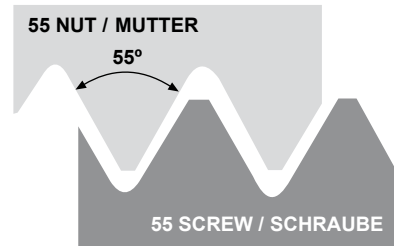
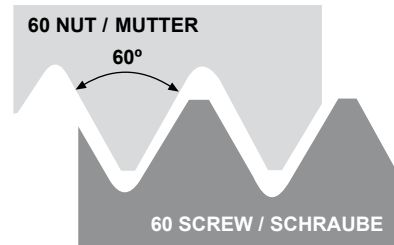

Recommended cutting conditions / Empfohlene Schnittdaten

Material Materialien	Cutting speed m/min. / Schnittgeschwindigkeit m/min.	
	TN30	
P	60-200	
M	60-180	
K	60-150	
S	20-50	

Turning / Drehen

Characteristics:

- Maximum deep of cut is 3,00 mm.
- Too low cutting speed will result in inadequate tool life and it is advisable to follow cutting speed recommendations.

Eigenschaften:

- Maximale Schnitttiefe: 3,00 mm.
- Eine zu niedrige Schnittgeschwindigkeit führt zu einer unzureichenden Standzeit. Es ist ratsam, die empfohlene Schnittgeschwindigkeiten zu verwenden.

GIST
Turning inserts
Drehplatten



Machining field
Bearbeitungsbereich

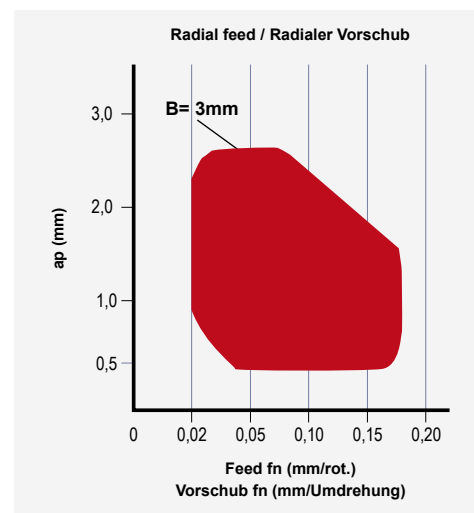

Recommended cutting conditions / Empfohlene Schnittdaten

Material Materialien	Cutting speed m/min. / Schnittgeschwindigkeit m/min.	
	TN30	
P	60-200	
M	60-180	
K	60-150	
S	20-50	



Characteristics:
Parting, grooving and face grooving toolholder that works well on steels, alloyed steels, stainless steels and refractories. Modular system for inserts with thickness from 2 to 6 mm.

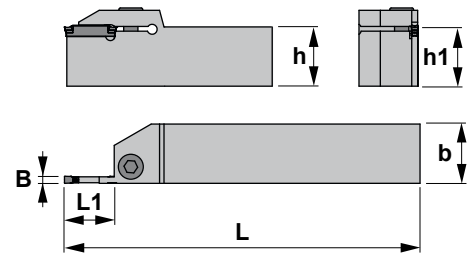

Eigenschaften:
Klemmhalter zum Ab-, Ein- und Stirnstechen. Geeignet für Stähle, legierte Stähle, rostfreie Stähle und feuerfeste Materialien. Modulares System für Wendeschneidplatten von 2 bis o 6 mm Dicke.

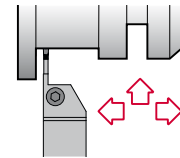

CZDP

Reference Bezeichnung	h=h1	b	L	L1	B		Nm	Insert size Wendeschneidplatte	
CZDP L 1616 H02/12	16	16	100	12	2	1916 5005	4.0	WDM.. 02	0,180
CZDP R 1616 H02/12	16	16	100	12	2	1916 5005	4.0	WDM.. 02	0,180
CZDP L 1616 H03/12	16	16	100	12	3	1916 5005	4.0	WDM.. 03	0,180
CZDP R 1616 H03/12	16	16	100	12	3	1916 5005	4.0	WDM.. 03	0,180
CZDP L 1616 H03/20	16	16	100	20	3	1916 5005	4.0	WDM.. 03	0,170
CZDP R 1616 H03/20	16	16	100	20	3	1916 5005	4.0	WDM.. 03	0,170
CZDP L 2020 K03/12	20	20	125	12	3	1906 5005	4.0	WDM.. 03	0,370
CZDP R 2020 K03/12	20	20	125	12	3	1906 5005	4.0	WDM.. 03	0,370
CZDP L 2020 K03/20	20	20	125	20	3	1906 5005	4.0	WDM.. 03	0,350
CZDP R 2020 K03/20	20	20	125	20	3	1906 5005	4.0	WDM.. 03	0,350
CZDP L 2020 K04/12	20	20	125	12	4	1906 5005	4.0	WDM.. 04	0,370
CZDP R 2020 K04/12	20	20	125	12	4	1906 5005	4.0	WDM.. 04	0,370
CZDP L 2020 K04/20	20	20	125	20	4	1906 5005	4.0	WDM.. 04	0,350
CZDP R 2020 K04/20	20	20	125	20	4	1906 5005	4.0	WDM.. 04	0,350
CZDP L 2525 M03/12	25	25	150	12	3	1906 5005	4.0	WDM.. 03	0,680
CZDP R 2525 M03/12	25	25	150	12	3	1906 5005	4.0	WDM.. 03	0,680
CZDP L 2525 M03/20	25	25	150	20	3	1906 5005	4.0	WDM.. 03	0,650
CZDP R 2525 M03/20	25	25	150	20	3	1906 5005	4.0	WDM.. 03	0,650
CZDP L 2525 M04/12	25	25	150	12	4	1906 5005	4.0	WDM.. 04	0,680
CZDP R 2525 M04/12	25	25	150	12	4	1906 5005	4.0	WDM.. 04	0,680
CZDP L 2525 M04/20	25	25	150	20	4	1906 5005	4.0	WDM.. 04	0,650
CZDP R 2525 M04/20	25	25	150	20	4	1906 5005	4.0	WDM.. 04	0,650
CZDP L 2525 M05/12	25	25	150	12	5	1906 5005	4.0	WDM.. 05	0,680
CZDP R 2525 M05/12	25	25	150	12	5	1906 5005	4.0	WDM.. 05	0,680
CZDP L 2525 M05/22	25	25	150	22	5	1906 5005	4.0	WDM.. 05	0,650
CZDP R 2525 M05/22	25	25	150	22	5	1906 5005	4.0	WDM.. 05	0,650
CZDP L 2525 M06/22	25	25	150	22	6	1906 5005	4.0	WDM.. 06	0,650
CZDP R 2525 M06/22	25	25	150	22	6	1906 5005	4.0	WDM.. 06	0,650

WDM..



Reference / Bez.	s
WDM.. 02	2,0
WDM.. 03	3,0
WDM.. 04	4,0
WDM.. 05	5,0
WDM.. 06	6,0

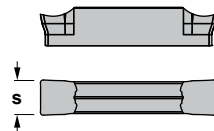

WDMG: Insert for grooving.
WDMP: Insert for parting.
WDMR: Insert for parting with radius.
WDMT: Insert for turning.
WDMG: Wendeschneidplatte zum Einstechen.
WDMP: Wendeschneidplatte zum Abstechen.
WDMR: Wendeschneidplatte zum Vollradius-Stechen.
WDMT: Wendeschneidplatte zum Drehen.

WDMG



WDMP



WDMR



WDMT





Characteristics:
Parting, grooving and side turning toolholder that works well on steels, alloyed steels, stainless steels and refractories.
Double-ended inserts with thickness from 2 to 6 mm.

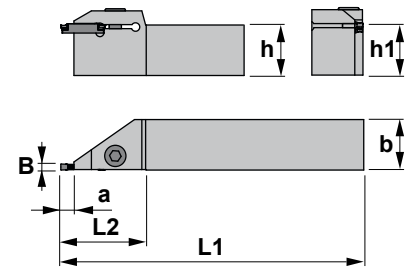

Eigenschaften:
Klemmhalter zum Ab- und Einstechen und Längsdrehen. Geeignet für Stähle, legierte Stähle, rostfreie Stähle und feuerfeste Materialien.
Zweiseitige Wendeschneidplatten von 2 bis 6 mm Dicke.

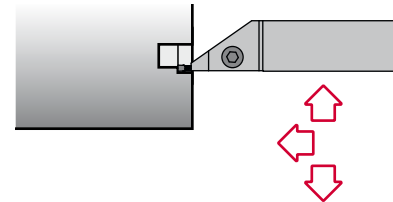

CZCD

Reference Bezeichnung	h	b	L1	L2	h1	B	a	Insert size Wendeschneidplatte	KG
CZCD L 1616 H23	16	16	100	30	16	2-3	5	WDM.. 02-03	0,190
CZCD R 1616 H23	16	16	100	30	16	2-3	5	WDM.. 02-03	0,190
CZCD L 2020 K23	20	20	125	32	20	2-3	5	WDM.. 02-03	0,360
CZCD R 2020 K23	20	20	125	32	20	2-3	5	WDM.. 02-03	0,360
CZCD L 2020 K46	20	20	125	32	20	4-6	6	WDM.. 04-06	0,360
CZCD R 2020 K46	20	20	125	32	20	4-6	6	WDM.. 04-06	0,360
CZCD L 2525 M46	25	25	150	34	25	4-6	6	WDM.. 04-06	0,660
CZCD R 2525 M46	25	25	150	34	25	4-6	6	WDM.. 04-06	0,660

Reference Bezeichnung			Nm
CZCD L 1616 H23	1916	5005	4.0
CZCD R 1616 H23	1916	5005	4.0
CZCD L 2020 K23	1906	5005	4.0
CZCD R 2020 K23	1906	5005	4.0
CZCD L 2020 K46	1906	5005	4.0
CZCD R 2020 K46	1906	5005	4.0
CZCD L 2525 M46	1906	5005	4.0
CZCD R 2525 M46	1906	5005	4.0

WDM..

 B07

Reference / Bez.	s
WDM.. 02	2,0
WDM.. 03	3,0
WDM.. 04	4,0
WDM.. 05	5,0
WDM.. 06	6,0

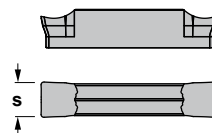

WDMG: Insert for grooving.
WDMP: Insert for parting.
WDMR: Insert for parting with radius.
WDMT: Insert for turning.
WDMG: Wendeschneidplatte zum Einstechen.
WDMP: Wendeschneidplatte zum Abstechen.
WDMR: Wendeschneidplatte zum Vollradius-Stechen.
WDMT: Wendeschneidplatte zum Drehen.

WDMG

WDMP



WDMR

WDMT



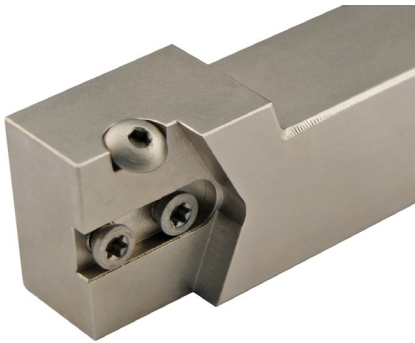

Characteristics:
Parting, grooving and side turning toolholder that works well on steels, alloyed steels, stainless steels and refractories.
Double-ended inserts with thickness from 2 to 6 mm.

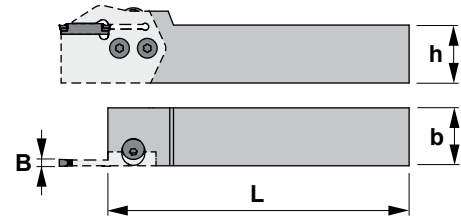



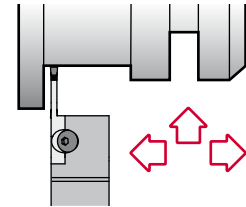

Eigenschaften:
Klemhalter zum Ab- und Einstechen und Längsdrehen. Geeignet für Stähle, legierte Stähle, rostfreie Stähle und feuerfeste Materialien.
Zweiseitige Wendeschneidplatten von 2 bis 6 mm Dicke.



CZGD

Reference Bezeichnung	h	b	L	B	kg
CZGD L 2020 K26	20	20	125	2-6	0,310
CZGD R 2020 K26	20	20	125	2-6	0,310
CZGD L 2525 M26	25	25	150	2-6	0,610
CZGD R 2525 M26	25	25	150	2-6	0,610
CZGD L 3232 P26	32	32	175	2-6	1,300
CZGD R 3232 P26	32	32	175	2-6	1,300

Reference Bezeichnung					Nm
CZGD L 2020 K26	1815	1450	5003	5520	3.0
CZGD R 2020 K26	1815	1450	5003	5520	3.0
CZGD L 2525 M26	1815	1450	5003	5520	3.0
CZGD R 2525 M26	1815	1450	5003	5520	3.0
CZGD L 3232 P26	1815	1450	5003	5520	3.0
CZGD R 3232 P26	1815	1450	5003	5520	3.0

Modular blades / Modulare Stechschwerter CZFD

WDM.. 02
WDM.. 03
WDM.. 04
WDM.. 05
WDM.. 06





CZGD

Right-handed holders use right-handed modular blades.

Auf rechten Haltern werden rechte modulare Stechschwerter montiert.

WDM.. 03
WDM.. 04
WDM.. 05
WDM.. 06





Right Hand / Rechts



Left Hand / Links

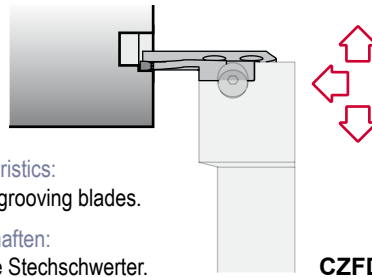
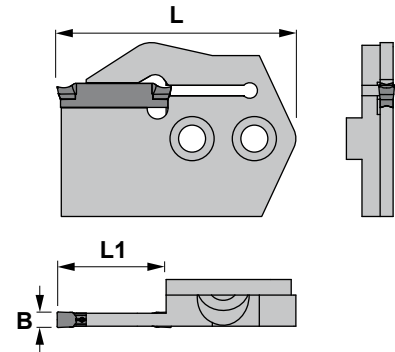

Characteristics:
Modular grooving blades.
Eigenschaften:
Modulare Stechschwerter.

CZFD

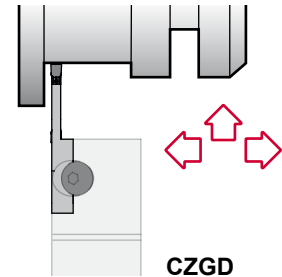

CZGD

CZFD

Reference Bezeichnung	L1	L	B	Insert size Wendeschneidplatte
CZFD L 0012-02	12	38	2	WDM.. 02
CZFD R 0012-02	12	38	2	WDM.. 02
CZFD L 0020-02	20	46	2	WDM.. 02
CZFD R 0020-02	20	46	2	WDM.. 02
CZFD L 0012-03	12	38	3	WDM.. 03
CZFD R 0012-03	12	38	3	WDM.. 03
CZFD L 0020-03	20	46	3	WDM.. 03
CZFD R 0020-03	20	46	3	WDM.. 03
CZFD L 0012-04	12	38	4	WDM.. 04
CZFD R 0012-04	12	38	4	WDM.. 04
CZFD L 0020-04	20	46	4	WDM.. 04
CZFD R 0020-04	20	46	4	WDM.. 04
CZFD L 0012-05	12	38	5	WDM.. 05
CZFD R 0012-05	12	38	5	WDM.. 05
CZFD L 0022-05	22	48	5	WDM.. 05
CZFD R 0022-05	22	48	5	WDM.. 05
CZFD L 0012-06	12	38	6	WDM.. 06
CZFD R 0012-06	12	38	6	WDM.. 06
CZFD L 0022-06	22	48	6	WDM.. 06
CZFD R 0022-06	22	48	6	WDM.. 06

WDM..



Reference / Bez.	s
WDM.. 02	2,0
WDM.. 03	3,0
WDM.. 04	4,0
WDM.. 05	5,0
WDM.. 06	6,0

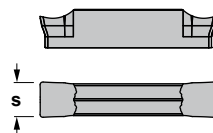

WDMG: Insert for grooving.
WDMP: Insert for parting.
WDMR: Insert for parting with radius.
WDMT: Insert for turning.
WDMG: Wendeschneidplatte zum Einstechen.
WDMP: Wendeschneidplatte zum Abstechen.
WDMR: Wendeschneidplatte zum Vollradius-Stechen.
WDMT: Wendeschneidplatte zum Drehen.

WDMG

WDMP



WDMR

WDMT





Right Hand / Rechts



Left Hand / Links

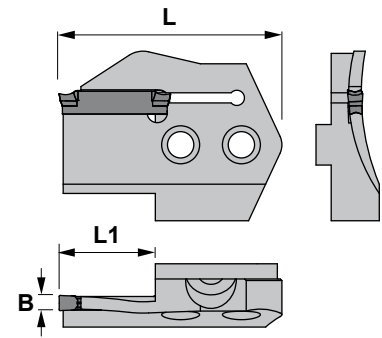

CZFD

Reference Bezeichnung	L1	L	B	Ø Range Ø Bereich	Insert size Wendeschneidplatte
CZFD L 4055-03	12	38	3	40-55	WDM.. 03
CZFD R 4055-03	12	38	3	40-55	WDM.. 03
CZFD L 5570-03	15	41	3	55-70	WDM.. 03
CZFD R 5570-03	15	41	3	55-70	WDM.. 03
CZFD L 7098-03	18	44	3	70-98	WDM.. 03
CZFD R 7098-03	18	44	3	70-98	WDM.. 03
CZFD L 90140-03	18	44	3	90-140	WDM.. 03
CZFD R 90140-03	18	44	3	90-140	WDM.. 03
CZFD L 130300-03	18	44	3	130-300	WDM.. 03
CZFD R 130300-03	18	44	3	130-300	WDM.. 03
CZFD L 300999-03	18	44	3	300-999	WDM.. 03
CZFD R 300999-03	18	44	3	300-999	WDM.. 03
CZFD L 4055-04	18	44	4	40-55	WDM.. 04
CZFD R 4055-04	18	44	4	40-55	WDM.. 04
CZFD L 5570-04	18	44	4	55-70	WDM.. 04
CZFD R 5570-04	18	44	4	55-70	WDM.. 04
CZFD L 7098-04	18	44	4	70-98	WDM.. 04
CZFD R 7098-04	18	44	4	70-98	WDM.. 04
CZFD L 90140-04	18	44	4	90-140	WDM.. 04
CZFD R 90140-04	18	44	4	90-140	WDM.. 04
CZFD L 130300-04	18	44	4	130-300	WDM.. 04
CZFD R 130300-04	18	44	4	130-300	WDM.. 04
CZFD L 300999-04	18	44	4	300-999	WDM.. 04
CZFD R 300999-04	18	44	4	300-999	WDM.. 04
CZFD L 5070-05	20	46	5	50-70	WDM.. 05
CZFD R 5070-05	20	46	5	50-70	WDM.. 05
CZFD L 7098-05	20	46	5	70-98	WDM.. 05
CZFD R 7098-05	20	46	5	70-98	WDM.. 05
CZFD L 90140-05	20	46	5	90-140	WDM.. 05
CZFD R 90140-05	20	46	5	90-140	WDM.. 05
CZFD L 130300-05	20	46	5	130-300	WDM.. 05
CZFD R 130300-05	20	46	5	130-300	WDM.. 05
CZFD L 300999-05	20	46	5	300-999	WDM.. 05
CZFD R 300999-05	20	46	5	300-999	WDM.. 05
CZFD L 5070-06	20	46	6	50-70	WDM.. 06
CZFD R 5070-06	20	46	6	50-70	WDM.. 06
CZFD L 7098-06	20	46	6	70-98	WDM.. 06
CZFD R 7098-06	20	46	6	70-98	WDM.. 06
CZFD L 90140-06	20	46	6	90-140	WDM.. 06
CZFD R 90140-06	20	46	6	90-140	WDM.. 06
CZFD L 130300-06	20	46	6	130-300	WDM.. 06
CZFD R 130300-06	20	46	6	130-300	WDM.. 06
CZFD L 300999-06	20	46	6	300-999	WDM.. 06
CZFD R 300999-06	20	46	6	300-999	WDM.. 06

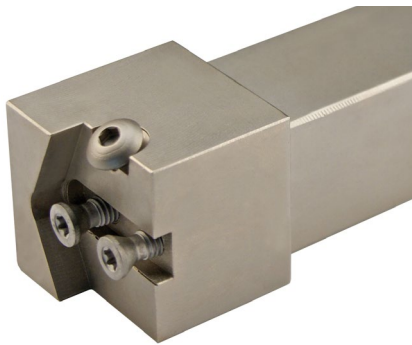

Characteristics:
Parting, grooving and face grooving toolholder that works well on steels, alloyed steels, stainless steels and refractories. Modular system for inserts with thickness from 2 to 6 mm.

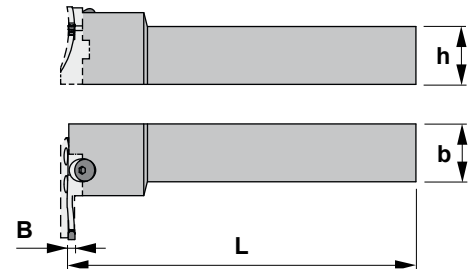



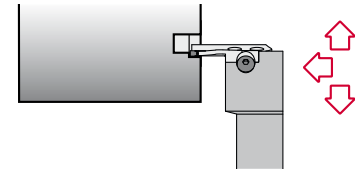

Eigenschaften:
Klemmhalter zum Ein-, Ab- und Stirnstechen. Geeignet für Stähle, legierte Stähle, rostfreie Stähle und feuerfeste Materialien. Modulares System für Wendeschneidplatten von 2 bis o 6 mm Dicke.



CZFD

Reference Bezeichnung	h	b	L	B	KG
CZFD L 2020 K26	20	20	125	2-6	0,450
CZFD R 2020 K26	20	20	125	2-6	0,450
CZFD L 2525 M26	25	25	150	2-6	0,780
CZFD R 2525 M26	25	25	150	2-6	0,780
CZFD L 3232 P26	32	32	175	2-6	1,400
CZFD R 3232 P26	32	32	175	2-6	1,400

Reference Bezeichnung					Nm
CZFD L 2020 K26	1815	1450	5003	5520	3.0
CZFD R 2020 K26	1815	1450	5003	5520	3.0
CZFD L 2525 M26	1815	1450	5003	5520	3.0
CZFD R 2525 M26	1815	1450	5003	5520	3.0
CZFD L 3232 P26	1815	1450	5003	5520	3.0
CZFD R 3232 P26	1815	1450	5003	5520	3.0

Modular blades / Modulare Stechschwerter CZFD

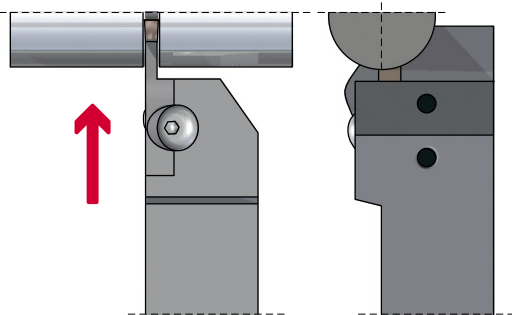
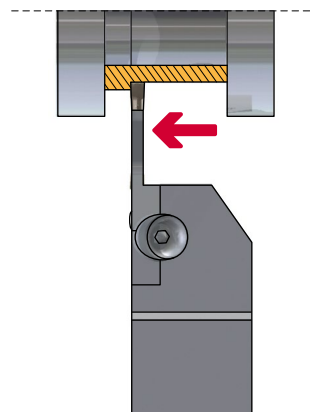
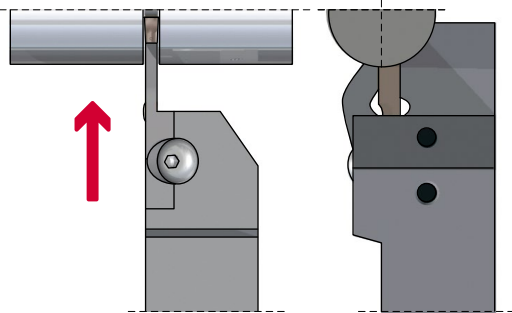
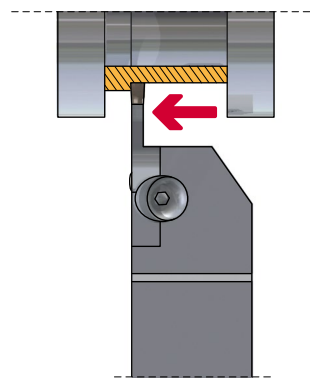

Tool selection
Werkzeugauswahl**Notes to select the tool body**
Hinweise zur Auswahl des Werkzeuges*Modular blade*
Modulares Schwert*Modular blade*
Modulares Schwert

i Select the shortest possible blade suitable for the application.

Wählen Sie das kürzeste Schwert aus, das für die Anwendung geeignet ist.

i Select the shortest possible blade suitable for the application.

Wählen Sie das kürzeste Schwert aus, das für die Anwendung geeignet ist.

Tool selection
Werkzeugauswahl

Notes for the tool setting
Hinweise zum Einsetzen des Werkzeuges

Setting of the cutting edge height
Einstellen der Schneidkantenhöhe

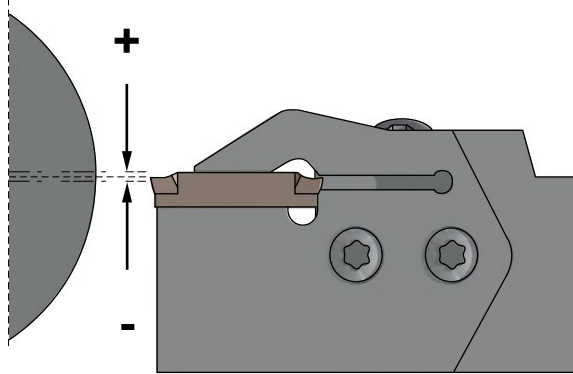

- i** <Grooving/Cross-feed machining> Set the cutting edge height to $\pm 0,1$ mm parallel to the central axis.
- <Parting> Set the cutting edge height to $0\pm 0,2$ mm parallel to the central axis.
- <Beim Einstechen> Schneidkantenhöhe auf $\pm 0,1$ mm parallel zur Mittelachse einsetzen.
- <Beim Abstechen> Schneidkantenhöhe auf $0\pm 0,2$ mm parallel zur Mittelachse einsetzen.

Tool setting angle
Einstellen des Zustellwinkels

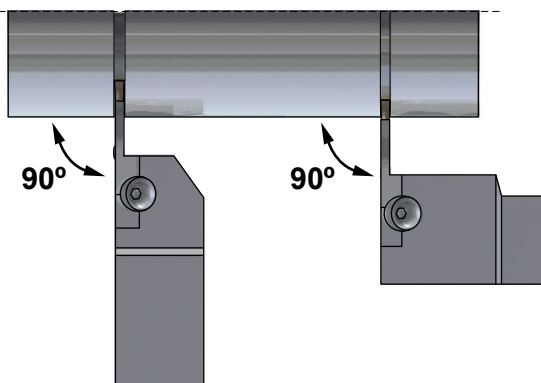

- i** Set the insert perpendicular to the central axis.
Schneidplatte senkrecht zur Mittelachse positionieren.

Overhang
Auskragung

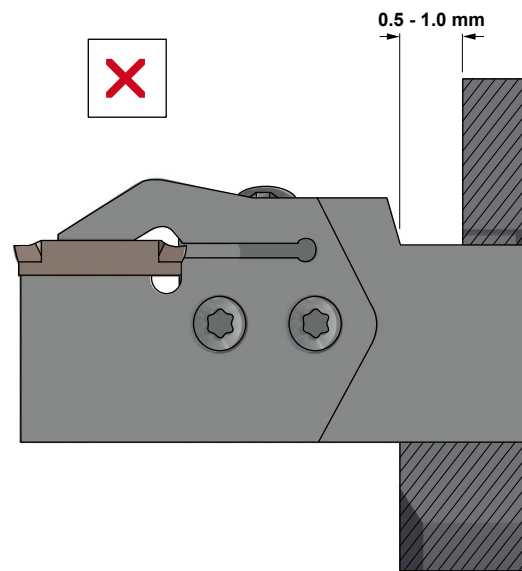
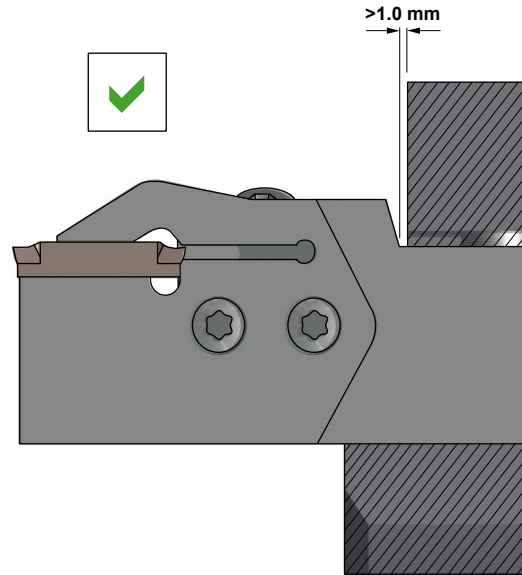

- i** When you set the tool, ensure that the overhang is as short as possible.
Achten Sie beim Einstellen des Werkzeuges darauf, dass die Auskragung so kurz wie möglich ist.



Machining recommendations Bearbeitungsempfehlungen

Notes for multi-functional machining Hinweis für Bearbeitung mit Multifunktions-Haltern

Machining of narrow grooves Bearbeitung enger Nuten

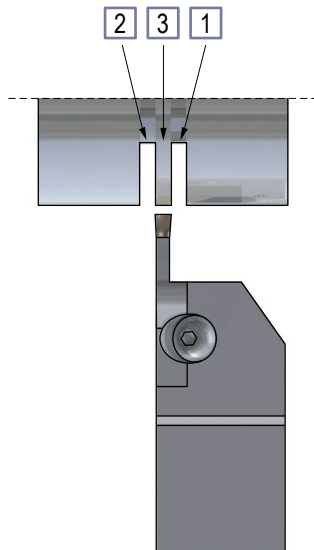

i We recommend to do the plunging in several passes. Following the above mentioned steps makes it difficult for the chips to elongate. This also improves the accuracy of the workpiece wall surface.

Wir empfehlen, das Eintauchen in mehreren Durchgängen durchzuführen, um keine langen Späne zu produzieren. Dadurch wird auch die Genauigkeit des Werkstückes verbessert.

Machining wide grooves Bearbeitung breiter Nuten

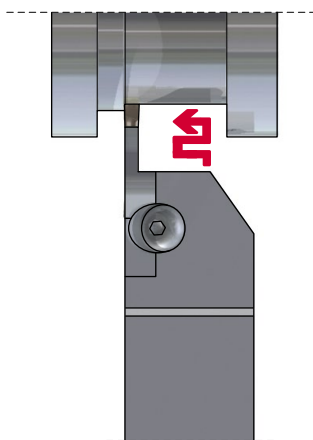

i It is recommended to use cross-feed machining. Es wird empfohlen, die Bearbeitung von breiten Nuten mit Stechdrehen durchzuführen.

Machining of wide grooves Bearbeitung breiter Nuten

ROUGHING SCHRUPPEN

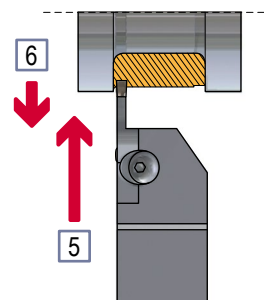
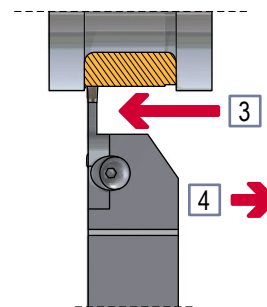
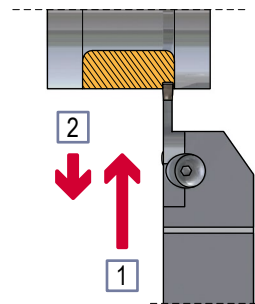

- i** 1 - Carry out grooving.
Einstechen.
2 - Retract the tool approx. 0,1 mm.
Werkzeug um ca. 0,1 mm herausziehen.
3 - Carry out cross-feed machining.
Längsdrehbearbeitung durchführen.
4 - Retract the tool approx. 0,1 mm.
Werkzeug um ca. 0,1 mm herausziehen.
5 - Carry out grooving.
Einstechen.
6 - Retract the tool approx. 0,1 mm.
Werkzeug um ca. 0,1 mm herausziehen.
* Repeat the steps 1 - 6.
* Schritte 1 - 6 wiederholen.

Machining recommendations
Bearbeitungsempfehlungen

Notes for multi-functional machining
Hinweise für multifunktionale Bearbeitung

Machining wide grooves
Bearbeitung breiter Nuten

FINISHING
SCHLICHTEN

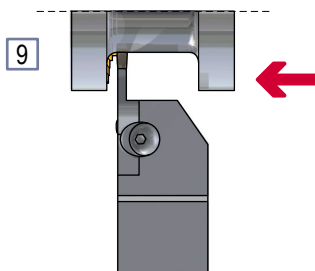
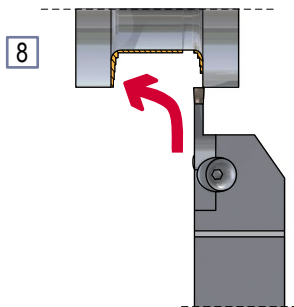
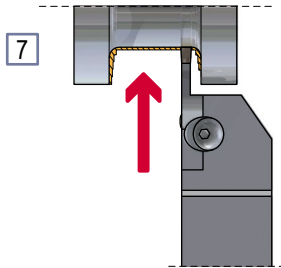

- i** 7 - Carry out grooving to the end point of the corner radius.
Einstechen bis zum Ende des Eckenradius ausführen.
- 8 - The machining of the wall surface, corner radius and bottom face must be carried out in one process.
Die Bearbeitung der Planfläche, der Konturen und der unteren Fläche sollte in einem Arbeitsgang erfolgen.
- 9 - Stop at the bottom of the corner radius.
Halten Sie am unteren Ende des Eckenradius an.

Machining wide grooves
Bearbeitung breiter Nuten

FINISHING
SCHLICHTEN

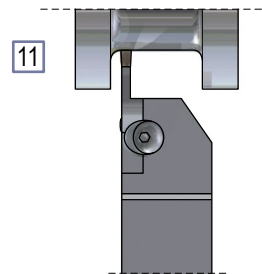
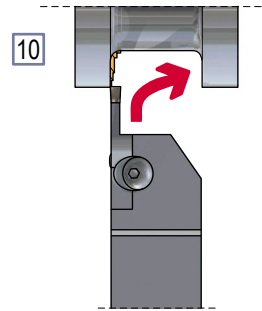

- i** 10 - Machine the counter wall to the corner radius in one process.
Bearbeiten Sie die dem Eckenradius gegenüberliegende Wand in einem Arbeitsgang.
- 11 - Finish the machining.
Beenden Sie die Bearbeitung.

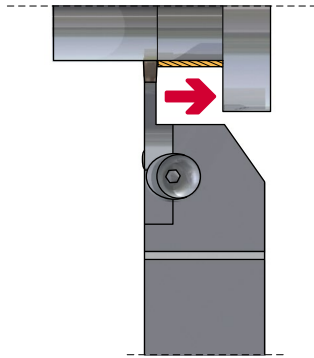
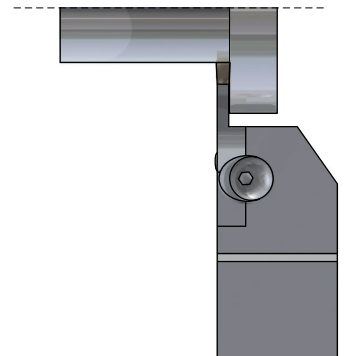
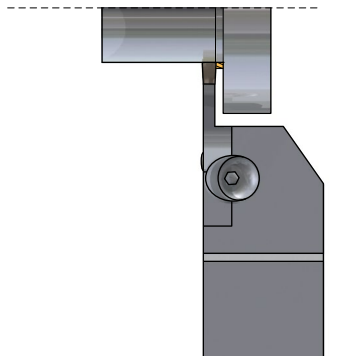
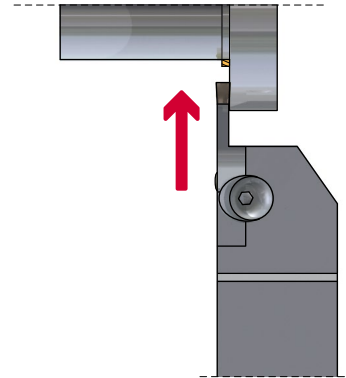

Machining recommendations
Bearbeitungsempfehlungen**Notes for multi-functional machining**
Hinweise für multifunktionale Bearbeitung*Wall machining*
Bearbeitung von Wandungen*Wall machining*
Bearbeitung von Wandungen

- i** When machining a wall, chip jamming can occur. In that case, stop the cross-feed machining just before the wall (a point less than the insert width) and then remove the remaining material by plunging.

Beim Bearbeiten von Wandungen kann Spanstau entstehen. In diesem Fall die Längsbearbeitung kurz vor der Wandung beenden (ein Punkt weniger als die Plattenbreite) und durch erneutes Einstechen fertig bearbeiten.

Machining recommendations
Bearbeitungsempfehlungen

Notes for multi-functional machining
Hinweise für multifunktionale Bearbeitung

Precautions when finishing walls
Vorsichtsmaßnahmen beim Schlichten von Wandungen

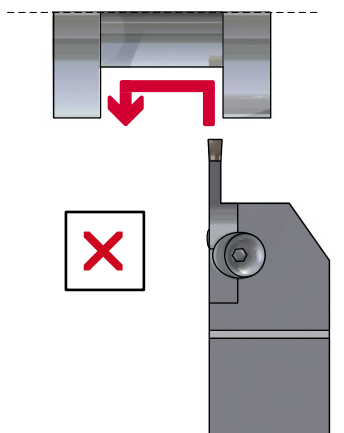
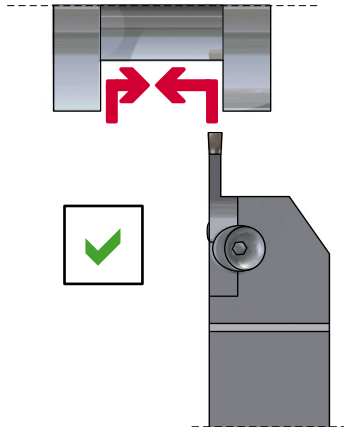

i To produce high accuracy walls using face grooving inserts, do not carry out back turning. We recommend plunging.

Zum Herstellen von Präzisionswänden mit Stechplatten nicht die Richtung umkehren. Empfohlen wird Eintauchen.

Machining of a ring
Bearbeitung von Ringen

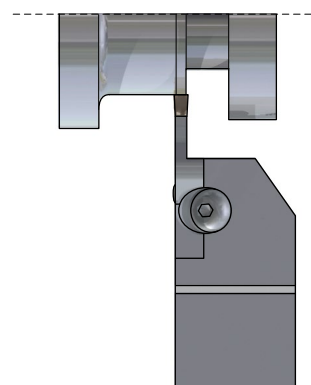
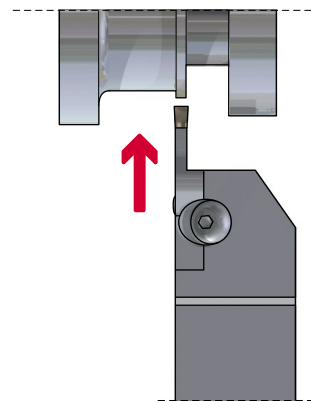
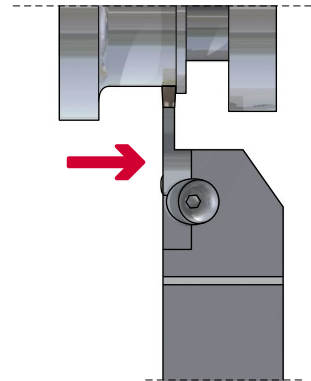

i When a ring remains in a cross-feed end process, finish the cross-feed machining 1-1,5 mm short of the end point, and then remove the ring by plunging.

Wenn sich ein Ring in einem Kreuzvorschub-Endprozess befindet, beenden Sie die Bearbeitung 1-1,5 mm kurz vor dem Endpunkt und entfernen Sie den Ring dann durch Einstechen.

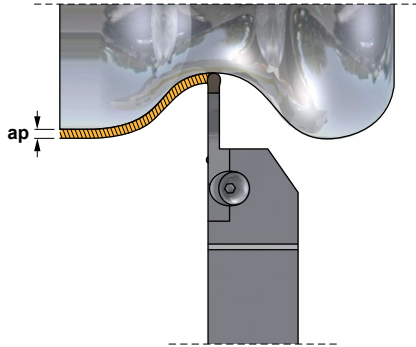

Machining recommendations
Bearbeitungsempfehlungen**Notes for multi-functional machining**
Hinweise für multifunktionale Bearbeitung**Notes for the first pass**
Hinweise für den ersten Durchgang

- i** With the face grooving ball nose insert it is possible to do tridimensional copying. Set the depth of cut (ap) to 40% less than the insert width.

Mit der Vollradius-Stechplatte ist 3D-Kopieren möglich. Die Schnitttiefe (ap) auf 40% der WSP-Breite einstellen.

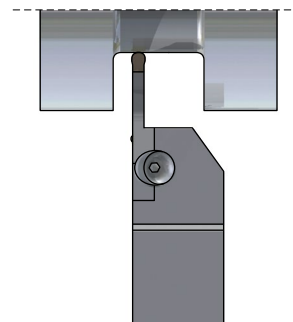
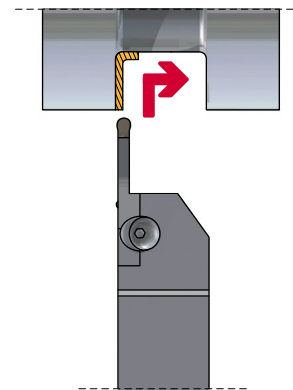
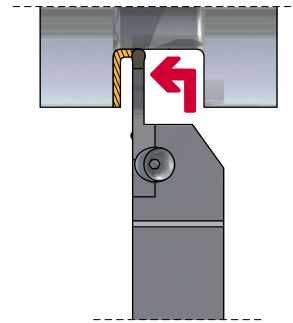
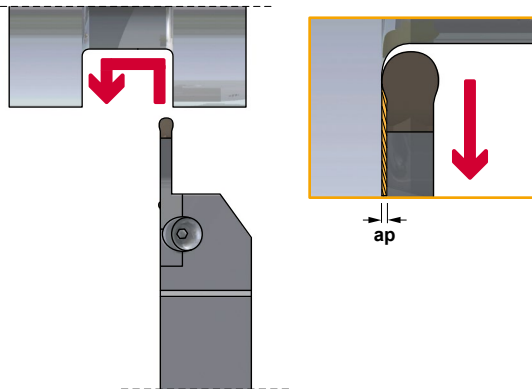
ROUGHING
SCHRUPPEN**FINISHING**
SCHLICHTEN

WDMR	ap (mm)
WDMR 03	0,10
WDMR 04	0,15
WDMR 05	0,20
WDMR 06	0,25

- i** Carry out finishing in one process. For the depth of cut (ap) when back turning, refer to the table above.

Das Schlichten in einem Vorgang ausführen. Die Schnitttiefe (ap) beim Ausstechen entnehmen Sie bitte der oberen Tabelle.

- i** Use plunging and cross-feed machining. When machining the corner, vibration is likely to occur. To avoid this, reduce the feed by 50%.

Eintauchen und Längsdrehen wird empfohlen. Den Vorschub um 50% reduzieren, um die beim Bearbeiten der Ecken möglichen Vibrationen zu dämpfen.

Machining recommendations
Bearbeitungsempfehlungen

Notes for parting
Hinweise zum Abstechen

FEED
VORSCHUB

<Feed>
<Vorschub>

Distance from the cutting edge to the workpiece centre.
Abstand zwischen Schneidkante und Mitte des Werkstücks.

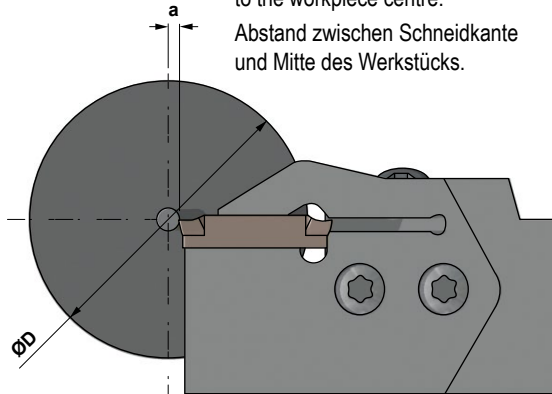

Feed f
Vorschub f

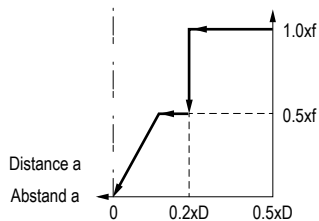

- i** - When the cutting edge approaches the centre, reduce the feed by 50%.
- If necessary, stop the feed prior to reaching the centre of the workpiece to prevent it falling under its own weight.
- Den Vorschub um 50% reduzieren, wenn die Schneidkante sich der Mitte nähert.
- Den Vorschub ggf. vor Erreichen der Werkstückmitte ausschalten, damit das Werkstück nicht unter seinem Eigengewicht einfällt

REVOLUTIONS
DREHZAHL

<Spindle speed>
<Spindeldrehzahl>

Distance from the cutting edge to the workpiece centre.
Abstand zwischen Schneidkante und Mitte des Werkstücks.

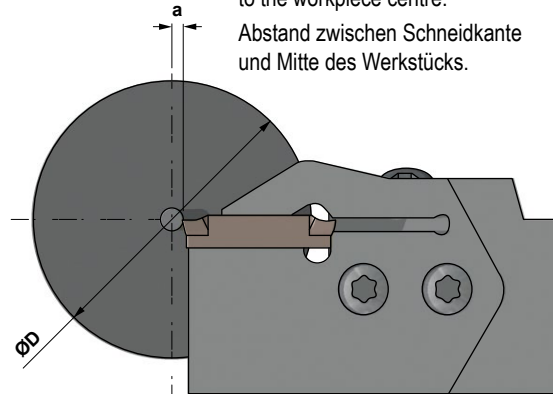

Revolutions n
Drehzahl n

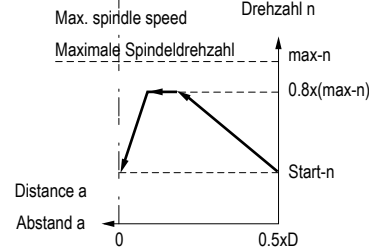

- i** If you use a constant cutting speed during a parting cycle, it is recommended to limit the spindle speed to 80% of maximum to ensure stability.
- To prevent the workpiece from being expelled, reduce the spindle speed before finishing the grooving operation.
- Bei konstanter Schnittgeschwindigkeit während eines Abstechzyklus wird empfohlen, die Spindeldrehzahl auf 80% des Maximum einzustellen, um die Stabilität sicherzustellen.
- Die Spindeldrehzahl vor Beenden des Einstechvorgangs reduzieren, um ein Wegschleudern des Werkzeuges zu verhindern.



Machining recommendations Bearbeitungsempfehlungen

Notes for face grooving Hinweise für Stirneinstechen

Notes for the first pass
Hinweise zum ersten Einstich

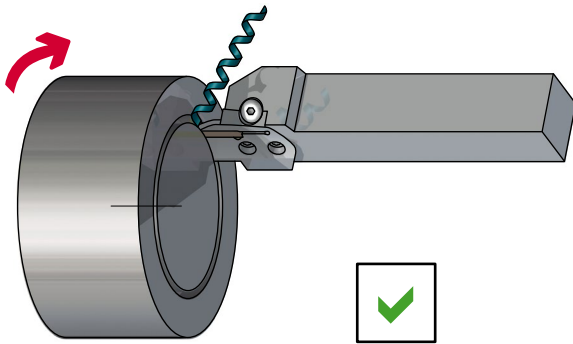

Notes for the first pass
Hinweise zum ersten Einstich

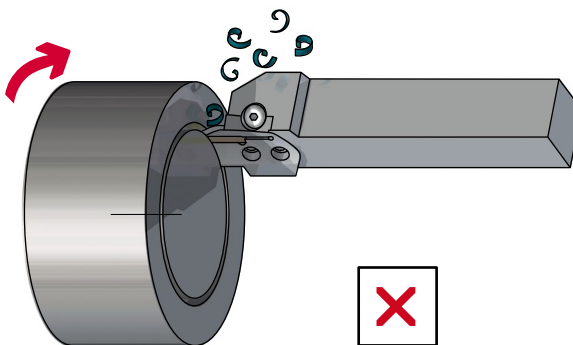
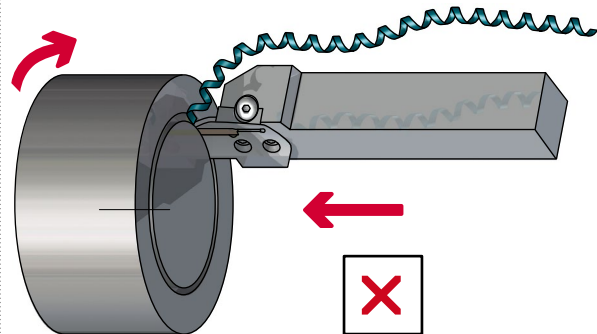
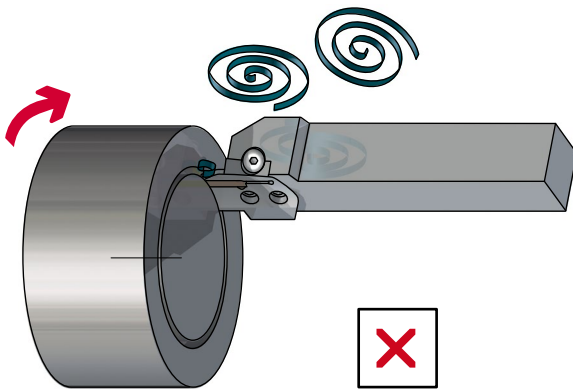
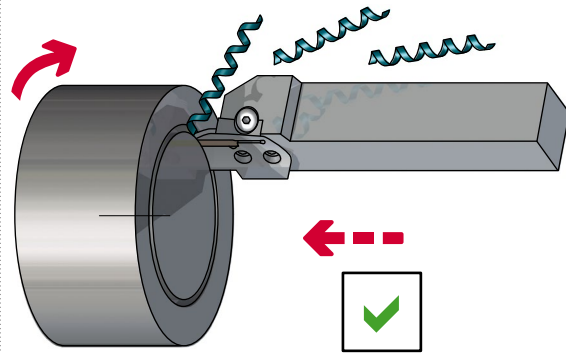

i If the chips become too long, use peck feed to break them into a suitable length.

Wenn die Späne zu lang werden, sollten Vorschubstopps programmiert werden, um die Späne in einer geeigneten Länge zu brechen.

i During the first face grooving pass it is difficult to disperse the broken chips, and that can lead to problems, such as insert wearing. Maintain longer chips that disperse easily by reducing the feed per rotation.

Beim ersten Stirneinstich ist die Spanabfuhr schwierig und dies kann zu vorzeitigem Wendepplattenverschleiß führen. Um längere Späne zu erzeugen, die einfacher entfernt werden, reduzieren Sie einfach den Vorschub.

Machining recommendations
Bearbeitungsempfehlungen

Notes for face grooving
Hinweise für Stirneinstechen

Notes for face grooving by plunging in several passes
Hinweise für Mehrfach-Stirneinstechen

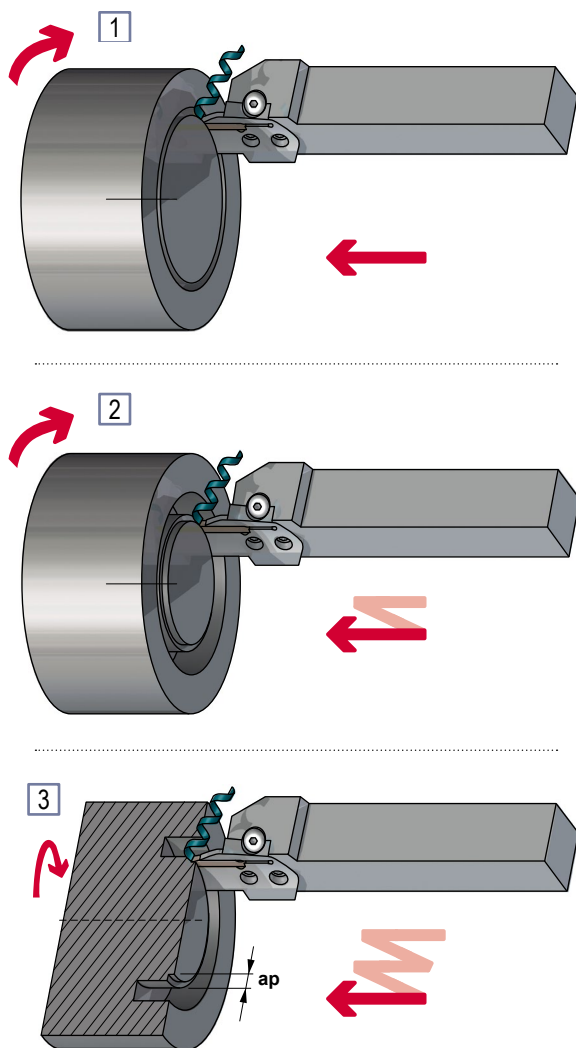

i When machining a face groove in several passes, machine from the outer diameter towards the centre, leaving space for discharging chips, and so preventing insert damage caused by chip jamming. It is recommended to set the plunging width of cut at 60-80% of the insert width. This enhances the effect of the chipbreaker by enlarging the width of the groove to improve chip dispersal.

Beim Mehrfach-Stirneinstechen bearbeiten Sie das Werkstück von außen nach innen, um eine gute Spanabfuhr zu gewährleisten und die Schneidplatte vor Bruch durch Spänestau zu schützen.

Setzen Sie die Einstichbreite auf 60-80% der Schneidplattenbreite. Dies verbessert die Wirkung des Spanbrechers und die Spanentfernung ist einfacher.

Notes for face grooving by combination of plunging and traverse machining
Hinweise für das Kombinieren von Stirneinstechen mit Stechdrehen

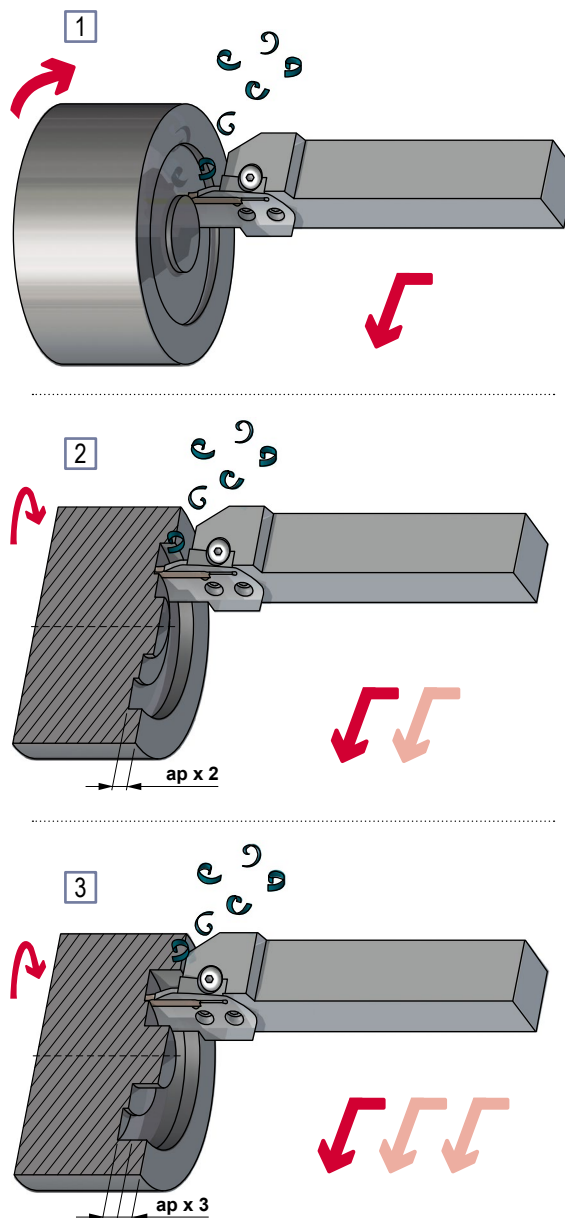

i When face grooving by using plunge feed and traverse machining, always machine from the outer diameter towards the centre to disperse the chips outwards in order to avoid chip jamming problems. Set the depth of cut within 40% of the insert width.

Beim Stirneinstechen und Stechdrehen bearbeiten Sie das Werkstück von außen nach innen, um eine gute Spanabfuhr zu gewährleisten.

Stellen Sie die axiale Schnitttiefe innerhalb 40% der Schneidplattenbreite ein.



Machining recommendations Bearbeitungsempfehlungen

Notes for face grooving Hinweise für Stirneinstechen

Notes for face grooving by
combination of plunging and traverse machining
Hinweise für das Kombinieren von
Stirneinstechen mit Stechdrehen

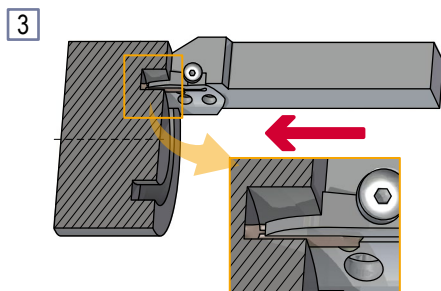
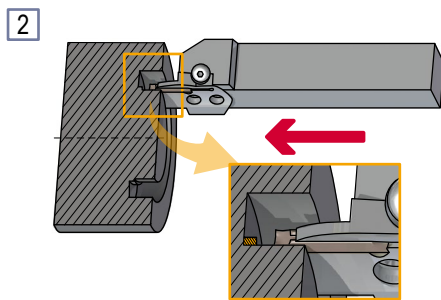
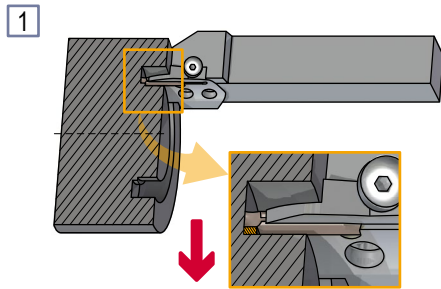

- i** When infeed machining at the bottom of a deep groove, chips may interfere on the cutting edge near the centre wall. In such cases, stop infeed machining just before the centre wall (at a point less than the insert width) and then remove the remaining material by plunging.

Beim Stirneinstechen von tiefen Nuten kann es bei Wandungen zu Spänestau kommen. In diesem Fall stoppen Sie kurz vor der Wandung die Bearbeitung (einen Punkt weniger als die Plattenbreite) und entfernen Sie das Restmaterial durch Stirneinstechen.

Finishing
Schlichten

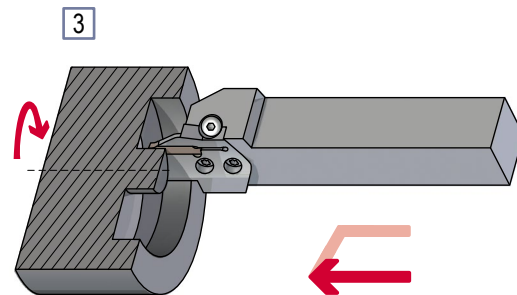
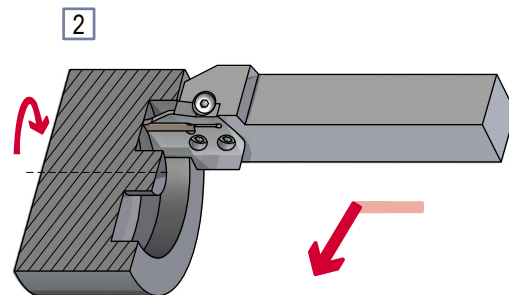
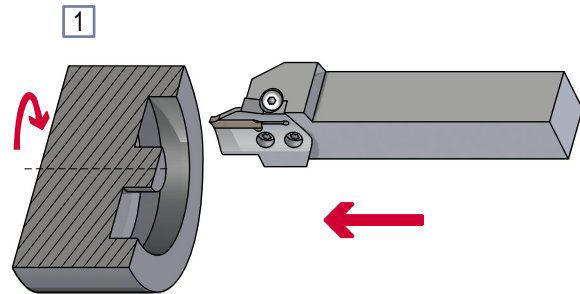

- i** When you finish cutting, machine continuously from the outer wall to the bottom of the groove, then finally plunge cut the centre wall.

Beim Schlichten bearbeiten Sie bitte das Werkstück ununterbrochen bis zur unteren Fläche, abschließend schlichten Sie den inneren Durchmesser durch Stirneinstechen.

Machining recommendations
Bearbeitungsempfehlungen

Notes for face grooving
Hinweise für Stirneinstechen

Notes for the copying with a ball nose insert
Hinweise für das axiale Kopieren
mit Vollradiusplatten

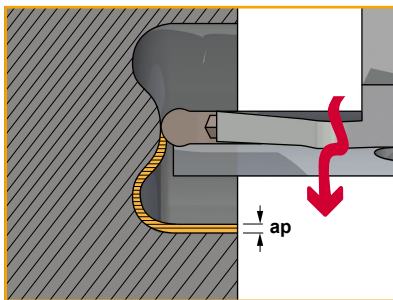
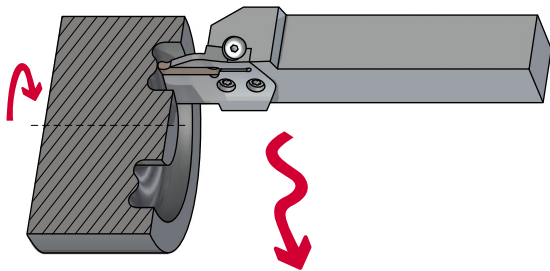

- i** With the ball nose insert it is possible to do tridimensional copying. Set the depth of cut (a_p) to 30% less than the insert width.
- Mit der Vollradius-Schneidplatte ist 3D-Kopieren möglich. Die Schnitttiefe (a_p) auf 30% der WSP-Breite einstellen.

Finishing with a ball nose insert
Schlichten mit Vollradiusplatten

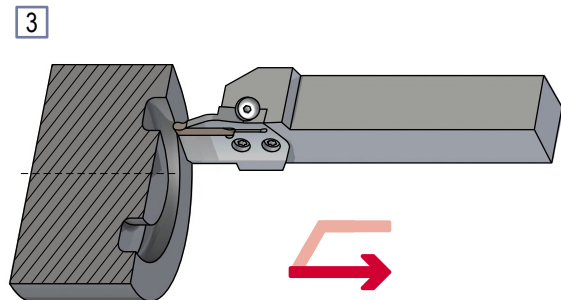
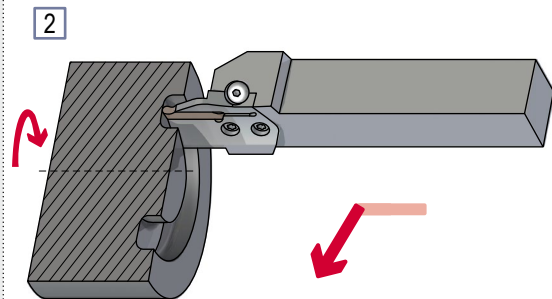
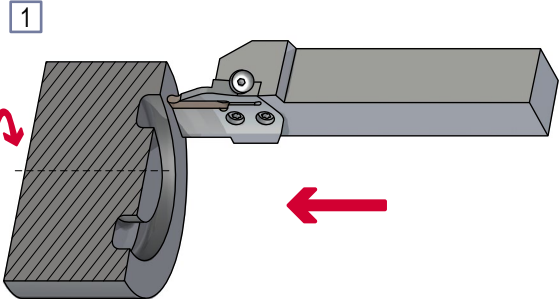

WDMR	a_p (mm)
WDMR 03	0,10
WDMR 04	0,15
WDMR 05	0,20
WDMR 06	0,25

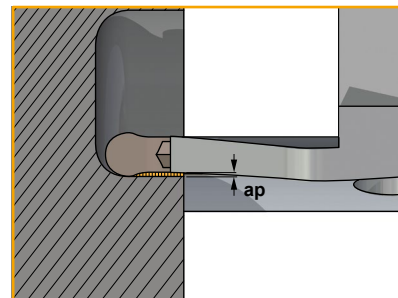

- i** Carry out finishing in one process. For the depth of cut (a_p) when back turning, refer to the table above.
- Die Feinbearbeitung in einem Vorgang ausführen. Die Schnitttiefe (a_p) beim Ausstechen entnehmen Sie bitte der oberen Tabelle.

**Nominal cutting speed and feed values for parting and grooving
Nennschnittgeschwindigkeit und Vorschub-Werte für Ab- und Einstechdrehen**



WDMG Medium cutting geometry

- Insert with narrow negative chamfer.
- Suitable for all steel materials with high strength.
- Suitable for all applications.
- For steel and grey cast iron.

WDMG Mittlere Schneidengeometrie

- Wendepplatten mit engen negativen Fasen.
- Geeignet für alle hochfesten Stähle.
- Geeignet für alle Anwendungen.
- Für Stahl und Grauguß.

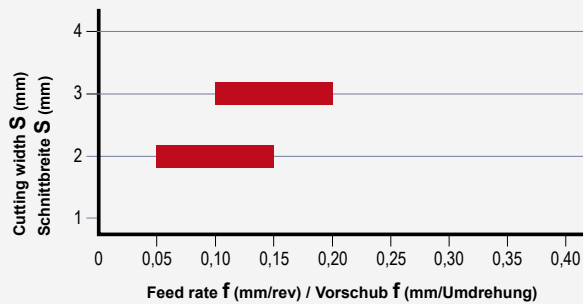
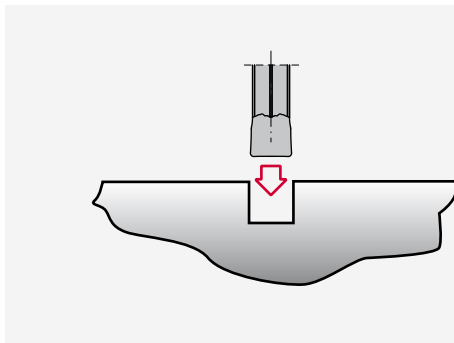

Material Materialien	P	HB	Condition Beschaffenheit	Cutting speed / Schnittgeschwindigkeit m/min.	
				TL30	Vc (m/min)
Unalloyed steel Unlegierter Stahl		150-250	C= 0,15% - 0,45% C	80	180
Low alloyed steel Niedriglegierter Stahl		250-300	Tempered Gehärtet	60	150
High alloyed steel Hochlegierter Stahl		350	Tempered Gehärtet	50	120
Corrosion resistant steel Korrosionsbeständiger Stahl		200	Annealed Geglüht	50	200

Material Materialien	K	HB	Condition Beschaffenheit	Cutting speed / Schnittgeschwindigkeit m/min.	
				TL30	Vc (m/min)
Grey cast iron Grauguß		180		100	200
Spheroidal graphite Sphäroguß		160		100	180
Malleable cast iron Temperguß		130	Ferritic Ferritisch	80	160



Nominal cutting speed and feed values for parting and grooving
Nennschnittgeschwindigkeit und Vorschub-Werte für Ab- und Einstechdrehen



WDMP Soft cutting geometry

- Especially for stainless steel.
- Problem solver for steel machining.

WDMP Weiche Schneidengeometrie

- Hauptsächlich für rostfreien Stahl.
- Problemlöser für Stahlbearbeitung.

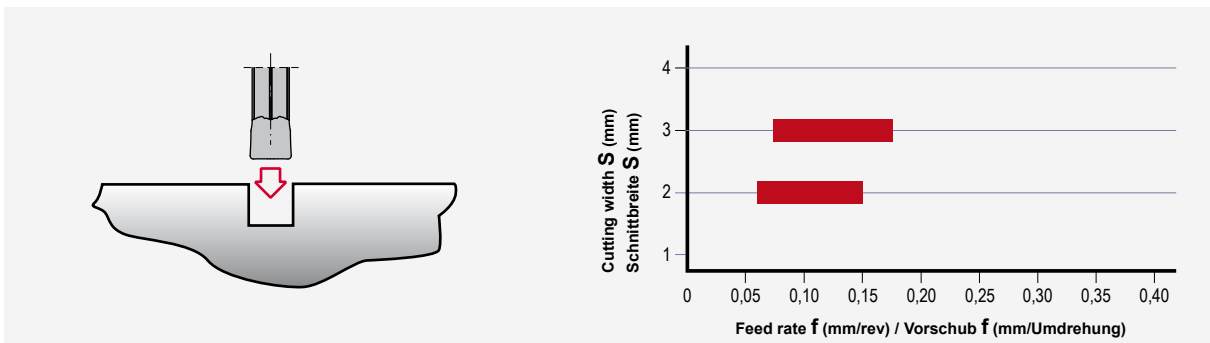

Material Materialien	M	HB	Condition Beschaffenheit	Cutting speed / Schnittgeschwindigkeit m/min.	
				TL30	Vc (m/min)
Stainless steel Rostfreier Stahl		200	Annealed ferritic / Geglüht ferritisch	50	200
		180	Quenched austenitic / Abgeschreckt austenitisch	50	180
		230-260	Quenched duplex / Abgeschreckt Duplex	50	100
		330	Hardened martensitic / Gehärtet martensitisch	50	80

Nominal cutting speed and feed values for parting and grooving Nennschnittgeschwindigkeit und Vorschub-Werte für Ab- und Einstechdrehen

WDMR



WDMR Radius grooves

- Insert for radius grooves.
- For copy turning.
- Suitable for all steel and cast iron materials.

WDMR Radiusnuten

- Wendepplatten für Radiusnuten.
- Zum Profildrehen.
- Geeignet für alle Stahl- und Gußwerkstoffe.

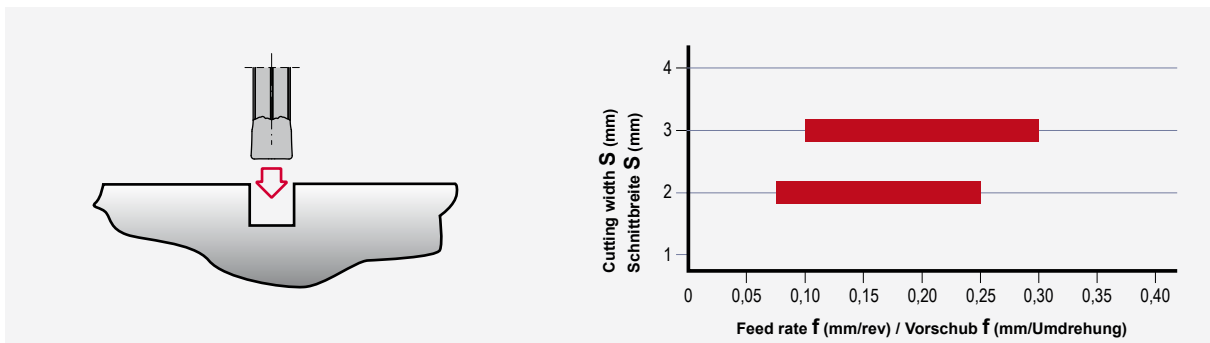

Material Materialien	P	HB	Condition Beschaffenheit	Cutting speed / Schnittgeschwindigkeit m/min.	
				TL30	Vc (m/min)
Unalloyed steel Unlegierter Stahl		150-250	C= 0,15% - 0,45% C	80	180
Low alloyed steel Niedriglegierter Stahl		250-300	Tempered Gehärtet	60	150
High alloyed steel Hochlegierter Stahl		350	Tempered Gehärtet	50	120
Corrosion resistant steel Korrosionsbeständiger Stahl		200	Annealed Geglüht	50	200
Material Materialien	M	HB	Condition Beschaffenheit	Cutting speed / Schnittgeschwindigkeit m/min.	
				TL30	Vc (m/min)
Stainless steel Rostfreier Stahl		200	Annealed ferritic / Geglüht ferritisch	50	200
		180	Quenched austenitic / Abgeschreckt austenitisch	50	180
		230-260	Quenched duplex / Abgeschreckt Duplex	50	100
		330	Hardened martensitic / Gehärtet martensitisch	50	80
Material Materialien	K	HB	Condition Beschaffenheit	Cutting speed / Schnittgeschwindigkeit m/min.	
				TL30	Vc (m/min)
Grey cast iron Grauguß		180		100	200
Spheroidal graphite Sphäroguß		160		100	180
Malleable cast iron Temperguß		130	Ferritic Ferritisch	80	160



Nominal cutting speed and feed values for parting and grooving
Nennschnittgeschwindigkeit und Vorschub-Werte für Ab- und Einstechdrehen



WDMT Grooving and Turning

- For grooving and turning.
- Suitable for all steel and stainless steel materials.
- Very good chip control.

WDMT Einstechen und Drehen

- Zum Einstechen und Drehen.
- Geeignet für alle Stahl- und rostfreien Stahlwerkstoffe.
- Sehr gute Spankontrolle.

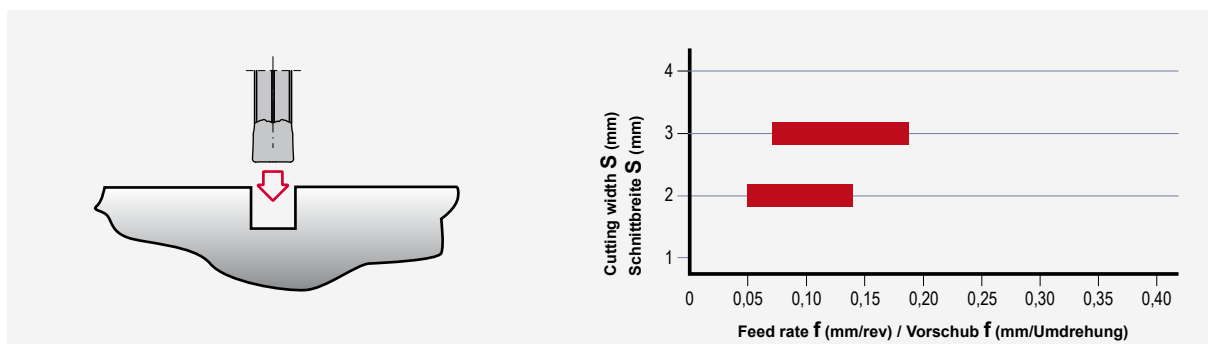

Material Materialien	P	HB	Condition Beschaffenheit	Cutting speed / Schnittgeschwindigkeit m/min.	
				TL30	Vc (m/min)
Unalloyed steel Unlegierter Stahl		150-250	C= 0,15% - 0,45% C	80	180
Low alloyed steel Niedriglegierter Stahl		250-300	Tempered Gehärtet	60	150
High alloyed steel Hochlegierter Stahl		350	Tempered Gehärtet	50	120
Corrosion resistant steel Korrosionsbeständiger Stahl		200	Annealed Geglüht	50	200
Material Materialien	M	HB	Condition Beschaffenheit	Cutting speed / Schnittgeschwindigkeit m/min.	
				TL30	Vc (m/min)
Stainless steel Rostfreier Stahl		200	Annealed ferritic / Geglüht ferritisch	50	200
		180	Quenched austenitic / Abgeschreckt austenitisch	50	180
		230-260	Quenched duplex / Abgeschreckt Duplex	50	100
		330	Hardened martensitic / Gehärtet martensitisch	50	80
Material Materialien	K	HB	Condition Beschaffenheit	Cutting speed / Schnittgeschwindigkeit m/min.	
				TL30	Vc (m/min)
Grey cast iron Grauguß		180		100	200
Spheroidal graphite Sphäroguß		160		100	180
Malleable cast iron Temperguß		130	Ferritic Ferritisch	80	160



Characteristics:

Parting, grooving and side turning toolholder that works well on steels, alloyed steels, stainless steels and refractories. Single-ended inserts with thickness from 1,6 to 6 mm.

Eigenschaften:

Klemmhalter zum Ein- und Abstechen und Längsdrehen. Geeignet für Stähle, legierte Stähle, rostfreie Stähle und feuerfeste Materialien. Einseitige Wendeschneidplatte von 1,6 bis 6 mm Dicke.

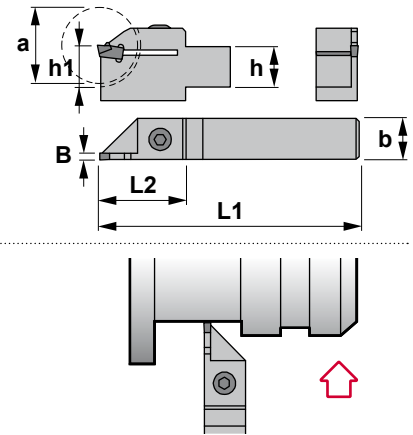

CZCB

Reference Bezeichnung	h	b	L1	L2	h1	B	a	Insert size Wendeschneidplatte	KG
CZCB R/L 1010 J01	10	10	110	25	10	1,6	22	MRCN 1,6	0,080
CZCB R/L 1010 J02	10	10	110	25	10	2,2	22	MRCN 2,2	0,080
CZCB R/L 1212 J01	12	12	110	26	12	1,6	22	MRCN 1,6	0,100
CZCB R/L 1212 J02	12	12	110	26	12	2,2	22	MRCN 2,2	0,100
CZCB R/L 1616 J02	16	16	110	30	16	2,2	32	MRCN 2,2	0,150
CZCB R/L 1616 J03	16	16	110	30	16	3,0	32	MRCN 3,0	0,150
CZCB R/L 2020 K03	20	20	125	36	20	3,0	42	MRCN 3,0	0,350
CZCB R/L 2020 K04	20	20	125	36	20	4,0	42	MRCN 4,0	0,350
CZCB R/L 2020 K05	20	20	125	36	20	5,0	42	MRCN 5,0	0,350
CZCB R/L 2020 K06	20	20	125	36	20	6,0	42	MRCN 6,0	0,350
CZCB R/L 2525 M03	25	25	150	50	25	3,0	60	MRCN 3,0	0,550
CZCB R/L 2525 M04	25	25	150	50	25	4,0	60	MRCN 4,0	0,550
CZCB R/L 2525 M05	25	25	150	50	25	5,0	60	MRCN 5,0	0,550
CZCB R/L 2525 M06	25	25	150	50	25	6,0	60	MRCN 6,0	0,550

Reference Bezeichnung		
CZCB R/L 1010 J01		1905
CZCB R/L 1010 J02		1905
CZCB R/L 1212 J01		1905
CZCB R/L 1212 J02		1905
CZCB R/L 1616 J02		1916
CZCB R/L 1616 J03		1916
CZCB R/L 2020 K03		1906
CZCB R/L 2020 K04		1906
CZCB R/L 2020 K05		1906
CZCB R/L 2020 K06		1906
CZCB R/L 2525 M03		1906
CZCB R/L 2525 M04		1906
CZCB R/L 2525 M05		1906
CZCB R/L 2525 M06		1906

MRCN

Single-ended insert for parting and grooving. Einseitige Wendeschneidplatte zum Ab- und Einstechen.  B08

Reference / Bez.	s	r
MRCN 1,6	1,6	0,15
MRCN 2,2	2,2	0,20
MRCN 3,0	3,0	0,20
MRCN 4,0	4,0	0,20
MRCN 5,0	5,0	0,30
MRCN 6,0	6,0	0,40

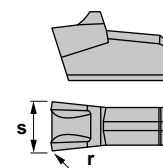

MRCN



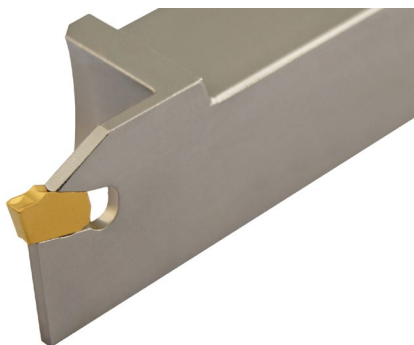

Characteristics:

Parting and grooving toolholder that works well on steels, alloyed steels, stainless steels and refractories.

Single-ended inserts with thickness from 2 to 4 mm.

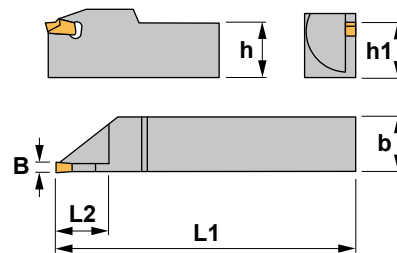

Eigenschaften:

Klemmhalter zum Ab- und Einstechen. Geeignet für Stähle, legierte Stähle, rostfreie Stähle und feuerfeste Materialien.

Einseitige Wendeschneidplatte von 2 bis 4 mm Dicke.

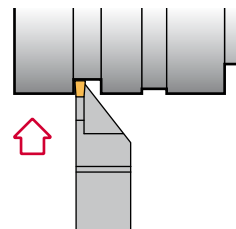

XLCF

Reference Bezeichnung	h=h1	b	L1	L2	B	Insert size Wendeschneidplatte	kg
XLCF R/L 1010 J02	10	10	110	18	2	PTNT 02	0,080
XLCF R/L 1212 J02	12	12	110	18	2	PTNT 02	0,100
XLCF R/L 1616 J03	16	16	110	20	3	PTNT 03	0,150
XLCF R/L 1616 J04	16	16	110	20	4	PTNT 04	0,150
XLCF R/L 2020 K03	20	20	125	20	3	PTNT 03	0,350
XLCF R/L 2020 K04	20	20	125	20	4	PTNT 04	0,350
XLCF R/L 2525 M03	25	25	150	20	3	PTNT 03	0,650
XLCF R/L 2525 M04	25	25	150	20	4	PTNT 04	0,650

Reference Bezeichnung	
XLCF R/L 1010 J02	5732
XLCF R/L 1212 J02	5732
XLCF R/L 1616 J03	5732
XLCF R/L 1616 J04	5732
XLCF R/L 2020 K03	5732
XLCF R/L 2020 K04	5732
XLCF R/L 2525 M03	5732
XLCF R/L 2525 M04	5732

PTNT

Single-ended insert for parting and grooving.
Einseitige Wendeschneidplatte zum Ab- und Einstechen. B08

Reference / Bez.

s

PTNT 02	2,10
PTNT 03	3,10
PTNT 04	4,10

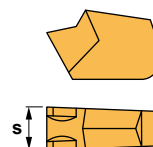

PTNT



**Characteristics:**

Multipurpose boring bar for grooving, threading and turning.
For smaller diameters from 4,2 mm.

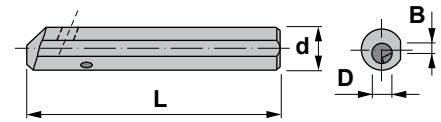
**Eigenschaften:**

Multifunktions-Bohrstange zum Einstechen, Gewindedrehen und Drehen.
Für kleinere Durchmesser ab 4,2mm.

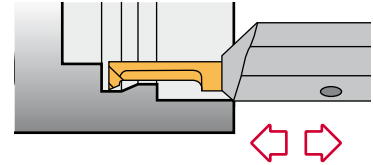

00.30

Reference Bezeichnung	L	d	B	D	Tool size Werkzeug	
00.30.12.04	100	12	2,35	2,5 / 4,2	CTI 04..	0,070
00.30.16.06	120	16	2,80	8,2	CTI 06..	0,150

Reference Bezeichnung			Nm
00.30.12.04	1505	5025	2.0
00.30.16.06	1506	5003	3.0



Characteristics:
Turning tool.
Eigenschaften:
Drehwerkzeug.



AR

Reference Bezeichnung	L	d	B	Dmin	r
CTI 0402 AR	15	4	0,8	4,2	0,2
CTI 0602 AR	20	6	1,8	6,2	0,2

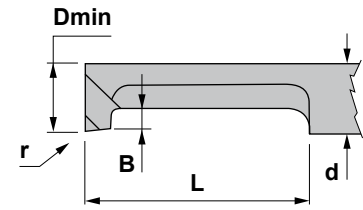

Characteristics:
Copying tool.
Eigenschaften:
Kopierwerkzeug.

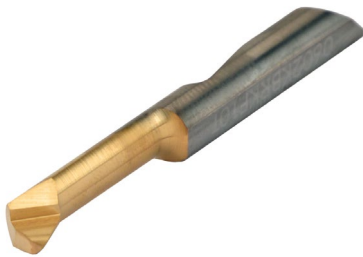

BR

Reference Bezeichnung	L	d	B	Dmin	r
CTI 0402 BR	15	4	0,8	4,2	0,2
CTI 0602 BR	20	6	1,8	6,2	0,2

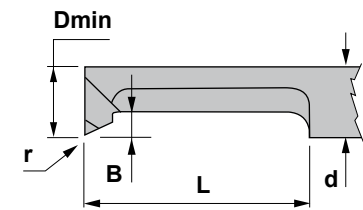

Characteristics:
Threading tool.
Eigenschaften:
Gewindewerkzeug.



CR

Reference Bezeichnung	L	d	B	Dmin
CTI 0400 CR	15	4	0,8	M5
CTI 0600 CR	20	6	1,8	M8

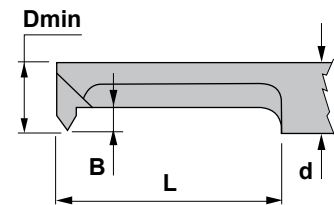

Characteristics:
Grooving tool.
Eigenschaften:
Einstechwerkzeug.



DR

Reference Bezeichnung	L	d	B	Dmin
CTI 0410 DR	15	4	1,0	4,2
CTI 0615 DR	20	6	1,8	6,2

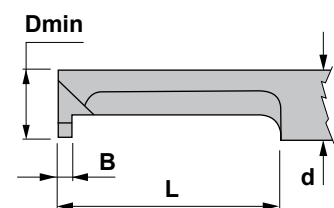



Characteristics: Multipurpose boring bar for grooving, threading and turning.
For smaller diameters from 8 mm.

Eigenschaften: Multifunktions-Bohrstange zum Einstechen, Gewindedrehen und Drehen.
Für kleinere Durchmesser ab 8mm.

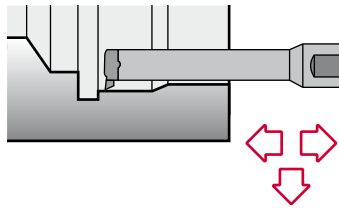
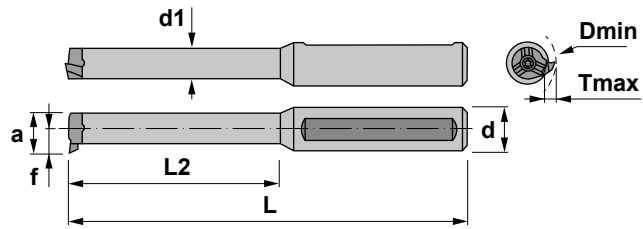

608.00

Reference Bezeichnung	Dmin	d	d1	L	L2	a	f	Tmax	Insert size Wendeschneidplatte	Kg
608.0012.2 HM	8	12	6	90	30	7,8	4,8	1,0	R/LS08	0,090
611.0012.2 HM	11	12	8	110	42	10,7	6,7	2,3	R/LS11	0,090
614.0012.2 HM	14	12	11	110	45	13,8	9,0	4,0	R/LS14	0,130
616.0012.2 HM	16	12	11	130	56	15,7	10,2	4,3	R/LS16	0,265

Reference Bezeichnung			Nm
608.0012.2 HM	1226	5508	1.2
611.0012.2 HM	1535	5510	2.0
614.0012.2 HM	1244	5515	3.0
616.0012.2 HM	1255	5520	4.0

R/LS..

B11-15

Reference / Bez.	d
R/LS.. 08..	6,0
R/LS.. 11..	8,0
R/LS.. 14..	9,0
R/LS.. 16..	11,0

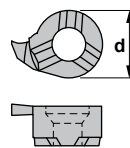

R/LS

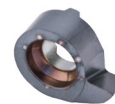

Insert for turning
WSP zum Drehen

R/LS

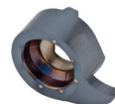

Insert for grooving with radius
WSP zum Vollradius-Einstechen

R/LS

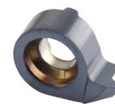

Insert for threading
WSP zum Gewindedrehen

R/LS



Insert for grooving
WSP zum Einstechen



Characteristics:

Grooving toolholder that works well on steels, alloyed steels, stainless steels and refractories.

Single-ended inserts with thickness from 3 to 4 mm.

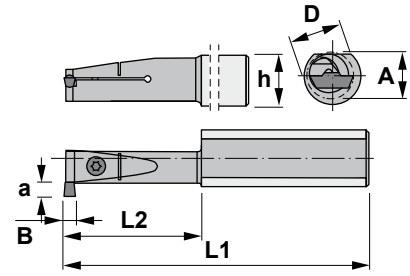

Eigenschaften:

Bohrstange zum Einstechen. Geeignet für Stähle, legierte Stähle, rostfreie Stähle und feuerfeste Materialien.

Einseitige Wendeschneidplatte von 3 bis 4 mm Dicke.

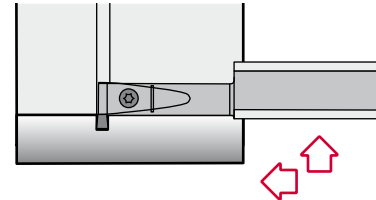

CZGB

Reference Bezeichnung	D	A	h	L1	L2	B	a	Insert size Wendeschneidplatte	Kg
S16M CZGB R/L 03	16	16	15	150	30	3	4	MCRN 3,0	0,180
S20R CZGB R/L 03	20	20	18	200	35	3	6	MCRN 3,0	0,400
S25S CZGB R/L 03	25	25	23	250	40	3	8	MCRN 3,0	0,650
S20R CZGB R/L 04	20	20	18	200	35	4	6	MCRN 4,0	0,400
S25S CZGB R/L 04	25	25	23	250	40	4	8	MCRN 4,0	0,650

Reference Bezeichnung				
S16M CZGB R/L 03	1250	5520	-	-
S20R CZGB R/L 03	1250	5520	-	-
S25S CZGB R/L 03	-	-	1006	5004
S20R CZGB R/L 04	-	-	1006	5004
S25S CZGB R/L 04	-	-	1006	5004

MRCN

Single-ended insert for parting and grooving.
Einseitige Wendeschneidplatte zum Ab- und Einstechen. B08

Reference / Bez.

s

r

MRCN 3,0

3,0

0,20

MRCN 4,0

4,0

0,20

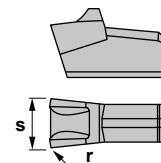

MRCN





Characteristics:

Tool blocks manufactured with two slot-guides that allow to maintain the blade always guided.
For manual and C.N.C. lathes.

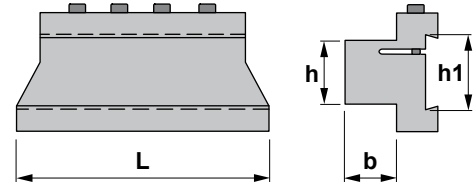

Eigenschaften:

Grundhalter hergestellt mit zwei Schlitzführungen, die stets das Stechschwert gerade halten.
Für konventionelle und C.N.C. Drehmaschinen.

CPTS

Reference Bezeichnung	h1	L	h	b			
CPTS 1916	19	76	16	16	1075	5004	0,300
CPTS 2616	26	87	16	16	1076	5005	0,450
CPTS 2620	26	87	20	20	1076	5005	0,500
CPTS 2625	26	87	25	25	1076	5005	0,650
CPTS 3220	32	100	20	20	1076	5005	0,700
CPTS 3225	32	110	25	25	1076	5005	0,950
CPTS 3232	32	120	32	32	1076	5005	1,400
CPTS 5250	52	135	50	50	1078	5006	3,400



Characteristics:

Tool blocks manufactured with two slot-guides that allow to maintain the blade always guided. Fixing system in two parts for machines with difficult access.
For manual and C.N.C. lathes.

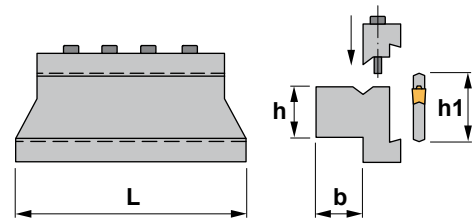

Eigenschaften:

Grundhalter hergestellt mit zwei Schlitzführungen, die stets das Stechschwert gerade halten.
Das Klemmungssystem in zwei Teilen ist für schwer zugängliche Maschinen empfohlen.
Für konventionelle und C.N.C. Drehmaschinen.

DPTS

Reference Bezeichnung	h1	L	h	b				
DPTS 1916	19	76	16	16	1075	2916	5004	0,250
DPTS 2620	26	87	20	20	1076	2920	5005	0,550
DPTS 2625	26	87	25	25	1076	2920	5005	0,700
DPTS 3220	32	100	20	20	1076	2930	5005	0,750
DPTS 3225	32	110	25	25	1076	2935	5005	1,000
DPTS 3232	32	120	32	32	1076	2942	5005	1,450
DPTS 5250	52	135	50	50	1078	2950	5006	3,450



Characteristics:

Parting, grooving and face grooving blade that works well on steels, alloyed steels, stainless steels and refractories. Modular system for inserts with thickness from 2 to 4 mm.

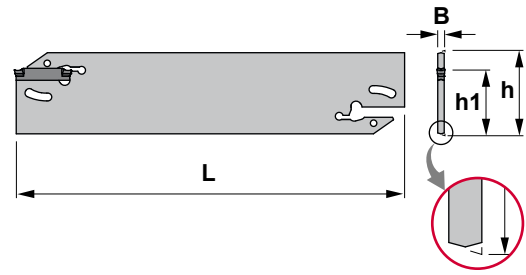

Eigenschaften:

Schwerter zum Ein-, Ab- und Stirnstechen. Geeignet für Stähle, legierte Stähle, rostfreie Stähle und feuerfeste Materialien. Modulares System für Wendeschneidplatten von 2 bis o 4 mm Dicke.

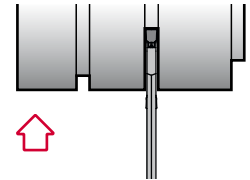

CZDPN

Reference Bezeichnung	h	L	h1	B	Insert size Wendeschneidplatte	/kg
CZDP N 2601 J02	26	110	21,4	2,2	WDM.. 02	0,060
CZDP N 2602 J03	26	110	21,4	3,0	WDM.. 03	0,070
CZDP N 3201 M02	32	150	25,0	2,2	WDM.. 02	0,090
CZDP N 3202 M03	32	150	25,0	3,0	WDM.. 03	0,100
CZDP N 3203 M04	32	150	25,0	4,0	WDM.. 04	0,125

Reference Bezeichnung	
CZDP N 2601 J02	5735
CZDP N 2602 J03	5735
CZDP N 3201 M02	5735
CZDP N 3202 M03	5735
CZDP N 3203 M04	5735

WDM..



Reference / Bez.	s
WDM.. 02	2,0
WDM.. 03	3,0
WDM.. 04	4,0

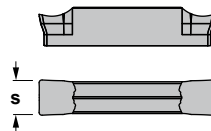

WDMG: Insert for grooving.
 WDMP: Insert for parting.
 WDMR: Insert for parting with radius.
 WDMT: Insert for turning.
 WDMG: Wendeschneidplatte zum Einstechen.
 WDMP: Wendeschneidplatte zum Abstechen.
 WDMR: Wendeschneidplatte zum Vollradius-Stechen.
 WDMT: Wendeschneidplatte zum Drehen.

WDMG



WDMP



WDMR



WDMT



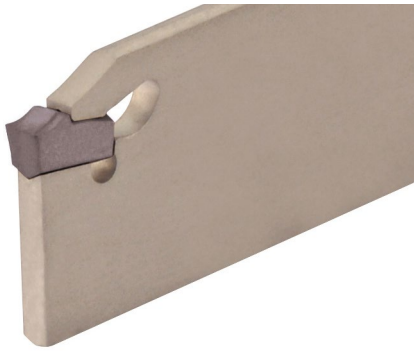

Characteristics:
Parting and grooving blade that works well on steels, alloyed steels, stainless steels and refractories.
Single-ended inserts with thickness from 2,2 to 6 mm.

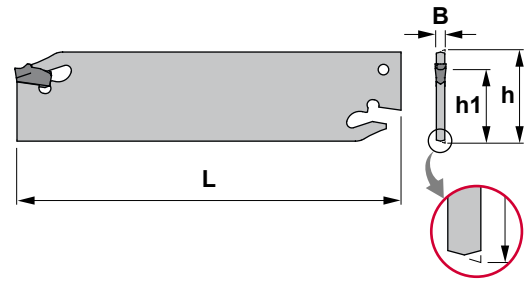

Eigenschaften:
Ab- und Einstechschwerter. Geeignet für Stähle, legierte Stähle, rostfreie Stähle und feuerfeste Materialien.
Einseitige Wendeschneidplatte von 2,2 bis 6 mm Dicke.

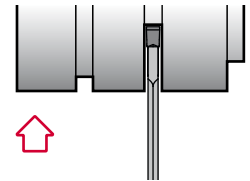

CRCFN

Reference Bezeichnung	h	L	h1	B	Insert size Wendeschneidplatte	⚖️ Kg
CRCF N 1901 X02	19	86	16,0	2,2	MCRN 2,2	0,040
CRCF N 2601 J02	26	110	21,4	2,2	MCRN 2,2	0,060
CRCF N 2602 J03	26	110	21,4	3,0	MCRN 3,0	0,070
CRCF N 2603 J04	26	110	21,4	4,0	MCRN 4,0	0,090
CRCF N 2604 J05	26	110	21,4	5,0	MCRN 5,0	0,100
CRCF N 2605 J06	26	110	21,4	6,0	MCRN 6,0	0,100
CRCF N 3202 M03	32	150	25,0	3,0	MCRN 3,0	0,100
CRCF N 3203 M04	32	150	25,0	4,0	MCRN 4,0	0,125
CRCF N 3204 M05	32	150	25,0	5,0	MCRN 5,0	0,150
CRCF N 3205 M06	32	150	25,0	6,0	MCRN 6,0	0,170

Reference Bezeichnung	
CRCF N 1901 X02	5732
CRCF N 2601 J02	5732
CRCF N 2602 J03	5732
CRCF N 2603 J04	5732
CRCF N 2604 J05	5732
CRCF N 2605 J06	5732
CRCF N 3202 M03	5732
CRCF N 3203 M04	5732
CRCF N 3204 M05	5732
CRCF N 3205 M06	5732

MRCN

Single-ended insert for parting and grooving.
Einseitige Wendeschneidplatte zum Ab- und Einstechen.  B08

Reference / Bez.	s	r
MRCN 2,2	2,2	0,20
MRCN 3,0	3,0	0,20
MRCN 4,0	4,0	0,20
MRCN 5,0	5,0	0,30
MRCN 6,0	6,0	0,40

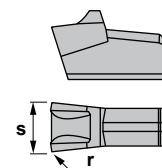

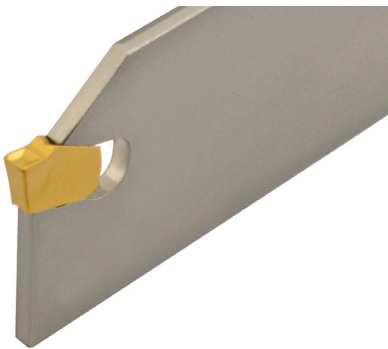

Characteristics:
Parting and grooving blade that works well on steels, alloyed steels, stainless steels and refractories.
Single-ended inserts with thickness from 2 to 9 mm.

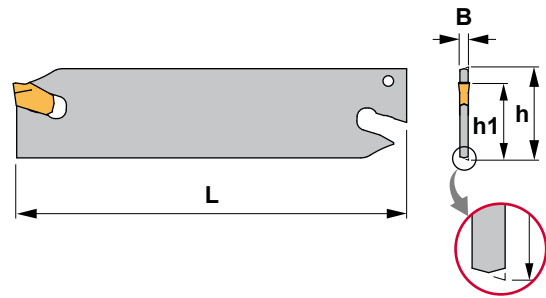

Eigenschaften:
Ab- und Einstechschwerter. Geeignet für Stähle, legierte Stähle, rostfreie Stähle und feuerfeste Materialien.
Einseitige Wendeschneidplatte von 2 bis 9 mm Dicke.

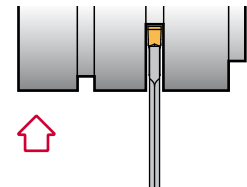

XLCFN

Reference Bezeichnung	h	L	h1	B		Insert size Wendeschneidplatte	
XLCF N 1901 X02	19,0	86	16,0	2,1	5732	PTNT 02	0,040
XLCF N 2601 J02	26,0	110	21,4	2,1	5732	PTNT 02	0,050
XLCF N 2602 J03	26,0	110	21,4	3,1	5732	PTNT 03	0,050
XLCF N 2603 J04	26,0	110	21,4	4,1	5732	PTNT 04	0,085
XLCF N 2604 J05	26,0	110	21,4	5,1	5732	PTNT 05	0,095
XLCF N 2605 J06	26,0	110	21,4	6,1	5732	PTNT 06	0,120
XLCF N 3201 M02	32,0	150	25,0	2,1	5732	PTNT 02	0,075
XLCF N 3202 M03	32,0	150	25,0	3,1	5732	PTNT 03	0,100
XLCF N 3203 M04	32,0	150	25,0	4,1	5732	PTNT 04	0,130
XLCF N 3204 M05	32,0	150	25,0	5,1	5732	PTNT 05	0,160
XLCF N 3205 M06	32,0	150	25,0	6,1	5732	PTNT 06	0,190
XLCF N 3207 M08	32,0	150	25,0	8,1	5732	PTNT 08	0,230
XLCF N 3208 M09	32,0	150	25,0	9,1	5732	PTNT 09	0,270
XLCF N 5207 X08	52,6	190	45,0	8,1	5732	PTNT 08	0,500
XLCF N 5208 X09	52,6	190	45,0	9,1	5732	PTNT 09	0,600
XLCF N 5307 X08	52,6	260	45,0	8,1	5732	PTNT 08	0,700
XLCF N 5308 X09	52,6	260	45,0	9,1	5732	PTNT 09	0,800

PTNT

Single-ended insert for parting and grooving.
Einseitige Wendeschneidplatte zum Ab- und Einstechen. B08

Reference / Bez.

s

PTNT 02	2,10
PTNT 03	3,10
PTNT 04	4,10
PTNT 05	5,10
PTNT 06	6,10
PTNT 08	8,10
PTNT 09	9,10

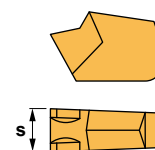

PTNT





Characteristics:
Parting and grooving positive stop blade that works well on steels, alloyed steels, stainless steels and refractories.
For inserts with thickness from 2 to 6 mm.

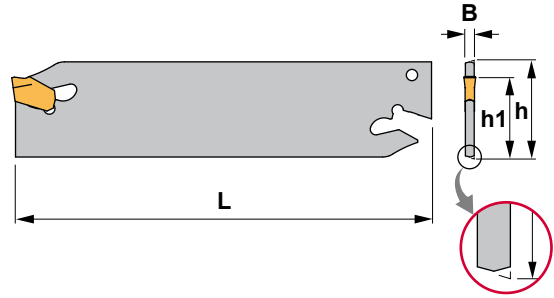

Eigenschaften:
Ab- und Einstechschwerter mit Festanschlag. Geeignet für Stähle, legierte Stähle, rostfreie Stähle und feuerfeste Materialien.
Einseitige Wendeschneidplatte von 2 bis 6 mm Dicke.

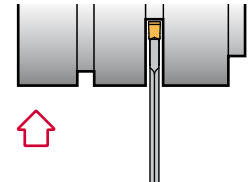

XLCTN

Reference Bezeichnung	h	L	h1	B	Insert size Wendeschneidplatte	Kg
XLCT N 1901 X02	19	86	16,0	2,1	PTNT 02	0,040
XLCT N 2601 J02	26	110	21,4	2,1	PTNT 02	0,050
XLCT N 2602 J03	26	110	21,4	3,1	PTNT 03	0,050
XLCT N 2603 J04	26	110	21,4	4,1	PTNT 04	0,085
XLCT N 2604 J05	26	110	21,4	5,1	PTNT 05	0,095
XLCT N 2605 J06	26	110	21,4	6,1	PTNT 06	0,120
XLCT N 3201 M02	32	150	25,0	2,1	PTNT 02	0,075
XLCT N 3202 M03	32	150	25,0	3,1	PTNT 03	0,100
XLCT N 3203 M04	32	150	25,0	4,1	PTNT 04	0,130
XLCT N 3204 M05	32	150	25,0	5,1	PTNT 05	0,160
XLCT N 3205 M06	32	150	25,0	6,1	PTNT 06	0,190

Reference Bezeichnung	
XLCT N 1901 X02	5732
XLCT N 2601 J02	5732
XLCT N 2602 J03	5732
XLCT N 2603 J04	5732
XLCT N 2604 J05	5732
XLCT N 2605 J06	5732
XLCT N 3201 M02	5732
XLCT N 3202 M03	5732
XLCT N 3203 M04	5732
XLCT N 3204 M05	5732
XLCT N 3205 M06	5732

PTNT

Single-ended insert for parting and grooving.
Einseitige Wendeschneidplatte zum Ab- und Einstechen. B08

Reference / Bez.	s
PTNT 02	2,10
PTNT 03	3,10
PTNT 04	4,10
PTNT 05	5,10
PTNT 06	6,10

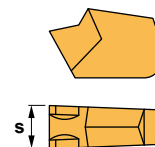



Characteristics:
Parting and grooving positive stop blade that works well on steels, alloyed steels, stainless steels and refractories.
For inserts with thickness from 2 to 4 mm.

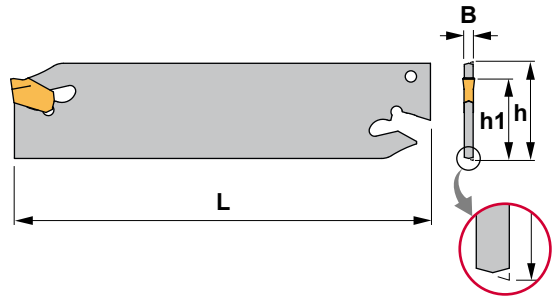

HSS

Eigenschaften:
Ab- und Einstechschwerner mit Festanschlag. Geeignet für Stähle, legierte Stähle, rostfreie Stähle und feuerfeste Materialien.
Einseitige Wendeschneidplatte von 2 bis 4 mm Dicke.

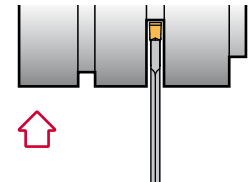

XLCTN-HSS

Reference Bezeichnung	h	L	h1	B	Insert size Wendeschneidplatte	kg
XLCT N 2601 J02-HSS	26	110	21,4	2,1	PTNT 02	0,050
XLCT N 2602 J03-HSS	26	110	21,4	3,1	PTNT 03	0,050
XLCT N 2603 J04-HSS	26	110	21,4	4,1	PTNT 04	0,085
XLCT N 3201 M02-HSS	32	150	25,0	2,1	PTNT 02	0,075
XLCT N 3202 M03-HSS	32	150	25,0	3,1	PTNT 03	0,100
XLCT N 3203 M04-HSS	32	150	25,0	4,1	PTNT 04	0,130

Reference Bezeichnung	
XLCT N 2601 J02-HSS	5732
XLCT N 2602 J03-HSS	5732
XLCT N 2603 J04-HSS	5732
XLCT N 3201 M02-HSS	5732
XLCT N 3202 M03-HSS	5732
XLCT N 3203 M04-HSS	5732

PTNT

Single-ended insert for parting and grooving.
Einseitige Wendeschneidplatte zum Ab- und Einstechen. B08

Reference / Bez.

s

PTNT 02	2,10
PTNT 03	3,10
PTNT 04	4,10

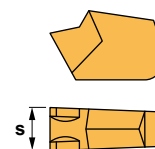

PTNT



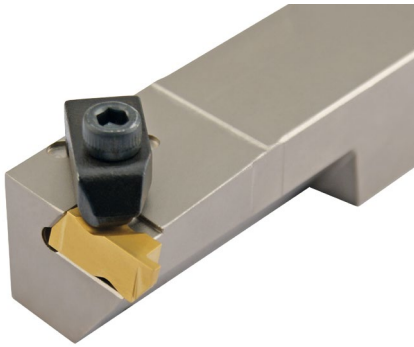

Characteristics:
Multipurpose grooving and threading
top clamp external toolholder.

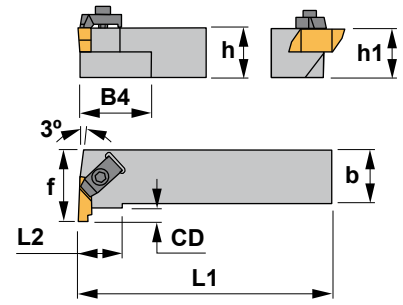

Eigenschaften:
Multifunktionaler Klemmhalter zum
Einstecken und Gewindedrehen mit
Top Notch Klemmung.

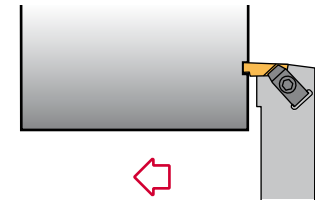

NE 93°

Reference Bezeichnung	h=h1	b	L1	L2	f	Insert size Wendeschneidplatte	Kg
NE R/L 1616 H02	16	16	100	25,40	20	N..2	0,200
NE R/L 2020 K02	20	20	125	25,40	25	N..2	0,400
NE R/L 2525 M02	25	25	150	25,40	32	N..2	0,700
NE R/L 2525 M03	25	25	150	50,80	32	N..3	0,700
NE R/L 3225 P03	32	25	170	50,80	32	N..3	1,000
NE R/L 2525 M04	25	25	150	50,80	35	N..4	0,700
NE R/L 3225 P04	32	25	170	50,80	35	N..4	1,000
NE R/L 3232 P04	32	32	170	50,80	40	N..4	1,250

Reference Bezeichnung				
NE R/L 1616 H02	5003	TF-75	TF-74	1494
NE R/L 2020 K02	5003	TF-75	TF-74	1494
NE R/L 2525 M02	5003	TF-75	TF-74	1494
NE R/L 2525 M03	5004	TF-73	TF-72	1495
NE R/L 3225 P03	5004	TF-73	TF-72	1495
NE R/L 2525 M04	5004	TF-73	TF-72	1495
NE R/L 3225 P04	5004	TF-73	TF-72	1495
NE R/L 3232 P04	5004	TF-73	TF-72	1495

N..

B09-10

Reference / Bez.	s
N.. 2	3,81
N.. 3	4,95
N.. 4	6,48

NG: Insert for grooving / Einstechwendeschneidplatte
NR: Insert for grooving with radius / Vollradius-Einsteckplatte
NT: Insert for threading / Gewindewendeschneidplatte

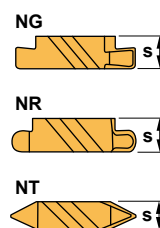

NG

NR



NT



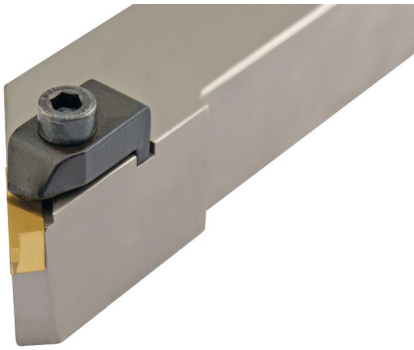

Characteristics:
Specific application external grooving toolholder.
Right tools require left inserts and vice versa. Maximum grooving depth depending on insert.

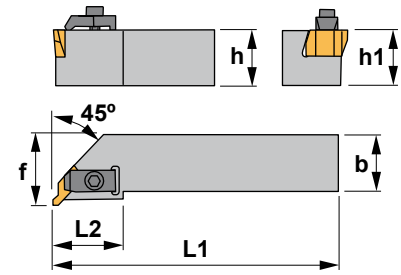

Eigenschaften:
Klemmhalter zum Einstecken für spezifische Anwendungen.
Rechte Werkzeuge benötigen linke Wendeschneidplatten und umgekehrt.
Die maximale Nutentiefe hängt von der Platte ab.

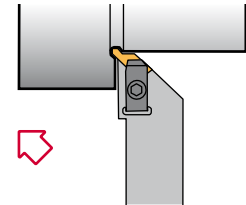

NR 45°

Reference Bezeichnung	h=h1	b	L1	L2	f	Insert size Wendeschneidplatte	Kg
NR R/L 2020 K03	20	20	125	32	25	N..3	0,400
NR R/L 2525 M03	25	25	150	32	32	N..3	0,700
NR R/L 3225 P03	32	25	170	32	32	N..3	1,000

Reference Bezeichnung				
NR R/L 2020 K03	5004	TF-73	TF-72	1495
NR R/L 2525 M03	5004	TF-73	TF-72	1495
NR R/L 3225 P03	5004	TF-73	TF-72	1495

N..

B09-10

Reference / Bez.	s
N.. 3	4,95

NG: Insert for grooving / Einstechwendeschneidplatte
NR: Insert for grooving with radius / Vollradius-Einstechplatte
NT: Insert for threading / Gewindewendeschneidplatte

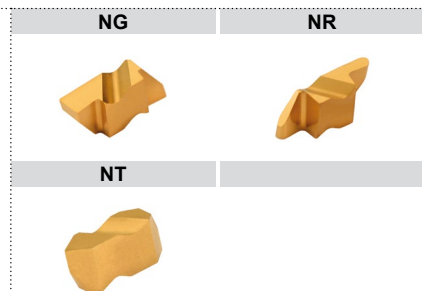
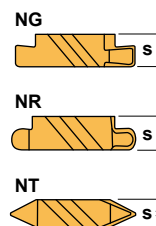

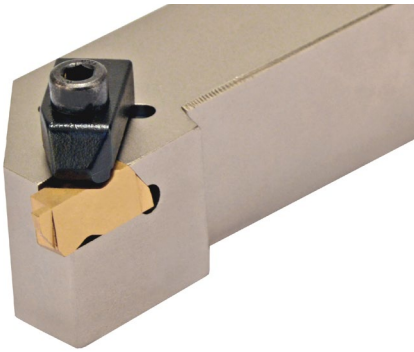

Characteristics:

Multipurpose grooving and threading top clamp external toolholder.
Maximum grooving depth depending on insert.

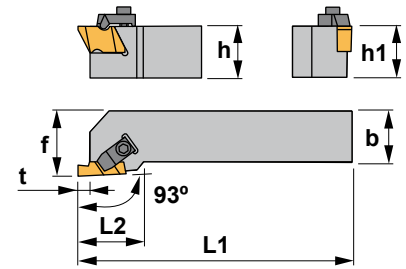

Eigenschaften:

Multifunktionaler Klemmhalter zum Einstechen und Gewindedrehen mit Top Notch Klemmung.
Die maximale Nutentiefe hängt von der Platte ab.

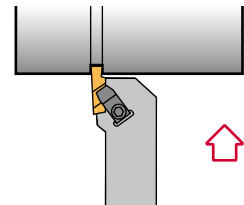

NS 93°

Reference Bezeichnung	h=h1	b	L1	L2	f	Insert size Wendeschneidplatte	⚖ kg
NS R/L 1010 E02	10	10	70	6,35	14	N..2	0,070
NS R/L 1212 F02	12	12	80	6,35	16	N..2	0,100
NS R/L 1616 H02	16	16	100	6,35	20	N..2	0,200
NS R/L 2020 K02	20	20	125	6,35	25	N..2	0,400
NS R/L 2525 M02	25	25	150	6,35	32	N..2	0,700
NS R/L 2020 K03	20	20	125	9,65	25	N..3	0,400
NS R/L 2525 M03	25	25	150	9,65	32	N..3	0,700
NS R/L 3225 P03	32	25	170	9,65	32	N..3	0,900
NS R/L 3232 P03	32	32	170	9,65	40	N..3	1,250
NS R/L 2525 M04	25	25	150	9,65	32	N..4	0,700
NS R/L 3225 P04	32	25	170	9,65	32	N..4	0,900
NS R/L 3232 P04	32	32	170	9,65	40	N..4	1,250

Reference Bezeichnung							
NS R/L 1010 E02	5003	TF-75	TF-74	-	-	-	1494
NS R/L 1212 F02	5003	TF-75	TF-74	-	-	-	1494
NS R/L 1616 H02	5003	TF-75	TF-74	-	-	-	1494
NS R/L 2020 K02	5003	TF-75	TF-74	-	-	-	1494
NS R/L 2525 M02	5003	TF-75	TF-74	-	-	-	1494
NS R/L 2020 K03	5004	TF-73	TF-72	-	-	-	1495
NS R/L 2525 M03	5004	TF-73	TF-72	-	-	-	1495
NS R/L 3225 P03	5004	TF-73	TF-72	-	-	-	1495
NS R/L 3232 P03	5004	TF-73	TF-72	-	-	-	1495
NS R/L 2525 M04	5004	TF-73	TF-72	3521	1625	-	1495
NS R/L 3225 P04	5004	TF-73	TF-72	3521	1625	-	1495
NS R/L 3232 P04	5004	TF-73	TF-72	3521	1625	-	1495

N..

B09-10

Reference / Bez.	s
N.. 2	3,81
N.. 3	4,95
N.. 4	6,48

NG: Insert for grooving / Einstechwendeschneidplatte
NR: Insert for grooving with radius / Vollradius-Einstechplatte
NT: Insert for threading / Gewindewendeschneidplatte

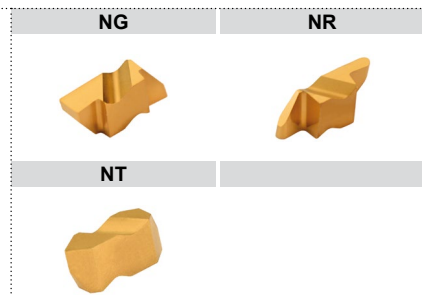
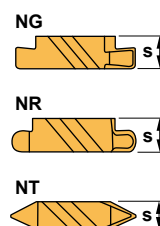

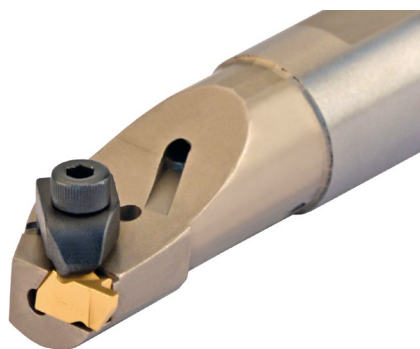

Characteristics:

Multipurpose grooving and threading top clamp boring bar. Right tools require left inserts and vice versa.

Maximum grooving depth depending on insert.

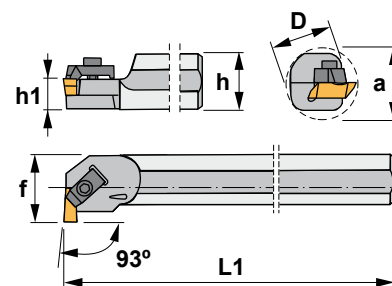

Eigenschaften:

Multifunktionale Bohrstanze zum Einstechen und Gewindedrehen mit Top Notch Klemmung.

Rechte Werkzeuge benötigen linke Wendeschneidplatten und umgekehrt.

Die maximale Nutentiefe hängt von der Platte ab.

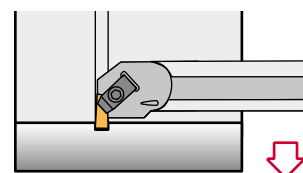

NNTO 93°

Reference Bezeichnung	D	h	h1	L1	f	A	Insert size Wendeschneidplatte	kg
A12M-NNTO R/L 02	12	11	5,5	150	11	18,5	N..2	0,150
A16M-NNTO R/L 02	16	15	7,5	150	11	22,0	N..2	0,200
A20Q-NNTO R/L 02	20	18	9,0	180	13	26,0	N..2	0,400
A25R-NNTO R/L 02	25	23	11,5	200	17	34,0	N..2	0,700
A25R-NNTO R/L 03	25	23	11,5	200	17	34,0	N..3	0,700
A32S-NNTO R/L 03	32	30	15,0	250	22	44,0	N..3	1,400
A40T-NNTO R/L 03	40	37	18,5	300	27	54,0	N..3	2,650
A40T-NNTO R/L 04	40	37	18,5	300	27	54,0	N..4	2,650
A50U-NNTO R/L 04	50	47	23,5	350	35	70,0	N..4	5,400

Reference Bezeichnung			
A12M-NNTO R/L 02	TF-147	TF-146	1494
A16M-NNTO R/L 02	TF-75	TF-74	1494
A20Q-NNTO R/L 02	TF-75	TF-74	1494
A25R-NNTO R/L 02	TF-75	TF-74	1494
A25R-NNTO R/L 03	TF-73	TF-72	1495
A32S-NNTO R/L 03	TF-73	TF-72	1495
A40T-NNTO R/L 03	TF-73	TF-72	1495
A40T-NNTO R/L 04	TF-73	TF-72	1495
A50U-NNTO R/L 04	TF-73	TF-72	1495

N..

B09-10

Reference / Bez.	s
N.. 2	3,81
N.. 3	4,95
N.. 4	6,48

NG: Insert for grooving / Einstechwendeschneidplatte
NR: Insert for grooving with radius / Vollradius-Einsteckplatte
NT: Insert for threading / Gewindewendeschneidplatte

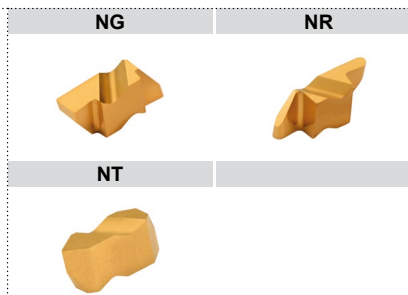
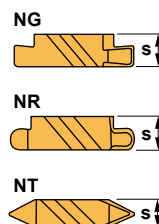

Nominal cutting speed for parting

Material	P	HB	Condition	Basic grades					Specific cutting force N/mm ²
				TL40	TN15	TN30	PM25	KM15	
				Cutting speed m/min.					
Unalloyed steel		125	C=0.15%	160-120	480-345-250	200-150	160-120		1900
		150	C=0.35%	150-110	440-315-230	190-140	150-110		2100
		200	C=0.60%	130-90	385-275-200	170-120	130-90		2250
Low alloyed steel		180	Annealed	140-100	380-265-195	180-130	140-100		2100
		275	Hardened	120-80	260-180-130	160-110	120-80		2600
		300	Hardened	110-70	240-165-120	150-100	110-70		2700
		350	Hardened	90-60	210-145-105	140-90	90-60		2850
High alloyed steel		200	Annealed	70-60	350-230-170	110-90	70-60		2600
		325	Hardened	45-30	170-110	70-50	45-30		3900
Stainless steel		200	Martensitic / ferritic	130-90	295-240-190	170-120	130-90		2300
Steel		180	Unalloyed	100-60	260-185-145	130-90	100-60		2000
		200	Low alloyed	90-50	230-160-120	115-75	90-50		2500
		225	High alloyed	80-40	190-130-95	100-60	80-40		2700

Material	M	HB	Condition	Basic grades					Specific cutting force N/mm ²	
				TL40	TN15	TN30	PM25	KM15		
				Cutting speed m/min.						
Stainless steel annealed		180		130-90	180-150-120	170-120	130-90	100-60	2450	
Heat-resistant alloys		200	Annealed						50-30	3000
		280	Aged						40-20	3050
		250	Annealed						30-20	3500
		350	Aged						20-10	4150
		320	Cast						20-10	4150
Titanium alloys		400	Ti						1520	
		950	Cast α , almost α and $\alpha+\beta$						1675	
		1050	Aged cast $\alpha+\beta$						1690	

Material	K	HB	Condition	Basic grades				Specific cutting force N/mm ²				
				TN15	TN30	PM25	KM15					
				Cutting speed m/min.								
Hardened steel		220	Hardened steel	175-145-100				4500				
		250	Manganese steel 12%						120-85-50			
Malleable cast iron		130	Ferritic	225-150-90	140-110		100-80	1100				
		230	Pearlitic						155-95-55	100-70	70-50	
Cast iron		180	Low tensile strength	165-110-70	110-85		80-60	1100				
		260	High tensile strength						120-90-55	100-70	70-50	
Nodular SG iron		160	Ferritic		100-70		70-50	1100				
		250	Pearlitic						85-60	60-40	1800	
Aluminium alloys		60	Non heat treatable		1500	1500	1000	500				
		100	Heat treatable						500	500	420	800
Aluminium alloys (cast)		75	Non heat treatable		1500	1500	1000	750				
		90	Heat treatable						750	750	650	900
Bronze-brass alloys		110	Lead alloys, Pb>1%		300	300	300	700				
		90	Brass, red brass						200	200	200	750
		100	Bronze and lead-free copper						150	150	150	1750

Nennschnittgeschwindigkeit für Abstechwerkzeuge



Materialien	P	HB	Beschaffenheit	Hauptsorten					Spezifische Schnittkraft N/mm ²	
				TL40	TN15	TN30	PM25	KM15		
				Schnittgeschwindigkeit m/min.						
Unlegierter Stahl	P	125	C=0.15% C=0.35% C=0.60%	160-120	480-345-250 440-315-230 385-275-200	200-150 190-140 170-120	160-120 150-110 130-90		1900 2100 2250	
		150		150-110						150-110
		200		130-90						130-90
Niedriglegierter Stahl	P	180	Geglüht Vergütet Vergütet Vergütet	140-100	380-265-195 260-180-130 240-165-120 210-145-105	180-130 160-110 150-100 140-90	140-100 120-80 110-70 90-60		2100 2600 2700 2850	
		275		120-80						120-80
		300		110-70						110-70
		350		90-60						90-60
Hochlegierter Stahl	P	200	Geglüht Vergütet	70-60	350-230-170 170-110	110-90 70-50	70-60 45-30		2600 3900	
		325		45-30						45-30
Rostfreier Stahl	P	200	Martensitisch / Ferritisch	130-90	295-240-190	170-120	130-90		2300	
Stahlguß	P	180	Unlegiert Niedriglegiert Hochlegiert	100-60	260-185-145 230-160-120 190-130-95	130-90 115-75 100-60	100-60 90-50 80-40		2000 2500 2700	
		200		90-50						90-50
		225		80-40						80-40

Materialien	M	HB	Beschaffenheit	Hauptsorten					Spezifische Schnittkraft N/mm ²
				TL40	TN15	TN30	PM25	KM15	
				Schnittgeschwindigkeit m/min.					
Rostfreier Stahl, gegläht	M	180		130-90	180-150-120	170-120	130-90	100-60	2450
Warmfeste Legierungen	M	200	Geglüht Verlätet Geglüht Verlätet Gegossen					50-30 40-20 30-20 20-10 20-10	3000 3050 3500 4150 4150
		280							
		250							
		350							
Titan-Legierungen	M	400	Ti α -Legierungen, fast α -Legierungen und α + β -Legierungen Verlätete α + β -Legierungen						1520 1675 1690
		950							
		1050							

Materialien	K	HB	Beschaffenheit	Hauptsorten				Spezifische Schnittkraft N/mm ²	
				TN15	TN30	PM25	KM15		
				Schnittgeschwindigkeit m/min.					
Gehärteter Stahl	K	220 250	Vergüteter Stahl Mangan-Stahl 12%	175-145-100 120-85-50				4500	
Temperguß	K	130 230	Ferritisch Perlitisch	225-150-90 155-95-55	140-110 100-70		100-80 70-50	1100 1100	
Guß	K	180 260	Niedrige Zugfestigkeit Hohe Zugfestigkeit	165-110-70 120-90-55	110-85 100-70		80-60 70-50	1100 1500	
SG-Kugelgraphitguß	K	160 250	Ferritisch Perlitisch		100-70 85-60		70-50 60-40	1100 1800	
Aluminium-Legierungen	K	60 100	Nicht warmbehandelbar Warmbehandelbar		1500 500	1500 500	1000 420	500 800	
Gegossene Aluminium-Legierungen	K	75 90	Nicht warmbehandelbar Warmbehandelbar		1500 750	1500 750	1000 650	750 900	
Bronze- und Messinglegierungen	K	110	Bleilegierungen, Pb>1% Messing, rotes Messing Bronze und bleifreies Kupfer				300 200 150	300 200 150	700 750 1750
		90							
		100							

Nominal cutting speed for grooving

Material	P	HB	Condition	External				Internal				Specific cutting force N/mm ²
				TL40	TN15	TN30	PM25	TL40	TN15	TN30	PM25	
				Cutting speed m/min.								
Unalloyed steel	125	C=0.15%	160-120	480-345-250	200-150	160-120	110-85	480-345-250	140-105	110-85	1900	
	150	C=0.35%	150-110	440-315-230	190-140	150-110	105-80	440-315-230	135-100	105-80	2100	
	200	C=0.60%	130-90	385-275-200	170-120	130-90	90-60	385-275-200	120-85	90-60	2250	
Low alloyed steel	180	Annealed	140-100	380-265-195	180-130	140-100	100-70	380-265-195	125-90	100-70	2100	
	275	Hardened	120-80	260-180-130	160-110	120-80	85-55	260-180-130	110-80	85-55	2600	
	300	Hardened	110-70	240-165-120	150-100	110-70	80-50	240-165-120	105-70	80-50	2700	
	350	Hardened	90-60	210-145-105	140-90	90-60	60-45	210-145-105	100-60	60-45	2850	
High alloyed steel	200	Annealed	70-60	350-230-170	110-90	70-60	50-45	350-230-170	80-60	50-45	2600	
	325	Hardened	45-30	170-110	70-50	45-30	32-20	170-110	80-35	32-20	3900	
Stainless steel	200	Martensitic / ferritic	130-90	295-240-190	170-120	130-90	90-60	295-240-190	120-85	90-60	2300	
Steel	180	Unalloyed	100-60	260-185-145	130-90	100-60	70-45	260-185-145	90-60	70-45	2000	
	200	Low alloyed	90-50	230-160-120	115-75	90-50	60-35	230-160-120	80-50	60-35	2500	
	225	High alloyed	80-40	190-130-95	100-60	80-40	55-30	190-130-95	70-45	55-30	2700	

Material	M	HB	Condition	External					Internal					Specific cutting force N/mm ²
				TL40	TN15	TN30	PM25	KM15	TL40	TN15	TN30	PM25	KM15	
				Cutting speed m/min.										
Stainless steel annealed	180			130-90	180-150-120	170-120	130-90	100-60	90-60	180-150-120	120-85	90-60	70-45	2450
Heat-resistant alloys	200	Annealed	Iron base					50-30					50-30	3000
	280	Aged						40-20					40-20	3050
	250	Annealed	Ni or Co base					30-20					30-20	3500
	350	Aged						20-10					20-10	4150
320	Cast					20-10						20-10	4150	
Titanium alloys	400	Ti	Cast α , almost α and $\alpha+\beta$ Aged cast $\alpha+\beta$					175						1520
	950							72						1675
	1050							65						1690

Material	K	HB	Condition	External				Internal				Specific cutting force N/mm ²
				TN15	TN30	PM25	KM15	TN15	TN30	PM25	KM15	
				Cutting speed m/min.								
Hardened steel	220	Hardened steel	175-145-100				175-145-100				4500	
	250	Manganese steel 12%	120-85-50				120-85-50					
Malleable cast iron	130	Ferritic	225-150-90	140-110		100-80	225-150-90	100-80		100-80	1100	
	230	Pearlitic	155-95-55	100-70		70-50	155-95-55	70-50		70-50	1100	
Cast iron	180	Low tensile strength	165-110-70	110-85		80-60	165-110-70	80-60		80-60	1100	
	260	High tensile strength	120-90-55	100-70		70-50	120-90-55	70-50		70-50	1500	
Nodular SG iron	160	Ferritic		100-70		70-50		70-50		70-50	1100	
	250	Pearlitic		85-60		60-40		60-45		60-40	1800	
Aluminium alloys	60	Non heat treatable		1500	1500	1000		1050	1050	700	500	
	100	Heat treatable		500	500	420		350	350	300	800	
Aluminium alloys (cast)	75	Non heat treatable		1500	1500	1000		1050	1050	700	750	
	90	Heat treatable		750	750	650		525	525	460	900	
Bronze-brass alloys	110	Lead alloys, Pb>1%		300	300	300		210	210	210	700	
	90	Brass, red brass		200	200	200		140	140	140	750	
	100	Bronze and lead-free copper		150	150	150		105	105	105	1750	

Nennschnittgeschwindigkeit für Einstechwerkzeuge



Materialien	P	HB	Beschaffenheit	Außen				Innen				Spezifische Schnittkraft N/mm ²
				TL40	TN15	TN30	PM25	TL40	TN15	TN30	PM25	
				Schnittgeschwindigkeit m/min.								
Unlegierter Stahl	125	C=0.15%	160-120	480-345-250	200-150	160-120	110-85	480-345-250	140-105	110-85	1900	
	150	C=0.35%	150-110	440-315-230	190-140	150-110	105-80	440-315-230	135-100	105-80	2100	
	200	C=0.60%	130-90	385-275-200	170-120	130-90	90-60	385-275-200	120-85	90-60	2250	
Niedriglegierter Stahl	180	Geglüht	140-100	380-265-195	180-130	140-100	100-70	380-265-195	125-90	100-70	2100	
	275	Vergütet	120-80	260-180-130	160-110	120-80	85-55	260-180-130	110-80	85-55	2600	
	300	Vergütet	110-70	240-165-120	150-100	110-70	80-50	240-165-120	105-70	80-50	2700	
	350	Vergütet	90-60	210-145-105	140-90	90-60	60-45	210-145-105	100-60	60-45	2850	
Hochlegierter Stahl	200	Geglüht	70-60	350-230-170	110-90	70-60	50-45	350-230-170	80-60	50-45	2600	
	325	Vergütet	45-30	170-110	70-50	45-30	32-20	170-110	80-35	32-20	3900	
Rostfreier Stahl	200	Martensitisch / Ferritisch	130-90	295-240-190	170-120	130-90	90-60	295-240-190	120-85	90-60	2300	
Stahl	180	Unlegiert	100-60	260-185-145	130-90	100-60	70-45	260-185-145	90-60	70-45	2000	
	200	Niedriglegiert	90-50	230-160-120	115-75	90-50	60-35	230-160-120	80-50	60-35	2500	
	225	Hochlegiert	80-40	190-130-95	100-60	80-40	55-30	190-130-95	70-45	55-30	2700	

Materialien	M	HB	Beschaffenheit	Außen					Innen					Spezifische Schnittkraft N/mm ²
				TL40	TN15	TN30	PM25	KM15	TL40	TN15	TN30	PM25	KM15	
				Schnittgeschwindigkeit m/min.										
Rostfreier Stahl, gegläht	180			130-90	180-150-120	170-120	130-90	100-60	90-60	180-150-120	120-85	90-60	70-45	2450
Warmfeste Legierungen	200	Geglüht	Eisenbasis					50-30					50-30	3000
	280	Verältert						40-20					40-20	3050
	250	Geglüht	Ni- oder Co-Basis					30-20					30-20	3500
	350	Verältert						20-10					20-10	4150
320	Gegossen					20-10						20-10	4150	
Titan-Legierungen	400	Ti α-Legierungen, fast α-Legierungen und α+β-Legierungen					175							1520
	950	Verälterte α+β-Legierungen					72							1675
	1050						65							1690

Materialien	K	HB	Beschaffenheit	Außen				Innen				Spezifische Schnittkraft N/mm ²
				TN15	TN30	PM25	KM15	TN15	TN30	PM25	KM15	
				Schnittgeschwindigkeit m/min.								
Gehärteter Stahl	220	Vergüteter Stahl	175-145-100				175-145-100				4500	
	250	Mangan-Stahl 12%	120-85-50				120-85-50					
Temperguß	130	Ferritisch	225-150-90	140-110		100-80	225-150-90	100-80		100-80	1100	
	230	Perlitisch	155-95-55	100-70		70-50	155-95-55	70-50		70-50	1100	
Guß	180	Niedrige Zugfestigkeit	165-110-70	110-85		80-60	165-110-70	80-60		80-60	1100	
	260	Hohe Zugfestigkeit	120-90-55	100-70		70-50	120-90-55	70-50		70-50	1500	
SG-Kugelgraphitguß	160	Ferritisch		100-70		70-50		70-50		70-50	1100	
	250	Perlitisch		85-60		60-40		60-45		60-40	1800	
Aluminium-Legierungen	60	Nicht wärmebehandelbar		1500	1500	1000		1050	1050	700	500	
	100	Wärmebehandelbar		500	500	420		350	350	300	800	
Gegossene Aluminium-Legierungen	75	Nicht wärmebehandelbar		1500	1500	1000		1050	1050	700	750	
	90	Wärmebehandelbar		750	750	650		525	525	460	900	
Bronze- und Messinglegierungen	110	Bleilegierungen, Pb>1%		300	300	300		210	210	210	700	
	90	Messing, rotes Messing		200	200	200		140	140	140	750	
	100	Bronze und bleifreies Kupfer		150	150	150		105	105	105	1750	

Nominal cutting speed for profiling

Material	P	HB	Condition	Basic grades					Specific cutting force N/mm ²
				TL40	TN15	TN30	PM25	KM15	
				Cutting speed m/min.					
Unalloyed steel	P	125	C=0.15%	160	480-345-250	200	160		1900
		150	C=0.35%	150	440-315-230	190	150		2100
		200	C=0.60%	130	385-275-200	170	130		2250
Low alloyed steel	P	180	Annealed	140	380-265-195	180	140		2100
		275	Hardened	120	260-180-130	160	120		2600
		300	Hardened	110	240-165-120	150	110		2700
		350	Hardened	90	210-145-105	140	90		2850
High alloyed steel	P	200	Annealed	100	350-230-170	130	100		2600
		325	Hardened	60	170-110	100	60		3900
Stainless steel	P	200	Martensitic / ferritic	130	295-240-190	170	130		2300
Steel	P	180	Unalloyed	100	260-185-145	130	100		2000
		200	Low alloyed	90	230-160-120	115	90		2500
		225	High alloyed	70	190-130-95	100	70		2700

Material	M	HB	Condition	Basic grades					Specific cutting force N/mm ²	
				TL40	TN15	TN30	PM25	KM15		
				Cutting speed m/min.						
Stainless steel annealed	M	180		120	180-150-120	170	120	100	2450	
Heat-resistant alloys	M	200	Annealed					60	3000	
		280	Aged					50	3050	
		250	Annealed	Iron base					30	3500
		350	Aged	Ni or Co base					20	4150
320	Cast						20	4150		
Titanium alloys	M	400	Ti					175	1520	
		950	Cast α , almost α and $\alpha+\beta$					72	1675	
		1050	Aged cast $\alpha+\beta$					65	1690	

Material	K	HB	Condition	Basic grades				Specific cutting force N/mm ²
				TN15	TN30	PM25	KM15	
				Cutting speed m/min.				
Hardened steel	K	220	Hardened steel	175-145-100				4500
		250	Manganese steel 12%	120-85-50				
Malleable cast iron	K	130	Ferritic	225-150-90	140		100	1100
		230	Pearlitic	155-95-55	110		70	
Cast iron	K	180	Low tensile strength	165-110-70	110		100	1100
		260	High tensile strength	120-90-55	100		70	
Nodular SG iron	K	160	Ferritic		100		100	1100
		250	Pearlitic		85		70	
Aluminium alloys	K	60	Non heat treatable		1500	1500	1000	500
		100	Heat treatable		500	500	420	
Aluminium alloys (cast)	K	75	Non heat treatable		1500	1500	450	750
		90	Heat treatable		750	750	300	
Bronze-brass alloys	K	110	Lead alloys, Pb>1%		300	300	300	700
		90	Brass, red brass		200	200	200	
		100	Bronze and lead-free copper		150	150	150	

Nennschnittgeschwindigkeit für Profildrehen



Materialien	P	HB	Beschaffenheit	Hauptsorten					Spezifische Schnittkraft N/mm ²
				TL40	TN15	TN30	PM25	KM15	
				Schnittgeschwindigkeit m/min.					
Unlegierter Stahl	P	125	C=0.15%	160	480-345-250	200	160		1900
		150	C=0.35%	150	440-315-230	190	150		2100
		200	C=0.60%	130	385-275-200	170	130		2250
Niedriglegierter Stahl	P	180	Geglüht	140	380-265-195	180	140		2100
		275	Vergütet	120	260-180-130	160	120		2600
		300	Vergütet	110	240-165-120	150	110		2700
		350	Vergütet	90	210-145-105	140	90		2850
Hochlegierter Stahl	P	200	Geglüht	100	350-230-170	130	100		2600
		325	Vergütet	60	170-110	100	60		3900
Rostfreier Stahl	P	200	Martensitisch / Ferritisch	130	295-240-190	170	130		2300
Stahl	P	180	Unlegiert	100	260-185-145	130	100		2000
		200	Niedriglegiert	90	230-160-120	115	90		2500
		225	Hochlegiert	70	190-130-95	100	70		2700

Materialien	M	HB	Beschaffenheit	Hauptsorten					Spezifische Schnittkraft N/mm ²
				TL40	TN15	TN30	PM25	KM15	
				Schnittgeschwindigkeit m/min.					
Rostfreier Stahl, gegläht	M	180		120	180-150-120	170	120	100	2450
Warmfeste Legierungen	M	200	Geglüht					60	3000
		280	Verältert					50	3050
		250	Geglüht	Eisenbasis				30	3500
		350	Verältert	Ni- oder Co-Basis				20	4150
		320	Gegossen				20	4150	
Titan-Legierungen	M	400	Ti α -Legierungen, fast α -Legierungen					175	1520
		950	und $\alpha+\beta$ -Legierungen					72	1675
		1050	Verälterte $\alpha+\beta$ -Legierungen					65	1690

Materialien	K	HB	Beschaffenheit	Hauptsorten				Spezifische Schnittkraft N/mm ²
				TN15	TN30	PM25	KM15	
				Schnittgeschwindigkeit m/min.				
Gehärteter Stahl	K	220	Vergüteter Stahl	175-145-100				4500
		250	Mangan-Stahl 12%	120-85-50				
Temperguß	K	130	Ferritisch	225-150-90	140		100	1100
		230	Perlitisch	155-95-55	110		70	1100
Guß	K	180	Niedrige Zugfestigkeit	165-110-70	110		100	1100
		260	Hohe Zugfestigkeit	120-90-55	100		70	1500
SG-Kugelgraphitguß	K	160	Ferritisch		100		100	1100
		250	Perlitisch		85		70	1800
Aluminium-Legierungen	K	60	Nicht warmbehandelbar		1500	1500	1000	500
		100	Warmbehandelbar		500	500	420	800
Gegossene Aluminium-Legierungen	K	75	Nicht warmbehandelbar		1500	1500	450	750
		90	Warmbehandelbar		750	750	300	900
Bronze- und Messinglegierungen	K	110	Bleilegierungen, Pb>1%		300	300	300	700
		90	Messing, rotes Messing		200	200	200	750
		100	Bronze und bleifreies Kupfer		150	150	150	1750

A large rectangular area filled with a fine grid of small squares, intended for taking notes or drawing technical diagrams.



THREADING GEWINDEDREHEN



Code system (ISO) Kodifizierung (ISO)	C02
Threading inserts Wendeschneidplatten zum Gewindedrehen	C03-10
Applications index Anwendungen	C11
External threading Außengewindedrehen	C12-16
Internal threading Innengewindedrehen	C17-20
Cutting data Schnittdaten	C21-24
Technical information Technische Auskünfte	C25-26

Code system / Kodifizierung (ISO)

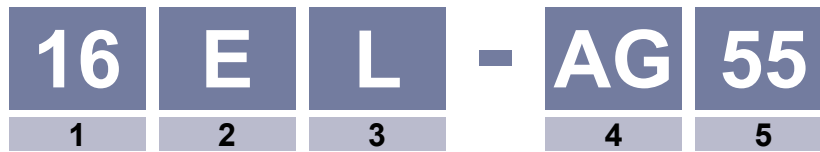

1 Insert size Wendeplattengröße

	IC=inch / Zoll	D=mm.
06	5/32	3,96
08	3/16	4,76
11	1/4	6,35
16	3/8	9,52
22	1/2	12,70
27	5/8	15,87

2 Insert type Wendeplattentyp

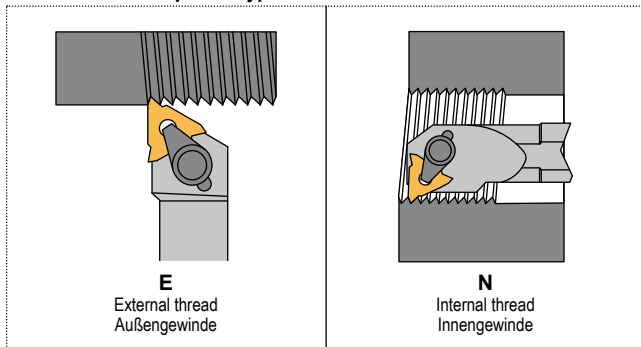

3 Hand of insert Wendeplattenausführung

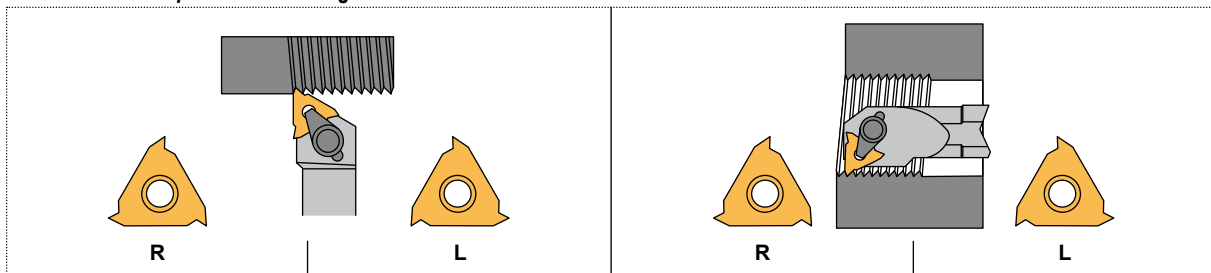

4 Pitch Steigung

	p-mm. x 100 p-inch / Zoll x 10	TPI
A	0,5-1,5	48-16
AG	0,5-3,0	48-8
G	1,75-3,0	14-8
N	3,5-5,0	7-5

5 Standard Standard

55	Partial profile 55° / Teilprofil 55°
60	Partial profile 60° / Teilprofil 60°
ISO	ISO metric / ISO metrisch
W	Whitworth, BSW / Whitworth, BSW
LG	Groove type LG / Nutentyp LG

Grade characteristics / Sorteneigenschaften

Grades Sorten	General use / Allgemeine Verwendung
TL20	General purpose grade with tough submicron substrate. Provides good fracture toughness in non-rigid cutting conditions. TiAlN coated. Universal-Beschichtung mit zähem Feinstkornsubstrat. Bietet gute Bruchfestigkeit bei unterschiedlichen Schnittbedingungen. TiAlN-beschichtet.
TIN25	General purpose grade, excellent in steel and stainless steel, recommended for rigid cutting conditions. Ground or sintered chipbreaker styles. TiN coated. Universal-Beschichtung hervorragend bei Stahl und rostfreiem Stahl, besonders bei unterschiedlichen Schnittbedingungen empfohlen. TiN-beschichtet.

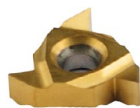

ER



ER TD

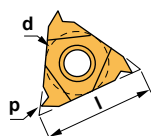

ER

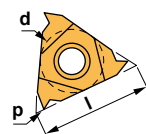

EL

ER-60°

Partial profile thread forms - External inserts 60°-55° (non topping)
Wendeschneidplatten (Teilprofil) 60°/55° zum Außengewindedrehen

Reference / Bezeichnung	l	d	p	TIN25	TL20
11ER-A60	11,00	6,35	60°	○	○
16ER-A60	16,00	9,52	60°	○	○
16ER-AG60	16,00	9,52	60°	●	○
16ER-G60	16,00	9,52	60°	●	○
22ER-N60	22,00	12,70	60°	●	○
27ER-S60	27,00	15,87	60°	○	○

EL-60°

Partial profile thread forms - External inserts 60°-55° (non topping)
Wendeschneidplatten (Teilprofil) 60°/55° zum Außengewindedrehen

Reference / Bezeichnung	l	d	p	TIN25	TL20
11EL-A60	11,00	6,35	60°	○	○
16EL-A60	16,00	9,52	60°	○	○
16EL-AG60	16,00	9,52	60°	○	○
16EL-G60	16,00	9,52	60°	○	○
22EL-N60	22,00	12,70	60°	○	○
27EL-S60	27,00	15,87	60°	○	○

ER-55°

Partial profile thread forms - External inserts 60°-55° (non topping)
Wendeschneidplatten (Teilprofil) 60°/55° zum Außengewindedrehen

Reference / Bezeichnung	l	d	p	TIN25	TL20
11ER-A55	11,00	6,35	55°	○	○
16ER-A55	16,00	9,52	55°	○	○
16ER-AG55	16,00	9,52	55°	●	○
16ER-G55	16,00	9,52	55°	○	○
22ER-N55	22,00	12,70	55°	○	○
27ER-S55	27,00	15,87	55°	○	○

EL-55°

Partial profile thread forms - External inserts 60°-55° (non topping)
Wendeschneidplatten (Teilprofil) 60°/55° zum Außengewindedrehen

Reference / Bezeichnung	l	d	p	TIN25	TL20
11EL-A55	11,00	6,35	55°	○	○
16EL-A55	16,00	9,52	55°	○	○
16EL-AG55	16,00	9,52	55°	○	○
16EL-G55	16,00	9,52	55°	○	○
22EL-N55	22,00	12,70	55°	○	○
27EL-S55	27,00	15,87	55°	○	○

ER-60° TD

Partial profile thread forms - External inserts 60°-55° (non topping)
Wendeschneidplatten (Teilprofil) 60°/55° zum Außengewindedrehen

Reference / Bezeichnung	l	d	p	TIN25	TL20
16ER-AG60 TD	16,00	9,52	60°	●	○

ER-55° TD

Partial profile thread forms - External inserts 60°-55° (non topping)
Wendeschneidplatten (Teilprofil) 60°/55° zum Außengewindedrehen

Reference / Bezeichnung	l	d	p	TIN25	TL20
16ER-AG55 TD	16,00	9,52	55°	●	○



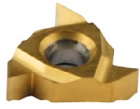

NR

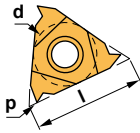

NR

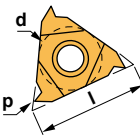

NL



NR-TD

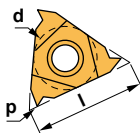

NR-60°

Partial profile thread forms - Internal inserts 60°-55° (non topping)
Wendeschneidplatten (Teilprofil) 60°/55° zum Innengewindedrehen

Reference / Bezeichnung	l	d	p	TIN25	TL20
06NR-A60	6,00	3,96	60°	○	○
08NR-A60	8,00	4,76	60°	○	○
11NR-A60	11,00	6,35	60°	●	○
16NR-A60	16,00	9,52	60°	○	○
16NR-AG60	16,00	9,52	60°	●	○
16NR-G60	16,00	9,52	60°	○	○
22NR-N60	22,00	12,70	60°	●	○
27NR-S60	27,00	15,87	60°	○	○

NL-60°

Partial profile thread forms - Internal inserts 60°-55° (non topping)
Wendeschneidplatten (Teilprofil) 60°/55° zum Innengewindedrehen

Reference / Bezeichnung	l	d	p	TIN25	TL20
06NL-A60	6,00	3,96	60°	○	○
08NL-A60	8,00	4,76	60°	○	○
11NL-A60	11,00	6,35	60°	○	○
16NL-A60	16,00	9,52	60°	○	○
16NL-AG60	16,00	9,52	60°	○	○
16NL-G60	16,00	9,52	60°	○	○
22NL-N60	22,00	12,70	60°	○	○
27NL-S60	27,00	15,87	60°	○	○

NR-55°

Partial profile thread forms - Internal inserts 60°-55° (non topping)
Wendeschneidplatten (Teilprofil) 60°/55° zum Innengewindedrehen

Reference / Bezeichnung	l	d	p	TIN25	TL20
06NR-A55	6,00	3,96	55°	○	○
08NR-A55	8,00	4,76	55°	○	○
11NR-A55	11,00	6,35	55°	○	○
16NR-A55	16,00	9,52	55°	○	○
16NR-AG55	16,00	9,52	55°	●	○
16NR-G55	16,00	9,52	55°	●	○
22NR-N55	22,00	12,70	55°	○	○
27NR-S55	27,00	15,87	55°	○	○

NL-55°

Partial profile thread forms - Internal inserts 60°-55° (non topping)
Wendeschneidplatten (Teilprofil) 60°/55° zum Innengewindedrehen

Reference / Bezeichnung	l	d	p	TIN25	TL20
06NL-A55	6,00	3,96	55°	○	○
08NL-A55	8,00	4,76	55°	○	○
11NL-A55	11,00	6,35	55°	○	○
16NL-A55	16,00	9,52	55°	○	○
16NL-AG55	16,00	9,52	55°	○	○
16NL-G55	16,00	9,52	55°	○	○
22NL-N55	22,00	12,70	55°	○	○
27NL-S55	27,00	15,87	55°	○	○

NR-60° TD

Partial profile thread forms - Internal inserts 60°-55° (non topping)
Wendeschneidplatten (Teilprofil) 60°/55° zum Innengewindedrehen

Reference / Bezeichnung	l	d	p	TIN25	TL20
16NR-AG60 TD	16,00	9,52	60°	●	○

NR-55° TD

Partial profile thread forms - Internal inserts 60°-55° (non topping)
Wendeschneidplatten (Teilprofil) 60°/55° zum Innengewindedrehen

Reference / Bezeichnung	l	d	p	TIN25	TL20
16NR-AG55 TD	16,00	9,52	55°	●	○



ER

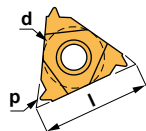

ER

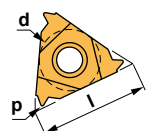

EL

ER-ISO

Mechanical thread forms - External inserts **ISO (full form) BS36**
Mechanische Gewindeformen / **ISO (Vollprofil) BS36** Wendeschneidplatten zum Außendrehen

Reference / Bezeichnung	l	d	p	TIN25	TL20
11ER-030ISO	11,00	6,35	0,30	○	○
11ER-040ISO	11,00	6,35	0,40	○	○
11ER-045ISO	11,00	6,35	0,45	○	○
11ER-050ISO	11,00	6,35	0,50	○	○
11ER-060ISO	11,00	6,35	0,60	○	○
11ER-070ISO	11,00	6,35	0,70	○	○
11ER-075ISO	11,00	6,35	0,75	○	○
11ER-080ISO	11,00	6,35	0,80	○	○
11ER-100ISO	11,00	6,35	1,00	○	○
11ER-125ISO	11,00	6,35	1,25	○	○
11ER-150ISO	11,00	6,35	1,50	○	○
11ER-175ISO	11,00	6,35	1,75	○	○
16ER-075ISO	16,00	9,52	0,75	○	○
16ER-100ISO	16,00	9,52	1,00	○	○
16ER-125ISO	16,00	9,52	1,25	○	○
16ER-150ISO	16,00	9,52	1,50	○	○
16ER-175ISO	16,00	9,52	1,75	○	○
16ER-200ISO	16,00	9,52	2,00	○	○
16ER-250ISO	16,00	9,52	2,50	○	○
16ER-300ISO	16,00	9,52	3,00	○	○
22ER-350ISO	22,00	12,70	3,50	○	○
22ER-400ISO	22,00	12,70	4,00	○	○
22ER-450ISO	22,00	12,70	4,50	○	○
22ER-500ISO	22,00	12,70	5,00	○	○
27ER-500ISO	27,00	15,87	5,00	○	○
27ER-550ISO	27,00	15,87	5,50	○	○
27ER-600ISO	27,00	15,87	6,00	○	○
27ER-800ISO	27,00	15,87	8,00	○	○

EL-ISO

Mechanical thread forms - External inserts **ISO (full form) BS36**
Mechanische Gewindeformen / **ISO (Vollprofil) BS36** Wendeschneidplatten zum Außendrehen

Reference / Bezeichnung	l	d	p	TIN25	TL20
16EL-100ISO	16,00	9,52	1,00	○	○
16EL-125ISO	16,00	9,52	1,25	○	○
16EL-150ISO	16,00	9,52	1,50	○	○
16EL-175ISO	16,00	9,52	1,75	○	○
16EL-200ISO	16,00	9,52	2,00	○	○
16EL-250ISO	16,00	9,52	2,50	○	○
16EL-300ISO	16,00	9,52	3,00	○	○
22EL-400ISO	22,00	12,70	4,00	○	○



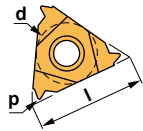

NR-ISO

Mechanical thread forms - Internal inserts **ISO (full form) BS36**
Mechanische Gewindeformen / **ISO (Vollprofil) BS36** Wendeschneidplatten zum Innendrehen

Reference / Bezeichnung	l	d	p	TIN25	TL20
06NR-050ISO	6,00	3,96	0,50	○	
06NR-075ISO	6,00	3,96	0,75	○	
06NR-100ISO	6,00	3,96	1,00	○	
06NR-125ISO	6,00	3,96	1,25	○	
08NR-050ISO	8,00	4,76	0,50	○	
08NR-075ISO	8,00	4,76	0,75	○	
08NR-100ISO	8,00	4,76	1,00	○	
08NR-125ISO	8,00	4,76	1,25	○	
08NR-150ISO	8,00	4,76	1,50	○	
08NR-175ISO	8,00	4,76	1,75	○	
11NR-035ISO	11,00	6,35	0,35	○	
11NR-040ISO	11,00	6,35	0,40	○	
11NR-045ISO	11,00	6,35	0,45	○	
11NR-050ISO	11,00	6,35	0,50	○	
11NR-060ISO	11,00	6,35	0,60	○	
11NR-070ISO	11,00	6,35	0,70	○	
11NR-075ISO	11,00	6,35	0,75	○	
11NR-080ISO	11,00	6,35	0,80	○	
11NR-100ISO	11,00	6,35	1,00	○	
11NR-125ISO	11,00	6,35	1,25	○	
11NR-150ISO	11,00	6,35	1,50	○	
11NR-175ISO	11,00	6,35	1,75	○	
11NR-200ISO	11,00	6,35	2,00	○	
11NR-250ISO	11,00	6,35	2,50	○	
16NR-075ISO	16,00	9,52	0,75	○	
16NR-100ISO	16,00	9,52	1,00	○	
16NR-125ISO	16,00	9,52	1,25	○	
16NR-150ISO	16,00	9,52	1,50	○	
16NR-175ISO	16,00	9,52	1,75	○	
16NR-200ISO	16,00	9,52	2,00	○	
16NR-250ISO	16,00	9,52	2,50	○	
16NR-300ISO	16,00	9,52	3,00	○	
22NR-350ISO	22,00	12,70	3,50	○	
22NR-400ISO	22,00	12,70	4,00	○	
22NR-450ISO	22,00	12,70	4,50	○	
22NR-500ISO	22,00	12,70	5,00	○	
27NR-500ISO	27,00	15,87	5,00	○	
27NR-550ISO	27,00	15,87	5,50	○	
27NR-600ISO	27,00	15,87	6,00	○	
27NR-800ISO	27,00	15,87	8,00	○	



NL ISO

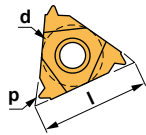

NL

NL-ISO

Mechanical thread forms - Internal inserts **ISO (full form) BS36**
Mechanische Gewindeformen / **ISO (Vollprofil) BS36** Wendeschneidplatten zum Innendrehen

Reference / Bezeichnung	l	d	p	TIN25	TL20
06NL-050ISO	6,00	3,96	0,50	○	○
06NL-075ISO	6,00	3,96	0,75	○	○
06NL-100ISO	6,00	3,96	1,00	○	○
06NL-125ISO	6,00	3,96	1,25	○	○
08NL-050ISO	8,00	4,76	0,50	○	○
08NL-075ISO	8,00	4,76	0,75	○	○
08NL-100ISO	8,00	4,76	1,00	○	○
08NL-125ISO	8,00	4,76	1,25	○	○
08NL-150ISO	8,00	4,76	1,50	○	○
08NL-175ISO	8,00	4,76	1,75	○	○
11NL-100ISO	11,00	6,35	1,00	○	○
11NL-150ISO	11,00	6,35	1,50	○	○
16NL-100ISO	16,00	9,52	1,00	○	○
16NL-125ISO	16,00	9,52	1,25	○	○
16NL-150ISO	16,00	9,52	1,50	○	○
16NL-175ISO	16,00	9,52	1,75	○	○
16NL-200ISO	16,00	9,52	2,00	○	○
16NL-250ISO	16,00	9,52	2,50	○	○
16NL-300ISO	16,00	9,52	3,00	○	○
22NL-400ISO	22,00	12,70	4,00	○	○



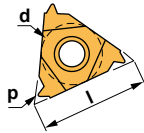
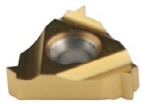

ER

ER-W

Mechanical thread forms - External and internal inserts **WHITWORTH (full form) BS84**
Mechanische Gewindeformen / **WHITWORTH (Vollprofil) BS84** Wendeschneidplatten zum Außen- und Innendrehen

Reference / Bezeichnung	l	d	p	TIN25	TL20
11ER-14W	11,00	6,35	14,0	○	
11ER-16W	11,00	6,35	16,0	○	
11ER-18W	11,00	6,35	18,0	○	
11ER-19W	11,00	6,35	19,0	○	
11ER-22W	11,00	6,35	22,0	○	
11ER-24W	11,00	6,35	24,0	○	
11ER-26W	11,00	6,35	26,0	○	
11ER-28W	11,00	6,35	28,0	○	
11ER-40W	11,00	6,35	40,0	○	
11ER-50W	11,00	6,35	50,0	○	
11ER-56W	11,00	6,35	56,0	○	
16ER-8W	16,00	9,52	8,0	○	
16ER-9W	16,00	9,52	9,0	○	
16ER-10W	16,00	9,52	10,0	○	
16ER-11W	16,00	9,52	11,0	○	
16ER-12W	16,00	9,52	12,0	○	
16ER-14W	16,00	9,52	14,0	○	
16ER-16W	16,00	9,52	16,0	○	
16ER-18W	16,00	9,52	18,0	○	
16ER-19W	16,00	9,52	19,0	○	
16ER-20W	16,00	9,52	20,0	○	
16ER-22W	16,00	9,52	22,0	○	
16ER-24W	16,00	9,52	24,0	○	
16ER-26W	16,00	9,52	26,0	○	
16ER-28W	16,00	9,52	28,0	○	
22ER-4W	22,00	12,70	4,0	○	
22ER-4.5W	22,00	12,70	4,5	○	
22ER-5W	22,00	12,70	5,0	○	
22ER-6W	22,00	12,70	6,0	○	
22ER-7W	22,00	12,70	7,0	○	
22ER-8W	22,00	12,70	8,0	○	
27ER-4W	27,00	15,87	4,0	○	
27ER-4.5W	27,00	15,87	4,5	○	



EL-W

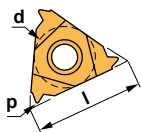

EL

EL-W

Mechanical thread forms - External and internal inserts **WHITWORTH (full form) BS84**
Mechanische Gewindeformen / **WHITWORTH (Vollprofil) BS84** Wendeschneidplatten zum Außen- und Innendrehen

Reference / Bezeichnung	l	d	p	TIN25	TL20
16EL-11W	16,00	9,52	11,0	○	
16EL-14W	16,00	9,52	14,0	○	
16EL-20W	16,00	9,52	20,0	○	

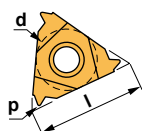
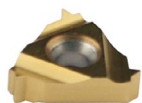

NR

NR-W

Mechanische Gewindeformen / WHITWORTH (Vollprofil) BS84 Wendeschneidplatten zum Innendrehen

Reference / Bezeichnung	l	d	p	TIN25	TL20
06NR-18W	6,00	3,96	18,0	○	
06NR-19W	6,00	3,96	19,0	○	
06NR-20W	6,00	3,96	20,0	○	
06NR-22W	6,00	3,96	22,0	○	
06NR-26W	6,00	3,96	26,0	○	
08NR-16W	8,00	4,76	16,0	○	
08NR-18W	8,00	4,76	18,0	○	
08NR-19W	8,00	4,76	19,0	○	
08NR-20W	8,00	4,76	20,0	○	
08NR-24W	8,00	4,76	24,0	○	
08NR-28W	8,00	4,76	28,0	○	
11NR-11W	11,00	6,35	11,0	○	
11NR-12W	11,00	6,35	12,0	○	
11NR-14W	11,00	6,35	14,0	○	
11NR-16W	11,00	6,35	16,0	○	
11NR-18W	11,00	6,35	18,0	○	
11NR-19W	11,00	6,35	19,0	○	
11NR-20W	11,00	6,35	20,0	○	
11NR-22W	11,00	6,35	22,0	○	
11NR-24W	11,00	6,35	24,0	○	
11NR-26W	11,00	6,35	26,0	○	
11NR-28W	11,00	6,35	28,0	○	
11NR-32W	11,00	6,35	32,0	○	
11NR-36W	11,00	6,35	36,0	○	
11NR-40W	11,00	6,35	40,0	○	
11NR-48W	11,00	6,35	48,0	○	
16NR-8W	16,00	9,52	8,0	○	
16NR-9W	16,00	9,52	9,0	○	
16NR-10W	16,00	9,52	10,0	○	
16NR-11W	16,00	9,52	11,0	○	
16NR-12W	16,00	9,52	12,0	○	
16NR-14W	16,00	9,52	14,0	○	
16NR-16W	16,00	9,52	16,0	○	
16NR-18W	16,00	9,52	18,0	○	
16NR-19W	16,00	9,52	19,0	○	
16NR-20W	16,00	9,52	20,0	○	
16NR-22W	16,00	9,52	22,0	○	
16NR-24W	16,00	9,52	24,0	○	
16NR-26W	16,00	9,52	26,0	○	
16NR-28W	16,00	9,52	28,0	○	
22NR-4W	22,00	12,70	4,0	○	
22NR-4.5W	22,00	12,70	4,5	○	
22NR-5W	22,00	12,70	5,0	○	
22NR-6W	22,00	12,70	6,0	○	
22NR-7W	22,00	12,70	7,0	○	



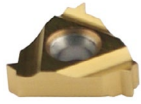

NL-W

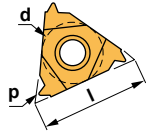

NL

NL-W

Mechanical thread forms - Internal inserts **WHITWORTH (full form) BS84**
Mechanische Gewindeformen / **WHITWORTH (Vollprofil) BS84** Wendeschneidplatten zum Innendrehen

Reference / Bezeichnung	l	d	p
06NL-18W	6,00	3,96	18,0
06NL-20W	6,00	3,96	20,0
06NL-22W	6,00	3,96	22,0
06NL-26W	6,00	3,96	26,0
08NL-16W	8,00	4,76	16,0
08NL-18W	8,00	4,76	18,0
08NL-19W	8,00	4,76	19,0
08NL-20W	8,00	4,76	20,0
08NL-24W	8,00	4,76	24,0
08NL-28W	8,00	4,76	28,0
16NL-11W	16,00	9,52	11,0
16NL-14W	16,00	9,52	14,0
16NL-16W	16,00	9,52	16,0

TIN25	TL20
<input type="radio"/>	<input type="radio"/>
<input type="radio"/>	<input type="radio"/>
<input type="radio"/>	<input type="radio"/>
<input type="radio"/>	<input type="radio"/>
<input type="radio"/>	<input type="radio"/>
<input type="radio"/>	<input type="radio"/>
<input type="radio"/>	<input type="radio"/>
<input type="radio"/>	<input type="radio"/>
<input type="radio"/>	<input type="radio"/>
<input type="radio"/>	<input type="radio"/>
<input type="radio"/>	<input type="radio"/>
<input type="radio"/>	<input type="radio"/>
<input type="radio"/>	<input type="radio"/>
<input type="radio"/>	<input type="radio"/>
<input type="radio"/>	<input type="radio"/>

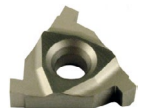

ER-LG

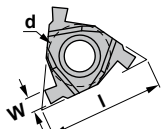

ER

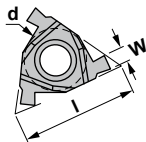

EL

ER-LG

External lock ring grooving inserts - Type LG
Außeneinstechplatten für Sicherungsringnuten Typ LG

Reference / Bezeichnung	l	d	W
16ER-100LG	16,00	9,52	1,15
16ER-120LG	16,00	9,52	1,35
16ER-150LG	16,00	9,52	1,65
16ER-175LG	16,00	9,52	1,90
16ER-200LG	16,00	9,52	2,15
16ER-250LG	16,00	9,52	2,65

TIN25	TL20
<input type="radio"/>	<input checked="" type="radio"/>
<input type="radio"/>	<input checked="" type="radio"/>
<input type="radio"/>	<input checked="" type="radio"/>
<input type="radio"/>	<input checked="" type="radio"/>
<input type="radio"/>	<input checked="" type="radio"/>
<input type="radio"/>	<input checked="" type="radio"/>

EL-LG

External lock ring grooving inserts - Type LG
Außeneinstechplatten für Sicherungsringnuten Typ LG

Reference / Bezeichnung	l	d	W
16EL-100LG	16,00	9,52	1,15
16EL-120LG	16,00	9,52	1,35
16EL-150LG	16,00	9,52	1,65
16EL-175LG	16,00	9,52	1,90
16EL-200LG	16,00	9,52	2,15

TIN25	TL20
<input type="radio"/>	<input checked="" type="radio"/>
<input type="radio"/>	<input checked="" type="radio"/>
<input type="radio"/>	<input checked="" type="radio"/>
<input type="radio"/>	<input checked="" type="radio"/>
<input type="radio"/>	<input checked="" type="radio"/>
<input type="radio"/>	<input checked="" type="radio"/>

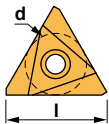
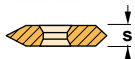

TNMC

Triangular negative insert for threading.
Dreikantige negative Wendeschneidplatte zum Gewindedrehen.

Reference / Bezeichnung	l	s	d
TNMC 1603XX	16,50	3,18	9,52
TNMC 2204XX	22,00	4,76	12,70

PM25	TN15
<input checked="" type="radio"/>	<input type="radio"/>
<input type="radio"/>	<input type="radio"/>

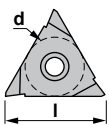
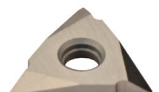

TPMC

Triangular positive insert for threading.
Dreikantige positive Wendeschneidplatte zum Gewindedrehen.

Reference / Bezeichnung	l	s	d
TPMC 1603XX	16,50	3,18	9,52
TPMC 2204XX	22,00	4,76	12,70

PM25	TN15
<input type="radio"/>	<input type="radio"/>
<input type="radio"/>	<input type="radio"/>

External threading Außengewindedrehen

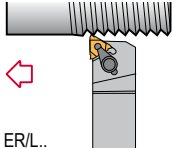
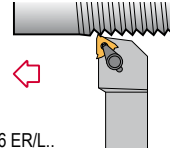
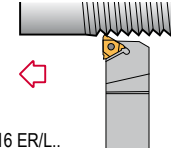
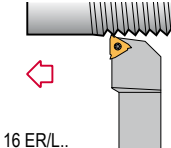
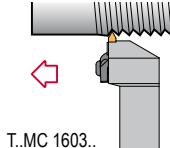
<p>CTAN 90°</p>  <p>16 ER/L... 22 ER/L... 27 ER/L...</p> <p>Page Seite C12</p>	<p>CTXN 90°</p>  <p>16 ER/L... 22 ER/L... 27 ER/L...</p> <p>Page Seite C13</p>	<p>STAN 90°</p>  <p>16 ER/L... 22 ER/L... 27 ER/L...</p> <p>Page Seite C14</p>	<p>STXN 90°</p>  <p>16 ER/L... 22 ER/L... 27 ER/L...</p> <p>Page Seite C15</p>	<p>STCN 90°</p>  <p>T.MC 1603.. T.MC 2204.. T.MC 2706..</p> <p>Page Seite C16</p>
--	--	--	---	---

Internal threading Innengewindedrehen

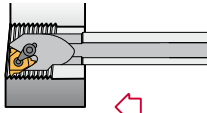
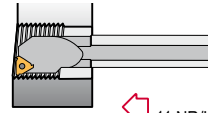
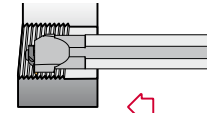
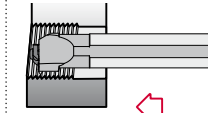
<p>CTXN 90°</p>  <p>Page Seite C17</p> <p>16 NR/L... 22 NR/L... 27 NR/L...</p>	<p>STXN 90°</p>  <p>Page Seite C18</p> <p>11 NR/L... 16 NR/L... 22 NR/L... 27 NR/L...</p>	<p>STGN 90°</p>  <p>Page Seite C19</p> <p>TNMC 1603.. TNMC 2204.. TNMC 2706..</p>	<p>STGP 90°</p>  <p>Page Seite C20</p> <p>TPMC 1603.. TPMC 2204..</p>	
--	---	---	--	--



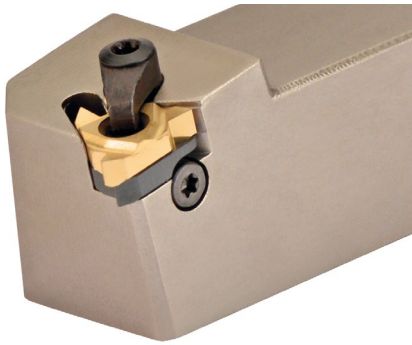

Characteristics:
Multipurpose top clamp threading toolholder for negative lay down inserts.

Eigenschaften:
Multifunktionaler Klemmhalter mit oberer Klemmung zum Außengewindedrehen für negative Gewindeplatten.

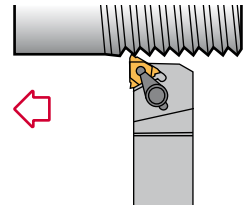
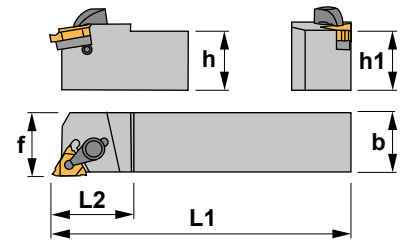

CTAN 90°

Reference Bezeichnung	h=h1	b	L1	L2	f	Insert size Wendeschnidplatte	Kg
CTAN R/L 2020 K16	20	20	125	28	20	16 ER/L..	0,400
CTAN R/L 2525 M16	25	25	150	28	25	16 ER/L..	0,700
CTAN R/L 3232 P16	32	32	170	28	32	16 ER/L..	1,050
CTAN R/L 2525 M22	25	25	150	34	25	22 ER/L..	0,700
CTAN R/L 3232 P22	32	32	170	34	32	22 ER/L..	1,300
CTAN R/L 4040 R22	40	40	200	36	40	22 ER/L..	3,000
CTAN R/L 3232 P27	32	32	170	34	32	27 ER/L..	1,300
CTAN R/L 4040 R27	40	40	200	40	40	27 ER/L..	3,000
CTAN R/L 5050 S27	50	50	250	40	50	27 ER/L..	5,800

WARNING!! Because of large thread profile, modification may have to be made to the toolholder to achieve full depth of thread.
ACHTUNG!! Bei großen Gewindeprofils eine Änderung im Klemmhalter könnte erforderlich sein, um die volle Gewindetiefe zu erreichen.

Reference Bezeichnung								Nm
CTAN R/L 2020 K16	2516	5515	5510	YE3	YI3	SY3	SA3	2.0
CTAN R/L 2525 M16	2516	5515	5510	YE3	YI3	SY3	SA3	2.0
CTAN R/L 3232 P16	2516	5515	-	YE3	YI3	SY3	SA3	-
CTAN R/L 2525 M22	2522	5515	5520	YE4	YI4	SY4	SA4	4.0
CTAN R/L 3232 P22	2522	5515	5520	YE4	YI4	SY4	SA4	4.0
CTAN R/L 4040 R22	2522	5515	5520	YE4	YI4	SY4	SA4	4.0
CTAN R/L 3232 P27	2527	5525	-	YE5	YI5	SY5	SA5	-
CTAN R/L 4040 R27	2527	5525	-	YE5	YI5	SY5	SA5	-
CTAN R/L 5050 S27	2527	5525	-	YE5	YI5	SY5	SA5	-

Optional

E R/L

Triangular negative inserts for external threading. Dreikantige negative Wendeschnidplatten zum Außengewindedrehen. C03,05,08,10

Reference / Bez.	l	d
16 ER/L..	16,00	9,52
22 ER/L..	22,00	12,70
27 ER/L..	27,50	15,88

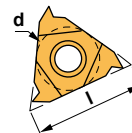



Characteristics:
Multipurpose top clamp threading toolholder for negative lay down inserts.

Eigenschaften:
Multifunktionaler Klemmhalter mit oberer Klemmung zum Außengewindedrehen für negative Gewindeplatten.

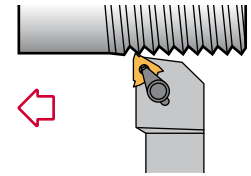
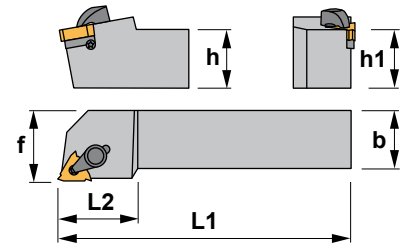

CTXN 90°

Reference Bezeichnung	h=h1	b	L1	L2	f	Insert size Wendschneidplatte	kg
CTXN R/L 1212 F16	12	12	80	25	16	16 ER/L..	0,100
CTXN R/L 1616 H16	16	16	100	25	20	16 ER/L..	0,200
CTXN R/L 2020 K16	20	20	125	28	25	16 ER/L..	0,400
CTXN R/L 2525 M16	25	25	150	28	32	16 ER/L..	0,700
CTXN R/L 3232 P16	32	32	170	28	40	16 ER/L..	1,050
CTXN R/L 2525 M22	25	25	150	34	32	22 ER/L..	0,700
CTXN R/L 3232 P22	32	32	170	34	40	22 ER/L..	1,300
CTXN R/L 4040 R22	40	40	200	36	50	22 ER/L..	3,000
CTXN R/L 2525 M27	25	25	150	34	32	27 ER/L..	0,700
CTXN R/L 3232 P27	32	32	170	34	40	27 ER/L..	1,300
CTXN R/L 4040 R27	40	40	200	40	50	27 ER/L..	3,000
CTXN R/L 5050 S27	50	50	250	50	60	27 ER/L..	5,800

WARNING!! Because of large thread profile, modification may have to be made to the toolholder to achieve full depth of thread.
ACHTUNG!! Bei großen Gewindeprofilen eine Änderung im Klemmhalter könnte erforderlich sein, um die volle Gewindetiefe zu erreichen.

Reference Bezeichnung							Nm
CTXN R/L 1212 F16	2516	5515	YE3	YI3	SY3	SA3	3.0
CTXN R/L 1616 H16	2516	5515	YE3	YI3	SY3	SA3	3.0
CTXN R/L 2020 K16	2516	5515	YE3	YI3	SY3	SA3	3.0
CTXN R/L 2525 M16	2516	5515	YE3	YI3	SY3	SA3	3.0
CTXN R/L 3232 P16	2516	5515	YE3	YI3	SY3	SA3	3.0
CTXN R/L 2525 M22	2522	5515	YE4	YI4	SY4	SA4	3.0
CTXN R/L 3232 P22	2522	5515	YE4	YI4	SY4	SA4	3.0
CTXN R/L 4040 R22	2522	5515	YE4	YI4	SY4	SA4	3.0
CTXN R/L 2525 M27	2527	5525	YE5	YI5	SY5	SA5	5.0
CTXN R/L 3232 P27	2527	5525	YE5	YI5	SY5	SA5	5.0
CTXN R/L 4040 R27	2527	5525	YE5	YI5	SY5	SA5	5.0
CTXN R/L 5050 S27	2527	5525	YE5	YI5	SY5	SA5	5.0

Optional

E R/L

Triangular negative inserts for external threading. Dreikantige negative Wendschneidplatten zum Außengewindedrehen. ⓘ C03,05,08,10

Reference / Bez.	l	d
16 ER/L..	16,00	9,52
22 ER/L..	22,00	12,70
27 ER/L..	27,50	15,88

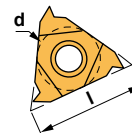

E R/L	E R/L TD
ER/L-LG	



Characteristics:
Multipurpose threading toolholder for negative lay down inserts.

Eigenschaften:
Multifunktionaler Klemmhalter zum Gewindedrehen für negative Gewindeplatten.

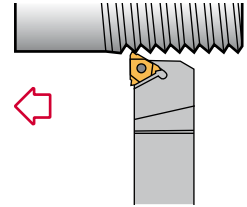
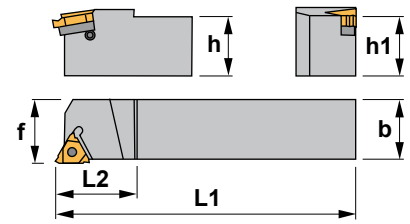

STAN 90°

Reference Bezeichnung	h=h1	b	L1	L2	f	Insert size Wendeschneidplatte	
STAN R/L 1616 H16	16	16	100	22	16	16 ER/L..	0,070
STAN R/L 2020 K16	20	20	125	28	20	16 ER/L..	0,100
STAN R/L 2525 M16	25	25	150	28	25	16 ER/L..	0,140
STAN R/L 3232 P16	32	32	170	28	32	16 ER/L..	0,200
STAN R/L 2525 M22	25	25	150	34	25	22 ER/L..	0,270
STAN R/L 3232 P22	32	32	175	34	32	22 ER/L..	0,400
STAN R/L 4040 R22	40	40	200	34	40	22 ER/L..	0,700
STAN R/L 3232 P27	32	32	170	34	32	27 ER/L..	1,300
STAN R/L 4040 R27	40	40	200	34	40	27 ER/L..	0,700
STAN R/L 5050 S27	50	50	250	34	50	27 ER/L..	1,300

WARNING!! Because of large thread profile, modification may have to be made to the toolholder to achieve full depth of thread.
ACHTUNG!! Bei großen Gewindeprofilen eine Änderung im Klemmhalter könnte erforderlich sein, um die volle Gewindetiefe zu erreichen.

Reference Bezeichnung			 R	 L		Nm
STAN R/L 1616 H16	SA3	5510	YE3	YI3	SY3	2.0
STAN R/L 2020 K16	SA3	5510	YE3	YI3	SY3	2.0
STAN R/L 2525 M16	SA3	5510	YE3	YI3	SY3	2.0
STAN R/L 3232 P16	SA3	5510	YE3	YI3	SY3	2.0
STAN R/L 2525 M22	SA4	5520	YE4	YI4	SY4	4.0
STAN R/L 3232 P22	SA4	5520	YE4	YI4	SY4	4.0
STAN R/L 4040 R22	SA4	5520	YE4	YI4	SY4	4.0
STAN R/L 3232 P27	SA5	5525	YE5	YI5	SY5	5.0
STAN R/L 4040 R27	SA5	5525	YE5	YI5	SY5	5.0
STAN R/L 5050 S27	SA5	5525	YE5	YI5	SY5	5.0

E R/L

Triangular negative inserts for external threading. Dreikantige negative Wendeschneidplatten zum Außengewindedrehen.  C03,05,08,10

Reference / Bez.	l	d
16 ER/L..	16,00	9,52
22 ER/L..	22,00	12,70
27 ER/L..	27,50	15,88

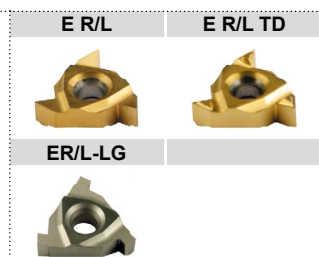
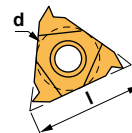



Characteristics:
Multipurpose threading toolholder for negative lay down inserts.

Eigenschaften:
Multifunktionaler Klemmhalter zum Gewindedrehen für negative Gewindeplatten.

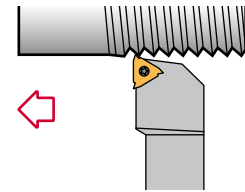
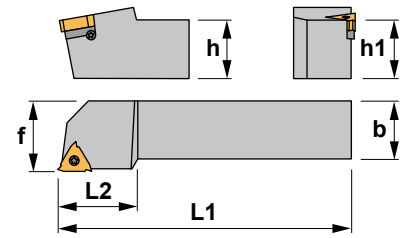

STXN 90°

Reference Bezeichnung	h=h1	b	L1	L2	f	Insert size Wendeschneidplatte	
STXN R/L 1212 F16	12	12	80	25	16	16 ER/L..	0,100
STXN R/L 1616 H16	16	16	100	25	20	16 ER/L..	0,200
STXN R/L 2020 K16	20	20	125	28	25	16 ER/L..	0,400
STXN R/L 2525 M16	25	25	150	28	32	16 ER/L..	0,700
STXN R/L 3232 P16	32	32	170	28	40	16 ER/L..	1,050
STXN R/L 2525 M22	25	25	150	34	32	22 ER/L..	0,700
STXN R/L 3232 P22	32	32	170	34	40	22 ER/L..	1,300
STXN R/L 4040 R22	40	40	200	34	50	22 ER/L..	3,000
STXN R/L 2525 M27	25	25	150	34	32	27 ER/L..	0,700
STXN R/L 3232 P27	32	32	170	34	40	27 ER/L..	1,300
STXN R/L 4040 R27	40	40	200	34	50	27 ER/L..	3,000
STXN R/L 5050 S27	50	50	250	34	60	27 ER/L..	5,800

WARNING!! Because of large thread profile, modification may have to be made to the toolholder to achieve full depth of thread.
ACHTUNG!! Bei großen Gewindeprofilen eine Änderung im Klemmhalter könnte erforderlich sein, um die volle Gewindetiefe zu erreichen.

Reference Bezeichnung						Nm
STXN R/L 1212 F16	SA3T	5510	YE3	YI3	SY3	2.0
STXN R/L 1616 H16	SA3	5510	YE3	YI3	SY3	2.0
STXN R/L 2020 K16	SA3	5510	YE3	YI3	SY3	2.0
STXN R/L 2525 M16	SA3	5510	YE3	YI3	SY3	2.0
STXN R/L 3232 P16	SA3	5510	YE3	YI3	SY3	2.0
STXN R/L 2525 M22	SA4	5520	YE4	YI4	SY4	4.0
STXN R/L 3232 P22	SA4	5520	YE4	YI4	SY4	4.0
STXN R/L 4040 R22	SA4	5520	YE4	YI4	SY4	4.0
STXN R/L 2525 M27	SA5	5525	YE5	YI5	SY5	5.0
STXN R/L 3232 P27	SA5	5525	YE5	YI5	SY5	5.0
STXN R/L 4040 R27	SA5	5525	YE5	YI5	SY5	5.0
STXN R/L 5050 S27	SA5	5525	YE5	YI5	SY5	5.0

E R/L

Triangular negative inserts for external threading. Dreikantige negative Wendeschneidplatten zum Außengewindedrehen. C03,05,08,10

Reference / Bez.	l	d
16 ER/L..	16,00	9,52
22 ER/L..	22,00	12,70
27 ER/L..	27,50	15,88

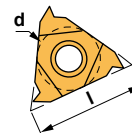

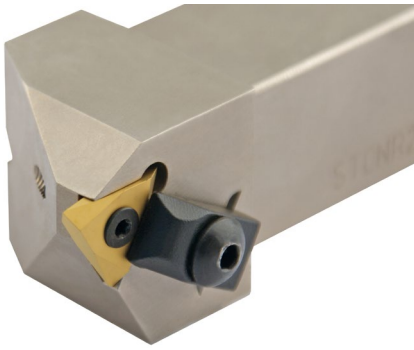

Characteristics:
Vertical on edge threading toolholder.

Eigenschaften:
Klemhalter zum Vertikal-Gewindedrehen
auf der Kante.

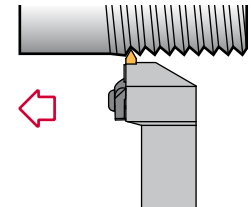
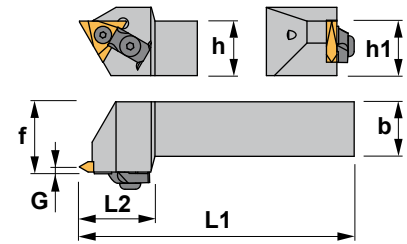

STCN 90°

Reference Bezeichnung	h=h1	b	L1	L2	f	G	Insert size Wendeschneidplatte	⚖ Kg
STCN R/L 1212 F16	12	12	80	25	16	1,59	TNMC/TPMC 1603..	0,100
STCN R/L 1616 H16	16	16	100	25	19	1,59	TNMC/TPMC 1603..	0,200
STCN R/L 2020 K16	20	20	125	28	22	1,59	TNMC/TPMC 1603..	0,400
STCN R/L 2525 M16	25	25	150	34	32	1,59	TNMC/TPMC 1603..	0,700
STCN R/L 3232 P16	32	32	170	34	38	1,59	TNMC/TPMC 1603..	1,050
STCN R/L 2020 K22	20	20	125	34	22	2,38	TNMC/TPMC 2204..	0,400
STCN R/L 2525 M22	25	25	150	34	32	2,38	TNMC/TPMC 2204..	0,700
STCN R/L 3225 P22	32	25	170	34	32	2,38	TNMC/TPMC 2204..	1,025
STCN R/L 3232 P22	32	32	170	34	38	2,38	TNMC/TPMC 2204..	1,050
STCN R/L 2525 M27	25	25	150	38	32	2,38	TNMC/TPMC 2706..	0,700
STCN R/L 3232 P27	32	32	170	42	38	2,38	TNMC/TPMC 2706..	1,050

Reference Bezeichnung						Nm ¹	Nm ²
STCN R/L 1212 F16	1935	-	-	-	-	-	-
STCN R/L 1616 H16	1935	-	-	-	-	-	-
STCN R/L 2020 K16	1935	2101	1815	5003	5002	3.0	1.4
STCN R/L 2525 M16	1935	2101	1815	5003	5002	3.0	1.4
STCN R/L 3232 P16	1935	2101	1815	5003	5002	3.0	1.4
STCN R/L 2020 K22	1950	2101	1815	5003	5025	3.0	2.0
STCN R/L 2525 M22	1950	2101	1815	5003	5025	3.0	2.0
STCN R/L 3225 P22	1950	2101	1815	5003	5025	3.0	2.0
STCN R/L 3232 P22	1950	2101	1815	5003	5025	3.0	2.0
STCN R/L 2525 M27	1955	2101	1815	-	5003	3.0	3.0
STCN R/L 3232 P27	1955	2101	1815	-	5003	3.0	3.0

TNMC/TPMC

Triangular negative and positive inserts for external threading. C10
Dreikantige negative und positive WSP zum Außengewindedrehen.

Reference / Bez.	l	s	d
T..MC 1603..	16,50	3,18	9,52
T..MC 2204..	22,00	4,76	12,70
T..MC 2706..	27,00	6,35	15,88

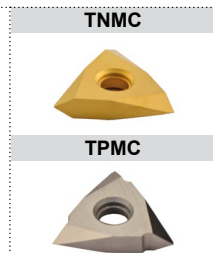
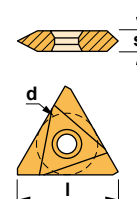



Characteristics:

Multipurpose top clamp threading boring bar for negative lay down inserts.

Eigenschaften:

Multifunktionale Bohrstanze mit oberer Klemmung zum Innengewindedrehen für negative Gewindeplatten.

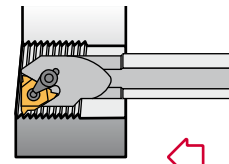
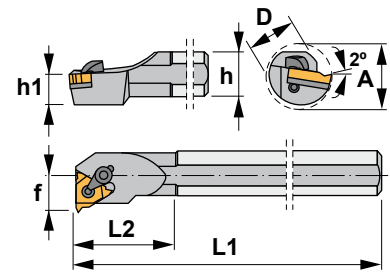

CTXN 90°

Reference Bezeichnung	D	h	h1	L1	L2	f	A	Insert size Wendeschneidplatte	kg
S20Q CTXN R/L 16	20	18	9,0	180	35	13,0	24	16 NR/L..	0,400
S25R CTXN R/L 16	25	23	11,5	200	40	17,0	29	16 NR/L..	0,700
S32S CTXN R/L 16	32	30	15,0	250	45	22,0	36	16 NR/L..	1,500
S40T CTXN R/L 16	40	37	18,5	300	50	27,0	44	16 NR/L..	2,850
S25R CTXN R/L 22	25	23	11,5	200	40	17,0	32	22 NR/L..	0,700
S32S CTXN R/L 22	32	30	15,0	250	45	22,0	39	22 NR/L..	1,500
S40T CTXN R/L 22	40	37	18,5	300	50	27,0	47	22 NR/L..	2,850
S32S CTXN R/L 27	32	30	15,0	250	45	22,4	40	27 NR/L..	1,500
S40T CTXN R/L 27	40	37	18,5	300	50	26,4	48	27 NR/L..	2,850
S50U CTXN R/L 27	50	47	23,5	350	60	31,4	58	27 NR/L..	5,200
S60V CTXN R/L 27	60	58	29,0	400	60	36,4	69	27 NR/L..	8,550

WARNING!! Because of large thread profile, modification may have to be made to the boring bar to achieve full depth of thread.
ACHTUNG!! Bei großen Gewindeprofilen eine Änderung in der Bohrstanze könnte erforderlich sein, um die volle Gewindetiefe zu erreichen.

Reference Bezeichnung			R	L			Nm
S20Q CTXN R/L 16	2516	5515	YI3	YE3	SY3	SN3	3.0
S25R CTXN R/L 16	2516	5515	YI3	YE3	SY3	SA3	3.0
S32S CTXN R/L 16	2516	5515	YI3	YE3	SY3	SA3	3.0
S40T CTXN R/L 16	2516	5515	YI3	YE3	SY3	SA3	3.0
S25R CTXN R/L 22	2522	5515	YI4	YE4	SY4	SA4	3.0
S32S CTXN R/L 22	2522	5515	YI4	YE4	SY4	SA4	3.0
S40T CTXN R/L 22	2522	5515	YI4	YE4	SY4	SA4	3.0
S32S CTXN R/L 27	2527	5525	YI5	YE5	SY5	SA5	5.0
S40T CTXN R/L 27	2527	5525	YI5	YE5	SY5	SA5	5.0
S50U CTXN R/L 27	2527	5525	YI5	YE5	SY5	SA5	5.0
S60V CTXN R/L 27	2527	5525	YI5	YE5	SY5	SA5	5.0

Optional

N R/L

Triangular negative inserts for internal threading. Dreikantige negative Wendeschneidplatten zum Innengewindedrehen. C04,06,07,09,10

Reference / Bez.

l

d

16 NR/L..	16,00	9,52
22 NR/L..	22,00	12,70
27 NR/L..	27,00	15,87

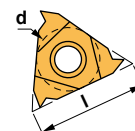

N R/L



N R/L TD





Characteristics:

Multipurpose threading boring bar for negative lay down inserts.

Eigenschaften:

Multifunktionale Bohrstanze zum Gewindedrehen für negative Gewindeplatten.

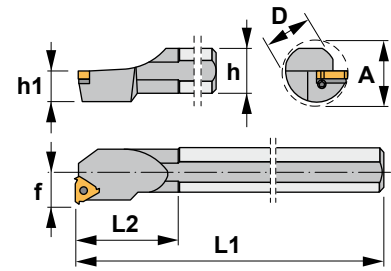
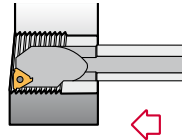

STXN 90°

Reference Bezeichnung	D	h	h1	L1	L2	f	A	Insert size Wendeschneidplatte	KG
S10K STXN R/L 11	10	9	4,5	125	16	7,3	13	11 NR/L..	0,070
S16M STXN R/L 11	16	15	7,5	150	25	8,9	16	11 NR/L..	0,200
S16M STXN R/L 16	16	15	7,5	150	30	11,5	20	16 NR/L..	0,200
S20Q STXN R/L 16	20	18	9,0	180	35	13,4	24	16 NR/L..	0,400
S25R STXN R/L 16	25	23	11,5	200	40	16,3	29	16 NR/L..	0,700
S32S STXN R/L 16	32	30	15,0	250	45	19,6	36	16 NR/L..	1,500
S40T STXN R/L 16	40	37	18,5	300	50	23,8	44	16 NR/L..	2,850
S20Q STXN R/L 22	20	18	9,0	180	35	15,6	27	22 NR/L..	0,400
S25R STXN R/L 22	25	23	11,5	200	40	17,2	32	22 NR/L..	0,700
S32S STXN R/L 22	32	30	15,0	250	45	21,5	39	22 NR/L..	1,500
S40T STXN R/L 22	40	37	18,5	300	50	25,8	47	22 NR/L..	2,850
S32S STXN R/L 27	32	30	15,0	250	45	22,4	40	27 NR/L..	1,500
S40T STXN R/L 27	40	37	18,5	300	50	26,4	48	27 NR/L..	2,850
S50U STXN R/L 27	50	47	23,5	350	60	31,4	58	27 NR/L..	5,200
S60V STXN R/L 27	60	57	28,5	400	60	36,4	69	27 NR/L..	8,550

WARNING!! Because of large thread profile, modification may have to be made to the boring bar to achieve full depth of thread.

ACHTUNG!! Bei großen Gewindeprofilen eine Änderung in der Bohrstanze könnte erforderlich sein, um die volle Gewindetiefe zu erreichen.

Reference Bezeichnung						Nm
S10K STXN R/L 11	1225	5507	-	-	-	0.9
S16M STXN R/L 11	1225	5507	-	-	-	0.9
S16M STXN R/L 16	SN3	5510	-	-	-	2.0
S20Q STXN R/L 16	SA3T	5510	YI3	YE3	SY3	2.0
S25R STXN R/L 16	SA3	5510	YI3	YE3	SY3	2.0
S32S STXN R/L 16	SA3	5510	YI3	YE3	SY3	2.0
S40T STXN R/L 16	SA3	5510	YI3	YE3	SY3	2.0
S20Q STXN R/L 22	SN4	5520	-	-	-	4.0
S25R STXN R/L 22	SA4	5520	YI4	YE4	SY4	4.0
S32S STXN R/L 22	SA4	5520	YI4	YE4	SY4	4.0
S40T STXN R/L 22	SA4	5520	YI4	YE4	SY4	4.0
S32S STXN R/L 27	SA5	5525	YI5	YE5	SY5	5.0
S40T STXN R/L 27	SA5	5525	YI5	YE5	SY5	5.0
S50U STXN R/L 27	SA5	5525	YI5	YE5	SY5	5.0
S60V STXN R/L 27	SA5	5525	YI5	YE5	SY5	5.0

N R/L

Triangular negative inserts for internal threading. Dreieckige negative Wendeschneidplatten zum Innengewindedrehen. ⓘ C04,06,07,09,10

Reference / Bez.

l

d

11 NR/L..	11,00	6,35
16 NR/L..	16,00	9,52
22 NR/L..	22,00	12,70
27 NR/L..	27,00	15,87

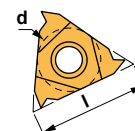

N R/L



N R/L TD

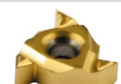



Characteristics:
Vertical on edge threading boring bar.

Eigenschaften:
Bohrstange zum Vertikal-Gewindedrehen auf der Kante.

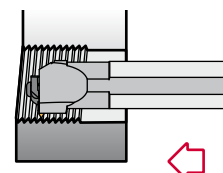
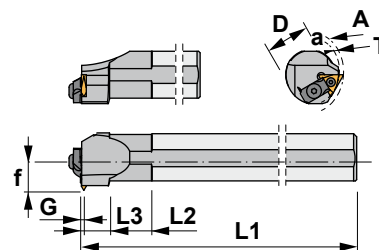

STGN 90°

Reference Bezeichnung	D	L1	L2	L3	f	A	a	T	G	Insert size Wendeschneidplatte	Kg
S32U STGN R/L 16	32	350	45	19	21,0	50,4	45	2,7	1,59	TNMC 1603..	2,100
S40V STGN R/L 16	40	400	50	19	25,0	60,4	55	2,7	1,59	TNMC 1603..	3,650
S32U STGN R/L 22	32	350	45	28	21,0	78,2	70	4,1	2,38	TNMC 2204..	2,100
S40V STGN R/L 22	40	400	50	28	25,0	50,4	45	4,1	2,38	TNMC 2204..	3,650
S50W STGN R/L 22	50	450	60	28	36,5	60,4	55	4,1	2,38	TNMC 2204..	6,700
S40V STGN R/L 27	40	400	50	28	25,0	60,4	55	6,0	3,18	TNMC 2706..	3,650
S50W STGN R/L 27	50	450	60	28	36,5	78,2	70	6,0	3,18	TNMC 2706..	6,700

Reference Bezeichnung						Nm ¹	Nm ²
S32U STGN R/L 16	1935	2101	1815	5002	5003	1.4	3.0
S40V STGN R/L 16	1935	2101	1815	5002	5003	1.4	3.0
S32U STGN R/L 22	1950	2101	1815	5025	5003	2.0	3.0
S40V STGN R/L 22	1950	2101	1815	5025	5003	2.0	3.0
S50W STGN R/L 22	1950	2101	1815	5025	5003	2.0	3.0
S40V STGN R/L 27	1955	2101	1815	5003	5003	3.0	3.0
S50W STGN R/L 27	1955	2101	1815	5003	5003	3.0	3.0

TNMC

Triangular negative insert for internal threading. C10
Dreikantige negative Wendeschneidplatte zum Innengewindedrehen.

Reference / Bez.

	l	s	d
TNMC 1603..	16,50	3,18	9,52
TNMC 2204..	22,00	4,76	12,70
TNMC 2706..	27,00	6,35	15,88

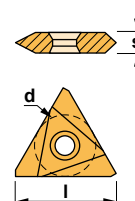

TNMC

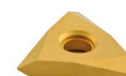



Characteristics:
Vertical on edge threading boring bar.

Eigenschaften:
Bohrstange zum Vertikal-Gewindedrehen
auf der Kante.

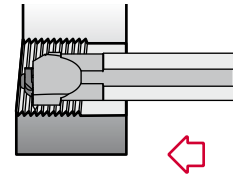
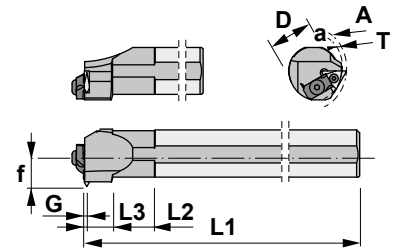

STGP 90°

Reference Bezeichnung	D	L1	L2	L3	f	A	a	T	G	Insert size Wendeschneidplatte	Kg
S25T STGP R/L 16	25	300	40	19	17,5	50,4	45	2,7	1,59	TPMC 1603..	1,100
S32U STGP R/L 16	32	350	45	19	20,5	50,4	45	2,7	1,59	TPMC 1603..	2,100
S40V STGP R/L 22	40	400	50	28	25,0	78,2	70	4,1	2,38	TPMC 2204..	3,650
S50W STGP R/L 22	50	450	60	28	36,5	78,2	70	4,1	2,38	TPMC 2204..	6,700

Reference Bezeichnung						Nm ¹	Nm ²
S25T STGP R/L 16	1935	2101	1815	5002	5003	1.4	3.0
S32U STGP R/L 16	1935	2101	1815	5002	5003	1.4	3.0
S40V STGP R/L 22	1950	2101	1815	5025	5003	2.0	3.0
S50W STGP R/L 22	1950	2101	1815	5025	5003	2.0	3.0

TPMC

Triangular positive insert for internal threading. C10
Dreikantige positive Wendeschneidplatte zum Innengewindedrehen.

Reference / Bez.	l	s	d
TPMC 1603..	16,50	3,18	9,52
TPMC 2204..	22,00	4,76	12,70

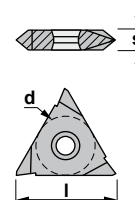

TPMC

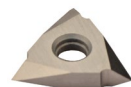

Cutting data

Material	Cutting speed m/min. (Ft/min) Insert grade			N° of passes		
	PM25	KM15	TIN25	P mm	TPI	N° of passes
Low and medium carbon steel	120-80 (390-260)		250-210 (820-690)	0,50 0,75 1,00 1,25 1,50 1,75 2,00 2,50 3,00 3,50 4,00 4,50 5,00 5,50 6,00 8,00	48,0 32,0 24,0 20,0 16,0 14,0 12,0 10,0 8,0 7,0 6,0 5,5 5,0 4,5 4,0 3,0	4 - 6 4 - 7 4 - 8 5 - 9 6 - 10 7 - 12 7 - 12 8 - 14 10 - 18 11 - 18 11 - 18 11 - 19 12 - 20 12 - 20 12 - 20 15 - 24
High carbon steel	110-70 (360-230)		210-150 (690-490)			
Alloyed tool steel and heat-treated steels	100-70 (360-230)		180-140 (590-460)			
Stainless steels	100-70 (360-230)	90-70 (295-230)	140-110 (460-360)			
Cast-iron HB 180-250		90-70 (295-230)				
Non-ferrous metals		180-120 (590-390)				

General recommendations:

- Threading speeds should normally be a minimum of 80% to 90% of turning speeds being used to machine the same component (assuming grades are compatible).
- Check helix angle and number of passes shown in charts before starting.
- Ensure centre height is correct.
- When there is a problem consult the following recommendations and change only one variable at a time. This will help to be sure of the original problem.
- Do not use flank infeed on work hardening materials.

Component problems

Problem	Remedy
Pitch error (on CNC machines) <ul style="list-style-type: none"> ▼ Starting too close to workpiece. ▼ Saddle speed towards chuck is excessive. 	<ul style="list-style-type: none"> ▲ Start cycle further back from workpiece. ▲ Reduce speed by 10% until correct.
Thread torn on one side only <ul style="list-style-type: none"> ▼ Incorrect helix angle in toolholder. 	<ul style="list-style-type: none"> ▲ Check helix chart. ▲ Reassemble with correct anvil. ▲ Check centre height.
Thread torn on both sides <ul style="list-style-type: none"> ▼ Running too slow. ▼ Built up edge. 	<ul style="list-style-type: none"> ▲ Increase cutting speed. ▲ Check center height. ▲ Use coated grade. ▲ Compare thread speed with turning speed.
Long dangerous swarf <ul style="list-style-type: none"> ▼ Incorrect chipbreaker geometry. ▼ Incorrect method of infeed. 	<ul style="list-style-type: none"> ▲ Use Canela (TD) chipbreaker. ▲ Use different infeed method.
Vibration chatter marks on both flanks <ul style="list-style-type: none"> ▼ Poor stability. ▼ Excessive overhang. 	<ul style="list-style-type: none"> ▲ Renew anvil to support insert. ▲ Check tool clamping. ▲ Reduce tool overhang. ▲ Check rigidity of setup.
Shallow threads Problem with gauging <ul style="list-style-type: none"> ▼ Insert not cresting. ▼ Incorrect effective diameter. 	<ul style="list-style-type: none"> ▲ Check machined diameters. ▲ Excessive tool wear or chipped on nose see remedies above.



Schnittdaten

Materialien	Schnittgeschwindigkeit m/min.(Ft/min) Wendeplattensorte			Anzahl von Steigungen		
	PM25	KM15	TIN25	P mm	TPI	Anzahl von Steigungen
Stahl mit niedrigem und mittlerem Kohlenstoffgehalt	120-80 (390-260)		250-210 (820-690)	0,50	48,0	4 - 6
				0,75	32,0	4 - 7
				1,00	24,0	4 - 8
				1,25	20,0	5 - 9
				1,50	16,0	6 - 10
Stahl mit hohem Kohlenstoffgehalt	110-70 (360-230)		210-150 (690-490)	1,75	14,0	7 - 12
				2,00	12,0	7 - 12
				2,50	10,0	8 - 14
				3,00	8,0	10 - 18
				3,50	7,0	11 - 18
Legierter Werkzeugstahl und Vergütungsstähle	100-70 (360-230)		180-140 (590-460)	4,00	6,0	11 - 18
				4,50	5,5	11 - 19
				5,00	5,0	12 - 20
				5,50	4,5	12 - 20
				6,00	4,0	12 - 20
Rostfreie Stähle	100-70 (360-230)	90-70 (295-230)	140-110 (460-360)	8,00	3,0	15 - 24
Guß HB 180-250		90-70 (295-230)				
Nichteisenmetalle		180-120 (590-390)				

Allgemeine Empfehlungen:

- Die Gewindedreh-Geschwindigkeiten sollten normalerweise minimum 80 bis 90% der Drehgeschwindigkeiten haben, die zur Bearbeitung derselben Teile verwendet werden (wenn die Sorten kompatibel sind).
- Bevor man beginnt, sollte man den Spiralwinkel und die Anzahl der auf den Tabellen gezeigten Steigungen kontrollieren.
- Kontrollieren, daß die Spitzenhöhe stimmt.
- Falls es ein Problem gibt, bitte folgende Empfehlungen beachten und nur eine Variable auf einmal ändern. Das hilft, Probleme zu lösen.
- Keine Flankenzustellung bei Materialien, die bei der Bearbeitung härter werden.

Problemen mit dem Werkstück

Problem	Ursache/Maßnahme
Steigungsfehler (bei CNC-Maschinen)	<ul style="list-style-type: none"> ▼ Man hat zu nah am Werkstück angefangen. ▼ Die Geschwindigkeit in Richtung auf den Antritt ist zu hoch. <ul style="list-style-type: none"> ▲ Zyklus weiter von dem Werkstück entfernt anfangen. ▲ Geschwindigkeit um 10% reduzieren, bis sie korrekt ist.
Gewinde, die nur auf einer Seite gebrochen sind	<ul style="list-style-type: none"> ▼ Nicht korrekter Steigungswinkel im Werkzeug. <ul style="list-style-type: none"> ▲ Steigungstabelle kontrollieren. ▲ Nochmal montieren aber mit der richtigen Unterlegplatte. ▲ Spitzenhöhe kontrollieren.
Gewinde, die auf beide Seiten gebrochen sind	<ul style="list-style-type: none"> ▼ Zu langsame Bearbeitung. ▼ Schneidenaufbau. <ul style="list-style-type: none"> ▲ Oberflächen-Geschwindigkeit erhöhen. ▲ Spitzenhöhe kontrollieren. ▲ Eine beschichtete Sorte verwenden. ▲ Gewindedreh-Geschwindigkeit mit Drehgeschwindigkeit vergleichen.
Lange und gefährliche Späne	<ul style="list-style-type: none"> ▼ Nicht korrekte Spanbrecher-Geometrie. ▼ Nicht korrekte Zustellungsmethode. <ul style="list-style-type: none"> ▲ Canela TD-Spanbrecher verwenden. ▲ Eine andere Zustellungsmethode verwenden.
Vibrationsmarken auf beiden Flanken	<ul style="list-style-type: none"> ▼ Geringe Stabilität. ▼ Zu große Auskrägung. <ul style="list-style-type: none"> ▲ Unterlegplatte wechseln, um die Wendeschneidplatte zu verstärken. ▲ Klemmung des Werkzeuges kontrollieren. ▲ Die Auskrägung reduzieren. ▲ Die Stabilität des Aufbaues kontrollieren.
Ungenauere Gewinde / Probleme mit den Abmessungen	<ul style="list-style-type: none"> ▼ Die Wendeschneidplatte macht eine schlechte Oberflächengüte. ▼ Nicht korrekter effektiver Durchmesser. <ul style="list-style-type: none"> ▲ Den bearbeiteten Durchmesser kontrollieren. ▲ Bei zuviel Verschleiß oder Ansammlung von Spänen in der Spitze, siehe obengenannte Maßnahmen.

Helix chart

Feed direction towards the chuck

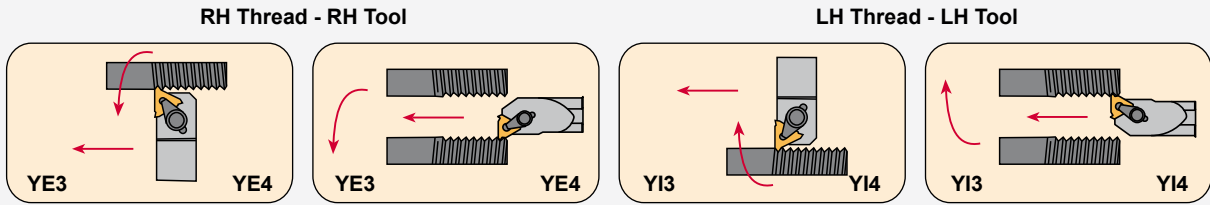

Anvil to give correct helix

Insert size	+3°	+2°	+1°	0°
16R	3424+3	3424+2	3424+1	YE3
16L	3425+3	3425+2	3425+1	YI3
22R	3430+3	3430+2	3430+1	YE4
22L	3431+3	3431+2	3431+1	YI4

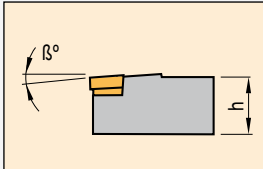
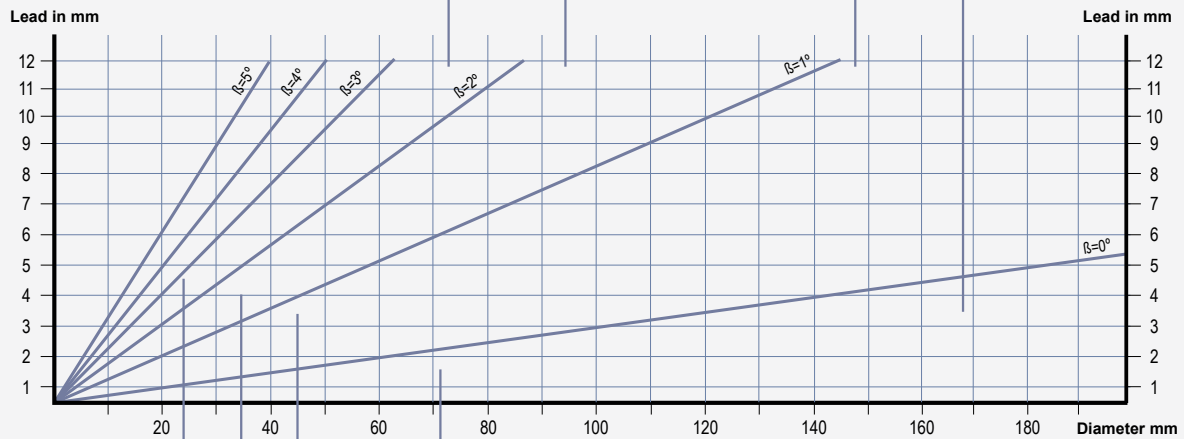

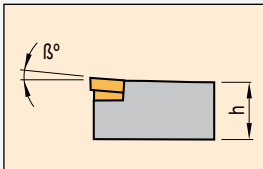

Anvil to give correct helix

Insert size	-3°	-2°	-1°	0°
16R	3424-3	3424-2	3424-1	YE3
16L	3425-3	3425-2	3425-1	YI3
22R	3430-3	3430-2	3430-1	YE4
22L	3431-3	3431-2	3431-1	YI4

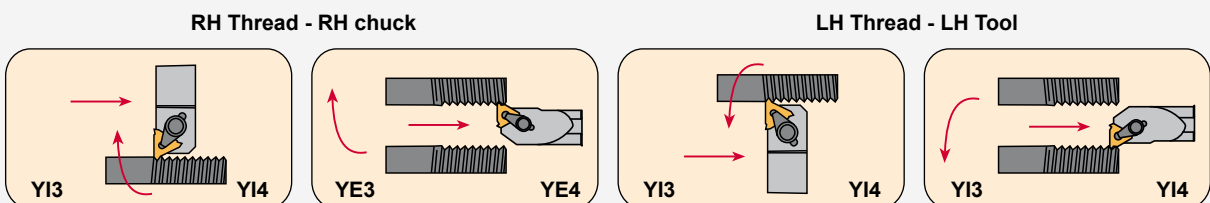

Feed direction away from the chuck



Steigungs-Tabelle

Vorschubrictung in Richtung Antrieb

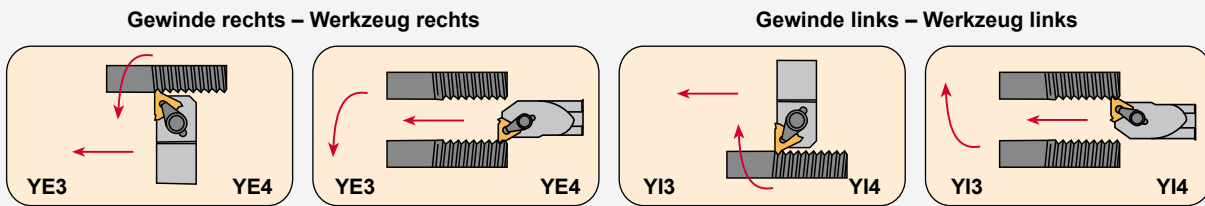

Nötige Unterlegplatte, um die korrekte Steigung zu erzeugen

Wendeplattengröße	+3°	+2°	+1°	0°
16R	3424+3	3424+2	3424+1	YE3
16L	3425+3	3425+2	3425+1	YI3
22R	3430+3	3430+2	3430+1	YE4
22L	3431+3	3431+2	3431+1	YI4

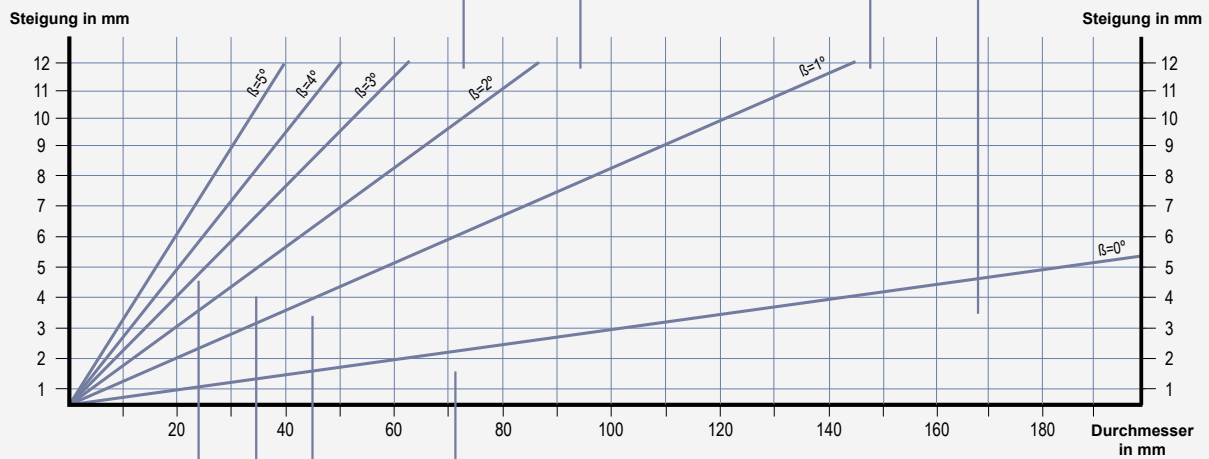
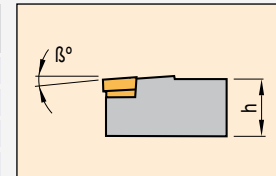

Nötige Unterlegplatte, um die korrekte Steigung zu erzeugen

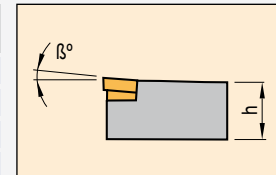

Wendeplattengröße	-3°	-2°	-1°	0°
16R	3424-3	3424-2	3424-1	YE3
16L	3425-3	3425-2	3425-1	YI3
22R	3430-3	3430-2	3430-1	YE4
22L	3431-3	3431-2	3431-1	YI4

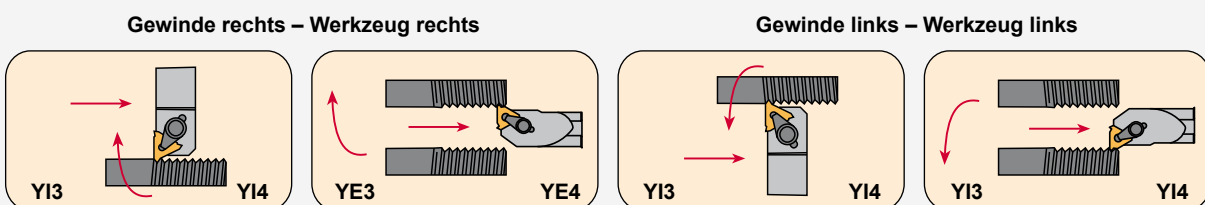

Vorschubrictung ab dem Antrieb



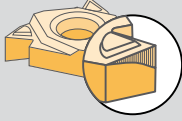
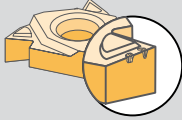
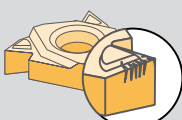
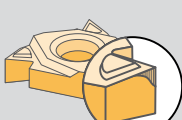

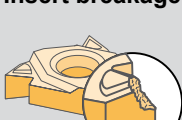
Threading insert wear and tool life

	Problem	Remedy
Rapid flank wear 	<ul style="list-style-type: none"> ▼ Cutting speed too high. ▼ Lack of coolant. ▼ Infeed per pass too small - too many passes. ▼ Incorrect grade. 	<ul style="list-style-type: none"> ▲ Reduce the cutting speed. ▲ Increase the coolant supply. ▲ Increase the depth of infeed for the smallest infeed depths - reduce the number of passes. ▲ Select a more wear resistant grade.
Edge frittering 	<ul style="list-style-type: none"> ▼ Instability of workholding and/or tool set-up. 	<ul style="list-style-type: none"> ▲ Check rigidity of operation. ▲ Select a tougher grade.
Edge spalling 	<ul style="list-style-type: none"> ▼ Intermittent coolant supply. 	<ul style="list-style-type: none"> ▲ Position coolant flow and/or increase coolant supply.
Uneven flank wear 	<ul style="list-style-type: none"> ▼ Incorrect method of infeed. ▼ Incorrect angle of inclination. 	<ul style="list-style-type: none"> ▲ In case of flank infeed use modified flank infeed. Decrease infeed angle 3-5°. ▲ Correct the angle on inclination according to the diagram.
Excessive plastic deformation 	<ul style="list-style-type: none"> ▼ Infeed per pass too big - too few passes. ▼ Lack of coolant. ▼ Cutting speed too high. ▼ Incorrect grade. ▼ Excessive stock removal from crest. 	<ul style="list-style-type: none"> ▲ Decrease the depth of infeed for the biggest depths. - Increase the number of passes. ▲ Increase coolant supply. ▲ Reduce the cutting speed. ▲ Select a harder grade. ▲ Check the volume of the material above the crest.
Insert breakage 	<ul style="list-style-type: none"> ▼ Instability. ▼ Lack of chip control. ▼ Excessive plastic deformation. ▼ Intermittent or inadequate coolant supply. ▼ Incorrect preparation of the operation. 	<ul style="list-style-type: none"> ▲ Check rigidity of operation. ▲ Select a tougher grade. Select modified flank infeed. ▲ Machine with same infeed per pass. ▲ Direct coolant flow and/or increase coolant supply. ▲ Check dimension of blank.
Shallow thread profile	<ul style="list-style-type: none"> ▼ Wrong centre height. ▼ Insert not cresting. ▼ Excessive tool wear. 	<ul style="list-style-type: none"> ▲ Adjust cutting edge height. ▲ Check dimension of blank. ▲ Change insert earlier.
Incorrect thread profile	<ul style="list-style-type: none"> ▼ Incorrect tool setting. 	<ul style="list-style-type: none"> ▲ Correct tool setting.
Lack of chip control	<ul style="list-style-type: none"> ▼ Incorrect depth of infeed per pass. ▼ Radial infeed. 	<ul style="list-style-type: none"> ▲ For modified flank infeed use 3-5°. ▲ Use geometry with modified flank infeed 1°.
Bad surface finish	<ul style="list-style-type: none"> ▼ Cutting speed too low. ▼ Incorrect angle of inclination. ▼ Flank infeed. 	<ul style="list-style-type: none"> ▲ Increase the cutting speed. ▲ Correct the angle of inclination according to diagram. ▲ Use modified flank infeed or radial infeed.

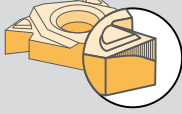
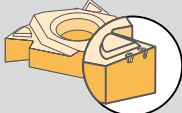
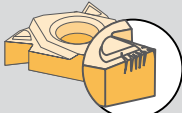
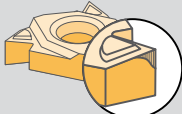

Verschleiß und Standzeit der Wendeplatte zum Gewindedrehen

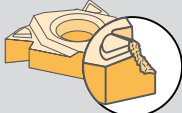
	Problem	Ursache und Maßnahmen
<p>Schneller Freiflächenverschleiß</p> 	<ul style="list-style-type: none"> ▼ Zu hohe Schnittgeschwindigkeit. ▼ Mangel an Kühlmittel. ▼ Zustellungstiefe pro Durchgang zu niedrig – zu viele Durchgänge. ▼ Nicht korrekte Plattensorte. 	<ul style="list-style-type: none"> ▲ Schnittgeschwindigkeit reduzieren. ▲ Kühlmittelzufuhr erhöhen. ▲ Für kleine Zustellungen, die Zustellungstiefe erhöhen – Anzahl der Durchgänge reduzieren. ▲ Eine Sorte mit höherem Widerstand gegen Verschleißfestigkeit wählen.
<p>Absplittern der Schneidkante</p> 	<ul style="list-style-type: none"> ▼ Instabilität des Werkstückes und/oder des Werkzeuges 	<ul style="list-style-type: none"> ▲ Stabilität der Operation kontrollieren. ▲ Eine härtere Sorte wählen.
<p>Kammerisse</p> 	<ul style="list-style-type: none"> ▼ Unterbrochene Kühlmittelzufuhr. 	<ul style="list-style-type: none"> ▲ Kühlmittel kontrollieren und/oder Zufuhr erhöhen.
<p>Ungleichmäßiger Freiflächenverschleiß</p> 	<ul style="list-style-type: none"> ▼ Falsche Methode der Flankenzustellung. ▼ Falscher Neigungswinkel der Wendeplatte. 	<ul style="list-style-type: none"> ▲ Zustellmethode ändern. Zustellwinkel 3-5° vermindern. ▲ Neigungswinkel gemäß Diagramm ändern.
<p>Übermäßige plastische Verformung</p> 	<ul style="list-style-type: none"> ▼ Zustellungstiefe pro Durchgang zu groß – zu wenige Durchgänge. ▼ Mangel an Kühlmittel. ▼ Zu hohe Schnittgeschwindigkeit. ▼ Nicht korrekte Plattensorte. ▼ Zuviel Materialabnahme an der Wendeplattenspitze. 	<ul style="list-style-type: none"> ▲ Zustellungstiefe reduzieren - Anzahl der Durchgänge erhöhen. ▲ Kühlmittelzufuhr erhöhen. ▲ Schnittgeschwindigkeit reduzieren. ▲ Eine härtere Sorte wählen. ▲ Materialmenge an der Wendeplattenspitze kontrollieren.
<p>Plattenbruch</p> 	<ul style="list-style-type: none"> ▼ Instabilität. ▼ Unkontrollierte Späne. ▼ Übermäßige plastische Verformung. ▼ Unterbrochene oder ungeeignete Kühlmittelzufuhr. ▼ Falsche Vorbereitung des Vorgangs. 	<ul style="list-style-type: none"> ▲ Stabilität der Operation kontrollieren. ▲ Eine härtere Sorte wählen. Modifizierte Flankenzustellung wählen. ▲ Mit derselben Zustellung per Steigung bearbeiten. ▲ Kühlmittelzufuhr kontrollieren und/oder Zufuhr erhöhen. ▲ Die Abmessung der Wendeplatte kontrollieren.
<p>Zu kleines Gewindeprofil</p>	<ul style="list-style-type: none"> ▼ Falsche Spitzenhöhe. ▼ Plattenbruch. ▼ Übermäßiger Verschleiß. 	<ul style="list-style-type: none"> ▲ Schneidkantenhöhe einstellen. ▲ Die Abmessung der Wendeplatte kontrollieren. ▲ Wendeplatte früher wechseln.
<p>Mangelhaftes Gewindeprofil</p>	<ul style="list-style-type: none"> ▼ Falsche Werkzeug/Wendeplattenkombination. 	<ul style="list-style-type: none"> ▲ Richtige Werkzeug/Wendeplattenkombination wählen.
<p>Schlechte Spankontrolle</p>	<ul style="list-style-type: none"> ▼ Falsche Tiefe der Zustellung per Steigung. ▼ Radiale Zustellung. 	<ul style="list-style-type: none"> ▲ Modifizierte Flankenzustellung von 3-5° verwenden. ▲ Geometrien mit modifizierter Flankenzustellung von 1° wählen.
<p>Schlechte Oberflächengüte</p>	<ul style="list-style-type: none"> ▼ Zu niedrige Schnittgeschwindigkeit. ▼ Nicht korrekter Neigungswinkel. ▼ Flankenzustellung. 	<ul style="list-style-type: none"> ▲ Schnittgeschwindigkeit erhöhen. ▲ Neigungswinkel gemäß Diagramm korrigieren. ▲ Modifizierte Flankenzustellung oder radiale Zustellung verwenden.

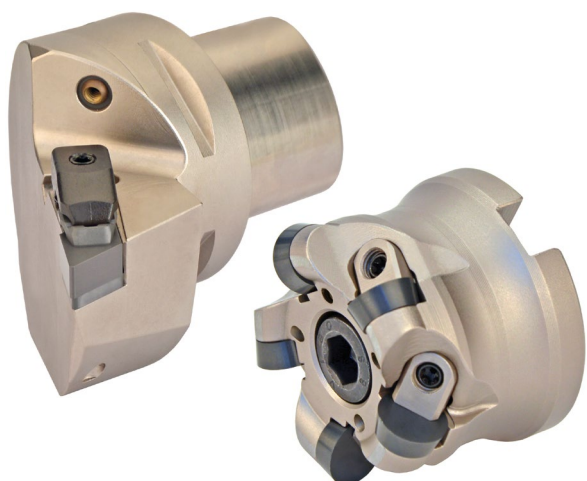











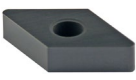

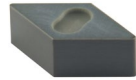
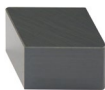



CERAMIC KERAMIK



Contents - Ceramic inserts	D02
Inhaltsverzeichnis / Keramik-Wendeschneidplatten	
Ceramic inserts	D03-07
Keramik-Wendeschneidplatten	
Applications index	D08-09
Anwendungen	
Ceramic milling cutters	D10-15
Fräser für Keramik-Wendeschneidplatten	
Toolholders	D16-33
Klemmhalter	
Boring bars	D34-40
Bohrstangen	
Top clamp ceramic PSC	D41-53
PSC Keramikhalter mit oberer Klemmung	

Ceramic inserts
Keramik-Wendeschnidplatten

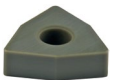
<p>CNGA</p>  <p>Page Seite D03 0° <input type="checkbox"/></p>	<p>CNGN</p>  <p>Page Seite D03 0° <input type="checkbox"/></p>	<p>CNGX</p>  <p>Page Seite D03 0° <input type="checkbox"/></p>	<p>DNGA</p>  <p>Page Seite D03 0° <input type="checkbox"/></p>	<p>DNGN</p>  <p>Page Seite D03 0° <input type="checkbox"/></p>	<p>DNGX</p>  <p>Page Seite D04 0° <input type="checkbox"/></p>
<p>ENGN</p>  <p>Page Seite D04 0° <input type="checkbox"/></p>	<p>GWG</p>  <p>Page Seite D04 3° <input checked="" type="checkbox"/></p>	<p>RCGX</p>  <p>Page Seite D04 7° <input checked="" type="checkbox"/></p>	<p>RNGN</p>  <p>Page Seite D04 0° <input type="checkbox"/></p>	<p>RPGN</p>  <p>Page Seite D05 0° <input type="checkbox"/></p>	<p>SNGA</p>  <p>Page Seite D05 0° <input type="checkbox"/></p>
<p>SNGN</p>  <p>Page Seite D05 0° <input type="checkbox"/></p>	<p>SNGN</p>  <p>Page Seite D05 0° <input type="checkbox"/></p>	<p>SNGX</p>  <p>Page Seite D06 0° <input type="checkbox"/></p>	<p>TNGA</p>  <p>Page Seite D06 0° <input type="checkbox"/></p>	<p>TNGN</p>  <p>Page Seite D06 0° <input type="checkbox"/></p>	<p>VNGA</p>  <p>Page Seite D07 0° <input type="checkbox"/></p>
<p>WNGA</p>  <p>Page Seite D07 0° <input type="checkbox"/></p>					



Ceramic inserts Keramik-Wendeschneidplatten

USE CLASSIFICATION

- Continuous
- ◐ Slight interruption
- ⊕ Interruption

AVAILABILITY

- Standard item
- Check availability

EINSATZBEREICH

- Ununterbrochen
- ◐ Leicht unterbrochen
- ⊕ Unterbrochen

VERFÜGBARKEIT

- Standard-Artikel
- Verfügbarkeit prüfen

Material Werkstoff	Grade Sorte	● Continuous Ununterbrochen	◐ Slight interruption Leicht unterbrochen	⊕ Interruption Unterbrochen
K Cast iron Guß	CC2	▶		
	CX6	▶		▶
	CW1	▶		▶
S Heat-resistant alloys Hitzebeständige Legierungen	CX9	▶		▶
	CW1	▶		▶
H Hard materials Harte Materialien	CC7	▶		

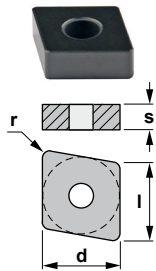

CNGA

80° rhombic negative insert.
80° rhombische negative Wendeschneidplatte.

Reference / Bezeichnung	l	s	d	r	CX6	CX9	CC2	CC7	CW1
CNGA 120404	12,90	4,76	12,70	0,4				●	
CNGA 120408	12,90	4,76	12,70	0,8	●			●	
CNGA 120412	12,90	4,76	12,70	1,2	●			●	

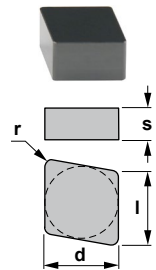

CNGN

80° rhombic negative insert.
80° rhombische negative Wendeschneidplatte.

Reference / Bezeichnung	l	s	d	r	CX6	CX9	CC2	CC7	CW1
CNGN 120408	12,90	4,76	12,70	0,8				●	●
CNGN 120412	12,90	4,76	12,70	1,2				●	●
CNGN 120708	12,90	7,94	12,70	0,8				●	●
CNGN 120712	12,90	7,94	12,70	1,2				●	●
CNGN 120716	12,90	7,94	12,70	1,6				●	●

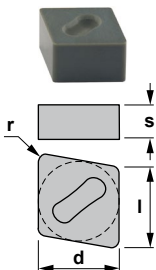

CNGX

80° rhombic negative insert.
80° rhombische negative Wendeschneidplatte.

Reference / Bezeichnung	l	s	d	r	CX6	CX9	CC2	CC7	CW1
CNGX 120708	12,90	7,94	12,70	0,8	●	●			
CNGX 120712	12,90	7,94	12,70	1,2	●	●			
CNGX 120716	12,90	7,94	12,70	1,6	●	●			
CNGX 160712	16,10	7,94	15,87	1,2	●				
CNGX 160716	16,10	7,94	15,87	1,6	●	●			

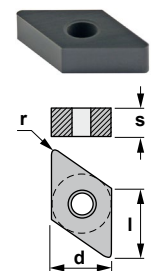

DNGA

55° rhombic negative insert.
55° rhombische negative Wendeschneidplatte.

Reference / Bezeichnung	l	s	d	r	CX6	CX9	CC2	CC7	CW1
DNGA 150404	12,90	4,76	12,70	0,4				●	
DNGA 150408	12,90	4,76	12,70	0,8	●			●	
DNGA 150412	12,90	4,76	12,70	1,2	●			●	

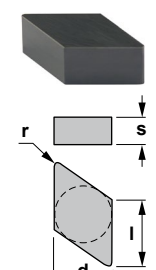

DNGN

55° rhombic negative insert.
55° rhombische negative Wendeschneidplatte.

Reference / Bezeichnung	l	s	d	r	CX6	CX9	CC2	CC7	CW1
DNGN 150708	15,50	7,94	12,70	0,8				●	●
DNGN 150712	15,50	7,94	12,70	1,2				●	●
DNGN 150716	15,50	7,94	12,70	1,6				●	

Ceramic inserts Keramik-Wendeschneidplatten

USE CLASSIFICATION

- Continuous
- ◐ Slight interruption
- ⊕ Interruption

AVAILABILITY

- Standard item
- Check availability

EINSATZBEREICH

- Ununterbrochen
- ◐ Leicht unterbrochen
- ⊕ Unterbrochen

VERFÜGBARKEIT

- Standard-Artikel
- Verfügbarkeit prüfen

Material Werkstoff	Grade Sorte	● Continuous Ununterbrochen	◐ Slight interruption Leicht unterbrochen	⊕ Interruption Unterbrochen
K Cast iron Guß	CC2	→		
	CX6	→		→
	CW1	→		→
S Heat-resistant alloys Hitzebeständige Legierungen	CX9	→		→
	CW1	→		→
H Hard materials Harte Materialien	CC7	→		

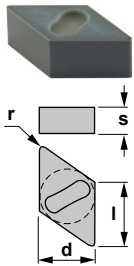

DNGX

55° rhombic negative insert.
55° rhombische negative Wendeschneidplatte.

Reference / Bezeichnung	l	s	d	r	CX6	CX9	CC2	CC7	CW1
DNGX 120708	12,20	7,94	10,00	0,8	●				
DNGX 120712	12,20	7,94	10,00	1,2	●				
DNGX 120716	12,20	7,94	10,00	1,6	●				
DNGX 150708	15,50	7,94	12,70	0,8	●				
DNGX 150712	15,50	7,94	12,70	1,2	●	●			
DNGX 150716	15,50	7,94	12,70	1,6	●	●			

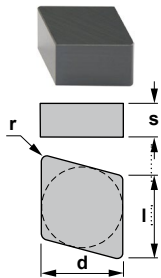

ENGN

75° rhombic negative insert.
75° rhombische negative Wendeschneidplatte.

Reference / Bezeichnung	l	s	d	r	CX6	CX9	CC2	CC7	CW1
ENGN 130708	13,15	7,94	12,70	0,8			●		
ENGN 130712	13,15	7,94	12,70	1,2			●		
ENGN 130716	13,15	7,94	12,70	1,6			●		
ENGN 130720	13,15	7,94	12,70	2,0			●		

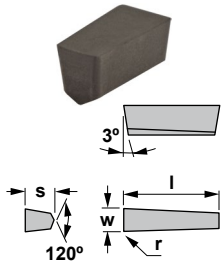

GWG

Positive insert.
Positive Wendeschneidplatte.

Reference / Bezeichnung	l	s	w	r	CX6	CX9	CC2	CC7	CW1
GWG 04 M	12,00	5,00	4,00	0,5	○				
GWG 05 M	12,00	5,00	5,00	0,8	○				
GWG 06 M	15,00	7,50	6,00	0,8	○				
GWG 07	15,00	7,50	7,00	0,8	○				
GWG 08	15,00	7,50	8,00	0,8	○				
GWG 10	15,00	7,50	10,00	0,8	○				

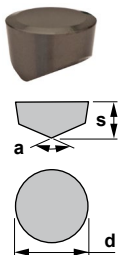

RCGX

Round positive insert.
Runde positive Wendeschneidplatte.

Reference / Bezeichnung	s	d	a	CX6	CX9	CC2	CC7	CW1
RCGX 060700	7,94	6,35	120°			●		●
RCGX 090700	7,94	9,52	120°		●	●		●
RCGX 120700	7,94	12,70	120°		●	●		●
RCGX 151000	10,00	15,87	120°			●		●
RCGX 191000	10,00	19,05	120°		●	●		●
RCGX 251200	12,00	25,40	140°			●		

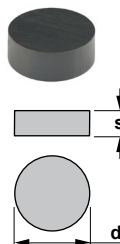

RNGN

Round negative insert.
Runde negative Wendeschneidplatte.

Reference / Bezeichnung	s	d	CX6	CX9	CC2	CC7	CW1
RNGN 120400	4,76	12,70		●		●	●
RNGN 120700	7,94	12,70		●		●	●

Ceramic inserts Keramik-Wendeschnidplatten

USE CLASSIFICATION

- Continuous
- ◐ Slight interruption
- ⊕ Interruption

AVAILABILITY

- Standard item
- Check availability

EINSATZBEREICH

- Ununterbrochen
- ◐ Leicht unterbrochen
- ⊕ Unterbrochen

VERFÜGBARKEIT

- Standard-Artikel
- Verfügbarkeit prüfen

Material Werkstoff	Grade Sorte	● Continuous Ununterbrochen	◐ Slight interruption Leicht unterbrochen	⊕ Interruption Unterbrochen
K Cast iron Guß	CC2	▶		
	CX6	▶		▶
	CW1	▶		
S Heat-resistant alloys Hitzebeständige Legierungen	CX9	▶		▶
	CW1	▶		
H Hard materials Harte Materialien	CC7	▶		

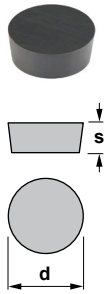

RPGN

Round negative insert.
Runde negative Wendschneidplatte.

Reference / Bezeichnung	s	d	CX6	CX9	CC2	CC7	CW1
RPGN 060200	2,38	6,35		●			
RPGN 090300	3,18	9,52		●			
RPGN 120400	4,76	12,70		●			

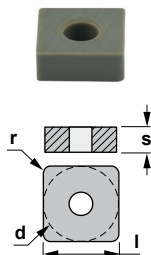

SNGA

Square negative insert.
Vierkantige negative Wendschneidplatte.

Reference / Bezeichnung	l	s	d	r	CX6	CX9	CC2	CC7	CW1
SNGA 120408	12,70	4,76	12,70	0,8				●	
SNGA 120412	12,70	4,76	12,70	1,2	●			●	
SNGA 120416	12,70	4,76	12,70	1,6	●			●	

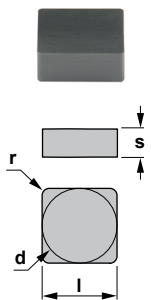

SNGN

Square negative insert.
Vierkantige negative Wendschneidplatte.

Reference / Bezeichnung	l	s	d	r	CX6	CX9	CC2	CC7	CW1
SNGN 120404	12,70	4,76	12,70	0,4			●		
SNGN 120408	12,70	4,76	12,70	0,8			●		
SNGN 120412	12,70	4,76	12,70	1,2	●		●		
SNGN 120416	12,70	4,76	12,70	1,6			●		
SNGN 120420	12,70	4,76	12,70	2,0			○		
SNGN 120424	12,70	4,76	12,70	2,4			○		
SNGN 120708	12,70	7,94	12,70	0,8		●	●		●
SNGN 120712	12,70	7,94	12,70	1,2		●	●		●
SNGN 120716	12,70	7,94	12,70	1,6		●	●		●
SNGN 120720	12,70	7,94	12,70	2,0			○		

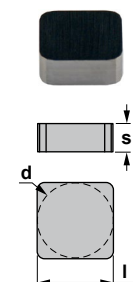

SNGN

Square negative insert.
Vierkantige negative Wendschneidplatte.

Reference / Bezeichnung	l	s	d	CX6	CX9	CC2	CC7	CW1
SNGN 1204ENT	12,70	4,76	12,70		●			



Ceramic inserts Keramik-Wendeschneidplatten

USE CLASSIFICATION

- Continuous
- ◐ Slight interruption
- ✚ Interruption

AVAILABILITY

- Standard item
- Check availability

EINSATZBEREICH

- Ununterbrochen
- ◐ Leicht unterbrochen
- ✚ Unterbrochen

VERFÜGBARKEIT

- Standard-Artikel
- Verfügbarkeit prüfen

Material Werkstoff	Grade Sorte	● Continuous Ununterbrochen	◐ Slight interruption Leicht unterbrochen	✚ Interruption Unterbrochen
K Cast iron Guß	CC2	●	◐	✚
	CX6	●	◐	✚
	CW1	●	◐	✚
S Heat-resistant alloys Hitzebeständige Legierungen	CX9	●	◐	✚
	CW1	●	◐	✚
H Hard materials Harte Materialien	CC7	●	◐	✚

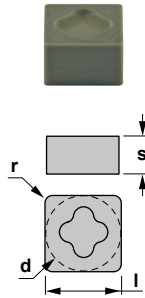

SNGX

Square negative insert.
Vierkantige negative Wendeschneidplatte.

Reference / Bezeichnung	l	s	d	r	CX6	CX9	CC2	CC7	CW1
SNGX 120708	12,70	7,94	12,70	0,8	●				
SNGX 120712	12,70	7,94	12,70	1,2	●				
SNGX 120716	12,70	7,94	12,70	1,6	●				
SNGX 150708	15,87	7,94	15,87	0,8	○				
SNGX 150712	15,87	7,94	15,87	1,2	●	●			
SNGX 150716	15,87	7,94	15,87	1,6	●	●			

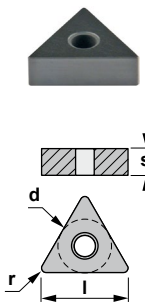

TNGA

Triangular negative insert.
Dreikantige negative Wendeschneidplatte.

Reference / Bezeichnung	l	s	d	r	CX6	CX9	CC2	CC7	CW1
TNGA 160404	16,50	4,76	9,52	0,4				●	
TNGA 160408	16,50	4,76	9,52	0,8				●	
TNGA 160412	16,50	4,76	9,52	1,2				●	
TNGA 160416	16,50	4,76	9,52	1,6				○	

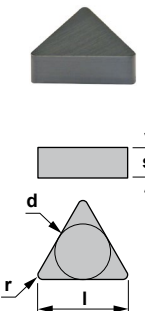

TNGN

Triangular negative insert.
Dreikantige negative Wendeschneidplatte.

Reference / Bezeichnung	l	s	d	r	CX6	CX9	CC2	CC7	CW1
TNGN 160408	16,50	4,76	9,52	0,8			●		
TNGN 160412	16,50	4,76	9,52	1,2			●		
TNGN 160416	16,50	4,76	9,52	1,6			●		
TNGN 160708	16,50	7,94	9,52	0,8			●		
TNGN 160712	16,50	7,94	9,52	1,2			○		

Ceramic inserts Keramik-Wendeschneidplatten

USE CLASSIFICATION

- Continuous
- Slight interruption
- ⊕ Interruption

AVAILABILITY

- Standard item
- Check availability

EINSATZBEREICH

- Ununterbrochen
- Leicht unterbrochen
- ⊕ Unterbrochen

VERFÜGBARKEIT

- Standard-Artikel
- Verfügbarkeit prüfen

Material Werkstoff

Grade
Sorte

● Continuous
Ununterbrochen

● Slight interruption
Leicht unterbrochen

⊕ Interruption
Unterbrochen

Material	Grade	Continuous	Slight interruption	Interruption
K Cast iron Guß	CC2 CX6 CW1	●	●	⊕
S Heat-resistant alloys Hitzebeständige Legierungen	CX9 CW1	●	●	⊕
H Hard materials Harte Materialien	CC7	●	●	⊕

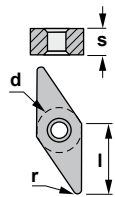
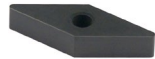

VNGA

35° rhombic negative insert.
35° rhombische negative Wendeschneidplatte.

Reference / Bezeichnung	l	s	d	r	CX6	CX9	CC2	CC7	CW1
VNGA 160404	16,50	4,76	9,52	0,4				●	
VNGA 160408	16,50	4,76	9,52	0,8				●	
VNGA 160412	16,50	4,76	9,52	1,2				●	

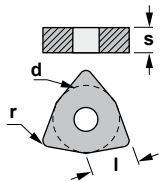
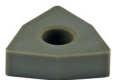





WNGA

80° trigon negative insert.
80° trigon negative Wendeschneidplatte.

Reference / Bezeichnung	l	s	d	r	CX6	CX9	CC2	CC7	CW1
WNGA 080408	8,14	4,76	12,70	0,8	●			●	
WNGA 080412	8,14	4,76	12,70	1,2	●			●	

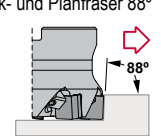
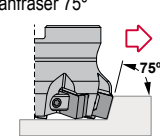

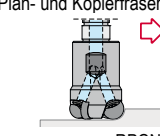
Ceramic milling cutters
Fräser für Keramik-Wendescheidplatten

<p>1242.90 88° Square and facing 88° Eck- und Planfräser 88°</p>  <p>Page Seite D10 SN.. 1204..</p>	<p>1442.90 75° Facing 75° Planfräser 75°</p>  <p>Page Seite D11 SN.. 1204..</p>	<p>5540.90 Facing and copying Plan- und Kopierfräser</p>  <p>Page Seite D12 RPGN 1204..</p>	<p>5540.06 Facing and copying Plan- und Kopierfräser</p>  <p>Page Seite D13 RPGN 0602.. RPGN 1204..</p>	<p>5542.90 Facing and copying Plan- und Kopierfräser</p>  <p>Page Seite D14 RNGN 1207..</p>
---	---	---	--	---

Toolholders
Klemmhalter

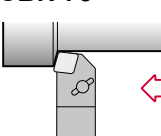
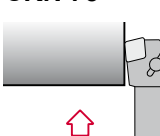
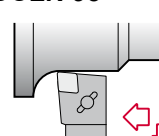
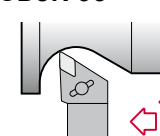
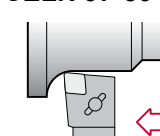
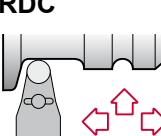
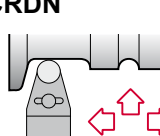
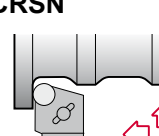
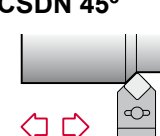
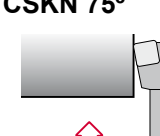
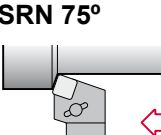
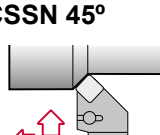
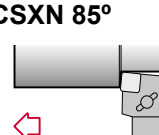
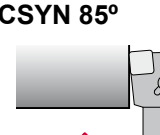
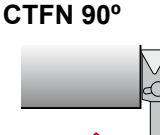
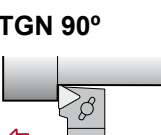
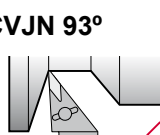
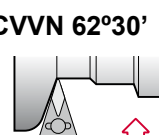
<p>CCBN 75°</p>  <p>Page Seite D16 CNG.. 1204.. CNG.. 1207.. CNG.. 1607..</p>	<p>CCKN 75°</p>  <p>Page Seite D17 CNG.. 1204.. CNG.. 1207..</p>	<p>CCLN 95°</p>  <p>Page Seite D18 CNG.. 1204.. CNG.. 1207.. CNG.. 1607..</p>	<p>CDJN 93°</p>  <p>Page Seite D19 DNG.. 1204.. DNG.. 1207.. DNG.. 1507..</p>	<p>CELN 97°30'</p>  <p>Page Seite D20 ENGN 1307..</p>
<p>CRDC</p>  <p>Page Seite D21 RCGX 0607.. RCGX 2512..</p>	<p>CRDN</p>  <p>Page Seite D22 RNGN 1204.. RNGN 2507..</p>	<p>CRSN</p>  <p>Page Seite D23 RNGN 1204.. RNGN 1207..</p>	<p>CSDN 45°</p>  <p>Page Seite D24 SNG.. 1204.. SNG.. 1207.. SNG.. 1507..</p>	<p>CSKN 75°</p>  <p>Page Seite D25 SNG.. 1204.. SNG.. 1207.. SNG.. 1507..</p>
<p>CSRN 75°</p>  <p>Page Seite D26 SNG.. 1204.. SNG.. 1207.. SNG.. 1507..</p>	<p>CSSN 45°</p>  <p>Page Seite D27 SNG.. 1204.. SNG.. 1207.. SNG.. 1507..</p>	<p>CSXN 85°</p>  <p>Page Seite D28 SNG.. 1204.. SNG.. 1207.. SNG.. 1507..</p>	<p>CSYN 85°</p>  <p>Page Seite D29 SNG.. 1204.. SNG.. 1207.. SNG.. 1507..</p>	<p>CTFN 90°</p>  <p>Page Seite D30 TNGN 1604.. TNGN 1607..</p>
<p>CTGN 90°</p>  <p>Page Seite D31 TNGN 1604.. TNGN 1607..</p>	<p>CVJN 93°</p>  <p>Page Seite D32 VNG.. 1604.. VNG.. 1607..</p>	<p>CVVN 62°30'</p>  <p>Page Seite D33 VNG.. 1604.. VNG.. 1607..</p>		

**Boring bars
Bohrstangen**

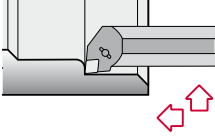
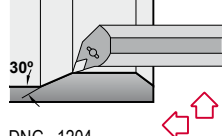
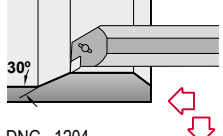
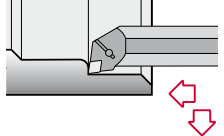
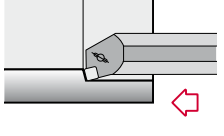
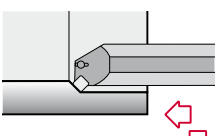
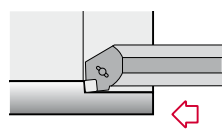
<p>CCLN 95°</p>  <p>Page CNG.. 1204.. Seite D34 CNG.. 1207..</p>	<p>CDQN 107°30'</p>  <p>DNG.. 1204.. DNG.. 1507..</p> <p>Page Seite D35</p>	<p>CDUN 93°</p>  <p>DNG.. 1204.. DNG.. 1507..</p> <p>Page Seite D36</p>	<p>CELN 97°30'</p>  <p>Page Seite D37 ENGN 1307..</p>	<p>CSKN 75°</p>  <p>Page Seite D38 SNG.. 1204.. SNG.. 1207..</p>
<p>CSSN 45°</p>  <p>SNG.. 1204.. SNG.. 1207.. SNG.. 1507..</p> <p>Page Seite D39</p>	<p>CSYN 85°</p>  <p>Page Seite D40 SNG.. 1204.. SNG.. 1207..</p>			

**Top clamp ceramic PSC
PSC Keramikhalter mit oberer Klemmung**

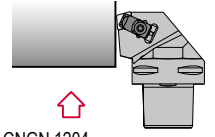
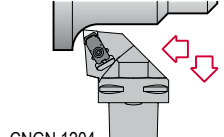
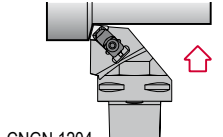
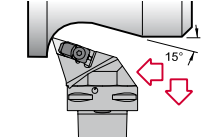
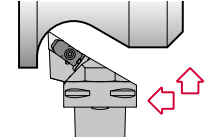
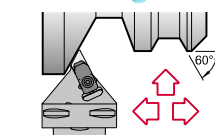
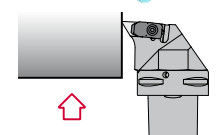
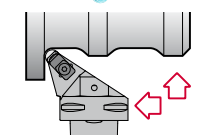
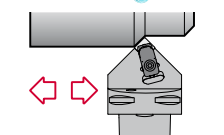
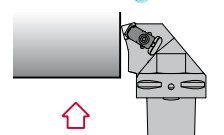
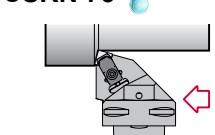
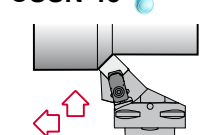
<p>CCKN 75°</p>  <p>CNGN 1204.. CNGN 1907..</p> <p>Page Seite D42</p>	<p>CCLN 95°</p>  <p>CNGN 1204.. CNGN 1907..</p> <p>Page Seite D43</p>	<p>CCRN 75°</p>  <p>CNGN 1204.. CNGN 1907..</p> <p>Page Seite D44</p>	<p>CDHN 107°30'</p>  <p>Page Seite D45 DNGN 1507..</p>	<p>CDJN 93°</p>  <p>Page Seite D46 DNGN 1507..</p>
<p>CDNN 63°</p>  <p>DNGN 1507..</p> <p>Page Seite D47</p>	<p>CDUN 93°</p>  <p>Page Seite D48 DNGN 1507..</p>	<p>CRSN</p>  <p>Page Seite D49 RNGN 1204.. RNGN 1207..</p>	<p>CSDN 45°</p>  <p>SNGN 1204.. SNGN 1207..</p> <p>Page Seite D50</p>	<p>CSKN 75°</p>  <p>Page Seite D51 SNGN 1204.. SNGN 1207..</p>
<p>CSRN 75°</p>  <p>Page Seite D52 SNGN 1204.. SNGN 1207..</p>	<p>CSSN 45°</p>  <p>Page Seite D53 SNGN 1204.. SNGN 1207..</p>			

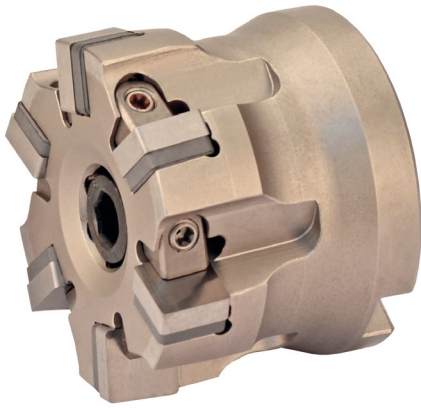

Characteristics:

Negative milling cutter with 88° entering angle. Its strong inserts accept high cutting depths and high feed per teeth. First option for cast iron milling.

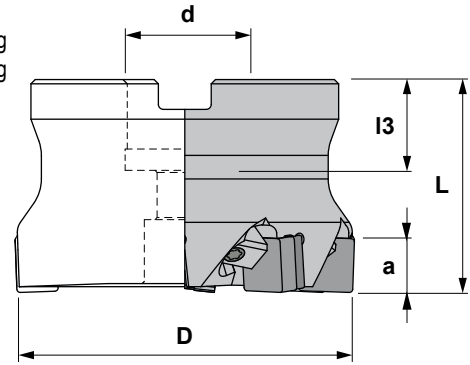

Eigenschaften:

Negativer Fräser mit 88° Einstellwinkel. Seine starken Wendeschneidplatten akzeptieren einen hohen Vorschub pro Zahn. Erste Wahl zum Fräsen von Guß.

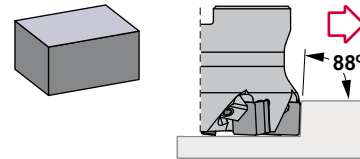

1242.90 88°

Reference Bezeichnung		D	L	I3	a	d	Insert size Wendeschneidplatte	
1242.90.063	6	63	50	22	12	27	SN.. 1204..	0,980
1242.90.080	8	80	50	22	12	27	SN.. 1204..	1,240
1242.90.100	10	100	50	25	12	32	SN.. 1204..	1,920
1242.90.125	12	125	63	29	12	40	SN.. 1204..	3,360

Reference Bezeichnung							Nm	
1242.90.063	1630	3212	6226	1266	5515	-	912,10	3.0
1242.90.080	1630	3212	6226	1266	5515	-	912,12	3.0
1242.90.100	1630	3212	6226	1266	-	5615	912,16	3.0
1242.90.125	1630	3212	6226	1266	-	5615	-	3.0

SN..

Square negative inserts. Vierkantige negative Wendeschneidplatten. D05

Reference / Bez.	l	s	d
SN.. 1204..	12,70	4,76	12,70

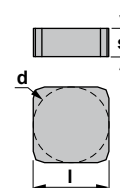

SNGN



SNGN





Characteristics:

Negative milling cutter with 75° entering angle. Its strong inserts accept high cutting depths and high feed per teeth. First option for cast iron milling.

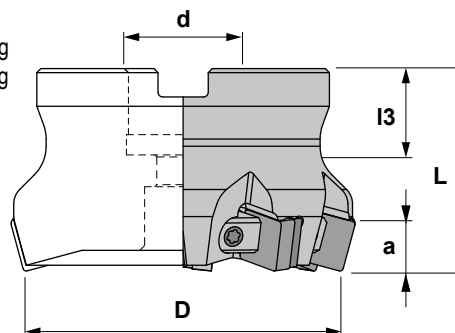

Eigenschaften:

Negativer Fräser mit 75° Einstellwinkel. Seine starken Wendeschneidplatten akzeptieren einen hohen Vorschub pro Zahn.

Erste Wahl zum Fräsen von Guß.

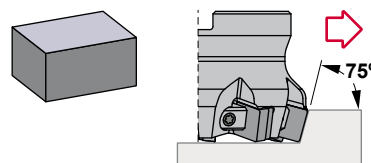

1442.90 75°

Reference Bezeichnung		D	L	I3	a	d	Insert size Wendeschneidplatte	
1442.90.063	6	63	50	22	11	27	SN.. 1204..	0,980
1442.90.080	8	80	50	22	11	27	SN.. 1204..	1,240
1442.90.100	10	100	50	25	11	32	SN.. 1204..	1,920
1442.90.125	12	125	63	29	11	40	SN.. 1204..	3,360

Reference Bezeichnung							Nm
1442.90.063	1630	3212	6226	1266	5515	-	3.0
1442.90.080	1630	3212	6226	1266	5515	-	3.0
1442.90.100	1630	3212	6226	1266	-	5615	3.0
1442.90.125	1630	3212	6226	1266	-	5615	3.0

SN..

Square negative inserts. Vierkantige negative Wendeschneidplatten. D05

Reference / Bez.	l	s	d
SN.. 1204..	12,70	4,76	12,70

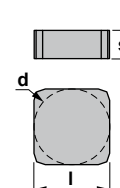

SNGN



SNGN





Characteristics:

Round insert cutter for slot milling, peripheral milling, ramp milling and drilling, pocket milling and copy milling.

It can be used in only one pass (roughing and finishing).

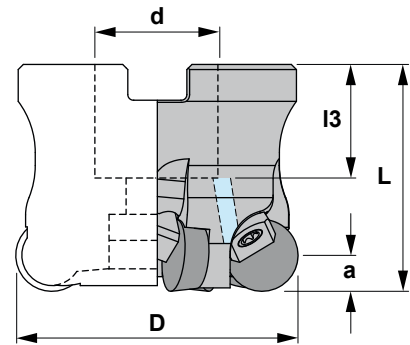

Eigenschaften:

Fräser mit runden Wendeschneidplatten zum Nutenfräsen, Zirkularfräsen (Bohrlocherweiterung), Stufenfräsen, Bohren, Taschenfräsen und Kopierfräsen.

Für allgemeine Bearbeitungen mit nur einem Durchgang (Schruppen und Schlichten).

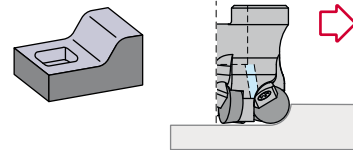

5540.90

Reference Bezeichnung		D	L	l3	a	d	Insert size Wendeschneidplatte	
5540.90.040	4	40	40	18	6,35	16	RPGN 1204..	0,200
5540.90.050	5	50	40	20	6,35	22	RPGN 1204..	0,330

Reference Bezeichnung					Nm
5540.90.040	1058	6226	1166	5515	3.0
5540.90.050	912,10	6226	1166	5515	3.0

RPGN

Round negative insert. Runde negative Wendeschneidplatte. D05

Reference / Bez.	s	d
RPGN 1204..	4,76	12,70

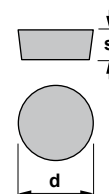



Characteristics:

Round insert end mill for slot milling, peripheral milling, ramp milling and drilling, pocket milling and copy milling.

It can be used in only one pass (roughing and finishing)

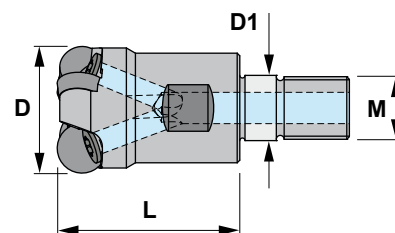

Eigenschaften:

Modularfräser mit runden Wendeschneidplatten zum Nutenfräsen, Zirkularfräsen (Bohrlocherweiterung), Stufenfräsen, Bohren, Taschenfräsen und Kopierfräsen.

Für allgemeine Bearbeitungen mit nur einem Durchgang (Schruppen und Schlichten).

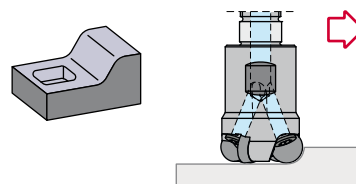

55²0.06

Reference Bezeichnung		L	M	D	D1	Insert size Wendeschneidplatte	
5520.06.016	2	23	M8	16	8,5	RPGN 0602..	0,030
5520.06.020	3	30	M10	20	10,5	RPGN 0602..	0,060
5530.06.025	3	35	M12	25	12,5	RPGN 0903..	0,100
5530.06.032	4	43	M16	32	16,5	RPGN 0903..	0,210
5540.06.032	3	43	M16	32	16,5	RPGN 1204..	0,220

Reference Bezeichnung			Nm
5520.06.016	1240	5515	3.0
5520.06.020	1240	5515	3.0
5530.06.025	1250	5520	4.0
5530.06.032	1250	5520	4.0
5540.06.032	1260	5525	5.0

RPGN

Round negative insert. Runde negative Wendeschneidplatte. D05

Reference / Bez.	s	d
RPGN 0602..	2,38	6,35
RPGN 0903..	3,18	9,52
RPGN 1204..	4,76	12,70

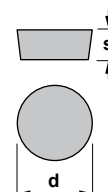

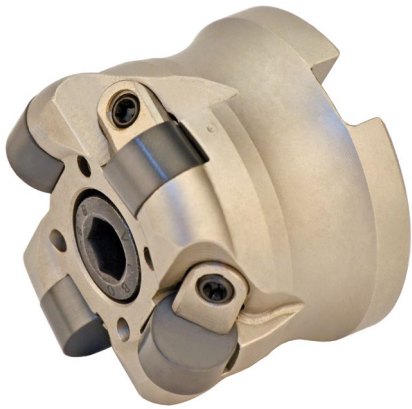

Characteristics:

Round negative insert cutter for slot milling, peripheral milling, ramp milling and drilling, pocket milling and copy milling. It can be used in only one pass (roughing and finishing).

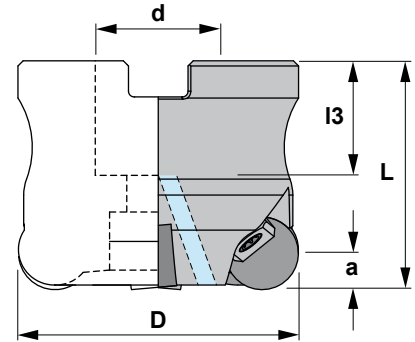

Eigenschaften:

Fräser mit runden negativen Wendeschneidplatten zum Nutenfräsen, Zirkularfräsen (Bohrlocherweiterung), Stufenfräsen, Bohren, Taschenfräsen und Kopierfräsen.

Für allgemeine Bearbeitungen mit nur einem Durchgang (Schruppen und Schlichten).

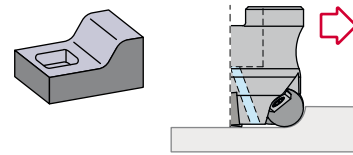

5542.90

Reference Bezeichnung		D	L	I3	a	d	Insert size Wendeschneidplatte	
5542.90.050	4	50	40	20	6,35	22	RNGN 1207..	0,350
5542.90.063	5	63	50	20	6,35	22	RNGN 1207..	0,800
5542.90.080	6	80	50	22	6,35	27	RNGN 1207..	1,250

Reference Bezeichnung					Nm
5542.90.050	912,10	6226	1166	5515	3.0
5542.90.063	912,10	6226	1266	5515	3.0
5542.90.080	912,12	6226	1266	5515	3.0

RNGN

Round negative insert. Runde negative Wendeschneidplatte. D04

Reference / Bez.	s	d
RNGN 1207..	7,94	12,70

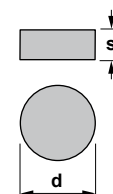



Ceramic milling cutters

Ceramic inserts run faster than carbide inserts, so productivity is highly increased in high-temperature machining.

Fräser für Keramik-Wendeschnidplatten

Die Keramik-Wendeschnidplatten arbeiten schneller als die Hartmetall-Wendeschnidplatten. Auf dieser Weise erhöht sich die Produktivität bei hohen Temperaturen.

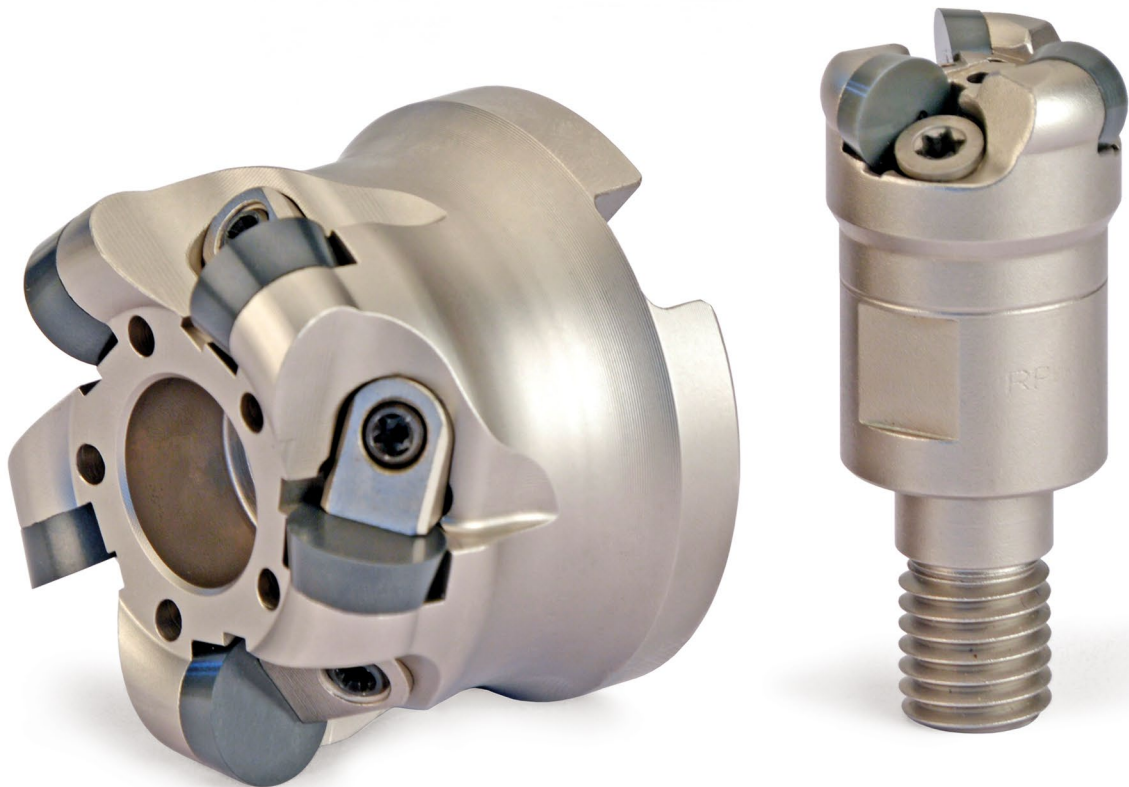



Characteristics:

Toolholder for external turning applications equipped with rhombic negative inserts (angle 80°).

For general applications, roughing, semi-finishing and finishing.

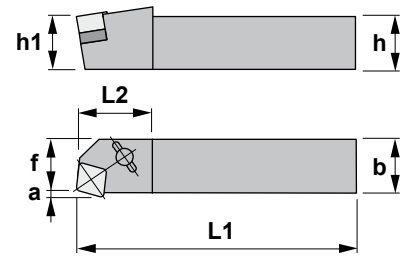

Eigenschaften:

Klemmhalter zum Außendrehen mit einer rhombischen negativen Wendschneidplatte (80° Winkel).

Für allgemeine Anwendungen, Schruppen, Vorschlichten und Schlichten geeignet.

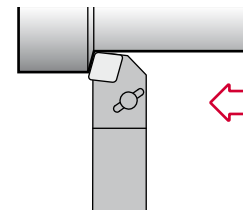

CCBN 75°

Reference Bezeichnung	h=h1	b	L1	L2	f	a	Insert size Wendschneidplatte	Kg
CCBN R/L 2525 M12-4CD	25	25	150	34	22	3,10	CNGN 1204..	0,750
CCBN R/L 2525 M12-7CD	25	25	150	34	22	3,10	CNGN 1207..	0,750
CCBN R/L 3225 P12-4CD	32	25	170	34	22	3,10	CNGN 1204..	1,050
CCBN R/L 3225 P12-7CD	32	25	170	34	22	3,10	CNGN 1207..	1,050
CCBN R/L 2525 M16-CD	25	25	150	34	27	3,82	CNGN 1607..	0,750
CCBN R/L 3225 P16-CD	32	25	170	34	27	3,82	CNGN 1607..	1,050
CCBN R/L 2525 M12-4CX	25	25	150	34	22	3,10	CNGX 1204..	0,750
CCBN R/L 2525 M12-7CX	25	25	150	34	22	3,10	CNGX 1207..	0,750
CCBN R/L 3225 P12-4CX	32	25	170	34	22	3,10	CNGX 1204..	1,050
CCBN R/L 3225 P12-7CX	32	25	170	34	22	3,10	CNGX 1207..	1,050
CCBN R/L 2525 M16-CX	25	25	150	34	27	3,82	CNGX 1607..	0,750
CCBN R/L 3225 P16-CX	32	25	170	34	27	3,82	CNGX 1607..	1,050

Reference Bezeichnung							Nm
CCBN R/L 2525 M12-4CD	ICSN 454	1160	9414	2417	-	5004	3.5
CCBN R/L 2525 M12-7CD	ICSN 434	1160	9414	2417	-	5004	3.5
CCBN R/L 3225 P12-4CD	ICSN 454	1160	9414	2417	-	5004	3.5
CCBN R/L 3225 P12-7CD	ICSN 434	1160	9414	2417	-	5004	3.5
CCBN R/L 2525 M16-CD	ICSN 533	1180	9414	2417	-	5004	3.5
CCBN R/L 3225 P16-CD	ICSN 533	1180	9414	2417	-	5004	3.5
CCBN R/L 2525 M12-4CX	ICSN 454	1160	-	-	2471	5004	3.5
CCBN R/L 2525 M12-7CX	ICSN 434	1160	-	-	2471	5004	3.5
CCBN R/L 3225 P12-4CX	ICSN 454	1160	-	-	2471	5004	3.5
CCBN R/L 3225 P12-7CX	ICSN 434	1160	-	-	2471	5004	3.5
CCBN R/L 2525 M16-CX	ICSN 533	1180	-	-	2415	5004	3.5
CCBN R/L 3225 P16-CX	ICSN 533	1180	-	-	2415	5004	3.5

CNG.. 80° rhombic negative inserts. D03
80° rhombische negative Wendschneidplatten.

Reference / Bez.	l	s	d
CNG.. 1204..	12,90	4,76	12,70
CNG.. 1207..	12,90	7,94	12,70
CNG.. 1607..	16,10	7,94	15,88

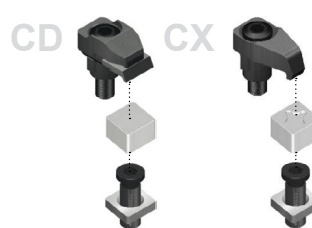
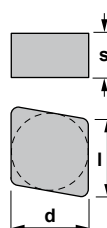

CNGN



CNGX





Characteristics:

Toolholder for face turning applications equipped with rhombic negative inserts (angle 80°).

For general applications, roughing, semi-finishing and finishing.

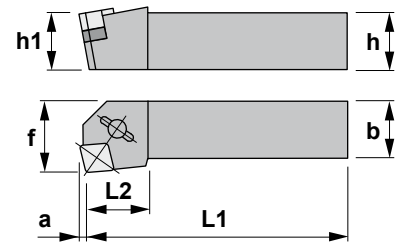

Eigenschaften:

Klemmhalter zum Plandrehen mit einer rhombischen negativen Wendeschneidplatte (80° Winkel).

Für allgemeine Anwendungen, Schruppen, Vorschlichten und Schlichten geeignet.

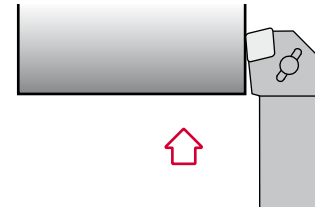

CCKN 75°

Reference Bezeichnung	h=h1	b	L1	L2	f	a	Insert size Wendeschneidplatte	Kg
CCKN R/L 2525 M12-4CD	25	25	150	29	32	3,10	CNGN 1204..	0,750
CCKN R/L 2525 M12-7CD	25	25	150	29	32	3,10	CNGN 1207..	0,750
CCKN R/L 3225 P12-4CD	32	25	170	29	32	3,10	CNGN 1204..	1,050
CCKN R/L 3225 P12-7CD	32	25	170	29	32	3,10	CNGN 1207..	1,050
CCKN R/L 2525 M12-4CX	25	25	150	29	32	3,10	CNGX 1204..	0,750
CCKN R/L 2525 M12-7CX	25	25	150	29	32	3,10	CNGX 1207..	0,750
CCKN R/L 3225 P12-4CX	32	25	170	29	32	3,10	CNGX 1204..	1,050
CCKN R/L 3225 P12-7CX	32	25	170	29	32	3,10	CNGX 1207..	1,050

Reference Bezeichnung							Nm
CCKN R/L 2525 M12-4CD	ICSN 454	1160	9414	2417	-	5004	3.5
CCKN R/L 2525 M12-7CD	ICSN 434	1160	9414	2417	-	5004	3.5
CCKN R/L 3225 P12-4CD	ICSN 454	1160	9414	2417	-	5004	3.5
CCKN R/L 3225 P12-7CD	ICSN 434	1160	9414	2417	-	5004	3.5
CCKN R/L 2525 M12-4CX	ICSN 454	1160	-	-	2471	5004	3.5
CCKN R/L 2525 M12-7CX	ICSN 434	1160	-	-	2471	5004	3.5
CCKN R/L 3225 P12-4CX	ICSN 454	1160	-	-	2471	5004	3.5
CCKN R/L 3225 P12-7CX	ICSN 434	1160	-	-	2471	5004	3.5

CNG.. 80° rhombic negative inserts. D03
80° rhombische negative Wendeschneidplatten.

Reference / Bez.	l	s	d
CNG.. 1204..	12,90	4,76	12,70
CNG.. 1207..	12,90	7,94	12,70

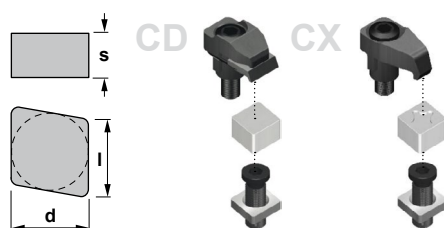

CNGN



CNGX



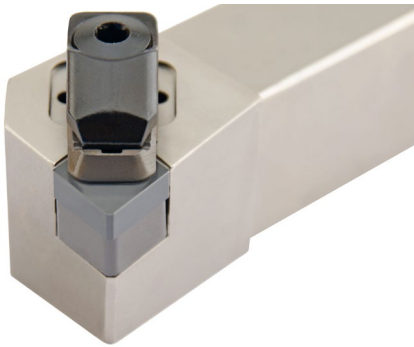

Characteristics:

Multipurpose toolholder equipped with rhombic negative double-sided insert (angle 80°).

For general applications, roughing, semi-finishing and finishing.

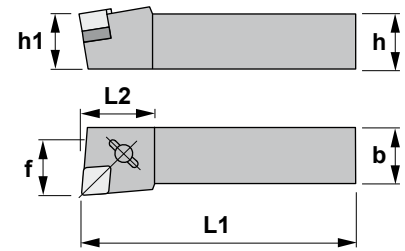

Eigenschaften:

Multifunktions-Klemmhalter mit einer doppelseitigen rhombischen negativen Wendeschneidplatte (80° Winkel).

Für allgemeine Anwendungen, Schruppen, Vorschlichten und Schlichten geeignet.

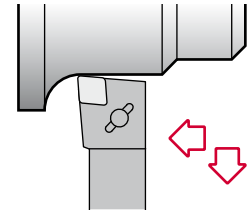

CCLN 95°

Reference Bezeichnung	h=h1	b	L1	L2	f	Insert size Wendeschneidplatte	Kg
CCLN R/L 2525 M12-4CD	25	25	150	34	32	CNGN 1204..	0,750
CCLN R/L 2525 M12-7CD	25	25	150	34	32	CNGN 1207..	0,750
CCLN R/L 3225 P12-4CD	32	25	170	34	32	CNGN 1204..	1,050
CCLN R/L 3225 P12-7CD	32	25	170	34	32	CNGN 1207..	1,050
CCLN R/L 2525 M16-CD	25	25	150	34	32	CNGN 1607..	0,750
CCLN R/L 3225 P16-CD	32	25	170	38	32	CNGN 1607..	1,050
CCLN R/L 2525 M12-4CX	25	25	150	34	32	CNGX 1204..	0,750
CCLN R/L 2525 M12-7CX	25	25	150	34	32	CNGX 1207..	0,750
CCLN R/L 3225 P12-4CX	32	25	170	34	32	CNGX 1204..	1,050
CCLN R/L 3225 P12-7CX	32	25	170	34	32	CNGX 1207..	1,050
CCLN R/L 2525 M16-CX	25	25	150	34	32	CNGX 1607..	0,750
CCLN R/L 3225 P16-CX	32	25	170	38	32	CNGX 1607..	1,050

Reference Bezeichnung							Nm
CCLN R/L 2525 M12-4CD	ICSN 454	1160	9414	2417	-	5004	3.5
CCLN R/L 2525 M12-7CD	ICSN 434	1160	9414	2417	-	5004	3.5
CCLN R/L 3225 P12-4CD	ICSN 454	1160	9414	2417	-	5004	3.5
CCLN R/L 3225 P12-7CD	ICSN 434	1160	9414	2417	-	5004	3.5
CCLN R/L 2525 M16-CD	ICSN 533	1180	9414	2417	-	5004	3.5
CCLN R/L 3225 P16-CD	ICSN 533	1180	9414	2417	-	5004	3.5
CCLN R/L 2525 M12-4CX	ICSN 454	1160	-	-	2415	5004	3.5
CCLN R/L 2525 M12-7CX	ICSN 434	1160	-	-	2415	5004	3.5
CCLN R/L 3225 P12-4CX	ICSN 454	1160	-	-	2415	5004	3.5
CCLN R/L 3225 P12-7CX	ICSN 434	1160	-	-	2415	5004	3.5
CCLN R/L 2525 M16-CX	ICSN 533	1180	-	-	2432	5004	3.5
CCLN R/L 3225 P16-CX	ICSN 533	1180	-	-	2432	5004	3.5

CNG.. 80° rhombic negative inserts. D03
80° rhombische negative Wendeschneidplatten.

Reference / Bez.	l	s	d
CNG.. 1204..	12,90	4,76	12,70
CNG.. 1207..	12,90	7,94	12,70
CNG.. 1607..	16,10	7,94	15,88

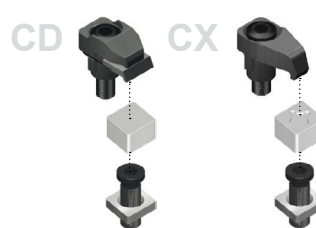
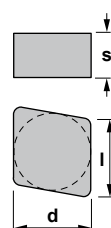

CNGN



CNGX





Characteristics:

Turning and profiling toolholder equipped with rhombic negative double-sided insert (angle 55°).

For general applications, roughing, semi-finishing and finishing.

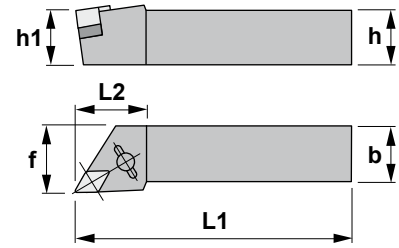

Eigenschaften:

Klemmhalter zum Drehen und Profildrehen mit einer doppelseitigen rhombischen negativen Wendeschneidplatte (55° Winkel).

Für allgemeine Anwendungen, Schruppen, Vorschlichten und Schlichten geeignet.

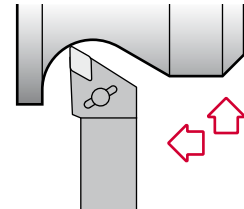

CDJN 93°

Reference Bezeichnung	h=h1	b	L1	L2	f	Insert size Wendeschneidplatte	Kg
CDJN R/L 2525 M12-4CD	25	25	150	34	32	DNGN 1204..	0,750
CDJN R/L 2525 M12-7CD	25	25	150	34	32	DNGN 1207..	0,750
CDJN R/L 3225 P12-4CD	32	25	170	34	32	DNGN 1204..	1,050
CDJN R/L 3225 P12-7CD	32	25	170	34	32	DNGN 1207..	1,050
CDJN R/L 2525 M15-CD	25	25	150	38	32	DNGN 1507..	0,750
CDJN R/L 3225 P15-CD	32	25	170	38	32	DNGN 1507..	1,050
CDJN R/L 2525 M12-4CX	25	25	150	34	32	DNGX 1204..	0,750
CDJN R/L 2525 M12-7CX	25	25	150	34	32	DNGX 1207..	0,750
CDJN R/L 3225 P12-4CX	32	25	170	34	32	DNGX 1204..	1,050
CDJN R/L 3225 P12-7CX	32	25	170	34	32	DNGX 1207..	1,050
CDJN R/L 2525 M15-CX	25	25	150	38	32	DNGX 1507..	0,750
CDJN R/L 3225 P15-CX	32	25	170	38	32	DNGX 1507..	1,050

Reference Bezeichnung							Nm
CDJN R/L 2525 M12-4CD	IDSN 354	1150	9416	2413	-	5004	3.5
CDJN R/L 2525 M12-7CD	IDSN 334	1150	9416	2413	-	5004	3.5
CDJN R/L 3225 P12-4CD	IDSN 354	1150	9416	2413	-	5004	3.5
CDJN R/L 3225 P12-7CD	IDSN 334	1150	9416	2413	-	5004	3.5
CDJN R/L 2525 M15-CD	IDSN 434	1160	9416	2417	-	5004	3.5
CDJN R/L 3225 P15-CD	IDSN 434	1160	9416	2417	-	5004	3.5
CDJN R/L 2525 M12-4CX	IDSN 354	1150	-	-	2415	5004	3.5
CDJN R/L 2525 M12-7CX	IDSN 334	1150	-	-	2415	5004	3.5
CDJN R/L 3225 P12-4CX	IDSN 354	1150	-	-	2415	5004	3.5
CDJN R/L 3225 P12-7CX	IDSN 334	1150	-	-	2415	5004	3.5
CDJN R/L 2525 M15-CX	IDSN 434	1160	-	-	2432	5004	3.5
CDJN R/L 3225 P15-CX	IDSN 434	1160	-	-	2432	5004	3.5

DNG.. 55° rhombic negative inserts. 55° rhombische negative Wendeschneidplatten. D03-04

Reference / Bez.	l	s	d
DNG.. 1204..	12,20	4,76	10,00
DNG.. 1207..	12,20	7,94	10,00
DNG.. 1507..	15,50	7,94	12,70

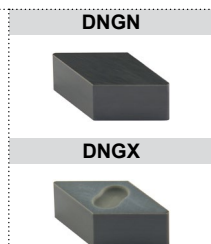
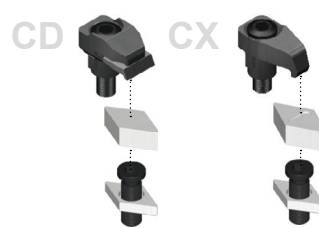
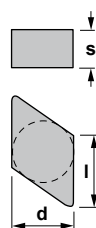

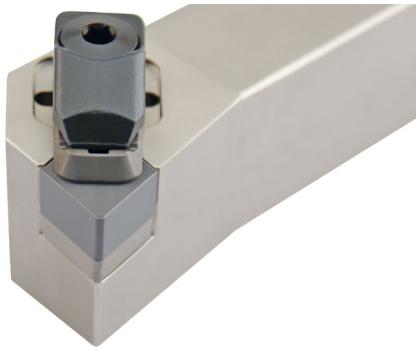

Characteristics:

Multipurpose toolholder equipped with rhombic negative double-sided insert (angle 75°).

For general applications, roughing, semi-finishing and finishing.

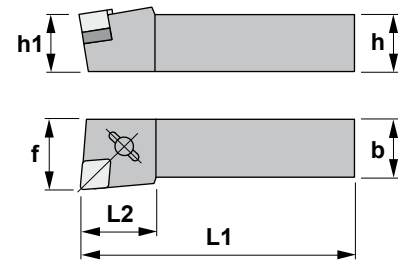

Eigenschaften:

Multifunktions-Klemmhalter mit einer doppelseitigen rhombischen negativen Wendeschneidplatte (75° Winkel).

Für allgemeine Anwendungen, Schruppen, Vorschlichten und Schlichten geeignet.

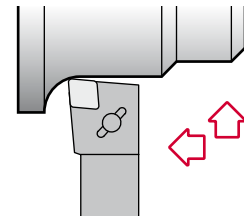

CELN 97°30'

Reference Bezeichnung	h=h1	b	L1	L2	f	Insert size Wendeschneidplatte	Kg
CELN R/L 2020 K13-CD	20	20	125	34	25	ENGN 1307..	0,400
CELN R/L 2525 M13-CD	25	25	150	34	32	ENGN 1307..	0,750
CELN R/L 3225 P13-CD	32	25	170	34	32	ENGN 1307..	1,050

Reference Bezeichnung						Nm
CELN R/L 2020 K13-CD	IESN 432	1161	9414	2417	5004	3.5
CELN R/L 2525 M13-CD	IESN 432	1160	9414	2417	5004	3.5
CELN R/L 3225 P13-CD	IESN 432	1160	9414	2417	5004	3.5

ENGN

75° rhombic negative insert. D04
75° rhombische negative Wendeschneidplatte.

Reference / Bez.	l	s	d
ENGN 1307..	13,12	7,94	12,70

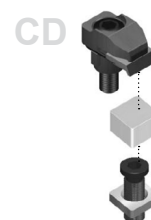
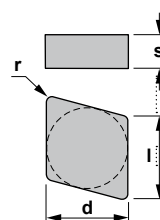

ENGN



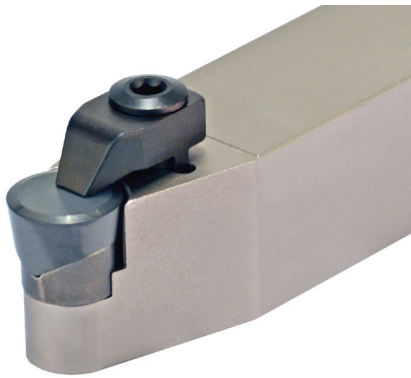

Characteristics:
Profiling toolholder equipped with round positive insert.
For general applications, roughing, semi-finishing and finishing.

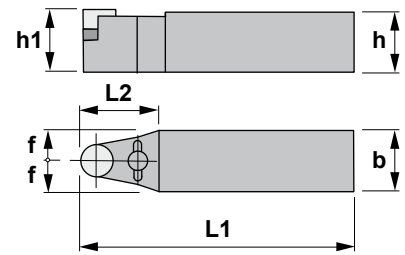

Eigenschaften:
Klemmhalter zum Profildrehen mit einer runden positiven Wendeschneidplatte.
Für allgemeine Anwendungen, Schruppen, Vorschlichten und Schlichten geeignet.

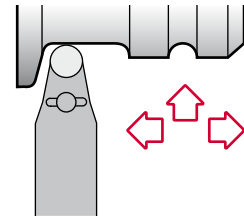

CRDC

Reference Bezeichnung	h=h1	b	L1	L2	f	Insert size Wendeschneidplatte	kg
CRDC N 2525 M06	25	25	150	28	12,5	RCGX 0607..	0,750
CRDC N 2525 M09	25	25	150	20	12,5	RCGX 0907..	0,750
CRDC N 3225 P09	32	25	170	20	12,5	RCGX 0907..	0,750
CRDC N 2525 M12	25	25	150	25	12,5	RCGX 1207..	0,750
CRDC N 3225 P12	32	25	170	25	12,5	RCGX 1207..	1,050
CRDC N 2525 M15	25	25	150	30	12,5	RCGX 1507..	0,750
CRDC N 3225 P15	32	25	170	30	12,5	RCGX 1507..	1,050
CRDC N 3225 P19	32	25	170	42	12,5	RCGX 1910..	1,050
CRDC N 3232 P19	32	32	170	42	16,0	RCGX 1910..	1,300
CRDC N 3232 P25	32	32	170	45	16,0	RCGX 2512..	1,300

Reference Bezeichnung										Nm	
CRDC N 2525 M06	3806	-	-	1392	2120	1335	-	5515	3807	3808	3.0
CRDC N 2525 M09	3849	-	-	1335	2121	1250	-	5520	-	-	4.0
CRDC N 3225 P09	3849	-	-	1335	2121	1250	-	5520	-	-	4.0
CRDC N 2525 M12	3852	-	-	1350	2122	1260	-	5525	-	-	5.0
CRDC N 3225 P12	3852	-	-	1350	2122	1260	-	5525	-	-	5.0
CRDC N 2525 M15	-	3817	-	1230 (2)	2414	-	5004	-	-	-	3.5
CRDC N 3225 P15	-	3817	-	1230 (2)	2414	-	5004	-	-	-	3.5
CRDC N 3225 P19	-	3819	-	1230 (2)	2414	-	5004	-	-	-	3.5
CRDC N 3232 P19	-	3819	9414	1230 (2)	2414	-	5004	-	-	-	3.5
CRDC N 3232 P25	-	3835	9414	1230 (2)	2417	-	5004	-	-	-	3.5

RCGX 0606.. RCGX 0604..
inserts inserts
Wendeplatten Wendeplatten

RCGX

Round positive insert with 7° clearance.
Runde positive Wendeschneidplatte mit 7° Freiwinkel. D04

Reference / Bez.	a	s	d
RCGX 0607..	120°	7,94	6,35
RCGX 0907..	120°	7,94	9,52
RCGX 1207..	120°	7,94	12,70
RCGX 1507..	120°	7,94	15,87
RCGX 1910..	120°	10,00	19,05
RCGX 1910..	120°	10,00	19,05
RCGX 2512..	140°	12,00	25,40

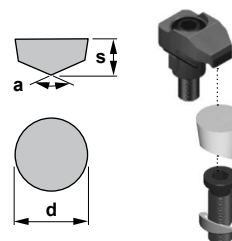

RCGX





Characteristics:

Profiling multipurpose turning toolholder equipped with round negative inserts. For general applications, roughing, semi-finishing and finishing.

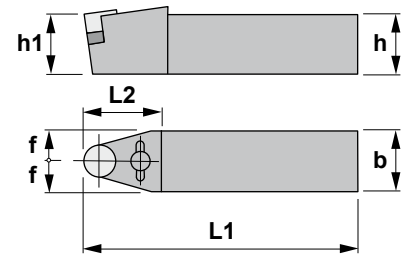

Eigenschaften:

Multifunktions-Klemmhalter zum Profildrehen mit einer runden negativen Wendeschneidplatte. Für allgemeine Anwendungen, Schruppen, Vorschlichten und Schlichten geeignet.

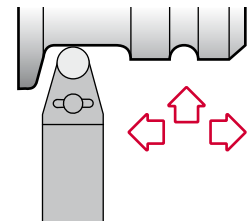

CRDN

Reference Bezeichnung	h=h1	b	L1	L2	f	Insert size Wendeschneidplatte	kg
CRDN N 2525 M12-4CD	25	25	150	34	12,5	RNGN 1204..	0,750
CRDN N 2525 M12-7CD	25	25	150	34	12,5	RNGN 1207..	0,750
CRDN N 3225 P12-4CD	32	25	170	34	12,5	RNGN 1204..	1,050
CRDN N 3225 P12-7CD	32	25	170	34	12,5	RNGN 1207..	1,050
CRDN N 2525 M15-7CD	25	25	150	34	12,5	RNGN 1507..	0,750
CRDN N 3225 P15-7CD	32	25	170	42	12,5	RNGN 1507..	1,050
CRDN N 3225 P19-7CD	32	25	170	42	12,5	RNGN 1907..	1,050
CRDN N 3232 P25-7CD	32	32	170	42	16,0	RNGN 2507..	1,300

Reference Bezeichnung						Nm
CRDN N 2525 M12-4CD	IRSN 45	1160	2413	9414	5004	3.5
CRDN N 2525 M12-7CD	IRSN 43	1160	2413	9414	5004	3.5
CRDN N 3225 P12-4CD	IRSN 45	1160	2413	9414	5004	3.5
CRDN N 3225 P12-7CD	IRSN 43	1160	2413	9414	5004	3.5
CRDN N 2525 M15-7CD	IRSN 53	1180	2417	9414	5004	3.5
CRDN N 3225 P15-7CD	IRSN 53	1180	2417	9414	5004	3.5
CRDN N 3225 P19-7CD	3919	1182	2417	9414	5004	3.5
CRDN N 3232 P25-7CD	3925	1192	2417	9414	5004	3.5

RNGN

Round negative insert.
Runde negative Wendeschneidplatte. D04

Reference / Bez.	s	d
RNGN 1204..	4,76	12,70
RNGN 1207..	7,94	12,70
RNGN 1507..	7,94	15,88
RNGN 1907..	7,94	19,05
RNGN 2507..	7,94	25,40

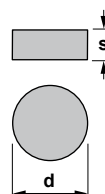

RNGN





Characteristics:
Profiling multipurpose turning toolholder equipped with round negative inserts.
For general applications, roughing, semi-finishing and finishing.

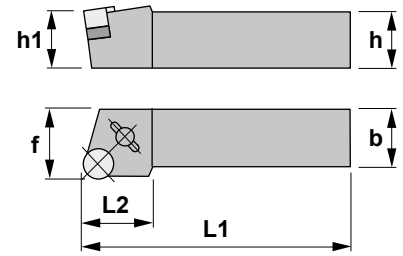

Eigenschaften:
Multifunktions-Klemmhalter zum Profildrehen mit einer runden negativen Wendschneidplatte.
Für allgemeine Anwendungen, Schruppen, Vorschlichten und Schlichten geeignet.

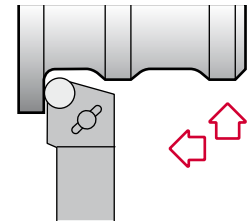

CRSN

Reference Bezeichnung	h=h1	b	L1	L2	f	Insert size Wendschneidplatte	KG
CRSN R/L 2525 M12-4CD	25	25	150	34	32	RNGN 1204..	0,750
CRSN R/L 2525 M12-7CD	25	25	150	34	32	RNGN 1207..	0,750
CRSN R/L 3225 P12-4CD	32	25	170	34	32	RNGN 1204..	1,050
CRSN R/L 3225 P12-7CD	32	25	170	34	32	RNGN 1207..	1,050

Reference Bezeichnung						Nm
CRSN R/L 2525 M12-4CD	IRSN 45	1160	2413	9414	5004	3.5
CRSN R/L 2525 M12-7CD	IRSN 43	1160	2413	9414	5004	3.5
CRSN R/L 3225 P12-4CD	IRSN 45	1160	2413	9414	5004	3.5
CRSN R/L 3225 P12-7CD	IRSN 43	1160	2413	9414	5004	3.5

RNGN

Round negative insert.
Runde negative Wendschneidplatte. D04

Reference / Bez.	s	d
RNGN 1204..	4,76	12,70
RNGN 1207..	7,94	12,70

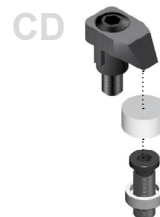
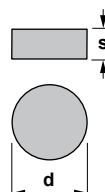

RNGN





Characteristics:

Toolholder for external turning and chamfering applications equipped with square negative inserts.

For general applications, roughing, semi-finishing and finishing.

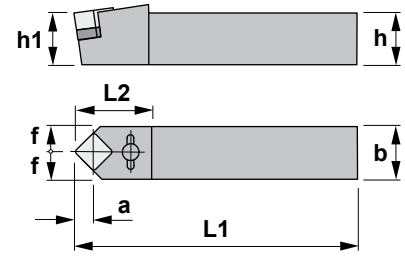

Eigenschaften:

Klemhalter zum Außendrehen und Abschrägen mit einer vierkantigen negativen Wendeschneidplatte.

Für allgemeine Anwendungen, Schruppen, Vorschlichten und Schlichten geeignet.

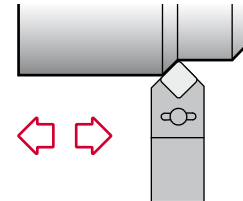

CSDN 45°

Reference Bezeichnung	h=h1	b	L1	L2	f	a	Insert size Wendeschneidplatte	kg
CSDN N 2525 M12-4CD	25	25	150	42	12,5	8,32	SNGN 1204..	0,750
CSDN N 2525 M12-7CD	25	25	150	42	12,5	8,32	SNGN 1207..	0,750
CSDN N 3225 P12-4CD	32	25	170	42	12,5	8,32	SNGN 1204..	1,050
CSDN N 3225 P12-7CD	32	25	170	42	12,5	10,23	SNGN 1207..	1,050
CSDN N 2525 M15-CD	25	25	150	42	12,5	8,32	SNGN 1507..	0,750
CSDN N 3225 P15-CD	32	25	170	42	12,5	10,23	SNGN 1507..	1,050
CSDN N 2525 M12-4CX	25	25	150	42	12,5	8,32	SNGX 1204..	0,750
CSDN N 2525 M12-7CX	25	25	150	42	12,5	8,32	SNGX 1207..	0,750
CSDN N 3225 P12-4CX	32	25	170	42	12,5	8,32	SNGX 1204..	1,050
CSDN N 3225 P12-7CX	32	25	170	42	12,5	8,32	SNGX 1207..	1,050
CSDN N 2525 M15-CX	25	25	150	42	12,5	10,23	SNGX 1507..	0,750
CSDN N 3225 P15-CX	32	25	170	42	12,5	10,23	SNGX 1507..	1,050

Reference Bezeichnung						Nm	
CSDN N 2525 M12-4CD	ISSN 454	1160	9414	2417	-	5004	3.5
CSDN N 2525 M12-7CD	ISSN 434	1160	9414	2417	-	5004	3.5
CSDN N 3225 P12-4CD	ISSN 454	1160	9414	2417	-	5004	3.5
CSDN N 3225 P12-7CD	ISSN 434	1160	9414	2417	-	5004	3.5
CSDN N 2525 M15-CD	ISSN 534	1180	9414	2417	-	5004	3.5
CSDN N 3225 P15-CD	ISSN 534	1180	9414	2417	-	5004	3.5
CSDN N 2525 M12-4CX	ISSN 454	1160	-	-	2415	5004	3.5
CSDN N 2525 M12-7CX	ISSN 434	1160	-	-	2415	5004	3.5
CSDN N 3225 P12-4CX	ISSN 454	1160	-	-	2415	5004	3.5
CSDN N 3225 P12-7CX	ISSN 434	1160	-	-	2415	5004	3.5
CSDN N 2525 M15-CX	ISSN 534	1180	-	-	2415	5004	3.5
CSDN N 3225 P15-CX	ISSN 534	1180	-	-	2415	5004	3.5

SNG.. Square negative inserts. Vierkantige negative Wendeschneidplatten. D05-06

Reference / Bez.	l	s	d
SNG.. 1204..	12,70	4,76	12,70
SNG.. 1207..	12,70	7,94	12,70
SNG.. 1507..	15,87	7,94	15,87

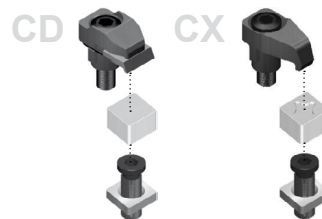
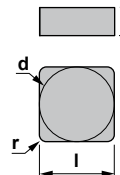

SNGN



SNGX



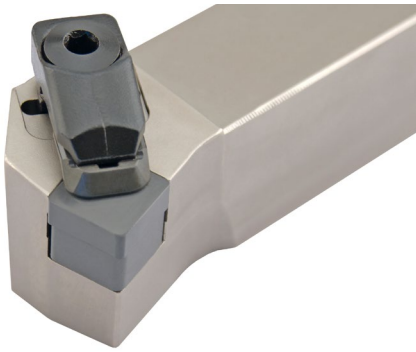

Characteristics:

Toolholder for face turning applications equipped with square negative inserts and strong cutting edges.

For general applications, roughing, semi-finishing and finishing.

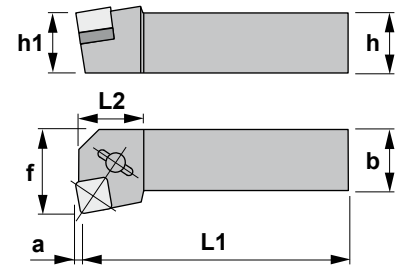

Eigenschaften:

Klemmhalter zum Plandrehen mit einer vierkantigen negativen Wendeschneidplatte mit verstärkten Schnittkanten.

Für allgemeine Anwendungen, Schruppen, Vorschlichten und Schlichten geeignet.

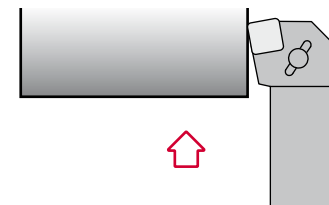

CSKN 75°

Reference Bezeichnung	h=h1	b	L1	L2	f	a	Insert size Wendeschneidplatte	KG
CSKN R/L 2525 M12-4CD	25	25	150	34	32	3,06	SNGN 1204..	0,750
CSKN R/L 2525 M12-7CD	25	25	150	34	32	3,06	SNGN 1207..	0,750
CSKN R/L 3225 P12-4CD	32	25	170	34	32	3,06	SNGN 1204..	1,050
CSKN R/L 3225 P12-7CD	32	25	170	34	32	3,06	SNGN 1207..	1,050
CSKN R/L 2525 M15-CD	25	25	150	34	32	3,77	SNGN 1507..	0,750
CSKN R/L 3225 P15-CD	32	25	170	34	32	3,77	SNGN 1507..	1,050
CSKN R/L 2525 M12-4CX	25	25	150	34	32	3,06	SNGX 1204..	0,750
CSKN R/L 2525 M12-7CX	25	25	150	34	32	3,06	SNGX 1207..	0,750
CSKN R/L 3225 P12-4CX	32	25	170	34	32	3,06	SNGX 1207..	1,050
CSKN R/L 3225 P12-7CX	32	25	170	34	32	3,06	SNGX 1207..	1,050
CSKN R/L 2525 M15-CX	25	25	150	34	32	3,77	SNGX 1507..	0,750
CSKN R/L 3225 P15-CX	32	25	170	34	32	3,77	SNGX 1507..	1,050
CSKN R/L 4040 P15-CX	40	40	170	34	50	3,77	SNGX 1507..	1,300

Reference Bezeichnung								Nm
CSKN R/L 2525 M12-4CD	ISSN 454	1160	9414	2417	-	5004		3.5
CSKN R/L 2525 M12-7CD	ISSN 434	1160	9414	2417	-	5004		3.5
CSKN R/L 3225 P12-4CD	ISSN 454	1160	9414	2417	-	5004		3.5
CSKN R/L 3225 P12-7CD	ISSN 434	1160	9414	2417	-	5004		3.5
CSKN R/L 2525 M15-CD	ISSN 534	1180	9414	2417	-	5004		3.5
CSKN R/L 3225 P15-CD	ISSN 534	1180	9414	2417	-	5004		3.5
CSKN R/L 2525 M12-4CX	ISSN 454	1160	-	-	2415	5004		3.5
CSKN R/L 2525 M12-7CX	ISSN 434	1160	-	-	2415	5004		3.5
CSKN R/L 3225 P12-4CX	ISSN 454	1160	-	-	2415	5004		3.5
CSKN R/L 3225 P12-7CX	ISSN 434	1160	-	-	2415	5004		3.5
CSKN R/L 2525 M15-CX	ISSN 534	1180	-	-	2415	5004		3.5
CSKN R/L 3225 P15-CX	ISSN 534	1180	-	-	2415	5004		3.5
CSKN R/L 4040 P15-CX	ISSN 534	1180	-	-	2415	5004		3.5

SNG.. Square negative inserts. Vierkantige negative Wendeschneidplatten. D05-06

Reference / Bez.	l	s	d
SNG.. 1204..	12,70	4,76	12,70
SNG.. 1207..	12,70	7,94	12,70
SNG.. 1507..	15,87	7,94	15,87

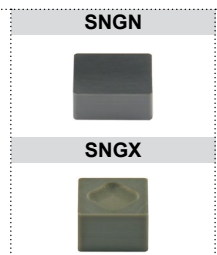
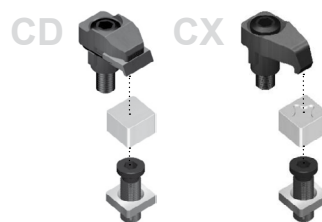
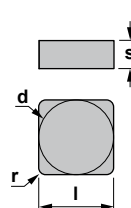



Characteristics:

Toolholder for external turning applications equipped with square negative inserts.

For general applications, roughing, semi-finishing and finishing.

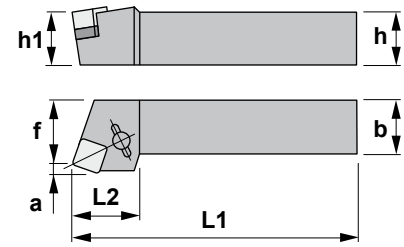

Eigenschaften:

Klemmhalter zum Außendreien mit einer vierkantigen negativen Wendeschneidplatte.

Für allgemeine Anwendungen, Schruppen, Vorschlichten und Schlichten geeignet.

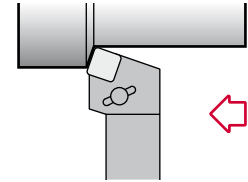

CSRN 75°

Reference Bezeichnung	h=h1	b	L1	L2	f	a	Insert size Wendeschneidplatte	kg
CSRN R/L 2525 M12-4CD	25	25	150	34	27	3,06	SNGN 1204..	0,750
CSRN R/L 2525 M12-7CD	25	25	150	34	27	3,06	SNGN 1207..	0,750
CSRN R/L 3225 P12-4CD	32	25	170	34	27	3,06	SNGN 1204..	1,050
CSRN R/L 3225 P12-7CD	32	25	170	34	27	3,06	SNGN 1207..	1,050
CSRN R/L 2525 M15-CD	25	25	150	34	27	3,77	SNGN 1507..	0,750
CSRN R/L 3225 P15-CD	32	25	170	38	27	3,77	SNGN 1507..	1,050
CSRN R/L 3232 P19-CD	32	32	170	42	35	4,50	SNGN 1907..	1,150
CSRN R/L 4040 P19-CD	40	40	170	42	43	4,50	SNGN 1907..	1,300
CSRN R/L 2525 M12-4CX	25	25	150	34	27	3,06	SNGX 1204..	0,750
CSRN R/L 2525 M12-7CX	25	25	150	34	27	3,06	SNGX 1207..	0,750
CSRN R/L 3225 P12-4CX	32	25	170	34	27	3,06	SNGX 1204..	1,050
CSRN R/L 3225 P12-7CX	32	25	170	34	27	3,06	SNGX 1207..	1,050
CSRN R/L 2525 M15-CX	25	25	150	34	27	3,77	SNGX 1507..	0,750
CSRN R/L 3225 P15-CX	32	25	170	38	27	3,77	SNGX 1507..	1,050

Reference Bezeichnung							Nm
CSRN R/L 2525 M12-4CD	ISSN 454	1160	9414	2417	-	5004	3.5
CSRN R/L 2525 M12-7CD	ISSN 434	1160	9414	2417	-	5004	3.5
CSRN R/L 3225 P12-4CD	ISSN 454	1160	9414	2417	-	5004	3.5
CSRN R/L 3225 P12-7CD	ISSN 434	1160	9414	2417	-	5004	3.5
CSRN R/L 2525 M15-CD	ISSN 534	1180	9414	2417	-	5004	3.5
CSRN R/L 3225 P15-CD	ISSN 534	1180	9414	2417	-	5004	3.5
CSRN R/L 3232 P19-CD	3519	1182	9414	2417	-	5004	3.5
CSRN R/L 4040 P19-CD	3519	1182	9414	2417	-	5004	3.5
CSRN R/L 2525 M12-4CX	ISSN 454	1160	-	-	2415	5004	3.5
CSRN R/L 2525 M12-7CX	ISSN 434	1160	-	-	2415	5004	3.5
CSRN R/L 3225 P12-4CX	ISSN 454	1160	-	-	2415	5004	3.5
CSRN R/L 3225 P12-7CX	ISSN 434	1160	-	-	2415	5004	3.5
CSRN R/L 2525 M15-CX	ISSN 534	1180	-	-	2415	5004	3.5
CSRN R/L 3225 P15-CX	ISSN 534	1180	-	-	2415	5004	3.5

SNG.. Square negative inserts. Vierkantige negative Wendeschneidplatten. D05-06

Reference / Bez.	l	s	d
SNG.. 1204..	12,70	4,76	12,70
SNG.. 1207..	12,70	7,94	12,70
SNG.. 1507..	15,87	7,94	15,87

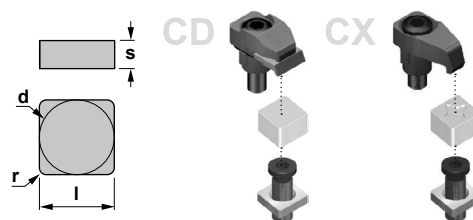



Characteristics:

Toolholder for external turning and chamfering applications equipped with square negative inserts.

For general applications, roughing, semi-finishing and finishing.

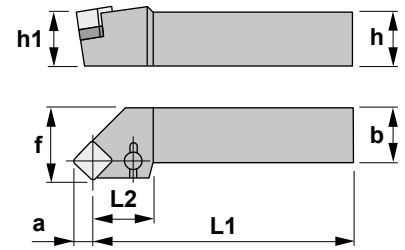

Eigenschaften:

Klemmhalter zum Außendreihen und Abschrägen mit einer vierkantigen negativen Wendeschneidplatte.

Für allgemeine Anwendungen, Schruppen, Vorschlichten und Schlichten geeignet.

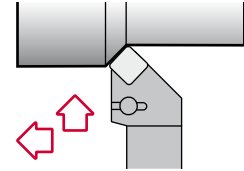

CSSN 45°

Reference Bezeichnung	h=h1	b	L1	L2	f	a	Insert size Wendeschneidplatte	kg
CSSN R/L 2525 M12-4CD	25	25	150	35	32	8,32	SNGN 1204..	0,750
CSSN R/L 2525 M12-7CD	25	25	150	35	32	8,32	SNGN 1207..	0,750
CSSN R/L 3225 P12-4CD	32	25	170	35	32	8,32	SNGN 1204..	1,050
CSSN R/L 3225 P12-7CD	32	25	170	35	32	8,32	SNGN 1207..	1,050
CSSN R/L 2525 M15-CD	25	25	150	37	32	10,23	SNGN 1507..	0,750
CSSN R/L 3225 P15-CD	32	25	170	37	32	10,23	SNGN 1507..	1,050
CSSN R/L 3232 P19-CD	32	32	170	37	40	12,50	SNGN 1907..	1,150
CSSN R/L 4040 P19-CD	40	40	170	37	50	12,50	SNGN 1907..	1,300
CSSN R/L 2525 M12-4CX	25	25	150	35	32	8,32	SNGX 1204..	0,750
CSSN R/L 2525 M12-7CX	25	25	150	35	32	8,32	SNGX 1207..	0,750
CSSN R/L 3225 P12-4CX	32	25	170	35	32	8,32	SNGX 1204..	1,050
CSSN R/L 3225 P12-7CX	32	25	170	35	32	8,32	SNGX 1207..	1,050
CSSN R/L 2525 M15-CX	25	25	150	37	32	10,23	SNGX 1507..	0,750
CSSN R/L 3225 P15-CX	32	25	170	37	32	10,23	SNGX 1507..	1,050

Reference Bezeichnung							Nm
CSSN R/L 2525 M12-4CD	ISSN 454	1160	9414	2417	-	5004	3.5
CSSN R/L 2525 M12-7CD	ISSN 434	1160	9414	2417	-	5004	3.5
CSSN R/L 3225 P12-4CD	ISSN 454	1160	9414	2417	-	5004	3.5
CSSN R/L 3225 P12-7CD	ISSN 434	1160	9414	2417	-	5004	3.5
CSSN R/L 2525 M15-CD	ISSN 534	1180	9414	2417	-	5004	3.5
CSSN R/L 3225 P15-CD	ISSN 534	1180	9414	2417	-	5004	3.5
CSSN R/L 3232 P19-CD	3519	1182	9414	2417	-	5004	3.5
CSSN R/L 4040 P19-CD	3519	1182	9414	2417	-	5004	3.5
CSSN R/L 2525 M12-4CX	ISSN 454	1160	-	-	2415	5004	3.5
CSSN R/L 2525 M12-7CX	ISSN 434	1160	-	-	2415	5004	3.5
CSSN R/L 3225 P12-4CX	ISSN 454	1160	-	-	2415	5004	3.5
CSSN R/L 3225 P12-7CX	ISSN 434	1160	-	-	2415	5004	3.5
CSSN R/L 2525 M15-CX	ISSN 534	1180	-	-	2415	5004	3.5
CSSN R/L 3225 P15-CX	ISSN 534	1180	-	-	2415	5004	3.5

SNG.. Square negative inserts. Vierkantige negative Wendeschneidplatten. D05-06

Reference / Bez.	l	s	d
SNG.. 1204..	12,70	4,76	12,70
SNG.. 1207..	12,70	7,94	12,70
SNG.. 1507..	15,87	7,94	15,87

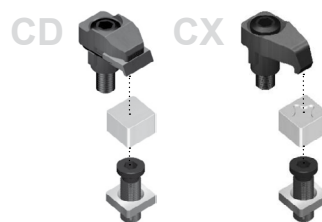
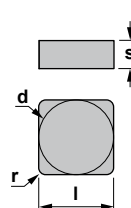

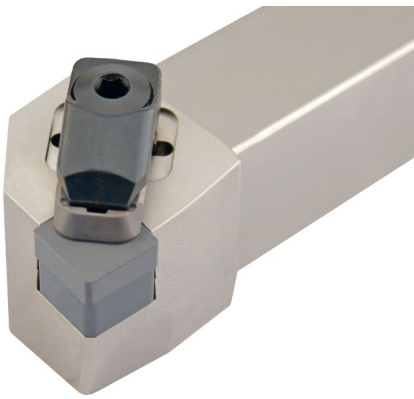

Characteristics:
Toolholder for external turning applications equipped with square negative inserts.
For general applications, roughing, semi-finishing and finishing.

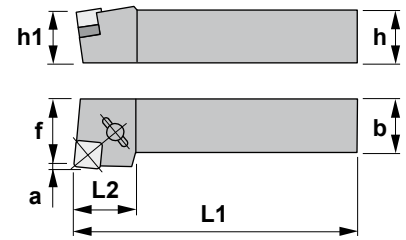

Eigenschaften:
Klemmhalter zum Außendreien mit einer vierkantigen negativen Wendeschneidplatte.
Für allgemeine Anwendungen, Schruppen, Vorschlichten und Schlichten geeignet.

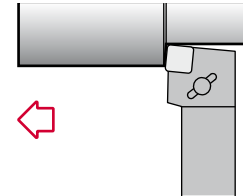

CSXN 85°

Reference Bezeichnung	h=h1	b	L1	L2	f	a	Insert size Wendeschneidplatte	KG
CSXN R/L 2525 M12-4CD	25	25	150	30	32	1,03	SNGN 1204..	0,750
CSXN R/L 2525 M12-7CD	25	25	150	30	32	1,03	SNGN 1207..	0,750
CSXN R/L 3225 P12-4CD	32	25	170	30	32	1,03	SNGN 1204..	1,050
CSXN R/L 3225 P12-7CD	32	25	170	30	32	1,03	SNGN 1207..	1,050
CSXN R/L 2525 M15-CD	25	25	150	33	32	1,38	SNGN 1507..	0,750
CSXN R/L 3225 P15-CD	32	25	170	33	32	1,38	SNGN 1507..	1,050
CSXN R/L 2525 M12-4CX	25	25	150	30	32	1,03	SNGX 1204..	0,750
CSXN R/L 2525 M12-7CX	25	25	150	30	32	1,03	SNGX 1207..	0,750
CSXN R/L 3225 P12-4CX	32	25	170	30	32	1,03	SNGX 1204..	1,050
CSXN R/L 3225 P12-7CX	32	25	170	30	32	1,03	SNGX 1207..	1,050
CSXN R/L 2525 M15-CX	25	25	150	33	32	1,38	SNGX 1507..	0,750
CSXN R/L 3225 P15-CX	32	25	170	33	32	1,38	SNGX 1507..	1,050

Reference Bezeichnung							Nm
CSXN R/L 2525 M12-4CD	ISSN 454	1160	9414	2417	-	5004	3.5
CSXN R/L 2525 M12-7CD	ISSN 434	1160	9414	2417	-	5004	3.5
CSXN R/L 3225 P12-4CD	ISSN 454	1160	9414	2417	-	5004	3.5
CSXN R/L 3225 P12-7CD	ISSN 434	1160	9414	2417	-	5004	3.5
CSXN R/L 2525 M15-CD	ISSN 534	1180	9414	2417	-	5004	3.5
CSXN R/L 3225 P15-CD	ISSN 534	1180	9414	2417	-	5004	3.5
CSXN R/L 2525 M12-4CX	ISSN 454	1160	-	-	2415	5004	3.5
CSXN R/L 2525 M12-7CX	ISSN 434	1160	-	-	2415	5004	3.5
CSXN R/L 3225 P12-4CX	ISSN 454	1160	-	-	2415	5004	3.5
CSXN R/L 3225 P12-7CX	ISSN 434	1160	-	-	2415	5004	3.5
CSXN R/L 2525 M15-CX	ISSN 534	1180	-	-	2415	5004	3.5
CSXN R/L 3225 P15-CX	ISSN 534	1180	-	-	2415	5004	3.5

SNG.. Square negative inserts. Vierkantige negative Wendeschneidplatten. D05-06

Reference / Bez.	l	s	d
SNG.. 1204..	12,70	4,76	12,70
SNG.. 1207..	12,70	7,94	12,70
SNG.. 1507..	15,87	7,94	15,87

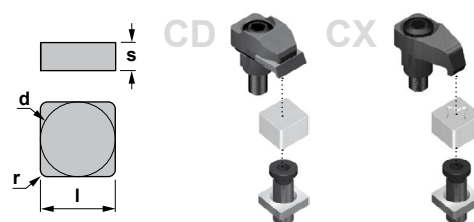

SNGN



SNGX



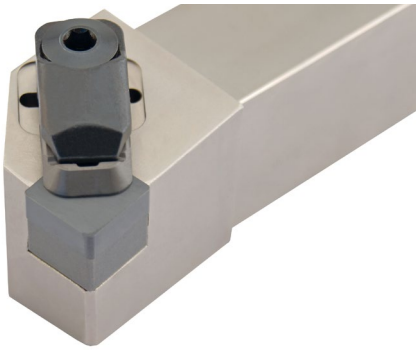

Characteristics:

Toolholder for front turning applications equipped with square negative inserts. For general applications, roughing, semi-finishing and finishing.

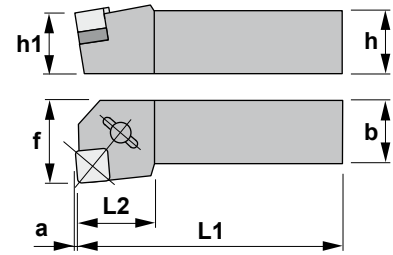

Eigenschaften:

Klemmhalter zum Plandrehen mit einer vierkantigen negativen Wendeschneidplatte. Für allgemeine Anwendungen, Schruppen, Vorschlichten und Schlichten geeignet.

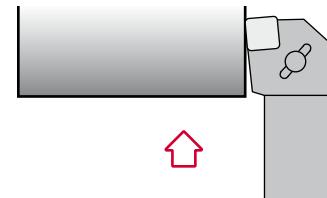

CSYN 85°

Reference Bezeichnung	h=h1	b	L1	L2	f	a	Insert size Wendeschneidplatte	KG
CSYN R/L 2525 M12-4CD	25	25	150	27	32	1,03	SNGN 1204..	0,750
CSYN R/L 2525 M12-7CD	25	25	150	27	32	1,03	SNGN 1207..	0,750
CSYN R/L 3225 P12-4CD	32	25	170	27	32	1,03	SNGN 1204..	1,050
CSYN R/L 3225 P12-7CD	32	25	170	27	32	1,03	SNGN 1207..	1,050
CSYN R/L 2525 M15-CD	25	25	150	27	32	1,38	SNGN 1507..	0,750
CSYN R/L 3225 P15-CD	32	25	170	27	32	1,38	SNGN 1507..	1,050
CSYN R/L 2525 M12-4CX	25	25	150	27	32	1,03	SNGX 1204..	0,750
CSYN R/L 2525 M12-7CX	25	25	150	27	32	1,03	SNGX 1207..	0,750
CSYN R/L 3225 P12-4CX	32	25	170	27	32	1,03	SNGX 1204..	1,050
CSYN R/L 3225 P12-7CX	32	25	170	27	32	1,03	SNGX 1207..	1,050
CSYN R/L 2525 M15-CX	25	25	150	27	32	1,38	SNGX 1507..	0,750
CSYN R/L 3225 P15-CX	32	25	170	27	32	1,38	SNGX 1507..	1,050

Reference Bezeichnung							Nm
CSYN R/L 2525 M12-4CD	ISSN 454	1160	9414	2417	-	5004	3.5
CSYN R/L 2525 M12-7CD	ISSN 434	1160	9414	2417	-	5004	3.5
CSYN R/L 3225 P12-4CD	ISSN 454	1160	9414	2417	-	5004	3.5
CSYN R/L 3225 P12-7CD	ISSN 434	1160	9414	2417	-	5004	3.5
CSYN R/L 2525 M15-CD	ISSN 534	1180	9414	2417	-	5004	3.5
CSYN R/L 3225 P15-CD	ISSN 534	1180	9414	2417	-	5004	3.5
CSYN R/L 2525 M12-4CX	ISSN 454	1160	-	-	2415	5004	3.5
CSYN R/L 2525 M12-7CX	ISSN 434	1160	-	-	2415	5004	3.5
CSYN R/L 3225 P12-4CX	ISSN 454	1160	-	-	2415	5004	3.5
CSYN R/L 3225 P12-7CX	ISSN 434	1160	-	-	2415	5004	3.5
CSYN R/L 2525 M15-CX	ISSN 534	1180	-	-	2415	5004	3.5
CSYN R/L 3225 P15-CX	ISSN 534	1180	-	-	2415	5004	3.5

SNG.. Square negative inserts. Vierkantige negative Wendeschneidplatten. D05-06

Reference / Bez.	l	s	d
SNG.. 1204..	12,70	4,76	12,70
SNG.. 1207..	12,70	7,94	12,70
SNG.. 1507..	15,87	7,94	15,87

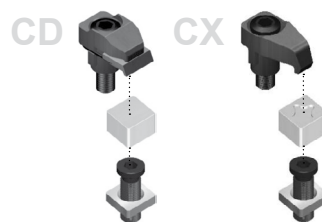
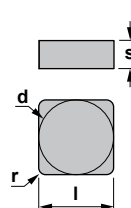

SNGN



SNGX



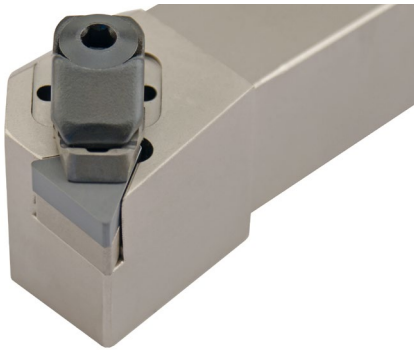

Characteristics:

Toolholder for face turning applications equipped with triangular negative inserts. For general applications, roughing, semi-finishing and finishing.

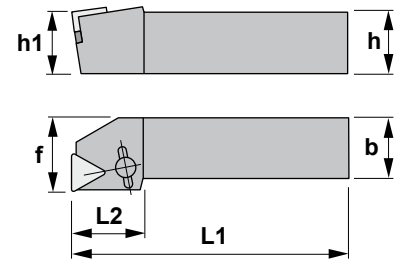

Eigenschaften:

Klemmhalter zum Plandrehen mit einer dreikantigen negativen Wendschneidplatte. Für allgemeine Anwendungen, Schruppen, Vorschlichten und Schlichten geeignet.

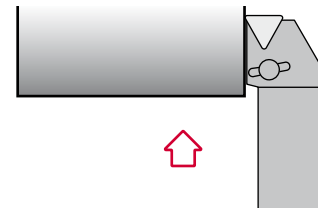

CTFN 90°

Reference Bezeichnung	h=h1	b	L1	L2	f	Insert size Wendschneidplatte	Kg
CTFN R/L 2525 M16-4CD	25	25	150	29	32	TNGN 1604..	0,750
CTFN R/L 2525 M16-7CD	25	25	150	29	32	TNGN 1607..	0,750
CTFN R/L 3225 P16-4CD	32	25	170	29	32	TNGN 1604..	1,050
CTFN R/L 3225 P16-7CD	32	25	170	29	32	TNGN 1607..	1,050

Reference Bezeichnung						Nm
CTFN R/L 2525 M16-4CD	ITSN 342	1150	9416	2413	5004	3.5
CTFN R/L 2525 M16-7CD	ITSN 324	1150	9416	2413	5004	3.5
CTFN R/L 3225 P16-4CD	ITSN 342	1150	9416	2417	5004	3.5
CTFN R/L 3225 P16-7CD	ITSN 324	1150	9416	2417	5004	3.5

TNGN

Triangular negative insert. Dreikantige negative Wendschneidplatte. D06

Reference / Bez.	l	s	d
TNGN 1604..	16,50	4,76	9,52
TNGN 1607..	16,50	7,94	9,52

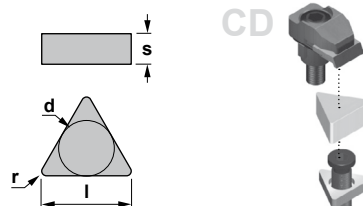

TNGN

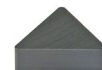

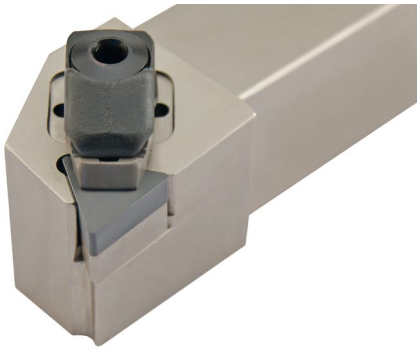

Characteristics:

Toolholder for external turning applications equipped with triangular negative inserts. For general applications, roughing, semi-finishing and finishing.

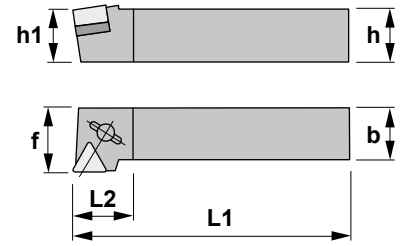

Eigenschaften:

Klemmhalter zum Außendrehen mit einer dreieckigen negativen Wendschneidplatte. Für allgemeine Anwendungen, Schruppen, Vorschlichten und Schlichten geeignet.

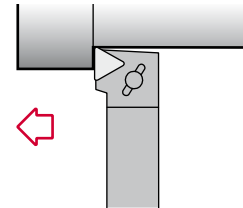

CTGN 90°

Reference Bezeichnung	h=h1	b	L1	L2	f	Insert size Wendschneidplatte	Kg
CTGN R/L 2525 M16-4CD	25	25	150	20	32	TNGN 1604..	0,750
CTGN R/L 2525 M16-7CD	25	25	150	20	32	TNGN 1607..	0,750
CTGN R/L 3225 P16-4CD	32	25	170	20	32	TNGN 1604..	1,050
CTGN R/L 3225 P16-7CD	32	25	170	20	32	TNGN 1607..	1,050

Reference Bezeichnung						Nm
CTGN R/L 2525 M16-4CD	ITSN 342	1150	9416	2413	5004	3.5
CTGN R/L 2525 M16-7CD	ITSN 324	1150	9416	2413	5004	3.5
CTGN R/L 3225 P16-4CD	ITSN 342	1150	9416	2413	5004	3.5
CTGN R/L 3225 P16-7CD	ITSN 324	1150	9416	2413	5004	3.5

TNGN <small>Triangular negative insert. Dreieckige negative Wendschneidplatte. D06</small>						TNGN
Reference / Bez.	l	s	d			
TNGN 1604..	16,50	4,76	9,52			
TNGN 1607..	16,50	7,94	9,52			





Characteristics:

External turning and profiling toolholder equipped with rhombic negative double-sided insert (angle 35°).
For general applications, roughing, semi-finishing and finishing.

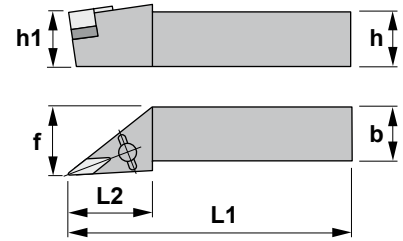

Eigenschaften:

Klemmhalter zum Außen- und Profildrehen mit einer doppelseitigen rhombischen negativen Wendeschneidplatte (35° Winkel).
Für allgemeine Anwendungen, Schruppen, Vorschlichten und Schlichten geeignet.

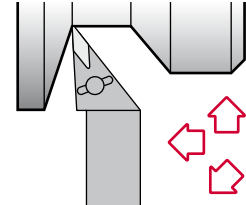

CVJN 93°

Reference Bezeichnung	h=h1	b	L1	L2	f	Insert size Wendeschneidplatte	⚖️ Kg
CVJN R/L 2525 M16-4CD	25	25	150	41	32	VNGN 1604..	0,750
CVJN R/L 2525 M16-7CD	25	25	150	41	32	VNGN 1607..	0,750
CVJN R/L 3225 P16-4CD	32	25	170	41	32	VNGN 1604..	1,050
CVJN R/L 3225 P16-7CD	32	25	170	41	32	VNGN 1607..	1,050
CVJN R/L 2525 M16-4CX	25	25	150	41	32	VNGX 1604..	0,750
CVJN R/L 2525 M16-7CX	25	25	150	41	32	VNGX 1607..	0,750
CVJN R/L 3225 P16-4CX	32	25	170	41	32	VNGX 1604..	1,050
CVJN R/L 3225 P16-7CX	32	25	170	41	32	VNGX 1607..	1,050

Reference Bezeichnung							Nm
CVJN R/L 2525 M16-4CD	IVSN 342	1150	9416	2417	-	5004	3.5
CVJN R/L 2525 M16-7CD	IVSN 322	1150	9416	2417	-	5004	3.5
CVJN R/L 3225 P16-4CD	IVSN 342	1150	9416	2417	-	5004	3.5
CVJN R/L 3225 P16-7CD	IVSN 322	1150	9416	2417	-	5004	3.5
CVJN R/L 2525 M16-4CX	IVSN 342	1150	-	-	2428	5004	3.5
CVJN R/L 2525 M16-7CX	IVSN 322	1150	-	-	2428	5004	3.5
CVJN R/L 3225 P16-4CX	IVSN 342	1150	-	-	2428	5004	3.5
CVJN R/L 3225 P16-7CX	IVSN 322	1150	-	-	2428	5004	3.5

VNG..

35° rhombic negative inserts.
35° rhombische negative Wendeschneidplatten.

Reference / Bez.	l	s	d
VNG.. 1604..	16,50	4,76	9,52
VNG.. 1607..	16,50	7,94	9,52

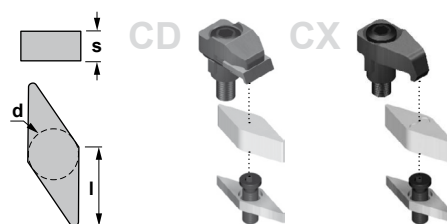

VNGN



VNGX

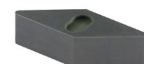

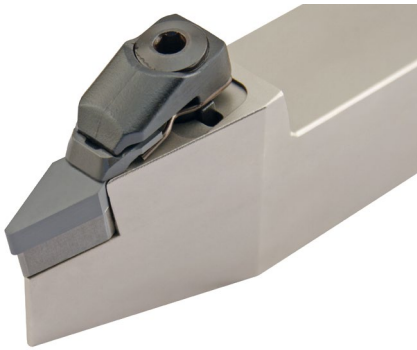

Characteristics:

External turning and profiling toolholder equipped with rhombic negative double-sided insert (angle 35°).

For general applications, roughing, semi-finishing and finishing.

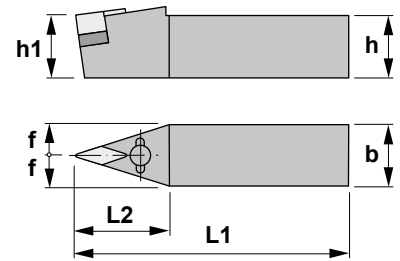

Eigenschaften:

Klemmhalter zum Außen- und Profildrehen mit einer doppelseitigen rhombischen negativen Wendeschneidplatte (35° Winkel).

Für allgemeine Anwendungen, Schruppen, Vorschlichten und Schlichten geeignet.

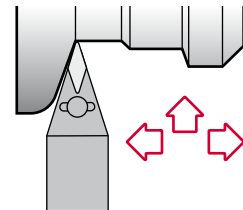

CVVN 62°30'

Reference Bezeichnung	h=h1	b	L1	L2	f	Insert size Wendeschneidplatte	Kg
CVVN N 2525 M16-4CD	25	25	150	45	12,5	VNGN 1604..	0,750
CVVN N 2525 M16-7CD	25	25	150	45	12,5	VNGN 1607..	0,750
CVVN N 3225 P16-4CD	32	25	170	45	12,5	VNGN 1604..	1,050
CVVN N 3225 P16-7CD	32	25	170	45	12,5	VNGN 1607..	1,050
CVVN N 2525 M16-4CX	25	25	150	45	12,5	VNGX 1604..	0,750
CVVN N 2525 M16-7CX	25	25	150	45	12,5	VNGX 1607..	0,750
CVVN N 3225 P16-4CX	32	25	170	45	12,5	VNGX 1604..	1,050
CVVN N 3225 P16-7CX	32	25	170	45	12,5	VNGX 1607..	1,050

Reference Bezeichnung								Nm
CVVN N 2525 M16-4CD	IVSN 342	1150	9416	2417	-	5004	3.5	
CVVN N 2525 M16-7CD	IVSN 322	1150	9416	2417	-	5004	3.5	
CVVN N 3225 P16-4CD	IVSN 342	1150	9416	2417	-	5004	3.5	
CVVN N 3225 P16-7CD	IVSN 322	1150	9416	2417	-	5004	3.5	
CVVN N 2525 M16-4CX	IVSN 342	1150	-	-	2428	5004	3.5	
CVVN N 2525 M16-7CX	IVSN 322	1150	-	-	2428	5004	3.5	
CVVN N 3225 P16-4CX	IVSN 342	1150	-	-	2428	5004	3.5	
CVVN N 3225 P16-7CX	IVSN 322	1150	-	-	2428	5004	3.5	

VNG..

35° rhombic negative inserts.
35° rhombische negative Wendeschneidplatten.

Reference / Bez.	l	s	d
VNG.. 1604..	16,50	4,76	9,52
VNG.. 1607..	16,50	7,94	9,52

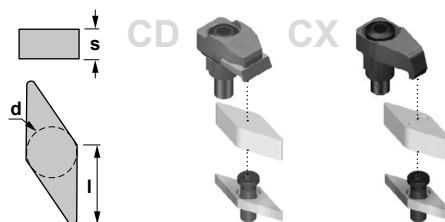

VNGN



VNGX

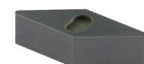



Characteristics:

Multipurpose boring bar equipped with rhombic negative double-sided insert (angle 80°).

For general applications, roughing, semi-finishing and finishing.

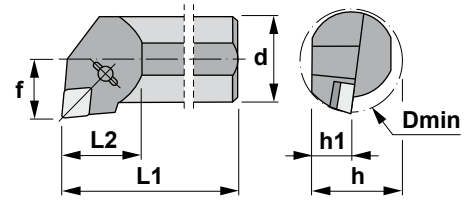

Eigenschaften:

Multifunktions-Bohrstange mit einer doppelseitigen rhombischen negativen Wendeschneidplatte (80° Winkel).

Für allgemeine Anwendungen, Schruppen, Vorschlichten und Schlichten geeignet.

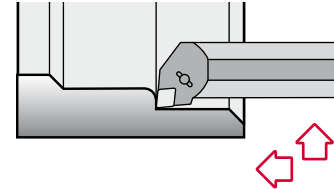

CCLN 95°

Reference Bezeichnung	d	h1	L1	L2	f	h	Dmin	Insert size Wendeschneidplatte	KG
S32S CCLN R/L 12-7CD	32	15,0	250	40	22	30	40	CNGN 1207..	1,450
S40T CCLN R/L 12-4CD	40	18,5	300	35	27	37	70	CNGN 1204..	2,700
S40T CCLN R/L 12-7CD	40	18,5	300	35	27	37	70	CNGN 1207..	2,700
S50U CCLN R/L 12-4CD	50	23,5	350	38	32	47	70	CNGN 1204..	4,950
S50U CCLN R/L 12-7CD	50	23,5	350	38	32	47	70	CNGN 1207..	4,950
S32S CCLN R/L 12-7CX	32	15,0	250	40	22	30	40	CNGX 1207..	1,450
S40T CCLN R/L 12-4CX	40	18,5	300	35	27	37	70	CNGX 1204..	2,700
S40T CCLN R/L 12-7CX	40	18,5	300	35	27	37	70	CNGX 1207..	2,700
S50U CCLN R/L 12-4CX	50	23,5	350	38	32	47	70	CNGX 1204..	4,950
S50U CCLN R/L 12-7CX	50	23,5	350	38	32	47	70	CNGX 1207..	4,950

Reference Bezeichnung							Nm
S32S CCLN R/L 12-7CD	-	-	9414	2417	-	5004	3.5
S40T CCLN R/L 12-4CD	ICSN 454	1161	9414	2417	-	5004	3.5
S40T CCLN R/L 12-7CD	ICSN 434	1161	9414	2417	-	5004	3.5
S50U CCLN R/L 12-4CD	ICSN 454	1160	9414	2417	-	5004	3.5
S50U CCLN R/L 12-7CD	ICSN 434	1160	9414	2417	-	5004	3.5
S32S CCLN R/L 12-7CX	-	-	-	-	2415	5004	3.5
S40T CCLN R/L 12-4CX	ICSN 454	1161	-	-	2415	5004	3.5
S40T CCLN R/L 12-7CX	ICSN 434	1161	-	-	2415	5004	3.5
S50U CCLN R/L 12-4CX	ICSN 454	1160	-	-	2415	5004	3.5
S50U CCLN R/L 12-7CX	ICSN 434	1160	-	-	2415	5004	3.5

CNG.. 80° rhombic negative inserts. 80° rhombische negative Wendeschneidplatten. D03

Reference / Bez.	l	s	d
CNG.. 1204..	12,90	4,76	12,70
CNG.. 1207..	12,90	7,94	12,70

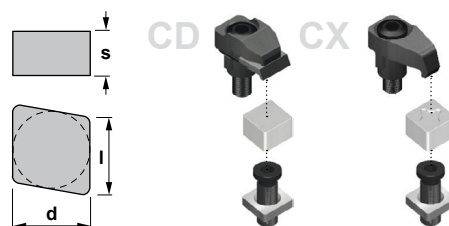



Characteristics:

Profiling boring bar equipped with rhombic negative double-sided insert (angle 55°).

For general applications, roughing, semi-finishing and finishing.

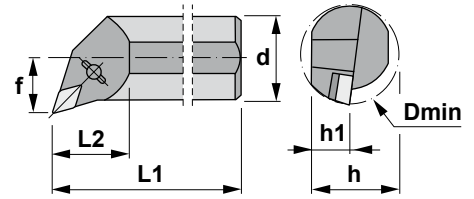

Eigenschaften:

Bohrstange zum Profildrehen mit einer doppelseitigen rhombischen negativen Wendeschneidplatte (55° Winkel).

Für allgemeine Anwendungen, Schruppen, Vorschlichten und Schlichten geeignet.

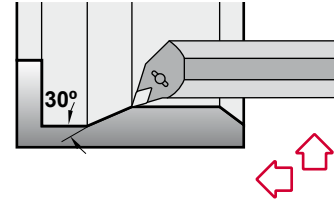

CDQN 107°30'

Reference Bezeichnung	d	h1	L1	L2	f	h	Dmin	Insert size Wendeschneidplatte	KG
S32S CDQN R/L 12-7CD	32	15,0	250	40	22	30	50	DNGN 1207..	1,450
S40T CDQN R/L 12-4CD	40	18,5	300	35	27	37	70	DNGN 1204..	2,700
S40T CDQN R/L 12-7CD	40	18,5	300	35	27	37	70	DNGN 1207..	2,700
S50U CDQN R/L 15-CD	50	23,5	350	38	32	47	70	DNGN 1507..	4,950
S32S CDQN R/L 12-7CX	32	15,0	250	40	22	30	50	DNGX 1207..	1,450
S40T CDQN R/L 12-4CX	40	18,5	300	35	27	37	70	DNGX 1204..	2,700
S40T CDQN R/L 12-7CX	40	18,5	300	35	27	37	70	DNGX 1207..	2,700
S50U CDQN R/L 15-CX	50	23,5	350	38	32	47	70	DNGX 1507..	4,950

Reference Bezeichnung							Nm
S32S CDQN R/L 12-7CD	-	-	9414	2413	-	5004	3.5
S40T CDQN R/L 12-4CD	IDSN 354	1151	9414	2413	-	5004	3.5
S40T CDQN R/L 12-7CD	IDSN 334	1151	9414	2413	-	5004	3.5
S50U CDQN R/L 15-CD	IDSN 432	1160	9414	2417	-	5004	3.5
S32S CDQN R/L 12-7CX	-	-	-	-	2415	5004	3.5
S40T CDQN R/L 12-4CX	IDSN 354	1151	-	-	2415	5004	3.5
S40T CDQN R/L 12-7CX	IDSN 334	1151	-	-	2415	5004	3.5
S50U CDQN R/L 15-CX	IDSN 432	1160	-	-	2432	5004	3.5

DNG.. 55° rhombische negative inserts. **D03-04**

Reference / Bez.	l	s	d
DNG.. 1204..	12,20	4,76	10,00
DNG.. 1207..	12,20	7,94	10,00
DNG.. 1507..	15,50	7,94	12,70

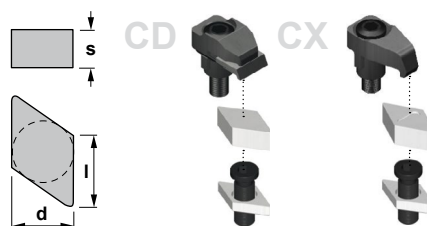



Characteristics:
Profiling boring bar equipped with rhombic negative double-sided insert (angle 55°).
For general applications, roughing, semi-finishing and finishing.

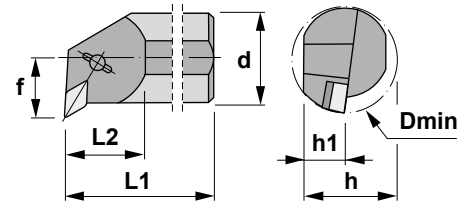

Eigenschaften:
Bohrstange zum Profildrehen mit einer doppelseitigen rhombischen negativen Wendschneidplatte (55° Winkel).
Für allgemeine Anwendungen, Schruppen, Vorschlichten und Schlichten geeignet.

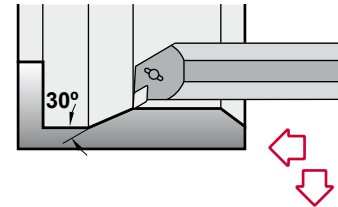

CDUN 93°

Reference Bezeichnung	d	h1	L1	L2	f	h	Dmin	Insert size Wendschneidplatte	
S32S CDUN R/L 12-7CD	32	15,0	250	40	22	30	40	DNGN 1207..	1,450
S40T CDUN R/L 12-4CD	40	18,5	300	50	27	37	70	DNGN 1204..	2,700
S40T CDUN R/L 12-7CD	40	18,5	300	50	27	37	70	DNGN 1207..	2,700
S50U CDUN R/L 15-CD	50	23,5	350	50	32	47	70	DNGN 1507..	4,950
S32S CDUN R/L 12-7CX	32	15,0	250	40	22	30	40	DNGX 1207..	1,450
S40T CDUN R/L 12-4CX	40	18,5	300	50	27	37	70	DNGX 1204..	2,700
S40T CDUN R/L 12-7CX	40	18,5	300	50	27	37	70	DNGX 1207..	2,700
S50U CDUN R/L 15-CX	50	23,5	350	50	32	47	70	DNGX 1507..	4,950

Reference Bezeichnung							Nm
S32S CDUN R/L 12-7CD	-	-	9416	2413	-	5004	3.5
S40T CDUN R/L 12-4CD	IDSN 354	1151	9416	2413	-	5004	3.5
S40T CDUN R/L 12-7CD	IDSN 334	1151	9416	2413	-	5004	3.5
S50U CDUN R/L 15-CD	IDSN 432	1160	9416	2417	-	5004	3.5
S32S CDUN R/L 12-7CX	-	-	-	-	2415	5004	3.5
S40T CDUN R/L 12-4CX	IDSN 354	1151	-	-	2415	5004	3.5
S40T CDUN R/L 12-7CX	IDSN 334	1151	-	-	2415	5004	3.5
S50U CDUN R/L 15-CX	IDSN 432	1160	-	-	2432	5004	3.5

DNG.. 55° rhombic negative inserts. D03-04
55° rhombische negative Wendschneidplatten.

Reference / Bez.	l	s	d
DNG.. 1204..	12,20	4,76	10,00
DNG.. 1207..	12,20	7,94	10,00
DNG.. 1507..	15,50	7,94	12,70

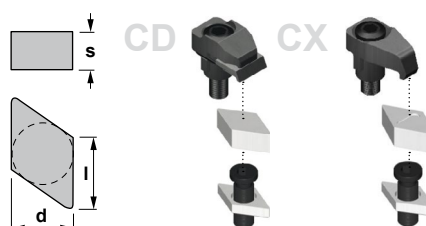

DNGN

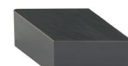

DNGX

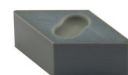



Characteristics:

Boring bar for internal turning applications equipped with square negative inserts.

For general applications, roughing, semi-finishing and finishing.

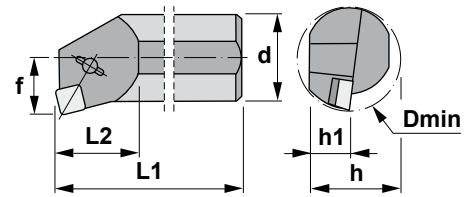

Eigenschaften:

Bohrstange zum Innendrehen mit einer vierkantigen negativen Wendeschneidplatte.

Für allgemeine Anwendungen, Schruppen, Vorschlichten und Schlichten geeignet.

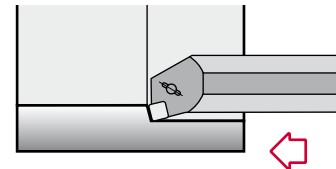

CSKN 75°

Reference Bezeichnung	d	h1	L1	L2	f	h	Dmin	Insert size Wendeschneidplatte	Kg
S32S CSKN R/L 12-7CD	32	15,0	250	40	22	30	40	SNGN 1207..	1,450
S40T CSKN R/L 12-4CD	40	18,5	300	67	27	37	70	SNGN 1204..	2,700
S40T CSKN R/L 12-7CD	40	18,5	300	67	27	37	70	SNGN 1207..	2,700
S50U CSKN R/L 12-4CD	50	23,5	350	67	35	47	70	SNGN 1204..	4,950
S50U CSKN R/L 12-7CD	50	23,5	350	67	35	47	70	SNGN 1207..	4,950
S32S CSKN R/L 12-7CX	32	15,0	250	40	22	30	40	SNGX 1207..	1,450
S40T CSKN R/L 12-4CX	40	18,5	300	67	27	37	70	SNGX 1204..	2,700
S40T CSKN R/L 12-7CX	40	18,5	300	67	27	37	70	SNGX 1207..	2,700
S50U CSKN R/L 12-4CX	50	23,5	350	67	35	47	70	SNGX 1204..	4,950
S50U CSKN R/L 12-7CX	50	23,5	350	67	35	47	70	SNGX 1207..	4,950

Reference Bezeichnung							Nm
S32S CSKN R/L 12-7CD	-	-	9414	2417	-	5004	3.5
S40T CSKN R/L 12-4CD	ISSN 454	1161	9414	2417	-	5004	3.5
S40T CSKN R/L 12-7CD	ISSN 434	1161	9414	2417	-	5004	3.5
S50U CSKN R/L 12-4CD	ISSN 454	1160	9414	2417	-	5004	3.5
S50U CSKN R/L 12-7CD	ISSN 434	1160	9414	2417	-	5004	3.5
S32S CSKN R/L 12-7CX	-	-	-	-	2415	5004	3.5
S40T CSKN R/L 12-4CX	ISSN 454	1161	-	-	2415	5004	3.5
S40T CSKN R/L 12-7CX	ISSN 434	1161	-	-	2415	5004	3.5
S50U CSKN R/L 12-4CX	ISSN 454	1160	-	-	2415	5004	3.5
S50U CSKN R/L 12-7CX	ISSN 434	1160	-	-	2415	5004	3.5

SNG..

Square negative inserts.
Vierkantige negative WSP. D05-06

Reference / Bez.	l	s	d
SNG.. 1204..	12,70	4,76	12,70
SNG.. 1207..	12,70	7,94	12,70

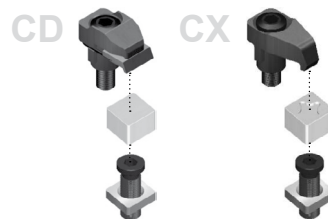
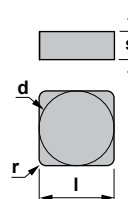

SNGN



SNGX



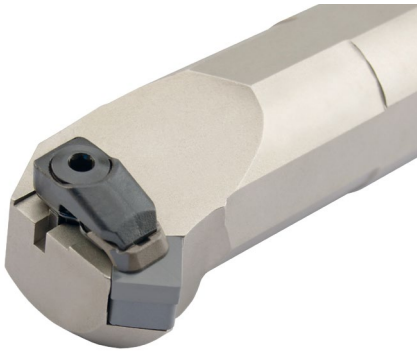

Characteristics:

Boring bar for internal turning and chamfering applications equipped with square negative inserts.

For general applications, roughing, semi-finishing and finishing.

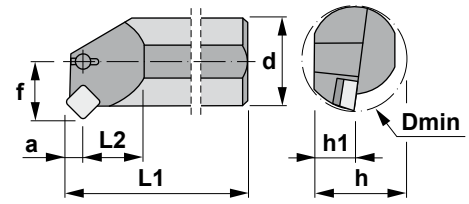

Eigenschaften:

Bohrstange zum Innendrehen und Abschrägen mit einer vierkantigen negativen Wendeschneidplatte.

Für allgemeine Anwendungen, Schruppen, Vorschlichten und Schlichten geeignet.

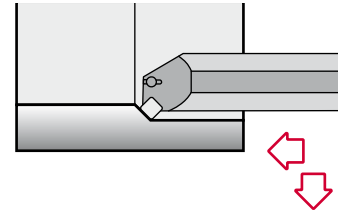

CSSN 45°

Reference Bezeichnung	d	h1	L1	L2	f	h	Dmin	Insert size Wendeschneidplatte	Kg
S32S CSSN R/L 12-7CD	32	15,0	250	40	22	30	40	SNGN 1207..	1,450
S40T CSSN R/L 12-4CD	40	18,5	300	50	27	37	70	SNGN 1204..	2,700
S40T CSSN R/L 12-7CD	40	18,5	300	50	27	37	70	SNGN 1207..	2,700
S50U CSSN R/L 15-CD	50	23,5	350	50	32	47	70	SNGN 1507..	4,950
S32S CSSN R/L 12-7CX	32	15,0	250	40	22	30	40	SNGX 1207..	1,450
S40T CSSN R/L 12-4CX	40	18,5	300	50	27	37	70	SNGX 1204..	2,700
S40T CSSN R/L 12-7CX	40	18,5	300	50	27	37	70	SNGX 1207..	2,700
S50U CSSN R/L 15-CX	50	23,5	350	50	32	47	70	SNGX 1507..	4,950

Reference Bezeichnung							Nm
S32S CSSN R/L 12-7CD	-	-	9414	2417	-	5004	3.5
S40T CSSN R/L 12-4CD	ISSN 454	1161	9414	2417	-	5004	3.5
S40T CSSN R/L 12-7CD	ISSN 434	1161	9414	2417	-	5004	3.5
S50U CSSN R/L 15-CD	ISSN 534	1180	9414	2417	-	5004	3.5
S32S CSSN R/L 12-7CX	-	-	-	-	2415	5004	3.5
S40T CSSN R/L 12-4CX	ISSN 454	1161	-	-	2415	5004	3.5
S40T CSSN R/L 12-7CX	ISSN 434	1161	-	-	2415	5004	3.5
S50U CSSN R/L 15-CX	ISSN 534	1180	-	-	2415	5004	3.5

SNG..

Square negative inserts.
Vierkantige negative WSP. D05-06

Reference / Bez.	l	s	d
SNG.. 1204..	12,70	4,76	12,70
SNG.. 1207..	12,70	7,94	12,70
SNG.. 1507..	15,87	7,94	15,87

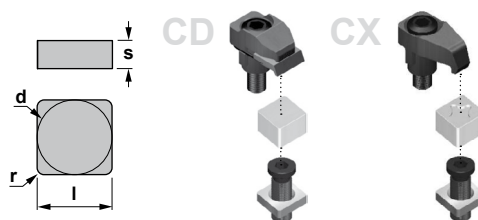

SNGN



SNGX



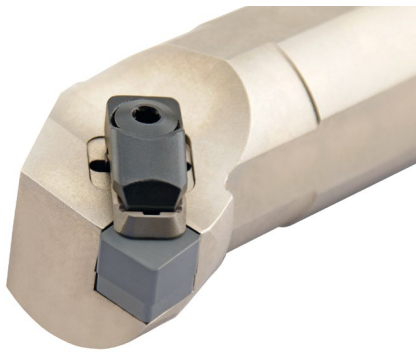

Characteristics:

Boring bar for internal turning applications equipped with square negative inserts.

For general applications, roughing, semi-finishing and finishing.

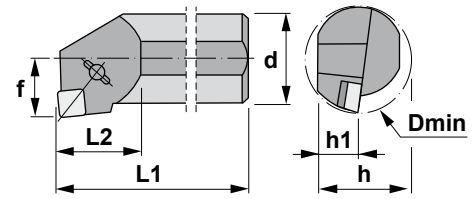

Eigenschaften:

Bohrstange zum Innendrehen mit einer vierkantigen negativen Wendeschneidplatte mit verstärkten Schnittkanten.

Für allgemeine Anwendungen, Schruppen, Vorschlichten und Schlichten geeignet.

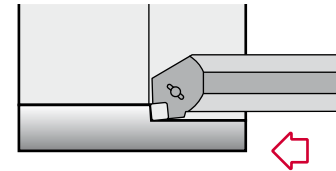

CSYN 85°

Reference Bezeichnung	d	h1	L1	L2	f	h	Dmin	Insert size Wendeschneidplatte	KG
S32S CSYN R/L 12-7CD	32	15,0	250	40	22	30	40	SNGN 1207..	1,450
S40T CSYN R/L 12-4CD	40	18,5	300	67	27	37	70	SNGN 1204..	2,700
S40T CSYN R/L 12-7CD	40	18,5	300	67	27	37	70	SNGN 1207..	2,700
S50U CSYN R/L 12-4CD	50	23,5	350	67	35	47	70	SNGN 1204..	4,950
S50U CSYN R/L 12-7CD	50	23,5	350	67	35	47	70	SNGN 1207..	4,950
S32S CSYN R/L 12-7CX	32	15,0	250	40	22	30	40	SNGX 1207..	1,450
S40T CSYN R/L 12-4CX	40	18,5	300	67	27	37	70	SNGX 1204..	2,700
S40T CSYN R/L 12-7CX	40	18,5	300	67	27	37	70	SNGX 1207..	2,700
S50U CSYN R/L 12-4CX	50	23,5	350	67	35	47	70	SNGX 1204..	4,950
S50U CSYN R/L 12-7CX	50	23,5	350	67	35	47	70	SNGX 1207..	4,950

Reference Bezeichnung							Nm
S32S CSYN R/L 12-7CD	-	-	9414	2417	-	5004	3.5
S40T CSYN R/L 12-4CD	ISSN 454	1161	9414	2417	-	5004	3.5
S40T CSYN R/L 12-7CD	ISSN 434	1161	9414	2417	-	5004	3.5
S50U CSYN R/L 12-4CD	ISSN 454	1160	9414	2417	-	5004	3.5
S50U CSYN R/L 12-7CD	ISSN 434	1160	9414	2417	-	5004	3.5
S32S CSYN R/L 12-7CX	-	-	-	-	2415	5004	3.5
S40T CSYN R/L 12-4CX	ISSN 454	1161	-	-	2415	5004	3.5
S40T CSYN R/L 12-7CX	ISSN 434	1161	-	-	2415	5004	3.5
S50U CSYN R/L 12-4CX	ISSN 454	1160	-	-	2415	5004	3.5
S50U CSYN R/L 12-7CX	ISSN 434	1160	-	-	2415	5004	3.5

SNG..

Square negative inserts.
Vierkantige negative WSP. D05-06

Reference / Bez.	l	s	d
SNG.. 1204..	12,70	4,76	12,70
SNG.. 1207..	12,70	7,94	12,70

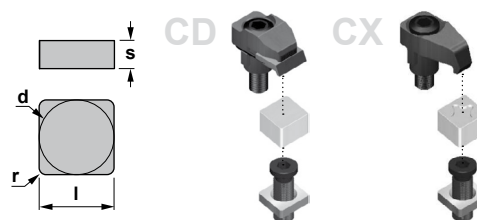

SNGN



SNGX



(C) Top clamp / Obere Klemmung

This classic negative insert clamping system is designed to hold ceramic flat negative inserts, both with additional or sintered chipbreaker. Diese klassische Klemmung für negative Wendeschneidplatten wurde so entwickelt, damit gesinterte und zusätzliche Spannbrecher mit flachen negativen Keramik-Wendeschneidplatten eingesetzt werden können.

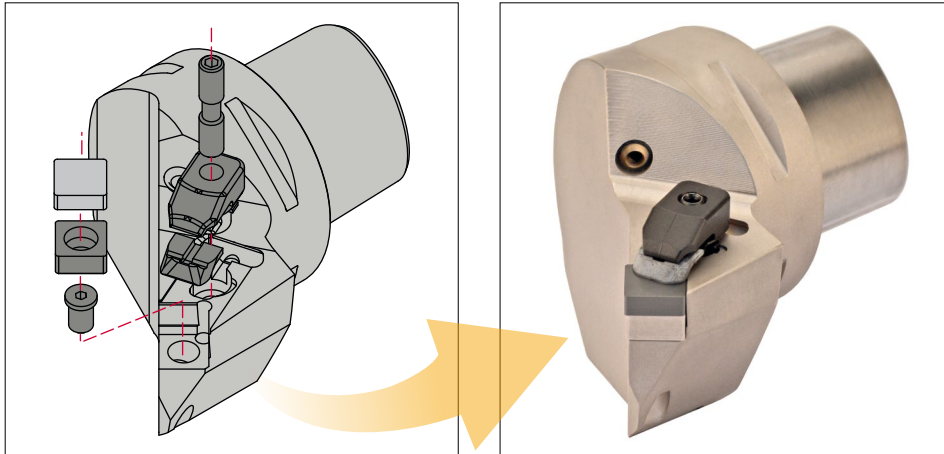

**All clamping systems
in the same body.**

**Alle Klemmsysteme
in dem gleichen Körper.**

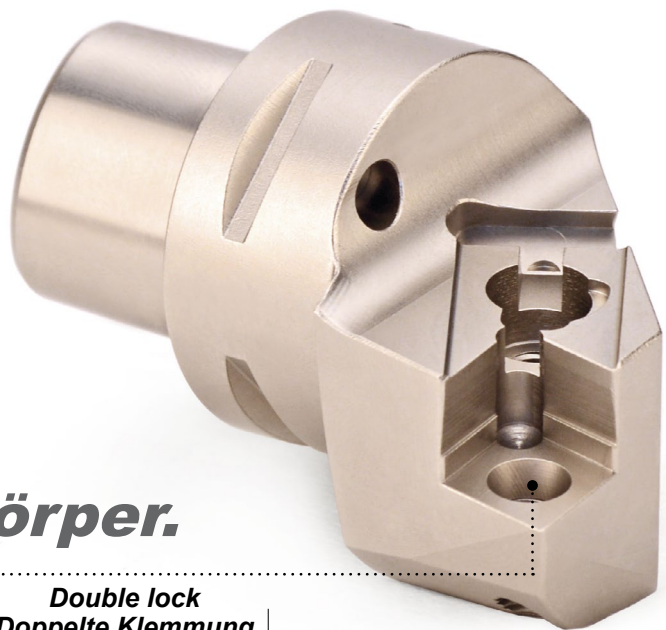

**Top clamp
Obere Klemmung**

C

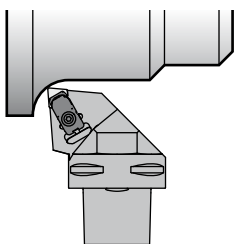

Dimple Lock

D

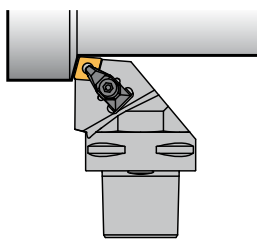

**Double lock
Doppelte Klemmung**

M

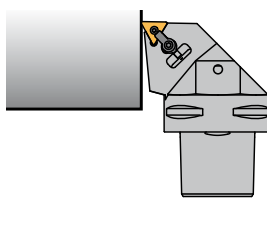



Characteristics:

Toolholder for face turning applications equipped with rhombic negative inserts (angle 80°).
PSC with internal coolant.

- 1) γ = Rake angle (valid with a flat insert).
- 2) λ_s = Angle of inclination.

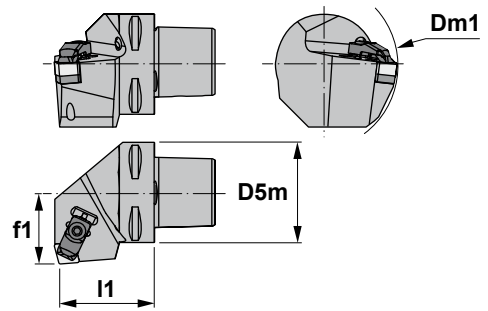

Eigenschaften:

Klemmhalter zum Plandrehen mit einer rhombischen negativen Wendeschneidplatte (80° Winkel). PSC mit Innenkühlung.

- 1) γ = Spanwinkel (Gültig nur mit flachen Wendeschneidplatte).
- 2) λ_s = Neigungswinkel.

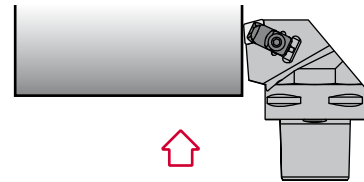

CCKN 75°

Reference Bezeichnung	D5m	Dm1 min.	f1	l1	γ^1	λ_{s2}	Insert size Wendeschneidplatte	kg
PSC40-CCKNR/L27050-12-4	40	110	27	50	-6°	-6°	CNGN 1204..	0,420
PSC40-CCKNR/L27050-12-7	40	110	27	50	-6°	-6°	CNGN 1207..	0,420
PSC50-CCKNR/L35060-12-4	50	110	35	60	-6°	-6°	CNGN 1204..	0,800
PSC50-CCKNR/L35060-12-7	50	110	35	60	-6°	-6°	CNGN 1207..	0,800
PSC63-CCKNR/L45065-12-4	63	110	45	65	-6°	-6°	CNGN 1204..	1,100
PSC63-CCKNR/L45065-12-7	63	110	45	65	-6°	-6°	CNGN 1207..	1,100
PSC40-CCKNR/L27050-16	40	125	27	50	-6°	-6°	CNGN 1607..	0,420
PSC50-CCKNR/L35060-16	50	125	35	60	-6°	-6°	CNGN 1607..	0,800
PSC63-CCKNR/L45065-16	63	125	45	65	-6°	-6°	CNGN 1607..	1,100
PSC63-CCKNR/L45065-19	63	125	45	65	-6°	-6°	CNGN 1907..	1,100
PSC80-CCKNR/L55080-19	80	125	55	80	-6°	-6°	CNGN 1907..	2,740

Reference Bezeichnung							Nm
PSC40-CCKNR/L27050-12-4	1766	ICSN-442	9414	2713	1086	5003	3.0
PSC40-CCKNR/L27050-12-7	1766	ICSN-422	9414	2713	1086	5003	3.0
PSC50-CCKNR/L35060-12-4	1766	ICSN-442	9414	2713	1086	5003	3.0
PSC50-CCKNR/L35060-12-7	1766	ICSN-422	9414	2713	1086	5003	3.0
PSC63-CCKNR/L45065-12-4	1766	ICSN-442	9414	2713	1086	5003	3.0
PSC63-CCKNR/L45065-12-7	1766	ICSN-422	9414	2713	1086	5003	3.0
PSC40-CCKNR/L27050-16	1768	ICSN-523	9414	2713	1086	5003	3.0
PSC50-CCKNR/L35060-16	1768	ICSN-523	9414	2713	1086	5003	3.0
PSC63-CCKNR/L45065-16	1768	ICSN-523	9414	2713	1086	5003	3.0
PSC63-CCKNR/L45065-19	1770	ICSN-623	9414	2713	1086	5003	3.0
PSC80-CCKNR/L55080-19	1770	ICSN-623	9414	2713	1086	5003	3.0

CNGN

80° rhombic negative insert. D03
80° rhombische negative Wendeschneidplatte.

Reference / Bez.	l	s	d
CNGN 1204..	12,90	4,76	12,70
CNGN 1207..	12,90	7,94	12,70
CNGN 1607..	16,10	7,94	15,88
CNGN 1907..	19,30	7,94	19,05

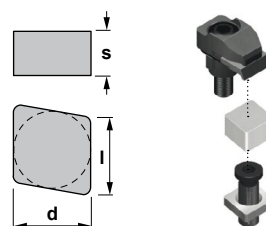

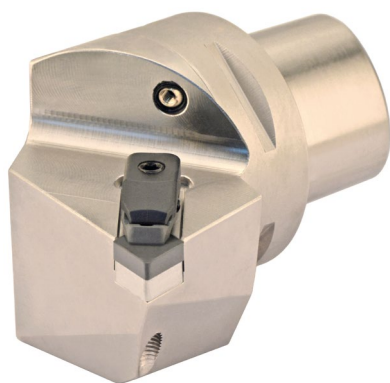
**Characteristics:**

Multipurpose toolholder equipped with rhombic negative double-sided insert (angle 80°).
PSC with internal coolant.

- 1) γ = Rake angle
(valid with a flat insert).
2) λ_s = Angle of inclination.

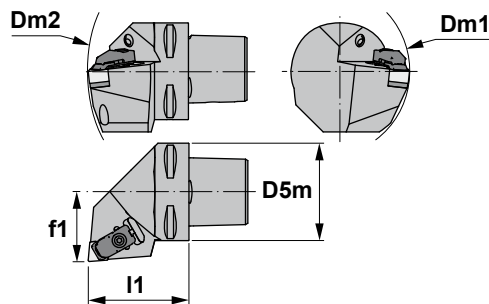

**Eigenschaften:**

Multifunktions-Klemmhalter mit einer doppelseitigen rhombischen negativen Wendeschneidplatte (80° Winkel).
PSC mit Innenkühlung.

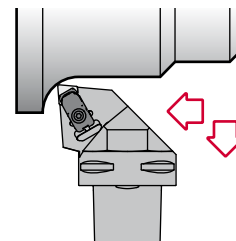
- 1) γ = Spanwinkel (Gültig nur mit flachen Wendeschneidplatte).
2) λ_s = Neigungswinkel.

**CCLN 95°**

Reference Bezeichnung	D5m	Dm1 min.	Dm2 min.	f1	l1	γ^1	λ_{s2}	Insert size Wendeschneidplatte	KG
PSC40-CCLNR/L27050-12-4	40	110	140	27	50	-6°	-6°	CNGN 1204..	0,420
PSC40-CCLNR/L27050-12-7	40	110	140	27	50	-6°	-6°	CNGN 1207..	0,420
PSC50-CCLNR/L35060-12-4	50	110	165	35	60	-6°	-6°	CNGN 1204..	0,800
PSC50-CCLNR/L35060-12-7	50	110	165	35	60	-6°	-6°	CNGN 1207..	0,800
PSC63-CCLNR/L45065-12-4	63	110	190	45	65	-6°	-6°	CNGN 1204..	1,100
PSC63-CCLNR/L45065-12-7	63	110	190	45	65	-6°	-6°	CNGN 1207..	1,100
PSC63-CCLNR/L45065-16	63	125	190	45	65	-6°	-6°	CNGN 1607..	1,100
PSC80-CCLNR/L55080-16	80	125	250	55	80	-6°	-6°	CNGN 1607..	2,740

Reference Bezeichnung							Nm
PSC40-CCLNR/L27050-12-4	1766	ICSN-442	9414	2713	1086	5003	3.0
PSC40-CCLNR/L27050-12-7	1766	ICSN-422	9414	2713	1086	5003	3.0
PSC50-CCLNR/L35060-12-4	1766	ICSN-442	9414	2713	1086	5003	3.0
PSC50-CCLNR/L35060-12-7	1766	ICSN-422	9414	2713	1086	5003	3.0
PSC63-CCLNR/L45065-12-4	1766	ICSN-442	9414	2713	1086	5003	3.0
PSC63-CCLNR/L45065-12-7	1766	ICSN-422	9414	2713	1086	5003	3.0
PSC63-CCLNR/L45065-16	1768	ICSN-523	9414	2713	1086	5003	3.0
PSC80-CCLNR/L55080-16	1768	ICSN-523	9414	2713	1086	5003	3.0

CNGN

80° rhombic negative insert.
80° rhombische negative Wendeschneidplatte.  D03

Reference / Bez.	l	s	d
CNGN 1204..	12,90	4,76	12,70
CNGN 1207..	12,90	7,94	12,70
CNGN 1607..	16,10	7,94	15,88
CNGN 1907..	19,30	7,94	19,05

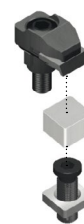
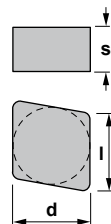
**CNGN**



Characteristics:

Multipurpose toolholder equipped with rhombic negative double-sided insert (angle 80°). PSC with internal coolant.

- 1) γ = Rake angle (valid with a flat insert).
- 2) λ_s = Angle of inclination.

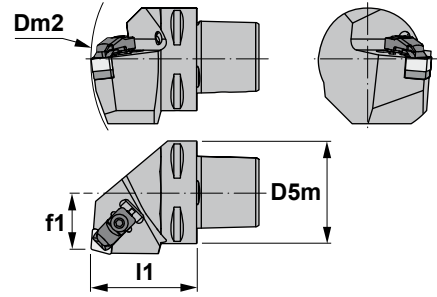

Eigenschaften:

Multifunktions-Klemmhalter mit einer doppelseitigen rhombischen negativen Wendeschneidplatte (80° Winkel). PSC mit Innenkühlung.

- 1) γ = Spanwinkel (Gültig nur mit flachen Wendeschneidplatte).
- 2) λ_s = Neigungswinkel.

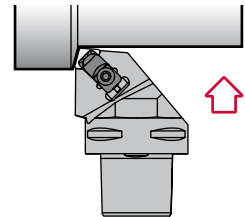

CCRN 75°

Reference Bezeichnung	D5m	Dm2 min.	f1	I1	γ^1	λ_s^2	Insert size Wendeschneidplatte	Kg
PSC40-CCRN/L22050-12-4	40	140	22	50	-6°	-6°	CNGN 1204..	0,420
PSC40-CCRN/L22050-12-7	40	140	22	50	-6°	-6°	CNGN 1207..	0,420
PSC50-CCRN/L27060-12-4	50	165	27	60	-6°	-6°	CNGN 1204..	0,800
PSC50-CCRN/L27060-12-7	50	165	27	60	-6°	-6°	CNGN 1207..	0,800
PSC63-CCRN/L35065-12-4	63	190	35	65	-6°	-6°	CNGN 1204..	1,400
PSC63-CCRN/L35065-12-7	63	190	35	65	-6°	-6°	CNGN 1207..	1,400
PSC50-CCRN/L27060-16	50	165	27	60	-6°	-6°	CNGN 1607..	0,800
PSC63-CCRN/L35065-16	63	190	35	65	-6°	-6°	CNGN 1607..	1,400
PSC80-CCRN/L55080-16	80	250	55	80	-6°	-6°	CNGN 1607..	2,740
PSC50-CCRN/L27060-19	50	165	27	60	-6°	-6°	CNGN 1907..	0,800
PSC63-CCRN/L35065-19	63	190	35	65	-6°	-6°	CNGN 1907..	1,400
PSC80-CCRN/L55080-19	80	250	55	80	-6°	-6°	CNGN 1907..	2,740

Reference Bezeichnung							Nm
PSC40-CCRN/L22050-12-4	1766	ICSN-442	9414	2713	1086	5003	3.0
PSC40-CCRN/L22050-12-7	1766	ICSN-422	9414	2713	1086	5003	3.0
PSC50-CCRN/L27060-12-4	1766	ICSN-442	9414	2713	1086	5003	3.0
PSC50-CCRN/L27060-12-7	1766	ICSN-422	9414	2713	1086	5003	3.0
PSC63-CCRN/L35065-12-4	1766	ICSN-442	9414	2713	1086	5003	3.0
PSC63-CCRN/L35065-12-7	1766	ICSN-422	9414	2713	1086	5003	3.0
PSC50-CCRN/L27060-16	1768	ICSN-523	9414	2713	1086	5003	3.0
PSC63-CCRN/L35065-16	1768	ICSN-523	9414	2713	1086	5003	3.0
PSC80-CCRN/L55080-16	1768	ICSN-523	9414	2713	1086	5003	3.0
PSC50-CCRN/L27060-19	1770	ICSN-623	9414	2713	1086	5003	3.0
PSC63-CCRN/L35065-19	1770	ICSN-623	9414	2713	1086	5003	3.0
PSC80-CCRN/L55080-19	1770	ICSN-623	9414	2713	1086	5003	3.0

CNGN

80° rhombic negative insert.
80° rhombische negative Wendeschneidplatte. D03

Reference / Bez.	l	s	d
CNGN 1204..	12,90	4,76	12,70
CNGN 1207..	12,90	7,94	12,70
CNGN 1607..	16,10	7,94	15,88
CNGN 1907..	19,30	7,94	19,05

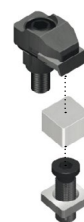
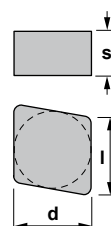

CNGN





Characteristics:

Turning and profiling toolholder equipped with rhombic negative double-sided insert (angle 55°). PSC with internal coolant.

- 1) γ = Rake angle (valid with a flat insert).
- 2) λ_s = Angle of inclination.

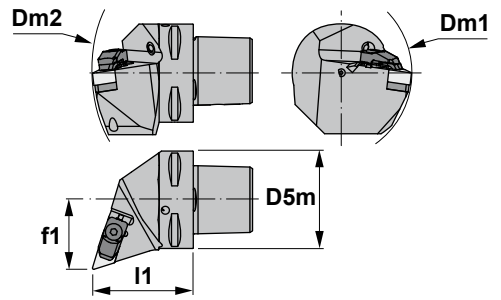

Eigenschaften:

Klemmhalter zum Drehen und Kopierdrehen mit einer doppelseitigen rhombischen negativen Wendeschneidplatten (Winkel 55°). PSC mit Innenkühlung.

- 1) γ = Spanwinkel (Gültig nur mit flachen Wendeschneidplatte).
- 2) λ_s = Neigungswinkel.

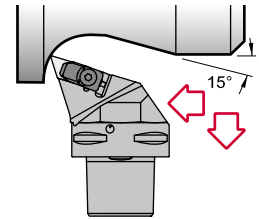

CDHN 107° 30'

Reference Bezeichnung	D5m	Dm1 min.	Dm2 min.	f1	l1	γ 1)	λ_s 2)	Insert size Wendeschneidplatte	kg
PSC40-CDHNR/L27055-15	40	110	145	27	50	-6°	-7°	DNGN 1507..	0,430
PSC50-CDHNR/L35060-15	50	110	165	35	60	-6°	-7°	DNGN 1507..	0,800
PSC63-CDHNR/L45065-15	63	110	190	45	65	-6°	-7°	DNGN 1507..	1,100
PSC80-CDHNR/L55080-15	80	110	250	55	80	-6°	-7°	DNGN 1507..	2,740

Reference Bezeichnung							Nm
PSC40-CDHNR/L27055-15	1766	IDSN-422	9416	2717	1086	5003	3.0
PSC50-CDHNR/L35060-15	1766	IDSN-422	9416	2717	1086	5003	3.0
PSC63-CDHNR/L45065-15	1766	IDSN-422	9416	2717	1086	5003	3.0
PSC80-CDHNR/L55080-15	1766	IDSN-422	9416	2717	1086	5003	3.0

DNGN	55° rhombic negative insert. D03 55° rhombische negative Wendeschneidplatte.			
	Reference / Bez.	l	s	d
DNGN 1507..	15,50	7,94	12,70	

DNGN



Characteristics:

Turning and profiling toolholder equipped with rhombic negative double-sided insert (angle 55°). PSC with internal coolant.

- 1) γ = Rake angle (valid with a flat insert).
- 2) λ_s = Angle of inclination.

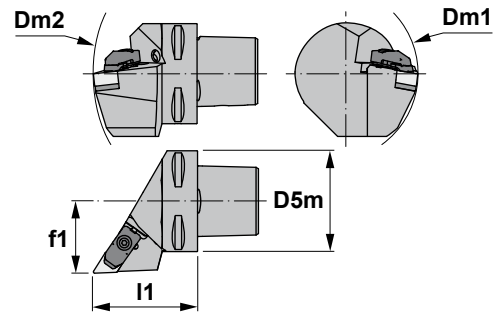

Eigenschaften:

Klemmhalter zum Drehen und Profildrehen mit einer doppelseitigen rhombischen negativen Wendschneidplatte (55° Winkel). PSC mit Innenkühlung.

- 1) γ = Spanwinkel (Gültig nur mit flachen Wendschneidplatte).
- 2) λ_s = Neigungswinkel.

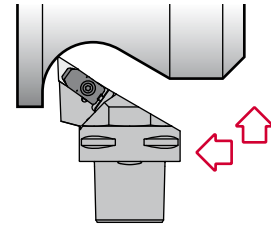

CDJN 93°

Reference Bezeichnung	D5m	Dm1 min.	Dm2 min.	f1	l1	γ^1	λ_s^2	Insert size Wendschneidplatte	Kg
PSC40-CDJNR/L27055-15	40	110	145	27	50	-6°	-7°	DNGN 1507..	0,430
PSC50-CDJNR/L35060-15	50	110	165	35	60	-6°	-7°	DNGN 1507..	0,800
PSC63-CDJNR/L45065-15	63	110	190	45	65	-6°	-7°	DNGN 1507..	1,100
PSC80-CDJNR/L55080-15	80	110	250	55	80	-6°	-7°	DNGN 1507..	2,740

Reference Bezeichnung							Nm
PSC40-CDJNR/L27055-15	1766	IDSN-422	9416	2717	1086	5003	3.0
PSC50-CDJNR/L35060-15	1766	IDSN-422	9416	2717	1086	5003	3.0
PSC63-CDJNR/L45065-15	1766	IDSN-422	9416	2717	1086	5003	3.0
PSC80-CDJNR/L55080-15	1766	IDSN-422	9416	2717	1086	5003	3.0

DNGN

55° rhombic negative insert.
55° rhombische negative Wendschneidplatte. D03

Reference / Bez.	l	s	d
DNGN 1507..	15,50	7,94	12,70

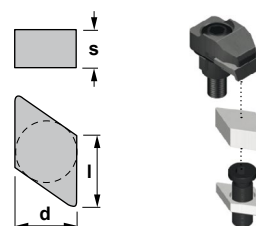

DNGN





Characteristics:

Turning and profiling toolholder equipped with rhombic negative double-sided insert (angle 55°). PSC with internal coolant.

- 1) γ = Rake angle (valid with a flat insert).
- 2) λ_s = Angle of inclination.

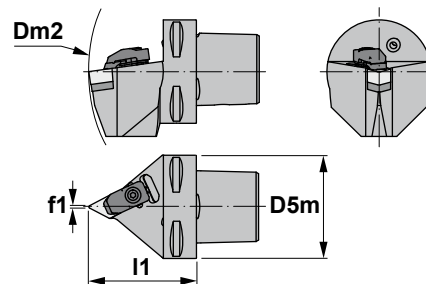

Eigenschaften:

Klemmhalter zum Profildrehen mit einer doppelseitigen rhombischen negativen Wendeschneidplatte (Winkel 55°). PSC mit Innenkühlung.

- 1) γ = Spanwinkel (Gültig nur mit flachen Wendeschneidplatte).
- 2) λ_s = Neigungswinkel.

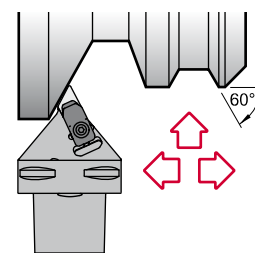

CDNN 63°

Reference Bezeichnung	D5m	Dm2 min.	f1	l1	γ 1)	λ_s 2)	Insert size Wendeschneidplatte	KG
PSC40-CDNNN00055-15	40	145	0.5	50	-5°	-9°	DNGN 1507..	0,370
PSC50-CDNNN00060-15	50	165	0.5	60	-5°	-9°	DNGN 1507..	0,750
PSC63-CDNNN00065-15	63	190	0.5	65	-5°	-9°	DNGN 1507..	1,070
PSC80-CDNNN00080-15	80	250	0.5	80	-5°	-9°	DNGN 1507..	2,320

Reference Bezeichnung							Nm
PSC40-CDNNN00055-15	1766	IDSN-422	9416	2717	1086	5003	3.0
PSC50-CDNNN00060-15	1766	IDSN-422	9416	2717	1086	5003	3.0
PSC63-CDNNN00065-15	1766	IDSN-422	9416	2717	1086	5003	3.0
PSC80-CDNNN00080-15	1766	IDSN-422	9416	2717	1086	5003	3.0

DNGN		55° rhombic negative insert. 55° rhombische negative Wendeschneidplatte. D03		
Reference / Bez.	l	s	d	
DNGN 1507..	15,50	7,94	12,70	

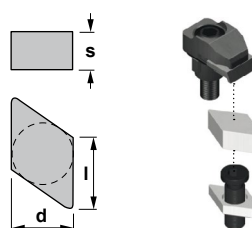

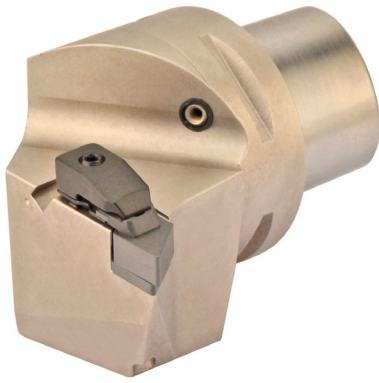

Characteristics:

Turning and profiling toolholder equipped with rhombic negative double-sided insert (angle 55°). PSC with internal coolant.

- 1) γ = Rake angle (valid with a flat insert).
- 2) λ_s = Angle of inclination.

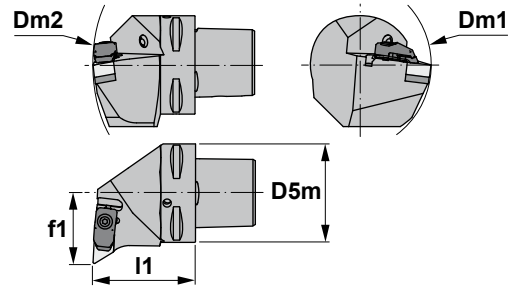

Eigenschaften:

Klemmhalter zum Drehen und Kopierdrehen mit einer doppelseitigen rhombischen negativen Wendeschneidplatte (Winkel 55°). PSC mit Innenkühlung.

- 1) γ = Spanwinkel (Gültig nur mit flachen Wendeschneidplatte).
- 2) λ_s = Neigungswinkel.

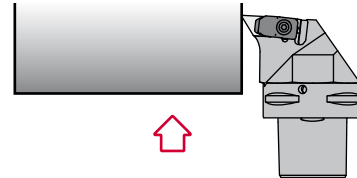

CDUN 93°

Reference Bezeichnung	D5m	Dm1 min.	Dm2 min.	f1	l1	γ^1	λ_s^2	Insert size Wendeschneidplatte	Kg
PSC40-CDUNR/L27050-15	40	110	140	27	50	-6°	-7°	DNGN 1507..	0,420
PSC50-CDUNR/L35060-15	50	110	165	35	60	-6°	-7°	DNGN 1507..	0,800
PSC63-CDUNR/L45065-15	63	110	190	45	65	-6°	-7°	DNGN 1507..	1,100
PSC80-CDUNR/L55080-15	80	110	250	55	80	-6°	-7°	DNGN 1507..	2,740

Reference Bezeichnung							Nm
PSC40-CDUNR/L27050-15	1766	IDSN-422	9416	2717	1086	5003	3.0
PSC50-CDUNR/L35060-15	1766	IDSN-422	9416	2717	1086	5003	3.0
PSC63-CDUNR/L45065-15	1766	IDSN-422	9416	2717	1086	5003	3.0
PSC80-CDUNR/L55080-15	1766	IDSN-422	9416	2717	1086	5003	3.0

DNGN

55° rhombic negative insert.
55° rhombische negative Wendeschneidplatte. D03

Reference / Bez.	l	s	d
DNGN 1507..	15,50	7,94	12,70

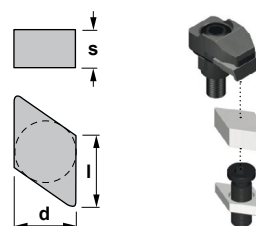

DNGN



**Characteristics:**

Profiling multipurpose turning toolholder equipped with round negative insert.
PSC with internal coolant.

- 1) γ = Rake angle (valid with a flat insert).
- 2) λ_s = Angle of inclination.

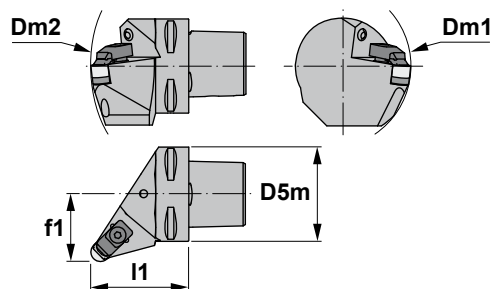
**Eigenschaften:**

Multifunktions-Klemmhalter zum Profildrehen mit einer runden negativen Wendschneidplatte.
PSC mit Innenkühlung.

- 1) γ = Spanwinkel (Gültig nur mit flachen Wendschneidplatte).
- 2) λ_s = Neigungswinkel.

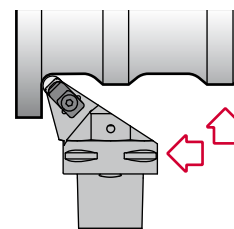

CRSN

Reference Bezeichnung	D5m	Dm1 min.	Dm2 min.	f1	l1	γ^1	λ_s^2	Insert size Wendschneidplatte	
PSC40-CRSNR/L27050-12-4	40	110	140	27	50	-6°	-6°	RNGN 1204..	0,420
PSC40-CRSNR/L27050-12-7	40	110	140	27	50	-6°	-6°	RNGN 1207..	0,420
PSC50-CRSNR/L35060-12-4	50	110	165	35	60	-6°	-6°	RNGN 1204..	0,800
PSC50-CRSNR/L35060-12-7	50	110	165	35	60	-6°	-6°	RNGN 1207..	0,800
PSC63-CRSNR/L45065-12-4	63	110	190	45	65	-6°	-6°	RNGN 1204..	1,100
PSC63-CRSNR/L45065-12-7	63	110	190	45	65	-6°	-6°	RNGN 1207..	1,100

Reference Bezeichnung							Nm
PSC40-CRSNR/L27050-12-4	1766	IRSN 44	9414	2713	1086	5003	3.0
PSC40-CRSNR/L27050-12-7	1766	IRSN 42	9414	2713	1086	5003	3.0
PSC50-CRSNR/L35060-12-4	1766	IRSN 44	9414	2713	1086	5003	3.0
PSC50-CRSNR/L35060-12-7	1766	IRSN 42	9414	2713	1086	5003	3.0
PSC63-CRSNR/L45065-12-4	1766	IRSN 44	9414	2713	1086	5003	3.0
PSC63-CRSNR/L45065-12-7	1766	IRSN 42	9414	2713	1086	5003	3.0

RNGN

Round negative insert.
Runde negative Wendschneidplatte. D04

Reference / Bez.

s

d

RNGN 1204.. 4,76 12,70

RNGN 1207.. 7,94 12,70

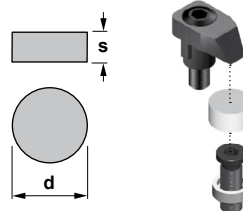
**RNGN**

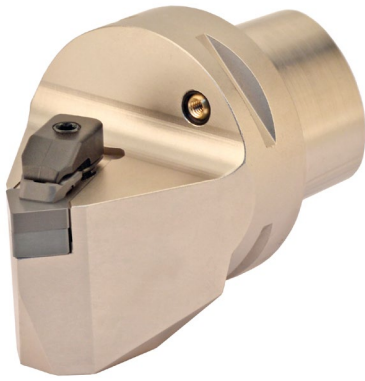

Characteristics:

Toolholder for external turning and chamfering applications equipped with square negative insert.
PSC with internal coolant.

- 1) γ = Rake angle (valid with a flat insert).
- 2) λ_s = Angle of inclination.

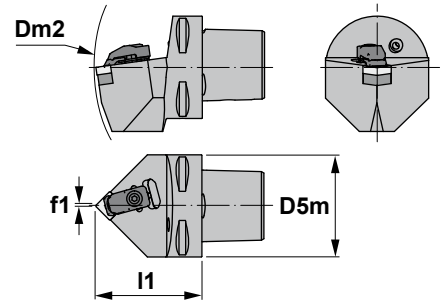

Eigenschaften:

Klemmhalter zum Außendrehen und Abschrägen mit einer vierkantigen negativen Wendeschneidplatte.
PSC mit Innenkühlung.

- 1) γ = Spanwinkel (Gültig nur mit flachen Wendeschneidplatte).
- 2) λ_s = Neigungswinkel.

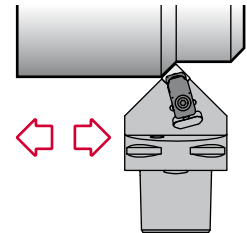

CSDN 45°

Reference Bezeichnung	D5m	Dm2 min.	f1	I1	γ^1	λ_s^2	Insert size Wendeschneidplatte	KG
PSC40-CSDNN00050-12-4	40	140	0.3	50	-6°	-6°	SNGN 1204..	0,350
PSC40-CSDNN00050-12-7	40	140	0.3	50	-6°	-6°	SNGN 1207..	0,350
PSC50-CSDNN00060-12-4	50	165	0.3	60	-6°	-6°	SNGN 1204..	0,750
PSC50-CSDNN00060-12-7	50	165	0.3	60	-6°	-6°	SNGN 1207..	0,750
PSC63-CSDNN00065-12-4	63	190	0.3	65	-6°	-6°	SNGN 1204..	1,070
PSC63-CSDNN00065-12-7	63	190	0.3	65	-6°	-6°	SNGN 1207..	1,070

Reference Bezeichnung							Nm
PSC40-CSDNN00050-12-4	1766	ISSN-442	9414	2713	1086	5003	3.0
PSC40-CSDNN00050-12-7	1766	ISSN-422	9414	2713	1086	5003	3.0
PSC50-CSDNN00060-12-4	1766	ISSN-442	9414	2713	1086	5003	3.0
PSC50-CSDNN00060-12-7	1766	ISSN-422	9414	2713	1086	5003	3.0
PSC63-CSDNN00065-12-4	1766	ISSN-442	9414	2713	1086	5003	3.0
PSC63-CSDNN00065-12-7	1766	ISSN-422	9414	2713	1086	5003	3.0

SNGN

Square negative insert. Vierkantige negative Wendeschneidplatte. D05

Reference / Bez.	l	s	d
SNGN 1204..	12,70	4,76	12,70
SNGN 1207..	12,70	7,94	12,70

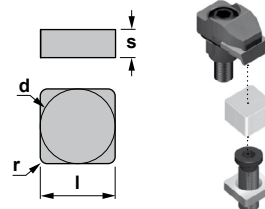

SNGN

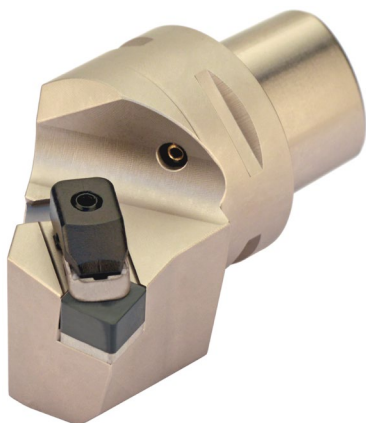

**Characteristics:**

Toolholder for face turning applications equipped with square negative insert and strong cutting edges.

PSC with internal coolant.

- 1) γ = Rake angle (valid with a flat insert).
- 2) λ_s = Angle of inclination.

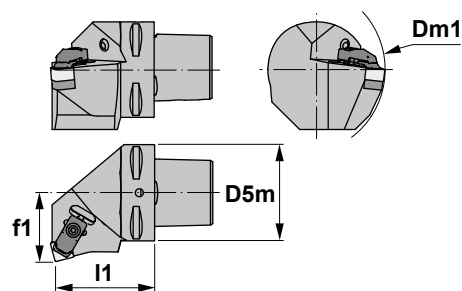
**Eigenschaften:**

Klemmhalter zum Plandrehen mit einer vierkantigen negativen Wendeschneidplatte mit verstärkten Schnittkanten.

PSC mit Innenkühlung.

- 1) γ = Spanwinkel (Gültig nur mit flachen Wendeschneidplatte).
- 2) λ_s = Neigungswinkel.

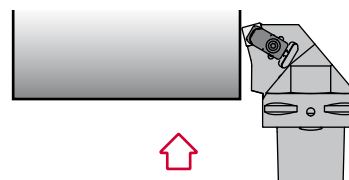

CSKN 75°

Reference Bezeichnung	D5m	Dm1 min.	f1	l1	γ^1	λ_s^2	Insert size Wendeschneidplatte	Kg
PSC40-CSKNR/L27050-12-4	40	110	27	50	-6°	-6°	SNGN 1204..	0,420
PSC40-CSKNR/L27050-12-7	40	110	27	50	-6°	-6°	SNGN 1207..	0,420
PSC50-CSKNR/L35060-12-4	50	110	35	60	-6°	-6°	SNGN 1204..	0,800
PSC50-CSKNR/L35060-12-7	50	110	35	60	-6°	-6°	SNGN 1207..	0,800
PSC63-CSKNR/L45065-12-4	63	110	45	65	-6°	-6°	SNGN 1204..	1,100
PSC63-CSKNR/L45065-12-7	63	110	45	65	-6°	-6°	SNGN 1207..	1,100

Reference Bezeichnung							Nm
PSC40-CSKNR/L27050-12-4	1766	ISSN-442	9414	2713	1086	5003	3.0
PSC40-CSKNR/L27050-12-7	1766	ISSN-422	9414	2713	1086	5003	3.0
PSC50-CSKNR/L35060-12-4	1766	ISSN-442	9414	2713	1086	5003	3.0
PSC50-CSKNR/L35060-12-7	1766	ISSN-422	9414	2713	1086	5003	3.0
PSC63-CSKNR/L45065-12-4	1766	ISSN-442	9414	2713	1086	5003	3.0
PSC63-CSKNR/L45065-12-7	1766	ISSN-422	9414	2713	1086	5003	3.0

SNGN

Square negative insert.
Vierkantige negative Wendeschneidplatte. D05

Reference / Bez.

l

s

d

SNGN 1204..

12,70

4,76

12,70

SNGN 1207..

12,70

7,94

12,70

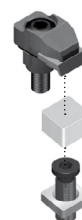
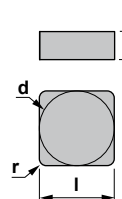
**SNGN**

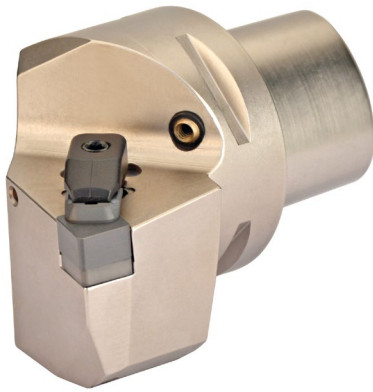

Characteristics:

Toolholder for external turning applications equipped with square negative insert. PSC with internal coolant.

- 1) γ = Rake angle (valid with a flat insert).
- 2) λ_s = Angle of inclination.

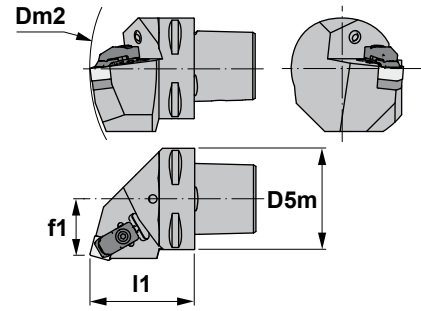

Eigenschaften:

Klemmhalter zum Außendreien mit einer vierkantigen negativen Wendeschneidplatte. PSC mit Innenkühlung.

- 1) γ = Spanwinkel (Gültig nur mit flachen Wendeschneidplatte).
- 2) λ_s = Neigungswinkel.

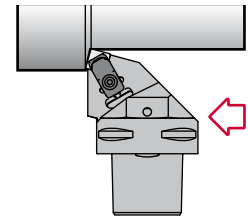

CSRN 75°

Reference Bezeichnung	D5m	Dm2 min.	f1	l1	$\gamma^{1)}$	$\lambda_s^{2)}$	Insert size Wendeschneidplatte	Kg
PSC40-CSRNR/L22050-12-4	40	140	22	50	-6°	-6°	SNGN 1204..	0,420
PSC40-CSRNR/L22050-12-7	40	140	22	50	-6°	-6°	SNGN 1207..	0,420
PSC50-CSRNR/L27060-12-4	50	165	27	60	-6°	-6°	SNGN 1204..	0,800
PSC50-CSRNR/L27060-12-7	50	165	27	60	-6°	-6°	SNGN 1207..	0,800
PSC63-CSRNR/L35065-12-4	63	190	35	65	-6°	-6°	SNGN 1204..	1,400
PSC63-CSRNR/L35065-12-7	63	190	35	65	-6°	-6°	SNGN 1207..	1,400

Reference Bezeichnung							Nm
PSC40-CSRNR/L22050-12-4	1766	ISSN-442	9414	2713	1086	5003	3.0
PSC40-CSRNR/L22050-12-7	1766	ISSN-422	9414	2713	1086	5003	3.0
PSC50-CSRNR/L27060-12-4	1766	ISSN-442	9414	2713	1086	5003	3.0
PSC50-CSRNR/L27060-12-7	1766	ISSN-422	9414	2713	1086	5003	3.0
PSC63-CSRNR/L35065-12-4	1766	ISSN-442	9414	2713	1086	5003	3.0
PSC63-CSRNR/L35065-12-7	1766	ISSN-422	9414	2713	1086	5003	3.0

SNGN

Square negative insert. Vierkantige negative Wendeschneidplatte. D05

Reference / Bez.	l	s	d
SNGN 1204..	12,70	4,76	12,70
SNGN 1207..	12,70	7,94	12,70

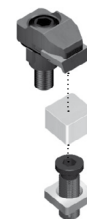
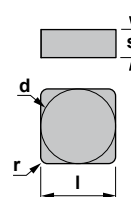

SNGN



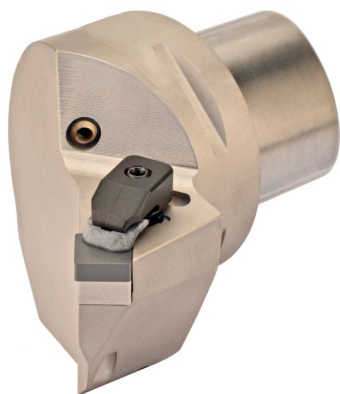

Characteristics:

Toolholder for external turning and chamfering applications equipped with square negative insert. PSC with internal coolant.

- 1) γ = Rake angle (valid with a flat insert).
- 2) λ_s = Angle of inclination.

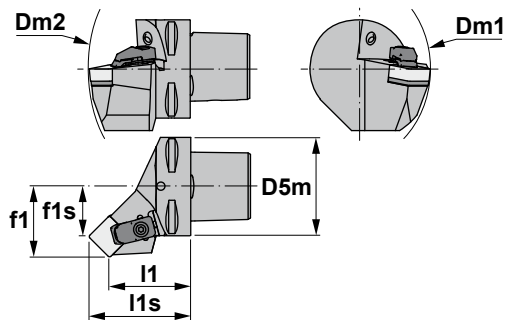

Eigenschaften:

Klemmhalter zum Außendrehen und Abschrägen mit einer vierkantigen negativen Wendeschneidplatte. PSC mit Innenkühlung.

- 1) γ = Spanwinkel (Gültig nur mit flachen Wendeschneidplatte).
- 2) λ_s = Neigungswinkel.

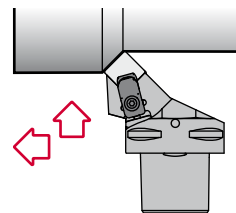

CSSN 45°

Reference Bezeichnung	D5m	Dm1 min.	Dm2 min.	f1	f1s	l1	l1s	γ^1	λ_s^2	Insert size Wendeschneidplatte	Kg
PSC40-CSSNR/L27042-12-4	40	110	140	27	18.7	42	50.3	-8°	-0°	SNGN 1204..	0,350
PSC40-CSSNR/L27042-12-7	40	110	140	27	18.7	42	50.3	-8°	-0°	SNGN 1207..	0,350
PSC50-CSSNR/L35052-12-4	50	110	165	35	26.7	52	60.3	-8°	-0°	SNGN 1204..	0,700
PSC50-CSSNR/L35052-12-7	50	110	165	35	26.7	52	60.3	-8°	-0°	SNGN 1207..	0,700
PSC63-CSSNR/L45056-12-4	63	110	190	45	36.7	56	64.3	-8°	-0°	SNGN 1204..	1,120
PSC63-CSSNR/L45056-12-7	63	110	190	45	36.7	56	64.3	-8°	-0°	SNGN 1207..	1,120

Reference Bezeichnung							Nm
PSC40-CSSNR/L27042-12-4	1766	ISSN-442	9414	2713	1086	5003	3.0
PSC40-CSSNR/L27042-12-7	1766	ISSN-422	9414	2713	1086	5003	3.0
PSC50-CSSNR/L35052-12-4	1766	ISSN-442	9414	2713	1086	5003	3.0
PSC50-CSSNR/L35052-12-7	1766	ISSN-422	9414	2713	1086	5003	3.0
PSC63-CSSNR/L45056-12-4	1766	ISSN-442	9414	2713	1086	5003	3.0
PSC63-CSSNR/L45056-12-7	1766	ISSN-422	9414	2713	1086	5003	3.0

SNGN

Square negative insert.
Vierkantige negative Wendeschneidplatte. D05

Reference / Bez.	l	s	d
SNGN 1204..	12,70	4,76	12,70
SNGN 1207..	12,70	7,94	12,70

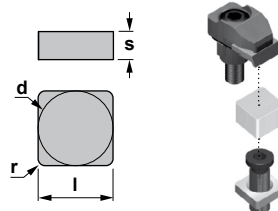

SNGN







PSC

Applications index Anwendungen	E02-05
Dimple lock toolholders Klemmhalter mit Dimple Lock-Klemmung	E06-24
Wedge clamp / Double lock toolholders Klemmhalter mit Pratzen- und Doppel-Klemmung	E25-40
Lever lock toolholders Klemmhalter mit Kniehebel-Klemmung	E41-50
Center screw toolholders Klemmhalter mit Zentralschrauben-Klemmung	E51-65
Antivibratory adaptor Schwingungsgedämpfte Aufnahmen	E66
Dimple lock boring bars Bohrstangen mit Dimple Lock-Klemmung	E67-69
Wedge clamp / Double lock boring bars Bohrstangen mit Pratzen- und Doppel-Klemmung	E70-72
Lever lock boring bars Bohrstangen mit Kniehebel-Klemmung	E73-75
Center screw boring bars Bohrstangen mit Zentralschrauben-Klemmung	E76-82
External and internal threading Außengewindedrehen und Innengewindedrehen	E83-84
Parting and grooving Ab- und Einstechdrehen	E85-91
Drills Bohrer	E92-94
Arbors and adaptors Aufnahmen	E96-125

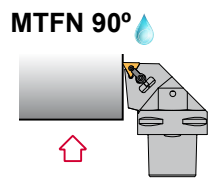
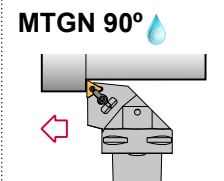
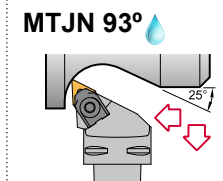
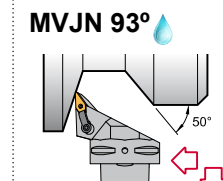
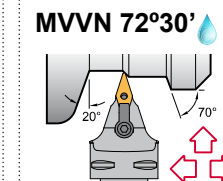
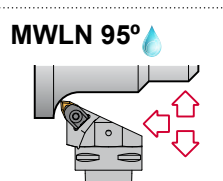

<p>MTFN 90°</p>  <p>Page Seite E35 TNM.. 1604..</p>	<p>MTGN 90°</p>  <p>Page Seite E36 TNM.. 1604.. TNM.. 2204..</p>	<p>MTJN 93°</p>  <p>Page Seite E37 TNM.. 1604.. TNM.. 2204..</p>	<p>MVJN 93°</p>  <p>Page Seite E38 VN.. 1604..</p>	<p>MVVN 72°30'</p>  <p>Page Seite E39 VN.. 1604..</p>
<p>MWLN 95°</p>  <p>Page Seite E40 WNMG 0604.. WNMG 0804..</p>				

**Lever lock toolholders
Klemmhalter mit Kniehebel-Klemmung**

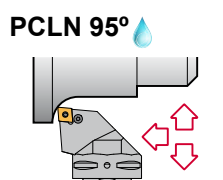
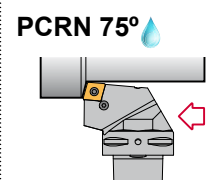
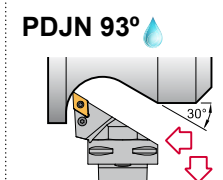
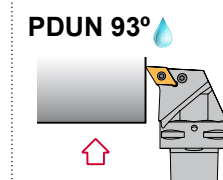
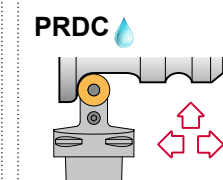
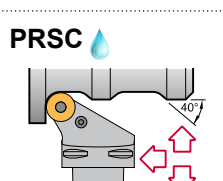
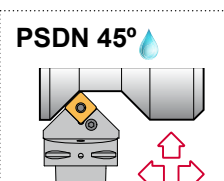
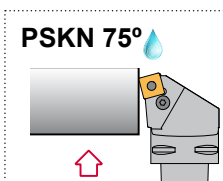
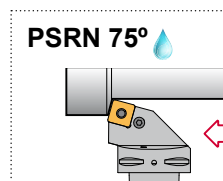
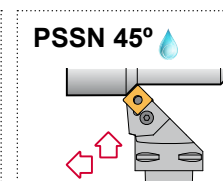
<p>PCLN 95°</p>  <p>Page Seite E41 CN.. 1204.. CN.. 2509..</p>	<p>PCRN 75°</p>  <p>Page Seite E42 CN.. 1204.. CN.. 1606.. CN.. 1906..</p>	<p>PDJN 93°</p>  <p>Page Seite E43 DN.. 1104.. DN.. 1504.. DN.. 1506..</p>	<p>PDUN 93°</p>  <p>Page Seite E44 DN.. 1506..</p>	<p>PRDC</p>  <p>Page Seite E45 RC.. 2507M0 RC.. 3209M0</p>
<p>PRSC</p>  <p>Page Seite E46 RC.. 2006M0 RC.. 2507M0 RC.. 3209M0</p>	<p>PSDN 45°</p>  <p>Page Seite E47 SNM.. 1204.. SNM.. 2507..</p>	<p>PSKN 75°</p>  <p>Page Seite E48 SNM.. 1204.. SNM.. 2507..</p>	<p>PSRN 75°</p>  <p>Page Seite E49 SNM.. 1204.. SNM.. 2507..</p>	<p>PSSN 45°</p>  <p>Page Seite E50 SNM.. 1204.. SNM.. 2507..</p>

POSITIVE TOOLHOLDERS / POSITIVE KLEMMHALTER

**Center screw toolholders
Klemmhalter mit Zentralschrauben-Klemmung**

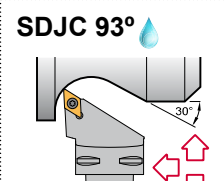
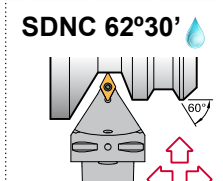
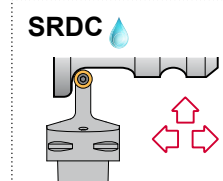
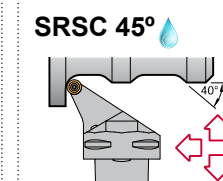
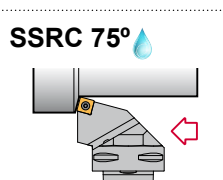
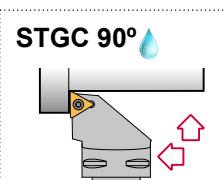
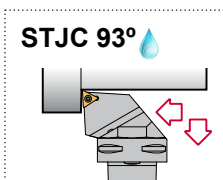
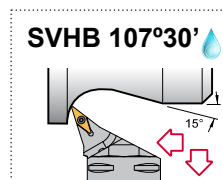
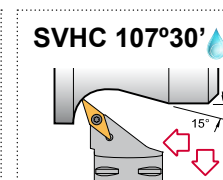
<p>SCLC 95°</p>  <p>Page Seite E51 CC.. 09T3.. CC.. 1204..</p>	<p>SDJC 93°</p>  <p>Page Seite E52 DC.. 0702.. DC.. 11T3..</p>	<p>SDNC 62°30'</p>  <p>Page Seite E53 DC.. 11T3..</p>	<p>SRDC</p>  <p>Page Seite E54 RC.. 0602M0 RC.. 2006M0</p>	<p>SRSC 45°</p>  <p>Page Seite E55 RC.. 0602M0 RC.. 2006M0</p>
<p>SSRC 75°</p>  <p>Page Seite E56 SC.. 1204..</p>	<p>STGC 90°</p>  <p>Page Seite E57 TC.. 1102.. TC.. 16T3..</p>	<p>STJC 93°</p>  <p>Page Seite E58 TC.. 1102.. TC.. 16T3..</p>	<p>SVHB 107°30'</p>  <p>Page Seite E59 VBMT 1604..</p>	<p>SVHC 107°30'</p>  <p>Page Seite E60 VC.. 1103.. VC.. 1604..</p>



POSITIVE TOOLHOLDERS / POSITIVE KLEMMHALTER

SVJB 93°

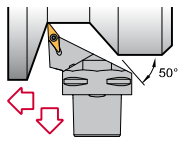

Page
Seite E61 VBMT 1604..

SVJC 93°

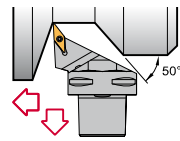

Page
Seite E62 VC.. 1103..
VC.. 1604..

SVMB 50° Multi-Task

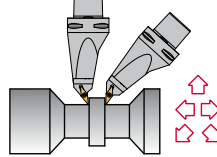

Page
Seite E63 VBMT 1604..

SVVB 72°30'

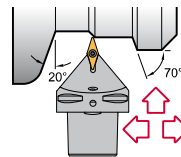

Page
Seite E64 VBMT 1604..

SVVC 72°30'

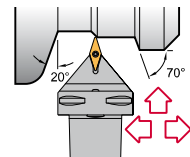

Page
Seite E65 VC.. 1103..
VC.. 1604..

NEGATIVE BORING BARS / NEGATIVE BOHRSTANGEN

Adaptor Adapter

J..



Page
Seite E66

Dimple lock boring bars Bohrstangen mit Dimple Lock-Klemmung

DCLN 95°

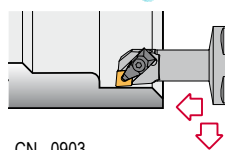

CN.. 0903..
CN.. 1204..
CN.. 1606.. Page
Seite E67

DDUN 93°

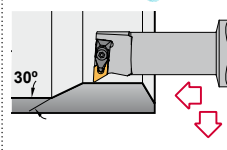

Page
Seite E68 DN.. 1104..
DN.. 1506..

DWLN 95°

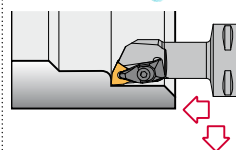

Page
Seite E69 WNMG 0604..
WNMG 0804..

Wedge clamp / Double lock boring bars Bohrstangen mit Prätzen- und Doppel-Klemmung

MTFN 90°

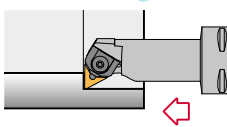

Page
Seite E70 TNM.. 1604..

MVUN 93°

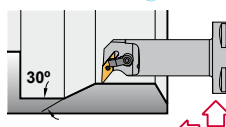

Page
Seite E71 VN.. 1604..

MWLN 95°

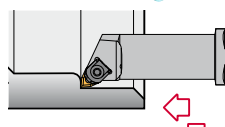

Page
Seite E72 WNMG 0604..
WNMG 0804..

Lever lock boring bars Bohrstangen mit Kniehebel-Klemmung

PCLN 95°

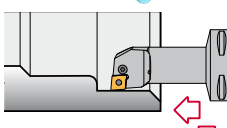

CN.. 0903..
CN.. 1204..
CN.. 1606.. Page
Seite E73

PDUN 93°

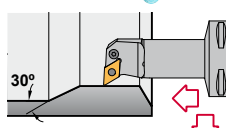

Page
Seite E74 DN.. 1104..
DN.. 1506..

PSKN 75°

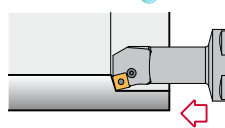

Page
Seite E75 SNM.. 1204..

POSITIVE BORING BARS / POSITIVE BOHRSTANGEN

Center screw boring bars Bohrstangen mit Zentralschrauben-Klemmung

SCLC 95°

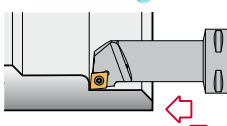

Page
Seite E76 CC.. 09T3..
CC.. 1204..

SDUC 93°

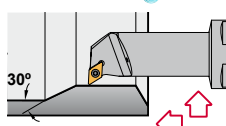

Page
Seite E77 DC.. 0702..
DC.. 11T3..

SDUC-X 93°

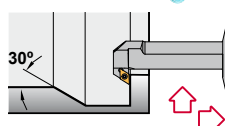

Page
Seite E78 DC.. 0702..

SSKC 75°

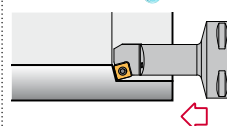

Page
Seite E79 SC.. 09T3..

STFC 90°

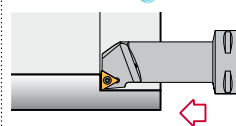

Page
Seite E80 TC.. 1102..
TC.. 16T3..

POSITIVE BORING BARS / POSITIVE BOHRSTANGEN

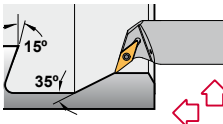
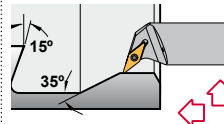
<p>SVQB 107°30'</p>  <p>Page Seite E81</p> <p>VBMT 1604..</p>	<p>SVQC 107°30'</p>  <p>Page Seite E82</p> <p>VC.. 1103.. VC.. 1604..</p>			
---	---	--	--	--

THREADING / GEWINDEDREHEN

External and internal threading Außengewindedrehen und Innengewindedrehen

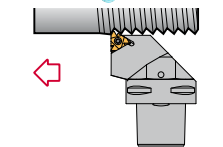
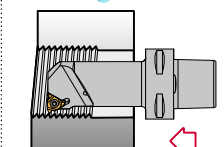
<p>SE 90°</p>  <p>Page Seite E83</p> <p>16 ER/L.. 22 ER/L..</p>	<p>SI 90°</p>  <p>Page Seite E84</p> <p>16 NR/L.. 22 NR/L..</p>			
---	---	--	--	--

PARTING AND GROOVING / AB- UND EINSTECHDREHEN

Toolholders and boring bars Klemmhalter und Bohrstan- gen

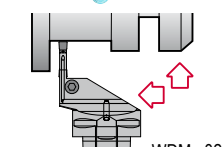
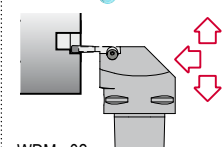
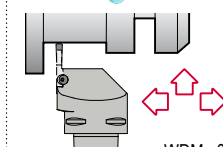
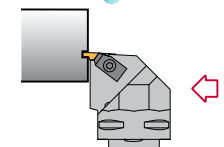
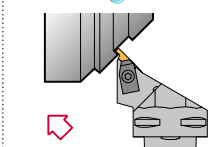
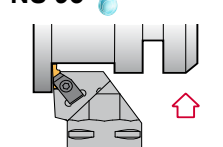
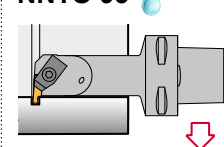
<p>CZCD</p>  <p>Page Seite E85</p> <p>WDM.. 02 .. WDM.. 06</p>	<p>CZFD</p>  <p>WDM.. 02 .. WDM.. 06</p> <p>Page Seite E86</p>	<p>CZGD</p>  <p>Page Seite E87</p> <p>WDM.. 02 .. WDM.. 06</p>	<p>NE 93°</p>  <p>Page Seite E88</p> <p>N.. 3</p>	<p>NR 45°</p>  <p>Page Seite E89</p> <p>N.. 3</p>
<p>NS 93°</p>  <p>Page Seite E90</p> <p>N.. 2 N.. 3 N.. 4</p>	<p>NNT0 93°</p>  <p>N.. 2 N.. 3 N.. 4</p> <p>Page Seite E91</p>			

DRILLS / BOHRER

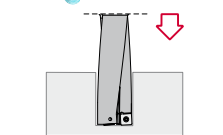
<p>45..</p>  <p>SPMT 0603.. .. SPMT 1204..</p> <p>Page Seite E92-94</p>				
---	--	--	--	--





Characteristics:
Multipurpose toolholder equipped with rhombic negative double-sided insert (angle 80°).
PSC with internal coolant.

- 1) γ = Rake angle (valid with a flat insert).
- 2) λ_s = Angle of inclination.

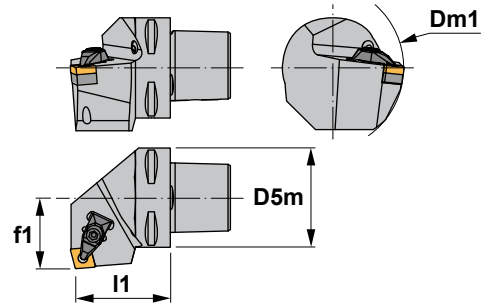

Eigenschaften:
Multifunktions-Werkzeug mit einer doppelseitigen rhombischen negativen Wendeschneidplatte (Winkel 80°). PSC mit Innenkühlung.

- 1) γ = Spanwinkel (Gültig nur mit flachen Wendeschneidplatte).
- 2) λ_s = Neigungswinkel.

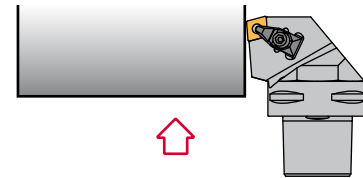

DCKN 75°

Reference Bezeichnung	D5m	Dm1 min.	f1	l1	γ^1	λ_s^2	Insert size Wendeschneidplatte	Kg
PSC40-DCKNR/L27050-12	40	110	27	50	-6°	-6°	CN.. 1204..	0,420
PSC50-DCKNR/L35060-12	50	110	35	60	-6°	-6°	CN.. 1204..	0,800
PSC63-DCKNR/L45065-12	63	110	45	65	-6°	-6°	CN.. 1204..	1,100
PSC40-DCKNR/L27050-16	40	125	27	50	-6°	-6°	CN.. 1606..	0,420
PSC50-DCKNR/L35060-16	50	125	35	60	-6°	-6°	CN.. 1606..	0,800
PSC63-DCKNR/L45065-16	63	125	45	65	-6°	-6°	CN.. 1606..	1,100
PSC63-DCKNR/L45065-19	63	125	45	65	-6°	-6°	CN.. 1906..	1,100
PSC80-DCKNR/L55080-19	80	125	55	80	-6°	-6°	CN.. 1906..	2,740

Reference Bezeichnung							Nm
PSC40-DCKNR/L27050-12	1766	ICSN-442	2712	1696	4295	5004	3.5
PSC50-DCKNR/L35060-12	1766	ICSN-442	2712	1696	4295	5004	3.5
PSC63-DCKNR/L45065-12	1766	ICSN-442	2712	1696	4295	5004	3.5
PSC40-DCKNR/L27050-16	1768	ICSN-533	2716	1696	4295	5004	3.5
PSC50-DCKNR/L35060-16	1768	ICSN-533	2716	1696	4295	5004	3.5
PSC63-DCKNR/L45065-16	1768	ICSN-533	2716	1696	4295	5004	3.5
PSC63-DCKNR/L45065-19	1770	ICSN-633	2719	1696	4295	5004	3.5
PSC80-DCKNR/L55080-19	1770	ICSN-633	2719	1696	4295	5004	3.5

CN..

80° rhombic negative inserts.
80° rhombische negative WSP. A32-34

Reference / Bez.	l	s	d
CN.. 1204..	12,90	4,76	12,70
CN.. 1606..	16,10	6,35	15,88
CN.. 1906..	19,30	6,35	19,05

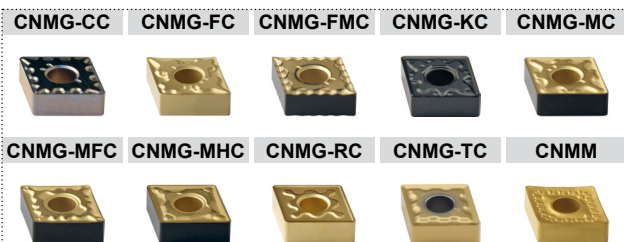
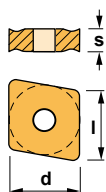



Characteristics:
Multipurpose toolholder equipped with rhombic negative double-sided insert (angle 80°).
PSC with internal coolant.

Eigenschaften:
Multifunktions-Werkzeug mit einer doppelseitigen rhombischen negativen Wendeschneidplatte (Winkel 80°).
PSC mit Innenkühlung.

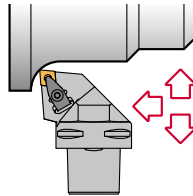
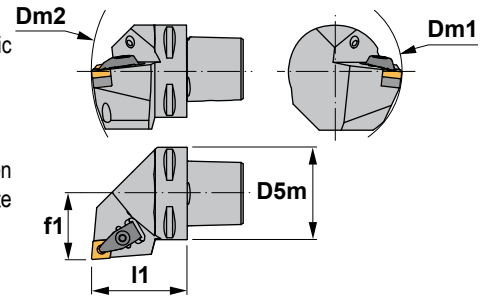

- 1) γ = Rake angle (valid with a flat insert).
Spanwinkel (Gültig nur mit flachen Wendeschneidplatte).
- 2) λ_s = Angle of inclination.
Neigungswinkel.

DCLN 95°

Reference Bezeichnung	D5m	Dm1 min.	Dm2 min.	f1	l1	γ^1	λ_s^2	Insert size Wendeschneidplatte	KG
PSC32-DCLNR/L22040-09	32	60	60	22	40	-6°	-6°	CN.. 0903..	0,210
PSC40-DCLNR/L27050-09	40	60	60	27	50	-6°	-6°	CN.. 0903..	0,420
PSC32-DCLNR/L22045-12	32	60	60	22	45	-6°	-6°	CN.. 1204..	0,240
PSC40-DCLNR/L27050-12	40	110	110	27	50	-6°	-6°	CN.. 1204..	0,420
PSC50-DCLNR/L35060-12	50	110	110	35	60	-6°	-6°	CN.. 1204..	0,800
PSC63-DCLNR/L45065-12	63	110	110	45	65	-6°	-6°	CN.. 1204..	1,100
PSC80-DCLNR/L55080-12	80	110	110	55	80	-6°	-6°	CN.. 1204..	2,740
PSC40-DCLNR/L27055-16	40	125	125	27	55	-6°	-6°	CN.. 1606..	0,430
PSC50-DCLNR/L35060-16	50	125	125	35	60	-6°	-6°	CN.. 1606..	0,800
PSC63-DCLNR/L45065-16	63	125	125	45	65	-6°	-6°	CN.. 1606..	1,100
PSC80-DCLNR/L55080-16	80	125	125	55	80	-6°	-6°	CN.. 1606..	2,740
PSC50-DCLNR/L35060-19	50	125	125	35	60	-6°	-6°	CN.. 1906..	0,800
PSC63-DCLNR/L45065-19	63	125	125	45	65	-6°	-6°	CN.. 1906..	1,100
PSC80-DCLNR/L55080-19	80	125	125	55	80	-6°	-6°	CN.. 1906..	2,740

Reference Bezeichnung							Nm
PSC32-DCLNR/L22040-09	1764	ICSN-332	2708	1695	4294	5004	3.5
PSC40-DCLNR/L27050-09	1764	ICSN-332	2708	1695	4294	5004	3.5
PSC32-DCLNR/L22045-12	1766	ICSN-442	2712	1696	4295	5004	3.5
PSC40-DCLNR/L27050-12	1766	ICSN-442	2712	1696	4295	5004	3.5
PSC50-DCLNR/L35060-12	1766	ICSN-442	2712	1696	4295	5004	3.5
PSC63-DCLNR/L45065-12	1766	ICSN-442	2712	1696	4295	5004	3.5
PSC80-DCLNR/L55080-12	1766	ICSN-442	2712	1696	4295	5004	3.5
PSC40-DCLNR/L27055-16	1768	ICSN-533	2716	1696	4295	5004	3.5
PSC50-DCLNR/L35060-16	1768	ICSN-533	2716	1696	4295	5004	3.5
PSC63-DCLNR/L45065-16	1768	ICSN-533	2716	1696	4295	5004	3.5
PSC80-DCLNR/L55080-16	1768	ICSN-533	2716	1696	4295	5004	3.5
PSC50-DCLNR/L35060-19	1770	ICSN-633	2719	1696	4295	5004	3.5
PSC63-DCLNR/L45065-19	1770	ICSN-633	2719	1696	4295	5004	3.5
PSC80-DCLNR/L55080-19	1770	ICSN-633	2719	1696	4295	5004	3.5

CN.. 80° rhombic negative inserts. 80° rhombische negative WSP. A32-34

Reference / Bez.	l	s	d
CN.. 0903..	9,65	3,18	9,52
CN.. 1204..	12,90	4,76	12,70
CN.. 1606..	16,10	6,35	15,88
CN.. 1906..	19,30	6,35	19,05

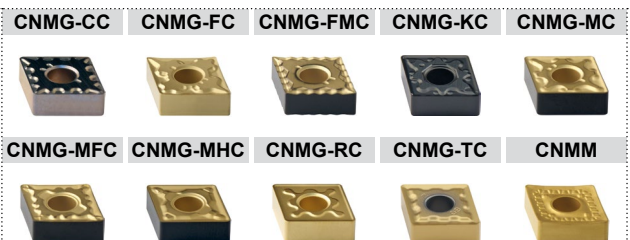
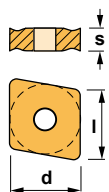



Characteristics:
Toolholder for multi-task machining equipped with rhombic negative inserts (angle 80°).
PSC with internal coolant.

- 1) γ = Rake angle (valid with a flat insert).
- 2) λ_s = Angle of inclination.

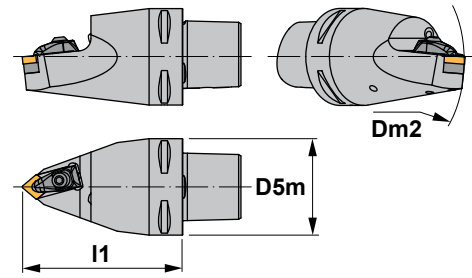

Eigenschaften:
Klemmhalter zur Multi-Task-Bearbeitung mit einer doppelseitigen rhombischen negativen Wendschneidplatte (80° Winkel).
PSC mit Innenkühlung.

- 1) γ = Spanwinkel (Gültig nur mit flachen Wendschneidplatte).
- 2) λ_s = Neigungswinkel.

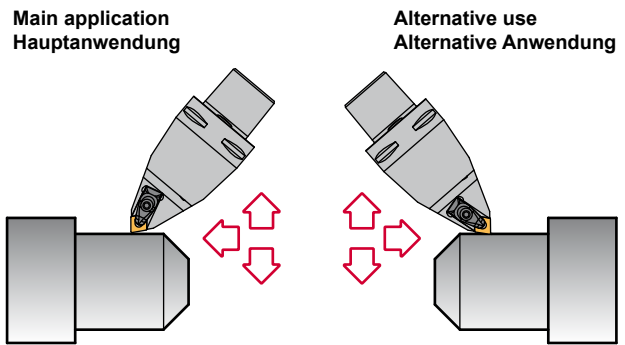

DCMN 50°

Reference Bezeichnung	D5m	Dm2 min.	I1	γ^1	λ_s^2	Insert size Wendschneidplatte	Kg
PSC63-DCMNN00115-12	63	110	115	-6°	-6°	CN.. 1204..	1,700
PSC80-DCMNN00150-16	80	115	150	-6°	-6°	CN.. 1606..	3,300

Reference Bezeichnung							Nm
PSC63-DCMNN00115-12	1766	ICSN-442	2712	1696	4295	5004	3.5
PSC80-DCMNN00150-16	1768	ICSN-533	2716	1696	4295	5004	3.5

CN..

80° rhombic negative inserts.
80° rhombische negative WSP. A32-34

Reference / Bez.	l	s	d
CN.. 1204..	12,90	4,76	12,70
CN.. 1606..	16,10	6,35	15,88

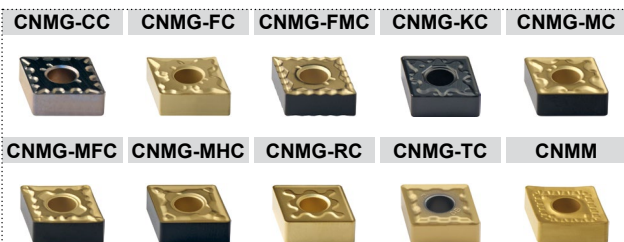
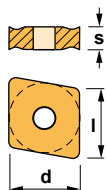



Characteristics:
Multipurpose toolholder equipped with rhombic negative double-sided insert (angle 80°).
PSC with internal coolant.

- 1) γ = Rake angle (valid with a flat insert).
- 2) λ_s = Angle of inclination.

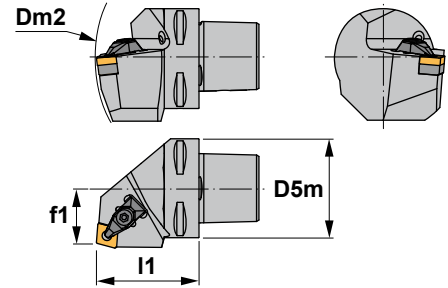

Eigenschaften:
Multifunktions-Werkzeug mit einer doppelseitigen rhombischen negativen Wendeschneidplatte (Winkel 80°).
PSC mit Innenkühlung.

- 1) γ = Spanwinkel (Gültig nur mit flachen Wendeschneidplatte).
- 2) λ_s = Neigungswinkel.

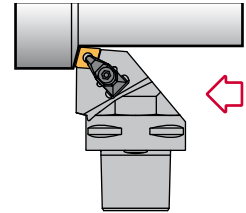

DCRN 75°

Reference Bezeichnung	D5m	Dm2 min.	f1	l1	$\gamma^{1)}$	$\lambda_s^{2)}$	Insert size Wendeschneidplatte	Kg
PSC40-DCRNR/L22050-12	40	140	22	50	-6°	-6°	CN.. 1204..	0,420
PSC50-DCRNR/L27060-12	50	165	27	60	-6°	-6°	CN.. 1204..	0,800
PSC63-DCRNR/L35065-12	63	190	35	65	-6°	-6°	CN.. 1204..	1,400
PSC50-DCRNR/L27060-16	50	165	27	60	-6°	-6°	CN.. 1606..	0,800
PSC63-DCRNR/L35065-16	63	190	35	65	-6°	-6°	CN.. 1606..	1,400
PSC80-DCRNR/L55080-16	80	250	55	80	-6°	-6°	CN.. 1606..	2,740
PSC50-DCRNR/L27060-19	50	165	27	60	-6°	-6°	CN.. 1906..	0,800
PSC63-DCRNR/L35065-19	63	190	35	65	-6°	-6°	CN.. 1906..	1,400
PSC80-DCRNR/L55080-19	80	250	55	80	-6°	-6°	CN.. 1906..	2,740

Reference Bezeichnung							Nm
PSC40-DCRNR/L22050-12	1766	ICSN-442	2712	1696	4295	5004	3.5
PSC50-DCRNR/L27060-12	1766	ICSN-442	2712	1696	4295	5004	3.5
PSC63-DCRNR/L35065-12	1766	ICSN-442	2712	1696	4295	5004	3.5
PSC50-DCRNR/L27060-16	1768	ICSN-533	2716	1696	4295	5004	3.5
PSC63-DCRNR/L35065-16	1768	ICSN-533	2716	1696	4295	5004	3.5
PSC80-DCRNR/L55080-16	1768	ICSN-533	2716	1696	4295	5004	3.5
PSC50-DCRNR/L27060-19	1770	ICSN-633	2719	1696	4295	5004	3.5
PSC63-DCRNR/L35065-19	1770	ICSN-633	2719	1696	4295	5004	3.5
PSC80-DCRNR/L55080-19	1770	ICSN-633	2719	1696	4295	5004	3.5

CN.. 80° rhombic negative inserts.
80° rhombische negative WSP. A32-34

Reference / Bez.	l	s	d
CN.. 1204..	12,90	4,76	12,70
CN.. 1606..	16,10	6,35	15,88
CN.. 1906..	19,30	6,35	19,05

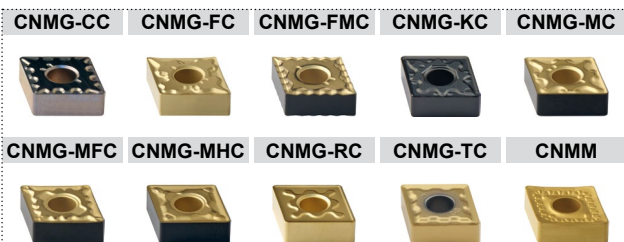
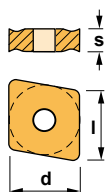



Characteristics:
Turning and profiling toolholder equipped with rhombic negative double-sided insert (angle 55°).
PSC with internal coolant.

- 1) γ = Rake angle (valid with a flat insert).
- 2) λ_s = Angle of inclination.

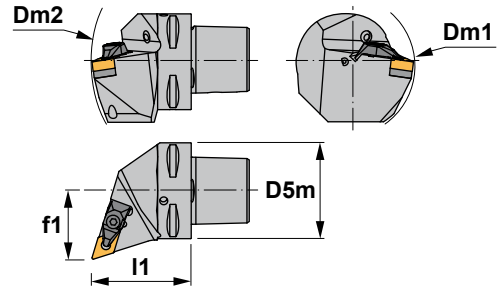

Eigenschaften:
Klemmhalter zum Drehen und Kopierdrehen mit einer doppelseitigen rhombischen negativen Wendeschneiplatte (Winkel 55°).
PSC mit Innenkühlung.

- 1) γ = Spanwinkel (Gültig nur mit flachen Wendeschneidplatte).
- 2) λ_s = Neigungswinkel.

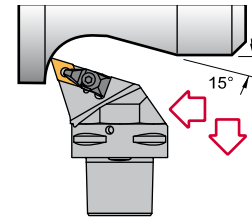

DDHN 107° 30'

Reference Bezeichnung	D5m	Dm1 min.	Dm2 min.	f1	l1	γ^1	λ_s^2	Insert size Wendeschneidplatte	
PSC40-DDHNR/L27055-15	40	110	145	27	55	-6°	-7°	DN.. 1506..	0,430
PSC50-DDHNR/L35060-15	50	110	165	35	60	-6°	-7°	DN.. 1506..	0,800
PSC63-DDHNR/L45065-15	63	110	190	45	65	-6°	-7°	DN.. 1506..	1,100
PSC80-DDHNR/L55080-15	80	110	250	55	80	-6°	-7°	DN.. 1506..	2,740

Reference Bezeichnung							Nm
PSC40-DDHNR/L27055-15	1766	IDSN-432	2712	1696	4295	5004	3.5
PSC50-DDHNR/L35060-15	1766	IDSN-432	2712	1696	4295	5004	3.5
PSC63-DDHNR/L45065-15	1766	IDSN-432	2712	1696	4295	5004	3.5
PSC80-DDHNR/L55080-15	1766	IDSN-432	2712	1696	4295	5004	3.5

DN.. 55° rhombic negative inserts. A36-37
55° rhombische negative Wendeschneidplatten.

Reference / Bez.	l	s	d
DN.. 1506..	15,50	6,35	12,70

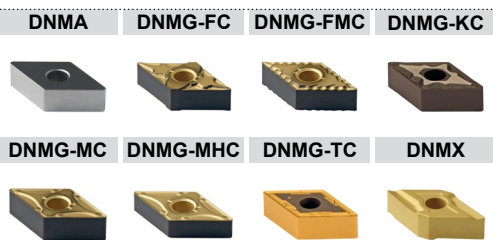
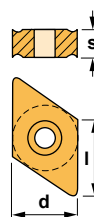



Characteristics:
Turning and profiling toolholder equipped with rhombic negative double-sided insert (angle 55°).
PSC with internal coolant.

- 1) γ = Rake angle (valid with a flat insert).
- 2) λ_s = Angle of inclination.

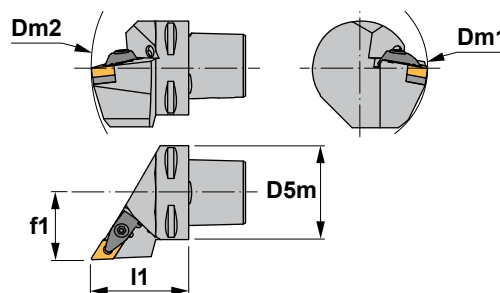

Eigenschaften:
Klemmhalter zum Drehen und Kopierdrehen mit einer doppelseitigen rhombischen negativen Wendeschneiplatte (Winkel 55°).
PSC mit Innenkühlung.

- 1) γ = Spanwinkel (Gültig nur mit flachen Wendeschneidplatte).
- 2) λ_s = Neigungswinkel.

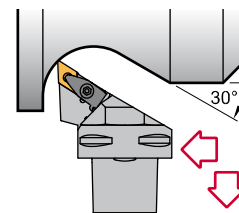

DDJN 93°

Reference Bezeichnung	D5m	Dm1 min.	Dm2 min.	f1	l1	$\gamma^1)$	$\lambda_s^2)$	Insert size Wendeschneidplatte	Kg
PSC32-DDJNR/L22045-11	32	60	121	22	45	-6°	-7°	DN.. 1104..	0,240
PSC40-DDJNR/L27050-11	40	60	140	27	50	-6°	-7°	DN.. 1104..	0,420
PSC50-DDJNR/L35060-11	50	65	165	35	60	-6°	-7°	DN.. 1104..	0,800
PSC63-DDJNR/L45065-11	63	81	190	45	65	-6°	-7°	DN.. 1104..	1,100
PSC40-DDJNR/L27055-15	40	110	145	27	55	-6°	-7°	DN.. 1506..	0,420
PSC50-DDJNR/L35060-15	50	110	165	35	60	-6°	-7°	DN.. 1506..	0,800
PSC63-DDJNR/L45065-15	63	110	190	45	65	-6°	-7°	DN.. 1506..	1,100
PSC80-DDJNR/L55080-15	80	110	250	55	80	-6°	-7°	DN.. 1506..	2,740

Reference Bezeichnung							Nm
PSC32-DDJNR/L22045-11	1764	IDSN-322	2708	1695	4294	5004	3.5
PSC40-DDJNR/L27050-11	1764	IDSN-322	2708	1695	4294	5004	3.5
PSC50-DDJNR/L35060-11	1764	IDSN-322	2708	1695	4294	5004	3.5
PSC63-DDJNR/L45065-11	1764	IDSN-322	2708	1695	4294	5004	3.5
PSC40-DDJNR/L27055-15	1766	IDSN-432	2712	1696	4295	5004	3.5
PSC50-DDJNR/L35060-15	1766	IDSN-432	2712	1696	4295	5004	3.5
PSC63-DDJNR/L45065-15	1766	IDSN-432	2712	1696	4295	5004	3.5
PSC80-DDJNR/L55080-15	1766	IDSN-432	2712	1696	4295	5004	3.5

DN.. 55° rhombic negative inserts. A36-37
55° rhombische negative Wendeschneidplatten.

Reference / Bez.	l	s	d
DN.. 1104..	11,60	4,76	9,52
DN.. 1506..	15,50	6,35	12,70

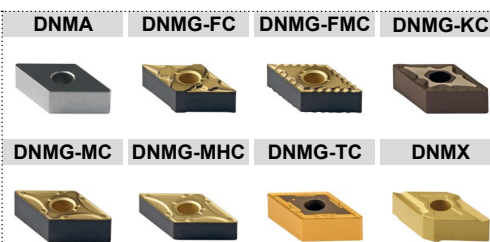
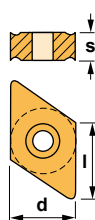



Characteristics:
Toolholder for multi-task machining equipped with rhombic negative inserts (angle 55°).
PSC with internal coolant.

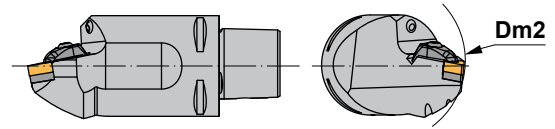

- 1) γ = Rake angle (valid with a flat insert).
- 2) λ_s = Angle of inclination.

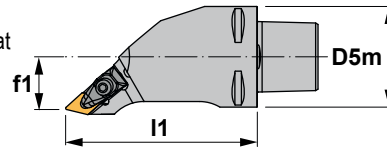

Eigenschaften:
Klemmhalter zur Multi-Task-Bearbeitung mit einer doppelseitigen rhombischen negativen Wendschneidplatte (55° Winkel).
PSC mit Innenkühlung.

- 1) γ = Spanwinkel (Gültig nur mit flachen Wendschneidplatte).
- 2) λ_s = Neigungswinkel.

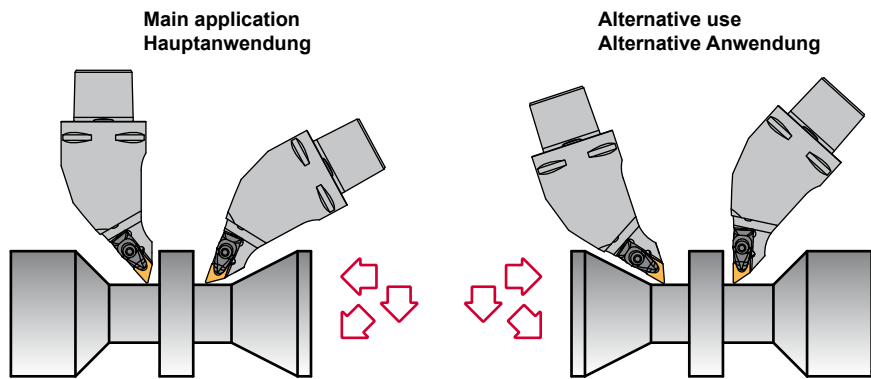

DDMN 48°

Reference Bezeichnung	D5m	Dm2 min.	f1	l1	γ_1	λ_{s2}	Insert size Wendschneidplatte	kg
PSC63-DDMNR/L33120-15	63	130	33	120	-5°	-9°	DN.. 1506..	2,300

Reference Bezeichnung							Nm
PSC63-DDMNR/L33120-15	1766	IDSN-432	2712	1696	4295	5004	3.5

DN..	55° rhombic negative inserts. A36-37 55° rhombische negative Wendschneidplatten.		
Reference / Bez.	l	s	d
DN.. 1506..	15,50	6,35	12,70

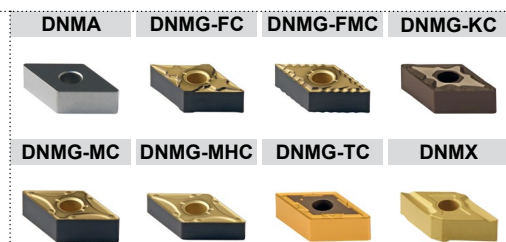
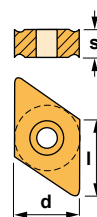



Characteristics:
Profiling toolholder equipped with rhombic negative double-sided insert (angle 55°).
PSC with internal coolant.

- 1) γ = Rake angle (valid with a flat insert).
- 2) λ_s = Angle of inclination.

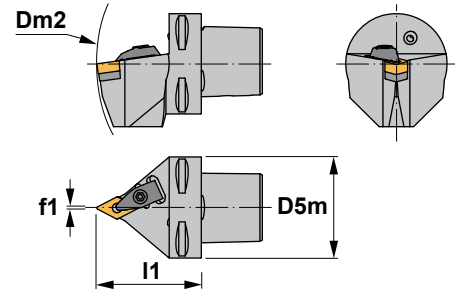

Eigenschaften:
Klemmhalter zum Profildrehen mit einer doppelseitigen rhombischen negativen Wendeschneidplatte (Winkel 55°).
PSC mit Innenkühlung.

- 1) γ = Spanwinkel (Gültig nur mit flachen Wendeschneidplatte).
- 2) λ_s = Neigungswinkel.

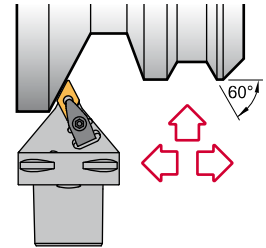

DDNN 63°

Reference Bezeichnung	D5m	Dm2 min.	f1	l1	γ^1	λ_s^2	Insert size Wendeschneidplatte	Kg
PSC40-DDNNN00050-11	40	140	0.5	50	-5°	-9°	DN.. 1104..	0,350
PSC50-DDNNN00060-11	50	165	0.5	60	-5°	-9°	DN.. 1104..	0,750
PSC40-DDNNN00055-15	40	145	0.5	55	-5°	-9°	DN.. 1506..	0,350
PSC50-DDNNN00060-15	50	165	0.5	60	-5°	-9°	DN.. 1506..	0,750
PSC63-DDNNN00065-15	63	190	0.5	65	-5°	-9°	DN.. 1506..	1,070
PSC80-DDNNN00080-15	80	250	0.5	80	-5°	-9°	DN.. 1506..	2,320

Reference Bezeichnung							Nm
PSC40-DDNNN00050-11	1764	IDSN-322	2708	1695	4294	5004	3.5
PSC50-DDNNN00060-11	1764	IDSN-322	2708	1695	4294	5004	3.5
PSC40-DDNNN00055-15	1766	IDSN-432	2712	1696	4295	5004	3.5
PSC50-DDNNN00060-15	1766	IDSN-432	2712	1696	4295	5004	3.5
PSC63-DDNNN00065-15	1766	IDSN-432	2712	1696	4295	5004	3.5
PSC80-DDNNN00080-15	1766	IDSN-432	2712	1696	4295	5004	3.5

DN.. 55° rhombic negative inserts. A36-37
55° rhombische negative Wendeschneidplatten.

Reference / Bez.	l	s	d
DN.. 1104..	11,60	4,76	9,52
DN.. 1506..	15,50	6,35	12,70

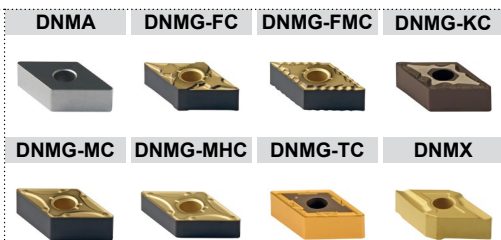
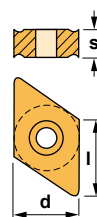



Characteristics:
Turning and profiling toolholder equipped with rhombic negative double-sided insert (angle 55°).
PSC with internal coolant.

- 1) γ = Rake angle (valid with a flat insert).
- 2) λ_s = Angle of inclination.

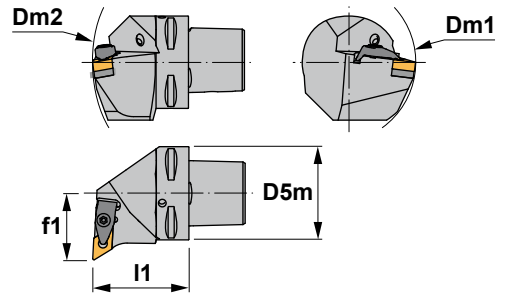

Eigenschaften:
Klemmhalter zum Drehen und Kopierdrehen mit einer doppelseitigen rhombischen negativen Wendeschneidplatte (Winkel 55°).
PSC mit Innenkühlung.

- 1) γ = Spanwinkel (Gültig nur mit flachen Wendeschneidplatte).
- 2) λ_s = Neigungswinkel.

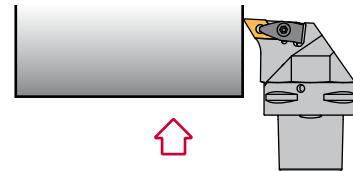

DDUN 93°

Reference Bezeichnung	D5m	Dm1 min.	Dm2 min.	f1	l1	$\gamma^1)$	$\lambda_s^2)$	Insert size Wendeschneidplatte	Kg
PSC40-DDUNR/L27050-15	40	110	140	27	50	-6°	-7°	DN.. 1506..	0,420
PSC50-DDUNR/L35060-15	50	110	165	35	60	-6°	-7°	DN.. 1506..	0,800
PSC63-DDUNR/L45065-15	63	110	190	45	65	-6°	-7°	DN.. 1506..	1,100
PSC80-DDUNR/L55080-15	80	110	250	55	80	-6°	-7°	DN.. 1506..	2,740

Reference Bezeichnung							Nm
PSC40-DDUNR/L27050-15	1766	IDSN-432	2712	1696	4295	5004	3.5
PSC50-DDUNR/L35060-15	1766	IDSN-432	2712	1696	4295	5004	3.5
PSC63-DDUNR/L45065-15	1766	IDSN-432	2712	1696	4295	5004	3.5
PSC80-DDUNR/L55080-15	1766	IDSN-432	2712	1696	4295	5004	3.5

DN.. 55° rhombic negative inserts. A36-37
55° rhombische negative Wendeschneidplatten.

Reference / Bez.	l	s	d
DN.. 1506..	15,50	6,35	12,70

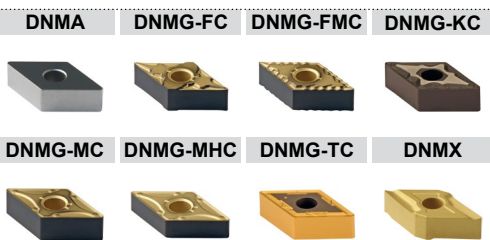
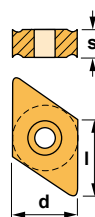



Characteristics:
Profiling multipurpose turning toolholder equipped with round negative insert. PSC with internal coolant.

- 1) γ = Rake angle (valid with a flat insert).
- 2) λ_s = Angle of inclination.

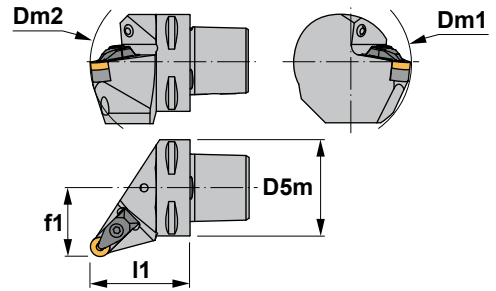

Eigenschaften:
Multifunktions-Klemmhalter zum Profildrehen mit einer runden negativen Wendeschneidplatte. PSC mit Innenkühlung.

- 1) γ = Spanwinkel (Gültig nur mit flachen Wendeschneidplatte).
- 2) λ_s = Neigungswinkel.

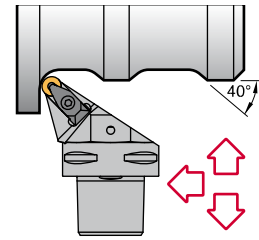

DRSN

Reference Bezeichnung	D5m	Dm1 min.	Dm2 min.	f1	l1	γ^1	λ_s^2	Insert size Wendeschneidplatte	
PSC40-DRSNR/L27050-12	40	110	140	27	50	-6°	-6°	RNMG 1204..	0,420
PSC50-DRSNR/L35060-12	50	110	165	35	60	-6°	-6°	RNMG 1204..	0,800
PSC63-DRSNR/L45065-12	63	110	190	45	65	-6°	-6°	RNMG 1204..	1,100

Reference Bezeichnung							Nm
PSC40-DRSNR/L27050-12	1766	IRSN-44	2712	1696	4295	5004	3.5
PSC50-DRSNR/L35060-12	1766	IRSN-44	2712	1696	4295	5004	3.5
PSC63-DRSNR/L45065-12	1766	IRSN-44	2712	1696	4295	5004	3.5

RNMG

Round negative insert.
Runde negative Wendeschneidplatte. A39

Reference / Bez.	s	d
RNMG 1204..	4,76	12,70

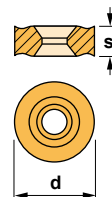

RNMG



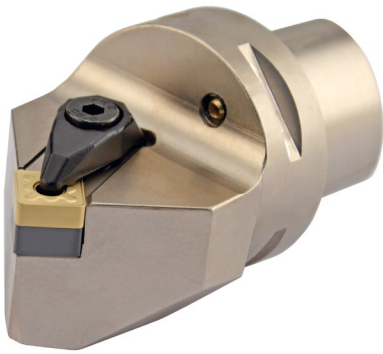

Characteristics:

Toolholder for external turning and chamfering applications equipped with square negative inserts.
PSC with internal coolant.

- 1) γ = Rake angle (valid with a flat insert).
- 2) λ_s = Angle of inclination.

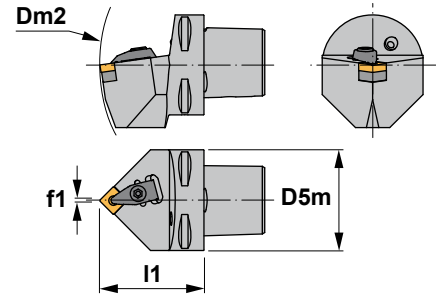

Eigenschaften:

Klemmhalter zum Außendrehen und Abschrägen mit einer vierkantigen negativen Wendschneidplatte.
PSC mit Innenkühlung.

- 1) γ = Spanwinkel (Gültig nur mit flachen Wendschneidplatte).
- 2) λ_s = Neigungswinkel.

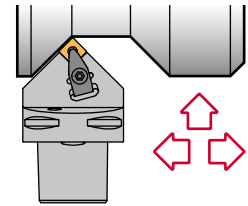

DSDN 45°

Reference Bezeichnung	D5m	Dm2 min.	f1	l1	$\gamma^1)$	$\lambda_s^2)$	Insert size Wendschneidplatte	Kg
PSC32-DSDNN00048-12	32	124	0.3	48	-6°	-6°	SNM.. 1204..	0,240
PSC40-DSDNN00050-12	40	140	0.3	50	-6°	-6°	SNM.. 1204..	0,350
PSC50-DSDNN00060-12	50	165	0.3	60	-6°	-6°	SNM.. 1204..	0,750
PSC63-DSDNN00065-12	63	190	0.3	65	-6°	-6°	SNM.. 1204..	1,070
PSC50-DSDNN00060-15	50	165	0.5	60	-6°	-6°	SNM.. 1506..	0,750
PSC63-DSDNN00065-15	63	190	0.5	65	-6°	-6°	SNM.. 1506..	1,070
PSC50-DSDNN00065-19	50	170	0.5	65	-6°	-6°	SNM.. 1906..	0,800
PSC63-DSDNN00070-19	63	195	0.5	70	-6°	-6°	SNM.. 1906..	1,260

Reference Bezeichnung							Nm
PSC32-DSDNN00048-12	1766	ISSN-442	2712	1696	4295	5004	3.5
PSC40-DSDNN00050-12	1766	ISSN-442	2712	1696	4295	5004	3.5
PSC50-DSDNN00060-12	1766	ISSN-442	2712	1696	4295	5004	3.5
PSC63-DSDNN00065-12	1766	ISSN-442	2712	1696	4295	5004	3.5
PSC50-DSDNN00060-15	1768	ISSN-533	2716	1696	4295	5004	3.5
PSC63-DSDNN00065-15	1768	ISSN-533	2716	1696	4295	5004	3.5
PSC50-DSDNN00065-19	1770	ISSN-633	2719	1696	4295	5004	3.5
PSC63-DSDNN00070-19	1770	ISSN-633	2719	1696	4295	5004	3.5

SNM..

Square negative inserts. A41-42
Vierkantige negative Wendschneidplatten.

Reference / Bez.	l	s	d
SNM.. 1204..	12,70	4,76	12,70
SNM.. 1506..	15,88	6,35	15,88
SNM.. 1906..	19,05	6,35	19,05

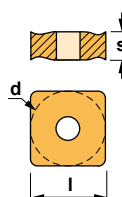

SNMG-FMC



SNMG-KC



SNMG-MHC



SNMG-RC



SNMG-TC



SNMM





Characteristics:

Toolholder for face turning applications equipped with square negative inserts. PSC with internal coolant.

- 1) γ = Rake angle (valid with a flat insert).
- 2) λ_s = Angle of inclination.

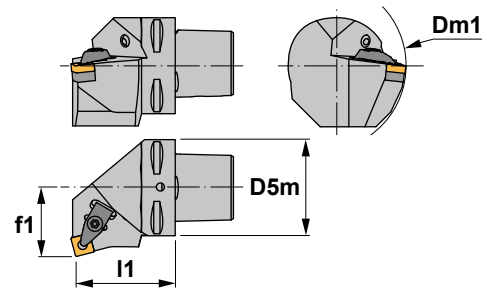

Eigenschaften:

Klemmhalter zum Plandrehen mit einer vierkantigen negativen Wendeschneidplatte. PSC mit Innenkühlung.

- 1) γ = Spanwinkel (Gültig nur mit flachen Wendeschneidplatte).
- 2) λ_s = Neigungswinkel.

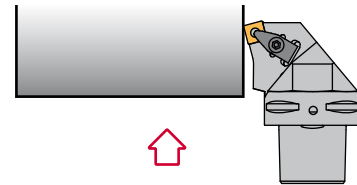

DSKN 75°

Reference Bezeichnung	D5m	Dm1 min.	f1	l1	$\gamma^1)$	$\lambda_s^2)$	Insert size Wendeschneidplatte	
PSC32-DSKNR/L22040-12	32	60	22	40	-6°	-6°	SNM.. 1204..	0,210
PSC40-DSKNR/L27050-12	40	110	27	50	-6°	-6°	SNM.. 1204..	0,420
PSC50-DSKNR/L35060-12	50	110	35	60	-6°	-6°	SNM.. 1204..	0,800
PSC63-DSKNR/L45065-12	63	110	45	65	-6°	-6°	SNM.. 1204..	1,100
PSC50-DSKNR/L35060-15	50	125	35	60	-6°	-6°	SNM.. 1506..	0,800
PSC63-DSKNR/L45065-15	63	125	45	65	-6°	-6°	SNM.. 1506..	1,100
PSC50-DSKNR/L35060-19	50	125	35	60	-6°	-6°	SNM.. 1906..	0,800
PSC63-DSKNR/L45065-19	63	125	45	65	-6°	-6°	SNM.. 1906..	1,100
PSC80-DSKNR/L55080-19	80	125	55	80	-6°	-6°	SNM.. 1906..	2,740

Reference Bezeichnung							Nm
PSC32-DSKNR/L22040-12	1766	ISSN-442	2712	1696	4295	5004	3.5
PSC40-DSKNR/L27050-12	1766	ISSN-442	2712	1696	4295	5004	3.5
PSC50-DSKNR/L35060-12	1766	ISSN-442	2712	1696	4295	5004	3.5
PSC63-DSKNR/L45065-12	1766	ISSN-442	2712	1696	4295	5004	3.5
PSC50-DSKNR/L35060-15	1768	ISSN-533	2716	1696	4295	5004	3.5
PSC63-DSKNR/L45065-15	1768	ISSN-533	2716	1696	4295	5004	3.5
PSC50-DSKNR/L35060-19	1770	ISSN-633	2719	1696	4295	5004	3.5
PSC63-DSKNR/L45065-19	1770	ISSN-633	2719	1696	4295	5004	3.5
PSC80-DSKNR/L55080-19	1770	ISSN-633	2719	1696	4295	5004	3.5

SNM.. <small>Square negative inserts. Vierkantige negative Wendeschneidplatten. A41-42</small>						
Reference / Bez.	l	s	d			
SNM.. 1204..	12,70	4,76	12,70			SNMG-FMC
SNM.. 1506..	15,88	6,35	15,88			SNMG-KC
SNM.. 1906..	19,05	6,35	19,05			SNMG-MHC
						SNMG-RC
						SNMG-TC
						SNMM





Characteristics:

Toolholder for face turning applications equipped with square negative inserts. PSC with internal coolant.

- 1) γ = Rake angle (valid with a flat insert).
- 2) λ_s = Angle of inclination.

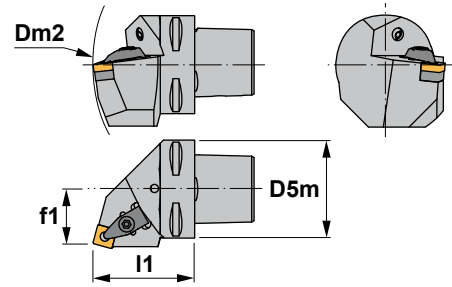

Eigenschaften:

Klemhalter zum Plandrehen mit einer vierkantigen negativen Wendeschneidplatte. PSC mit Innenkühlung.

- 1) γ = Spanwinkel (Gültig nur mit flachen Wendeschneidplatte).
- 2) λ_s = Neigungswinkel.

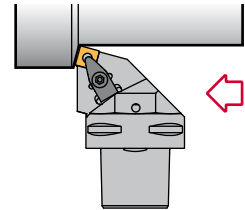

DSRN 75°

Reference Bezeichnung	D5m	Dm2 min.	f1	I1	γ^1	λ_s^2	Insert size Wendeschneidplatte	KG
PSC32-DSRNR/L19048-12	32	124	19	48	-6°	-6°	SNM.. 1204..	0,260
PSC40-DSRNR/L22050-12	40	140	22	50	-6°	-6°	SNM.. 1204..	0,420
PSC50-DSRNR/L27060-12	50	165	27	60	-6°	-6°	SNM.. 1204..	0,800
PSC63-DSRNR/L35065-12	63	190	35	65	-6°	-6°	SNM.. 1204..	1,400
PSC50-DSRNR/L27060-15	50	165	27	60	-6°	-6°	SNM.. 1506..	0,800
PSC63-DSRNR/L35065-15	63	190	35	65	-6°	-6°	SNM.. 1506..	1,400
PSC50-DSRNR/L27060-19	50	165	27	60	-6°	-6°	SNM.. 1906..	0,800
PSC63-DSRNR/L35065-19	63	190	35	65	-6°	-6°	SNM.. 1906..	1,400
PSC80-DSRNR/L45080-19	80	250	45	80	-6°	-6°	SNM.. 1906..	2,800

Reference Bezeichnung							Nm
PSC32-DSRNR/L19048-12	1766	ISSN-442	2712	1696	4295	5004	3.5
PSC40-DSRNR/L22050-12	1766	ISSN-442	2712	1696	4295	5004	3.5
PSC50-DSRNR/L27060-12	1766	ISSN-442	2712	1696	4295	5004	3.5
PSC63-DSRNR/L35065-12	1766	ISSN-442	2712	1696	4295	5004	3.5
PSC50-DSRNR/L27060-15	1768	ISSN-533	2716	1696	4295	5004	3.5
PSC63-DSRNR/L35065-15	1768	ISSN-533	2716	1696	4295	5004	3.5
PSC50-DSRNR/L27060-19	1770	ISSN-633	2719	1696	4295	5004	3.5
PSC63-DSRNR/L35065-19	1770	ISSN-633	2719	1696	4295	5004	3.5
PSC80-DSRNR/L45080-19	1770	ISSN-633	2719	1696	4295	5004	3.5

SNM..

Square negative inserts. A41-42
Vierkantige negative Wendeschneidplatten.

Reference / Bez.	l	s	d
SNM.. 1204..	12,70	4,76	12,70
SNM.. 1506..	15,88	6,35	15,88
SNM.. 1906..	19,05	6,35	19,05

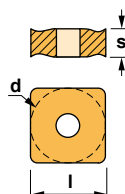

SNMG-FMC



SNMG-KC



SNMG-MHC



SNMG-RC



SNMG-TC



SNMM





Characteristics:

Toolholder for external turning and chamfering applications equipped with square negative inserts.
PSC with internal coolant.

- 1) γ = Rake angle (valid with a flat insert).
- 2) λ_s = Angle of inclination.

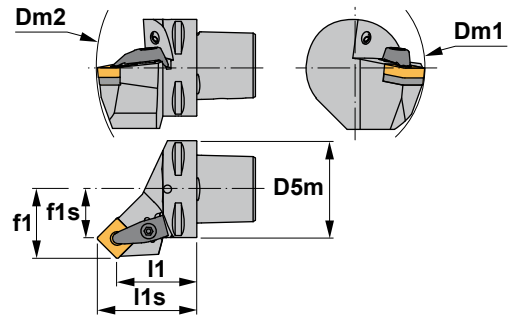

Eigenschaften:

Klemmhalter zum Außendrehen und Abschrägen mit einer vierkantigen negativen Wendeschneidplatte.
PSC mit Innenkühlung.

- 1) γ = Spanwinkel (Gültig nur mit flachen Wendeschneidplatte).
- 2) λ_s = Neigungswinkel.

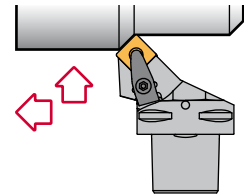

DSSN 45°

Reference Bezeichnung	D5m	Dm1 min.	Dm2 min.	f1	f1s	l1	l1s	γ^1	λ_s^2	Insert size Wendeschneidplatte	kg
PSC32-DSSNR/L22040-12	32	60	124	22	13.7	40	48.3	-8°	0°	SNM.. 1204..	0,210
PSC40-DSSNR/L27042-12	40	110	140	27	18.7	42	50.3	-8°	0°	SNM.. 1204..	0,350
PSC50-DSSNR/L35052-12	50	110	165	35	26.7	52	60.3	-8°	0°	SNM.. 1204..	0,700
PSC63-DSSNR/L45056-12	63	110	190	45	36.7	56	64.3	-8°	0°	SNM.. 1204..	1,120
PSC40-DSSNR/L27045-15	40	125	145	27	16.8	45	55.2	-8°	0°	SNM.. 1506..	0,400
PSC50-DSSNR/L35050-15	50	125	165	35	24.8	50	60.2	-8°	0°	SNM.. 1506..	0,680
PSC63-DSSNR/L45054-15	63	125	190	45	34.8	54	64.2	-8°	0°	SNM.. 1506..	1,140
PSC50-DSSNR/L35048-19	50	125	165	35	22.5	48	60.5	-8°	0°	SNM.. 1906..	0,700
PSC63-DSSNR/L45052-19	63	125	190	45	32.5	52	64.5	-8°	0°	SNM.. 1906..	1,130

Reference Bezeichnung							Nm
PSC32-DSSNR/L22040-12	1766	ISSN-442	2712	1696	4295	5004	3.5
PSC40-DSSNR/L27042-12	1766	ISSN-442	2712	1696	4295	5004	3.5
PSC50-DSSNR/L35052-12	1766	ISSN-442	2712	1696	4295	5004	3.5
PSC63-DSSNR/L45056-12	1766	ISSN-442	2712	1696	4295	5004	3.5
PSC40-DSSNR/L27045-15	1768	ISSN-533	2716	1696	4295	5004	3.5
PSC50-DSSNR/L35050-15	1768	ISSN-533	2716	1696	4295	5004	3.5
PSC63-DSSNR/L45054-15	1768	ISSN-533	2716	1696	4295	5004	3.5
PSC50-DSSNR/L35048-19	1770	ISSN-633	2719	1696	4295	5004	3.5
PSC63-DSSNR/L45052-19	1770	ISSN-633	2719	1696	4295	5004	3.5

SNM.. <small>Square negative inserts. Vierkantige negative Wendeschneidplatten. A41-42</small>			
Reference / Bez.	l	s	d
SNM.. 1204..	12,70	4,76	12,70
SNM.. 1506..	15,88	6,35	15,88
SNM.. 1906..	19,05	6,35	19,05

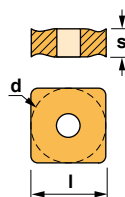

SNMG-FMC	SNMG-KC	SNMG-MHC
SNMG-RC	SNMG-TC	SNMM





Characteristics:
Toolholder for face turning applications equipped with triangular negative inserts. PSC with internal coolant.

- 1) γ = Rake angle (valid with a flat insert).
- 2) λ_s = Angle of inclination.

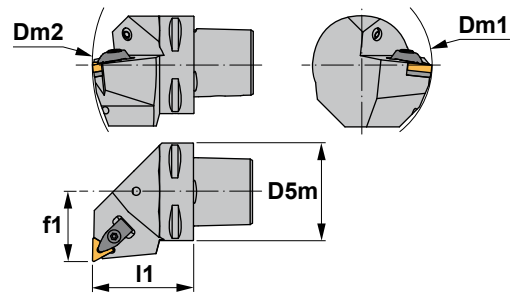

Eigenschaften:
Klemmhalter zum Plandrehen mit einer dreikantigen negativen Wendeschneidplatte. PSC mit Innenkühlung.

- 1) γ = Spanwinkel (Gültig nur mit flachen Wendeschneidplatte).
- 2) λ_s = Neigungswinkel.

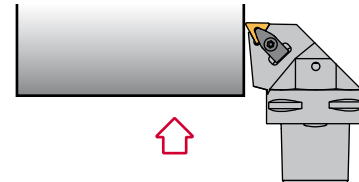

DTFN 90°

Reference Bezeichnung	D5m	Dm1 min.	Dm2 min.	f1	l1	γ^1	λ_s^2	Insert size Wendeschneidplatte	kg
PSC32-DTFNR/L22040-16	32	60	116	22	40	-6°	-6°	TNM.. 1604..	0,210
PSC40-DTFNR/L27050-16	40	110	140	27	50	-6°	-6°	TNM.. 1604..	0,420
PSC50-DTFNR/L35060-16	50	110	165	35	60	-6°	-6°	TNM.. 1604..	0,800
PSC63-DTFNR/L45065-16	63	110	190	45	65	-6°	-6°	TNM.. 1604..	1,100
PSC40-DTFNR/L27050-22	40	110	140	27	50	-6°	-6°	TNM.. 2204..	0,420
PSC50-DTFNR/L35060-22	50	110	165	35	60	-6°	-6°	TNM.. 2204..	0,800
PSC63-DTFNR/L45065-22	63	110	190	45	65	-6°	-6°	TNM.. 2204..	1,100

Reference Bezeichnung							Nm
PSC32-DTFNR/L22040-16	1764	ITSN-342	2708	1695	4294	5004	3.5
PSC40-DTFNR/L27050-16	1764	ITSN-342	2708	1695	4294	5004	3.5
PSC50-DTFNR/L35060-16	1764	ITSN-342	2708	1695	4294	5004	3.5
PSC63-DTFNR/L45065-16	1764	ITSN-342	2708	1695	4294	5004	3.5
PSC40-DTFNR/L27050-22	1766	ITSN-443	2712	1696	4295	5004	3.5
PSC50-DTFNR/L35060-22	1766	ITSN-443	2712	1696	4295	5004	3.5
PSC63-DTFNR/L45065-22	1766	ITSN-443	2712	1696	4295	5004	3.5

TNM..

Triangular negative inserts.
Dreikantige negative WSP. A45-46

Reference / Bez.	l	s	d
TNM.. 1604..	16,50	4,76	9,52
TNM.. 2204..	22,00	4,76	12,70

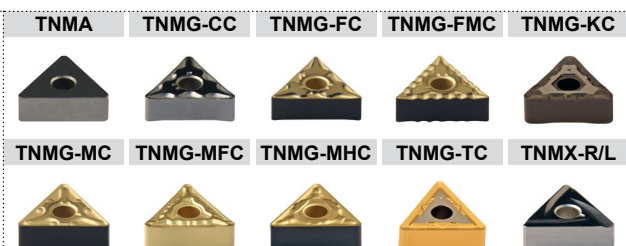
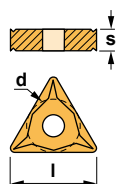



Characteristics:

Toolholder for external turning applications equipped with triangular negative inserts. PSC with internal coolant.

- 1) γ = Rake angle (valid with a flat insert).
- 2) λ_s = Angle of inclination.

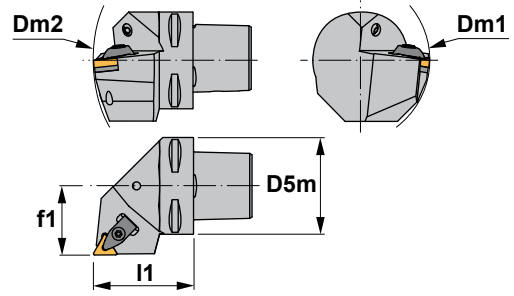

Eigenschaften:

Klemmhalter zum Außendrehen mit einer dreikantigen negativen Wendeschneidplatte. PSC mit Innenkühlung.

- 1) γ = Spanwinkel (Gültig nur mit flachen Wendeschneidplatte).
- 2) λ_s = Neigungswinkel.

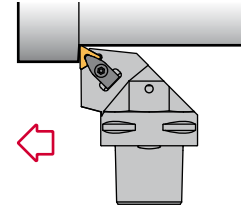

DTGN 90°

Reference Bezeichnung	D5m	Dm1 min.	Dm2 min.	f1	l1	γ^1	λ_s^2	Insert size Wendeschneidplatte	kg
PSC40-DTGNR/L27050-16	40	110	140	27	50	-6°	-6°	TNM.. 1604..	0,420
PSC50-DTGNR/L35060-16	50	110	165	35	60	-6°	-6°	TNM.. 1604..	0,800
PSC63-DTGNR/L45065-16	63	110	190	45	65	-6°	-6°	TNM.. 1604..	1,100
PSC40-DTGNR/L27050-22	40	110	140	27	50	-6°	-6°	TNM.. 2204..	0,420
PSC50-DTGNR/L35060-22	50	110	165	35	60	-6°	-6°	TNM.. 2204..	0,800
PSC63-DTGNR/L45065-22	63	110	190	45	65	-6°	-6°	TNM.. 2204..	1,100

Reference Bezeichnung							Nm
PSC40-DTGNR/L27050-16	1764	ITSN-342	2708	1695	4294	5004	3.5
PSC50-DTGNR/L35060-16	1764	ITSN-342	2708	1695	4294	5004	3.5
PSC63-DTGNR/L45065-16	1764	ITSN-342	2708	1695	4294	5004	3.5
PSC40-DTGNR/L27050-22	1766	ITSN-443	2712	1696	4295	5004	3.5
PSC50-DTGNR/L35060-22	1766	ITSN-443	2712	1696	4295	5004	3.5
PSC63-DTGNR/L45065-22	1766	ITSN-443	2712	1696	4295	5004	3.5

TNM.. <small>Triangular negative inserts. Dreikantige negative WSP. A45-46</small>									
Reference / Bez.	l	s	d		TNMA	TNMG-CC	TNMG-FC	TNMG-FMC	TNMG-KC
TNM.. 1604..	16,50	4,76	9,52						
TNM.. 2204..	22,00	4,76	12,70						



**Characteristics:**

Toolholder for very specific operations equipped with rhombic negative inserts (angle 35°).

PSC with internal coolant.

- 1) γ = Rake angle (valid with a flat insert).
- 2) λ_s = Angle of inclination.

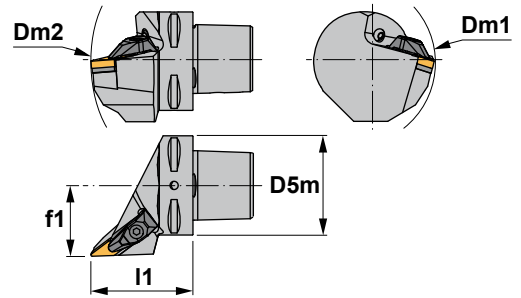
**Eigenschaften:**

Klemmhalter für sehr spezifische Anwendungen mit einer rhombischen negativen Wendeschneidplatte (Winkel 35°).

PSC mit Innenkühlung.

- 1) γ = Spanwinkel (Gültig nur mit flachen Wendeschneidplatte).
- 2) λ_s = Neigungswinkel.

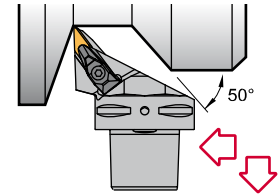

DVJN 93°

Reference Bezeichnung	D5m	Dm1 min.	Dm2 min.	f1	l1	$\gamma^{1)}$	$\lambda_s^{2)}$	Insert size Wendeschneidplatte	
PSC40-DVJNR/L27062-16	40	60	152	27	62	-4°	-13°	VN.. 1604..	0,450
PSC50-DVJNR/L35065-16	50	65	170	35	65	-4°	-13°	VN.. 1604..	0,790
PSC63-DVJNR/L45065-16	63	81	190	45	65	-4°	-13°	VN.. 1604..	1,100
PSC80-DVJNR/L55080-16	80	100	250	55	80	-4°	-13°	VN.. 1604..	2,740

Reference Bezeichnung							Nm
PSC40-DVJNR/L27062-16	1764	IVSN-322	2708	1695	4294	5004	3.5
PSC50-DVJNR/L35065-16	1764	IVSN-322	2708	1695	4294	5004	3.5
PSC63-DVJNR/L45065-16	1764	IVSN-322	2708	1695	4294	5004	3.5
PSC80-DVJNR/L55080-16	1764	IVSN-322	2708	1695	4294	5004	3.5

VN..

35° rhombic negative inserts. A49
35° rhombische negative Wendeschneidplatten.

Reference / Bez.	l	s	d
VN.. 1604..	16,50	4,76	9,52

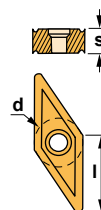
**VNGP****VNMG****VNMG-TC**



Characteristics:

Profiling toolholder equipped with rhombic negative double-sided insert (angle 35°). PSC with internal coolant.

- 1) γ = Rake angle (valid with a flat insert).
- 2) λ_s = Angle of inclination.

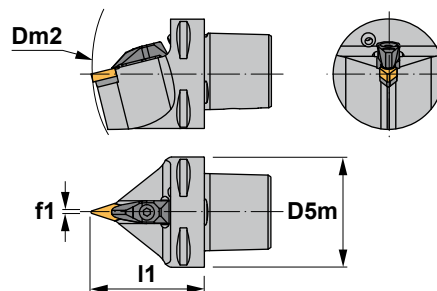

Eigenschaften:

Klemmhalter zum Drehen und Profildrehen mit einer doppelseitigen rhombischen negativen Wendeschneidplatte (Winkel 35°). PSC mit Innenkühlung.

- 1) γ = Spanwinkel (Gültig nur mit flachen Wendeschneidplatte).
- 2) λ_s = Neigungswinkel.

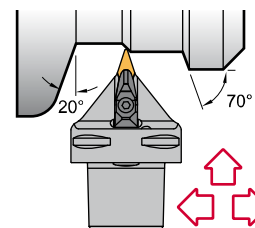

DVNN 72° 30'

Reference Bezeichnung	D5m	Dm2 min.	f1	l1	γ^1	λ_s^2	Insert size Wendeschneidplatte	kg
PSC40-DVVNN00062-16	40	152	0.6	62	-4°	-13°	VN.. 1604..	0,430
PSC50-DVVNN00065-16	50	170	0.6	65	-4°	-13°	VN.. 1604..	0,800
PSC63-DVVNN00065-16	63	190	0.6	65	-4°	-13°	VN.. 1604..	1,070
PSC80-DVVNN00080-16	80	250	0.6	80	-4°	-13°	VN.. 1604..	2,320

Reference Bezeichnung							Nm
PSC40-DVVNN00062-16	1764	IVSN-322	2708	1695	4294	5004	3.5
PSC50-DVVNN00065-16	1764	IVSN-322	2708	1695	4294	5004	3.5
PSC63-DVVNN00065-16	1764	IVSN-322	2708	1695	4294	5004	3.5
PSC80-DVVNN00080-16	1764	IVSN-322	2708	1695	4294	5004	3.5

VN.. 35° rhombic negative inserts. A49
35° rhombische negative Wendeschneidplatten.

Reference / Bez.	l	s	d
VN.. 1604..	16,50	4,76	9,52

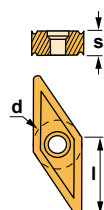

VNGP	VNMG
VNMG-TC	





Characteristics:
Multipurpose toolholder equipped with trigon negative double-sided insert (angle 80°).
PSC with internal coolant.

- 1) γ = Rake angle (valid with a flat insert).
- 2) λ_s = Angle of inclination.

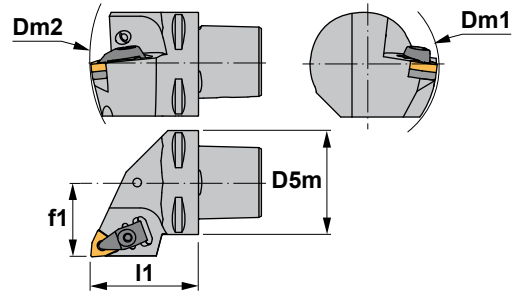

Eigenschaften:
Multifunktions-Klemmhalter mit einer doppelseitigen negativen Trigon-Wendeschneidplatte (Winkel 80°).
PSC mit Innenkühlung.

- 1) γ = Spanwinkel (Gültig nur mit flachen Wendeschneidplatte).
- 2) λ_s = Neigungswinkel.

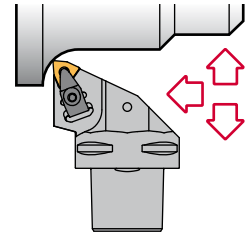

DWLN 95°

Reference Bezeichnung	D5m	Dm1 min.	Dm2 min.	f1	l1	γ^1	λ_s^2	Insert size Wendeschneidplatte	Kg
PSC32-DWLNR/L22040-06	32	60	116	22	40	-6°	-6°	WNMG 0604..	0,210
PSC40-DWLNR/L27050-06	40	60	140	27	50	-6°	-6°	WNMG 0604..	0,420
PSC50-DWLNR/L35060-06	50	65	165	35	60	-6°	-6°	WNMG 0604..	0,800
PSC63-DWLNR/L45065-06	63	81	190	45	65	-6°	-6°	WNMG 0604..	1,100
PSC40-DWLNR/L27050-08	40	110	140	27	50	-6°	-6°	WNMG 0804..	0,420
PSC50-DWLNR/L35060-08	50	110	165	35	60	-6°	-6°	WNMG 0804..	0,800
PSC63-DWLNR/L45065-08	63	110	190	45	65	-6°	-6°	WNMG 0804..	1,100
PSC80-DWLNR/L55080-08	80	110	250	55	80	-6°	-6°	WNMG 0804..	2,740

Reference Bezeichnung							Nm
PSC32-DWLNR/L22040-06	1764	IWSN-322	2708	1695	4294	5004	3.5
PSC40-DWLNR/L27050-06	1764	IWSN-322	2708	1695	4294	5004	3.5
PSC50-DWLNR/L35060-06	1764	IWSN-322	2708	1695	4294	5004	3.5
PSC63-DWLNR/L45065-06	1764	IWSN-322	2708	1695	4294	5004	3.5
PSC40-DWLNR/L27050-08	1766	IWSN-433	2712	1696	4295	5004	3.5
PSC50-DWLNR/L35060-08	1766	IWSN-433	2712	1696	4295	5004	3.5
PSC63-DWLNR/L45065-08	1766	IWSN-433	2712	1696	4295	5004	3.5
PSC80-DWLNR/L55080-08	1766	IWSN-433	2712	1696	4295	5004	3.5

WNMG 80° trigon negative inserts. A50-51 80° trigon negative Wendeschneidplatten.

Reference / Bez.	l	s	d
WNMG 0604..	6,45	4,76	9,52
WNMG 0804..	8,14	4,76	12,70

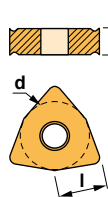



Characteristics:
Toolholder for face turning applications equipped with rhombic negative inserts (angle 80°).
PSC with internal coolant.

- 1) γ = Rake angle (valid with a flat insert).
- 2) λ_s = Angle of inclination.

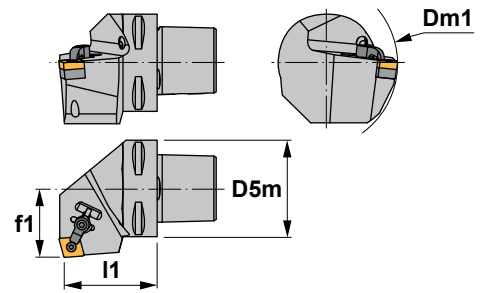

Eigenschaften:
Klemmhalter zum Plandrehen mit einer doppelseitigen rhombischen negativen Wendeschneidplatte (80° Winkel).
PSC mit Innenkühlung.

- 1) γ = Spanwinkel (Gültig nur mit flachen Wendeschneidplatte).
- 2) λ_s = Neigungswinkel.

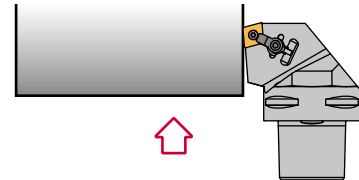

MCKN 75°

Reference Bezeichnung	D5m	Dm1 min.	f1	l1	γ^1	λ_s^2	Insert size Wendeschneidplatte	Kg
PSC40-MCKNR/L27050-12	40	110	27	50	-6°	-6°	CN.. 1204..	0,420
PSC50-MCKNR/L35060-12	50	110	35	60	-6°	-6°	CN.. 1204..	0,800
PSC63-MCKNR/L45065-12	63	110	45	65	-6°	-6°	CN.. 1204..	1,100
PSC40-MCKNR/L27050-16	40	125	27	50	-6°	-6°	CN.. 1606..	0,420
PSC50-MCKNR/L35060-16	50	125	35	60	-6°	-6°	CN.. 1606..	0,800
PSC63-MCKNR/L45065-16	63	125	45	65	-6°	-6°	CN.. 1606..	1,100
PSC63-MCKNR/L45065-19	63	125	45	65	-6°	-6°	CN.. 1906..	1,100
PSC80-MCKNR/L55080-19	80	125	55	80	-6°	-6°	CN.. 1906..	2,740

Reference Bezeichnung							Nm
PSC40-MCKNR/L27050-12	2613	1086	5003	ICSN-442	1657	5025	3.0
PSC50-MCKNR/L35060-12	2613	1086	5003	ICSN-442	1657	5025	3.0
PSC63-MCKNR/L45065-12	2613	1086	5003	ICSN-442	1657	5025	3.0
PSC40-MCKNR/L27050-16	2614	1086	5003	ICSN-533	1673	5003	3.0
PSC50-MCKNR/L35060-16	2614	1086	5003	ICSN-533	1673	5003	3.0
PSC63-MCKNR/L45065-16	2614	1086	5003	ICSN-533	1673	5003	3.0
PSC63-MCKNR/L45065-19	2614	1086	5003	ICSN-633	1674	5004	3.0
PSC80-MCKNR/L55080-19	2614	1086	5003	ICSN-633	1674	5004	3.0

CN.. 80° rhombic negative inserts. A32-34
80° rhombische negative WSP.

Reference / Bez.	l	s	d
CN.. 1204..	12,90	4,76	12,70
CN.. 1606..	16,10	6,35	15,88
CN.. 1906..	19,30	6,35	19,05

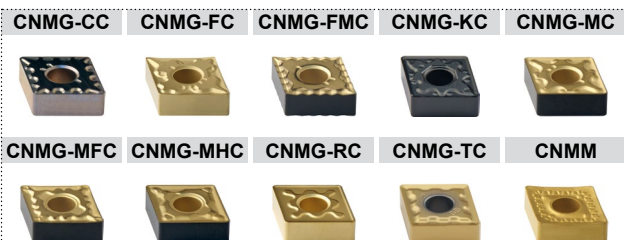
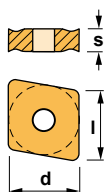



Characteristics:
Multipurpose toolholder equipped with rhombic negative double-sided insert (angle 80°). PSC with internal coolant.

- 1) γ = Rake angle (valid with a flat insert).
- 2) λ_s = Angle of inclination.

Eigenschaften:
Multifunktions-Klemmhalter mit einer doppelseitigen rhombischen Wendeschneidplatte (Winkel 80°). PSC mit Innenkühlung.

- 1) γ = Spanwinkel (Gültig nur mit flachen Wendeschneidplatte).
- 2) λ_s = Neigungswinkel.

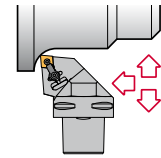
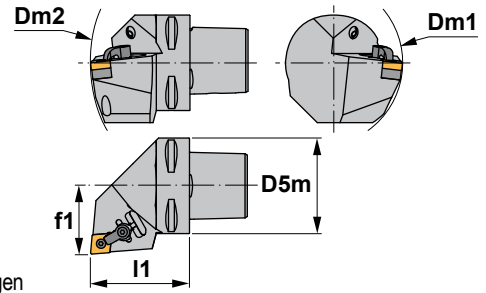

MCLN 95°

Reference Bezeichnung	D5m	Dm1 min.	Dm2 min.	f1	l1	$\gamma^1)$	$\lambda_s^2)$	Insert size Wendeschneidplatte	Kg
PSC32-MCLNR/L22040-09	32	60	116	22	40	-6°	-6°	CN.. 0903..	0,210
PSC40-MCLNR/L27050-09	40	60	140	27	50	-6°	-6°	CN.. 0903..	0,420
PSC32-MCLNR/L22045-12	32	60	121	22	45	-6°	-6°	CN.. 1204..	0,240
PSC40-MCLNR/L27050-12	40	110	140	27	50	-6°	-6°	CN.. 1204..	0,420
PSC50-MCLNR/L35060-12	50	110	165	35	60	-6°	-6°	CN.. 1204..	0,800
PSC63-MCLNR/L45065-12	63	110	190	45	65	-6°	-6°	CN.. 1204..	1,100
PSC80-MCLNR/L55080-12	80	110	250	55	80	-6°	-6°	CN.. 1204..	2,740
PSC40-MCLNR/L27055-16	40	125	145	27	55	-6°	-6°	CN.. 1606..	0,430
PSC50-MCLNR/L35060-16	50	125	165	35	60	-6°	-6°	CN.. 1606..	0,800
PSC63-MCLNR/L45065-16	63	125	190	45	65	-6°	-6°	CN.. 1606..	1,100
PSC80-MCLNR/L55080-16	80	125	250	55	80	-6°	-6°	CN.. 1606..	2,740
PSC50-MCLNR/L35060-19	50	125	165	35	60	-6°	-6°	CN.. 1906..	0,800
PSC63-MCLNR/L45065-19	63	125	190	45	65	-6°	-6°	CN.. 1906..	1,100
PSC80-MCLNR/L55080-19	80	125	250	55	80	-6°	-6°	CN.. 1906..	2,740

Reference Bezeichnung							Nm
PSC32-MCLNR/L22040-09	2604	1085	5025	ICSN-332	1665	5002	2.0
PSC40-MCLNR/L27050-09	2604	1085	5025	ICSN-332	1665	5002	2.0
PSC32-MCLNR/L22045-12	2613	1086	5003	ICSN-442	1657	5025	3.0
PSC40-MCLNR/L27050-12	2613	1086	5003	ICSN-442	1657	5025	3.0
PSC50-MCLNR/L35060-12	2613	1086	5003	ICSN-442	1657	5025	3.0
PSC63-MCLNR/L45065-12	2613	1086	5003	ICSN-442	1657	5025	3.0
PSC80-MCLNR/L55080-12	2613	1086	5003	ICSN-442	1657	5025	3.0
PSC40-MCLNR/L27055-16	2614	1086	5003	ICSN-533	1673	5003	3.0
PSC50-MCLNR/L35060-16	2614	1086	5003	ICSN-533	1673	5003	3.0
PSC63-MCLNR/L45065-16	2614	1086	5003	ICSN-533	1673	5003	3.0
PSC80-MCLNR/L55080-16	2614	1086	5003	ICSN-533	1673	5003	3.0
PSC50-MCLNR/L35060-19	2614	1086	5003	ICSN-633	1674	5004	3.0
PSC63-MCLNR/L45065-19	2614	1086	5003	ICSN-633	1674	5004	3.0
PSC80-MCLNR/L55080-19	2614	1086	5003	ICSN-633	1674	5004	3.0

CN..

80° rhombic negative inserts.
80° rhombische negative WSP. A32-34

Reference / Bez.	l	s	d
CN.. 0903..	9,65	3,18	9,52
CN.. 1204..	12,90	4,76	12,70
CN.. 1606..	16,10	6,35	15,88
CN.. 1906..	19,30	6,35	19,05

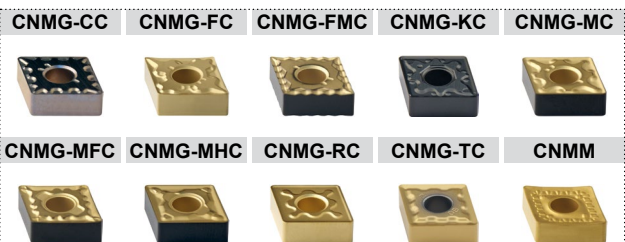
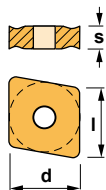

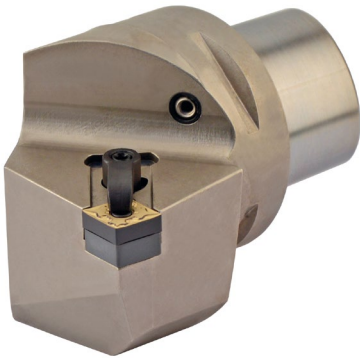

Characteristics:

Toolholder for external turning applications equipped with rhombic negative inserts (angle 80°).
PSC with internal coolant.

- 1) γ = Rake angle (valid with a flat insert).
- 2) λ_s = Angle of inclination.

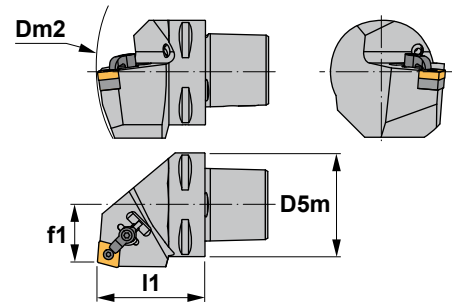

Eigenschaften:

Klemmhalter zum Außendrehen mit einer rhombischen negativen Wendeschneidplatte (80° Winkel).
PSC mit Innenkühlung.

- 1) γ = Spanwinkel (Gültig nur mit flachen Wendeschneidplatte).
- 2) λ_s = Neigungswinkel.

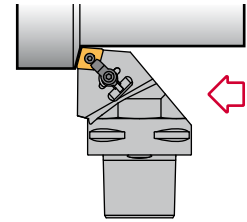

MCRN 75°

Reference Bezeichnung	D5m	Dm2 min.	f1	l1	$\gamma^1)$	$\lambda_s^2)$	Insert size Wendeschneidplatte	Kg
PSC40-MCRNR/L22050-12	40	140	22	50	-6°	-6°	CN.. 1204..	0,420
PSC50-MCRNR/L27060-12	50	165	27	60	-6°	-6°	CN.. 1204..	0,800
PSC63-MCRNR/L35065-12	63	190	35	65	-6°	-6°	CN.. 1204..	1,400
PSC50-MCRNR/L27060-16	50	165	27	60	-6°	-6°	CN.. 1606..	0,800
PSC63-MCRNR/L35065-16	63	190	35	65	-6°	-6°	CN.. 1606..	1,400
PSC80-MCRNR/L55080-16	80	250	55	80	-6°	-6°	CN.. 1606..	2,740
PSC50-MCRNR/L27060-19	50	165	27	60	-6°	-6°	CN.. 1906..	0,800
PSC63-MCRNR/L35065-19	63	190	35	65	-6°	-6°	CN.. 1906..	1,400
PSC80-MCRNR/L55080-19	80	250	55	80	-6°	-6°	CN.. 1906..	2,740

Reference Bezeichnung							Nm
PSC40-MCRNR/L22050-12	2613	1086	5003	ICSN-442	1657	5025	3.0
PSC50-MCRNR/L27060-12	2613	1086	5003	ICSN-442	1657	5025	3.0
PSC63-MCRNR/L35065-12	2613	1086	5003	ICSN-442	1657	5025	3.0
PSC50-MCRNR/L27060-16	2614	1086	5003	ICSN-533	1673	5003	3.0
PSC63-MCRNR/L35065-16	2614	1086	5003	ICSN-533	1673	5003	3.0
PSC80-MCRNR/L55080-16	2614	1086	5003	ICSN-533	1673	5003	3.0
PSC50-MCRNR/L27060-19	2614	1086	5003	ICSN-633	1674	5004	3.0
PSC63-MCRNR/L35065-19	2614	1086	5003	ICSN-633	1674	5004	3.0
PSC80-MCRNR/L55080-19	2614	1086	5003	ICSN-633	1674	5004	3.0

CN..

80° rhombic negative inserts.
80° rhombische negative WSP. A32-34

Reference / Bez.	l	s	d
CN.. 1204..	12,90	4,76	12,70
CN.. 1606..	16,10	6,35	15,88
CN.. 1906..	19,30	6,35	19,05

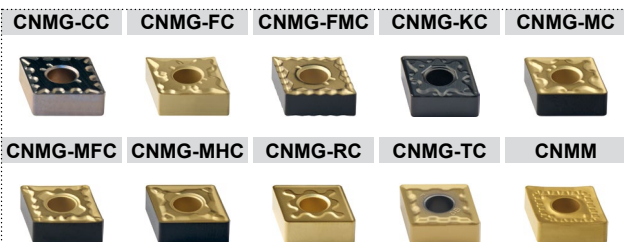
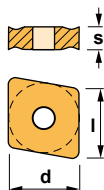



Characteristics:
Turning and profiling toolholder equipped with rhombic negative double-sided insert (angle 55°).
PSC with internal coolant.

- 1) γ = Rake angle (valid with a flat insert).
- 2) λ_s = Angle of inclination.

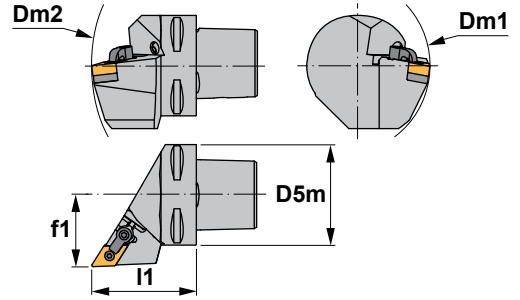

Eigenschaften:
Klemmhalter zum Drehen und Profildrehen mit einer doppelseitigen rhombischen negativen Wendeschneidplatte (Winkel 55°).
PSC mit Innenkühlung.

- 1) γ = Spanwinkel (Gültig nur mit flachen Wendeschneidplatte).
- 2) λ_s = Neigungswinkel.

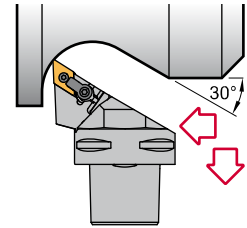

MDJN 93°

Reference Bezeichnung	D5m	Dm1 min.	Dm2 min.	f1	l1	$\gamma^1)$	$\lambda_s^2)$	Insert size Wendeschneidplatte	Kg
PSC32-MDJNR/L22045-11	32	60	121	22	45	-6°	-7°	DN.. 1104..	0,240
PSC40-MDJNR/L27050-11	40	60	140	27	50	-6°	-7°	DN.. 1104..	0,420
PSC50-MDJNR/L35060-11	50	65	165	35	60	-6°	-7°	DN.. 1104..	0,800
PSC63-MDJNR/L45065-11	63	81	190	45	65	-6°	-7°	DN.. 1104..	1,100
PSC40-MDJNR/L27055-15	40	110	145	27	55	-6°	-7°	DN.. 1506..	0,430
PSC50-MDJNR/L35060-15	50	110	165	35	60	-6°	-7°	DN.. 1506..	0,800
PSC63-MDJNR/L45065-15	63	110	190	45	65	-6°	-7°	DN.. 1506..	1,100
PSC80-MDJNR/L55080-15	80	110	250	55	80	-6°	-7°	DN.. 1506..	2,740

Reference Bezeichnung							Nm
PSC32-MDJNR/L22045-11	2604	1085	5025	IDSN-322	1665	5002	2.0
PSC40-MDJNR/L27050-11	2604	1085	5025	IDSN-322	1665	5002	2.0
PSC50-MDJNR/L35060-11	2604	1085	5025	IDSN-322	1665	5002	2.0
PSC63-MDJNR/L45065-11	2604	1085	5025	IDSN-322	1665	5002	2.0
PSC40-MDJNR/L27055-15	2613	1086	5003	IDSN-432	1657	5025	3.0
PSC50-MDJNR/L35060-15	2613	1086	5003	IDSN-432	1657	5025	3.0
PSC63-MDJNR/L45065-15	2613	1086	5003	IDSN-432	1657	5025	3.0
PSC80-MDJNR/L55080-15	2613	1086	5003	IDSN-432	1657	5025	3.0

DN.. 55° rhombic negative inserts. A36-37
55° rhombische negative Wendeschneidplatten.

Reference / Bez.	l	s	d
DN.. 1104..	11,60	4,76	9,52
DN.. 1506..	15,50	6,35	12,70

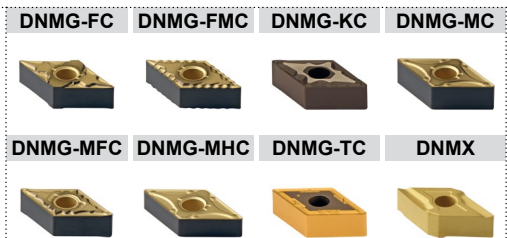
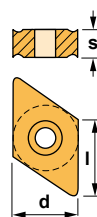



Characteristics:

Turning and profiling toolholder equipped with rhombic negative double-sided insert (angle 55°).
PSC with internal coolant.

- 1) γ = Rake angle (valid with a flat insert).
- 2) λ_s = Angle of inclination.

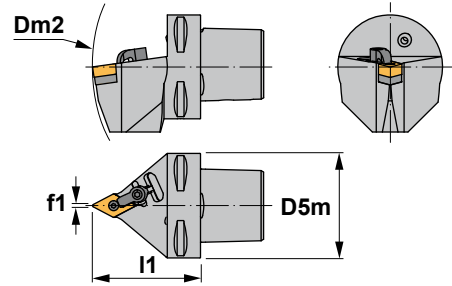

Eigenschaften:

Klemmhalter zum Drehen und Profildrehen mit einer doppelseitigen rhombischen negativen Wendeschneidplatte (Winkel 55°).
PSC mit Innenkühlung.

- 1) γ = Spanwinkel (Gültig nur mit flachen Wendeschneidplatte).
- 2) λ_s = Neigungswinkel.

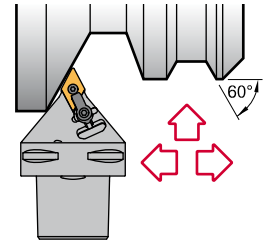

MDNN 63°

Reference Bezeichnung	D5m	Dm2 min.	f1	l1	γ^1	λ_s^2	Insert size Wendeschneidplatte	kg
PSC40-MDNNN00050-11	40	140	0.5	50	-5°	-9°	DN.. 1104..	0,350
PSC50-MDNNN00060-11	50	165	0.5	60	-5°	-9°	DN.. 1104..	0,750
PSC40-MDNNN00055-15	40	145	0.5	55	-5°	-9°	DN.. 1506..	0,370
PSC50-MDNNN00060-15	50	165	0.5	60	-5°	-9°	DN.. 1506..	0,750
PSC63-MDNNN00065-15	63	190	0.5	65	-5°	-9°	DN.. 1506..	1,070
PSC80-MDNNN00080-15	80	250	0.5	80	-5°	-9°	DN.. 1506..	2,320

Reference Bezeichnung						Nm
PSC40-MDNNN00050-11	2604	1085	5025	IDSN-322	1665 5002	2.0
PSC50-MDNNN00060-11	2604	1085	5025	IDSN-322	1665 5002	2.0
PSC40-MDNNN00055-15	2613	1086	5003	IDSN-432	1657 5025	3.0
PSC50-MDNNN00060-15	2613	1086	5003	IDSN-432	1657 5025	3.0
PSC63-MDNNN00065-15	2613	1086	5003	IDSN-432	1657 5025	3.0
PSC80-MDNNN00080-15	2613	1086	5003	IDSN-432	1657 5025	3.0

Reference / Bez.	l	s	d
DN.. 1104..	11,60	4,76	9,52
DN.. 1506..	15,50	6,35	12,70

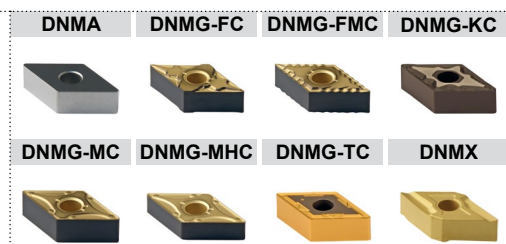
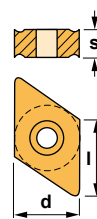

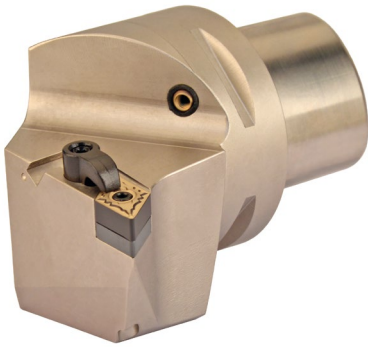

Characteristics:
Turning and profiling toolholder equipped with rhombic negative double-sided insert (angle 55°).
PSC with internal coolant.

- 1) γ = Rake angle (valid with a flat insert).
- 2) $\lambda.s$ = Angle of inclination.

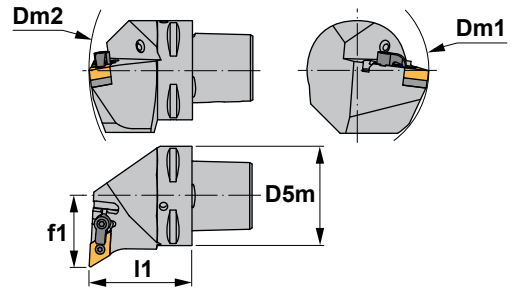

Eigenschaften:
Klemmhalter zum Drehen und Profildrehen mit einer doppelseitigen rhombischen negativen Wendeschneidplatte (Winkel 55°).
PSC mit Innenkühlung.

- 1) γ = Spanwinkel (Gültig nur mit flachen Wendeschneidplatte).
- 2) $\lambda.s$ = Neigungswinkel.

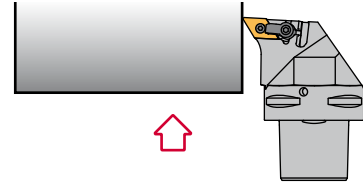

MDUN 93°

Reference Bezeichnung	D5m	Dm1 min.	Dm2 min.	f1	l1	γ^1	$\lambda.s^2$	Insert size Wendeschneidplatte	
PSC40-MDUNR/L27050-15	40	110	140	27	50	-6°	-7°	DN.. 1506..	0,420
PSC50-MDUNR/L35060-15	50	110	165	35	60	-6°	-7°	DN.. 1506..	0,800
PSC63-MDUNR/L45065-15	63	110	190	45	65	-6°	-7°	DN.. 1506..	1,100
PSC80-MDUNR/L55080-15	80	110	250	55	80	-6°	-7°	DN.. 1506..	2,740

Reference Bezeichnung						Nm
PSC40-MDUNR/L27050-15	2613	1086	5003	IDSN-432	1657 5025	3.0
PSC50-MDUNR/L35060-15	2613	1086	5003	IDSN-432	1657 5025	3.0
PSC63-MDUNR/L45065-15	2613	1086	5003	IDSN-432	1657 5025	3.0
PSC80-MDUNR/L55080-15	2613	1086	5003	IDSN-432	1657 5025	3.0

DN.. 55° rhombic negative inserts. A36-37
55° rhombische negative Wendeschneidplatten.

Reference / Bez.	l	s	d
DN.. 1506..	15,50	6,35	12,70

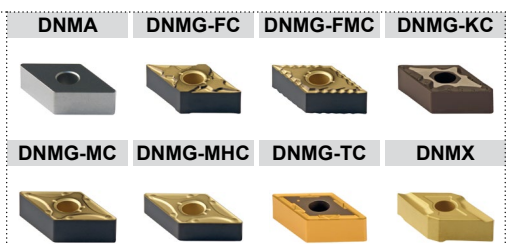
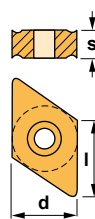

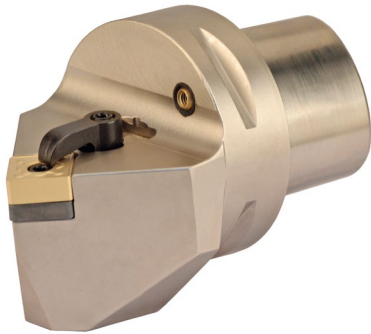

Characteristics:

Toolholder for external turning and chamfering applications equipped with square negative inserts.

PSC with internal coolant.

- 1) γ = Rake angle (valid with a flat insert).
- 2) λ_s = Angle of inclination.

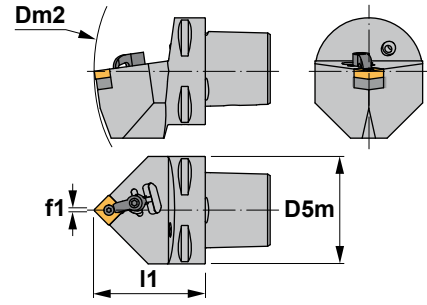

Eigenschaften:

Klemmhalter zum Außendrehen und Abschrägen mit einer vierkantigen negativen Wendeschneidplatte.

PSC mit Innenkühlung.

- 1) γ = Spanwinkel (Gültig nur mit flachen Wendeschneidplatte).
- 2) λ_s = Neigungswinkel.

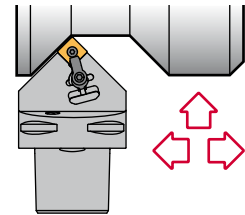

MSDN 45°

Reference Bezeichnung	D5m	Dm2 min.	f1	l1	γ^1	λ_s^2	Insert size Wendeschneidplatte	Kg
PSC32-MSDNN00048-12	32	124	0.3	48	-6°	-6°	SNM.. 1204..	0,240
PSC40-MSDNN00050-12	40	140	0.3	50	-6°	-6°	SNM.. 1204..	0,350
PSC50-MSDNN00060-12	50	165	0.3	60	-6°	-6°	SNM.. 1204..	0,750
PSC63-MSDNN00065-12	63	190	0.3	65	-6°	-6°	SNM.. 1204..	1,070
PSC50-MSDNN00060-15	50	165	0.5	60	-6°	-6°	SNM.. 1508..	0,750
PSC63-MSDNN00065-15	63	190	0.5	65	-6°	-6°	SNM.. 1508..	1,070
PSC50-MSDNN00065-19	50	170	0.5	65	-6°	-6°	SNM.. 1906..	0,800
PSC63-MSDNN00070-19	63	195	0.5	70	-6°	-6°	SNM.. 1906..	1,260

Reference Bezeichnung						Nm
PSC32-MSDNN00048-12	2613	1086	5003	ISSN-442	1657 5025	3.0
PSC40-MSDNN00050-12	2613	1086	5003	ISSN-442	1657 5025	3.0
PSC50-MSDNN00060-12	2613	1086	5003	ISSN-442	1657 5025	3.0
PSC63-MSDNN00065-12	2613	1086	5003	ISSN-442	1657 5025	3.0
PSC50-MSDNN00060-15	2614	1086	5003	ISSN-533	1673 5003	3.0
PSC63-MSDNN00065-15	2614	1086	5003	ISSN-533	1673 5003	3.0
PSC50-MSDNN00065-19	2614	1086	5003	ISSN-633	1674 5004	3.0
PSC63-MSDNN00070-19	2614	1086	5003	ISSN-633	1674 5004	3.0

SNM.. <small>Square negative inserts. Vierkantige negative Wendeschneidplatten. A41-42</small>			
Reference / Bez.	l	s	d
SNM.. 1204..	12,70	4,76	12,70
SNM.. 1506..	15,88	6,35	15,88
SNM.. 1906..	19,05	6,35	19,05

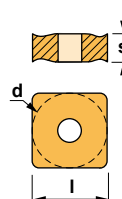

SNMG-FMC	SNMG-KC	SNMG-MHC
SNMG-RC	SNMG-TC	SNMM





Characteristics:

Toolholder for face turning applications equipped with square negative inserts. PSC with internal coolant.

- 1) γ = Rake angle (valid with a flat insert).
- 2) λ_s = Angle of inclination.

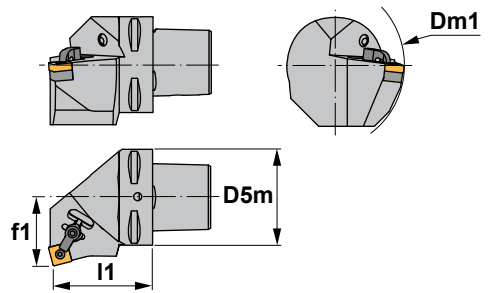

Eigenschaften:

Klemmhalter zum Plandrehen mit einer vierkantigen negativen Wendeschneidplatte. PSC mit Innenkühlung.

- 1) γ = Spanwinkel (Gültig nur mit flachen Wendeschneidplatte).
- 2) λ_s = Neigungswinkel.

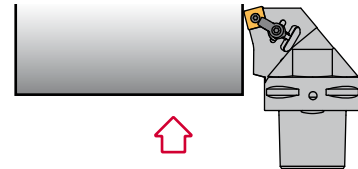

MSKN 75°

Reference Bezeichnung	D5m	Dm1 min.	f1	l1	$\gamma^{1)}$	$\lambda_s^{2)}$	Insert size Wendeschneidplatte	Kg
PSC32-MSKNR/L22040-12	32	60	22	40	-6°	-6°	SNM.. 1204..	0,210
PSC40-MSKNR/L27050-12	40	110	27	50	-6°	-6°	SNM.. 1204..	0,420
PSC50-MSKNR/L35060-12	50	110	35	60	-6°	-6°	SNM.. 1204..	0,800
PSC63-MSKNR/L45065-12	63	110	45	65	-6°	-6°	SNM.. 1204..	1,100
PSC50-MSKNR/L35060-15	50	125	35	60	-6°	-6°	SNM..1506..	0,800
PSC63-MSKNR/L45065-15	63	125	45	65	-6°	-6°	SNM..1506..	1,100
PSC50-MSKNR/L35060-19	50	125	35	60	-6°	-6°	SNM.. 1906..	0,800
PSC63-MSKNR/L45065-19	63	125	45	65	-6°	-6°	SNM.. 1906..	1,100
PSC80-MSKNR/L55080-19	80	125	55	80	-6°	-6°	SNM.. 1906..	2,740

Reference Bezeichnung						Nm
PSC32-MSKNR/L22040-12	2613	1086	5003	ISSN-442	1657 5025	3.0
PSC40-MSKNR/L27050-12	2613	1086	5003	ISSN-442	1657 5025	3.0
PSC50-MSKNR/L35060-12	2613	1086	5003	ISSN-442	1657 5025	3.0
PSC63-MSKNR/L45065-12	2613	1086	5003	ISSN-442	1657 5025	3.0
PSC50-MSKNR/L35060-15	2614	1086	5003	ISSN-533	1673 5003	3.0
PSC63-MSKNR/L45065-15	2614	1086	5003	ISSN-533	1673 5003	3.0
PSC50-MSKNR/L35060-19	2614	1086	5003	ISSN-633	1674 5004	3.0
PSC63-MSKNR/L45065-19	2614	1086	5003	ISSN-633	1674 5004	3.0
PSC80-MSKNR/L55080-19	2614	1086	5003	ISSN-633	1674 5004	3.0

SNM..

Square negative inserts. Vierkantige negative Wendeschneidplatten. A41-42

Reference / Bez.	l	s	d
SNM.. 1204..	12,70	4,76	12,70
SNM.. 1506..	15,88	6,35	15,88
SNM.. 1906..	19,05	6,35	19,05

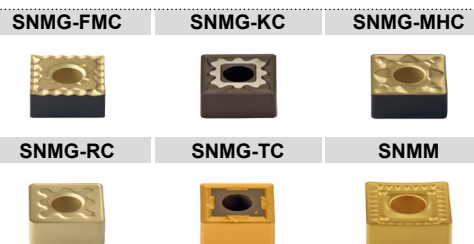
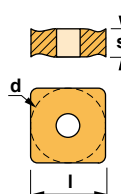

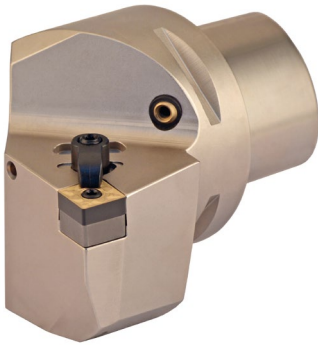

Characteristics:

Toolholder for face turning applications equipped with square negative inserts. PSC with internal coolant.

- 1) γ = Rake angle (valid with a flat insert).
- 2) λ_s = Angle of inclination.

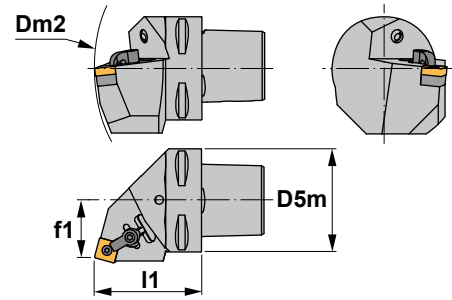

Eigenschaften:

Klemmhalter zum Plandrehen mit einer vierkantigen negativen Wendschneidplatte. PSC mit Innenkühlung.

- 1) γ = Spanwinkel (Gültig nur mit flachen Wendschneidplatte).
- 2) λ_s = Neigungswinkel.

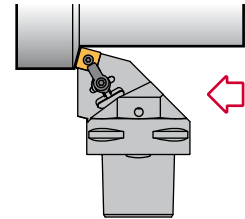

MSRN 75°

Reference Bezeichnung	D5m	Dm2 min.	f1	l1	γ^1	λ_s^2	Insert size Wendschneidplatte	
PSC32-MSRNR/L19048-12	32	124	19	48	-6°	-6°	SNM.. 1204..	0,260
PSC40-MSRNR/L22050-12	40	140	22	50	-6°	-6°	SNM.. 1204..	0,420
PSC50-MSRNR/L27060-12	50	165	27	60	-6°	-6°	SNM.. 1204..	0,800
PSC63-MSRNR/L35065-12	63	190	35	65	-6°	-6°	SNM.. 1204..	1,400
PSC50-MSRNR/L27060-15	50	165	27	60	-6°	-6°	SNM.. 1506..	0,800
PSC63-MSRNR/L35065-15	63	190	35	65	-6°	-6°	SNM.. 1506..	1,400
PSC50-MSRNR/L27060-19	50	165	27	60	-6°	-6°	SNM.. 1906..	0,800
PSC63-MSRNR/L35065-19	63	190	35	65	-6°	-6°	SNM.. 1906..	1,400
PSC80-MSRNR/L45080-19	80	250	45	80	-6°	-6°	SNM.. 1906..	2,800

Reference Bezeichnung							Nm
PSC32-MSRNR/L19048-12	2613	1086	5003	ISSN-442	1657	5025	3.0
PSC40-MSRNR/L22050-12	2613	1086	5003	ISSN-442	1657	5025	3.0
PSC50-MSRNR/L27060-12	2613	1086	5003	ISSN-442	1657	5025	3.0
PSC63-MSRNR/L35065-12	2613	1086	5003	ISSN-442	1657	5025	3.0
PSC50-MSRNR/L27060-15	2614	1086	5003	ISSN-533	1673	5003	3.0
PSC63-MSRNR/L35065-15	2614	1086	5003	ISSN-533	1673	5003	3.0
PSC50-MSRNR/L27060-19	2614	1086	5003	ISSN-633	1674	5004	3.0
PSC63-MSRNR/L35065-19	2614	1086	5003	ISSN-633	1674	5004	3.0
PSC80-MSRNR/L45080-19	2614	1086	5003	ISSN-633	1674	5004	3.0

SNM..

Square negative inserts. A41-42
Vierkantige negative Wendschneidplatten.

Reference / Bez.	l	s	d
SNM.. 1204..	12,70	4,76	12,70
SNM.. 1506..	15,88	6,35	15,88
SNM.. 1906..	19,05	6,35	19,05

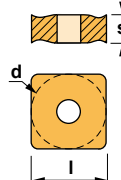

SNMG-FMC



SNMG-KC



SNMG-MHC



SNMG-RC



SNMG-TC



SNMM





Characteristics:
Toolholder for external turning and chamfering applications equipped with square negative inserts.
PSC with internal coolant.

- 1) γ = Rake angle (valid with a flat insert).
- 2) λ_s = Angle of inclination.

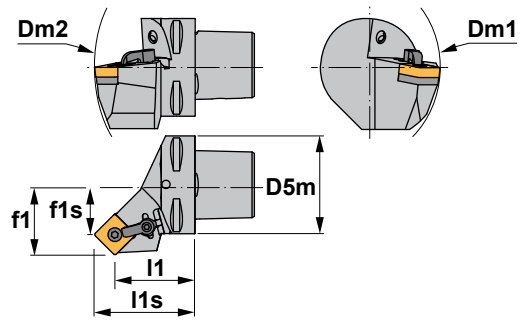

Eigenschaften:
Klemmhalter zum Außendreihen und Abschrägen mit einer vierkantigen negativen Wendeschneidplatte.
PSC mit Innenkühlung.

- 1) γ = Spanwinkel (Gültig nur mit flachen Wendeschneidplatte).
- 2) λ_s = Neigungswinkel.

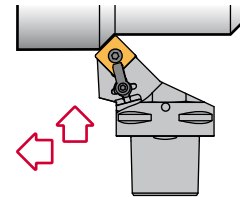

MSSN 45°

Reference Bezeichnung	D5m	Dm1 min.	Dm2 min.	f1	f1s	l1	l1s	γ^1	λ_s^2	Insert size Wendeschneidplatte	Kg
PSC32-MSSNR/L22040-12	32	60	124	22	13.7	40	48.3	-8°	0°	SNM.. 1204..	0,210
PSC40-MSSNR/L27042-12	40	110	140	27	18.7	42	50.3	-8°	0°	SNM.. 1204..	0,350
PSC50-MSSNR/L35052-12	50	110	165	35	26.7	52	60.3	-8°	0°	SNM.. 1204..	0,700
PSC63-MSSNR/L45056-12	63	110	190	45	36.7	56	64.3	-8°	0°	SNM.. 1204..	1,120
PSC40-MSSNR/L27045-15	40	125	145	27	16.8	45	55.2	-8°	0°	SNM.. 1506..	0,400
PSC50-MSSNR/L35050-15	50	125	165	35	24.8	50	60.2	-8°	0°	SNM.. 1506..	0,680
PSC63-MSSNR/L45054-15	63	125	190	45	34.8	54	64.2	-8°	0°	SNM.. 1506..	1,140
PSC50-MSSNR/L35048-19	50	125	165	35	22.5	48	60.5	-8°	0°	SNM.. 1906..	0,700
PSC63-MSSNR/L45052-19	63	125	190	45	32.5	52	64.5	-8°	0°	SNM.. 1906..	1,130

Reference Bezeichnung							Nm
PSC32-MSSNR/L22040-12	2613	1086	5003	ISSN-442	1657	5025	3.0
PSC40-MSSNR/L27042-12	2613	1086	5003	ISSN-442	1657	5025	3.0
PSC50-MSSNR/L35052-12	2613	1086	5003	ISSN-442	1657	5025	3.0
PSC63-MSSNR/L45056-12	2613	1086	5003	ISSN-442	1657	5025	3.0
PSC40-MSSNR/L27045-15	2614	1086	5003	ISSN-533	1673	5003	3.0
PSC50-MSSNR/L35050-15	2614	1086	5003	ISSN-533	1673	5003	3.0
PSC63-MSSNR/L45054-15	2614	1086	5003	ISSN-533	1673	5003	3.0
PSC50-MSSNR/L35048-19	2614	1086	5003	ISSN-633	1674	5004	3.0
PSC63-MSSNR/L45052-19	2614	1086	5003	ISSN-633	1674	5004	3.0

SNM.. Square negative inserts. Vierkantige negative Wendeschneidplatten. A41-42

Reference / Bez.	l	s	d
SNM.. 1204..	12,70	4,76	12,70
SNM.. 1506..	15,88	6,35	15,88
SNM.. 1906..	19,05	6,35	19,05

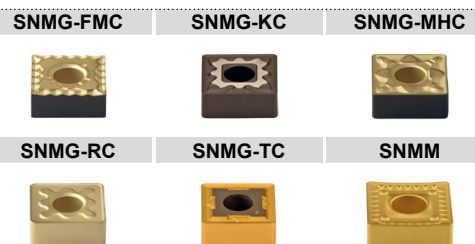
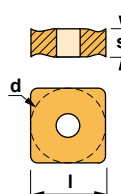



Characteristics:
Toolholder for face turning applications equipped with triangular negative inserts. PSC with internal coolant.

- 1) γ = Rake angle (valid with a flat insert).
- 2) λ_s = Angle of inclination.

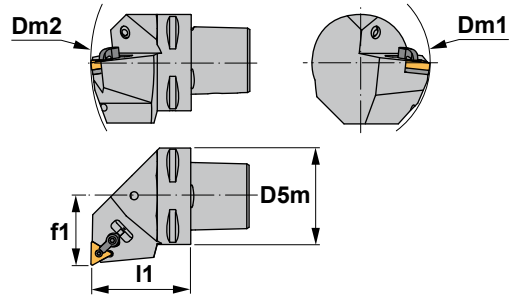

Eigenschaften:
Klemmhalter zum Plandrehen mit einer dreikantigen negativen Wendeschneidplatte. PSC mit Innenkühlung.

- 1) γ = Spanwinkel (Gültig nur mit flachen Wendeschneidplatte).
- 2) λ_s = Neigungswinkel.

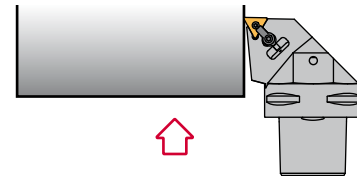

MTFN 90°

Reference Bezeichnung	D5m	Dm1 min.	Dm2 min.	f1	l1	γ^1	λ_s^2	Insert size Wendeschneidplatte	kg
PSC32-MTFNR/L22040-16	32	60	116	22	40	-6°	-6°	TNM.. 1604..	0,210
PSC40-MTFNR/L27050-16	40	110	140	27	50	-6°	-6°	TNM.. 1604..	0,420
PSC50-MTFNR/L35060-16	50	110	165	35	60	-6°	-6°	TNM.. 1604..	0,800
PSC63-MTFNR/L45065-16	63	110	190	45	65	-6°	-6°	TNM.. 1604..	1,100

Reference Bezeichnung							Nm
PSC32-MTFNR/L22040-16	2604	1085	5025	ITSN-342	1675	5002	2.0
PSC40-MTFNR/L27050-16	2604	1085	5025	ITSN-342	1675	5002	2.0
PSC50-MTFNR/L35060-16	2604	1085	5025	ITSN-342	1675	5002	2.0
PSC63-MTFNR/L45065-16	2604	1085	5025	ITSN-342	1675	5002	2.0

TNM.. Triangular negative inserts. Dreikantige negative WSP. A45-46

Reference / Bez.	l	s	d
TNM.. 1604..	16,50	4,76	9,52

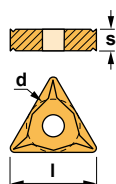



Characteristics:
Toolholder for external turning applications equipped with triangular negative inserts. PSC with internal coolant.

- 1) γ = Rake angle (valid with a flat insert).
- 2) λ_s = Angle of inclination.

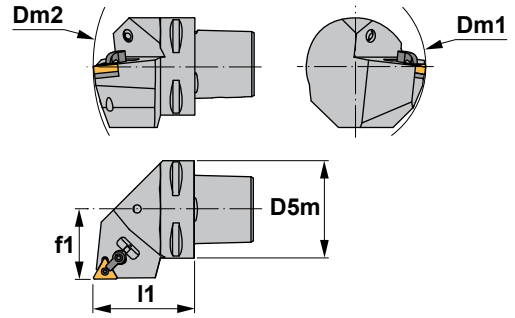

Eigenschaften:
Klemmhalter zum Außendrehen mit einer dreikantigen negativen Wendeschneidplatte. PSC mit Innenkühlung.

- 1) γ = Spanwinkel (Gültig nur mit flachen Wendeschneidplatte).
- 2) λ_s = Neigungswinkel.

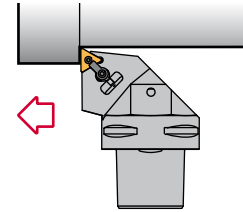

MTGN 90°

Reference Bezeichnung	D5m	Dm1 min.	Dm2 min.	f1	l1	γ^1	λ_s^2	Insert size Wendeschneidplatte	kg
PSC40-MTGNR/L27050-16	40	110	140	27	50	-6°	-6°	TNM.. 1604..	0,420
PSC50-MTGNR/L35060-16	50	110	165	35	60	-6°	-6°	TNM.. 1604..	0,800
PSC63-MTGNR/L45065-16	63	110	190	45	65	-6°	-6°	TNM.. 1604..	1,100
PSC63-MTGNR/L45065-22	63	110	190	45	65	-6°	-6°	TNM.. 2204..	1,100

Reference Bezeichnung							Nm
PSC40-MTGNR/L27050-16	2604	1085	5025	ITSN-342	1675	5002	2.0
PSC50-MTGNR/L35060-16	2604	1085	5025	ITSN-342	1675	5002	2.0
PSC63-MTGNR/L45065-16	2604	1085	5025	ITSN-342	1675	5002	2.0
PSC63-MTGNR/L45065-22	2613	1086	5003	ITSN-443	1657	5025	2.0

TNM..			
Triangular negative inserts. Dreikantige negative WSP. A45-46			
Reference / Bez.	l	s	d
TNM.. 1604..	16,50	4,76	9,52
TNM.. 2204..	22,00	4,76	12,70

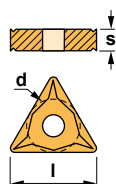



Characteristics:

Toolholder for external turning applications equipped with triangular negative inserts. PSC with internal coolant.

- 1) γ = Rake angle (valid with a flat insert).
- 2) λ_s = Angle of inclination.

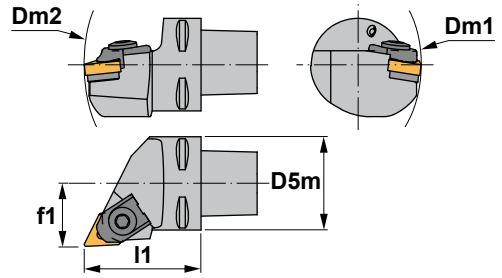

Eigenschaften:

Klemmhalter zum Außendrehen mit einer dreikantigen negativen Wendeschneidplatte. PSC mit Innenkühlung.

- 1) γ = Spanwinkel (Gültig nur mit flachen Wendeschneidplatte).
- 2) λ_s = Neigungswinkel.

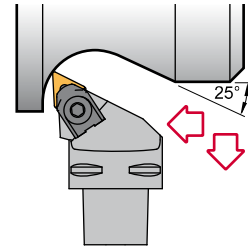

MTJN 93°

Reference Bezeichnung	D5m	Dm1 min.	Dm2 min.	f1	l1	γ^1	λ_s^2	Insert size Wendeschneidplatte	KG
PSC32-MTJNR/L22040-16	32	60	116	22	40	-6°	-6°	TNM.. 1604..	0,210
PSC40-MTJNR/L27050-16	40	110	140	27	50	-6°	-6°	TNM.. 1604..	0,420
PSC50-MTJNR/L35060-16	50	110	165	35	60	-6°	-6°	TNM.. 1604..	0,800
PSC63-MTJNR/L45065-16	63	110	190	45	65	-6°	-6°	TNM.. 1604..	1,100
PSC40-MTJNR/L27050-22	40	110	140	27	50	-6°	-6°	TNM.. 2204..	0,420
PSC50-MTJNR/L35060-22	50	110	165	35	60	-6°	-6°	TNM.. 2204..	0,800
PSC63-MTJNR/L45065-22	63	110	190	45	65	-6°	-6°	TNM.. 2204..	1,100

Reference Bezeichnung						Nm
PSC32-MTJNR/L22040-16	2014	5005	3414	1642	1393	4.0
PSC40-MTJNR/L27050-16	2014	5005	3414	1642	1393	4.0
PSC50-MTJNR/L35060-16	2014	5005	3414	1642	1393	4.0
PSC63-MTJNR/L45065-16	2014	5005	3414	1642	1393	4.0
PSC40-MTJNR/L27050-22	2024	5005	ITSN-433	1661	1394	4.0
PSC50-MTJNR/L35060-22	2024	5005	ITSN-433	1661	1394	4.0
PSC63-MTJNR/L45065-22	2024	5005	ITSN-433	1661	1394	4.0

TNM..	Triangular negative inserts. Dreikantige negative WSP. A45-46				TNMA	TNMG-CC	TNMG-FC	TNMG-FMC	TNMG-KC
	Reference / Bez.	l	s		d				
TNM.. 1604..	16,50	4,76	9,52						
TNM.. 2204..	22,00	4,76	12,70						





Characteristics:
Toolholder for very specific operations equipped with rhombic negative inserts (angle 35°).
PSC with internal coolant.

- 1) γ = Rake angle (valid with a flat insert).
- 2) λ_s = Angle of inclination.

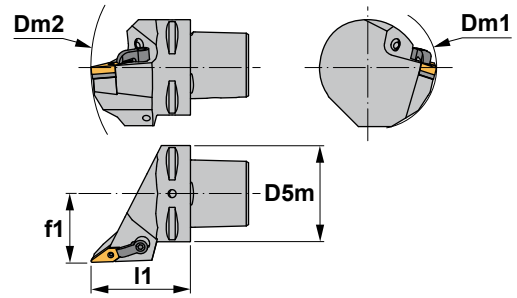

Eigenschaften:
Klemmhalter für sehr spezifische Anwendungen mit einer rhombischen negativen Wendeschneidplatte (Winkel 35°).
PSC mit Innenkühlung.

- 1) γ = Spanwinkel (Gültig nur mit flachen Wendeschneidplatte).
- 2) λ_s = Neigungswinkel.

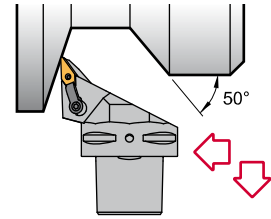

MVJN 93°

Reference Bezeichnung	D5m	Dm1 min.	Dm2 min.	f1	l1	γ^1	λ_s^2	Insert size Wendeschneidplatte	Kg
PSC40-MVJNR/L27062-16	40	60	152	27	62	-4°	-13°	VN.. 1604..	0,450
PSC50-MVJNR/L35065-16	50	65	170	35	65	-4°	-13°	VN.. 1604..	0,790
PSC63-MVJNR/L45065-16	63	81	190	45	65	-4°	-13°	VN.. 1604..	1,100
PSC80-MVJNR/L55080-16	80	100	250	55	80	-4°	-13°	VN.. 1604..	2,740

Reference Bezeichnung							Nm
PSC40-MVJNR/L27062-16	2604	1085	5025	IVSN-322	1665	5002	2.0
PSC50-MVJNR/L35065-16	2604	1085	5025	IVSN-322	1665	5002	2.0
PSC63-MVJNR/L45065-16	2604	1085	5025	IVSN-322	1665	5002	2.0
PSC80-MVJNR/L55080-16	2604	1085	5025	IVSN-322	1665	5002	2.0

VN.. 35° rhombic negative inserts. A49
35° rhombische negative Wendeschneidplatten.

Reference / Bez.	l	s	d
VN.. 1604..	16,50	4,76	9,52

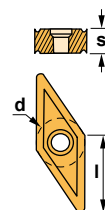

VNGP

VNMG



VNMG-TC



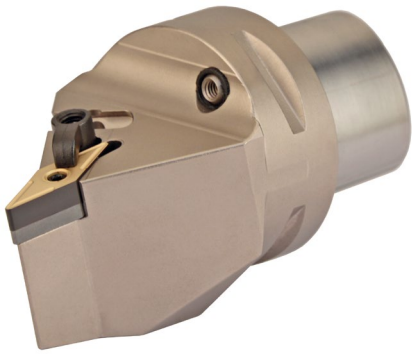

Characteristics:

Profiling toolholder equipped with rhombic negative double-sided insert (angle 35°). PSC with internal coolant.

- 1) γ = Rake angle (valid with a flat insert).
- 2) λ_s = Angle of inclination.

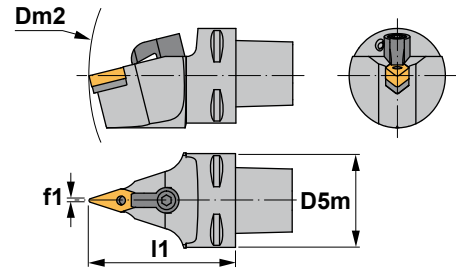

Eigenschaften:

Klemmhalter zum Drehen und Profildrehen mit einer doppelseitigen rhombischen negativen Wendeschneidplatte (Winkel 35°). PSC mit Innenkühlung.

- 1) γ = Spanwinkel (Gültig nur mit flachen Wendeschneidplatte).
- 2) λ_s = Neigungswinkel.

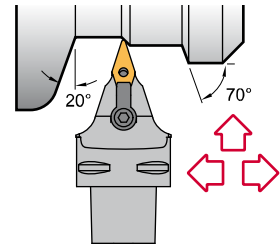

MVVN 72° 30'

Reference Bezeichnung	D5m	Dm2 min.	f1	I1	γ^1	λ_s^2	Insert size Wendeschneidplatte	KG
PSC40-MVVNN00062-16	40	152	0.6	62	-4°	-13°	VN.. 1604..	0,430
PSC50-MVVNN00065-16	50	170	0.6	65	-4°	-13°	VN.. 1604..	0,800
PSC63-MVVNN00065-16	63	190	0.6	65	-4°	-13°	VN.. 1604..	1,070
PSC80-MVVNN00080-16	80	250	0.6	80	-4°	-13°	VN.. 1604..	2,320

Reference Bezeichnung							Nm
PSC40-MVVNN00062-16	2604	1085	5025	IVSN-322	1665	5002	2.0
PSC50-MVVNN00065-16	2604	1085	5025	IVSN-322	1665	5002	2.0
PSC63-MVVNN00065-16	2604	1085	5025	IVSN-322	1665	5002	2.0
PSC80-MVVNN00080-16	2604	1085	5025	IVSN-322	1665	5002	2.0

VN..	35° rhombic negative inserts. 35° rhombische negative Wendeschneidplatten. A49		
Reference / Bez.	l	s	d
VN.. 1604..	16,50	4,76	9,52

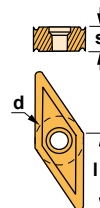

VNGP	VNMG
VNMG-TC	



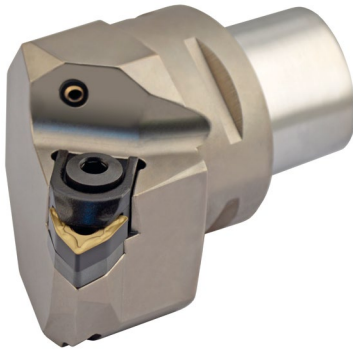

Characteristics:
Multipurpose toolholder equipped with trigon negative double-sided insert (angle 80°).
PSC with internal coolant.

- 1) γ = Rake angle (valid with a flat insert).
- 2) λ_s = Angle of inclination.

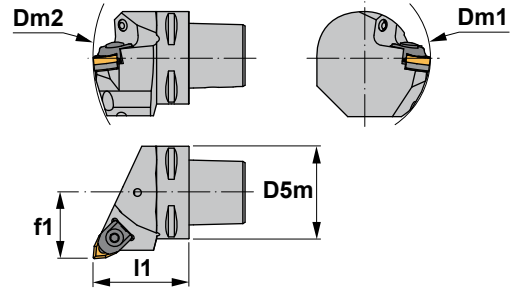

Eigenschaften:
Multifunktions-Klemmhalter mit einer doppelseitigen negativen Trigon-Wendeschneidplatte (Winkel 80°).
PSC mit Innenkühlung.

- 1) γ = Spanwinkel (Gültig nur mit flachen Wendeschneidplatte).
- 2) λ_s = Neigungswinkel.

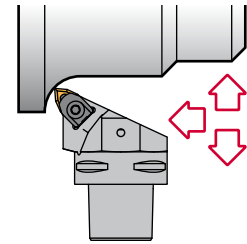

MWLN 95°

Reference Bezeichnung	D5m	Dm1 min.	Dm2 min.	f1	l1	γ 1)	λ_s 2)	Insert size Wendeschneidplatte	Kg
PSC32-MWLNR/L22040-06	32	60	116	22	40	-6°	-6°	WNMG 0604..	0,210
PSC40-MWLNR/L27050-06	40	60	140	27	50	-6°	-6°	WNMG 0604..	0,420
PSC40-MWLNR/L27050-08	40	110	140	27	50	-6°	-6°	WNMG 0804..	0,420
PSC50-MWLNR/L35060-08	50	110	165	35	60	-6°	-6°	WNMG 0804..	0,800
PSC63-MWLNR/L45065-08	63	110	190	45	65	-6°	-6°	WNMG 0804..	1,100
PSC80-MWLNR/L55080-08	80	110	250	55	80	-6°	-6°	WNMG 0804..	2,740

Reference Bezeichnung						Nm
PSC32-MWLNR/L22040-06	2006	5025	3006	1644	1813	2.0
PSC40-MWLNR/L27050-06	2006	5025	3006	1642	1393	2.0
PSC40-MWLNR/L27050-08	2011	5005	IWSN-433	1661	1394	4.0
PSC50-MWLNR/L35060-08	2011	5005	IWSN-433	1661	1394	4.0
PSC63-MWLNR/L45065-08	2011	5005	IWSN-433	1661	1394	4.0
PSC80-MWLNR/L55080-08	2011	5005	IWSN-433	1661	1394	4.0

WNMG 80° trigon negative inserts. A50-51 80° trigon negative Wendeschneidplatten.

Reference / Bez.	l	s	d
WNMG 0604..	6,45	4,76	9,52
WNMG 0804..	8,14	4,76	12,70

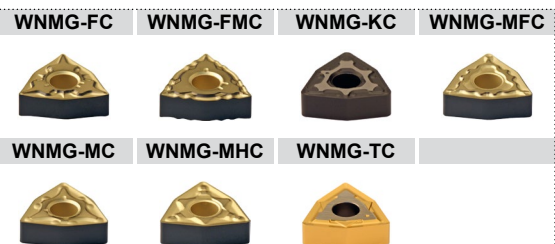
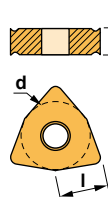



Characteristics:
Multipurpose toolholder equipped with rhombic negative double-sided insert (angle 80°). PSC with internal coolant.

- 1) γ = Rake angle (valid with a flat insert).
- 2) λ_s = Angle of inclination.

Eigenschaften:
Multifunktions-Klemmhalter mit einer doppelseitigen rhombischen Wendeschneidplatte (Winkel 80°). PSC mit Innenkühlung.

- 1) γ = Spanwinkel (Gültig nur mit flachen Wendeschneidplatte).
- 2) λ_s = Neigungswinkel.

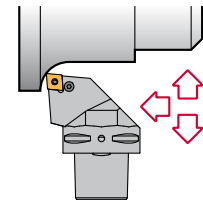
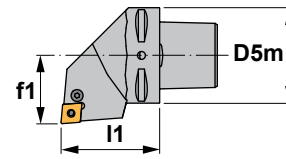
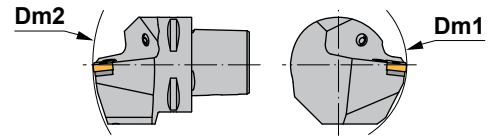

PCLN 95°

Reference Bezeichnung	D5m	Dm1 min.	Dm2 min.	f1	l1	γ^1	λ_s^2	Insert size Wendeschneidplatte	kg
PSC32-PCLNR/L22040-12	32	60	124	22	40	-6°	-6°	CN.. 1204..	0,210
PSC40-PCLNR/L27050-12	40	110	140	27	50	-6°	-6°	CN.. 1204..	0,420
PSC50-PCLNR/L35060-12	50	110	165	35	60	-6°	-6°	CN.. 1204..	0,800
PSC63-PCLNR/L45065-12	63	110	190	45	65	-6°	-6°	CN.. 1204..	1,100
PSC80-PCLNR/L55080-12	80	110	250	55	80	-6°	-6°	CN.. 1204..	2,740
PSC40-PCLNR/L27050-16	40	125	140	27	50	-6°	-6°	CN.. 1606..	0,420
PSC50-PCLNR/L35060-16	50	125	165	35	60	-6°	-6°	CN.. 1606..	0,800
PSC63-PCLNR/L45065-16	63	125	190	45	65	-6°	-6°	CN.. 1606..	1,100
PSC80-PCLNR/L55080-16	80	125	250	55	80	-6°	-6°	CN.. 1606..	2,740
PSC50-PCLNR/L35060-19	50	125	165	35	60	-6°	-6°	CN.. 1906..	0,800
PSC63-PCLNR/L45065-19	63	125	190	45	65	-6°	-6°	CN.. 1906..	1,100
PSC80-PCLNR/L55080-19	80	125	250	55	80	-6°	-6°	CN.. 1906..	2,740
PSC80-PCLNR/L55080-25	80	150	250	55	80	-6°	-6°	CN.. 2509..	2,740

Reference Bezeichnung							Nm
PSC32-PCLNR/L22040-12	8012	1608	5003	3612	4112	0012	3.0
PSC40-PCLNR/L27050-12	8012	1608	5003	3612	4112	0012	3.0
PSC50-PCLNR/L35060-12	8012	1608	5003	3612	4112	0012	3.0
PSC63-PCLNR/L45065-12	8012	1608	5003	3612	4112	0012	3.0
PSC80-PCLNR/L55080-12	8012	1608	5003	3612	4112	0012	3.0
PSC40-PCLNR/L27050-16	8016	1618	5003	3616	4115	0015	3.0
PSC50-PCLNR/L35060-16	8016	1618	5003	3616	4115	0015	3.0
PSC63-PCLNR/L45065-16	8016	1618	5003	3616	4115	0015	3.0
PSC80-PCLNR/L55080-16	8016	1618	5003	3616	4115	0015	3.0
PSC50-PCLNR/L35060-19	8019	1610	5004	3619	4119	0019	3.5
PSC63-PCLNR/L45065-19	8019	1610	5004	3619	4119	0019	3.5
PSC80-PCLNR/L55080-19	8019	1610	5004	3619	4119	0019	3.5
PSC80-PCLNR/L55080-25	8025	1612	5005	3625	4125	0025	4.0

CN.. 80° rhombic negative inserts. A32-34
80° rhombische negative WSP.

Reference / Bez.	l	s	d
CN.. 1204..	12,90	4,76	12,70
CN.. 1606..	16,10	6,35	15,88
CN.. 1906..	19,30	6,35	19,05
CN.. 2509..	25,80	9,52	25,40

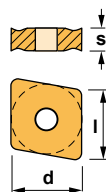

CNMG-CC CNMG-FC CNMG-FMC CNMG-KC CNMG-MC



CNMG-MFC CNMG-MHC CNMG-RC CNMG-TC CNMM



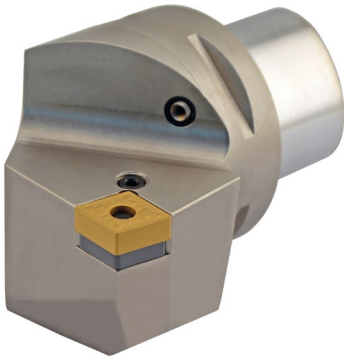

Characteristics:
Multipurpose toolholder equipped with rhombic negative double-sided insert (angle 80°).
PSC with internal coolant.

- 1) γ = Rake angle (valid with a flat insert).
- 2) λ_s = Angle of inclination.

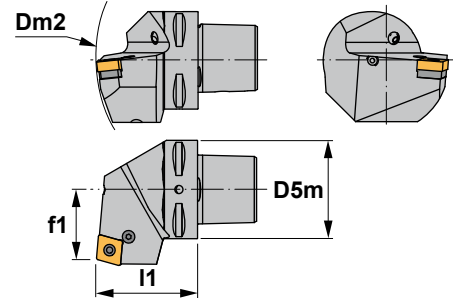

Eigenschaften:
Multifunktions-Werkzeuge mit einer doppelseitigen rhombischen negativen Wendeschneidplatte (Winkel 80°).
PSC mit Innenkühlung.

- 1) γ = Spanwinkel (Gültig nur mit flachen Wendeschneidplatte).
- 2) λ_s = Neigungswinkel.

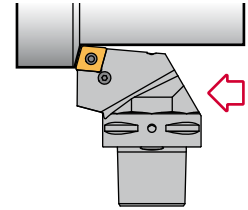

PCRN 75°

Reference Bezeichnung	D5m	Dm2 min.	f1	l1	γ^1	λ_s^2	Insert size Wendeschneidplatte	kg
PSC50-PCRN/L27060-12	50	165	27	60	-6°	-6°	CN.. 1204..	0,800
PSC63-PCRN/L35065-12	63	190	35	65	-6°	-6°	CN.. 1204..	1,400
PSC50-PCRN/L27060-16	50	165	27	60	-6°	-6°	CN.. 1606..	0,800
PSC63-PCRN/L35065-16	63	190	35	65	-6°	-6°	CN.. 1606..	1,400
PSC50-PCRN/L27060-19	50	165	27	60	-6°	-6°	CN.. 1906..	0,800
PSC63-PCRN/L35065-19	63	190	35	65	-6°	-6°	CN.. 1906..	1,400

Reference Bezeichnung							Nm
PSC50-PCRN/L27060-12	8012	1608	5003	3612	4112	0012	3.0
PSC63-PCRN/L35065-12	8012	1608	5003	3612	4112	0012	3.0
PSC50-PCRN/L27060-16	8016	1618	5003	3616	4115	0015	3.0
PSC63-PCRN/L35065-16	8016	1618	5003	3616	4115	0015	3.0
PSC50-PCRN/L27060-19	8019	1610	5004	3619	4119	0019	3.5
PSC63-PCRN/L35065-19	8019	1610	5004	3619	4119	0019	3.5

CN.. 80° rhombic negative inserts. 80° rhombische negative WSP. A32-34

Reference / Bez.	l	s	d
CN.. 1204..	12,90	4,76	12,70
CN.. 1606..	16,10	6,35	15,88
CN.. 1906..	19,30	6,35	19,05

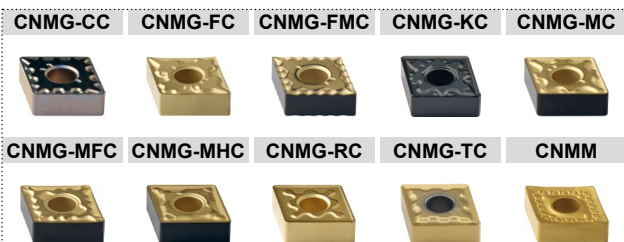
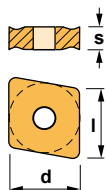



Characteristics:
Turning and profiling toolholder equipped with rhombic negative double-sided insert (angle 55°).
PSC with internal coolant.

- 1) γ = Rake angle (valid with a flat insert).
- 2) λ_s = Angle of inclination.

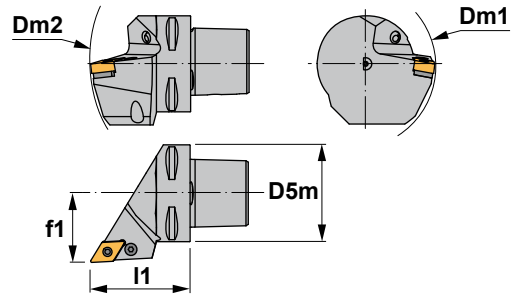

Eigenschaften:
Klemmhalter zum Drehen und Kopierdrehen mit einer doppelseitigen rhombischen negativen Wendeschneidplatte (Winkel 55°).
PSC mit Innenkühlung.

- 1) γ = Spanwinkel (Gültig nur mit flachen Wendeschneidplatte).
- 2) λ_s = Neigungswinkel.

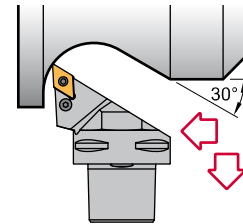

PDJN 93°

Reference Bezeichnung	D5m	Dm1 min.	Dm2 min.	f1	l1	γ^1	λ_s^2	Insert size Wendeschneidplatte	Kg
PSC50-PDJNR/L35060-11	50	110	165	35	60	-6°	-7°	DN.. 1104..	0,800
PSC40-PDJNR/L27055-15	40	110	145	27	55	-6°	-7°	DN.. 1506..	0,430
PSC50-PDJNR/L35060-15	50	110	165	35	60	-6°	-7°	DN.. 1506..	0,800
PSC63-PDJNR/L45065-15	63	110	190	45	65	-6°	-7°	DN.. 1506..	1,100
PSC80-PDJNR/L55080-15	80	110	250	55	80	-6°	-7°	DN.. 1506..	2,740

Reference Bezeichnung										Nm
PSC50-PDJNR/L35060-11	8009	1606	5025	3711	4109	0009	-	-	-	2.0
PSC40-PDJNR/L27055-15	8415	1638	5003	3715	4112	0012	3725	4135	3725 4135	3.0
PSC50-PDJNR/L35060-15	8415	1638	5003	3715	4112	0012	3725	4135	3725 4135	3.0
PSC63-PDJNR/L45065-15	8415	1638	5003	3715	4112	0012	3725	4135	3725 4135	3.0
PSC80-PDJNR/L55080-15	8415	1638	5003	3715	4112	0012	3725	4135	3725 4135	3.0

For inserts DNM.. 1504..
Für Wendeschneidplatten DNM.. 1504

DN..	55° rhombic negative inserts. 55° rhombische negative Wendeschneidplatten. A36-37		
Reference / Bez.	l	s	d
DN.. 1104..	11,60	4,76	9,52
DN.. 1504..	15,50	4,76	12,70
DN.. 1506..	15,50	6,35	12,70

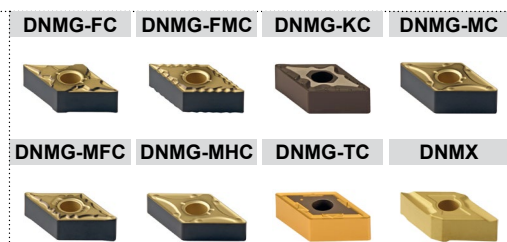
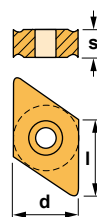



Characteristics:
Turning and profiling toolholder equipped with rhombic negative double-sided insert (angle 55°).
PSC with internal coolant.

- 1) γ = Rake angle (valid with a flat insert).
- 2) $\lambda.s$ = Angle of inclination.

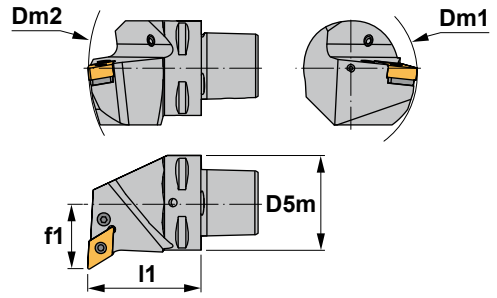

Eigenschaften:
Klemmhalter zum Drehen und Profildrehen mit einer doppelseitigen rhombischen negativen Wendeschneidplatte (Winkel 55°).
PSC mit Innenkühlung.

- 1) γ = Spanwinkel (Gültig nur mit flachen Wendeschneidplatte).
- 2) $\lambda.s$ = Neigungswinkel.

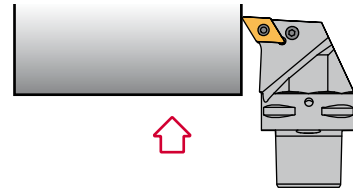

PDUN 93°

Reference Bezeichnung	D5m	Dm1 min.	Dm2 min.	f1	l1	γ^1	$\lambda.s^2$	Insert size Wendeschneidplatte	
PSC40-PDUNR/L27050-15	40	110	140	27	50	-6°	-7°	DN.. 1506..	0,420
PSC50-PDUNR/L35060-15	50	110	165	35	60	-6°	-7°	DN.. 1506..	0,800
PSC63-PDUNR/L45065-15	63	110	190	45	65	-6°	-7°	DN.. 1506..	1,100
PSC80-PDUNR/L55080-15	80	110	250	55	80	-6°	-7°	DN.. 1506..	2,740

Reference Bezeichnung										Nm
PSC40-PDUNR/L27050-15	8415	1638	5003	3715	4112	0012	3725	4135		3.0
PSC50-PDUNR/L35060-15	8415	1638	5003	3715	4112	0012	3725	4135		3.0
PSC63-PDUNR/L45065-15	8415	1638	5003	3715	4112	0012	3725	4135		3.0
PSC80-PDUNR/L55080-15	8415	1638	5003	3715	4112	0012	3725	4135		3.0

For inserts DNM.. 1504..
Für Wendeschneidplatten DNM.. 1504

DN.. 55° rhombic negative inserts. A36-37
55° rhombische negative Wendeschneidplatten.

Reference / Bez.	l	s	d
DN.. 1506..	15,50	6,35	12,70

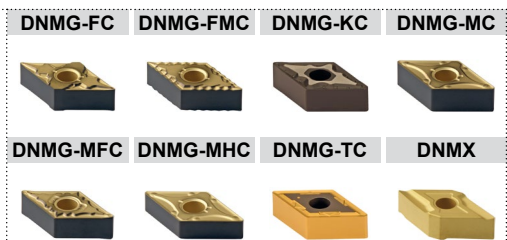
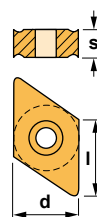



Characteristics:

Profiling toolholder equipped with round positive insert. PSC with internal coolant.

- 1) γ = Rake angle (valid with a flat insert).
- 2) λ_s = Angle of inclination.

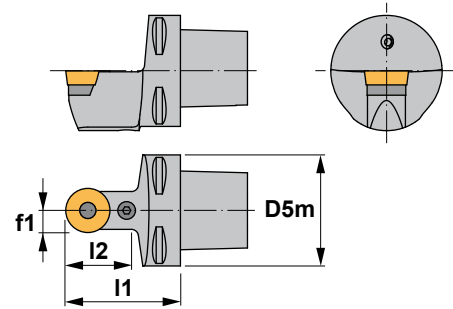

Eigenschaften:

Klemmhalter zum Profildrehen mit einer runden positiven Wendeschneidplatte.
PSC mit Innenkühlung.

- 1) γ = Spanwinkel (Gültig nur mit flachen Wendeschneidplatte).
- 2) λ_s = Neigungswinkel.

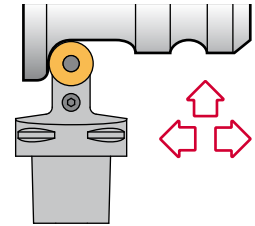

PRDC

Reference Bezeichnung	D5m	f1	l1	γ^1	λ_s^2	l2	Insert size Wendeschneidplatte	Kg
PSC63-PRDCN00065-25	63	12.5	65	0°	0°	40	RC.. 2507M0	1,070
PSC80-PRDCN00080-25	80	12.5	80	0°	0°	40	RC.. 2507M0	2,320
PSC80-PRDCN00080-32	80	16.0	80	0°	0°	45	RC.. 3209M0	2,320

Reference Bezeichnung							Nm
PSC63-PRDCN00065-25	8125	1710	5004	3825	4119	0019	3.5
PSC80-PRDCN00080-25	8125	1710	5004	3825	4119	0019	3.5
PSC80-PRDCN00080-32	8132	1612	5005	3832	4125	0025	4.0

RC..

Round positive inserts with 7° clearance. A38-39
Runde positive Wendeschneidplatten mit 7° Freiwinkel.

Reference / Bez.	s	d
RC.. 2507M0	7,94	25,00
RC.. 3209M0	9,52	32,00

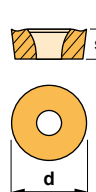

RCGT-AL



RCGT-AP



RCMT



**Characteristics:**

Profiling toolholder equipped with round positive insert. PSC with internal coolant.

- 1) γ = Rake angle (valid with a flat insert).
- 2) λs = Angle of inclination.

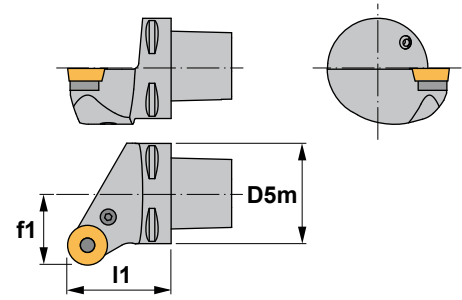
**Eigenschaften:**





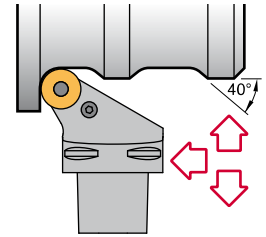

Klemmhalter zum Profildrehen mit einer runden positiven Wendschneidplatten. PSC mit Innenkühlung.

- 1) γ = Spanwinkel (Gültig nur mit flachen Wendschneidplatte).
- 2) λs = Neigungswinkel.



PRSC

Reference Bezeichnung	D5m	f1	l1	γ^1	λs^2	Insert size Wendschneidplatte	
PSC80-PRSCR/L55080-20	80	55	80	0°	0°	RC.. 2006M0	2,740
PSC63-PRSCR/L45065-25	63	45	65	0°	0°	RC.. 2507M0	1,100
PSC80-PRSCR/L55080-25	80	55	80	0°	0°	RC.. 2507M0	2,740
PSC80-PRSCR/L55080-32	80	55	80	0°	0°	RC.. 3209M0	2,740

Reference Bezeichnung							Nm
PSC80-PRSCR/L55080-20	8120	1708	5003	3820	4115	0015	3.0
PSC63-PRSCR/L45065-25	8125	1710	5004	3825	4119	0019	3.5
PSC80-PRSCR/L55080-25	8125	1710	5004	3825	4119	0019	3.5
PSC80-PRSCR/L55080-32	8132	1612	5005	3832	4125	0025	4.0

RC..

Round positive inserts with 7° clearance.  A38-39
Runde positive Wendschneidplatten mit 7° Freiwinkel.

Reference / Bez.	s	d
RC.. 2006M0	6,35	20,00
RC.. 2507M0	7,94	25,00
RC.. 3209M0	9,52	32,00

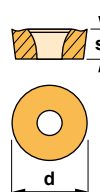
**RCGT-AL****RCGT-AP****RCMT**



Characteristics:

Toolholder for external turning and chamfering applications equipped with square negative inserts.

PSC with internal coolant.

- 1) γ = Rake angle (valid with a flat insert).
- 2) λ_s = Angle of inclination.

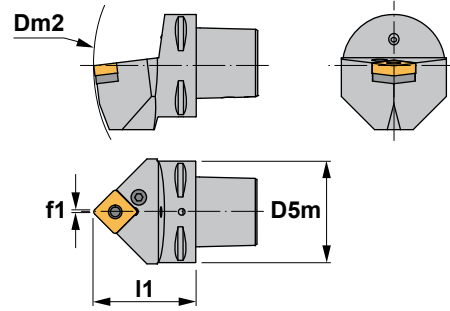

Eigenschaften:

Klemmhalter zum Außendreihen und Abschrägen mit einer vierkantigen negativen Wendeschneidplatte.

PSC mit Innenkühlung.

- 1) γ = Spanwinkel (Gültig nur mit flachen Wendeschneidplatte).
- 2) λ_s = Neigungswinkel.

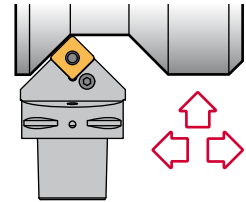

PSDN 45°

Reference Bezeichnung	D5m	Dm2 min.	f1	l1	γ 1)	λ_s 2)	Insert size Wendeschneidplatte	KG
PSC40-PSDNN00050-12	40	140	0.3	50	-6°	-6°	SNM.. 1204..	0,350
PSC50-PSDNN00060-12	50	165	0.3	60	-6°	-6°	SNM.. 1204..	0,750
PSC63-PSDNN00065-12	63	190	0.3	65	-6°	-6°	SNM.. 1204..	1,070
PSC40-PSDNN00050-15	40	140	0.5	50	-6°	-6°	SNM.. 1506..	0,350
PSC50-PSDNN00060-15	50	165	0.5	60	-6°	-6°	SNM.. 1506..	0,750
PSC63-PSDNN00065-15	63	190	0.5	65	-6°	-6°	SNM.. 1506..	1,070
PSC50-PSDNN00060-19	50	170	0.5	60	-6°	-6°	SNM.. 1906..	0,750
PSC63-PSDNN00065-19	63	195	0.5	65	-6°	-6°	SNM.. 1906..	1,070
PSC63-PSDNN00065-25	63	195	1.0	65	-6°	-6°	SNM.. 2507..	1,070
PSC80-PSDNN00080-25	80	250	1.0	80	-6°	-6°	SNM.. 2507..	2,320

Reference Bezeichnung							Nm
PSC40-PSDNN00050-12	8012	1608	5003	3512	4112	0012	3.0
PSC50-PSDNN00060-12	8012	1608	5003	3512	4112	0012	3.0
PSC63-PSDNN00065-12	8012	1608	5003	3512	4112	0012	3.0
PSC40-PSDNN00050-15	8016	1618	5003	3515	4115	0015	3.0
PSC50-PSDNN00060-15	8016	1618	5003	3515	4115	0015	3.0
PSC63-PSDNN00065-15	8016	1618	5003	3515	4115	0015	3.0
PSC50-PSDNN00060-19	8019	1610	5004	3519	4119	0019	3.5
PSC63-PSDNN00065-19	8019	1610	5004	3519	4119	0019	3.5
PSC63-PSDNN00065-25	8025	1612	5005	3525	4125	0025	4.0
PSC80-PSDNN00080-25	8025	1612	5005	3525	4125	0025	4.0

SNM.. Square negative inserts. Vierkantige negative Wendeschneidplatten. A41-42

Reference / Bez.	l	s	d
SNM.. 1204..	12,70	4,76	12,70
SNM.. 1506..	15,88	6,35	15,88
SNM.. 1906..	19,05	6,35	19,05
SNM.. 2507..	25,40	7,94	25,40

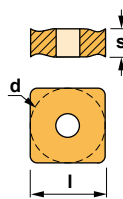

SNMG-FMC	SNMG-KC	SNMG-MHC
SNMG-RC	SNMG-TC	SNMM





Characteristics:
Toolholder for face turning applications equipped with square negative inserts.
PSC with internal coolant.

- 1) γ = Rake angle (valid with a flat insert).
- 2) λ_s = Angle of inclination.

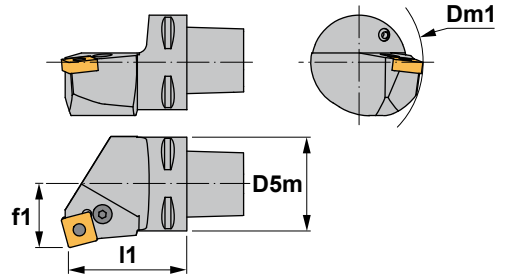

Eigenschaften:
Klemmhalter zum Plandrehen mit einer vierkantigen negativen Wendeschneidplatte.
PSC mit Innenkühlung.

- 1) γ = Spanwinkel (Gültig nur mit flachen Wendeschneidplatte).
- 2) λ_s = Neigungswinkel.

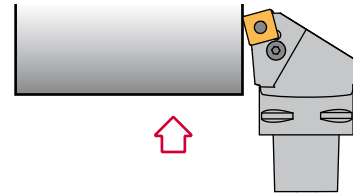

PSKN 75°

Reference Bezeichnung	D5m	Dm1 min.	f1	l1	γ^1	λ_s^2	Insert size Wendeschneidplatte	
PSC40-PSKNR/L27050-12	40	110	27	50	-6°	-6°	SNM.. 1204..	0,420
PSC50-PSKNR/L35060-12	50	110	35	60	-6°	-6°	SNM.. 1204..	0,800
PSC63-PSKNR/L45065-12	63	110	45	65	-6°	-6°	SNM.. 1204..	1,100
PSC50-PSKNR/L35060-15	50	125	35	60	-6°	-6°	SNM.. 1506..	0,800
PSC63-PSKNR/L45065-15	63	125	45	65	-6°	-6°	SNM.. 1506..	1,100
PSC50-PSKNR/L35060-19	50	125	35	60	-6°	-6°	SNM.. 1906..	0,800
PSC63-PSKNR/L45065-19	63	125	45	65	-6°	-6°	SNM.. 1906..	1,100
PSC80-PSKNR/L55080-19	80	125	55	80	-6°	-6°	SNM.. 1906..	2,740
PSC80-PSKNR/L55080-25	80	150	55	80	-6°	-6°	SNM.. 2507..	2,740

Reference Bezeichnung							Nm
PSC40-PSKNR/L27050-12	8012	1608	5003	3512	4112	0012	3.0
PSC50-PSKNR/L35060-12	8012	1608	5003	3512	4112	0012	3.0
PSC63-PSKNR/L45065-12	8012	1608	5003	3512	4112	0012	3.0
PSC50-PSKNR/L35060-15	8016	1618	5003	3515	4115	0015	3.0
PSC63-PSKNR/L45065-15	8016	1618	5003	3515	4115	0015	3.0
PSC50-PSKNR/L35060-19	8019	1610	5004	3519	4119	0019	3.5
PSC63-PSKNR/L45065-19	8019	1610	5004	3519	4119	0019	3.5
PSC80-PSKNR/L55080-19	8019	1610	5004	3519	4119	0019	3.5
PSC80-PSKNR/L55080-25	8025	1612	5005	3525	4125	0025	4.0

SNM.. Square negative inserts. Vierkantige negative Wendeschneidplatten. A41-42

Reference / Bez.	l	s	d
SNM.. 1204..	12,70	4,76	12,70
SNM.. 1506..	15,88	6,35	15,88
SNM.. 1906..	19,05	6,35	19,05
SNM.. 2507..	25,40	7,94	25,40

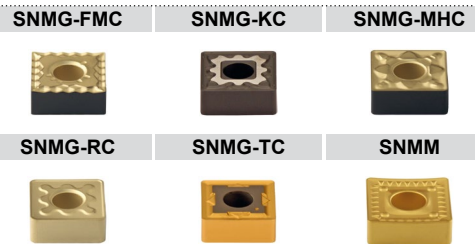
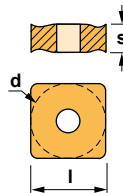



Characteristics:
Toolholder for face turning applications equipped with square negative inserts.
PSC with internal coolant.

- 1) γ = Rake angle (valid with a flat insert).
- 2) λ_s = Angle of inclination.

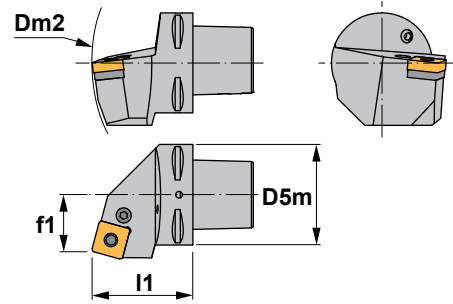

Eigenschaften:
Klemmhalter zum Plandrehen mit einer vierkantigen negativen Wendeschneidplatte.
PSC mit Innenkühlung.

- 1) γ = Spanwinkel (Gültig nur mit flachen Wendeschneidplatte).
- 2) λ_s = Neigungswinkel.

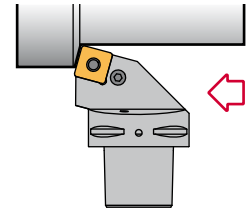

PSRN 75°

Reference Bezeichnung	D5m	Dm2 min.	f1	l1	γ^1	λ_s^2	Insert size Wendeschneidplatte	KG
PSC32-PSRNR/L17040-12	32	124	17	40	-6°	-6°	SNM.. 1204..	0,200
PSC40-PSRNR/L22050-12	40	140	22	50	-6°	-6°	SNM.. 1204..	0,420
PSC50-PSRNR/L27060-12	50	165	27	60	-6°	-6°	SNM.. 1204..	0,800
PSC63-PSRNR/L35065-12	63	190	35	65	-6°	-6°	SNM.. 1204..	1,400
PSC50-PSRNR/L27060-15	50	165	27	60	-6°	-6°	SNM.. 1506..	0,800
PSC63-PSRNR/L35065-15	63	190	35	65	-6°	-6°	SNM.. 1506..	1,400
PSC50-PSRNR/L27060-19	50	165	27	60	-6°	-6°	SNM.. 1906..	0,800
PSC63-PSRNR/L35065-19	63	190	35	65	-6°	-6°	SNM.. 1906..	1,400
PSC80-PSRNR/L45080-19	80	250	45	80	-6°	-6°	SNM.. 1906..	2,800
PSC80-PSRNR/L45080-25	80	250	45	80	-6°	-6°	SNM.. 2507..	2,800

Reference Bezeichnung							Nm
PSC32-PSRNR/L17040-12	8012	1608	5003	3512	4112	0012	3.0
PSC40-PSRNR/L22050-12	8012	1608	5003	3512	4112	0012	3.0
PSC50-PSRNR/L27060-12	8012	1608	5003	3512	4112	0012	3.0
PSC63-PSRNR/L35065-12	8012	1608	5003	3512	4112	0012	3.0
PSC50-PSRNR/L27060-15	8016	1618	5003	3515	4115	0015	3.0
PSC63-PSRNR/L35065-15	8016	1618	5003	3515	4115	0015	3.0
PSC50-PSRNR/L27060-19	8019	1610	5004	3519	4119	0019	3.5
PSC63-PSRNR/L35065-19	8019	1610	5004	3519	4119	0019	3.5
PSC80-PSRNR/L45080-19	8019	1610	5004	3519	4119	0019	3.5
PSC80-PSRNR/L45080-25	8025	1612	5005	3525	4125	0025	4.0

SNM.. Square negative inserts. Vierkantige negative Wendeschneidplatten. A41-42

Reference / Bez.	l	s	d
SNM.. 1204..	12,70	4,76	12,70
SNM.. 1506..	15,88	6,35	15,88
SNM.. 1906..	19,05	6,35	19,05
SNM.. 2507..	25,40	7,94	25,40

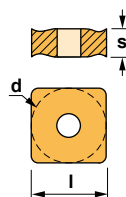

SNMG-FMC	SNMG-KC	SNMG-MHC
SNMG-RC	SNMG-TC	SNMM





Characteristics:
Toolholder for external turning and chamfering applications equipped with square negative inserts.
PSC with internal coolant.

- 1) γ = Rake angle (valid with a flat insert).
- 2) λ_s = Angle of inclination.

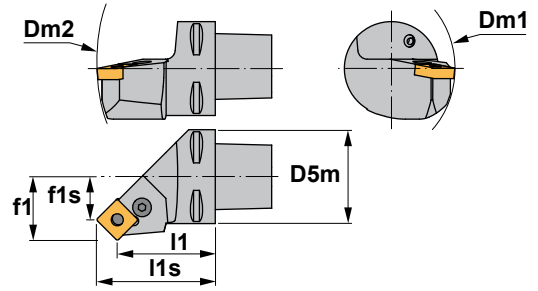

Eigenschaften:
Klemmhalter zum Außendreien und Abschrägen mit einer vierkantigen negativen Wendeschneidplatte.
PSC mit Innenkühlung.

- 1) γ = Spanwinkel (Gültig nur mit flachen Wendeschneidplatte).
- 2) λ_s = Neigungswinkel.

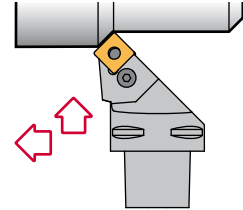

PSSN 45°

Reference Bezeichnung	D5m	Dm1 min.	Dm2 min.	f1	f1s	l1	l1s	γ^1	λ_s^2	Insert size Wendeschneidplatte	kg
PSC32-PSSNR/L22032-12	32	60	124	22	13.7	32	40.3	-8°	0°	SNM.. 1204..	0,180
PSC40-PSSNR/L27042-12	40	110	140	27	18.7	42	50.3	-8°	0°	SNM.. 1204..	0,350
PSC50-PSSNR/L35052-12	50	110	165	35	26.7	52	60.3	-8°	0°	SNM.. 1204..	0,700
PSC63-PSSNR/L45056-12	63	110	190	45	36.7	56	64.3	-8°	0°	SNM.. 1204..	1,120
PSC63-PSSNR/L45054-15	63	125	190	45	34.8	54	64.2	-8°	0°	SNM.. 1506..	1,140
PSC63-PSSNR/L45052-19	63	125	190	45	32.5	52	64.5	-8°	0°	SNM.. 1906..	1,130
PSC80-PSSNR/L55070-25	80	150	256	55	39.0	70	86.0	-8°	0°	SNM.. 2507..	2,620

Reference Bezeichnung							Nm
PSC32-PSSNR/L22032-12	8012	1608	5003	3512	4112	0012	3.0
PSC40-PSSNR/L27042-12	8012	1608	5003	3512	4112	0012	3.0
PSC50-PSSNR/L35052-12	8012	1608	5003	3512	4112	0012	3.0
PSC63-PSSNR/L45056-12	8012	1608	5003	3512	4112	0012	3.0
PSC63-PSSNR/L45054-15	8016	1618	5003	3515	4115	0015	3.0
PSC63-PSSNR/L45052-19	8019	1610	5004	3519	4119	0019	3.5
PSC80-PSSNR/L55070-25	8025	1612	5005	3525	4125	0025	4.0

SNM.. Square negative inserts. Vierkantige negative Wendeschneidplatten. A41-42

Reference / Bez.	l	s	d
SNM.. 1204..	12,70	4,76	12,70
SNM.. 1506..	15,88	6,35	15,88
SNM.. 1906..	19,05	6,35	19,05
SNM.. 2507..	25,40	7,94	25,40

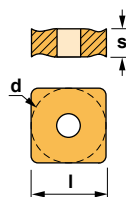

SNMG-FMC SNMG-KC SNMG-MHC



SNMG-RC SNMG-TC SNMM





Characteristics:
Multipurpose toolholder equipped with rhombic positive insert (angle 80°).
PSC with internal coolant.

- 1) γ = Rake angle (valid with a flat insert).
- 2) λ_s = Angle of inclination.

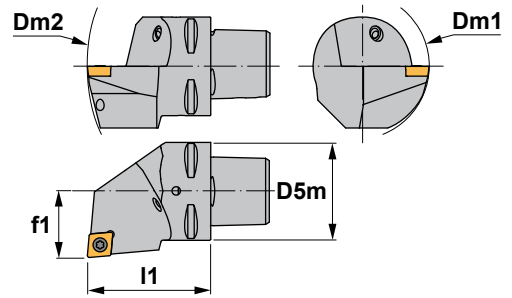

Eigenschaften:
Multifunktions-Klemmhalter mit einer rhombischen positiven Wendeschneidplatte (80° Winkel).
PSC mit Innenkühlung.

- 1) γ = Spanwinkel (Gültig nur mit flachen Wendeschneidplatte).
- 2) λ_s = Neigungswinkel.

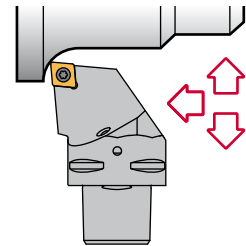

SCLC 95°

Reference Bezeichnung	D5m	Dm1 min.	Dm2 min.	f1	l1	γ^1	λ_s^2	Insert size Wendeschneidplatte	
PSC32-SCLCR/L22040-09	32	80	124	22	40	0°	0°	CC.. 09T3..	0,210
PSC40-SCLCR/L27050-09	40	80	140	27	50	0°	0°	CC.. 09T3..	0,420
PSC50-SCLCR/L35060-09	50	80	165	35	60	0°	0°	CC.. 09T3..	0,800
PSC63-SCLCR/L45065-09	63	80	190	45	65	0°	0°	CC.. 09T3..	1,100
PSC32-SCLCR/L22040-12	32	110	124	22	40	0°	0°	CC.. 1204..	0,210
PSC40-SCLCR/L27050-12	40	110	140	27	50	0°	0°	CC.. 1204..	0,420
PSC50-SCLCR/L35060-12	50	110	165	35	60	0°	0°	CC.. 1204..	0,800
PSC63-SCLCR/L45065-12	63	110	190	45	65	0°	0°	CC.. 1204..	1,100

Reference Bezeichnung					Nm
PSC32-SCLCR/L22040-09	1240	5515	-	-	3.0
PSC40-SCLCR/L27050-09	1240	5515	-	-	3.0
PSC50-SCLCR/L35060-09	1240	5515	-	-	3.0
PSC63-SCLCR/L45065-09	1240	5515	-	-	3.0
PSC32-SCLCR/L22040-12	1540	5517	3614	1760	3.0
PSC40-SCLCR/L27050-12	1540	5517	3614	1760	3.0
PSC50-SCLCR/L35060-12	1540	5517	3614	1760	3.0
PSC63-SCLCR/L45065-12	1540	5517	3614	1760	3.0

CC.. 80° rhombic positive inserts with 7° clearance. A30-31
80° rhombische positive Wendeschneidplatten mit 7° Freiwinkel.

Reference / Bez.	l	s	d
CC.. 09T3..	9,65	3,97	9,52
CC.. 1204..	12,90	4,76	12,70

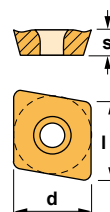

CCGT-AL



CCGT-AP



CCMT



CCMW





Characteristics:
Multipurpose toolholder equipped with rhombic positive insert (angle 55°).
PSC with internal coolant.

- 1) γ = Rake angle (valid with a flat insert).
- 2) λ_s = Angle of inclination.

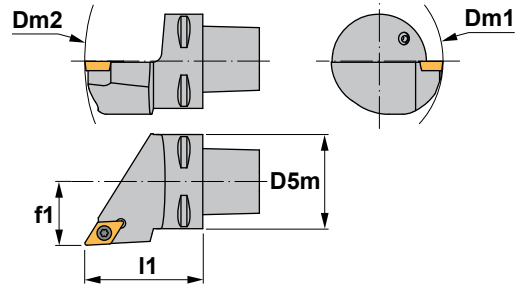

Eigenschaften:
Multifunktions-Klemmhalter mit einer rhombischen positiven Wendeschneidplatte (55° Winkel).
PSC mit Innenkühlung.

- 1) γ = Spanwinkel (Gültig nur mit flachen Wendeschneidplatte).
- 2) λ_s = Neigungswinkel.

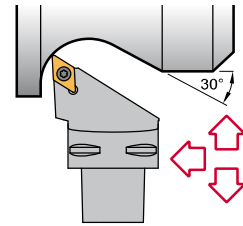

SDJC 93°

Reference Bezeichnung	D5m	Dm1 min.	Dm2 min.	f1	l1	γ^1	λ_s^2	Insert size Wendeschneidplatte	Kg
PSC32-SDJCR/L22040-07	32	80	124	22	40	0°	0°	DC.. 0702..	0,210
PSC40-SDJCR/L27050-07	40	80	140	27	50	0°	0°	DC.. 0702..	0,420
PSC32-SDJCR/L22040-11	32	110	124	22	40	0°	0°	DC.. 11T3..	0,210
PSC40-SDJCR/L27050-11	40	110	140	27	50	0°	0°	DC.. 11T3..	0,420
PSC50-SDJCR/L35060-11	50	110	165	35	60	0°	0°	DC.. 11T3..	0,800
PSC63-SDJCR/L45065-11	63	110	190	45	65	0°	0°	DC.. 11T3..	1,100

Reference Bezeichnung					Nm
PSC32-SDJCR/L22040-07	1225	5507	-	-	0.9
PSC40-SDJCR/L27050-07	1225	5507	-	-	0.9
PSC32-SDJCR/L22040-11	1335	5516	3714	1750	3.0
PSC40-SDJCR/L27050-11	1335	5516	3714	1750	3.0
PSC50-SDJCR/L35060-11	1335	5516	3714	1750	3.0
PSC63-SDJCR/L45065-11	1335	5516	3714	1750	3.0

DC.. 55° rhombic positive inserts with 7° clearance. A35
55° rhombische positive Wendeschneidplatten mit 7° Freiwinkel.

Reference / Bez.	l	s	d
DC.. 0702..	7,75	2,38	6,35
DC.. 11T3..	11,60	3,97	9,52

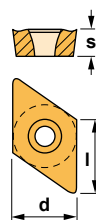

DCGT-AL



DCGT-AP



DCMT



DCMW

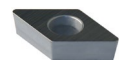

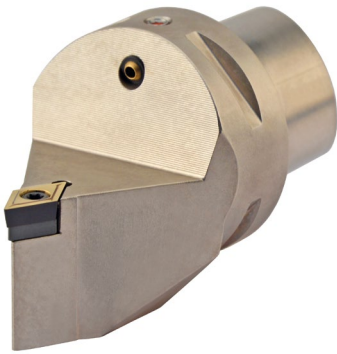

Characteristics:
Multipurpose profiling toolholder equipped with rhombic positive insert (angle 55°). PSC with internal coolant.

- 1) γ = Rake angle (valid with a flat insert).
- 2) λ_s = Angle of inclination.

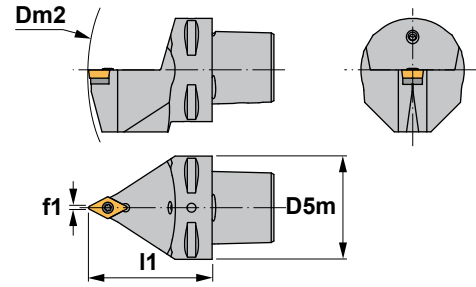

Eigenschaften:
Multifunktions-Klemmhalter zum Profildrehen mit einer rhombischen positiven Wendeschneidplatte (55° Winkel). PSC mit Innenkühlung.

- 1) γ = Spanwinkel (Gültig nur mit flachen Wendeschneidplatte).
- 2) λ_s = Neigungswinkel.

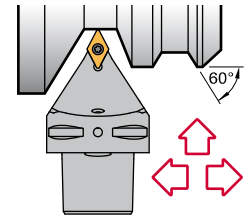

SDNC 62° 30'

Reference Bezeichnung	D5m	Dm2 min.	f1	l1	γ^1	λ_s^2	Insert size Wendeschneidplatte	Kg
PSC32-SDNCN00040-11	32	124	0.5	40	0°	0°	DC.. 11T3..	0,160
PSC40-SDNCN00050-11	40	140	0.5	50	0°	0°	DC.. 11T3..	0,350
PSC50-SDNCN00060-11	50	165	0.5	60	0°	0°	DC.. 11T3..	0,750

Reference Bezeichnung					Nm
PSC32-SDNCN00040-11	1335	5516	3714	1750	3.0
PSC40-SDNCN00050-11	1335	5516	3714	1750	3.0
PSC50-SDNCN00060-11	1335	5516	3714	1750	3.0

DC.. 55° rhombic positive inserts with 7° clearance. A35
55° rhombische positive Wendeschneidplatten mit 7° Freiwinkel.

Reference / Bez.	l	s	d
DC.. 11T3..	11,60	3,97	9,52

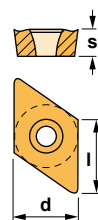

DCGT-AL



DCGT-AP



DCMT



DCMW

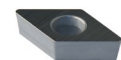

**Characteristics:**

Profiling toolholder equipped with round positive insert. PSC with internal coolant.

- 1) γ = Rake angle (valid with a flat insert).
2) λ_s = Angle of inclination.

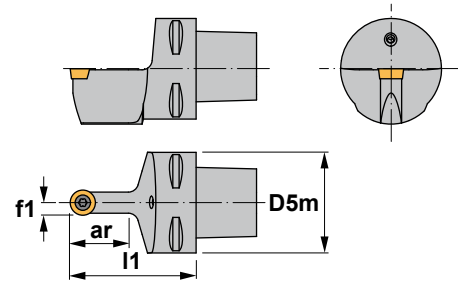
**Eigenschaften:**

Klemmhalter zum Profildrehen mit einer runden positiven Wendeschneidplatte.
PSC mit Innenkühlung.

- 1) γ = Spanwinkel (Gültig nur mit flachen Wendeschneidplatte).
2) λ_s = Neigungswinkel.

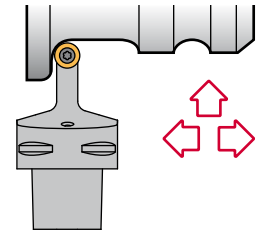
**SRDC**

Reference Bezeichnung	ar	D5m	f1	l1	γ^1	λ_s^2	Insert size Wendeschneidplatte	kg
PSC32-SRDCN00040-06	12	32	3	40	0°	0°	RC.. 0602M0	0,160
PSC40-SRDCN00050-06	12	40	3	50	0°	0°	RC.. 0602M0	0,350
PSC50-SRDCN00060-06	12	50	3	60	0°	0°	RC.. 0602M0	0,750
PSC32-SRDCN00040-08	16	32	4	40	0°	0°	RC.. 0803M0	0,160
PSC40-SRDCN00050-08	16	40	4	50	0°	0°	RC.. 0803M0	0,350
PSC50-SRDCN00060-08	16	50	4	60	0°	0°	RC.. 0803M0	0,750
PSC32-SRDCN00040-10	20	32	5	40	0°	0°	RC.. 10T3M0	0,160
PSC40-SRDCN00050-10	25	40	5	50	0°	0°	RC.. 10T3M0	0,350
PSC50-SRDCN00060-10	25	50	5	60	0°	0°	RC.. 10T3M0	0,750
PSC63-SRDCN00065-10	25	63	5	65	0°	0°	RC.. 10T3M0	1,070
PSC40-SRDCN00050-12	28	40	6	50	0°	0°	RC.. 1204M0	0,350
PSC50-SRDCN00060-12	28	50	6	60	0°	0°	RC.. 1204M0	0,750
PSC63-SRDCN00065-12	28	63	6	65	0°	0°	RC.. 1204M0	1,070
PSC50-SRDCN00060-16	35	50	8	60	0°	0°	RC.. 1606M0	0,750
PSC63-SRDCN00065-16	35	63	8	65	0°	0°	RC.. 1606M0	1,070
PSC50-SRDCN00060-20	40	50	10	60	0°	0°	RC.. 2006M0	0,750
PSC63-SRDCN00065-20	40	63	10	65	0°	0°	RC.. 2006M0	1,070

Reference Bezeichnung					Nm
... -06	1225	5507	-	-	0.9
... -08	1230	5508	-	-	1.2
... -10	1335	5516	3811	1750	3.0
... -12	1335	5516	3814	1750	3.0
... -16	1540	5517	3816	1765	3.0
... -20	1260	5520	3919	1059	4.0

RC..

Round positive inserts with 7° clearance. A38-39
Runde positive Wendeschneidplatten mit 7° Freiwinkel.

Reference / Bez.	s	d
RC.. 0602M0	2,38	6,00
RC.. 0803M0	3,18	8,00
RC.. 10T3M0	3,97	10,00
RC.. 1204M0	4,76	12,00
RC.. 1606M0	6,35	16,00
RC.. 2006M0	6,35	20,00

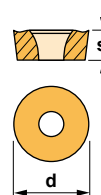
**RCGT-AL****RCGT-AP****RCMT**



Characteristics:
Profiling toolholder equipped with round positive insert. PSC with internal coolant.

- 1) γ = Rake angle (valid with a flat insert).
- 2) λ_s = Angle of inclination.

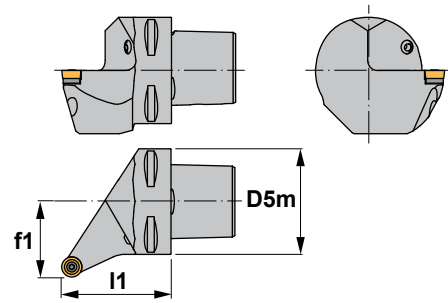

Eigenschaften:
Klemmhalter zum Profildrehen mit einer runden positiven Wendeschneidplatte.
PSC mit Innenkühlung.

- 1) γ = Spanwinkel (Gültig nur mit flachen Wendeschneidplatte).
- 2) λ_s = Neigungswinkel.

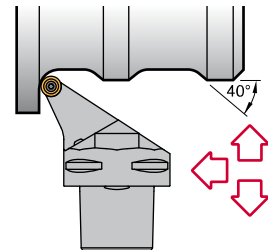

SRSC 45°

Reference Bezeichnung	D5m	f1	l1	γ^1	λ_s^2	Insert size Wendeschneidplatte	Kg
PSC32-SRSCR/L22040-06	32	22	40	0°	0°	RC.. 0602M0	0,210
PSC40-SRSCR/L27050-06	40	27	50	0°	0°	RC.. 0602M0	0,420
PSC50-SRSCR/L35060-06	50	35	60	0°	0°	RC.. 0602M0	0,800
PSC32-SRSCR/L22040-08	32	22	40	0°	0°	RC.. 0803M0	0,210
PSC40-SRSCR/L27050-08	40	27	50	0°	0°	RC.. 0803M0	0,420
PSC50-SRSCR/L35060-08	50	35	60	0°	0°	RC.. 0803M0	0,800
PSC32-SRSCR/L22040-10	32	22	40	0°	0°	RC.. 10T3M0	0,210
PSC40-SRSCR/L27050-10	40	27	50	0°	0°	RC.. 10T3M0	0,420
PSC50-SRSCR/L35060-10	50	35	60	0°	0°	RC.. 10T3M0	0,800
PSC63-SRSCR/L45065-10	63	45	65	0°	0°	RC.. 10T3M0	1,100
PSC40-SRSCR/L27050-12	40	27	50	0°	0°	RC.. 1204M0	0,420
PSC50-SRSCR/L35060-12	50	35	60	0°	0°	RC.. 1204M0	0,800
PSC63-SRSCR/L45065-12	63	45	65	0°	0°	RC.. 1204M0	1,100
PSC50-SRSCR/L35060-16	50	35	60	0°	0°	RC.. 1606M0	0,800
PSC63-SRSCR/L45065-16	63	45	65	0°	0°	RC.. 1606M0	1,100
PSC50-SRSCR/L35060-20	50	35	60	0°	0°	RC.. 2006M0	0,800
PSC63-SRSCR/L45065-20	63	45	65	0°	0°	RC.. 2006M0	1,100

Reference Bezeichnung					Nm
... -06	1225	5507	-	-	0.9
... -08	1230	5508	-	-	1.2
... -10	1335	5516	3811	1750	3.0
... -12	1335	5516	3814	1750	3.0
... -16	1540	5517	3816	1765	3.0
... -20	1260	5520	3919	1059	4.0

RC.. Round positive inserts with 7° clearance. A38-39
Runde positive Wendeschneidplatten mit 7° Freiwinkel.

Reference / Bez.	s	d
RC.. 0602M0	2,38	6,00
RC.. 0803M0	3,18	8,00
RC.. 10T3M0	3,97	10,00
RC.. 1204M0	4,76	12,00
RC.. 1606M0	6,35	16,00
RC.. 2006M0	6,35	20,00

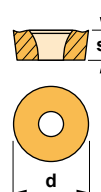

RCGT-AL

RCGT-AP



RCMT





Characteristics:

Toolholder for external turning and chamfering applications equipped with square positive inserts.
PSC with internal coolant.

- 1) γ = Rake angle (valid with a flat insert).
- 2) λ_s = Angle of inclination.

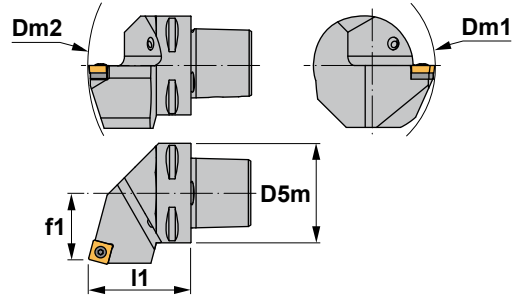

Eigenschaften:

Klemmhalter zum Außendrehen und Abschrägen mit einer vierkantigen positiven Wendeschneidplatte.
PSC mit Innenkühlung.

- 1) γ = Spanwinkel (Gültig nur mit flachen Wendeschneidplatte).
- 2) λ_s = Neigungswinkel.

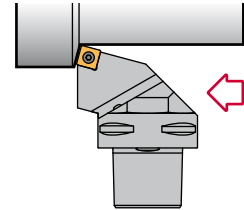

SSRC 75°

Reference Bezeichnung	D5m	Dm1 min.	Dm2 min.	f1	l1	γ^1	λ_s^2	Insert size Wendeschneidplatte	
PSC40-SSRCR/L22050-12	40	110	140	22	50	0°	0°	SC.. 1204..	0,420
PSC50-SSRCR/L27060-12	50	110	165	27	60	0°	0°	SC.. 1204..	0,800

Reference Bezeichnung					Nm
PSC40-SSRCR/L22050-12	1540	5517	3514	1760	3.0
PSC50-SSRCR/L27060-12	1540	5517	3514	1760	3.0

SC.. Square positive inserts with 7° clearance. A40
Vierkantige positive Wendeschneidplatten mit 7° Freiwinkel.

Reference / Bez.	l	s	d
SC.. 1204..	12,70	4,76	12,70

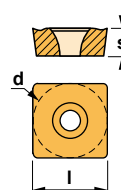

SCGT-AL



SCMT



SCMT-39





Characteristics:
Toolholder for external turning applications equipped with triangular positive inserts. PSC with internal coolant.

- 1) γ = Rake angle (valid with a flat insert).
- 2) λ_s = Angle of inclination.

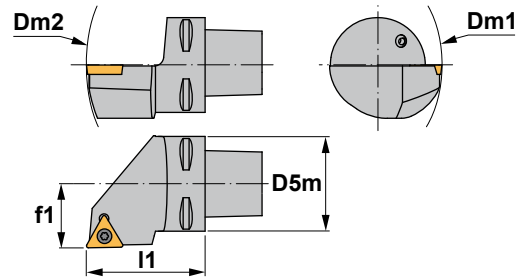

Eigenschaften:
Klemmhalter zum Außendrehen mit einer dreikantigen positiven Wendeschneidplatte. PSC mit Innenkühlung.

- 1) γ = Spanwinkel (Gültig nur mit flachen Wendeschneidplatte).
- 2) λ_s = Neigungswinkel.

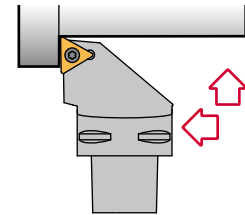

STGC 90°

Reference Bezeichnung	D5m	Dm1 min.	Dm2 min.	f1	l1	$\gamma^1)$	$\lambda_s^2)$	Insert size Wendeschneidplatte	
PSC32-STGCR/L22040-11	32	80	124	22	40	0°	0°	TC.. 1102..	0,210
PSC40-STGCR/L27050-11	40	80	140	27	50	0°	0°	TC.. 1102..	0,420
PSC32-STGCR/L22040-16	32	110	124	22	40	0°	0°	TC.. 16T3..	0,210
PSC40-STGCR/L27050-16	40	110	140	27	50	0°	0°	TC.. 16T3..	0,420
PSC50-STGCR/L35060-16	50	110	165	35	60	0°	0°	TC.. 16T3..	0,800
PSC63-STGCR/L45065-16	63	110	190	45	65	0°	0°	TC.. 16T3..	1,100

Reference Bezeichnung					Nm
PSC32-STGCR/L22040-11	1225	5507	-	-	0.9
PSC40-STGCR/L27050-11	1225	5507	-	-	0.9
PSC32-STGCR/L22040-16	1335	5516	3414	1750	3.0
PSC40-STGCR/L27050-16	1335	5516	3414	1750	3.0
PSC50-STGCR/L35060-16	1335	5516	3414	1750	3.0
PSC63-STGCR/L45065-16	1335	5516	3414	1750	3.0

TC.. Triangular positive inserts with 7° clearance. A44
Dreikantige positive Wendeschneidplatten mit 7° Freiwinkel.

Reference / Bez.	l	s	d
TC.. 1102..	11,00	2,38	6,35
TC.. 16T3..	16,50	3,97	9,52

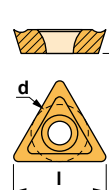

TCGT-AL



TCMT



TCMW

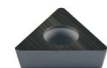



Characteristics:
Toolholder for external and face turning applications equipped with triangular positive inserts.
PSC with internal coolant.

- 1) γ = Rake angle (valid with a flat insert).
- 2) λ_s = Angle of inclination.

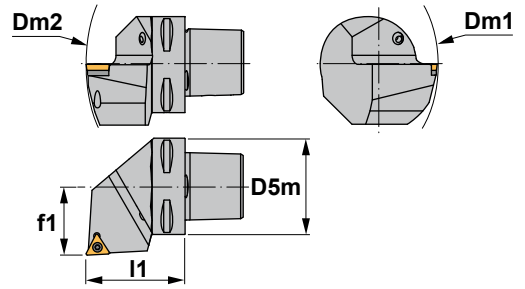

Eigenschaften:
Klemmhalter zum Außen- und Plandrehen mit einer dreikantigen positiven Wendeschneidplatte.
PSC mit Innenkühlung.

- 1) γ = Spanwinkel (Gültig nur mit flachen Wendeschneidplatte).
- 2) λ_s = Neigungswinkel.

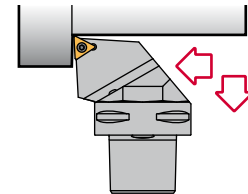

STJC 93°

Reference Bezeichnung	D5m	Dm1 min.	Dm2 min.	f1	l1	γ^1	λ_s^2	Insert size Wendeschneidplatte	Kg
PSC32-STJCR/L22040-11	32	80	124	22	40	0°	0°	TC.. 1102..	0,210
PSC40-STJCR/L27050-11	40	80	140	27	50	0°	0°	TC.. 1102..	0,420
PSC32-STJCR/L22040-16	32	110	124	22	40	0°	0°	TC.. 16T3..	0,210
PSC40-STJCR/L27050-16	40	110	140	27	50	0°	0°	TC.. 16T3..	0,420
PSC50-STJCR/L35060-16	50	110	165	35	60	0°	0°	TC.. 16T3..	0,800

Reference Bezeichnung					Nm
PSC32-STJCR/L22040-11	1225	5507	-	-	0.9
PSC40-STJCR/L27050-11	1225	5507	-	-	0.9
PSC32-STJCR/L22040-16	1335	5516	3414	1750	3.0
PSC40-STJCR/L27050-16	1335	5516	3414	1750	3.0
PSC50-STJCR/L35060-16	1335	5516	3414	1750	3.0

TC.. Triangular positive inserts with 7° clearance. A44 Dreikantige positive Wendeschneidplatten mit 7° Freiwinkel.

Reference / Bez.	l	s	d
TC.. 1102..	11,00	2,38	6,35
TC.. 16T3..	16,50	3,97	9,52

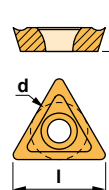

TCGT-AL



TCMT



TCMW

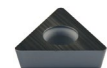



Characteristics:
Multipurpose profiling toolholder equipped with rhombic positive insert (angle 35°).
PSC with internal coolant.

- 1) γ = Rake angle (valid with a flat insert).
- 2) $\lambda.s$ = Angle of inclination.

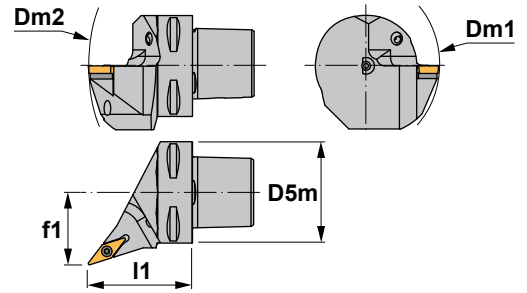

Eigenschaften:
Multifunktions-Klemmhalter zum Profildrehen mit einer rhombischen positiven Wendeschneidplatte (35° Winkel).
PSC mit Innenkühlung.

- 1) γ = Spanwinkel (Gültig nur mit flachen Wendeschneidplatte).
- 2) $\lambda.s$ = Neigungswinkel.

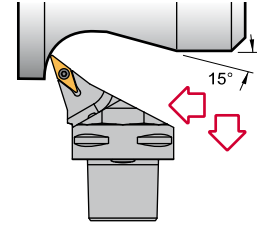

SVHB 107° 30'

Reference Bezeichnung	D5m	Dm1 min.	Dm2 min.	f1	l1	$\gamma^{(1)}$	$\lambda.s^{(2)}$	Insert size Wendeschneidplatte	
PSC40-SVHBR/L27050-16	40	110	140	27	50	0°	0°	VBMT 1604..	0,420
PSC50-SVHBR/L35060-16	50	110	165	35	60	0°	0°	VBMT 1604..	0,800
PSC63-SVHBR/L45065-16	63	110	190	45	65	0°	0°	VBMT 1604..	1,100

Reference Bezeichnung					Nm
PSC40-SVHBR/L27050-16	1335	5516	3718	1750	3.0
PSC50-SVHBR/L35060-16	1335	5516	3718	1750	3.0
PSC63-SVHBR/L45065-16	1335	5516	3718	1750	3.0

VBMT				35° rhombic positive insert with 5° clearance. A48		35° rhombische positive Wendeschneidplatte mit 5° Freiwinkel.	
Reference / Bez.	l	s	d			VBMT	
VBMT 1604..	16,50	4,76	9,52				



**Characteristics:**

Multipurpose profiling toolholder equipped with rhombic positive insert (angle 35°).
PSC with internal coolant.

- 1) γ = Rake angle (valid with a flat insert).
2) λ_s = Angle of inclination.

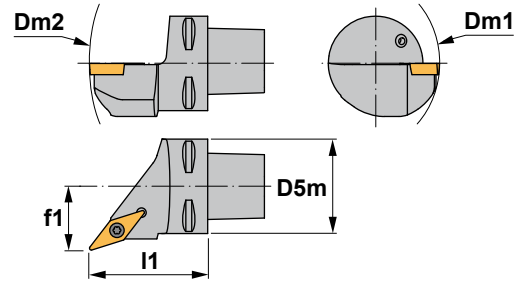
**Eigenschaften:**

Multifunktions-Klemmhalter zum Profildrehen mit einer rhombischen positiven Wendschneidplatte (35° Winkel).
PSC mit Innenkühlung.

- 1) γ = Spanwinkel (Gültig nur mit flachen Wendschneidplatte).
2) λ_s = Neigungswinkel.

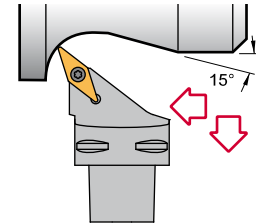

SVHC 107° 30'

Reference Bezeichnung	D5m	Dm1 min.	Dm2 min.	f1	l1	γ^1	λ_s^2	Insert size Wendschneidplatte	Kg
PSC32-SVHCR/L22040-11	32	80	124	22	40	0°	0°	VC.. 1103..	0,210
PSC40-SVHCR/L27050-11	40	80	140	27	50	0°	0°	VC.. 1103..	0,420
PSC50-SVHCR/L35060-11	50	80	165	35	60	0°	0°	VC.. 1103..	0,800
PSC40-SVHCR/L27050-16	40	110	140	27	50	0°	0°	VC.. 1604..	0,420
PSC50-SVHCR/L35060-16	50	110	165	35	60	0°	0°	VC.. 1604..	0,800
PSC63-SVHCR/L45065-16	63	110	190	45	65	0°	0°	VC.. 1604..	1,100

Reference Bezeichnung					Nm
PSC32-SVHCR/L22040-11	1225	5507	-	-	0.9
PSC40-SVHCR/L27050-11	1225	5507	-	-	0.9
PSC50-SVHCR/L35060-11	1225	5507	-	-	0.9
PSC40-SVHCR/L27050-16	1335	5516	3718	1750	3.0
PSC50-SVHCR/L35060-16	1335	5516	3718	1750	3.0
PSC63-SVHCR/L45065-16	1335	5516	3718	1750	3.0

VC.. 35° rhombic positive inserts with 7° clearance. A48
35° rhombische positive Wendschneidplatten mit 7° Freiwinkel.

Reference / Bez.	l	s	d
VC.. 1103..	11,00	3,18	6,35
VC.. 1604..	16,50	4,76	9,52

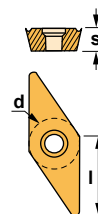

VCGT-AL



VCGT-AP



VCMT





Characteristics:
Multipurpose profiling toolholder equipped with rhombic 5° positive insert (angle 35°). PSC with internal coolant.

- 1) γ = Rake angle (valid with a flat insert).
- 2) λ_s = Angle of inclination.

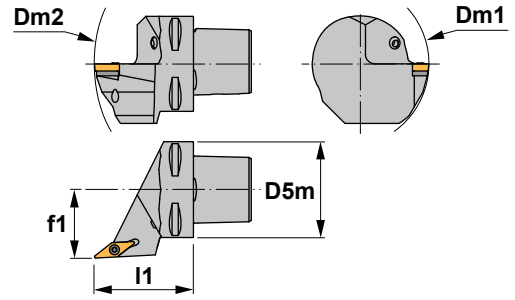

Eigenschaften:
Multifunktions-Klemmhalter zum Profildrehen mit einer 5° rhombischen positiven Wendeschneidplatte (35° Winkel). PSC mit Innenkühlung.

- 1) γ = Spanwinkel (Gültig nur mit flachen Wendeschneidplatte).
- 2) λ_s = Neigungswinkel.

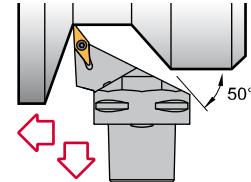

SVJB 93°

Reference Bezeichnung	D5m	Dm1 min.	Dm2 min.	f1	l1	$\gamma^{1)}$	$\lambda_{s2)}$	Insert size Wendeschneidplatte	Kg
PSC40-SVJBR/L27050-16	40	110	145	27	50	0°	0°	VBMT 1604..	0,420
PSC50-SVJBR/L35060-16	50	110	165	35	60	0°	0°	VBMT 1604..	0,800
PSC63-SVJBR/L45065-16	63	110	190	45	65	0°	0°	VBMT 1604..	1,100

Reference Bezeichnung					Nm
PSC40-SVJBR/L27050-16	1335	5516	3718	1750	3.0
PSC50-SVJBR/L35060-16	1335	5516	3718	1750	3.0
PSC63-SVJBR/L45065-16	1335	5516	3718	1750	3.0

VBMT 35° rhombic positive insert with 5° clearance. A48 35° rhombische positive Wendeschneidplatte mit 5° Freiwinkel.				
Reference / Bez.	l	s	d	
VBMT 1604..	16,50	4,76	9,52	





Characteristics:
Multipurpose profiling toolholder equipped with rhombic positive insert (angle 35°).
PSC with internal coolant.

- 1) γ = Rake angle (valid with a flat insert).
- 2) λ_s = Angle of inclination.

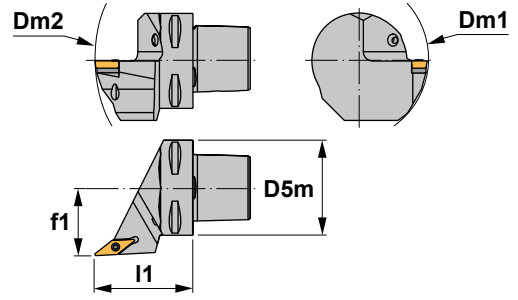

Eigenschaften:
Multifunktions-Klemmhalter zum Profildrehen mit einer rhombischen positiven Wendeschneidplatte (35° Winkel).
PSC mit Innenkühlung.

- 1) γ = Spanwinkel (Gültig nur mit flachen Wendeschneidplatte).
- 2) λ_s = Neigungswinkel.

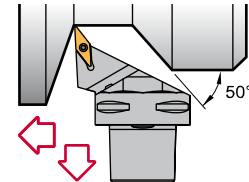

SVJC 93°

Reference Bezeichnung	D5m	Dm1 min.	Dm2 min.	f1	l1	γ^1	λ_s^2	Insert size Wendeschneidplatte	kg
PSC32-SVJCR/L22040-11	32	80	121	22	40	0°	0°	VC.. 1103..	0,210
PSC40-SVJCR/L27050-11	40	80	145	27	50	0°	0°	VC.. 1103..	0,420
PSC50-SVJCR/L35060-11	50	80	165	35	60	0°	0°	VC.. 1103..	0,800
PSC40-SVJCR/L27050-16	40	110	145	27	50	0°	0°	VC.. 1604..	0,420
PSC50-SVJCR/L35060-16	50	110	165	35	60	0°	0°	VC.. 1604..	0,800
PSC63-SVJCR/L45065-16	63	110	190	45	65	0°	0°	VC.. 1604..	1,100

Reference Bezeichnung					Nm
PSC32-SVJCR/L22040-11	1225	5507	-	-	0.9
PSC40-SVJCR/L27050-11	1225	5507	-	-	0.9
PSC50-SVJCR/L35060-11	1225	5507	-	-	0.9
PSC40-SVJCR/L27050-16	1335	5516	3718	1750	3.0
PSC50-SVJCR/L35060-16	1335	5516	3718	1750	3.0
PSC63-SVJCR/L45065-16	1335	5516	3718	1750	3.0

VC.. 35° rhombic positive inserts with 7° clearance. A48
35° rhombische positive Wendeschneidplatten mit 7° Freiwinkel.

Reference / Bez.	l	s	d
VC.. 1103..	11,00	3,18	6,35
VC.. 1604..	16,50	4,76	9,52

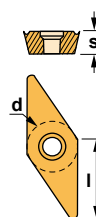

VCGT-AL



VCGT-AP



VCMT





Characteristics:

Toolholder for multi-task machining equipped with rhombic negative inserts (angle 35°).

PSC with internal coolant.

HP= High pressure coolant.

1) γ = Rake angle (valid with a flat insert).

2) λ_s = Angle of inclination.

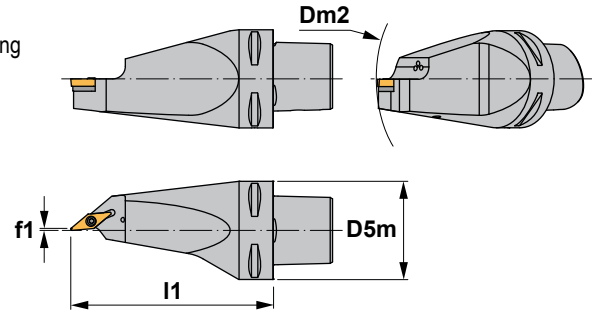

Eigenschaften:

Klemmhalter zur Multi-Task-Bearbeitung mit einer doppelseitigen rhombischen negativen Wendeschneidplatte (35° Winkel).

PSC mit Innenkühlung.

HP= Hochdruck-Kühlschmierstoff.

1) γ = Spanwinkel (Gültig nur mit flachen Wendeschneidplatte).

2) λ_s = Neigungswinkel.

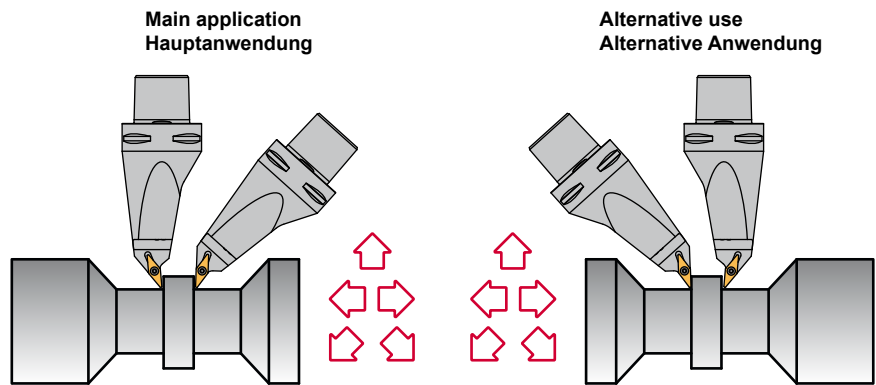

SVMB 50°

Reference Bezeichnung	D5m	Dm2 min.	f1	l1	$\gamma^1)$	$\lambda_s^2)$	Insert size Wendeschneidplatte	Kg
PSC63-SVMBR/L00130-16HP	63	110	1,2	130	0°	0°	VBMT 1604..	1,690

Reference Bezeichnung					Nm
PSC63-SVMBR/L00130-16HP	1335	5516	3718	1750	3.0

VBMT		35° rhombic positive insert with 5° clearance. A48 35° rhombische positive Wendeschneidplatte mit 5° Freiwinkel.		
Reference / Bez.	l	s	d	
VBMT 1604..	16,50	4,76	9,52	

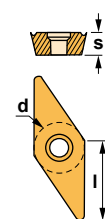

**Characteristics:**

Multipurpose profiling toolholder equipped with rhombic 5° positive insert (angle 35°). PSC with internal coolant.

- 1) γ = Rake angle (valid with a flat insert).
- 2) λ_s = Angle of inclination.

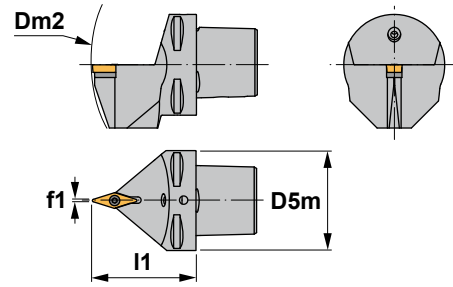
**Eigenschaften:**

Multifunktions-Klemmhalter zum Profildrehen mit einer 5° rhombischen positiven Wendeschneidplatte (35° Winkel).

PSC mit Innenkühlung.

- 1) γ = Spanwinkel (Gültig nur mit flachen Wendeschneidplatte).
- 2) λ_s = Neigungswinkel.

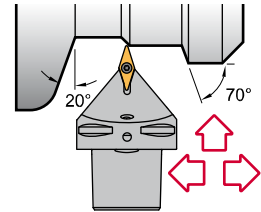

SVVB 72° 30'

Reference Bezeichnung	D5m	Dm2 min.	f1	l1	γ^1	λ_s^2	Insert size Wendeschneidplatte	kg
PSC40-SVVBN00050-16	40	140	0.6	50	0°	0°	VBMT 1604..	0,350
PSC50-SVVBN00060-16	50	165	0.6	60	0°	0°	VBMT 1604..	0,750
PSC63-SVVBN00065-16	63	190	0.6	65	0°	0°	VBMT 1604..	1,070

Reference Bezeichnung					Nm
PSC40-SVVBN00050-16	1335	5516	3718	1750	3.0
PSC50-SVVBN00060-16	1335	5516	3718	1750	3.0
PSC63-SVVBN00065-16	1335	5516	3718	1750	3.0

VBMT

35° rhombic positive insert with 5° clearance. A48
35° rhombische positive Wendeschneidplatte mit 5° Freiwinkel.

Reference / Bez.

VBMT 1604..

l

16,50

s

4,76

d

9,52

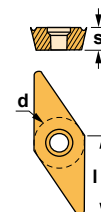
**VBMT**



Characteristics:
Multipurpose profiling toolholder equipped with rhombic positive insert (angle 35°).
PSC with internal coolant.

- 1) γ = Rake angle (valid with a flat insert).
- 2) λ_s = Angle of inclination.

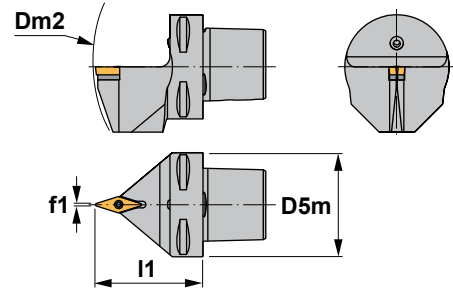

Eigenschaften:
Multifunktions-Klemmhalter zum Profildrehen mit einer rhombischen positiven Wendeschneidplatte (35° Winkel).
PSC mit Innenkühlung.

- 1) γ = Spanwinkel (Gültig nur mit flachen Wendeschneidplatte).
- 2) λ_s = Neigungswinkel.

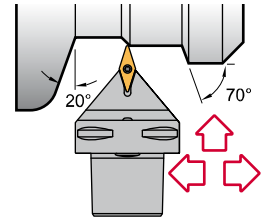

SVVC 72° 30'

Reference Bezeichnung	D5m	Dm2 min.	f1	I1	$\gamma^{1)}$	$\lambda_s^{2)}$	Insert size Wendeschneidplatte	Kg
PSC32-SVVCN00040-11	32	124	0.3	40	0°	0°	VC.. 1103..	0,160
PSC40-SVVCN00050-11	40	140	0.3	50	0°	0°	VC.. 1103..	0,350
PSC40-SVVCN00050-16	40	140	0.6	50	0°	0°	VC.. 1604..	0,350
PSC50-SVVCN00060-16	50	165	0.6	60	0°	0°	VC.. 1604..	0,750
PSC63-SVVCN00065-16	63	190	0.6	65	0°	0°	VC.. 1604..	1,070

Reference Bezeichnung					Nm
PSC32-SVVCN00040-11	1225	5507	-	-	0.9
PSC40-SVVCN00050-11	1225	5507	-	-	0.9
PSC40-SVVCN00050-16	1335	5516	3718	1750	3.0
PSC50-SVVCN00060-16	1335	5516	3718	1750	3.0
PSC63-SVVCN00065-16	1335	5516	3718	1750	3.0

VC.. 35° rhombic positive inserts with 7° clearance. A48
35° rhombische positive Wendeschneidplatten mit 7° Freiwinkel.

Reference / Bez.	l	s	d
VC.. 1103..	11,00	3,18	6,35
VC.. 1604..	16,50	4,76	9,52

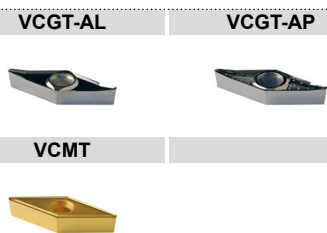
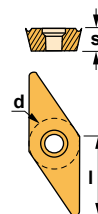



Characteristics:
Antivibratory adaptor.

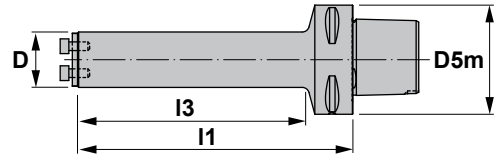

Eigenschaften:
Schwingungsgedämpfte Aufnahmen.





J..





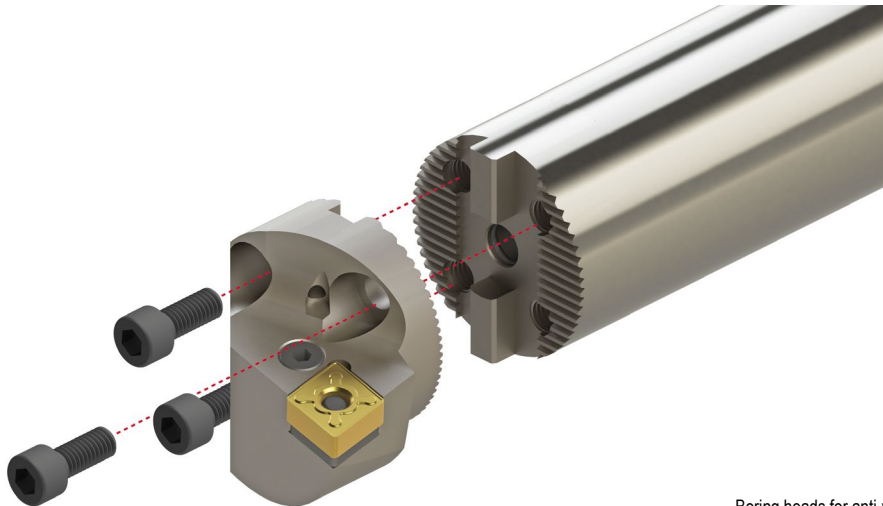





Reference Bezeichnung	D5m	D	l3	l1	
PSC63-J25	63	25	103	132	1,300
PSC63-J32	63	32	129	159	1,700
PSC63-J40	63	40	169	198	2,300
PSC63-J50	63	50	212	239	3,300
PSC63-J60	63	60	263	287	5,900

Reference Bezeichnung			Nm
PSC63-J25	1924	5025	2.0
PSC63-J32	1925	5003	3.0
PSC63-J40	1926	5004	3.5
PSC63-J50	1928	5005	4.0
PSC63-J60	1928	5005	4.0



Boring heads for anti-vibration bars.  A238-245
Bohrköpfe für Schwingungsgedämpfte Bohrstanen.

MTUN 93°-N 	PCLN 95°-N 	PDUN 93°-N 	PWLN 95°-N 
SCLC 95°-N 	SDUC 93°-N 	STFC 90°-N 	SXFN 90°-N 

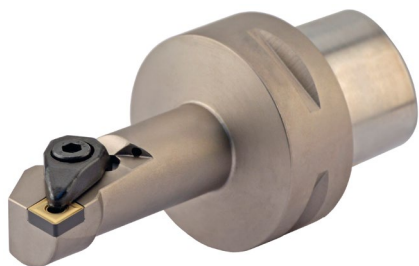

Characteristics:
Boring bar for internal turning applications equipped with rhombic negative inserts (angle 80°).
PSC with internal coolant.

- 1) γ = Rake angle (valid with a flat insert).
- 2) λ_s = Angle of inclination.

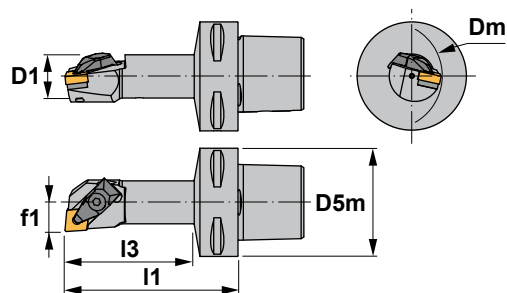

Eigenschaften:
Bohrstange zum Innendrehen mit einer rhombischen negativen Wendeschneidplatte (80° Winkel).
PSC mit Innenkühlung.

- 1) γ = Spanwinkel (Gültig nur mit flachen Wendeschneidplatte).
- 2) λ_s = Neigungswinkel.

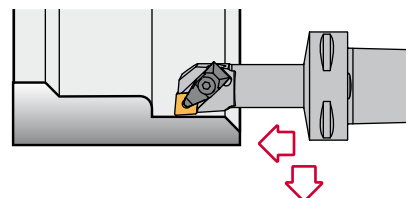

DCLN 95°

Reference Bezeichnung	Dm	D1	D5m	f1	I1	I3	γ^1	λ_{s2}	Insert size Wendeschneidplatte	
PSC40-DCLNR/L13080-09	25	20	40	13	80	57	-6°	-14°	CN.. 0903..	0,400
PSC50-DCLNR/L13080-09	25	20	50	13	80	56	-6°	-14°	CN.. 0903..	0,570
PSC40-DCLNR/L17090-12	32	25	40	17	90	68	-6°	-12°	CN.. 1204..	0,480
PSC50-DCLNR/L17090-12	32	25	50	17	90	66	-6°	-12°	CN.. 1204..	0,700
PSC63-DCLNR/L17100-12	32	25	63	17	100	72	-6°	-12°	CN.. 1204..	1,000
PSC63-DCLNR/L27140-16	50	40	63	27	140	114	-6°	-16°	CN.. 1606..	1,780

Reference Bezeichnung							Nm
PSC40-DCLNR/L13080-09	-	-	2708	1695	4294	5004	3.5
PSC50-DCLNR/L13080-09	-	-	2708	1695	4294	5004	3.5
PSC40-DCLNR/L17090-12	1766	ICSN-422	2712	1696	4295	5004	3.5
PSC50-DCLNR/L17090-12	1766	ICSN-422	2712	1696	4295	5004	3.5
PSC63-DCLNR/L17100-12	1766	ICSN-422	2712	1696	4295	5004	3.5
PSC63-DCLNR/L27140-16	1768	ICSN-533	2716	1696	4295	5004	3.5

CN..

80° rhombic negative inserts.
80° rhombische negative WSP. A32-34

Reference / Bez.	l	s	d
CN.. 0903..	9,65	3,18	9,52
CN.. 1204..	12,90	4,76	12,70
CN.. 1606..	16,10	6,35	15,88

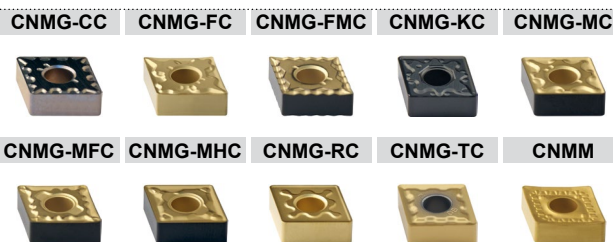
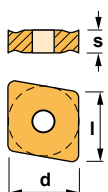



Characteristics:

Boring bar for internal turning and profiling applications equipped with rhombic negative inserts (angle 55°).
PSC with internal coolant.

- 1) γ = Rake angle (valid with a flat insert).
- 2) λ_s = Angle of inclination.

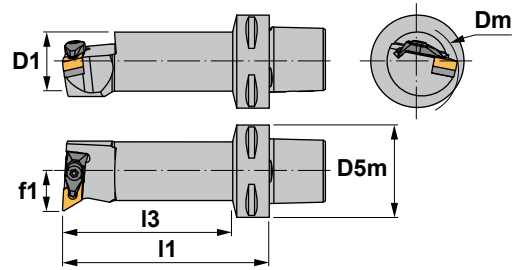

Eigenschaften:

Bohrstange zum Innen- und Profildrehen mit einer rhombischen negativen Wendeschneidplatte (55° Winkel).
PSC mit Innenkühlung.

- 1) γ = Spanwinkel (Gültig nur mit flachen Wendeschneidplatte).
- 2) λ_s = Neigungswinkel.

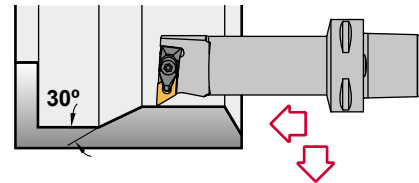

DDUN 93°

Reference Bezeichnung	Dm	D1	D5m	f1	l1	l3	γ^1	λ_s^2	Insert size Wendeschneidplatte	kg
PSC40-DDUNR/L17090-11	32	25.0	40	17	90	68	-6°	-12°	DN.. 1104..	0,480
PSC50-DDUNR/L17090-11	32	25.0	50	17	90	66	-6°	-12°	DN.. 1104..	0,700
PSC40-DDUNR/L27080-15	50	39.7	40	27	80	59	-6°	-11°	DN.. 1506..	0,740
PSC50-DDUNR/L27140-15	50	40.0	50	27	140	118	-6°	-11°	DN.. 1506..	1,470
PSC63-DDUNR/L27140-15	50	40.0	63	27	140	114	-6°	-11°	DN.. 1506..	1,780

Reference Bezeichnung							Nm
PSC40-DDUNR/L17090-11	1764	IDSN-322	2708	1695	4294	5004	3.5
PSC50-DDUNR/L17090-11	1764	IDSN-322	2708	1695	4294	5004	3.5
PSC40-DDUNR/L27080-15	1766	IDSN-432	2712	1696	4295	5004	3.5
PSC50-DDUNR/L27140-15	1766	IDSN-432	2712	1696	4295	5004	3.5
PSC63-DDUNR/L27140-15	1766	IDSN-432	2712	1696	4295	5004	3.5

DN.. 55° rhombic negative inserts. A36-37
55° rhombische negative Wendeschneidplatten.

Reference / Bez.	l	s	d
DN.. 1104..	11,60	4,76	9,52
DN.. 1506..	15,50	6,35	12,70

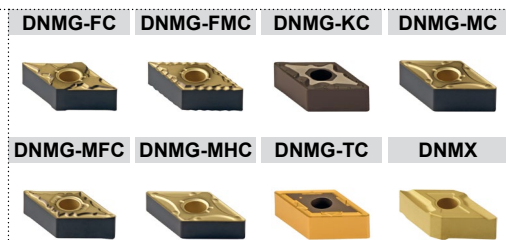
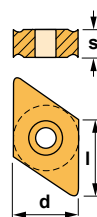

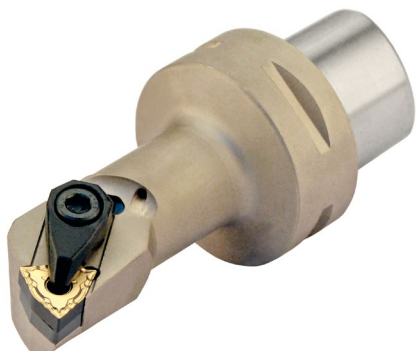

Characteristics:
Multipurpose boring bar equipped with trigon negative double-sided insert (angle 80°).
PSC with internal coolant.

- 1) γ = Rake angle (valid with a flat insert).
- 2) λ_s = Angle of inclination.

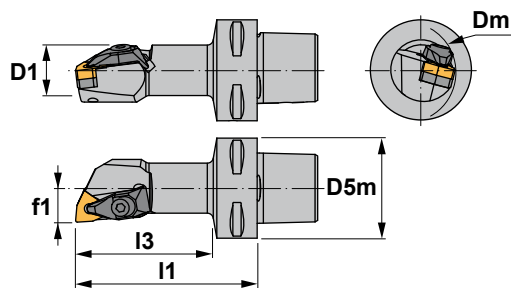

Eigenschaften:
Multifunktions-Bohrstange mit einer doppelseitigen negativen Trigon Wendeschneidplatte (80° Winkel).
PSC mit Innenkühlung.

- 1) γ = Spanwinkel (Gültig nur mit flachen Wendeschneidplatte).
- 2) λ_s = Neigungswinkel.

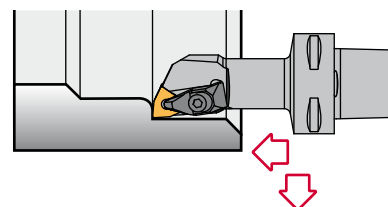

DWLN 95°

Reference Bezeichnung	Dm	D1	D5m	f1	I1	I3	$\gamma^1)$	$\lambda_s^2)$	Insert size Wendeschneidplatte	
PSC40-DWLN/L13075-06	33	20	40	13	75	52	-6°	-17°	WNMG 0604..	0,420
PSC40-DWLN/L17090-08	35	25	40	17	90	68	-6°	-12°	WNMG 0804..	0,480
PSC50-DWLN/L17090-08	35	25	50	17	90	66	-6°	-12°	WNMG 0804..	0,700

Reference Bezeichnung							Nm
PSC40-DWLN/L13075-06	1764	IWSN-322	2708	1695	4294	5004	3.5
PSC40-DWLN/L17090-08	1766	IWSN-433	2712	1696	4295	5004	3.5
PSC50-DWLN/L17090-08	1766	IWSN-433	2712	1696	4295	5004	3.5

WNMG 80° trigon negative inserts. A50-51 80° trigon negative Wendeschneidplatten.

Reference / Bez.	l	s	d
WNMG 0604..	6,45	4,76	9,52
WNMG 0804..	8,14	4,76	12,70

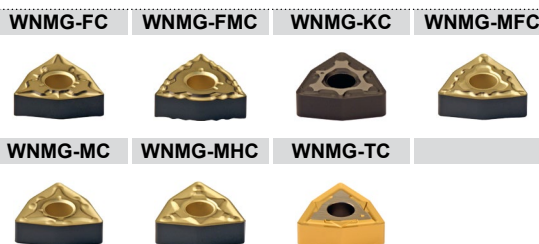
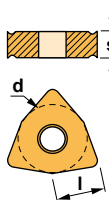



Characteristics:
Internal turning and profiling boring bar equipped with triangular negative double-sided insert.
PSC with internal coolant.

- 1) γ = Rake angle (valid with a flat insert).
- 2) λ_s = Angle of inclination.

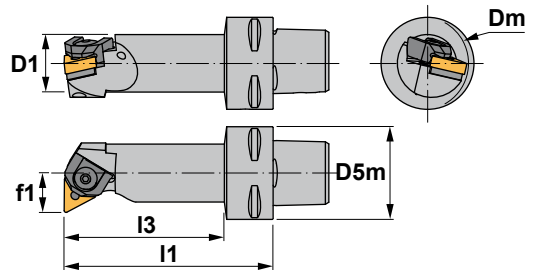

Eigenschaften:
Bohrstange zum Innen- und Profildrehen mit einer doppelseitigen dreieckigen negativen Wendeschneidplatte.
PSC mit Innenkühlung.

- 1) γ = Spanwinkel (Gültig nur mit flachen Wendeschneidplatte).
- 2) λ_s = Neigungswinkel.

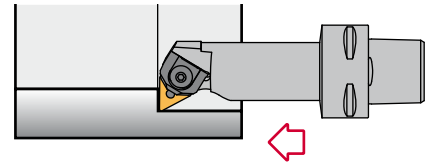

MTFN 90°

Reference Bezeichnung	Dm	D1	D5m	f1	I1	I3	γ^1	λ_{s^2}	Insert size Wendeschneidplatte	
PSC40-MTFNR/L17090-16	32	25	40	17	90	69	-6°	-13°	TNM.. 1604..	0,480
PSC40-MTFNR/L22110-16	40	32	40	22	110	89	-6°	-12°	TNM.. 1604..	0,750
PSC40-MTFNR/L27120-16	50	40	40	27	120	100	-6°	-11°	TNM.. 1604..	1,130
PSC50-MTFNR/L17090-16	32	25	50	17	90	67	-6°	-13°	TNM.. 1604..	0,700
PSC50-MTFNR/L22110-16	40	32	50	22	110	88	-6°	-12°	TNM.. 1604..	0,930
PSC50-MTFNR/L27140-16	50	40	50	27	140	119	-6°	-11°	TNM.. 1604..	1,470
PSC63-MTFNR/L22110-16	40	32	63	22	110	84	-6°	-12°	TNM.. 1604..	1,260
PSC63-MTFNR/L27140-16	50	40	63	27	140	115	-6°	-11°	TNM.. 1604..	1,780

Reference Bezeichnung						Nm
PSC40-MTFNR/L17090-16	2017	1644	5025	3414	1813	2.0
PSC40-MTFNR/L22110-16	2017	1644	5025	3414	1393	2.0
PSC40-MTFNR/L27120-16	2017	1644	5025	3414	1393	2.0
PSC50-MTFNR/L17090-16	2017	1644	5025	3414	1393	2.0
PSC50-MTFNR/L22110-16	2017	1644	5025	3414	1393	2.0
PSC50-MTFNR/L27140-16	2017	1644	5025	3414	1393	2.0
PSC63-MTFNR/L22110-16	2017	1644	5025	3414	1393	2.0
PSC63-MTFNR/L27140-16	2017	1644	5025	3414	1393	2.0

TNM..

Triangular negative inserts.
Dreieckige negative WSP. A45-46

Reference / Bez.	l	s	d
TNM.. 1604..	16,50	4,76	9,52

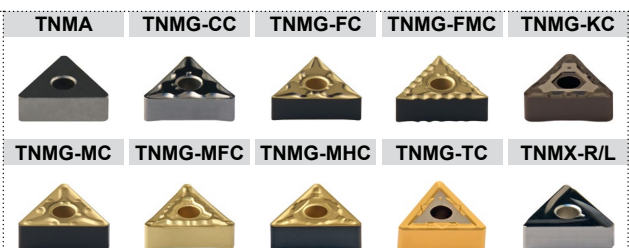
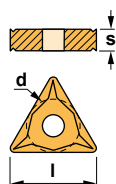



Characteristics:
Internal turning and profiling boring bar equipped with rhombic negative double-sided insert (angle 35°).
PSC with internal coolant.

- 1) γ = Rake angle (valid with a flat insert).
- 2) λ_s = Angle of inclination.

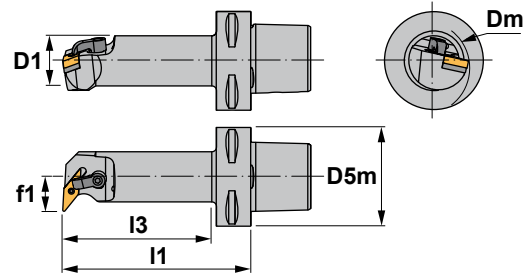

Eigenschaften:
Bohrstange zum Innen- und Profildrehen mit einer doppelseitigen rhombischen negativen Wendeschneidplatte (35° Winkel).
PSC mit Innenkühlung.

- 1) γ = Spanwinkel (Gültig nur mit flachen Wendeschneidplatte).
- 2) λ_s = Neigungswinkel.

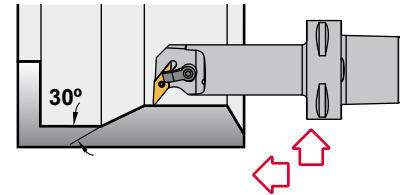

MVUN 93°

Reference Bezeichnung	Dm	D1	D5m	f1	I1	I3	γ^1	λ_s^2	Insert size Wendeschneidplatte	KG
PSC40-MVUNR/L27120-16	50	40	40	27	120	100	-6°	-10°	VN.. 1604..	1,130
PSC50-MVUNR/L27140-16	50	40	50	27	140	119	-6°	-10°	VN.. 1604..	1,470
PSC50-MVUNR/L35150-16	63	50	50	35	150	131	-6°	-10°	VN.. 1604..	2,250
PSC63-MVUNR/L22120-16	40	32	63	22	120	94	-6°	-12°	VN.. 1604..	1,280
PSC63-MVUNR/L35175-16	63	50	63	35	175	152	-6°	-10°	VN.. 1604..	2,850

Reference Bezeichnung							Nm
PSC40-MVUNR/L27120-16	2614	5003	IVSN-322	1086	1665	5002	3.0
PSC50-MVUNR/L27140-16	2614	5003	IVSN-322	1086	1665	5002	3.0
PSC50-MVUNR/L35150-16	2614	5003	IVSN-322	1086	1665	5002	3.0
PSC63-MVUNR/L22120-16	2614	5003	IVSN-322	1186	1665	5002	3.0
PSC63-MVUNR/L35175-16	2614	5003	IVSN-322	1086	1665	5002	3.0

VN.. 35° rhombic negative inserts. A49
35° rhombische negative Wendeschneidplatten.

Reference / Bez.	l	s	d
VN.. 1604..	16,50	4,76	9,52

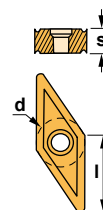

VNGP



VNMG



VNMG-TC





Characteristics:
Multipurpose boring bar equipped with trigon negative double-sided insert (angle 80°).
PSC with internal coolant.

- 1) γ = Rake angle (valid with a flat insert).
- 2) λ_s = Angle of inclination.

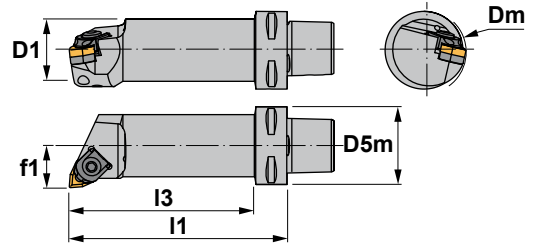

Eigenschaften:
Multifunktions-Bohrstange mit einer doppelseitigen negativen Trigon Wendeschneidplatte (80° Winkel).
PSC mit Innenkühlung.

- 1) γ = Spanwinkel (Gültig nur mit flachen Wendeschneidplatte).
- 2) λ_s = Neigungswinkel.

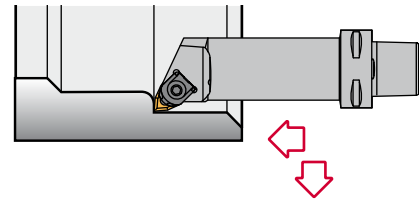

MWLN 95°

Reference Bezeichnung	Dm	D1	D5m	f1	l1	l3	γ^1	λ_s^2	Insert size Wendeschneidplatte	KG
PSC32-MWLN/L13075-06	25	20	32	13	75	59	-6°	-14°	WNMG 0604..	0,240
PSC32-MWLN/L17090-06	32	25	32	17	90	75	-6°	-12°	WNMG 0604..	0,360
PSC40-MWLN/L13075-06	25	20	40	13	75	53	-6°	-14°	WNMG 0604..	0,420
PSC40-MWLN/L17090-06	32	25	40	17	90	69	-6°	-12°	WNMG 0604..	0,480
PSC40-MWLN/L17090-08	32	25	40	17	90	69	-6°	-14°	WNMG 0804..	0,480
PSC40-MWLN/L22110-08	40	32	40	22	110	89	-6°	-14°	WNMG 0804..	0,750
PSC40-MWLN/L27120-08	50	40	40	27	120	100	-6°	-12°	WNMG 0804..	1,130
PSC50-MWLN/L17090-08	32	25	50	17	90	67	-6°	-14°	WNMG 0804..	0,700
PSC50-MWLN/L22110-08	40	32	50	22	110	88	-6°	-14°	WNMG 0804..	0,930
PSC50-MWLN/L27140-08	50	40	50	27	140	119	-6°	-12°	WNMG 0804..	1,470

Reference Bezeichnung						Nm
PSC32-MWLN/L13075-06	2006	5025	-	1643	1813	2.0
PSC32-MWLN/L17090-06	2006	5025	3006	1644	1813	2.0
PSC40-MWLN/L13075-06	2006	5025	-	1643	1813	2.0
PSC40-MWLN/L17090-06	2006	5025	3006	1644	1813	2.0
PSC40-MWLN/L17090-08	2011	5005	-	1647	1814	4.0
PSC40-MWLN/L22110-08	2011	5005	IWSN-433	1661	1814	4.0
PSC40-MWLN/L27120-08	2011	5005	IWSN-433	1661	1814	4.0
PSC50-MWLN/L17090-08	2011	5005	-	1647	1814	4.0
PSC50-MWLN/L22110-08	2011	5005	IWSN-433	1661	1814	4.0
PSC50-MWLN/L27140-08	2011	5005	IWSN-433	1661	1814	4.0

WNMG 80° trigon negative inserts. 80° trigon negative Wendeschneidplatten. A50-51

Reference / Bez.	l	s	d
WNMG 0604..	6,45	4,76	9,52
WNMG 0804..	8,14	4,76	12,70

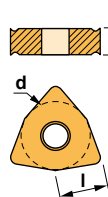



Characteristics: Boring bar for internal turning applications equipped with rhombic negative inserts (angle 80°). PSC with internal coolant.
1) γ = Rake angle (valid with a flat insert).
2) λ_s = Angle of inclination.

Eigenschaften:

Bohrstange zum Innendrehen mit einer rhombischen negativen Wendeschneidplatte (80° Winkel). PSC mit Innenkühlung.
1) γ = Spanwinkel (Gültig nur mit flachen Wendeschneidplatte).
2) λ_s = Neigungswinkel.

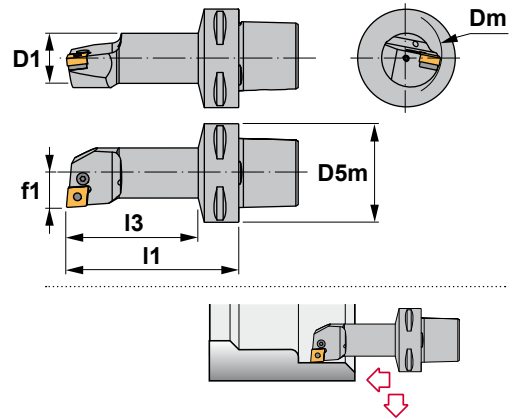

PCLN 95°

Reference Bezeichnung	Dm	D1	D5m	f1	I1	I3	$\gamma^1)$	$\lambda_{s^2)}$	Insert size Wendeschneidplatte	Kg
PSC40-PCLNR/L13080-09	25	20	40	13	80	58	-6°	-11°	CN.. 0903..	0,400
PSC50-PCLNR/L13080-09	25	20	50	13	80	56	-6°	-11°	CN.. 0903..	0,570
PSC32-PCLNR/L17090-12	32	25	32	17	90	75	-6°	-11°	CN.. 1204..	0,360
PSC32-PCLNR/L22064-12	40	32	32	22	64	50	-6°	-11°	CN.. 1204..	0,350
PSC32-PCLNR/L22096-12	40	32	32	22	96	82	-6°	-11°	CN.. 1204..	0,550
PSC40-PCLNR/L17090-12	32	25	40	17	90	69	-6°	-11°	CN.. 1204..	0,480
PSC40-PCLNR/L22110-12	40	32	40	22	110	89	-6°	-11°	CN.. 1204..	0,750
PSC40-PCLNR/L27080-12	50	40	40	27	80	60	-6°	-10°	CN.. 1204..	0,740
PSC40-PCLNR/L27120-12	50	40	40	27	120	100	-6°	-11°	CN.. 1204..	1,130
PSC50-PCLNR/L17090-12	32	25	50	17	90	67	-6°	-11°	CN.. 1204..	0,700
PSC50-PCLNR/L22110-12	40	32	50	22	110	88	-6°	-11°	CN.. 1204..	0,930
PSC50-PCLNR/L27140-12	50	40	50	27	140	119	-6°	-10°	CN.. 1204..	1,470
PSC50-PCLNR/L35100-12	63	50	50	35	100	81	-6°	-7°	CN.. 1204..	1,480
PSC63-PCLNR/L17100-12	32	25	63	17	100	74	-6°	-11°	CN.. 1204..	1,000
PSC63-PCLNR/L22110-12	40	32	63	22	110	84	-6°	-11°	CN.. 1204..	1,260
PSC50-PCLNR/L35150-16	63	50	50	35	150	131	-6°	-11°	CN.. 1606..	2,250
PSC63-PCLNR/L27140-16	50	40	63	27	140	115	-6°	-11°	CN.. 1606..	1,780
PSC63-PCLNR/L35175-16	63	50	63	35	175	152	-6°	-11°	CN.. 1606..	2,850

Reference Bezeichnung							Nm
PSC40-PCLNR/L13080-09	8005	1605	5002	-	-	-	1.4
PSC50-PCLNR/L13080-09	8005	1605	5002	-	-	-	1.4
PSC32-PCLNR/L17090-12	8212	1626	5025	-	-	-	2.0
PSC32-PCLNR/L22064-12	8312	1648	5003	3612	4112	0012	3.0
PSC32-PCLNR/L22096-12	8312	1648	5003	3612	4112	0012	3.0
PSC40-PCLNR/L17090-12	8212	1626	5025	-	-	-	2.0
PSC40-PCLNR/L22110-12	8312	1648	5003	3612	4112	0012	3.0
PSC40-PCLNR/L27080-12	8012	1608	5003	3612	4112	0012	3.0
PSC40-PCLNR/L27120-12	8012	1608	5003	3612	4112	0012	3.0
PSC50-PCLNR/L17090-12	8212	1626	5025	-	-	-	2.0
PSC50-PCLNR/L22110-12	8312	1648	5003	3612	4112	0012	3.0
PSC50-PCLNR/L27140-12	8012	1608	5003	3612	4112	0012	3.0
PSC50-PCLNR/L35100-12	8012	1608	5003	3612	4112	0012	3.0
PSC63-PCLNR/L17100-12	8212	1626	5025	-	-	-	2.0
PSC63-PCLNR/L22110-12	8312	1648	5003	3612	4112	0012	3.0
PSC50-PCLNR/L35150-16	8016	1618	5003	3616	4115	0015	3.0
PSC63-PCLNR/L27140-16	8016	1618	5003	3616	4115	0015	3.0
PSC63-PCLNR/L35175-16	8016	1618	5003	3616	4115	0015	3.0

CN..

80° rhombic negative inserts.
80° rhombische negative Wendeschneidplatten. A32-34





Characteristics:

Boring bar for internal turning and profiling applications equipped with rhombic negative inserts (angle 55°). PSC with internal coolant.

- 1) γ = Rake angle (valid with a flat insert).
- 2) λ_s = Angle of inclination.

Eigenschaften:

Bohrstange zum Innen- und Profildrehen mit einer rhombischen negativen Wendeschneidplatte (55° Winkel). PSC mit Innenkühlung.

- 1) γ = Spanwinkel (Gültig nur mit flachen Wendeschneidplatte).
- 2) λ_s = Neigungswinkel.

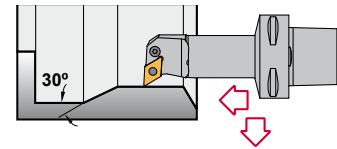
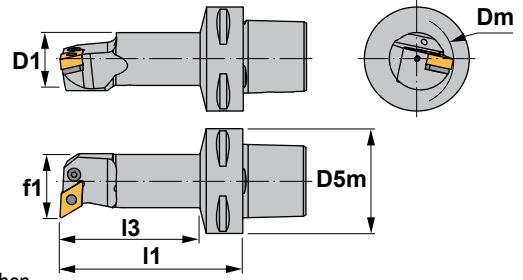

PDUN 93°

Reference Bezeichnung	Dm	D1	D5m	f1	I1	I3	γ^1	λ_s^2	Insert size Wendeschneidplatte	kg
PSC32-PDUNR/L17090-11	32	25	32	17	90	75	-6°	-11°	DN.. 1104..	0,360
PSC40-PDUNR/L17090-11	32	25	40	17	90	69	-6°	-11°	DN.. 1104..	0,480
PSC40-PDUNR/L22110-11	40	32	40	22	110	89	-6°	-10°	DN.. 1104..	0,750
PSC50-PDUNR/L17090-11	32	25	50	17	90	67	-6°	-11°	DN.. 1104..	0,700
PSC50-PDUNR/L22110-11	40	32	50	22	110	88	-6°	-10°	DN.. 1104..	0,930
PSC63-PDUNR/L17100-11	32	25	63	17	100	74	-6°	-11°	DN.. 1104..	1,000
PSC40-PDUNR/L27080-15	50	40	40	27	80	60	-6°	-11°	DN.. 1506..	0,740
PSC40-PDUNR/L27120-15	50	40	40	27	120	100	-6°	-11°	DN.. 1506..	1,130
PSC50-PDUNR/L27140-15	50	40	50	27	140	119	-6°	-11°	DN.. 1506..	1,470
PSC50-PDUNR/L35100-15	63	50	50	35	100	81	-6°	-10°	DN.. 1506..	1,480
PSC50-PDUNR/L35150-15	63	50	50	35	150	131	-6°	-10°	DN.. 1506..	2,250
PSC63-PDUNR/L22110-15	40	32	63	22	110	84	-6°	-12°	DN.. 1506..	1,260
PSC63-PDUNR/L27140-15	50	40	63	27	140	115	-6°	-11°	DN.. 1506..	1,780
PSC63-PDUNR/L35175-15	63	50	63	35	175	152	-6°	-10°	DN.. 1506..	2,850

Reference Bezeichnung									Nm
PSC32-PDUNR/L17090-11	8009	1606	5025	3711	4109	0009	3725	4135	2.0
PSC40-PDUNR/L17090-11	8009	1606	5025	3711	4109	0009	3725	4135	2.0
PSC40-PDUNR/L22110-11	8009	1606	5025	3711	4109	0009	3725	4135	2.0
PSC50-PDUNR/L17090-11	8009	1606	5025	3711	4109	0009	3725	4135	2.0
PSC50-PDUNR/L22110-11	8009	1606	5025	3711	4109	0009	3725	4135	2.0
PSC63-PDUNR/L17100-11	8009	1606	5025	3711	4109	0009	3725	4135	2.0
PSC40-PDUNR/L27080-15	8415	1638	5003	3715	4112	0012	3725	4135	3.0
PSC40-PDUNR/L27120-15	8415	1638	5003	3715	4112	0012	3725	4135	3.0
PSC50-PDUNR/L27140-15	8415	1638	5003	3715	4112	0012	3725	4135	3.0
PSC50-PDUNR/L35100-15	8415	1638	5003	3715	4112	0012	3725	4135	3.0
PSC50-PDUNR/L35150-15	8415	1638	5003	3715	4112	0012	3725	4135	3.0
PSC63-PDUNR/L22110-15	8415	1638	5003	3715	4112	0012	3725	4135	3.0
PSC63-PDUNR/L27140-15	8415	1638	5003	3715	4112	0012	3725	4135	3.0
PSC63-PDUNR/L35175-15	8415	1638	5003	3715	4112	0012	3725	4135	3.0

For DNM.. 1504.. inserts
Für Wendeschneidplatten DNM.. 1504..

DN..	55° rhombic negative inserts. 55° rhombische negative Wendeschneidplatten. A36-37		
Reference / Bez.	l	s	d
DN.. 1104..	11,60	4,76	9,52
DN.. 1506..	15,50	6,35	12,70

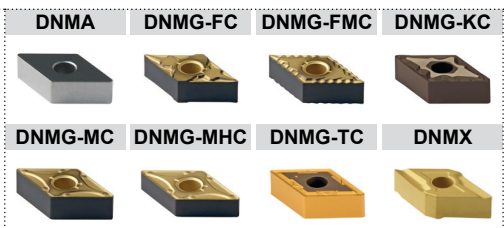
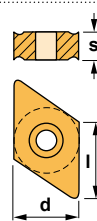



Characteristics:
Boring bar for internal turning applications equipped with square negative inserts.
PSC with internal coolant.

- 1) γ = Rake angle (valid with a flat insert).
- 2) λ_s = Angle of inclination.

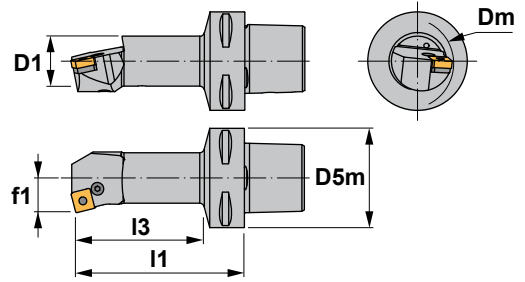

Eigenschaften:
Bohrstange zum Innendrehen mit einer vierkantigen negativen Wendeschneidplatte.
PSC mit Innenkühlung.

- 1) γ = Spanwinkel (Gültig nur mit flachen Wendeschneidplatte).
- 2) λ_s = Neigungswinkel.

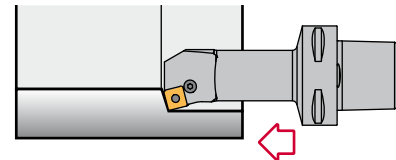

PSKN 75°

Reference Bezeichnung	Dm	D1	D5m	f1	I1	I3	γ^1	λ_s^2	Insert size Wendeschneidplatte	KG
PSC40-PSKNR/L17090-12	32	25	40	17	90	69	-6°	-11°	SNM.. 1204..	0,480
PSC50-PSKNR/L17090-12	32	25	50	17	90	67	-6°	-11°	SNM.. 1204..	0,700
PSC50-PSKNR/L22110-12	40	32	50	22	110	68	-6°	-10°	SNM.. 1204..	0,930
PSC50-PSKNR/L27140-12	50	40	50	27	140	119	-6°	-10°	SNM.. 1204..	1,470
PSC63-PSKNR/L22110-12	40	32	63	22	110	84	-6°	-10°	SNM.. 1204..	1,260

Reference Bezeichnung							Nm
PSC40-PSKNR/L17090-12	8212	1626	5025	-	-	-	2.0
PSC50-PSKNR/L17090-12	8212	1626	5025	-	-	-	2.0
PSC50-PSKNR/L22110-12	8312	1648	5003	3512	4112	0012	3.0
PSC50-PSKNR/L27140-12	8012	1608	5003	3512	4112	0012	3.0
PSC63-PSKNR/L22110-12	8012	1608	5003	3512	4112	0012	3.0

SNM.. Square negative inserts. Vierkantige negative Wendeschneidplatten. A41-42

Reference / Bez.	l	s	d
SNM.. 1204..	12,70	4,76	12,70

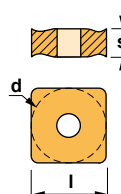

SNMG-FMC



SNMG-KC



SNMG-MHC



SNMG-RC



SNMG-TC



SNMM





SCLC 95°

Characteristics:

Multipurpose boring bar equipped with rhombic positive insert (angle 80°). PSC with internal coolant.

- 1) γ = Rake angle (valid with a flat insert).
- 2) λ_s = Angle of inclination.



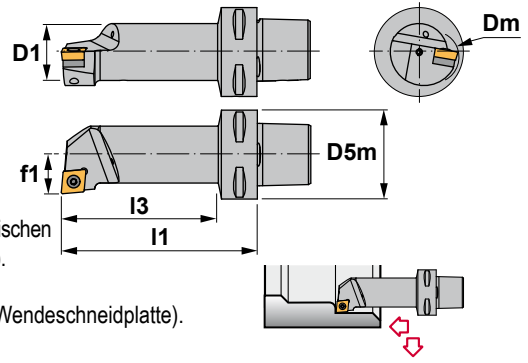

Eigenschaften:

Multifunktions-Bohrstange mit einer rhombischen positiven Wendeschneidplatte (80° Winkel). PSC mit Innenkühlung.

- 1) γ = Spanwinkel (Gültig nur mit flachen Wendeschneidplatte).
- 2) λ_s = Neigungswinkel.



Reference Bezeichnung	Dm	D1	D5m	f1	l1	l3	γ^1	λ_s^2	Insert size Wendeschneidplatte	kg
PSC32-SCLCR/L11065-09	20	16.0	32	11	65	48	0°	-12°	CC.. 09T3..	0,180
PSC32-SCLCR/L13075-09	25	20.0	32	13	75	59	0°	-8°	CC.. 09T3..	0,240
PSC32-SCLCR/L17090-09	32	25.0	32	17	90	75	0°	-6°	CC.. 09T3..	0,360
PSC40-SCLCR/L11070-09	20	16.0	40	11	70	47	0°	-12°	CC.. 09T3..	0,330
PSC40-SCLCR/L13080-09	25	20.0	40	13	80	58	0°	-8°	CC.. 09T3..	0,400
PSC40-SCLCR/L17090-09	32	25.0	40	17	90	69	0°	-6°	CC.. 09T3..	0,480
PSC40-SCLCR/L27080-09	50	39.7	40	27	80	60	0°	-6°	CC.. 09T3..	0,740
PSC50-SCLCR/L11070-09	20	16.0	50	11	70	46	0°	-12°	CC.. 09T3..	0,500
PSC50-SCLCR/L13080-09	25	20.0	50	13	80	56	0°	-8°	CC.. 09T3..	0,570
PSC50-SCLCR/L17090-09	32	25.0	50	17	90	67	0°	-6°	CC.. 09T3..	0,700
PSC50-SCLCR/L35100-09	63	49.7	50	35	100	81	0°	-4°	CC.. 09T3..	1,480
PSC32-SCLCR/L17090-12	32	25.0	32	17	90	75	0°	-6°	CC.. 1204..	0,360
PSC32-SCLCR/L22064-12	40	31.7	32	22	64	50	0°	-10°	CC.. 1204..	0,350
PSC32-SCLCR/L22096-12	40	34.7	32	22	96	82	0°	-10°	CC.. 1204..	0,550
PSC40-SCLCR/L17090-12	32	25.0	40	17	90	69	0°	-6°	CC.. 1204..	0,480
PSC40-SCLCR/L22110-12	40	32.0	40	22	110	89	0°	-10°	CC.. 1204..	0,750
PSC40-SCLCR/L27080-12	50	39.7	40	27	80	60	0°	-8°	CC.. 1204..	0,740
PSC50-SCLCR/L17090-12	32	25.0	50	17	90	67	0°	-6°	CC.. 1204..	0,700
PSC50-SCLCR/L22110-12	40	32.0	50	22	110	88	0°	-10°	CC.. 1204..	0,930
PSC50-SCLCR/L27140-12	50	40.0	50	27	140	119	0°	-8°	CC.. 1204..	1,470
PSC50-SCLCR/L35100-12	63	49.7	50	35	100	80	0°	-5°	CC.. 1204..	1,480

Reference Bezeichnung					Nm
PSC32-SCLCR/L.....-09	1440	5515	-	-	3.0
PSC40-SCLCR/L.....-09	1440	5515	-	-	3.0
PSC40-SCLCR/L17090-09	1240	5515	-	-	3.0
PSC40-SCLCR/L27080-09	1240	5515	-	-	3.0
PSC50-SCLCR/L.....-09	1440	5515	-	-	3.0
PSC50-SCLCR/L17090-09	1240	5515	-	-	3.0
PSC50-SCLCR/L35100-09	1240	5515	-	-	3.0
PSC32-SCLCR/L17090-12	1250	5515	-	-	3.0
PSC32-SCLCR/L22064-12	1540	5517	3614	1760	3.0
PSC32-SCLCR/L22096-12	1540	5517	3614	1760	3.0
PSC40-SCLCR/L17090-12	1250	5520	-	-	4.0
PSC40-SCLCR/L22110-12	1540	5517	3614	1760	3.0
PSC40-SCLCR/L27080-12	1540	5517	3614	1760	3.0
PSC50-SCLCR/L17090-12	1250	5520	-	-	4.0
PSC50-SCLCR/L22110-12	1540	5517	3614	1760	3.0
PSC50-SCLCR/L27140-12	1540	5517	3614	1760	3.0
PSC50-SCLCR/L35100-12	1540	5517	3614	1760	3.0

CC..

80° rhombic positive inserts with 7° clearance. 80° rhombische positive Wendeschneidplatten mit 7° Freiwinkel.  A30-31



Characteristics:
Multipurpose profiling boring bar equipped with rhombic positive insert (angle 55°). PSC with internal coolant.
1) γ = Rake angle (valid with a flat insert).
2) λ_s = Angle of inclination.

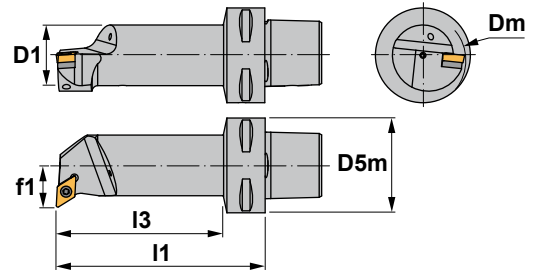

Eigenschaften:
Multifunktions-Bohrstange zum Profildrehen mit einer rhombischen positiven Wendeschneidplatte (55° Winkel). PSC mit Innenkühlung.
1) γ = Spanwinkel (Gültig nur mit flachen WSP).
2) λ_s = Neigungswinkel.

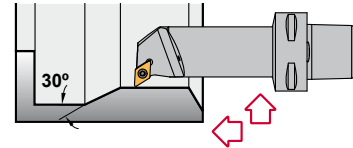

SDUC 93°

Reference Bezeichnung	Dm	D1	D5m	f1	l1	l3	γ^1	λ_{s2}	Insert size Wendeschneidplatte	KG
PSC32-SDUCR/L11065-07	20	16.0	32	11	65	48	0°	-6°	DC.. 0702..	0,180
PSC40-SDUCR/L11070-07	20	16.0	40	11	70	47	0°	-8°	DC.. 0702..	0,330
PSC50-SDUCR/L11070-07	20	16.0	50	11	70	46	0°	-8°	DC.. 0702..	0,500
PSC32-SDUCR/L13075-11	25	20.0	32	13	75	59	0°	-6°	DC.. 11T3..	0,240
PSC32-SDUCR/L17090-11	32	25.0	32	17	90	75	0°	-6°	DC.. 11T3..	0,360
PSC32-SDUCR/L22064-11	40	31.7	32	22	64	50	0°	-6°	DC.. 11T3..	0,350
PSC32-SDUCR/L22096-11	40	31.7	32	22	96	82	0°	-6°	DC.. 11T3..	0,550
PSC40-SDUCR/L13080-11	25	20.0	40	13	80	58	0°	-6°	DC.. 11T3..	0,400
PSC40-SDUCR/L17090-11	32	25.0	40	17	90	69	0°	-6°	DC.. 11T3..	0,480
PSC40-SDUCR/L22110-11	40	32.0	40	22	110	89	0°	-6°	DC.. 11T3..	0,750
PSC40-SDUCR/L27080-11	50	40.0	40	27	80	60	0°	-6°	DC.. 11T3..	0,740
PSC50-SDUCR/L13080-11	25	20.0	50	13	80	56	0°	-6°	DC.. 11T3..	0,570
PSC50-SDUCR/L17090-11	32	25.0	50	17	90	67	0°	-6°	DC.. 11T3..	0,700
PSC50-SDUCR/L22110-11	40	32.0	50	22	110	88	0°	-6°	DC.. 11T3..	0,930
PSC50-SDUCR/L35100-11	63	49.7	50	35	100	81	0°	-4°	DC.. 11T3..	1,480

Reference Bezeichnung					Nm
PSC32-SDUCR/L11065-07			1225	5507	0.9
PSC40-SDUCR/L11070-07			1225	5507	0.9
PSC50-SDUCR/L11070-07			1225	5507	0.9
PSC32-SDUCR/L13075-11			1240	5515	3.0
PSC32-SDUCR/L17090-11			1240	5515	3.0
PSC32-SDUCR/L22064-11			1335	5516	3.0
PSC32-SDUCR/L22096-11			1335	5516	3.0
PSC40-SDUCR/L13080-11			1240	5515	3.0
PSC40-SDUCR/L17090-11			1240	5515	3.0
PSC40-SDUCR/L22110-11			1335	5516	3.0
PSC40-SDUCR/L27080-11			1335	5516	3.0
PSC50-SDUCR/L13080-11			1240	5515	3.0
PSC50-SDUCR/L17090-11			1240	5515	3.0
PSC50-SDUCR/L22110-11			1335	5516	3.0
PSC50-SDUCR/L35100-11			1335	5516	3.0

DC.. 55° rhombic positive inserts with 7° clearance. A35
55° rhombische positive Wendeschneidplatten mit 7° Freiwinkel.

Reference / Bez.	l	s	d
DC.. 0702..	7,75	2,38	6,35
DC.. 11T3..	11,60	3,97	9,52

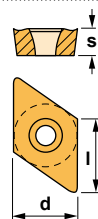

DCGT-AL



DCGT-AP



DCMT



DCMW

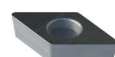



Characteristics:

Backwards multipurpose profiling boring bar equipped with rhombic positive insert (angle 55°). PSC with internal coolant.

- 1) γ = Rake angle (valid with a flat insert).
- 2) λ_s = Angle of inclination.

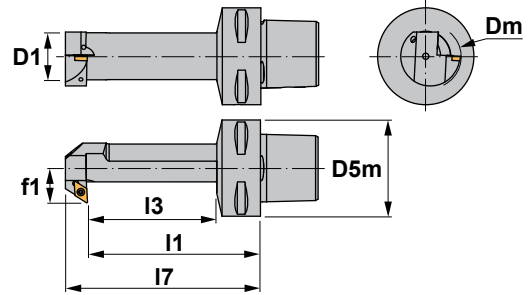

Eigenschaften:

Rückwärts-Multifunktions-Bohrstange zum Profildrehen mit einer rhombischen positiven Wendeschneidplatte (55° Winkel). PSC mit Innenkühlung.

- 1) γ = Spanwinkel (Gültig nur mit flachen Wendeschneidplatte).
- 2) λ_s = Neigungswinkel.

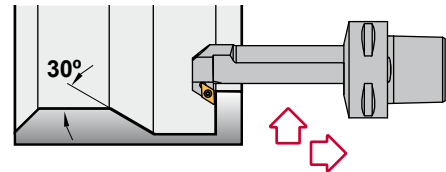

SDUC-X 93°

Reference Bezeichnung	Dm	D1	D5m	f1	I1	I3	I7	$\gamma^1)$	$\lambda_s^2)$	Insert size Wendeschneidplatte	
PSC32-SDUCR/L13070-07X	22	16	32	13	70	54	80.7	0°	-6°	DC.. 0702..	0,210
PSC32-SDUCR/L15080-07X	27	20	32	15	80	64	80.7	0°	-3°	DC.. 0702..	0,280
PSC40-SDUCR/L13070-07X	22	16	40	13	70	48	80.7	0°	-6°	DC.. 0702..	0,330
PSC40-SDUCR/L15080-07X	27	20	40	15	80	58	91.5	0°	-3°	DC.. 0702..	0,400
PSC40-SDUCR/L18090-07X	32	25	40	18	90	69	101.5	0°	-3°	DC.. 0702..	0,480
PSC50-SDUCR/L15080-07X	27	20	50	15	80	57	91.5	0°	-3°	DC.. 0702..	0,580
PSC50-SDUCR/L18090-07X	32	25	50	18	90	67	101.5	0°	-3°	DC.. 0702..	0,670

Reference Bezeichnung			Nm
PSC32-SDUCR/L13070-07X	1225	5507	0.9
PSC32-SDUCR/L15080-07X	1225	5507	0.9
PSC40-SDUCR/L13070-07X	1225	5507	0.9
PSC40-SDUCR/L15080-07X	1225	5507	0.9
PSC40-SDUCR/L18090-07X	1225	5507	0.9
PSC50-SDUCR/L15080-07X	1225	5507	0.9
PSC50-SDUCR/L18090-07X	1225	5507	0.9

DC.. 55° rhombic positive inserts with 7° clearance. A35
55° rhombische positive Wendeschneidplatten mit 7° Freiwinkel.

Reference / Bez.	l	s	d
DC.. 0702..	7,75	2,38	6,35

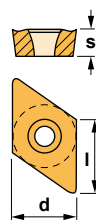

DCGT-AL **DCGT-AP**



DCMT

DCMW

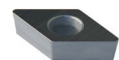



Characteristics:
Multipurpose boring bar equipped with square positive insert. PSC with internal coolant.

- 1) γ = Rake angle (valid with a flat insert).
- 2) λ_s = Angle of inclination.

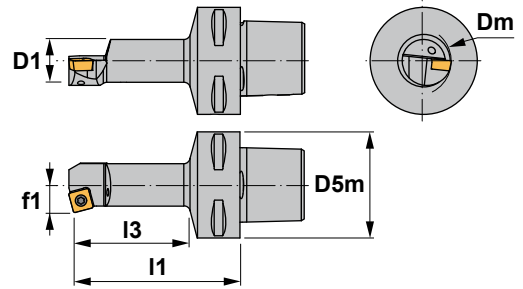

Eigenschaften:
Multifunktions-Bohrstange mit einer vierkantigen positiven Wendschneidplatte. PSC mit Innenkühlung.

- 1) γ = Spanwinkel (Gültig nur mit flachen Wendschneidplatte).
- 2) λ_s = Neigungswinkel.

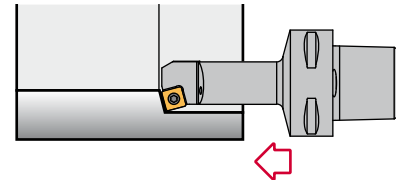

SSKC 75°

Reference Bezeichnung	Dm	D1	D5m	f1	l1	l3	γ^1	λ_{s2}	Insert size Wendschneidplatte	
PSC40-SSKCR/L13080-09	25	20	40	13	80	58	0°	-6°	SC.. 09T3..	0,400
PSC50-SSKCR/L13080-09	25	20	50	13	80	56	0°	-6°	SC.. 09T3..	0,570

Reference Bezeichnung			Nm
PSC40-SSKCR/L13080-09	1540	5517	3.0
PSC50-SSKCR/L13080-09	1540	5517	3.0

SC.. Square positive inserts with 7° clearance. A40
Vierkantige positive Wendschneidplatten mit 7° Freiwinkel.

Reference / Bez.	l	s	d
SC.. 09T3..	9,52	3,97	9,52

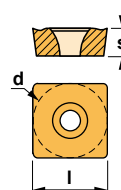

SCGT-AL



SCMT



SCMT-39





Characteristics:
Multipurpose boring bar equipped with triangular positive insert.
PSC with internal coolant.

- 1) γ = Rake angle (valid with a flat insert).
- 2) λ_s = Angle of inclination.

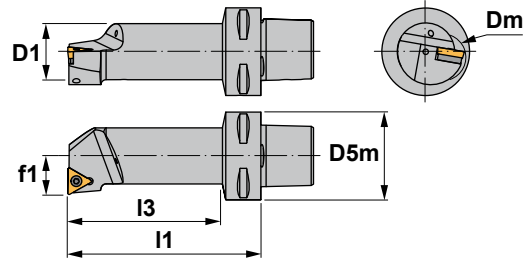

Eigenschaften:
Multifunktions-Bohrstange mit einer dreikantigen positiven Wendeschneidplatte.
PSC mit Innenkühlung.

- 1) γ = Spanwinkel (Gültig nur mit flachen Wendeschneidplatte).
- 2) λ_s = Neigungswinkel.

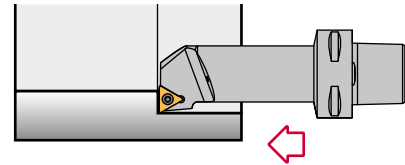

STFC 90°

Reference Bezeichnung	Dm	D1	D5m	f1	l1	l3	$\gamma^1)$	$\lambda_s^2)$	Insert size Wendeschneidplatte	
PSC32-STFCR/L11065-11	20	16	32	11	65	48	0°	-4°	TC.. 1102..	0,180
PSC32-STFCR/L13075-11	25	20	32	13	75	59	0°	-3°	TC.. 1102..	0,240
PSC40-STFCR/L11070-11	20	16	40	11	70	47	0°	-4°	TC.. 1102..	0,330
PSC40-STFCR/L13080-11	25	20	40	13	80	57	0°	-3°	TC.. 1102..	0,400
PSC50-STFCR/L11070-11	20	16	50	11	70	46	0°	-4°	TC.. 1102..	0,500
PSC50-STFCR/L13080-11	25	20	50	13	80	56	0°	-3°	TC.. 1102..	0,570
PSC32-STFCR/L17090-16	32	25	32	17	90	74	0°	-3.5°	TC.. 16T3..	0,360
PSC40-STFCR/L17090-16	32	25	40	17	90	69	0°	-6°	TC.. 16T3..	0,480
PSC40-STFCR/L22110-16	40	32	40	22	110	89	0°	-10°	TC.. 16T3..	0,750
PSC50-STFCR/L17090-16	32	25	50	17	90	67	0°	-6°	TC.. 16T3..	0,700
PSC50-STFCR/L22110-16	40	32	50	22	110	88	0°	-10°	TC.. 16T3..	0,930

Reference Bezeichnung					Nm
PSC32-STFCR/L11065-11	1225	5507	-	-	0.9
PSC32-STFCR/L13075-11	1225	5507	-	-	0.9
PSC40-STFCR/L11070-11	1225	5507	-	-	0.9
PSC40-STFCR/L13080-11	1225	5507	-	-	0.9
PSC50-STFCR/L11070-11	1225	5507	-	-	0.9
PSC50-STFCR/L13080-11	1225	5507	-	-	0.9
PSC32-STFCR/L17090-16	1240	5515	-	-	3.0
PSC40-STFCR/L17090-16	1240	5515	-	-	3.0
PSC40-STFCR/L22110-16	1335	5516	3414	1750	3.0
PSC50-STFCR/L17090-16	1240	5515	-	-	3.0
PSC50-STFCR/L22110-16	1335	5516	3414	1750	3.0

TC.. Triangular positive inserts with 7° clearance. Dreikantige positive Wendeschneidplatten mit 7° Freiwinkel. A44

Reference / Bez.	l	s	d
TC.. 1102..	11,00	2,38	6,35
TC.. 16T3..	16,50	3,97	9,52

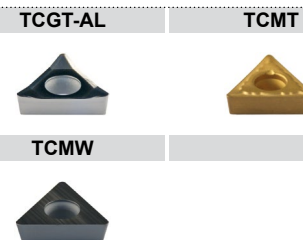
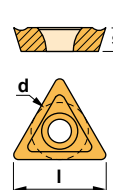



Characteristics:

Multipurpose profiling boring bar equipped with rhombic positive insert (angle 35°).

PSC with internal coolant.

1) γ = Rake angle (valid with a flat insert).

2) λ_s = Angle of inclination.

Eigenschaften:

Multifunktions-Bohrstange zum Profildrehen mit einer rhombischen positiven Wendeschneidplatte (35° Winkel). PSC mit Innenkühlung.

1) γ = Spanwinkel (Gültig nur mit flachen Wendeschneidplatte).

2) λ_s = Neigungswinkel.

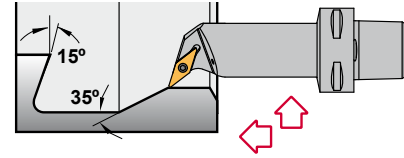
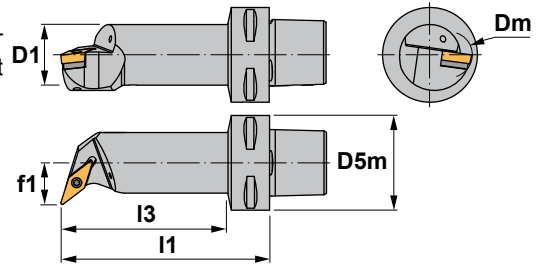

SVQB 107° 30'

Reference Bezeichnung	Dm	D1	D5m	f1	I1	I3	γ^1	λ_{s2}	Insert size Wendeschneidplatte	KG
PSC32-SVQBR/L18090-16	33	25.0	32	18	90	75	0°	-6°	VBMT 1604..	0,360
PSC32-SVQBR/L22064-16	40	31.7	32	22	64	49	0°	-7.5°	VBMT 1604..	0,350
PSC32-SVQBR/L22096-16	40	31.7	32	22	96	82	0°	-8°	VBMT 1604..	0,550
PSC40-SVQBR/L18090-16	33	25.0	40	18	90	69	0°	-6°	VBMT 1604..	0,480
PSC40-SVQBR/L22110-16	40	32.0	40	22	110	89	0°	-8°	VBMT 1604..	0,750
PSC40-SVQBR/L27080-16	50	40.0	40	27	80	60	0°	-8°	VBMT 1604..	0,740
PSC40-SVQBR/L27120-16	50	40.0	40	27	120	100	0°	-8°	VBMT 1604..	1,130
PSC50-SVQBR/L18090-16	33	25.0	50	18	90	67	0°	-6°	VBMT 1604..	0,670
PSC50-SVQBR/L22110-16	40	32.0	50	22	110	88	0°	-8°	VBMT 1604..	0,930
PSC50-SVQBR/L27140-16	50	40.0	50	27	140	119	0°	-8°	VBMT 1604..	1,470
PSC50-SVQBR/L35100-16	63	50.0	50	35	100	81	0°	-7°	VBMT 1604..	1,480
PSC50-SVQBR/L35150-16	63	50.0	50	35	150	131	0°	-7°	VBMT 1604..	2,250
PSC63-SVQBR/L22120-16	40	32.0	63	22	120	94	0°	-8°	VBMT 1604..	1,280
PSC63-SVQBR/L27145-16	50	40.0	63	27	145	120	0°	-8°	VBMT 1604..	1,780
PSC63-SVQBR/L35175-16	63	50.0	63	35	175	152	0°	-8°	VBMT 1604..	2,850

Reference Bezeichnung					Nm	
PSC32-SVQBR/L18090-16		1335	5516	3718	1750	3.0
PSC32-SVQBR/L22064-16		1335	5516	3718	1750	3.0
PSC32-SVQBR/L22096-16		1335	5516	3718	1750	3.0
PSC40-SVQBR/L18090-16		1335	5516	3718	1750	3.0
PSC40-SVQBR/L22110-16		1335	5516	3718	1750	3.0
PSC40-SVQBR/L27080-16		1335	5516	3718	1750	3.0
PSC40-SVQBR/L27120-16		1335	5516	3718	1750	3.0
PSC50-SVQBR/L18090-16		1335	5516	3718	1750	3.0
PSC50-SVQBR/L22110-16		1335	5516	3718	1750	3.0
PSC50-SVQBR/L27140-16		1335	5516	3718	1750	3.0
PSC50-SVQBR/L35100-16		1335	5516	3718	1750	3.0
PSC50-SVQBR/L35150-16		1335	5516	3718	1750	3.0
PSC63-SVQBR/L22120-16		1335	5516	3718	1750	3.0
PSC63-SVQBR/L27145-16		1335	5516	3718	1750	3.0
PSC63-SVQBR/L35175-16		1335	5516	3718	1750	3.0

VBMT

35° rhombic positive insert with 5° clearance. A48
35° rhombische positive Wendeschneidplatte mit 5° Freiwinkel.

Reference / Bez.	l	s	d
VBMT 1604..	16,50	4,76	9,52

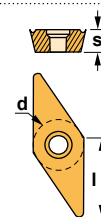

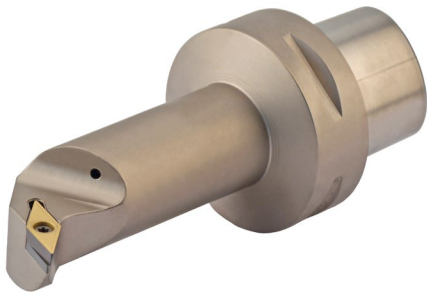

Characteristics:
Multipurpose profiling boring bar equipped with rhombic positive insert (angle 35°). PSC with internal coolant.

- 1) γ = Rake angle (valid with a flat insert).
- 2) λ_s = Angle of inclination.

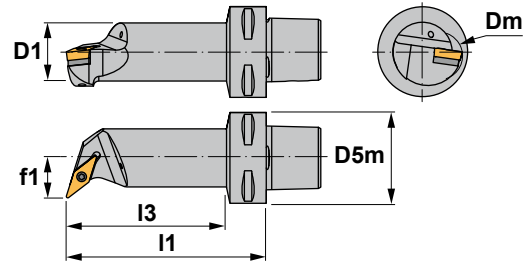

Eigenschaften:
Multifunktions-Bohrstange zum Profildrehen mit einer rhombischen positiven Wendeschneidplatte (35° Winkel). PSC mit Innenkühlung.

- 1) γ = Spanwinkel (Gültig nur mit flachen Wendeschneidplatte).
- 2) λ_s = Neigungswinkel.

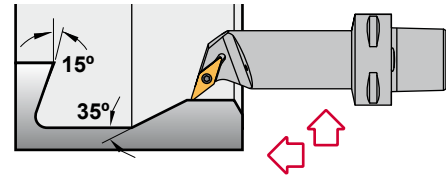

SVQC 107° 30'

Reference Bezeichnung	Dm	D1	D5m	f1	I1	I3	γ^1	λ_{s2}	Insert size Wendeschneidplatte	
PSC32-SVQCR/L13070-11	22	16	32	13	70	53.4	0°	-7°	VC.. 1103..	0,210
PSC32-SVQCR/L15080-11	27	20	32	15	80	63.9	0°	-5°	VC.. 1103..	0,280
PSC40-SVQCR/L13070-11	25	20	40	13	70	47.9	0°	-5.5°	VC.. 1103..	0,330
PSC40-SVQCR/L15080-11	27	20	40	15	80	57.9	0°	-5°	VC.. 1103..	0,400
PSC40-SVQCR/L18090-16	33	25	40	18	90	69.0	0°	-12°	VC.. 1604..	0,480
PSC40-SVQCR/L22110-16	40	32	40	22	110	89.0	0°	-8°	VC.. 1604..	0,750
PSC40-SVQCR/L27080-16	50	40	40	27	80	60.0	0°	-8°	VC.. 1604..	0,740
PSC40-SVQCR/L27120-16	50	40	40	27	120	100.0	0°	-8°	VC.. 1604..	1,130
PSC50-SVQCR/L18090-16	33	25	50	18	90	67.0	0°	-12°	VC.. 1604..	0,670
PSC50-SVQCR/L22110-16	40	32	50	22	110	88.0	0°	-8°	VC.. 1604..	0,930
PSC50-SVQCR/L27140-16	50	40	50	27	140	119.0	0°	-8°	VC.. 1604..	1,470
PSC50-SVQCR/L35100-16	63	50	50	35	100	81.0	0°	-7°	VC.. 1604..	1,480
PSC50-SVQCR/L35150-16	63	50	50	35	150	131.0	0°	-7°	VC.. 1604..	2,250
PSC63-SVQCR/L22120-16	40	32	63	22	120	94.0	0°	-8°	VC.. 1604..	1,280
PSC63-SVQCR/L27145-16	50	40	63	27	145	120.0	0°	-8°	VC.. 1604..	1,780
PSC63-SVQCR/L35175-16	63	50	63	35	175	152.0	0°	-8°	VC.. 1604..	2,850

Reference Bezeichnung					Nm
.....-11	1225	5507	-	-	0.9
.....-16	1335	5516	3718	1750	3.0

VC.. 35° rhombic positive inserts with 7° clearance. A48
35° rhombische positive Wendeschneidplatten mit 7° Freiwinkel.

Reference / Bez.	l	s	d
VC.. 1103..	11,00	3,18	6,35
VC.. 1604..	16,50	4,76	9,52

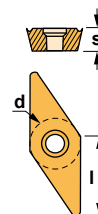

VCGT-AL



VCGT-AP



VCMT





Characteristics:
Multipurpose threading toolholder
for negative lay down inserts.
PSC with internal coolant.

Eigenschaften:
Multifunktions-Klemmhalter zum
Gewindedrehen für negative
Wendeschneidplatten.
PSC mit Innenkühlung.

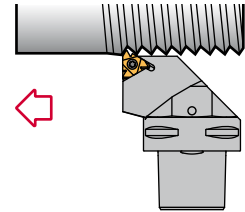
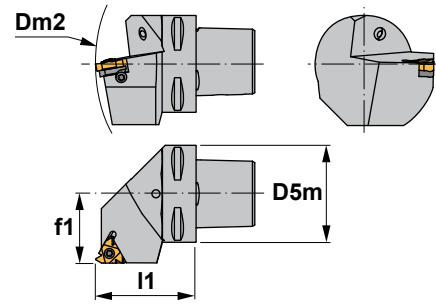

SE 90°

Reference Bezeichnung	D5m	Dm2 min.	f1	l1	Insert size Wendeschneidplatte	
PSC32-SER/L22040-16	32	124	22	40	16 ER/L..	0,210
PSC40-SER/L27050-16	40	140	27	50	16 ER/L..	0,420
PSC50-SER/L35060-16	50	165	35	60	16 ER/L..	0,800
PSC63-SER/L45065-16	63	190	45	65	16 ER/L..	1,100
PSC32-SER/L22040-22	32	124	22	40	22 ER/L..	0,210
PSC40-SER/L27050-22	40	140	27	50	22 ER/L..	0,420
PSC50-SER/L35060-22	50	165	35	60	22 ER/L..	0,800
PSC63-SER/L45065-22	63	190	45	65	22 ER/L..	1,100
PSC80-SER/L55080-22	80	250	55	80	22 ER/L..	2,740

WARNING!! Because of large thread profile, modification may have to be made to the toolholder to achieve full depth of thread.
ACHTUNG!! Bei großen Gewindeprofilen könnte eine Änderung im Klemmhalter erforderlich sein, um die volle Gewindetiefe zu erreichen.

Reference Bezeichnung			 R	 L		Nm
PSC32-SER/L22040-16	SA3	5510	YE3	YI3	SY3	2.0
PSC40-SER/L27050-16	SA3	5510	YE3	YI3	SY3	2.0
PSC50-SER/L35060-16	SA3	5510	YE3	YI3	SY3	2.0
PSC63-SER/L45065-16	SA3	5510	YE3	YI3	SY3	2.0
PSC32-SER/L22040-22	SA4	5520	YE4	YI4	SY4	4.0
PSC40-SER/L27050-22	SA4	5520	YE4	YI4	SY4	4.0
PSC50-SER/L35060-22	SA4	5520	YE4	YI4	SY4	4.0
PSC63-SER/L45065-22	SA4	5520	YE4	YI4	SY4	4.0
PSC80-SER/L55080-22	SA4	5520	YE4	YI4	SY4	4.0

E R/L

Triangular negative inserts for external threading.  C03,05,08,10
Dreikantige negative Wendeschneidplatten zum Außengewindedrehen.

Reference / Bez.	l	d
16 ER/L..	16,00	9,52
22 ER/L..	22,00	12,70

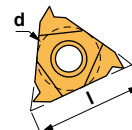

E R/L

E R/L TD

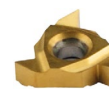

ER/L-LG

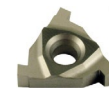

**Characteristics:**

Multipurpose threading boring bar for negative lay down inserts.
PSC with internal coolant.

Eigenschaften:

Multifunktions-Bohrstange zum Gewindedrehen für negative Wendeschneidplatten.
PSC mit Innenkühlung.

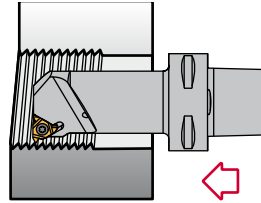
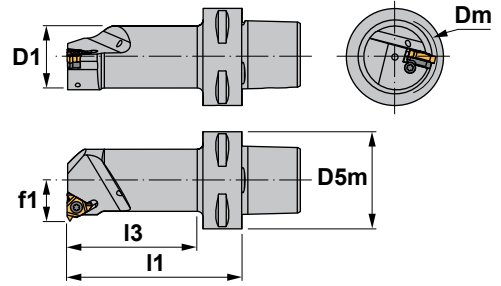
**SI 90°**

Reference Bezeichnung	D1	Dm	D5m	f1	I1	I3	Insert size Wendeschneidplatte						Nm	
PSC32-SIR/L12050-16	15.5	20	32	12	50	33	16 NR/L..	SN3	5510	-	-	-	2.0	0,210
PSC32-SIR/L22085-16	31.5	40	32	22	85	70	16 NR/L..	SA3	5510	YI3	YE3	SY3	2.0	0,510
PSC40-SIR/L12060-16	15.5	20	40	12	60	37	16 NR/L..	SN3	5510	-	-	-	2.0	0,300
PSC40-SIR/L14060-16	18.5	25	40	14	60	38	16 NR/L..	SA3T	5510	YI3	YE3	SY3	2.0	0,340
PSC40-SIR/L17070-16	24.5	32	40	17	70	48	16 NR/L..	SA3	5510	YI3	YE3	SY3	2.0	0,410
PSC40-SIR/L22090-16	32.0	40	40	22	90	69	16 NR/L..	SA3	5510	YI3	YE3	SY3	2.0	0,650
PSC40-SIR/L27080-16	39.5	50	40	27	80	60	16 NR/L..	SA3	5510	YI3	YE3	SY3	2.0	0,760
PSC50-SIR/L12060-16	15.5	20	50	12	60	35	16 NR/L..	SN3	5510	-	-	-	2.0	0,490
PSC50-SIR/L14060-16	18.5	25	50	14	60	36	16 NR/L..	SA3T	5510	YI3	YE3	SY3	2.0	0,510
PSC50-SIR/L17070-16	24.5	32	50	17	70	47	16 NR/L..	SA3	5510	YI3	YE3	SY3	2.0	0,590
PSC50-SIR/L22090-16	24.5	40	50	22	90	68	16 NR/L..	SA3	5510	YI3	YE3	SY3	2.0	0,820
PSC50-SIR/L27105-16	40.0	50	50	27	105	84	16 NR/L..	SA3	5510	YI3	YE3	SY3	2.0	1,200
PSC63-SIR/L14070-16	18.5	25	63	14	70	42	16 NR/L..	SA3T	5510	YI3	YE3	SY3	2.0	0,900
PSC63-SIR/L17075-16	24.5	32	63	17	75	48	16 NR/L..	SA3	5510	YI3	YE3	SY3	2.0	0,970
PSC63-SIR/L22090-16	32.0	40	63	22	90	64	16 NR/L..	SA3	5510	YI3	YE3	SY3	2.0	1,140
PSC63-SIR/L27105-16	40.0	50	63	27	105	80	16 NR/L..	SA3	5510	YI3	YE3	SY3	2.0	1,500
PSC40-SIR/L15065-22	18.5	25	40	15	65	42	22 NR/L..	SN4	5520	-	-	-	4.0	0,350
PSC40-SIR/L19070-22	25.0	32	40	19	70	48	22 NR/L..	SA4	5520	YI4	YE4	SY4	4.0	0,420
PSC40-SIR/L22090-22	31.5	40	40	22	90	69	22 NR/L..	SA4	5520	YI4	YE4	SY4	4.0	0,650
PSC40-SIR/L27080-22	39.5	50	40	27	80	60	22 NR/L..	SA4	5520	YI4	YE4	SY4	4.0	0,760
PSC50-SIR/L15065-22	18.5	25	50	15	65	41	22 NR/L..	SN4	5520	-	-	-	4.0	0,520
PSC50-SIR/L19070-22	25.0	32	50	19	70	47	22 NR/L..	SA4	5520	YI4	YE4	SY4	4.0	0,600
PSC50-SIR/L22090-22	31.5	40	50	22	90	68	22 NR/L..	SA4	5520	YI4	YE4	SY4	4.0	0,820
PSC50-SIR/L27105-22	40.0	50	50	27	105	84	22 NR/L..	SA4	5520	YI4	YE4	SY4	4.0	1,200
PSC63-SIR/L19075-22	25.0	32	63	19	75	48	22 NR/L..	SA4	5520	YI4	YE4	SY4	4.0	0,970
PSC63-SIR/L22090-22	31.5	40	63	22	90	64	22 NR/L..	SA4	5520	YI4	YE4	SY4	4.0	1,140
PSC63-SIR/L27105-22	40.0	50	63	27	105	80	22 NR/L..	SA4	5520	YI4	YE4	SY4	4.0	1,500

WARNING!! Because of large thread profile, modification may have to be made to the boring bar to achieve full depth of thread.
ACHTUNG!! Bei großen Gewindeprofilen könnte eine Änderung in der Bohrstange erforderlich sein, um die volle Gewindetiefe zu erreichen.

N R/L

Triangular negative inserts for internal threading.
Dreieckige negative Wendeschneidplatten zum Innengewindedrehen. C04,06,07,09,10

Reference / Bez.

l

d

16 NR/L..

16,00

9,52

22 NR/L..

22,00

12,70

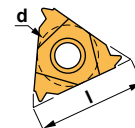
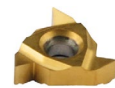
**N R/L****N R/L TD**



Characteristics:

Parting, grooving and side turning toolholder for modular blades CZFD. Double-sided inserts 2 to 6 mm thickness. PSC with internal coolant.

Eigenschaften:

Klemmhalter zum Ein- und Abstechen und Längsdrehen für modulare Kassetten CZFD. Zweiseitige Wendeschneidplatten von 2 bis 6 mm Dicke. PSC mit Innenkühlung.

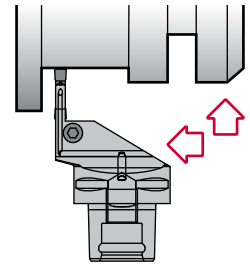
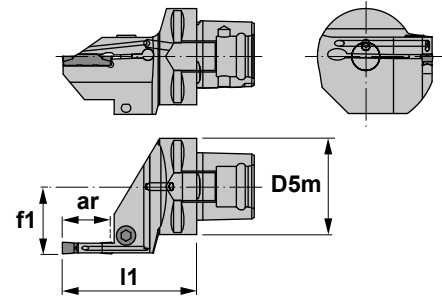

CZCD

Reference Bezeichnung	D5m	f1	l1	ar max	Insert size Wendeschneidplatte		Nm	
PSC32-CZCDR/L22055-02	32	22	55	15	WDM.. 02	1296 5005	4.0	0,250
PSC40-CZCDR/L27055-02	40	27	55	15	WDM.. 02	1096 5005	4.0	0,430
PSC50-CZCDR/L35060-02	50	35	60	15	WDM.. 02	1096 5005	4.0	0,800
PSC32-CZCDR/L22055-03	32	22	55	20	WDM.. 03	1296 5005	4.0	0,250
PSC40-CZCDR/L27060-03	40	27	60	20	WDM.. 03	1096 5005	4.0	0,480
PSC50-CZCDR/L35060-03	50	35	60	20	WDM.. 03	1096 5005	4.0	0,800
PSC63-CZCDR/L45065-03	63	45	65	20	WDM.. 03	1096 5005	4.0	1,100
PSC32-CZCDR/L22060-04	32	22	60	20	WDM.. 04	1296 5005	4.0	0,260
PSC40-CZCDR/L27067-04	40	27	67	25	WDM.. 04	1096 5005	4.0	0,440
PSC50-CZCDR/L35067-04	50	35	67	25	WDM.. 04	1096 5005	4.0	0,800
PSC63-CZCDR/L45070-04	63	45	70	25	WDM.. 04	1096 5005	4.0	1,350
PSC40-CZCDR/L27067-05	40	27	67	25	WDM.. 05	1096 5005	4.0	0,440
PSC50-CZCDR/L35067-05	50	35	67	25	WDM.. 05	1096 5005	4.0	0,800
PSC63-CZCDR/L45070-05	63	45	70	25	WDM.. 05	1096 5005	4.0	1,350
PSC40-CZCDR/L27070-06	40	27	70	25	WDM.. 06	1096 5005	4.0	0,440
PSC50-CZCDR/L35070-06	50	35	70	25	WDM.. 06	1096 5005	4.0	0,780
PSC63-CZCDR/L45075-06	63	45	75	25	WDM.. 06	1096 5005	4.0	1,430

For modular blades CZFD, see pages B23 to B24.
Für modulare Kassetten CZFD, siehe Seiten B23 bis B24.

WDM..



Reference / Bez.	s
WDM.. 02	2,0
WDM.. 03	3,0
WDM.. 04	4,0
WDM.. 05	5,0
WDM.. 06	6,0

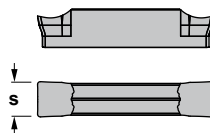

WDMG: Insert for grooving.
WDMP: Insert for parting.
WDMR: Insert for parting with radius.
WDMT: Insert for turning.
WDMG: Wendeschneidplatte zum Einstechen.
WDMP: Wendeschneidplatte zum Abstechen.
WDMR: Wendeschneidplatte zum Vollradius-Stechen.
WDMT: Wendeschneidplatte zum Drehen.

WDMG

WDMP



WDMR

WDMT

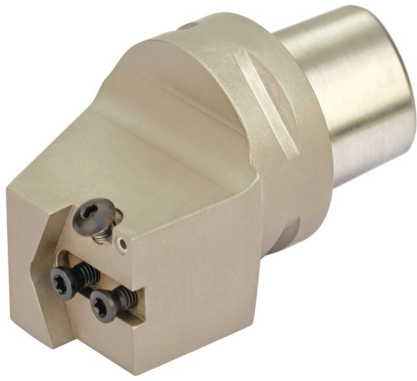

**Characteristics:**

Parting, grooving and side turning toolholder for modular blades CZFD.
Double-sided inserts 2 to 6 mm thickness.
PSC with internal coolant.



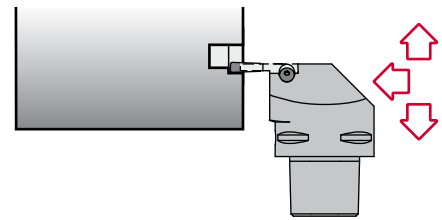
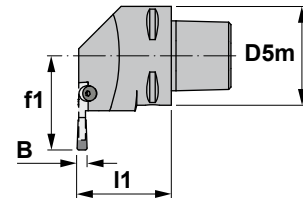
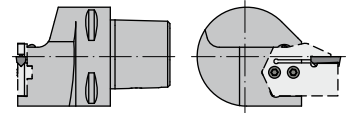

Eigenschaften:

Klemmhalter zum Ein- und Abstechen und Längsdrehen für modulare Kassetten CZFD.
Zweiseitige Wendeschneidplatten von 2 bis 6 mm Dicke.
PSC mit Innenkühlung.



CZFD

Reference Bezeichnung	D5m	f1	l1	B	
PSC32-CZFDR/L09050	32	9	50	2-6	0,250
PSC40-CZFDR/L14050	40	14	50	2-6	0,430
PSC50-CZFDR/L22050	50	22	55	2-6	0,800
PSC63-CZFDR/L32060	63	32	60	2-6	1,100

Reference Bezeichnung					Nm
PSC32-CZFDR/L09050	1815	1450	5003	5520	3.0
PSC40-CZFDR/L14050	1815	1450	5003	5520	3.0
PSC50-CZFDR/L22050	1815	1450	5003	5520	3.0
PSC63-CZFDR/L32060	1815	1450	5003	5520	3.0

For modular blades CZFD, see pages B23 to B24.
Für modulare Kassetten CZFD, siehe Seiten B23 bis B24.

Modular blades / Modulare Stechschwerter CZFD







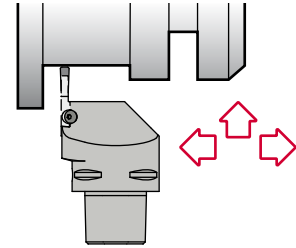
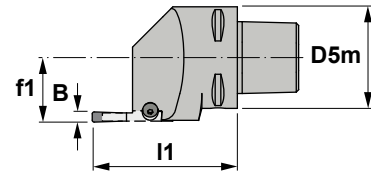
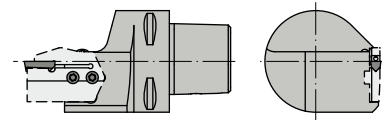

Characteristics:
Parting, grooving and side turning toolholder for modular blades CZFD.
Double-sided inserts 2 to 6 mm thickness.
PSC with internal coolant.

Eigenschaften:
Klemmhalter zum Ein- und Abstechen und Längsdrehen für modulare Kassetten CZFD.
Zweiseitige Wendschneidplatten von 2 bis 6 mm Dicke.
PSC mit Innenkühlung.



CZGD

Reference Bezeichnung	D5m	f1	I1	B	
PSC32-CZGDR/L17042	32	17	42	2-6	0,250
PSC40-CZGDR/L22042	40	22	42	2-6	0,430
PSC50-CZGDR/L30047	50	30	47	2-6	0,800
PSC63-CZGDR/L40052	63	40	52	2-6	1,100

Reference Bezeichnung					Nm
PSC32-CZGDR/L17042	1815	1450	5003	5520	3.0
PSC40-CZGDR/L22042	1815	1450	5003	5520	3.0
PSC50-CZGDR/L30047	1815	1450	5003	5520	3.0
PSC63-CZGDR/L40052	1815	1450	5003	5520	3.0

For modular blades CZFD, see pages B23 to B24.
Für modulare Kassetten CZFD, siehe Seiten B23 bis B24.

Modular blades / Modulare Stechschwerter CZFD

WDM.. 02
WDM.. 03
WDM.. 04
WDM.. 05
WDM.. 06





CZGD

Right-handed holders use
right-handed modular blades.

Auf rechten Haltern werden rechte modulare
Stechschwerter montiert.

WDM.. 03
WDM.. 04
WDM.. 05
WDM.. 06







Characteristics:
 Multipurpose grooving and threading top clamp toolholder.
 Right tools require left inserts and vice versa.
 PSC with internal coolant.

Eigenschaften:
 Multifunktionaler Klemmhalter zum Einstechen und Gewindedrehen mit Top Notch Klemmung.
 Rechte Werkzeuge erfordern linke Wendeschneidplatten und umgekehrt.
 PSC mit Innenkühlung.

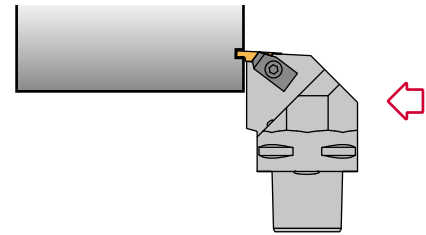
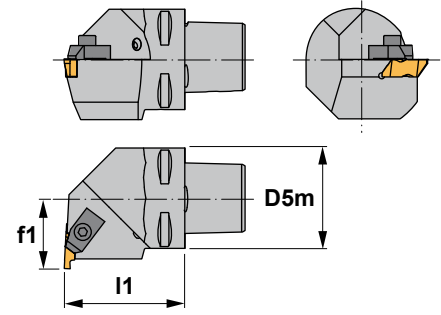

NE 93°

Reference Bezeichnung	D5m	f1	l1	Insert size Wendeschneidplatte	kg
PSC40-NER/L27050-03	40	27	50	N.. 3	0,420
PSC50-NER/L35060-03	50	35	60	N.. 3	0,800
PSC63-NER/L45065-03	63	45	65	N.. 3	1,100

Reference Bezeichnung					Nm
PSC40-NER/L27050-03	TF-73	TF-72	5004	1495	3.5
PSC50-NER/L35060-03	TF-73	TF-72	5004	1495	3.5
PSC63-NER/L45065-03	TF-73	TF-72	5004	1495	3.5

N..

B09-10

Reference / Bez.	s
N.. 3	4,95

NG: Insert for grooving. NG: Einstechwendschneidplatte.
 NR: Insert for parting with radius. NR: Vollradius-Stechplatte.
 NT: Insert for threading. NT: Gewindewendschneidplatte.

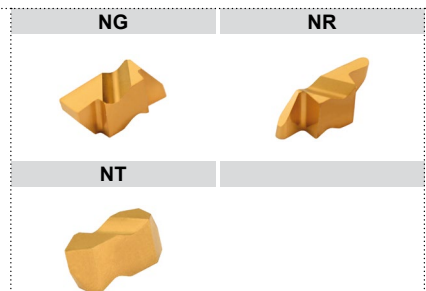
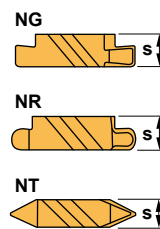



Characteristics:

Specific application grooving toolholder.
Right tools require left inserts and vice versa.

PSC with internal coolant.

Eigenschaften:

Klemmhalter zum Einstecken für spezifische Anwendungen.

Rechte Werkzeuge erfordern linke Wendeschneidplatten und umgekehrt.
PSC mit Innenkühlung.

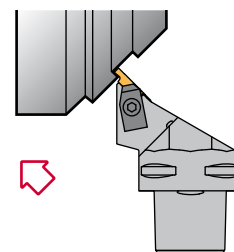
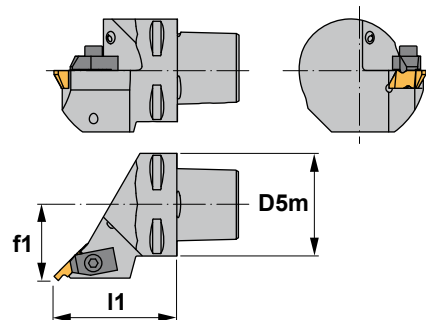

NR 45°

Reference Bezeichnung	D5m	f1	l1	Insert size Wendeschneidplatte	Kg
PSC40-NRR/L27055-03	40	27	55	N.. 3	0,430
PSC50-NRR/L35060-03	50	35	60	N.. 3	0,800
PSC63-NRR/L45065-03	63	45	65	N.. 3	1,100

Reference Bezeichnung					Nm
PSC40-NRR/L27055-03	TF-73	TF-72	5004	1495	3.5
PSC50-NRR/L35060-03	TF-73	TF-72	5004	1495	3.5
PSC63-NRR/L45065-03	TF-73	TF-72	5004	1495	3.5

N..

B09-10

Reference / Bez.

s

N.. 3

4,95

NG: Insert for grooving.
NR: Insert for parting with radius.
NT: Insert for threading.

NG: Einstechwendeschneidplatte.
NR: Vollradius-Stechplatte.
NT: Gewindewendeschneidplatte.

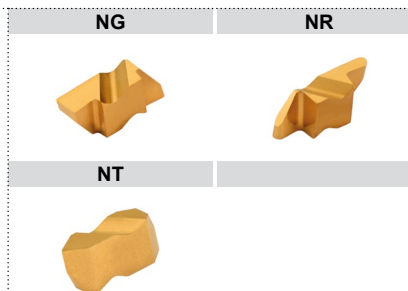
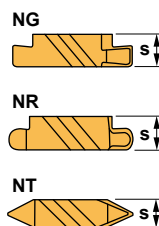

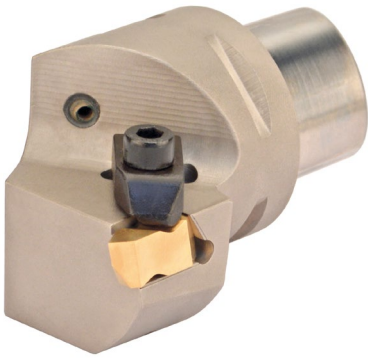
**Characteristics:**

Multipurpose grooving and threading
top clamp toolholder.
PSC with internal coolant.

Eigenschaften:

Multifunktionaler Klemmhalter zum
Einstechen und Gewindedrehen
mit Top Notch Klemmung.
PSC mit Innenkühlung.

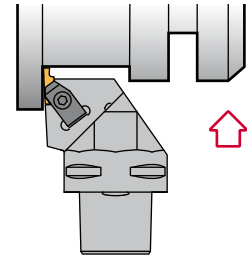
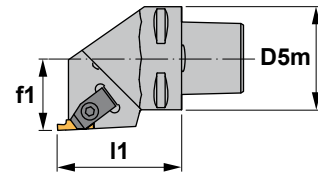
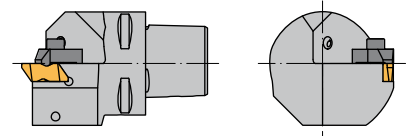
**NS 93°**

Reference Bezeichnung	D5m	f1	l1	Insert size Wendeschneidplatte	Kg
PSC32-NSR22040-02	32	22	40	N.. 2	0,210
PSC40-NSR/L27050-02	40	27	50	N.. 2	0,420
PSC32-NSR22045-03	32	22	45	N.. 3	0,240
PSC40-NSR/L27050-03	40	27	50	N.. 3	0,420
PSC50-NSR/L35060-03	50	35	60	N.. 3	0,800
PSC63-NSR/L45065-03	63	45	65	N.. 3	1,100
PSC40-NSR/L27055-04	40	27	55	N.. 4	0,430
PSC50-NSR/L35060-04	50	35	60	N.. 4	0,800
PSC63-NSR/L45065-04	63	45	65	N.. 4	1,100

Reference Bezeichnung							Nm
PSC32-NSR22040-02	TF-74	TF-75	-	-	5003	1494	3.0
PSC40-NSR/L27050-02	TF-74	TF-75	-	-	5003	1494	3.0
PSC32-NSR22045-03	TF-72	TF-73	-	-	5004	1495	3.5
PSC40-NSR/L27050-03	TF-72	TF-73	-	-	5004	1495	3.5
PSC50-NSR/L35060-03	TF-72	TF-73	-	-	5004	1495	3.5
PSC63-NSR/L45065-03	TF-72	TF-73	-	-	5004	1495	3.5
PSC40-NSR/L27055-04	TF-72	TF-73	3521	1625	5004	1495	3.5
PSC50-NSR/L35060-04	TF-72	TF-73	3521	1625	5004	1495	3.5
PSC63-NSR/L45065-04	TF-72	TF-73	3521	1625	5004	1495	3.5

N..

B09-10

Reference / Bez.

s

N.. 2	3,81
N.. 3	4,95
N.. 4	6,48

NG: Insert for grooving. NG: Einstechwendschneidplatte.
NR: Insert for parting with radius. NR: Vollradius-Stechplatte.
NT: Insert for threading. NT: Gewindewendschneidplatte.



NG

NR



NT





Characteristics:
Multipurpose grooving and threading top clamp boring bar.
Right tools require left inserts and vice versa.
PSC with internal coolant.

Eigenschaften:
Multifunktionale Bohrstanze zum Einstecken und Gewindedrehen mit Top Notch Klemmung.
Rechte Werkzeuge erfordern linke Wendeschneidplatten und umgekehrt.
PSC mit Innenkühlung.

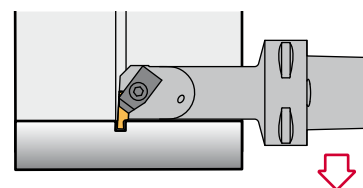
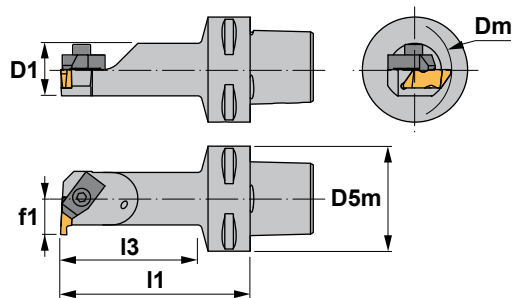

NNTO 93°

Reference Bezeichnung	Dm	D1	D5m	f1	I1	I3	Insert size Wendeschneidplatte	
PSC40-NNTOR/L11070-02	22	16	40	11	70	47	N.. 2	0,330
PSC40-NNTOR/L13080-02	26	20	40	13	80	58	N.. 2	0,400
PSC50-NNTOR/L11070-02	22	16	50	11	70	46	N.. 2	0,500
PSC50-NNTOR/L13080-02	26	20	50	13	80	56	N.. 2	0,570
PSC50-NNTOR/L17090-02	34	25	50	17	90	67	N.. 2	0,700
PSC40-NNTOR/L17090-03	34	25	40	17	90	69	N.. 3	0,480
PSC50-NNTOR/L17090-03	34	25	50	17	90	67	N.. 3	0,700
PSC50-NNTOR/L22110-03	44	32	50	22	110	88	N.. 3	0,930
PSC63-NNTOR/L27140-04	54	40	63	27	140	115	N.. 4	1,780
PSC63-NNTOR/L35175-04	70	50	63	35	175	152	N.. 4	2,850

Reference Bezeichnung					Nm
PSC40-NNTOR/L11070-02	TF-147	TF-146	5003	1494	3.0
PSC40-NNTOR/L13080-02	TF-75	TF-146	5003	1494	3.0
PSC50-NNTOR/L11070-02	TF-75	TF-146	5003	1494	3.0
PSC50-NNTOR/L13080-02	TF-75	TF-146	5003	1494	3.0
PSC50-NNTOR/L17090-02	TF-75	TF-146	5003	1494	3.0
PSC40-NNTOR/L17090-03	TF-73	TF-72	5004	1495	3.5
PSC50-NNTOR/L17090-03	TF-73	TF-72	5004	1495	3.5
PSC50-NNTOR/L22110-03	TF-73	TF-72	5004	1495	3.5
PSC63-NNTOR/L27140-04	TF-73	TF-72	5004	1495	3.5
PSC63-NNTOR/L35175-04	TF-73	TF-72	5004	1495	3.5

N..

B09-10

Reference / Bez.	s
N.. 2	3,81
N.. 3	4,95
N.. 4	6,48

NG: Insert for grooving. NG: Einstechwendeschneidplatte.
NR: Insert for parting with radius. NR: Vollradius-Stechplatte.
NT: Insert for threading. NT: Gewindewendeschneidplatte.

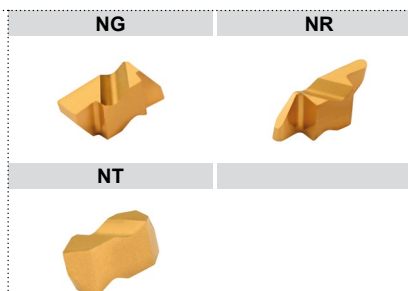
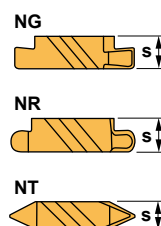

**Characteristics:**

Helical flute indexable insert drills provide faster cutting speeds and efficient chip removal for use on conventional and C.N.C. machines. This type of drills incorporates a neutral-rake geometry and screw-down square inserts for stability and clean through-hole putting. PSC with internal coolant. Max. hole depth = 3xDiameter (D)

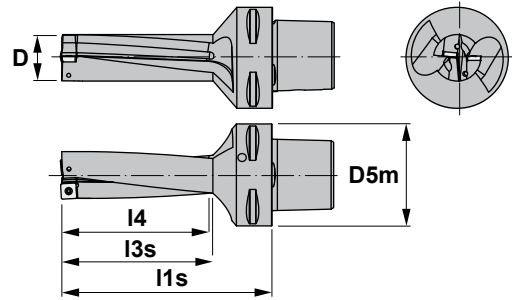
**Eigenschaften:**

Die Spiralbohrer für Wendeschneidplatten erbringen schnellere Schnittgeschwindigkeiten und eine effiziente Spanabfuhr bei konventionellen und C.N.C. Maschinen. Dieser Bohrertyp benutzt verschraubte vierkantige Wendeschneidplatten mit neutralem Spanwinkel, was Stabilität und saubere Durchgangsbohrungen erbringt. PSC mit Innenkühlung. Maximale Bohrtiefe = 3xDrm. (D)

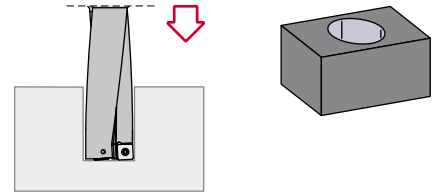
**45..**

Reference Bezeichnung	D5m	D	l1s	l3s	l4	Radial Adj. Dmax	Insert size Wendeschneidplatte		Nm	
PSC40-4514.15	40	15,0	82	48	45	+0,40↻15,8	SPMT 0603..	1225 5507	0.9	0,330
PSC40-4514.16	40	16,0	86	51	48	+0,30↻16,6	SPMT 0603..	1225 5507	0.9	0,360
PSC40-4514.17	40	17,0	89	54	51	+0,60↻18,2	SPMT 0603..	1225 5507	0.9	0,370
PSC40-4514.17,5	40	17,5	92	56	53	+0,50↻18,5	SPMT 0603..	1225 5507	0.9	0,380
PSC40-4514.18	40	18,0	93	57	54	+0,40↻18,8	SPMT 0603..	1225 5507	0.9	0,390
PSC40-4514.18,5	40	18,5	95	59	56	+0,40↻19,3	SPMT 0603..	1225 5507	0.9	0,400
PSC40-4514.19	40	19,0	96	60	57	+0,30↻19,6	SPMT 0603..	1225 5507	0.9	0,410
PSC40-4514.20	40	20,0	101	64	60	+0,90↻21,8	SPMT 0603..	1225 5507	0.9	0,440
PSC40-4524.21	40	21,0	104	66	63	+0,80↻22,6	SPMT 0703..	1225 5507	0.9	0,460
PSC40-4524.22	40	22,0	107	69	66	+0,60↻23,2	SPMT 0703..	1225 5507	0.9	0,490
PSC40-4524.23	40	23,0	111	72	69	+0,50↻24,0	SPMT 0703..	1225 5507	0.9	0,520
PSC40-4524.24	40	24,0	115	76	72	+1,10↻26,2	SPMT 0703..	1225 5507	0.9	0,560
PSC40-4524.25	40	25,0	119	79	75	+1,00↻27,0	SPMT 0703..	1225 5507	0.9	0,590
PSC40-4534.26	40	26,0	122	81	78	+0,90↻27,8	SPMT 0903..	1230 5508	1.2	0,640
PSC40-4534.27	40	27,0	125	84	81	+0,70↻28,4	SPMT 0903..	1230 5508	1.2	0,680
PSC40-4534.28	40	28,0	129	87	84	+0,60↻29,2	SPMT 0903..	1230 5508	1.2	0,720
PSC40-4534.29	40	29,0	132	90	87	+0,50↻30,0	SPMT 0903..	1230 5508	1.2	0,760
PSC40-4534.30	40	30,0	137	94	90	+1,12↻32,2	SPMT 0903..	1230 5508	1.2	0,810

SPMT

Square positive insert with 11° clearance. H02
Vierkantige positive Wendeschneidplatte mit 11° Freiwinkel.

Reference / Bez.	l	s	d
SPMT 060304	6,35	3,18	6,35
SPMT 070308	7,94	3,18	7,94
SPMT 090308	9,52	3,18	9,52

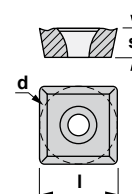
**SPMT**



Characteristics:



Helical flute indexable insert drills provide faster cutting speeds and efficient chip removal for use on conventional and C.N.C. machines.

Eigenschaften:

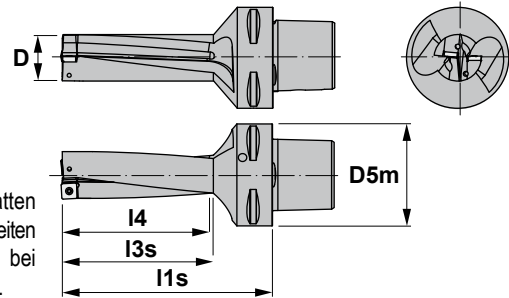
Die Spiralbohrer für Wendeschneidplatten erbringen schnellere Schnittgeschwindigkeiten und eine effiziente Spanabfuhr bei konventionellen und C.N.C. Maschinen.



45.. 

Reference Bezeichnung	D5m	D	l1s	l3s	l4	Radial Adj. Dmax	Insert size Wendeschneidplatte	 	Nm	
PSC50-4514.15	50	15,0	82	48	45	+0,40↔15,8	SPMT 0603..	1225 5507	0.9	0,580
PSC50-4514.16	50	16,0	86	51	48	+0,30↔16,6	SPMT 0603..	1225 5507	0.9	0,590
PSC50-4514.17	50	17,0	89	54	51	+0,60↔18,2	SPMT 0603..	1225 5507	0.9	0,600
PSC50-4514.17,5	50	17,5	92	56	53	+0,50↔18,5	SPMT 0603..	1225 5507	0.9	0,600
PSC50-4514.18	50	18,0	93	57	54	+0,40↔18,8	SPMT 0603..	1225 5507	0.9	0,600
PSC50-4514.18,5	50	18,5	95	59	56	+0,40↔19,3	SPMT 0603..	1225 5507	0.9	0,600
PSC50-4514.19	50	19,0	96	60	57	+0,30↔19,6	SPMT 0603..	1225 5507	0.9	0,610
PSC50-4514.20	50	20,0	101	64	60	+0,90↔21,8	SPMT 0603..	1225 5507	0.9	0,640
PSC50-4524.21	50	21,0	104	66	63	+0,80↔22,6	SPMT 0703..	1225 5507	0.9	0,650
PSC50-4524.22	50	22,0	107	69	66	+0,60↔23,2	SPMT 0703..	1225 5507	0.9	0,670
PSC50-4524.23	50	23,0	111	72	69	+0,50↔24,0	SPMT 0703..	1225 5507	0.9	0,700
PSC50-4524.24	50	24,0	115	76	72	+1,10↔26,2	SPMT 0703..	1225 5507	0.9	0,740
PSC50-4524.25	50	25,0	119	79	75	+1,00↔27,0	SPMT 0703..	1225 5507	0.9	0,780
PSC50-4534.26	50	26,0	122	81	78	+0,90↔27,8	SPMT 0903..	1230 5508	1.2	0,820
PSC50-4534.27	50	27,0	125	84	81	+0,70↔28,4	SPMT 0903..	1230 5508	1.2	0,820
PSC50-4534.28	50	28,0	129	87	84	+0,60↔29,2	SPMT 0903..	1230 5508	1.2	0,900
PSC50-4534.29	50	29,0	132	90	87	+0,50↔30,0	SPMT 0903..	1230 5508	1.2	0,950
PSC50-4534.30	50	30,0	137	94	90	+1,12↔32,2	SPMT 0903..	1230 5508	1.2	1,010
PSC50-4534.31	50	31,0	141	97	93	+0,99↔33,0	SPMT 0903..	1230 5508	1.2	1,060
PSC50-4534.32	50	32,0	144	100	96	+0,87↔33,7	SPMT 0903..	1230 5508	1.2	1,110
PSC50-4534.33	50	33,0	148	103	99	+0,75↔34,5	SPMT 0903..	1230 5508	1.2	1,180
PSC50-4534.34	50	34,0	151	106	102	+0,62↔35,2	SPMT 0903..	1230 5508	1.2	1,260
PSC50-4544.35	50	35,0	155	109	105	+0,50↔36,0	SPMT 1204..	1250 5520	4.0	1,330
PSC50-4544.36	50	36,0	159	112	108	+1,38↔38,8	SPMT 1204..	1250 5520	4.0	1,420
PSC50-4544.37	50	37,0	162	115	111	+1,25↔39,5	SPMT 1204..	1250 5520	4.0	1,470
PSC50-4544.38	50	38,0	166	118	114	+1,13↔40,2	SPMT 1204..	1250 5520	4.0	1,580
PSC50-4544.39	50	39,0	169	121	117	+1,00↔41,0	SPMT 1204..	1250 5520	4.0	1,640
PSC50-4544.40	50	40,0	173	124	120	+0,88↔41,8	SPMT 1204..	1250 5520	4.0	2,040
PSC50-4544.41	50	41,0	177	127	123	+0,75↔42,5	SPMT 1204..	1250 5520	4.0	2,040
PSC50-4544.42	50	42,0	186	130	126	+0,63↔43,2	SPMT 1204..	1250 5520	4.0	2,040
PSC50-4544.43	50	43,0	190	133	129	+0,50↔44,0	SPMT 1204..	1250 5520	4.0	2,150

SPMT

Square positive insert with 11° clearance.  H02
Vierkantige positive Wendeschneidplatte mit 11° Freiwinkel.

Reference / Bez.	l	s	d
SPMT 060304	6,35	3,18	6,35
SPMT 070308	7,94	3,18	7,94
SPMT 090308	9,52	3,18	9,52
SPMT 120408	12,70	4,76	12,70

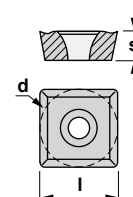

SPMT





**Characteristics:**

Helical flute indexable insert drills provide faster cutting speeds and efficient chip removal for use on conventional and C.N.C. machines.

Eigenschaften:

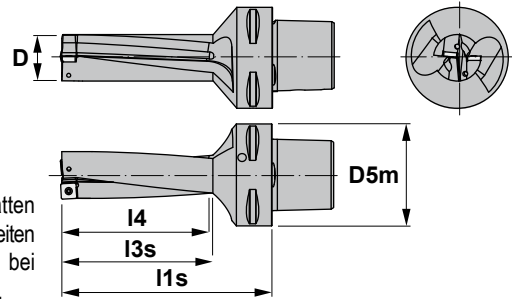
Die Spiralbohrer für Wendeschneidplatten erbringen schnellere Schnittgeschwindigkeiten und eine effiziente Spanabfuhr bei konventionellen und C.N.C. Maschinen.

**45..**

Reference Bezeichnung	D5m	D	l1s	l3s	l4	Radial Adj. Dmax	Insert size Wendeschneidplatte		Nm	
PSC63-4514.15	63	15,0	84	48	45	+0,40⇒15,8	SPMT 0603..	1225 5507	0.9	0,840
PSC63-4514.16	63	16,0	88	51	48	+0,30⇒16,6	SPMT 0603..	1225 5507	0.9	0,860
PSC63-4514.17	63	17,0	91	54	51	+0,60⇒18,2	SPMT 0603..	1225 5507	0.9	0,870
PSC63-4514.17,5	63	17,5	94	56	53	+0,50⇒18,5	SPMT 0603..	1225 5507	0.9	0,880
PSC63-4514.18	63	18,0	95	57	54	+0,40⇒18,8	SPMT 0603..	1225 5507	0.9	0,880
PSC63-4514.18,5	63	18,5	97	59	56	+0,40⇒19,3	SPMT 0603..	1225 5507	0.9	0,900
PSC63-4514.19	63	19,0	98	60	57	+0,30⇒19,6	SPMT 0603..	1225 5507	0.9	0,900
PSC63-4514.20	63	20,0	103	64	60	+0,90⇒21,8	SPMT 0603..	1225 5507	0.9	0,930
PSC63-4524.21	63	21,0	106	66	63	+0,80⇒22,6	SPMT 0703..	1225 5507	0.9	0,960
PSC63-4524.22	63	22,0	109	69	66	+0,60⇒23,2	SPMT 0703..	1225 5507	0.9	0,970
PSC63-4524.23	63	23,0	113	72	69	+0,50⇒24,0	SPMT 0703..	1225 5507	0.9	1,010
PSC63-4524.24	63	24,0	117	76	72	+1,10⇒26,2	SPMT 0703..	1225 5507	0.9	1,040
PSC63-4524.25	63	25,0	121	79	75	+1,00⇒27,0	SPMT 0703..	1225 5507	0.9	1,080
PSC63-4534.26	63	26,0	124	81	78	+0,90⇒27,8	SPMT 0903..	1230 5508	1.2	1,120
PSC63-4534.27	63	27,0	127	84	81	+0,70⇒28,4	SPMT 0903..	1230 5508	1.2	1,160
PSC63-4534.28	63	28,0	131	87	84	+0,60⇒29,2	SPMT 0903..	1230 5508	1.2	1,210
PSC63-4534.29	63	29,0	134	90	87	+0,50⇒30,0	SPMT 0903..	1230 5508	1.2	1,260
PSC63-4534.30	63	30,0	139	94	90	+1,12⇒32,2	SPMT 0903..	1230 5508	1.2	1,320
PSC63-4534.31	63	31,0	143	97	93	+0,99⇒33,0	SPMT 0903..	1230 5508	1.2	1,370
PSC63-4534.32	63	32,0	146	100	96	+0,87⇒33,7	SPMT 0903..	1230 5508	1.2	1,430
PSC63-4534.33	63	33,0	150	103	99	+0,75⇒34,5	SPMT 0903..	1230 5508	1.2	1,500
PSC63-4534.34	63	34,0	153	106	102	+0,62⇒35,2	SPMT 0903..	1230 5508	1.2	1,560
PSC63-4544.35	63	35,0	157	109	105	+0,50⇒36,0	SPMT 1204..	1250 5520	4.0	1,630
PSC63-4544.36	63	36,0	161	112	108	+1,38⇒38,8	SPMT 1204..	1250 5520	4.0	1,710
PSC63-4544.37	63	37,0	164	115	111	+1,25⇒39,5	SPMT 1204..	1250 5520	4.0	1,790
PSC63-4544.38	63	38,0	168	118	114	+1,13⇒40,2	SPMT 1204..	1250 5520	4.0	1,880
PSC63-4544.39	63	39,0	171	121	117	+1,00⇒41,0	SPMT 1204..	1250 5520	4.0	1,940
PSC63-4544.40	63	40,0	175	124	120	+0,88⇒41,8	SPMT 1204..	1250 5520	4.0	2,040
PSC63-4544.41	63	41,0	179	127	123	+0,75⇒42,5	SPMT 1204..	1250 5520	4.0	2,160
PSC63-4544.42	63	42,0	182	130	126	+0,63⇒43,2	SPMT 1204..	1250 5520	4.0	2,270
PSC63-4544.43	63	43,0	186	133	129	+0,50⇒44,0	SPMT 1204..	1250 5520	4.0	2,350

SPMT

Square positive insert with 11° clearance.  H02
Vierkantige positive Wendeschneidplatte mit 11° Freiwinkel.

Reference / Bez.	l	s	d
SPMT 060304	6,35	3,18	6,35
SPMT 070308	7,94	3,18	7,94
SPMT 090308	9,52	3,18	9,52
SPMT 120408	12,70	4,76	12,70

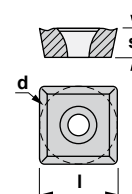
**SPMT**

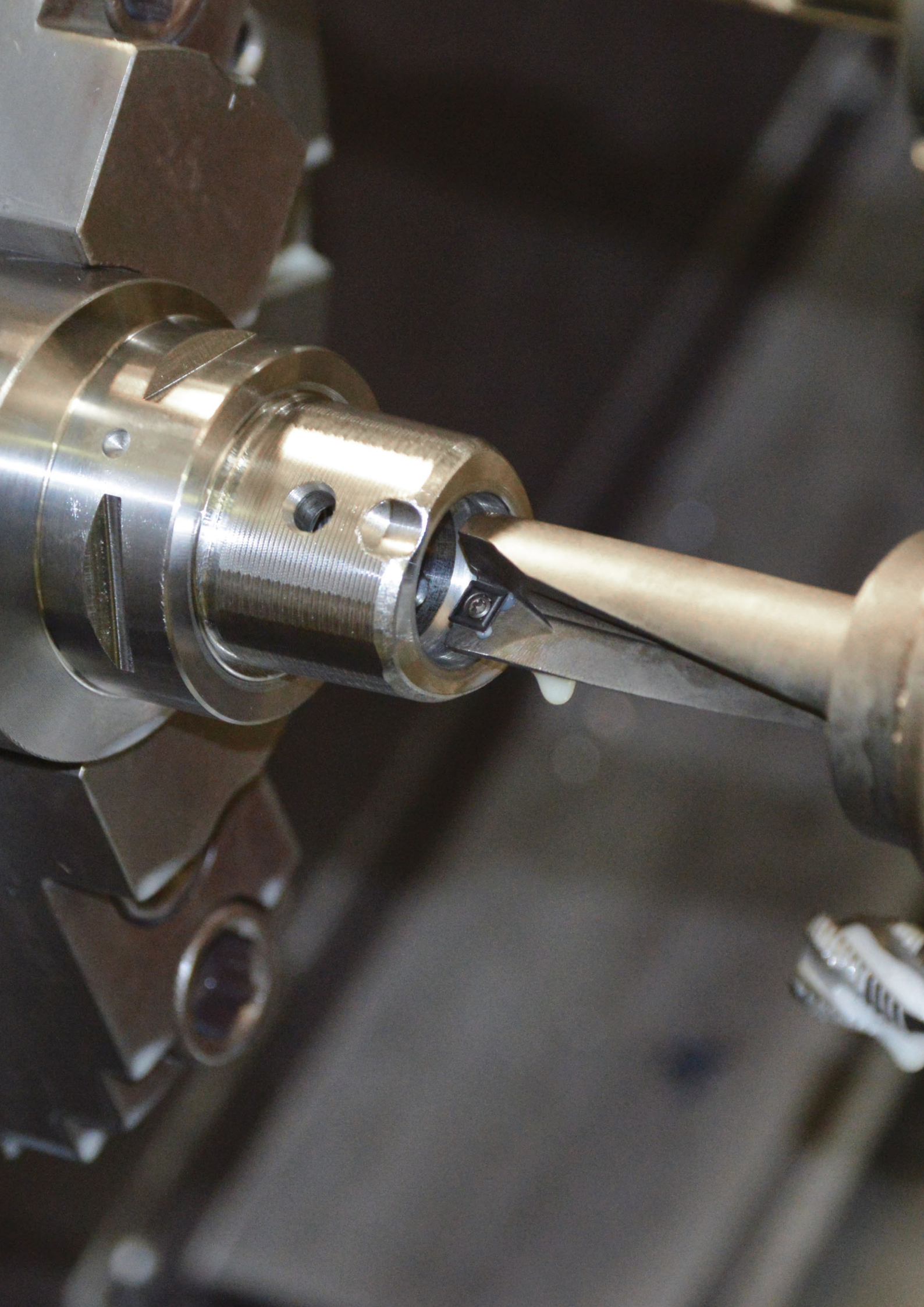

CANELA also offers a full range of adapters.

CANELA bietet auch eine breite Palette von Adaptern an.

13
ISO 7388
DIN 69871/A

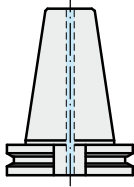

16
HSK
DIN 69893-1

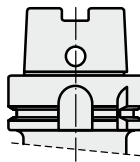

23
ISO
JIS B 6339-BT

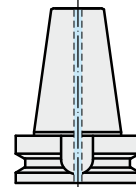

18.218
EXTENSION
VERLÄNGERUNG REDUCER
REDUZIERHÜLSE

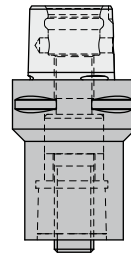
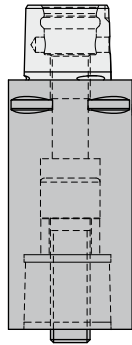

18.160 18.180 18.215 18.296 18.306 18.315 18.400 18.406 18.453 18.455

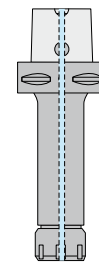
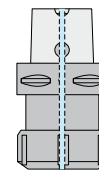
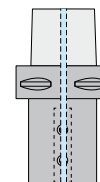
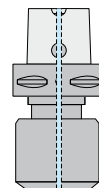
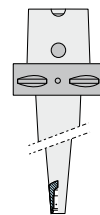
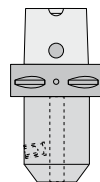
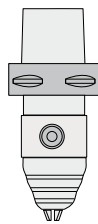
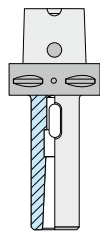
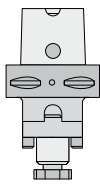
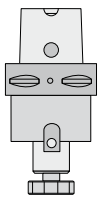

18.470 18.500 18.510 18.520 18.530 18.540 18.550 18.620 18.999

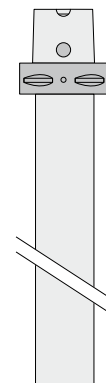
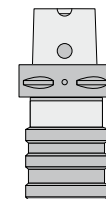
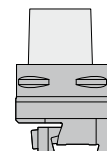
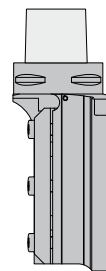
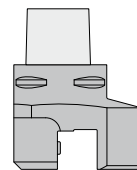
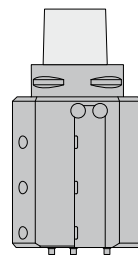
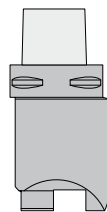
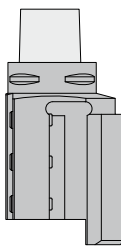
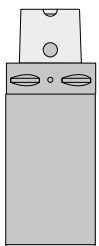

Code system / Kodifizierung

18 **160** **050** **16**

1 **2** **3** **4**



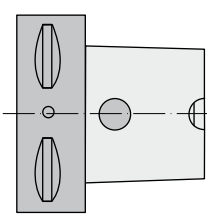

1 *Model*
Modell

PSC ISO 26623-1

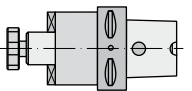
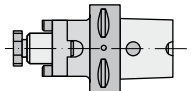
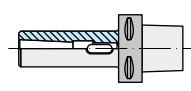
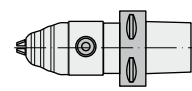
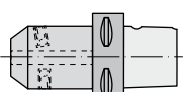
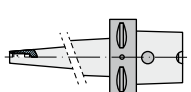
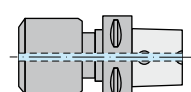
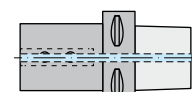
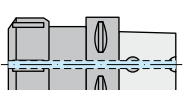
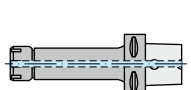

18

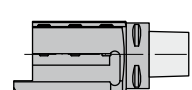
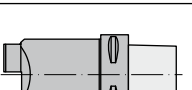
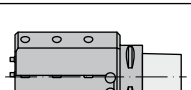
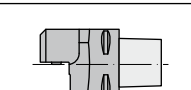
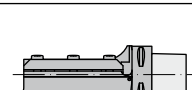
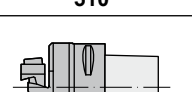
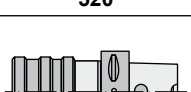
2 *Arbor type*
Aufnahmen-Typ

 160	 180	 215	 296
 306	 315	 400	 406
 453	 455	 470	 500
 510	 520	 530	 540
 550	 620	 999	

3 *Arbor size*
Aufnahmegröße

PSC ISO 26623-1

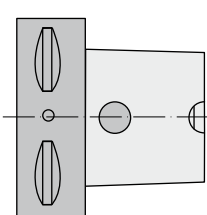

32 | 40 | 50 | 63 | 80 | 100

4 *Adaptor size*
Adaptergröße

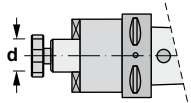
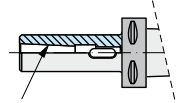
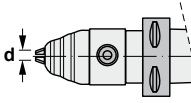
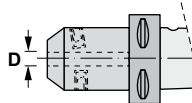
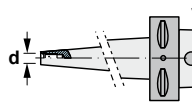
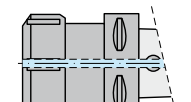
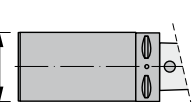
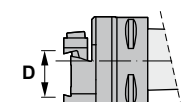
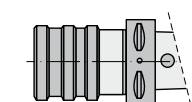
 Ø 16 ... Ø 60 16 ... 60	<i>K₁ - MORSE</i>  MK2 MK3 MK4 MK5 02 03 04 05	 Ø 13 Ø 16 13 16	 Ø 25 ... Ø 100 25 ... 100	 M M M M M8 M10 M12 M16
 ER16 ... ER50 16 ... 50	 D Ø 32 ... Ø 200 32 ... 200	 D Ø 20 ... Ø 50 20 ... 50	 M3-M12 M8-M20 M14-M33 12 20 33	



AT3 TECHNICAL CHARACTERISTICS OF THE TOOLHOLDERS AT3 TECHNISCHE EIGENSCHAFTEN DER AUFNAHMEN

MATERIAL:

- Chromium-manganese carburised steel 1.7131 (16MnCr5).

EXECUTION:

- Carburised, hardened and tempered.
- Surface hardness HRC 58±2 (670±40 HV30)
- Depth of carburised layer minimum 0,5 mm.
- Tensile strength in core minimum 800 N/mm² after carburizing.

ACCURACY:

- Taper according to DIN 254
- Taper angle:
tolerance AT 3 DIN 7178 part 1 and DIN 2080 part 1.
- Other tolerances according to DIN 7160 and 7168.
- Taper surface roughness RZ<0,001 mm.

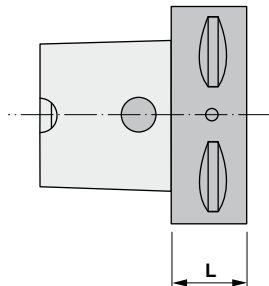

TOLERANCE AT:

- Indicates the tolerance of measuring plane D between the real and the theoretical value of the taper conicity.
- This value of measuring plane D must always be less (negative), never more (positive) in order to GUARANTEE a good toolholder fixation at the bigger taper diameter.

MATERIALIEN:

- Legierter aufgekohlter Stahl mit Chrom-Mangan 1.7131 (16MnCr5).

KONSTRUKTIONS DATEN:

- Aufgekühlt, gehärtet und angelassen.
- Oberflächenhärte HRC 58±2 (670±40 HV30)
- Aufgekühlt auf minimum 0,5 mm Tiefe.
- Zugfestigkeit im Kern minimum 800 N/mm² nach der Aufkohlung.

GENAUIGKEIT:

- Dorn nach DIN 254
- Kegelminkel:
Toleranz AT 3 DIN 7178 Teil 1 und DIN 2080 Teil 1.
- Andere Toleranzen entsprechend DIN 7160 und 7168.
- Rauigkeit der Oberfläche RZ<0,001 mm.

K	AT3 mm
ISO 30	0,002
ISO 40	0,003
ISO 45	0,003
ISO 50	0,004
ISO 60	0,005

TOLERANZ AT:



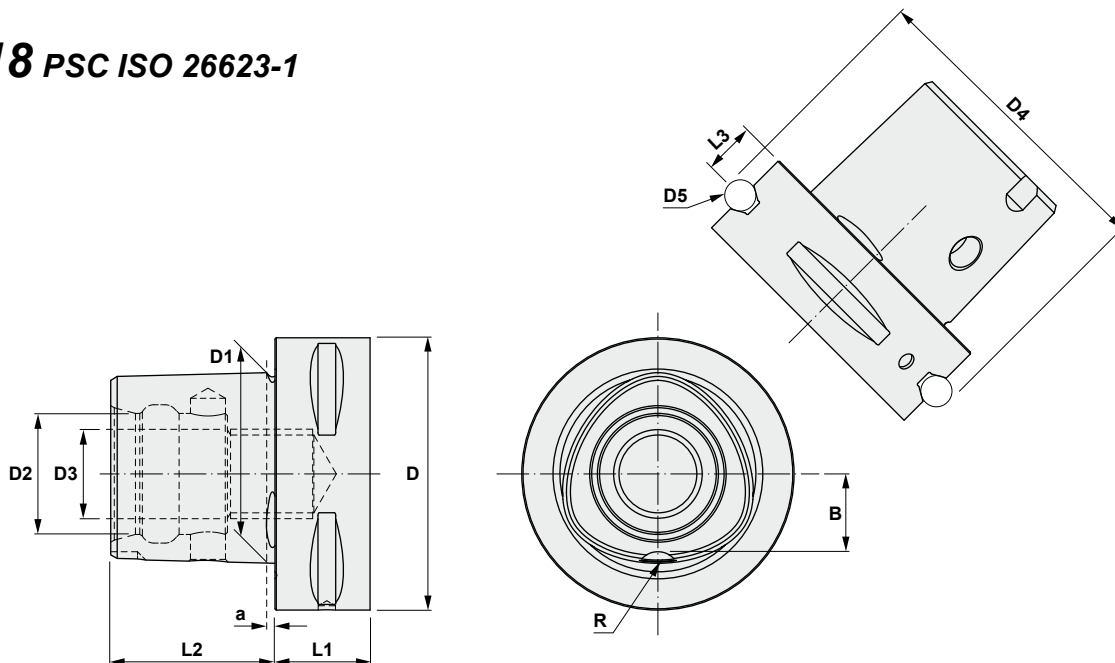

- Zeigt die Toleranz auf der Messebene D zwischen dem tatsächlichen Wert der Kegelonizität und dem theoretischen Wert.
- Dieser Wert auf der Messebene D sollte immer minus (negativ) sein, nie plus (positiv), um für einen guten Halt des Futter in den größeren Durchmesser des Kegels zu GARANTIEREN.

18 PSC ISO 26623-1



PSC	D	D1	D2	D3	D4	D5	L1 min	L2	L3	a	B	R
32	32	22	15	M12 x 1,5	39,0	5	15	19	6	2,5	9,0	3
40	40	28	18	M14 x 1,5	46,0	5	20	24	8	2,5	11,0	3
50	50	35	21	M16 x 1,5	59,3	7	20	30	10	3,0	14,0	4
63	63	44	28	M20 x 2,0	70,7	7	22	38	12	3,0	18,0	5
80	80	55	32	M20 x 2,0	86,0	7	30	48	12	3,0	22,2	6
100	100	72	43	M24 x 2,0	110,0	10	32	60	16	3,0	29,2	6

Arbors and adaptors PSC ISO 26623-1
Aufnahmen PSC ISO 26623-1

<p>18.160</p>  <p>Page / Seite E100</p>	<p>18.180</p>  <p>Page / Seite E101</p>	<p>18.215</p>  <p>Page / Seite E102</p>	<p>18.296</p>  <p>Page / Seite E103</p>	<p>18.306</p>  <p>Page / Seite E104</p>
<p>18.315</p>  <p>Page / Seite E105</p>	<p>18.400</p>  <p>Page / Seite E106</p>	<p>18.406</p>  <p>Page / Seite E107</p>	<p>18.453</p>  <p>Page / Seite E108</p>	<p>18.455</p>  <p>Page / Seite E109</p>
<p>18.470</p>  <p>Page / Seite E110</p>	<p>18.500</p>  <p>Page / Seite E111</p>	<p>18.510</p>  <p>Page / Seite E112</p>	<p>18.520</p>  <p>Page / Seite E113</p>	<p>18.530</p>  <p>Page / Seite E114</p>
<p>18.540</p>  <p>Page / Seite E115</p>	<p>18.550</p>  <p>Page / Seite E116</p>	<p>18.620</p>  <p>Page / Seite E117</p>	<p>18.999</p>  <p>Page / Seite E118</p>	
<p>13.218</p>  <p>Page / Seite E119</p>	<p>16.218</p>  <p>Page / Seite E120</p>	<p>18.218 Extension Verlängerung</p>  <p>Page / Seite E121</p>	<p>18.218 Reducer Reduzierhülse</p>  <p>Page / Seite E122</p>	<p>23.218</p>  <p>Page / Seite E123</p>
<p>18.700</p>  <p>Page / Seite E124</p>	<p>MC</p>  <p>Page / Seite E125</p>	<p>AC</p>  <p>Page / Seite E125</p>		







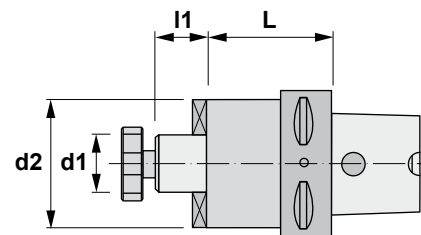

Characteristics:
Shell mill adaptor.
PSC ISO 26623-1
For cutters with driving slot DIN 138.

Eigenschaften:
Aufsteckfräsdorne.
PSC ISO 26623-1
Für Fräser mit Quernut DIN 138.



18.160

Reference Bezeichnung	PSC	d1 h6	L	l1	d2				
18.160.040.16	40	16	55	17	37	10008	86016	11103	0,560
18.160.040.22	40	22	55	19	47	10010	86022	11004	0,770
18.160.050.16	50	16	60	17	37	10008	86016	11103	0,780
18.160.050.22	50	22	60	19	47	10010	86022	11004	1,020
18.160.050.27	50	27	60	21	58	10012	86027	11005	1,270
18.160.050.32	50	32	60	24	63	10016	86032	11105	1,500
18.160.063.16	63	16	63	17	37	10008	86016	11103	1,070
18.160.063.22	63	22	25	19	47	10010	86122	11004	0,820
18.160.063.22/100	63	22	100	19	47	10010	86022	11004	1,810
18.160.063.27	63	27	25	21	58	10012	86127	11005	0,850
18.160.063.27/100	63	27	100	21	58	10012	86027	11005	2,390
18.160.063.32	63	32	25	24	63	10016	86132	11105	0,890
18.160.063.32/100	63	32	100	24	63	10016	86032	11105	2,710
18.160.063.40	63	40	40	27	89	10020	80040	11006	1,770
18.160.063.40/100	63	40	100	27	70	10020	86040	11006	3,230
18.160.080.16	80	16	50	17	37	10008	86016	11103	1,900
18.160.080.22	80	22	30	19	47	10010	86122	11004	1,760
18.160.080.22/100	80	22	100	19	47	10010	86022	11004	2,710
18.160.080.27	80	27	30	21	58	10012	86127	11005	1,790
18.160.080.27/100	80	27	100	21	58	10012	86027	11005	3,240
18.160.080.32	80	32	30	24	63	10016	86132	11105	1,830
18.160.080.32/100	80	32	100	24	63	10016	86032	11105	3,530
18.160.080.40	80	40	40	27	63	10020	86140	11006	2,380
18.160.080.40/100	80	40	100	27	70	10020	86040	11006	4,000
18.160.080.60	80	60	60	40	130	-	80060	11012	5,420
18.160.100.16	100	16	50	17	37	10008	86016	11103	3,260
18.160.100.22	100	22	50	19	47	10010	86022	11004	3,380
18.160.100.22/100	100	22	100	19	47	10010	86022	11004	4,050
18.160.100.27	100	27	50	21	58	10012	86027	11005	3,530
18.160.100.27/100	100	27	100	21	58	10012	86027	11005	4,560
18.160.100.32	100	32	50	24	63	10016	86032	11105	3,890
18.160.100.32/100	100	32	100	24	63	10016	86032	11105	5,860
18.160.100.40	100	40	50	27	63	10020	86040	11006	3,980
18.160.100.40/100	100	40	100	27	63	10020	86040	11006	5,940
18.160.100.60	100	60	70	40	130	-	80060	11012	7,610





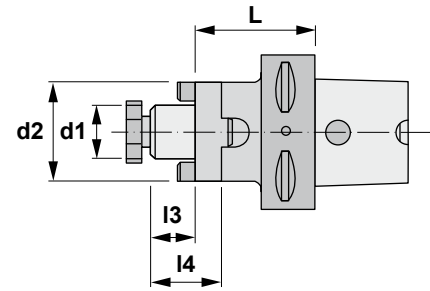

Characteristics:
Combi-Shell mill adaptor.
PSC ISO 26623-1
For cutters with keyway or driving slot
DIN 138.

Eigenschaften:
Kombi-Aufsteckfräsdorne.
PSC ISO 26623-1
Für Fräser mit Längsnut oder
Stimmitnehmer DIN 138.



18.180

Reference Bezeichnung	PSC	d1 h6	L	l3	l4	d2				
18.180.040.16	40	16	50	17	27	32	10008	60116	88016	0,450
18.180.040.22	40	22	50	19	31	40	10010	60122	88022	0,590
18.180.050.16	50	16	50	17	27	32	10008	60116	88016	0,640
18.180.050.22	50	22	50	19	31	40	10010	60122	88022	0,770
18.180.050.27	50	27	50	21	33	48	10012	60127	88027	0,930
18.180.050.32	50	32	60	24	38	58	10016	60132	88032	1,360
18.180.063.16	63	16	90	17	27	32	10008	60116	88016	1,160
18.180.063.22	63	22	90	19	31	40	10010	60122	88022	1,420
18.180.063.27	63	27	90	21	33	48	10012	60127	88027	1,740
18.180.063.32	63	32	90	24	38	58	10016	60132	88032	2,220
18.180.063.40	63	40	90	27	41	70	10020	60140	88040	2,940
18.180.080.16	80	16	100	17	27	32	10008	60116	88016	2,180
18.180.080.22	80	22	100	19	31	40	10010	60122	88022	2,450
18.180.080.27	80	27	100	21	33	48	10012	60127	88027	2,780
18.180.080.32	80	32	100	24	38	58	10016	60132	88032	3,280
18.180.080.40	80	40	100	27	41	70	10020	60140	88040	4,070
18.180.080.50	80	50	100	30	46	90	10024	60150	88050	5,550
18.180.100.16	100	16	100	17	27	32	10008	60116	88016	3,540
18.180.100.22	100	22	100	19	31	40	10010	60122	88022	3,800
18.180.100.27	100	27	100	21	33	48	10012	60127	88027	4,130
18.180.100.32	100	32	100	24	38	58	10016	60132	88032	4,610
18.180.100.40	100	40	100	27	41	70	10020	60140	88040	5,330
18.180.100.50	100	50	100	30	46	90	10024	60150	88050	6,820





Characteristics:
Reducing adaptor.
PSC ISO 26623-1
For tools with Morse taper shank
and tang DIN 228-B. Form B.

Eigenschaften:
Reduzierhülsen.
PSC ISO 26623-1
Für Werkzeuge mit Morsekegel
und Austreiblappen DIN 228-B
Form B.

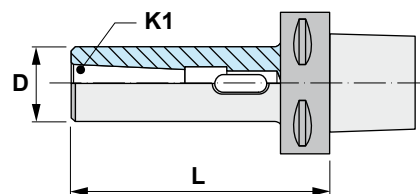

18.215

Reference Bezeichnung	PSC	K1 MORSE	L	D	 Kg
18.215.050.02	50	2	110	32	0,860
18.215.050.03	50	3	130	40	1,230
18.215.063.02	63	2	110	32	1,140
18.215.063.03	63	3	130	40	1,500
18.215.063.04	63	4	150	52	2,250
18.215.080.03	80	3	120	40	2,340
18.215.080.04	80	4	140	52	2,980
18.215.080.05	80	5	160	63	3,480
18.215.100.03	100	3	130	40	3,780
18.215.100.04	100	4	150	52	4,480
18.215.100.05	100	5	175	63	5,130





Characteristics:
CNC-Universal precision drill chucks.
PSC ISO 26623-1
For left and right hand turn.

*** SUPPLIED WITH WRENCH**

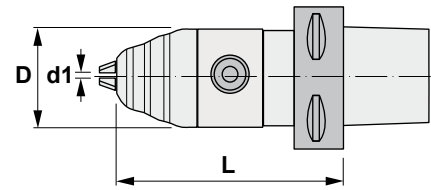

Eigenschaften:
CNC-Universal Bohrfutter,
Genauigkeitsausführung.
PSC ISO 26623-1
Für links- und rechtslaufende
Bearbeitungen.

*** LIEFERUNG MIT SCHLÜSSEL**



18.296

Reference Bezeichnung	PSC	d1	D	L	
18.296.040.13	40	0.5 - 13	50	112	1,560
18.296.050.13	50	0.5 - 13	50	112	1,730
18.296.063.13	63	0.5 - 13	50	112	2,320
18.296.063.16	63	3.0 - 16	57	112	2,350
18.296.080.13	80	0.5 - 13	50	125	3,030
18.296.080.16	80	3.0 - 16	57	125	3,280
18.296.100.13	100	0.5 - 13	50	135	4,250
18.296.100.16	100	3.0 - 16	57	135	4,400

Reference Bezeichnung		3x 
18.296.040.13	50706	60313
18.296.050.13	50706	60313
18.296.063.13	50706	60313
18.296.063.16	50706	60313
18.296.080.13	50706	60313
18.296.080.16	50706	60313
18.296.100.13	50706	60313
18.296.100.16	50706	60313

**Characteristics:**

Combined end mill adaptors type Weldon /
Whistle-Notch. PSC ISO 26623-1

For tools with cylindrical shank and
tightening inclined flat DIN 1835-B+E.



Eigenschaften:

Kombi-Aufnahme Typ Weldon /
Whistle-Notch. PSC ISO 26623-1

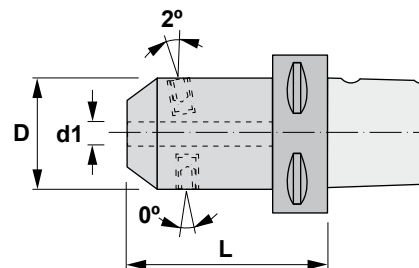
Für Werkzeuge mit zylindrischem Schaft
und geneigter Spannfläche DIN1835-B+E.



18.306

Reference Bezeichnung	PSC	d1	L	D	2x 	
18.306.040.06	40	06	50	25	15106	0,350
18.306.040.08	40	08	50	28	15108	0,370
18.306.040.10	40	10	50	35	15110	0,440
18.306.040.12	40	12	55	42	15212	0,570
18.306.040.16	40	16	55	48	15314	0,650
18.306.050.06	50	06	55	25	15106	0,550
18.306.050.08	50	08	55	28	15108	0,580
18.306.050.10	50	10	65	35	15110	0,730
18.306.050.12	50	12	65	42	15212	0,870
18.306.050.14	50	14	65	42	15212	0,850
18.306.050.16	50	16	65	48	15314	0,980
18.306.050.18	50	18	65	48	15314	0,950
18.306.050.20	50	20	65	52	15216	1,020
18.306.050.25	50	25	80	65	4 x 15218	1,620
18.306.063.06	63	06	80	25	15106	0,920
18.306.063.08	63	08	80	28	15108	0,960
18.306.063.10	63	10	80	35	15110	1,100
18.306.063.12	63	12	80	42	15212	1,280
18.306.063.14	63	14	80	42	15212	1,260
18.306.063.16	63	16	80	48	15314	1,430
18.306.063.18	63	18	80	48	15314	1,400
18.306.063.20	63	20	80	52	15216	1,510
18.306.063.25	63	25	90	65	4 x 15218	2,080
18.306.063.32	63	32	90	72	4 x 15220	1,890
18.306.063.40	63	40	95	80	4 x 15220	1,680
18.306.080.06	80	06	80	25	15106	1,900
18.306.080.08	80	08	80	28	15108	1,940
18.306.080.10	80	10	80	35	15110	2,060
18.306.080.12	80	12	80	42	15212	2,210
18.306.080.14	80	14	80	42	15212	2,190
18.306.080.16	80	16	80	48	15314	2,330
18.306.080.20	80	20	80	52	15216	2,400
18.306.080.25	80	25	90	65	4 x 15218	3,010
18.306.080.32	80	32	90	72	4 x 15220	3,190
18.306.080.40	80	40	110	80	4 x 15220	3,980
18.306.080.50	80	50	120	100	4 x 15024	3,760
18.306.100.12	100	12	100	42	15212	3,750
18.306.100.16	100	16	100	48	15314	3,930
18.306.100.20	100	20	100	52	15216	4,020
18.306.100.25	100	25	100	65	4 x 15218	4,550
18.306.100.32	100	32	100	72	4 x 15220	4,750
18.306.100.40	100	40	120	80	4 x 15220	5,600
18.306.100.50	100	50	130	100	4 x 15024	7,500



Characteristics:
Mill adaptors.
PSC ISO 26623-1
For frontal end mill support
screwed shanks.

Eigenschaften:
Spannfutter PSC ISO 26623-1
Für Einschraubfräser.

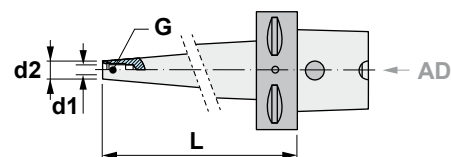

18.315

Reference Bezeichnung	PSC	L	d1	d2	
18.315.040.08	40	70	M8	13	0,310
18.315.040.10	40	80	M10	18	0,390
18.315.040.12	40	80	M12	21	0,430
18.315.050.08	50	70	M8	13	0,490
18.315.050.10	50	80	M10	18	0,570
18.315.050.12	50	80	M12	21	0,610
18.315.050.16	50	80	M16	29	0,750
18.315.063.08	63	70	M8	13	0,770
18.315.063.10	63	90	M10	18	0,880
18.315.063.12	63	100	M12	21	0,980
18.315.063.16	63	100	M16	29	1,170
18.315.080.12	80	100	M12	21	1,950
18.315.080.16	80	100	M16	29	2,110
18.315.100.12	100	120	M12	21	3,590
18.315.100.16	100	120	M16	29	3,560





Characteristics:
Strong hold collet chuck for cylindrical collets.
PSC ISO 26623-1

Eigenschaften:
Kraftspannfutter für zylindrische Spannzangen.
PSC ISO 26623-1

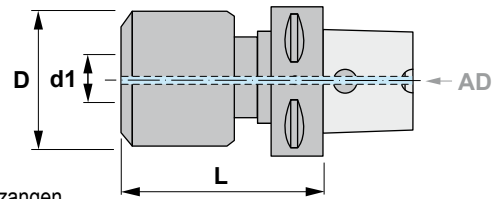

18.400

Reference Bezeichnung	PSC	L	d1	D	
18.400.063.20	63	93	20	54	1,690
18.400.080.20	80	89	32	72	2,490
18.400.080.32	80	101	32	72	3,140
18.400.100.32	100	120	32	72	5,160

Complements (Collets type C) /Zubehör (Spannzangen Typ C)

Reference / Bezeichnung	d	D	L
C2006	6	20	55
C2008	8	20	55
C2010	10	20	55
C2012	12	20	55
C2016	16	20	55
C3206	6	32	65
C3208	8	32	65
C3210	10	32	65
C3212	12	32	65
C3216	16	32	65
C3220	20	32	65
C3225	25	32	65

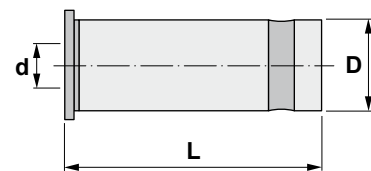



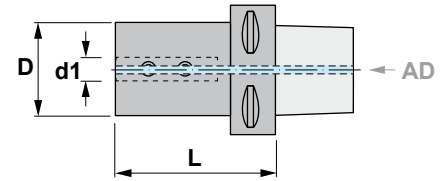

Characteristics:
Boring bar holders.
PSC ISO 26623-1

Eigenschaften:
Bohrstangenaufnahme.
PSC ISO 26623-1



18.406

Reference Bezeichnung	PSC	L	d1	D		
18.406.040.08	40	50	08	44	14206	0,590
18.406.040.10	40	50	10	44	14208	0,580
18.406.040.12	40	50	12	44	14208	0,570
18.406.040.16	40	50	16	44	14210	0,550
18.406.050.08	50	52	08	44	14206	0,790
18.406.050.10	50	52	10	44	14208	0,780
18.406.050.12	50	52	12	44	14208	0,770
18.406.050.16	50	52	16	44	14210	0,730
18.406.050.20	50	52	20	50	14210	0,820
18.406.050.25	50	60	25	55	14210	1,000
18.406.063.08	63	60	08	44	14206	1,140
18.406.063.10	63	60	10	44	14208	1,130
18.406.063.12	63	60	12	44	14208	1,120
18.406.063.16	63	60	16	44	14210	1,090
18.406.063.20	63	60	20	50	14210	1,190
18.406.063.25	63	72	25	55	14210	1,420
18.406.063.32	63	75	32	55	14210	1,320
18.406.063.40	63	85	40	65	14210	3,260
18.406.080.16	80	85	16	44	14210	2,280
18.406.080.20	80	85	20	50	14210	2,410
18.406.080.25	80	85	25	55	14210	2,490
18.406.080.32	80	85	32	72	14310	3,080
18.406.080.40	80	95	40	65	14310	4,850
18.406.080.50	80	100	50	75	14310	4,680
18.406.100.16	100	100	16	44	14210	3,430
18.406.100.20	100	100	20	50	14210	3,650
18.406.100.25	100	100	25	55	14210	3,900
18.406.100.32	100	100	32	55	14310	4,600
18.406.100.40	100	110	40	65	14310	5,200
18.406.100.50	100	120	50	75	14310	5,580



**Characteristics:**

Collet chucks for DIN 6499 (ER) collets.

PSC ISO 26623-1

For tools with cylindrical shank DIN 1835-B.

* Ball bearing nut, see page: I217

Eigenschaften:





Spannzangenfutter für Spannzangen DIN 6499 (ER).

PSC ISO 26623-1

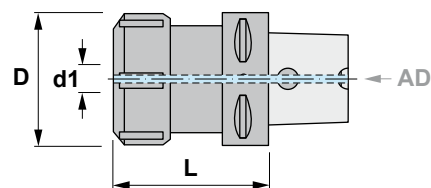
Für Werkzeuge mit zylindrischem Schaft DIN 1835-B.

* Für Kugellager-Mutter, siehe Seite: I217

**18.453***** SUPPLIED WITHOUT WRENCH / LIEFERUNG OHNE SCHLÜSSEL**

Reference Bezeichnung	PSC		L	d1	D			
18.453.040.16	40	ER16	60	0,5-10	28	45316	50216	0,420
18.453.040.20	40	ER20	60	1-13	34	45320	50220	0,490
18.453.040.25	40	ER25	60	1-16	42	45325	50225	0,630
18.453.040.32	40	ER32	60	2-20	50	45332	50232	0,850
18.453.050.16	50	ER16	60	0,5-10	28	45316	50216	0,600
18.453.050.16/100	50	ER16	100	0,5-10	28	45316	50216	0,790
18.453.050.20	50	ER20	60	1-13	34	45320	50220	0,670
18.453.050.20/100	50	ER20	100	1-13	34	45320	50220	0,900
18.453.050.25	50	ER25	60	1-16	42	45325	50225	0,810
18.453.050.25/100	50	ER25	100	1-16	42	45325	50225	1,150
18.453.050.32	50	ER32	60	2-20	50	45332	50232	1,020
18.453.050.32/100	50	ER32	100	2-20	50	45332	50232	1,520
18.453.050.40	50	ER40	65	3-30	63	45340	50240	1,410
18.453.050.40/100	50	ER40	100	3-30	63	45340	50240	1,950
18.453.063.16	63	ER16	60	0,5-10	28	45316	50216	0,870
18.453.063.16/100	63	ER16	100	0,5-10	28	45316	50216	1,060
18.453.063.20	63	ER20	60	1-13	34	45320	50220	0,940
18.453.063.20/100	63	ER20	100	1-13	34	45320	50220	1,170
18.453.063.25	63	ER25	60	1-16	42	45325	50225	1,070
18.453.063.25/100	63	ER25	100	1-16	42	45325	50225	1,410
18.453.063.32	63	ER32	60	2-20	50	45332	50232	1,280
18.453.063.32/100	63	ER32	100	2-20	50	45332	50232	1,810
18.453.063.40	63	ER40	70	3-30	63	45340	50240	1,770
18.453.063.40/120	63	ER40	120	3-30	63	45340	50240	2,740
18.453.080.32	80	ER32	70	2-20	50	45332	50232	2,310
18.453.080.32/160	80	ER32	160	2-20	50	45332	50232	3,420
18.453.080.40	80	ER40	70	3-30	63	45340	50240	2,660
18.453.080.40/160	80	ER40	160	3-30	63	45340	50240	4,350
18.453.100.32	100	ER32	100	2-20	50	45332	50232	3,960
18.453.100.32/160	100	ER32	160	2-20	50	45332	50232	4,780
18.453.100.40	100	ER40	100	3-30	63	45340	50240	4,430
18.453.100.40/160	100	ER40	160	3-30	63	45340	50240	5,690
18.453.100.50	100	ER50	100	6-34	78	45350	50250	5,460
18.453.100.50/160	100	ER50	160	6-34	78	45350	50250	7,190

ERXX  I210-212

Reference / Bez.

ERXX

**ERCXX**  I215-216

Reference / Bez.

ERCXX

**ERTXX**  I217-218

Reference / Bez.

ERTXX

**40.453..**  I180

Reference / Bez.

40.453..

**40.455..**  I181

Reference / Bez.

40.455..





Characteristics:
Long collet chuck for
DIN 6499 (ER) collets.
PSC ISO 26623-1
For tools with cylindrical shank.
With "mini" collet nut.

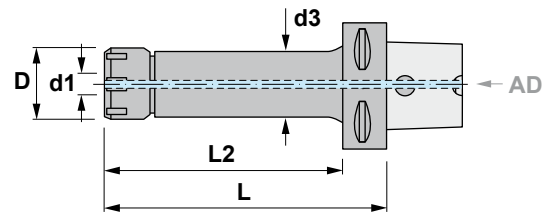

*** SUPPLIED WITHOUT WRENCH**

Eigenschaften:
Lange Spannzangenfutter für
Spannzangen DIN 6499 (ER).
PSC ISO 26623-1
Für Werkzeuge mit zylindrischem Schaft.
Mit "Mini"-Spannmutter.

*** LIEFERUNG OHNE SCHLÜSSEL**

18.455

Reference Bezeichnung	PSC		L	d1	D	L2	d3				
18.455.063.16	63	ER16	60	0,5-10	22	-	-	45516	50916	19210	0,860
18.455.063.16/100	63	ER16	100	0,5-10	22	78	22	45516	50916	19210	0,950
18.455.063.20	63	ER20	60	1-13	28	-	-	45520	50920	19212	0,960
18.455.063.20/100	63	ER20	100	1-13	28	78	30	45520	50920	19212	1,120

ERXX

 I210-212

Ref. / Bez. Accessories / Zubehör

ERXX Collets with double slot DIN 6499 - Form B (ER)
Spannzangen mit Doppelnut DIN 6499 - Form B (ER)



ERCXX

 I215-216

Ref. / Bez. Accessories / Zubehör

ERCXX Sealed collets DIN 6499 (ER)
Abgedichtete Spannzangen DIN 6499 (ER)



ERTXX

 I217-218

Ref. / Bez. Accessories / Zubehör

ERTXX Collets DIN 6499 - Form Mexin (ER)
Spannzangen DIN 6499 - Form Mexin (ER)





Characteristics:
Blank adaptors.
PSC ISO 26623-1

Eigenschaften:
Rohlinge.
PSC ISO 26623-1

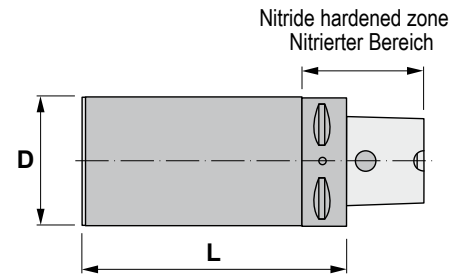

18.470

Reference Bezeichnung	PSC	D	L	 Kg
18.470.032.032/090	32	32	90	0,590
18.470.032.040/110	32	40	110	1,050
18.470.032.050/125	32	50	125	1,810
18.470.032.060/090	32	60	90	1,780
18.470.032.070/060	32	70	60	1,470
18.470.032.090/070	32	90	70	2,860
18.470.040.040/095	40	40	95	0,990
18.470.040.040/120	40	40	120	1,240
18.470.040.060/165	40	60	165	3,460
18.470.040.080/075	40	80	75	2,420
18.470.040.080/120	40	80	120	4,190
18.470.040.100/085	40	100	85	4,260
18.470.050.050/125	50	50	125	2,050
18.470.050.050/150	50	50	150	2,430
18.470.050.063/180	50	63	180	4,340
18.470.050.075/175	50	75	175	5,800
18.470.050.090/080	50	90	80	3,420
18.470.050.095/150	50	95	150	7,660
18.470.050.110/090	50	110	90	5,650
18.470.063.063/180	63	63	180	4,630
18.470.063.075/195	63	75	195	6,710
18.470.063.110/085	63	110	85	5,410
18.470.063.110/120	63	110	120	8,020
18.470.063.120/180	63	120	180	14,730
18.470.063.130/095	63	130	95	14,740
18.470.080.080/200	80	80	200	8,430
18.470.080.100/200	80	100	200	12,200
18.470.080.120/160	80	120	160	13,260
18.470.080.130/090	80	130	90	7,970
18.470.080.150/200	80	150	200	25,300
18.470.080.160/120	80	160	120	15,930
18.470.100.100/100	100	100	100	7,280
18.470.100.100/200	100	100	200	13,450
18.470.100.150/100	100	150	100	12,520
18.470.100.150/200	100	150	200	26,390
18.470.100.160/150	100	160	150	21,710
18.470.100.200/100	100	200	100	19,850



Characteristics:
Adaptor with axial mounting.
PSC ISO 26623-1
Adaptor for square turning toolholder
left / right hand.

Eigenschaften:
Axial-Werkzeughalter.
PSC ISO 26623-1
Dreh-Werkzeughalter für Klemmhalter
links / rechts.

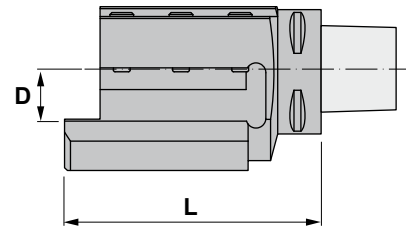

18.500

Reference Bezeichnung	PSC	D	L	
18.500.050.20 R/L	50	20	98	2,050
18.500.063.20 R/L	63	20	100	2,560
18.500.063.25 R/L	63	25	130	3,640
18.500.063.32 R/L	63	32	134	3,990
18.500.080.32 R/L	80	32	140	5,390
18.500.100.32 R/L	100	32	150	10,100

Reference Bezeichnung	3x 	
18.500.050.20 R/L	17010	29708
18.500.063.20 R/L	17110	29708
18.500.063.25 R/L	17012	29708
18.500.063.32 R/L	17012	29708
18.500.080.32 R/L	17012	29710
18.500.100.32 R/L	17012	29710



**Characteristics:**

Adaptor with angular mounting.

PSC ISO 26623-1

Adaptor for square turning toolholder
left / right hand.**Eigenschaften:**

Werkzeughalter. Schräge Montage.

PSC ISO 26623-1

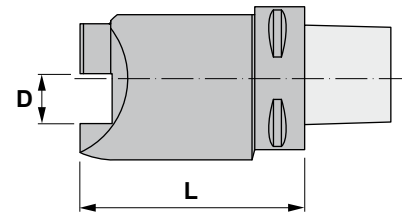
Dreh-Werkzeughalter für Klemmhalter
links / rechts.

18.510

Reference Bezeichnung	PSC	D	L	
18.510.050.20 R/L	50	20	97	1,770
18.510.063.20 R/L	63	20	99	2,180
18.510.063.25 R/L	63	25	130	4,430
18.510.080.32 R/L	80	32	135	6,680
18.510.100.32 R/L	100	32	145	10,030

Reference Bezeichnung		
18.510.050.20 R/L	17110	29708
18.510.063.20 R/L	17110	29708
18.510.063.25 R/L	17012	29708
18.510.080.32 R/L	17012	29710
18.510.100.32 R/L	17012	29710



Characteristics:
Mini-turret with axial mounting.
PSC ISO 26623-1
Multipurpose mini-turret for square toolholders.

Eigenschaften:
Mehrfach-Axial-Werkzeughalter.
PSC ISO 26623-1
Multifunktionaler Werkzeughalter für vierkantigen Klemmhalter.

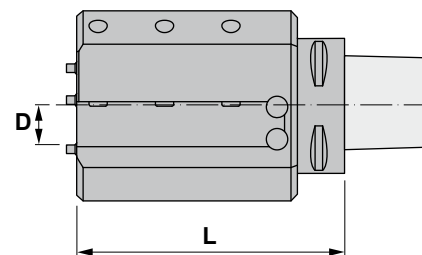

18.520

Reference Bezeichnung	PSC	D	L	
18.520.050.20 R/L	50	20	123	3,770
18.520.063.20 R/L	63	20	125	4,250
18.520.063.25 R/L	63	25	130	5,140
18.520.080.32 R/L	80	32	150	7,780
18.520.100.32 R/L	100	32	160	11,400

Reference Bezeichnung		
18.520.050.20 R/L	17012	29708
18.520.063.20 R/L	17012	29708
18.520.063.25 R/L	17012	29708
18.520.080.32 R/L	17012	29710
18.520.100.32 R/L	17012	29710



**Characteristics:**

Adaptor with radial mounting.
PSC ISO 26623-1
Multipurpose adaptor for square
toolholders.

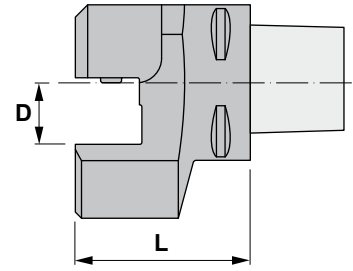

Eigenschaften:

Radial-Werkzeughalter.
PSC ISO 26623-1
Multifunktionaler Werkzeughalter für
vierkantige Klemmhalter.



18.530

Reference Bezeichnung	PSC	D	L	
18.530.050.20	50	20	58	1,460
18.530.063.20	63	20	60	1,790
18.530.063.25	63	25	71	2,860
18.530.063.32	63	32	71	3,300
18.530.080.32	80	32	85	4,750
18.530.100.32	100	32	90	6,470

Reference Bezeichnung		
18.530.050.20	17112	29708
18.530.063.20	17112	29708
18.530.063.25	17012	29708
18.530.063.32	17012	29708
18.530.080.32	17012	29710
18.530.100.32	17012	29710



Characteristics:
Adaptor with axial mounting for blades.
PSC ISO 26623-1

Eigenschaften:
Axial-Werkzeughalter für Stechschwerter.
PSC ISO 26623-1

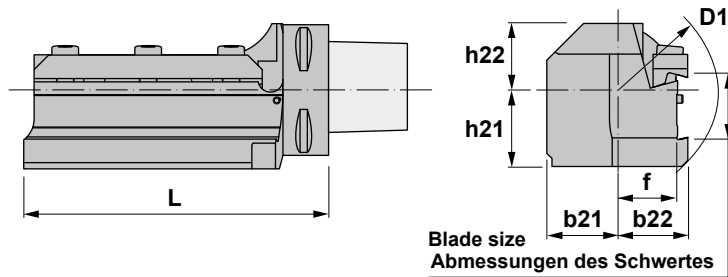

18.540

Reference Bezeichnung	PSC	Blade size Abmessungen des Schwertes	D1	b21	b22	f	h21	h22	L	
18.540.050.26 R/L	50	26	88	25.0	32.0	27.0	30.0	26.0	95	1,500
18.540.063.32 R/L	63	32	106	32.0	39.5	32.0	38.0	32.0	147	3,300
18.540.080.32 R/L	80	32	126	40.5	48.0	40.5	40.5	40.5	155	5,200
18.540.100.32 R/L	100	32	145	50.0	58.0	50.5	50.5	50.0	160	9,240
18.540.100.52 R/L	100	52/53	175	50.0	58.0	50.5	65.0	50.0	200	12,410

Reference Bezeichnung		
18.540.050.26 R/L	80526	11008
18.540.063.32 R/L	80632	11108
18.540.080.32 R/L	80632	11108
18.540.100.32 R/L	80632	11108
18.540.100.52 R/L	81052	11108



**Characteristics:**

Adaptor with radial mounting for blades.
PSC ISO 26623-1

Eigenschaften:

Radial-Werkzeughalter für Stechschwerter.
PSC ISO 26623-1

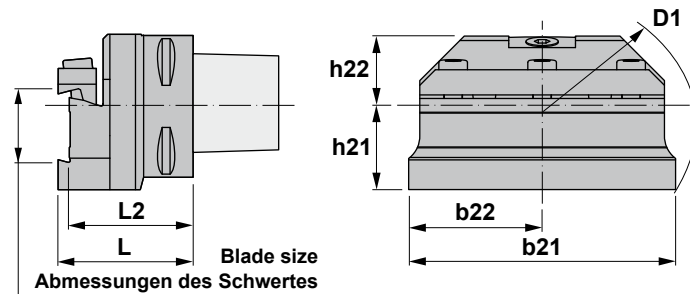

18.550

Reference Bezeichnung	PSC	Blade size Abmessungen des Schwertes	D1	b21	b22	h21	h22	L	L2	
18.550.050.26	50	26	100	80	40	30.0	25.2	58	53.0	1,300
18.550.063.32	63	32	141	120	60	37.0	32.0	63	55.5	2,300
18.550.080.32	80	32	145	120	60	40.5	40.0	71	63.5	3,500
18.550.100.32	100	32	145	120	60	50.5	50.0	75	67.5	5,570
18.550.100.52	100	52/53	195	160	80	65.0	50.0	75	67.5	6,440

Reference Bezeichnung		
18.550.050.26	80526	11008
18.550.063.32	81632	11108
18.550.080.32	81632	11108
18.550.100.32	81632	11108
18.550.100.52	81052	11108



Characteristics:

Quick change tapping head with axial compensation.

PSC ISO 26623-1

With Bilz system tap chucks bushings. Compensation in compression (C) and tension (T).

Eigenschaften:

Gewindeschneid-Schnellwechselfutter mit Axial-Längenausgleich.

PSC ISO 26623-1

Mit Gewindebohrer-Buchsen System Bilz.

Ausgleich der Kompression (C) und der Traktion (T).

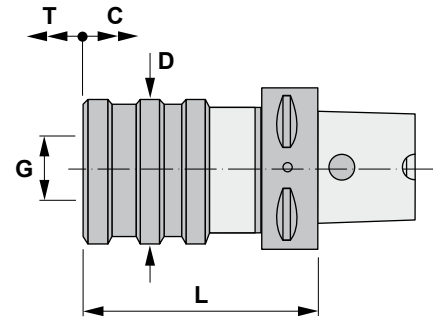

18.620

Reference Bezeichnung	PSC	N° G Ø	d1	L	D	C	T			
18.620.040.12	40	1 19	M3-M12	65	38	9	9	710XX	750XX	0,510
18.620.050.12	50	1 19	M3-M12	65	38	9	9	710XX	750XX	0,690
18.620.063.12	63	1 19	M3-M12	70	38	9	9	710XX	750XX	0,970
18.620.063.20	63	2 31	M8-M20	95	55	15	15	720XX	760XX	1,710
18.620.063.33	63	3 48	M14-M33	140	79	24	24	730XX	770XX	3,550
18.620.080.12	80	1 19	M3-M12	80	38	9	9	710XX	750XX	2,050
18.620.080.20	80	2 31	M8-M20	100	55	15	15	720XX	760XX	2,720
18.620.080.33	80	3 48	M14-M33	150	79	24	24	730XX	770XX	5,040
18.620.100.12	100	1 19	M3-M12	90	38	9	9	710XX	750XX	3,470
18.620.100.20	100	2 31	M8-M20	110	55	15	15	720XX	760XX	4,180
18.620.100.33	100	3 48	M14-M33	160	79	24	24	730XX	770XX	6,620

710XX..730XX

I202

Ref. / Bezeichnung

Accessories / Zubehör

710XX..730XX

Quick change adapters without overload clutch
Schnellwechseleinsätze ohne Sicherheitskupplung



750XX..770XX

I203

Ref. / Bezeichnung

Accessories / Zubehör

750XX..770XX

Quick change adapters with overload clutch
Schnellwechseleinsätze mit Sicherheitskupplung





Characteristics:
Test arbors.
PSC ISO 26623-1

Eigenschaften:
Prüfdome.
PSC ISO 26623-1

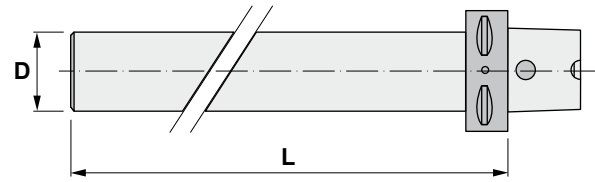

18.999

Reference Bezeichnung	PSC	L	D	 kg
18.999.050	50	255	32	1,910
18.999.063	63	322	40	3,260
18.999.080	80	330	40	4,680





Characteristics:
Adaptor DIN 69871-A
to PSC ISO 26623-1.

Eigenschaften:
Adapter DIN 69871-A
zu PSC ISO 26623-1.

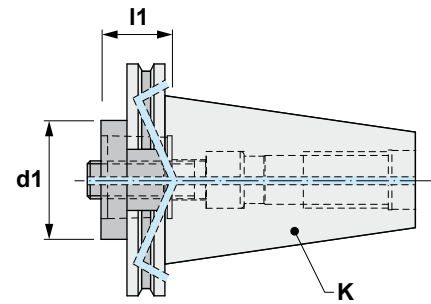

13.218

Reference Bezeichnung	K ISO	PSC	d1	l1	
13.218.30.32/030	30	32	32	30	0,400
13.218.30.32/060	30	32	32	60	0,550
13.218.40.32/030	40	32	32	30	0,850
13.218.40.32/060	40	32	32	60	1,000
13.218.40.40/030	40	40	40	30	0,850
13.218.40.40/060	40	40	40	60	1,100
13.218.40.50/030	40	50	50	30	0,850
13.218.40.50/070	40	50	50	70	1,400
13.218.40.63/085	40	63	63	85	1,900
13.218.50.32/030	50	32	32	30	2,700
13.218.50.32/060	50	32	32	60	3,000
13.218.50.40/030	50	40	40	30	0,850
13.218.50.40/060	50	40	40	60	3,000
13.218.50.50/030	50	50	50	30	2,650
13.218.50.50/070	50	50	50	70	3,210
13.218.50.63/030	50	63	63	30	2,610
13.218.50.63/080	50	63	63	80	3,750
13.218.50.80/070	50	80	80	70	3,900
13.218.50.80/120	50	80	80	120	5,550





Characteristics:
Adaptor HSK DIN 69893-1
to PSC ISO 26623-1.

Eigenschaften:
Adapter HSK DIN 69893-1
zu PSC ISO 26623-1.

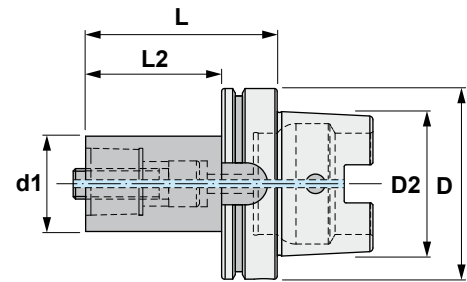

16.218

Reference Bezeichnung	HSK	PSC	d1	D	D2	L	L2	
16.218.063.32/075	63	32	32	63	48	75	49	0,900
16.218.063.40/080	63	40	40	63	48	80	54	1,100
16.218.063.50/090	63	50	50	63	48	90	64	1,450
16.218.100.32/080	100	32	32	100	75	80	51	2,310
16.218.100.40/090	100	40	40	100	75	90	61	2,550
16.218.100.50/100	100	50	50	100	75	100	71	2,950
16.218.100.63/110	100	63	63	100	75	110	81	3,700
16.218.100.80/120	100	80	80	100	75	120	91	4,900





Characteristics:
Extension
PSC ISO 26623-1.

Eigenschaften:
Verlängerung
PSC ISO 26623-1.

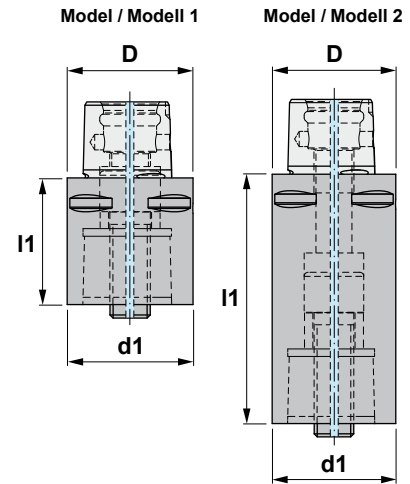

18.218

Reference Bezeichnung	Model Modell	Side PSC / Machine PSC Größe/ Maschine	d1	D	l1	⚖️ Kg
18.218.32.32/035	1	32	32	32	35	0,200
18.218.32.32/060	2	32	32	32	60	0,360
18.218.32.32/080	2	32	32	32	80	0,490
18.218.40.40/040	1	40	40	40	40	0,370
18.218.40.40/060	2	40	40	40	60	0,600
18.218.40.40/080	2	40	40	40	80	0,800
18.218.50.50/050	1	50	50	50	50	0,730
18.218.50.50/080	2	50	50	50	80	1,240
18.218.50.50/100	2	50	50	50	100	1,500
18.218.63.63/060	1	63	63	63	60	1,350
18.218.63.63/100	2	63	63	63	100	2,350
18.218.63.63/140	2	63	63	63	140	3,300
18.218.80.80/065	1	80	80	80	65	2,350
18.218.80.80/100	2	80	80	80	100	3,750
18.218.80.80/125	2	80	80	80	125	4,750





Characteristics:
Reducer
PSC ISO 26623-1.

Eigenschaften:
Reduzierhülse
PSC ISO 26623-1.

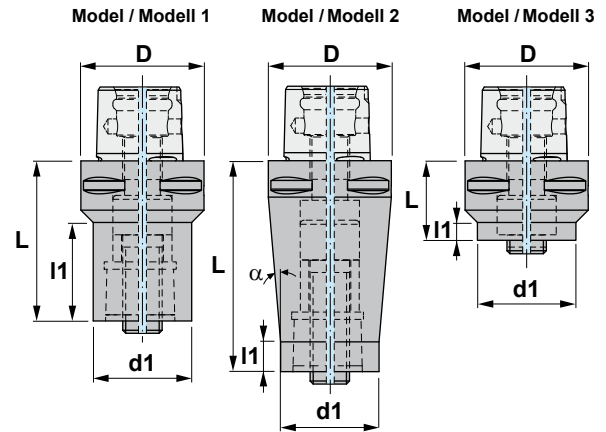

18.218

Reference Bezeichnung	Model Modell	Side Machine PSC Maschine	Side PSC PSC Größe	D	d1	L	l1	α	
18.218.40.32/055	1	40	32	40	32	55	31.0	-	0,430
18.218.40.32/070	2	40	32	40	32	70	12.0	6.0°	0,560
18.218.50.32/060	1	50	32	50	32	60	34.8	-	0,640
18.218.50.40/065	1	50	40	50	40	65	40.0	-	0,800
18.218.50.40/085	2	50	40	50	40	85	12.0	5.4°	1,130
18.218.50.32/033	3	50	32	50	32	33	10.0	-	0,470
18.218.50.40/040	3	50	40	50	40	40	18.0	-	0,550
18.218.63.32/070	1	63	32	63	32	70	39.0	-	0,970
18.218.63.40/080	1	63	40	63	40	80	51.4	-	1,200
18.218.63.50/080	1	63	50	63	50	80	51.5	-	1,500
18.218.63.50/110	2	63	50	63	50	110	12.0	4.9°	2,250
18.218.63.32/032	3	63	32	63	32	32	6.0	-	0,760
18.218.63.40/040	3	63	40	63	40	40	11.0	-	0,800
18.218.63.50/050	3	63	50	63	50	50	26.5	-	1,000
18.218.80.32/060	1	80	32	80	32	60	29.3	-	1,900
18.218.80.40/070	1	80	40	80	40	70	36.5	-	2,000
18.218.80.50/080	1	80	50	80	50	80	49.3	-	2,300
18.218.80.63/080	1	80	63	80	63	80	53.1	-	2,650
18.218.80.63/120	2	80	63	80	63	120	12.0	6.2°	4,300
18.218.80.50/045	3	80	50	80	50	45	10.0	-	1,800
18.218.80.63/055	3	80	63	80	63	55	20.0	-	2,000



Characteristics:
Adaptor JIS B 6339-BT
to PSC ISO 26623-1.

Eigenschaften:
Adapter JIS B 6339-BT
zu PSC ISO 26623-1.

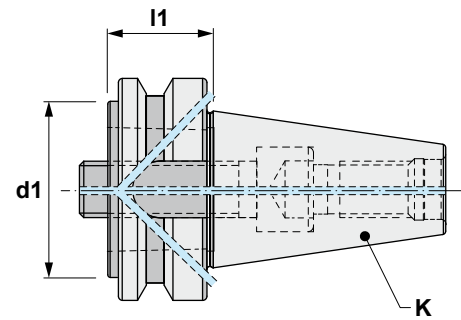

23.218

Reference Bezeichnung	K ISO	PSC	d1	l1	⚖️
23.218.30.32/030	30	32	32	30	0,400
23.218.30.32/060	30	32	32	60	0,600
23.218.40.32/030	40	32	32	30	1,000
23.218.40.32/060	40	32	32	60	1,200
23.218.40.40/030	40	40	40	30	0,950
23.218.40.40/060	40	40	40	60	1,250
23.218.40.50/030	40	50	50	30	0,900
23.218.40.50/070	40	50	50	70	1,500
23.218.40.63/075	40	63	63	75	1,900
23.218.50.32/040	50	32	32	40	3,650
23.218.50.32/070	50	32	32	70	3,850
23.218.50.40/040	50	40	40	40	3,650
23.218.50.40/070	50	40	40	70	3,900
23.218.50.50/040	50	50	50	40	3,550
23.218.50.50/080	50	50	50	80	4,150
23.218.50.63/040	50	63	63	40	3,450
23.218.50.63/090	50	63	63	90	4,650
23.218.50.80/070	50	80	80	70	4,200
23.218.50.80/120	50	80	80	120	6,150





Characteristics:
Arbors for boring heads.
PSC ISO 26623-1

Eigenschaften:
Aufnahmen für Bohrköpfe.
PSC ISO 26623-1

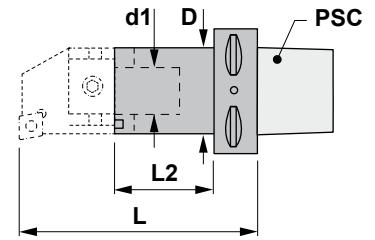

18.700

Reference Bezeichnung	PSC	D	L	L2	d1	Kg
18.700.63.12/055	63	22	77	43	12	0,750
18.700.63.12/110	63	22	132	98	12	0,920
18.700.63.15/065	63	27	87	45	15	0,880
18.700.63.15/110	63	27	132	90	15	1,080
18.700.63.20/075	63	32	97	52	20	1,000
18.700.63.20/120	63	32	142	97	20	1,280

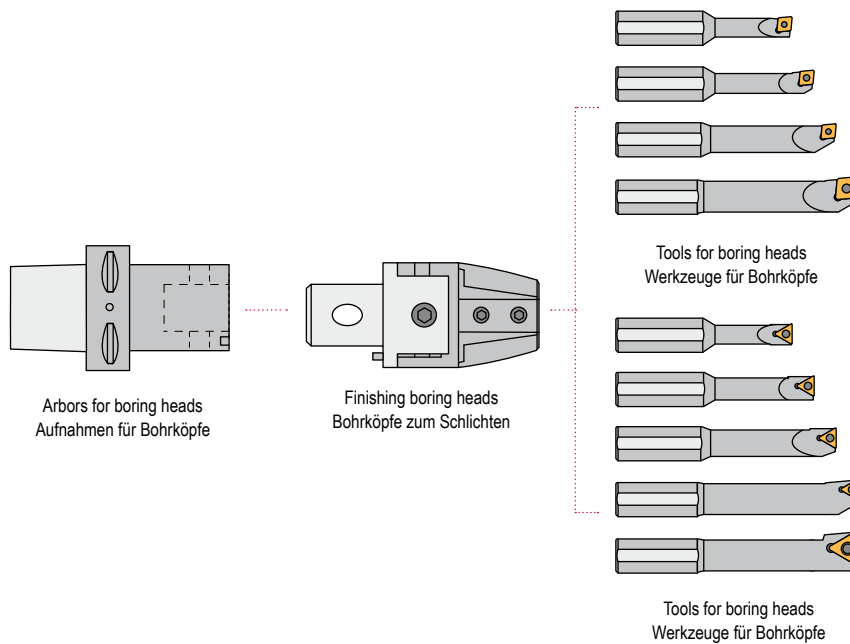
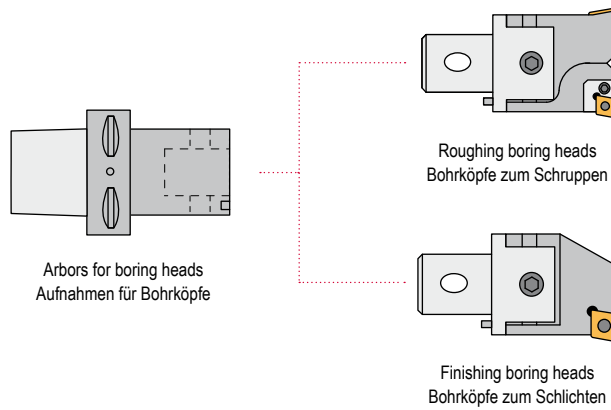



Characteristics:
Manual caps.

Eigenschaften:
Manuelle Verschlussstopfen.

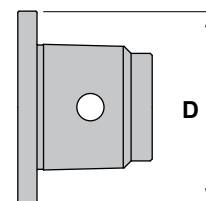

MC

Reference Bezeichnung	Manual Cap Manuelle Verschlussstopfen	
PSC32-MC	32	0,080
PSC40-MC	40	0,150
PSC50-MC	50	0,180
PSC63-MC	63	0,420
PSC80-MC	80	1,000



Characteristics:
Automatic caps.

Eigenschaften:
Automatische Verschlussstopfen.

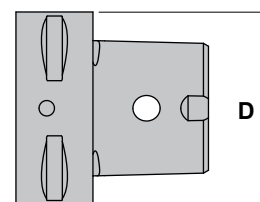

AC

Reference Bezeichnung	Automatic Cap Automatische Verschlussstopfen	
PSC40-AC	40	0,250
PSC50-AC	50	0,445
PSC63-AC	63	0,700
PSC80-AC	80	1,700



INSERTS WENDESCHNEIDPLATTEN

Grades Sorten	F02-05
ISO Code Key ISO Bezeichnung	F06-07
Contents - Milling inserts Inhalt - Fräswendeplatten	F08-09
ISO inserts ISO Wendeschneidplatten	F10-22



F

UNCOATED CARBIDE

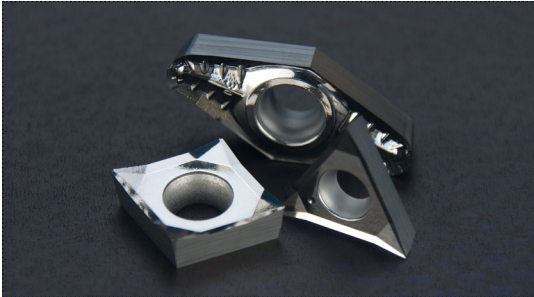

UNCOATED CARBIDE

- Excellent thermal crack resistance makes it possible to machine in wet cutting conditions.
- Cemented carbide can be applied for various workpieces.
- High toughness and low cutting force.
- Low affinity to workpiece.

Features of UNCOATED CARBIDE

Material		Grade	Colour	Composition	Definition
P Steel		PM25		WC+TiC+TaC+Co	General purpose uncoated grade in the P30 range. This tough, economical grade is suitable to work carbon steels, alloyed steels, tool steels and stainless steels. PM25 provides toughness and resistance to deformation in roughing and semi-finishing applications.
		PM40		WC+TiC+TaC+Co	Roughing grade in the P35 range. This tough grade is for structural, cast and tool steels. It is recommended when toughness is more important than wear resistance.
K Cast iron		KM15		WC+Co	Finishing grade in the K10 range. This carbide grade is for use on cast iron, aluminium and heat-resistant alloys. This grade works well on cobalt based alloys and synthetic materials and is suitable for finishing on heat-resistant alloys.

Application

ISO	Composition	Features	Workpiece
P	WC+TiC+TaC+Co	Heat resistance, excellent plastic deformation resistance.	Carbon steel, alloy steel, stainless steel.
M	WC+TiC+TaC+Co	General tools stable heat resistance with strength.	Carbon steel, alloy steel, stainless steel, cast steel.
K	WC+Co	High strength and superior wear resistance.	Carbon iron, non-ferrous metal, plastic, etc.





Properties

Grade	Hardness (HRA)	TRS (Kgf/mm ²)	Young's modulus (103Kgf/mm ²)	Thermal expansion coefficient (10 ⁻⁶ /°C)	Thermal conductivity (cal/cm·sec·°C)
KM15	90.9	250	63	-	105
PM25	91.9	200	56	5.2	45
PM40	91.3	230	53	5.2	-

UNBESCHICHTETES HARTMETALL

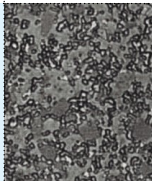
- Die hervorragende Wärmerißbeständigkeit ermöglicht eine Bearbeitung mit Kühlmittel.
- Unbeschichtetes Hartmetall eignet sich zur Bearbeitung von verschiedenen Werkstoffen.
- Hohe Zähfestigkeit und geringe Schneidkraft.
- Niedrige Affinität zum Werkstoff.

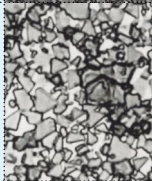
Eigenschaften von unbeschichtetem Hartmetall

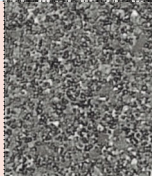
Beschreibung	Zusammensetzung	Farbe	Sorte		Werkstoff
Allgemeine unbeschichtete Sorte im P30 Bereich. Diese zähe und wirtschaftliche Sorte ist zur Bearbeitung von Kohlenstoffstahl, legiertem Stahl, Werkzeugstahl und rostfreiem Stahl gut geeignet. PM25 hat eine gute Zähigkeit und Verschleißfestigkeit in Schrupp- und mittlere Schlichtarbeiten.	WC+TiC+TaC+Co		PM25		P Stahl
Es ist eine Sorte zum Schruppen im P35 Bereich. Diese zähe Sorte ist für Baustahl, Stahlguß und Werkzeugstahl geeignet, insbesondere wenn die Zähigkeit wichtiger als die Verschleißfestigkeit ist.	WC+TiC+TaC+Co		PM40		
Es ist eine Sorte zum Schlichten im K10 Bereich. Diese Sorte ist für Guß, Aluminium und hitzebeständigen Legierungen geeignet. Sie hat gute Bearbeitungseigenschaften für Kobaltlegierungen und synthetischen Materialien und ist für das Schlichten in hitzebeständigen Legierungen besonders gut geeignet.	WC+Co		KM15		K Guß



Anwendung

ISO	Zusammensetzung	Eigenschaften	Bearbeitungsstück
P	WC+TiC+TaC+Co	Hitzebeständigkeit, ausgezeichneter Widerstand gegen plastische Verformung.	Kohlenstoffstahl, legierter Stahl, rostfreier Stahl.
M	WC+TiC+TaC+Co	Stabile Hitzebeständigkeit mit Stärke.	Kohlenstoffstahl, legierter Stahl, rostfreier Stahl, Stahlguß.
K	WC+Co	Hohe Festigkeit und hervorragende Verschleißfestigkeit.	Kohlenstoff-Eisen, Nicht-Eisen-Metall, Kunststoff, usw.

Sorteneigenschaften

Sorte	Härte (HRA)	TRS (Kg/mm ²)	Youngscher Modul (103Kg/mm ²)	Wärmeausdehnungs-Koeffizient (10 ⁻⁶ /°C)	Wärmeleitfähigkeit (cal/cm-sec-°C)
KM15	90.9	250	63	-	105
PM25	91.9	200	56	5.2	45
PM40	91.3	230	53	5.2	-

CVD / PVD

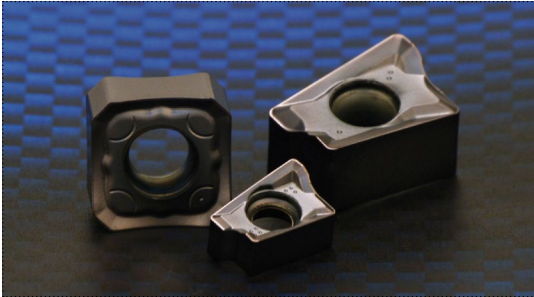

CVD coated carbide

CVD coatings provide a high wear resistance due to its excellent adhesion to cemented carbide.

They are the first choice in a large turning range where wear resistance is important.

PVD coated carbide

PVD coatings offer wear resistance due to their hardness.

They are recommended when sharp cutting edges are needed.

Features of CVD and PVD coated carbide

Material		Grade	Colour	Coating composition	Definition
P Steel		TL10	●	TiAlN	A K10 substrate premium grade with built-in wear resistance and a TiAlN-PVD coating for extended life during finishing applications. Used in ball nose finishing and back draft inserts for the die and mould industry, it is capable of running at moderate to high cutting speeds.
		TL20	●	TiAlN	Carbide with TiAlN and lubricity layer PVD coating. It has a lower friction coefficient and a lower cutting energy during finishing. The sharper cutting edge reduces the built-up edge damage and gives the workpiece an excellent surface finish. Recommended for alloyed steel.
		TL40	●	TiAlN	A tough, general-purpose TiAlN-PVD-coated carbide grade for medium to heavy milling applications for use in all steels, stainless steels and cast irons. TL40 can be used either wet or dry.
		TIN21	●	TiCN+Al ₂ O ₃	A multilayered TiN-TiCN-Al ₂ O ₃ -TiN-PVD-coated carbide grade with a tough substrate used for medium machining of all steels and ductile cast irons. Best results when machining dry, but it can be used wet.
		TIN25	●	TiN-TiC-TiN	Coated with TiN-TiC-TiN. The CVD coating has a thickness of 3-5 microns for use on steel, alloyed steel and stainless steel, with or without coolant.
M Stainless		TIN28	●	TiCN	A thin PVD coated TiCN layer on a tough substrate, for milling, parting and grooving on stainless and alloyed steels at low to medium cutting speeds and for unstable machining conditions.
N Non ferrous materials		ZR10	●	TiB ₂	Micrograin grade with an extremely hard single TiB ₂ layer for machining aluminium, copper alloys and plastics.



CVD-beschichteter Hartmetall

Die CVD-Beschichtungen verfügen über eine hohe Verschleißfestigkeit, weil sie eine hervorragende Haftung auf dem Hartmetall haben. Sie sind die erste Wahl bei einer breiten Drehpalette, bei der die Verschleißfestigkeit wichtig ist.

PVD-beschichteter Hartmetall

Aufgrund Ihrer Härte bieten PVD-Beschichtungen Verschleißfestigkeit an. Sie werden empfohlen, wenn man scharfe Schneidkanten braucht.

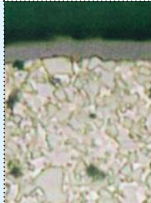
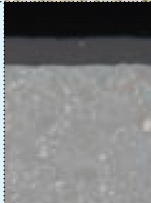
Eigenschaften von CVD und PVD-beschichtetem Hartmetall

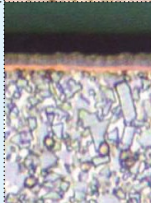
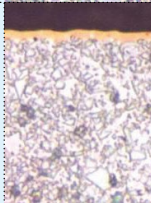
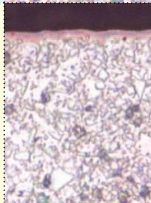
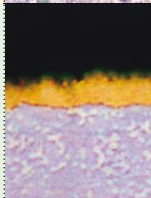
Beschreibung	Zusammensetzung	Farbe	Sorte		Werkstoff
Hochwertig beschichtete Sorte mit K10-Substrat, das Verschleißfestigkeit bietet, und eine TiAlN-PVD-Beschichtung für eine längere Standzeit bei Schlichtbearbeitungen. Sie wird für Vollradius-Schlichtwerkzeuge und für torische Wendeschneidplatten im Werkzeug- und Formenbau verwendet. Sie eignet sich für mittlere bis hohe Schnittgeschwindigkeiten.	TiAlN	●	TL10		P Stahl
PVD beschichtete Sorte mit TiAlN und einer Gleitschicht. Sie hat einen niedrigen Reibungswert und eine niedrige Schneidenergie beim Schlichten. Die scharfe Schneidkante reduziert den Schneidenaufbau und erzeugt eine hervorragende Oberfläche. Empfohlen für legierten Stahl.	TiAlN	●	TL20		
Eine zähe Universal-Hartmetallsorte mit PVD-TiAlN-Beschichtung für mittlere und schwere Fräsanwendungen in allen Stählen und Gußeisen. TL40 eignet sich sowohl für die Trocken- als auch für die Nassbearbeitung.	TiAlN	●	TL40		
Eine Hartmetallsorte mit Multischicht TiN-TiCN-Al ₂ O ₃ TiN-PVD-Beschichtung und einem zähen Substrat, die zur mittleren Bearbeitung sämtlicher Stähle und Kugelgraphit-Gußwerkstoffe verwendet werden kann. Die besten Ergebnisse werden bei Trockenbearbeitung erzielt. Die Sorte kann jedoch auch bei Nassbearbeitung verwendet werden.	TiCN+Al ₂ O ₃	●	TIN21		
Mit TiN-TiC-TiN beschichtet. Die Dicke der CVD-Schicht ist 3-5 Mikron und ist zur Bearbeitung von Stahl, legiertem Stahl und rostfreien Stahl geeignet, mit oder ohne Kühlung.	TiN-TiC-TiN	●	TIN25		
Eine dünne PVD-TiCN Schicht auf einem zähen Substrat. Geeignet zum Fräsen, Ein- und Abstechen auf rostfreiem und legiertem Stahl bei niedrigen bis mittleren Schnittgeschwindigkeiten, und auch für nicht stabilen Bearbeitungsbedingungen.	TiCN	●	TIN28		M Rostfreier Stahl
Mikrokorn-Sorte mit einer einzigen sehr harten TiB ₂ -Schicht, zur Bearbeitung von Aluminium, Kupfer-Legierungen und Kunststoff.	TiB ₂	●	ZR10		N Nicht-Eisen-Metalle



ISO Code key / Bezeichnung

INSERT SHAPE FORM DER WENDEPLATTE		
V	Rhombic 35° Rhombisch 35°	
D	Rhombic 55° Rhombisch 55°	
E	Rhombic 75° Rhombisch 75°	
C	Rhombic 80° Rhombisch 80°	
M	Rhombic 86° Rhombisch 86°	
K	Parallelogram 55° Parallelogramm 55°	
B	Parallelogram 82° Parallelogramm 82°	
A	Parallelogram 85° Parallelogramm 85°	
L	Rectangular 90° Rechteckig 90°	
N	Heptagonal 128,57° Siebeneckig 128,57°	
H	Hexagonal 120° Sechskant 120°	
O	Octagonal 135° Achtkant 135°	
R	Round Rund	
S	Square 90° Vierkant 90°	
T	Triangular 60° Dreikant 60°	
W	Trigon 80° Trigon 80°	
X	Special design Spezielles Design	

TOLERANCES TOLERANZEN										
	m	Ø d	s	Detail of M Class insert tolerance (Tolerance of nose height m) Detailtoleranz für Wendeschneidplatten M-Klasse (Toleranz ohne Radius m)						
				D.I.C						
A	±0.005	±0.025	±0.025	6.35	±0.08	±0.08	±0.08	±0.11	±0.16	-
F	±0.005	±0.013	±0.025	9.525	±0.08	±0.08	±0.08	±0.11	±0.16	-
C	±0.013	±0.025	±0.025	12.70	±0.13	±0.13	±0.13	±0.15	-	-
H	±0.013	±0.013	±0.025	15.875	±0.15	±0.15	±0.15	±0.18	-	-
E	±0.025	±0.025	±0.025	19.05	±0.15	±0.15	±0.15	±0.18	-	-
G	±0.025	±0.025	±0.013	25.40	-	±0.18	-	-	-	-
J	±0.005	±0.05 - ±0.15	±0.025	31.75	-	±0.20	-	-	-	-
K	±0.013	±0.05 - ±0.15	±0.025	Detail of M Class insert tolerance (Tolerance of inscribed circle d) Detailtoleranz für Wendeschneidplatten M-Klasse (Toleranz des Innenkreises d)						
L	±0.025	±0.05 - ±0.15	±0.025	D.I.C						
M	±0.08 - ±0.20	±0.05 - ±0.15	±0.13	6.35	±0.05	±0.05	±0.05	±0.05	±0.05	-
N	±0.08 - ±0.20	±0.05 - ±0.15	±0.025	9.525	±0.05	±0.05	±0.05	±0.05	±0.05	±0.05
U	±0.13 - ±0.38	±0.08 - ±0.25	±0.13	12.70	±0.08	±0.08	±0.08	±0.08	-	±0.08
				15.875	±0.10	±0.10	±0.10	±0.10	-	±0.10
				19.05	±0.10	±0.10	±0.10	±0.10	-	±0.10
				25.40	-	±0.13	-	-	-	±0.13
				31.75	-	±0.15	-	-	-	±0.15

Triangular insert with a facet (Secondary cutting edge)
Dreikant-Wendepatte mit Seitenschneide (Nebenschneide)

S E K N

CLEARANCE ANGLE FREIWINKEL	
A	3°
B	5°
C	7°
D	15°
E	20°
F	25°
G	30°
N	0°
P	11°

SYMBOL FOR FIXING AND/OR FOR CHIPBREAKER BEFESTIGUNGS- UND/ODER SPANBRECHERSYMBOL				
Metric / Metrisch				
	Hole Loch	Hole configuration Loch-Konfiguration	Chipbreaker Spanbrecher	Figure Abbildung
N	Without hole / Ohne Loch	-	No / Nein	
R	Without hole / Ohne Loch	-	One-sided / Einseitig	
F	Without hole / Ohne Loch	-	Double-sided / Doppelseitig	
A	With hole / Mit Loch	Cylindrical hole Zylindrisches Loch	No / Nein	
M	With hole / Mit Loch	Cylindrical hole Zylindrisches Loch	One-sided / Einseitig	
G	With hole / Mit Loch	Cylindrical hole Zylindrisches Loch	Double-sided / Doppelseitig	
W	With hole / Mit Loch	Cylindrical hole + One countersink (40-60°) Zylindrisches Loch + Einseitige Senkung (40-60°)	No / Nein	
T	With hole / Mit Loch	Cylindrical hole + One-sided countersink (40-60°) Zylindrisches Loch + Einseitige Senkung (40-60°)	One-sided / Einseitig	
Q	With hole / Mit Loch	Cylindrical hole + Double countersink (40-60°) Zylindrisches Loch + Doppelseitige Senkung (40-60°)	No / Nein	
U	With hole / Mit Loch	Cylindrical hole + Double countersink (40-60°) Zylindrisches Loch + Doppelseitige Senkung (40-60°)	Double-sided / Doppelseitig	
B	With hole / Mit Loch	Cylindrical hole + One countersink (70-90°) Zylindrisches Loch + Einseitige Senkung (70-90°)	No / Nein	
H	With hole / Mit Loch	Cylindrical hole + One-sided countersink (70-90°) Zylindrisches Loch + Einseitige Senkung (70-90°)	One-sided / Einseitig	
C	With hole / Mit Loch	Cylindrical hole + Double countersink (70-90°) Zylindrisches Loch + Doppelseitige Senkung (70-90°)	No / Nein	
J	With hole / Mit Loch	Cylindrical hole + Double countersink (70-90°) Zylindrisches Loch + Doppelseitige Senkung (70-90°)	Double-sided / Doppelseitig	
X	-	-	-	Special / Spezielles Design

SYMBOL FOR INSERT SIZE SYMBOL FÜR WENDEPLATTENGRÖSSE							
	04	03	03	06			3,97
08	05	04	04	08			4,76
09	06	05	05	09	03		5,56
						06	6,00
11	07	06	06	11	04		6,35
13	09	08	07	13	05		7,94
						08	8,00
16	11	09	09	16	06		9,52
						10	10,00
						12	12,00
22	15	12	12	22	08		12,70
	19	16	15	27	10		15,87
	23	19	19	33	13		19,00
	27	22	22	38			22,22
						25	25,00
	31	25	25	44			25,40
	38	32	31	54			31,75
						32	32,00

INSERT CORNER ECKENRADIUS			
00	0,0	12	1,2
M0	0,0	16	1,6
02	0,2	20	2,0
04	0,4	24	2,4
08	0,8	32	3,2
SECONDARY CUTTING EDGE WINKEL DER NEBENSCHNEIDE			
A	45°	F	85°
D	60°	P	90°
E	75°		
CLEARANCE ANGLE FREIWINKEL			
A	3°	F	25°
B	5°	G	30°
C	7°	N	0°
D	15°	P	11°
E	20°	Z	Special Spezielles

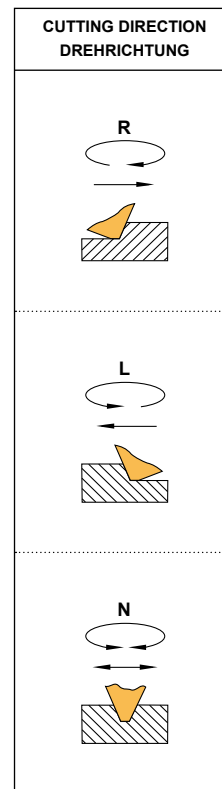





















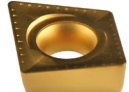







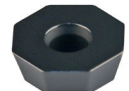

12 03 AF / 04 E N - 3 A





















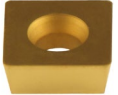

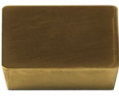

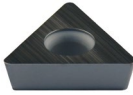
SYMBOL FOR INSERT THICKNESS SYMBOL FÜR WENDEPLATTENDICKE	
SYMBOL	THICKNESS (mm) DICKE (mm)
01	1,59
02	2,38
03	3,18
T3	3,97
04	4,76
05	5,56
06	6,35
07	7,94
09	9,52

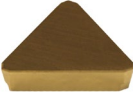
SYMBOL FOR CUTTING EDGE CONDITION SYMBOL FÜR SCHNEIDKANTENAUSFÜHRUNG	
SYMBOL	CUTTING EDGE SCHNEIDKANTE
F	Sharp Scharf
E	Honed Abgerundet
T	Chamfered Gefasst
S	Chamfered and honed Gefasst und abgerundet
K	Double-chamfered Doppelgefasset
P	Double-chamfered and honed Doppelgefasset und abgerundet

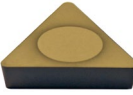
CUTTING EDGE SCHNEIDKANTE	
≤ 1,2	1
1,4	2
2,0	3
2,4	4

CUTTING DIRECTION DREHRICHTUNG	
0	A
0,08 x 40°	B
0,15 x 15°	C
0,15 x 25°	D
0,20 x 10°	E
0,20 x 15°	F
0,20 x 22°	G
0,15 x 20°	X

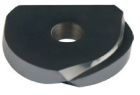
<p>ADKT</p>  <p>Page Seite F10 15°</p>	<p>ADMT</p>  <p>Page Seite F10 15°</p>	<p>ADMT-R</p>  <p>Page Seite F10 15°</p>	<p>ADMW</p>  <p>Page Seite F10 15°</p>	<p>ADMW-C</p>  <p>Page Seite F10 15°</p>	<p>APHT-AL</p>  <p>Page Seite F11 11°</p>
<p>APKT</p>  <p>Page Seite F11 11°</p>	<p>APLT</p>  <p>Page Seite F11 11°</p>	<p>APMT</p>  <p>Page Seite F11 11°</p>	<p>APMW</p>  <p>Page Seite F11 11°</p>		
<p>CCGT-AL</p>  <p>Page Seite F12 7°</p>	<p>CCKT</p>  <p>Page Seite F12 7°</p>	<p>CCMT</p>  <p>Page Seite F12 7°</p>	<p>CCMW</p>  <p>Page Seite F12 7°</p>		
<p>ENHQ</p>  <p>Page Seite F13</p>		<p>FRC</p>  <p>Page Seite F13</p>	<p>FRCR</p>  <p>Page Seite F13</p>		
<p>LNMM</p>  <p>Page Seite F14</p>	<p>NNMU</p>  <p>Page Seite F15</p>				
<p>ODMT</p>  <p>Page Seite F15 15°</p>	<p>ODMW</p>  <p>Page Seite F15 15°</p>				
<p>RDHW</p>  <p>Page Seite F15 15°</p>	<p>RDMT</p>  <p>Page Seite F16 15°</p>	<p>RDMW</p>  <p>Page Seite F16 15°</p>	<p>RPMT</p>  <p>Page Seite F16 11°</p>	<p>RPMW</p>  <p>Page Seite F16 11°</p>	
<p>SCGT-AL</p>  <p>Page Seite F17 7°</p>	<p>SCMT-39</p>  <p>Page Seite F17 7°</p>	<p>SCMW</p>  <p>Page Seite F17 7°</p>	<p>SDMT</p>  <p>Page Seite F17 15°</p>	<p>SEHT</p>  <p>Page Seite F17 20°</p>	<p>SEHT-AL</p>  <p>Page Seite F17 20°</p>

<p>SEHW</p>  <p>Page Seite F17 20°</p>	<p>SEKN</p>  <p>Page Seite F18 20°</p>	<p>SEKR</p>  <p>Page Seite F18 20°</p>	<p>SEMT</p>  <p>Page Seite F18 20°</p>	<p>SNHX</p>  <p>Page Seite F18 0°</p>	<p>SNKN</p>  <p>Page Seite F18 0°</p>
<p>SNMX</p>  <p>Page Seite F19 0°</p>	<p>SNUN</p>  <p>Page Seite F19 0°</p>	<p>SPKN</p>  <p>Page Seite F19 11°</p>	<p>SPKR</p>  <p>Page Seite F19 11°</p>	<p>SPMT</p>  <p>Page Seite F19 11°</p>	<p>SPMW</p>  <p>Page Seite F20 11°</p>
<p>SPMX</p>  <p>Page Seite F20 11°</p>	<p>SPUN</p>  <p>Page Seite F20 11°</p>				
<p>TCGT-AL</p>  <p>Page Seite F21 7°</p>	<p>TCMT-39</p>  <p>Page Seite F21 7°</p>	<p>TCMW</p>  <p>Page Seite F21 7°</p>	<p>TCMX</p>  <p>Page Seite F21 7°</p>		
<p>TPKN</p>  <p>Page Seite F21 11°</p>	<p>TPKR</p>  <p>Page Seite F21 11°</p>	<p>TPUN</p>  <p>Page Seite F22 11°</p>			
<p>VCGT-AL</p>  <p>Page Seite F22 7°</p>	<p>VCGT-AP</p>  <p>Page Seite F22 7°</p>				
<p>HPKW</p>  <p>Page Seite F14 7°</p>	<p>HPR</p>  <p>Page Seite F14 11°</p>				
<p>RPR</p>  <p>Page Seite F16 11°</p>					



**Parallelogram inserts / Positive
Parallelogramme Wendeschneidplatten / Positiv**

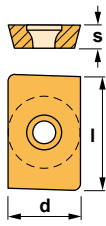

- i** Use classification / Einsatzbereich
- Continuous / Ununterbrochen
 - ◐ Slight interruption / Leicht unterbrochen
 - ⊕ Interruption / Unterbrochen
- i** Availability / Verfügbarkeit
- Standard item / Standard-Artikel
 - Check availability / Verfügbarkeit prüfen

P	Steel Stahl	●	●	●	●	●	●	●	●	●	●	●	●	●	●	●	●	●	●	●
M	Stainless Rostfreier Stahl	●	●	●	●	●	●	●	●	●	●	●	●	●	●	●	●	●	●	●
K	Cast iron Guß	●	●	●	●	●	●	●	●	●	●	●	●	●	●	●	●	●	●	●
N	Non ferrous materials Nicht-Eisen-Metalle	●	●	●	●	●	●	●	●	●	●	●	●	●	●	●	●	●	●	●
S	Heat-resistant alloys Hitzebeständige Legierungen	●	●	●	●	●	●	●	●	●	●	●	●	●	●	●	●	●	●	●
H	Hard materials Harte Materialien	●	●	●	●	●	●	●	●	●	●	●	●	●	●	●	●	●	●	●



APHT-AL



Reference / Bezeichnung	l	s	d	r	KM15	PM25	PM40	TIN21	TIN25	TIN28	TL10	TL20	TL40	ZR10
APHT 1003PDFR-AL	9,52	3,18	6,35	-	●									●
APHT 1604PDFR-AL	17,00	4,76	9,52	-	●									●

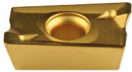

APKT



Reference / Bezeichnung	l	s	d	r	KM15	PM25	PM40	TIN21	TIN25	TIN28	TL10	TL20	TL40	ZR10
APKT 1003PDR	9,52	3,18	6,35	0,4						●				
APKT 1003PDTR	9,52	3,18	6,35	0,4		●		●	●					
APKT 1604PDR	16,00	4,76	9,52	0,8		●		●	●	●				
APKT 160416	16,00	4,76	9,52	1,6					●	●				
APKT 160424	16,00	4,76	9,52	2,4					●	●				
APKT 160432	16,00	4,76	9,52	3,2					●	●				



APLT



Reference / Bezeichnung	l	s	d	r	KM15	PM25	PM40	TIN21	TIN25	TIN28	TL10	TL20	TL40	ZR10
APLT 1504ZZR	15,87	4,76	12,70	0,8					●					



APMT



Reference / Bezeichnung	l	s	d	r	KM15	PM25	PM40	TIN21	TIN25	TIN28	TL10	TL20	TL40	ZR10
APMT 1604PDER	16,00	4,76	9,52	0,8	●	●			●				●	
APMT 200408	20,00	4,76	12,70	0,8		●			●				●	



APMW



Reference / Bezeichnung	l	s	d	r	KM15	PM25	PM40	TIN21	TIN25	TIN28	TL10	TL20	TL40	ZR10
APMW 200408E	20,00	4,76	12,70	0,8		●			●				●	
APMW 200408F	20,00	4,76	12,70	0,8	○									



80° Rhombic inserts / Negative
Rhombische Wendeschneidplatten 80° / Negativ

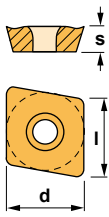

- i** Use classification / Einsatzbereich
- Continuous / Ununterbrochen
 - ◐ Slight interruption / Leicht unterbrochen
 - ⊕ Interruption / Unterbrochen
- i** Availability / Verfügbarkeit
- Standard item / Standard-Artikel
 - Check availability / Verfügbarkeit prüfen

P	Steel Stahl	●	●	●	●	●	●	●	●	●	●	●	●
M	Stainless Rostfreier Stahl	●	●	●	●	●	●	●	●	●	●	●	●
K	Cast iron Guß	●	⊕	⊕	⊕	⊕	⊕	⊕	⊕	⊕	⊕	⊕	⊕
N	Non ferrous materials Nicht-Eisen-Metalle	●	●	●	●	●	●	●	●	●	●	●	●
S	Heat-resistant alloys Hitzebeständige Legierungen	●	●	●	●	●	●	●	●	●	●	●	●
H	Hard materials Harte Materialien	●	●	●	●	●	●	●	●	●	●	●	●



CCGT-AL

Reference / Bezeichnung	l	s	d	r	7°	KM15	PM25	PM40	TIN21	TIN25	TIN28	TL10	TL20	TL40	ZR10
CCGT 060202-AL	6,45	2,38	6,35	0,2	●	●									○
CCGT 060204-AL	6,45	2,38	6,35	0,4	●	●									○
CCGT 09T302-AL	9,65	3,97	9,52	0,2	●	●									○
CCGT 09T304-AL	9,65	3,97	9,52	0,4	●	●									○
CCGT 09T308-AL	9,65	3,97	9,52	0,8	●	●									○
CCGT 120402-AL	12,90	4,76	12,70	0,2	●	●									○
CCGT 120404-AL	12,90	4,76	12,70	0,4	●	●									○
CCGT 120408-AL	12,90	4,76	12,70	0,8	●	●									○

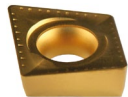

CCKT

Reference / Bezeichnung	l	s	d	r	7°	KM15	PM25	PM40	TIN21	TIN25	TIN28	TL10	TL20	TL40	ZR10
CCKT 060204	6,45	2,38	6,35	0,4					●	●					
CCKT 080308	8,05	3,18	7,94	0,8					●	●					
CCKT 09T308	9,65	4,00	9,52	0,8					●	●					
CCKT 120408	12,90	4,76	12,70	0,8					●	●					



CCMT

Reference / Bezeichnung	l	s	d	r	7°	KM15	PM25	PM40	TIN21	TIN25	TIN28	TL10	TL20	TL40	ZR10
CCMT 060202	6,45	2,38	6,35	0,2			●								
CCMT 060204	6,45	2,38	6,35	0,4			●								
CCMT 080304	8,05	3,18	7,94	0,4			●								
CCMT 080308	8,05	3,18	7,94	0,8			●								
CCMT 09T304	9,65	3,97	9,52	0,4			●								
CCMT 09T308	9,65	3,97	9,52	0,8			●								
CCMT 120408	12,90	4,76	12,70	0,8			●								



CCMW

Reference / Bezeichnung	l	s	d	r	7°	KM15	PM25	PM40	TIN21	TIN25	TIN28	TL10	TL20	TL40	ZR10
CCMW 060202	6,45	2,38	6,35	0,2						○					
CCMW 060204	6,45	2,38	6,35	0,4			●			○					
CCMW 080304	8,05	3,18	7,94	0,4			●			○					
CCMW 09T304	9,65	3,97	9,52	0,4			●			○					
CCMW 09T308	9,65	3,97	9,52	0,8			●			○					
CCMW 120408	12,90	4,76	12,70	0,8			●			○					

Heptagonal inserts / Negative Siebeneckige Wendeschneidplatten / Negativ

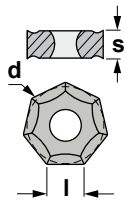

- i** Use classification / Einsatzbereich
- Continuous / Ununterbrochen
 - ◐ Slight interruption / Leicht unterbrochen
 - ⊕ Interruption / Unterbrochen
- i** Availability / Verfügbarkeit
- Standard item / Standard-Artikel
 - Check availability / Verfügbarkeit prüfen

P	Steel Stahl		●	⊕	●	⊕	●	⊕	●	⊕	●	⊕
M	Stainless Rostfreier Stahl		●		●	⊕		●	⊕			
K	Cast iron Guß		●	⊕		⊕		●				
N	Non ferrous materials Nicht-Eisen-Metalle		⊕								⊕	
S	Heat-resistant alloys Hitzebeständige Legierungen											
H	Hard materials Harte Materialien											



NNMU

Reference / Bezeichnung	l	s	d	KM15	PM25	PM40	TIN21	TIN25	TIN28	TL10	TL20	TL40	ZR10
NNMU 200708	8,20	7,25	20,00									●	

Octagonal inserts / Positive Achtkantige Wendeschneidplatten / Positiv

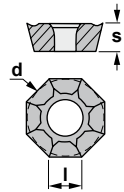

- i** Use classification / Einsatzbereich
- Continuous / Ununterbrochen
 - ◐ Slight interruption / Leicht unterbrochen
 - ⊕ Interruption / Unterbrochen
- i** Availability / Verfügbarkeit
- Standard item / Standard-Artikel
 - Check availability / Verfügbarkeit prüfen

P	Steel Stahl		●	⊕	●	⊕	●	⊕	●	⊕	●	⊕
M	Stainless Rostfreier Stahl		●		●	⊕		●	⊕			
K	Cast iron Guß		●	⊕		⊕		●				
N	Non ferrous materials Nicht-Eisen-Metalle		⊕									⊕
S	Heat-resistant alloys Hitzebeständige Legierungen											
H	Hard materials Harte Materialien											



ODMT

Reference / Bezeichnung	l	s	d	r	KM15	PM25	PM40	TIN21	TIN25	TIN28	TL10	TL20	TL40	ZR10
ODMT 040408	4,00	4,76	12,70	0,8				●						
ODMT 060512	6,00	5,55	16,00	1,2				●						

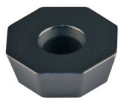

ODMW

Reference / Bezeichnung	l	s	d	r	KM15	PM25	PM40	TIN21	TIN25	TIN28	TL10	TL20	TL40	ZR10
ODMW 060512	6,00	5,55	16,00	1,2				●						

Round inserts / Positive Runde Wendeschneidplatten / Positiv

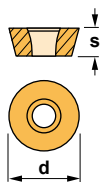

- i** Use classification / Einsatzbereich
- Continuous / Ununterbrochen
 - ◐ Slight interruption / Leicht unterbrochen
 - ⊕ Interruption / Unterbrochen
- i** Availability / Verfügbarkeit
- Standard item / Standard-Artikel
 - Check availability / Verfügbarkeit prüfen

P	Steel Stahl		●	⊕	●	⊕	●	⊕	●	⊕	●	⊕
M	Stainless Rostfreier Stahl		●		●	⊕		●	⊕			
K	Cast iron Guß		●	⊕		⊕		●				
N	Non ferrous materials Nicht-Eisen-Metalle		⊕									⊕
S	Heat-resistant alloys Hitzebeständige Legierungen											
H	Hard materials Harte Materialien											



RDHW

Reference / Bezeichnung	s	d	KM15	PM25	PM40	TIN21	TIN25	TIN28	TL10	TL20	TL40	ZR10
RDHW 0702M0	2,38	7,00								●		
RDHW 1003M0	3,18	10,00								●	●	
RDHW 12T3M0	3,97	12,00								●	●	
RDHW 1604M0	4,76	16,00								●	●	
RDHW 2006M0	6,35	20,00								●		

Round inserts / Positive
Runde Wendeschneidplatten / Positiv

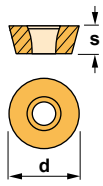

- i** Use classification / Einsatzbereich
- Continuous / Ununterbrochen
- ◐ Slight interruption / Leicht unterbrochen
- ⊕ Interruption / Unterbrochen
- i** Availability / Verfügbarkeit
- Standard item / Standard-Artikel
- Check availability / Verfügbarkeit prüfen

P	Steel Stahl																			
M	Stainless Rostfreier Stahl																			
K	Cast iron Guß																			
N	Non ferrous materials Nicht-Eisen-Metalle																			
S	Heat-resistant alloys Hitzebeständige Legierungen																			
H	Hard materials Harte Materialien																			



RDMT



Reference / Bezeichnung

	s	d
RDMT 1003M0	3,18	10,00
RDMT 12T3M0	3,97	12,00
RDMT 1604M0	4,76	16,00

KM15																				
PM25																				
PM40																				
TIN21																				
TIN25																				
TIN28																				
TL10																				
TL20																				
TL40																				
ZR10																				

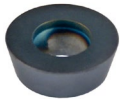

RDMW



Reference / Bezeichnung

	s	d
RDMW 1003M0	3,18	10,00
RDMW 12T3M0	3,97	12,00
RDMW 1604M0	4,76	16,00

KM15																				
PM25																				
PM40																				
TIN21																				
TIN25																				
TIN28																				
TL10																				
TL20																				
TL40																				
ZR10																				



RPMT



Reference / Bezeichnung

	s	d
RPMT 120400-39	4,76	12,70
RPMT 1204M0	4,76	12,00

KM15																				
PM25																				
PM40																				
TIN21																				
TIN25																				
TIN28																				
TL10																				
TL20																				
TL40																				
ZR10																				



RPMW



Reference / Bezeichnung

	s	d
RPMW 0802M0	2,38	8,00
RPMW 1003M0	3,18	10,00
RPMW 1204M0	4,76	12,00
RPMW 1204M0T	4,76	12,00

KM15																				
PM25																				
PM40																				
TIN21																				
TIN25																				
TIN28																				
TL10																				
TL20																				
TL40																				
ZR10																				

Round inserts / Positive
Runde Wendeschneidplatten / Positiv

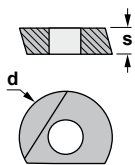

- i** Use classification / Einsatzbereich
- Continuous / Ununterbrochen
- ◐ Slight interruption / Leicht unterbrochen
- ⊕ Interruption / Unterbrochen
- i** Availability / Verfügbarkeit
- Standard item / Standard-Artikel
- Check availability / Verfügbarkeit prüfen

P	Steel Stahl																			
M	Stainless Rostfreier Stahl																			
K	Cast iron Guß																			
N	Non ferrous materials Nicht-Eisen-Metalle																			
S	Heat-resistant alloys Hitzebeständige Legierungen																			
H	Hard materials Harte Materialien																			



RPR



Reference / Bezeichnung

	s	d
RPR 10	2,60	10,00
RPR 12	3,00	12,00
RPR 16	4,00	16,00
RPR 20	5,00	20,00
RPR 25	6,00	25,00
RPR 32	7,00	32,00

KM15																				
PM25																				
PM40																				
TIN21																				
TIN25																				
TIN28																				
TL10																				
TL20																				
TL40																				
ZR10																				

Square inserts / Positive
Vierkant-Wendeschneidplatten / Positiv

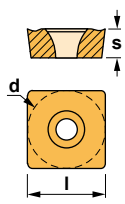

- i** Use classification / Einsatzbereich
- Continuous / Ununterbrochen
 - ◐ Slight interruption / Leicht unterbrochen
 - ✚ Interruption / Unterbrochen
- i** Availability / Verfügbarkeit
- Standard item / Standard-Artikel
 - Check availability / Verfügbarkeit prüfen

P	Steel Stahl		●	●	●	●	●	●	●	●	●	●	●
M	Stainless Rostfreier Stahl		●	●	●	●	●	●	●	●	●	●	●
K	Cast iron Guß		●	✚	✚	✚	✚	✚	✚	✚	✚	✚	✚
N	Non ferrous materials Nicht-Eisen-Metalle		●	●	●	●	●	●	●	●	●	●	●
S	Heat-resistant alloys Hitzebeständige Legierungen		●	●	●	●	●	●	●	●	●	●	●
H	Hard materials Harte Materialien		●	●	●	●	●	●	●	●	●	●	●



SCGT-AL



Reference / Bezeichnung	l	s	d	r	KM15	PM25	PM40	TIN21	TIN25	TIN28	TL10	TL20	TL40	ZR10
SCGT 09T304-AL	9,52	3,97	9,52	0,4	●									○
SCGT 09T308-AL	9,52	3,97	9,52	0,8	●									○
SCGT 120408-AL	12,70	4,76	12,70	0,8	●									○



SCMT-39



Reference / Bezeichnung	l	s	d	r	KM15	PM25	PM40	TIN21	TIN25	TIN28	TL10	TL20	TL40	ZR10
SCMT 09T304-39	9,52	3,97	9,52	0,4		●			●					
SCMT 09T308-39	9,52	3,97	9,52	0,8	○	●			●					
SCMT 120408-39	12,70	4,76	12,70	0,8	○	●			●					
SCMT 120412-39	12,70	4,76	12,70	1,2		●			●					
SCMT 120612-39	12,70	6,35	12,70	1,2		●			●					



SCMW



Reference / Bezeichnung	l	s	d	r	KM15	PM25	PM40	TIN21	TIN25	TIN28	TL10	TL20	TL40	ZR10
SCMW 09T308	9,52	3,97	9,52	0,8		○			○					
SCMW 120408	12,70	4,76	12,70	0,8	○	○			○					
SCMW 120412	12,70	4,76	12,70	1,2		○			○					



SDMT



Reference / Bezeichnung	l	s	d	r	KM15	PM25	PM40	TIN21	TIN25	TIN28	TL10	TL20	TL40	ZR10
SDMT 09T308	9,52	3,97	9,52	0,8				●					●	
SDMT 120508	12,35	5,00	12,35	0,8				●					●	



SEHT



Reference / Bezeichnung	l	s	d	r	KM15	PM25	PM40	TIN21	TIN25	TIN28	TL10	TL20	TL40	ZR10
SEHT 1204AFN	12,70	4,76	12,70	-				●	●					



SEHT-AL



Reference / Bezeichnung	l	s	d	r	KM15	PM25	PM40	TIN21	TIN25	TIN28	TL10	TL20	TL40	ZR10
SEHT 1204AFFN-AL	12,70	3,18	12,70	-	●									●



SEHW



Reference / Bezeichnung	l	s	d	r	KM15	PM25	PM40	TIN21	TIN25	TIN28	TL10	TL20	TL40	ZR10
SEHW 1204AFEN001	12,70	4,76	12,70	-	●									
SEHW 1204AFSN151	12,70	4,76	12,70	-		●		●	●					



Square inserts / Positive
Vierkant-Wendeschneidplatten / Positiv

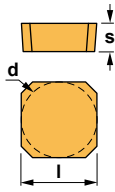

- i** Use classification / Einsatzbereich
- Continuous / Ununterbrochen
- ◐ Slight interruption / Leicht unterbrochen
- ⊕ Interruption / Unterbrochen
- i** Availability / Verfügbarkeit
- Standard item / Standard-Artikel
- Check availability / Verfügbarkeit prüfen

P	Steel Stahl		⊕	⊕	⊕	⊕	⊕	⊕	⊕	⊕	⊕	⊕
M	Stainless Rostfreier Stahl		⊕			⊕	⊕					
K	Cast iron Guß		⊕	⊕		⊕						
N	Non ferrous materials Nicht-Eisen-Metalle		⊕									⊕
S	Heat-resistant alloys Hitzebeständige Legierungen											
H	Hard materials Harte Materialien											



SEKN



Reference / Bezeichnung	l	s	d	KM15	PM25	PM40	TIN21	TIN25	TIN28	TL10	TL20	TL40	ZR10
SEKN 1203AFEN-3A	12,70	3,18	12,70	●									
SEKN 1203AFSN-3D	12,70	3,18	12,70				●	●				●	
SEKN 1204AFEN-3A	12,70	4,76	12,70	○									
SEKN 1204AFSN-3D	12,70	4,76	12,70		●			●				●	
SEKN 1504AFEN-4A	15,88	4,76	15,88	○									
SEKN 1504AFSN-4D	15,88	4,76	15,88		●			●				●	



SEKR



Reference / Bezeichnung	l	s	d	KM15	PM25	PM40	TIN21	TIN25	TIN28	TL10	TL20	TL40	ZR10
SEKR 1203AFN	12,70	3,18	12,70										
SEKR 1203AFTN-94	12,70	3,18	12,70				●	●	●				



SEMT



Reference / Bezeichnung	l	s	d	KM15	PM25	PM40	TIN21	TIN25	TIN28	TL10	TL20	TL40	ZR10
SEMT 1204AFTN	12,70	4,76	12,70						●				

F

Square inserts / Negative
Vierkant-Wendeschneidplatten / Negativ

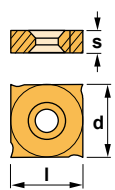

- i** Use classification / Einsatzbereich
- Continuous / Ununterbrochen
- ◐ Slight interruption / Leicht unterbrochen
- ⊕ Interruption / Unterbrochen
- i** Availability / Verfügbarkeit
- Standard item / Standard-Artikel
- Check availability / Verfügbarkeit prüfen

P	Steel Stahl		⊕	⊕	⊕	⊕	⊕	⊕	⊕	⊕	⊕	⊕	⊕
M	Stainless Rostfreier Stahl		⊕				⊕	⊕					
K	Cast iron Guß		⊕	⊕		⊕							
N	Non ferrous materials Nicht-Eisen-Metalle		⊕										⊕
S	Heat-resistant alloys Hitzebeständige Legierungen												
H	Hard materials Harte Materialien												



SNHX

Reference / Bezeichnung	l	s	d	KM15	PM25	PM40	TIN21	TIN25	TIN28	TL10	TL20	TL40	ZR10
SNHX 1102XX	11,00	2,38	11,00										
SNHX 1103XX	11,00	2,70	11,00										
SNHX 1203XX	12,70	3,18	12,70					●				●	
SNHX 12045XX	12,70	4,50	12,70					●				●	
SNHX 1205XX	12,70	5,40	12,70					●				●	
SNHX 1207XX	12,70	7,00	12,70					●				●	



SNKN

Reference / Bezeichnung	l	s	d	KM15	PM25	PM40	TIN21	TIN25	TIN28	TL10	TL20	TL40	ZR10
SNKN 1204ENN	12,70	4,76	12,70	○	●								

Square inserts / Negative Vierkant-Wendeschneidplatten / Negativ

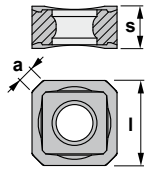

- i** Use classification / Einsatzbereich
- Continuous / Ununterbrochen
 - ◐ Slight interruption / Leicht unterbrochen
 - ⊕ Interruption / Unterbrochen
- i** Availability / Verfügbarkeit
- Standard item / Standard-Artikel
 - Check availability / Verfügbarkeit prüfen

P	Steel Stahl		●	⊕	●	⊕	●	⊕	●	⊕	●	⊕
M	Stainless Rostfreier Stahl		●	●	●	●	●	●	●	●	●	●
K	Cast iron Guß		●	⊕	⊕	⊕	⊕	⊕	●	⊕	⊕	⊕
N	Non ferrous materials Nicht-Eisen-Metalle		⊕									⊕
S	Heat-resistant alloys Hitzebeständige Legierungen											
H	Hard materials Harte Materialien											



SNMX

Reference / Bezeichnung	l	s	a	KM15	PM25	PM40	TIN21	TIN25	TIN28	TL10	TL20	TL40	ZR10
SNMX 1206ANSN	12,70	6,35	2,36									●	



SNUN

Reference / Bezeichnung	l	s	d	r	KM15	PM25	PM40	TIN21	TIN25	TIN28	TL10	TL20	TL40	ZR10
SNUN 120408E	12,70	4,76	12,70	0,8		●								
SNUN 120408F	12,70	4,76	12,70	0,8	○									
SNUN 120412E	12,70	4,76	12,70	1,2		●								

Square inserts / Positive Vierkant-Wendeschneidplatten / Positiv

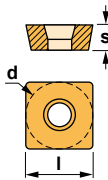

- i** Use classification / Einsatzbereich
- Continuous / Ununterbrochen
 - ◐ Slight interruption / Leicht unterbrochen
 - ⊕ Interruption / Unterbrochen
- i** Availability / Verfügbarkeit
- Standard item / Standard-Artikel
 - Check availability / Verfügbarkeit prüfen

P	Steel Stahl		●	⊕	●	⊕	●	⊕	●	⊕	●	⊕
M	Stainless Rostfreier Stahl		●	●	●	●	●	●	●	●	●	●
K	Cast iron Guß		●	⊕	⊕	⊕	⊕	⊕	⊕	⊕	●	⊕
N	Non ferrous materials Nicht-Eisen-Metalle		⊕									⊕
S	Heat-resistant alloys Hitzebeständige Legierungen											
H	Hard materials Harte Materialien											



SPKN

Reference / Bezeichnung	l	s	d	r	KM15	PM25	PM40	TIN21	TIN25	TIN28	TL10	TL20	TL40	ZR10
SPKN 1203EDER-3A	12,70	3,18	12,70	-	●									
SPKN 1203EDSR-3C	12,70	3,18	12,70	-		●		●	●					
SPKN 1203EDTR	12,70	3,18	12,70	-						●				
SPKN 1504EDSR-2F	15,88	4,76	15,88	-								●		



SPKR

Reference / Bezeichnung	l	s	d	r	KM15	PM25	PM40	TIN21	TIN25	TIN28	TL10	TL20	TL40	ZR10
SPKR 1203EDSR	12,70	3,18	12,70	-									●	



SPMT

Reference / Bezeichnung	l	s	d	r	KM15	PM25	PM40	TIN21	TIN25	TIN28	TL10	TL20	TL40	ZR10
SPMT 060304	6,35	3,18	6,35	0,4									●	
SPMT 070308	7,94	3,18	7,94	0,8									●	
SPMT 090308	9,52	3,18	9,52	0,8									●	
SPMT 120408	12,70	4,76	12,70	0,8									●	



Square inserts / Positive
Vierkant-Wendeschneidplatten / Positiv

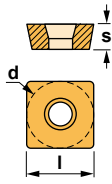

- i** Use classification / Einsatzbereich
- Continuous / Ununterbrochen
 - ◐ Slight interruption / Leicht unterbrochen
 - ⊕ Interruption / Unterbrochen
- i** Availability / Verfügbarkeit
- Standard item / Standard-Artikel
 - Check availability / Verfügbarkeit prüfen

P	Steel Stahl		⊕	⊕	⊕	⊕	⊕	⊕	⊕	⊕	⊕	⊕	⊕
M	Stainless Rostfreier Stahl		⊕	⊕	⊕	⊕	⊕	⊕	⊕	⊕	⊕	⊕	⊕
K	Cast iron Guß		⊕	⊕	⊕	⊕	⊕	⊕	⊕	⊕	⊕	⊕	⊕
N	Non ferrous materials Nicht-Eisen-Metalle		⊕										⊕
S	Heat-resistant alloys Hitzebeständige Legierungen												
H	Hard materials Harte Materialien												



SPMW



Reference / Bezeichnung	l	s	d	r	KM15	PM25	PM40	TIN21	TIN25	TIN28	TL10	TL20	TL40	ZR10
SPMW 120408	12,70	4,76	12,70	0,8	○	●			●				●	



SPUN



Reference / Bezeichnung	l	s	d	r	KM15	PM25	PM40	TIN21	TIN25	TIN28	TL10	TL20	TL40	ZR10
SPUN 090304E	9,52	3,18	9,52	0,4		●			●					
SPUN 090308E	9,52	3,18	9,52	0,8		●			●					
SPUN 120304E	12,70	3,18	12,70	0,4		●			●					
SPUN 120308E	12,70	3,18	12,70	0,8		●			●				○	
SPUN 120308F	12,70	3,18	12,70	0,8	●									
SPUN 120312E	12,70	3,18	12,70	1,2		●		●	●					
SPUN 120408E	12,70	4,76	12,70	0,8		○								
SPUN 150408E	15,88	4,76	15,88	0,8		○								
SPUN 150412E	15,88	4,76	15,88	1,2		○								
SPUN 190412E	19,05	4,76	19,05	1,2		○								

High feed inserts / Positive
Hoher Vorschub-Wendeschneidplatten / Positiv

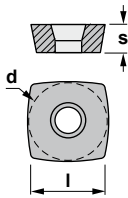

- i** Use classification / Einsatzbereich
- Continuous / Ununterbrochen
 - ◐ Slight interruption / Leicht unterbrochen
 - ⊕ Interruption / Unterbrochen
- i** Availability / Verfügbarkeit
- Standard item / Standard-Artikel
 - Check availability / Verfügbarkeit prüfen

P	Steel Stahl		⊕	⊕	⊕	⊕	⊕	⊕	⊕	⊕	⊕	⊕	⊕
M	Stainless Rostfreier Stahl		⊕	⊕	⊕	⊕	⊕	⊕	⊕	⊕	⊕	⊕	⊕
K	Cast iron Guß		⊕	⊕	⊕	⊕	⊕	⊕	⊕	⊕	⊕	⊕	⊕
N	Non ferrous materials Nicht-Eisen-Metalle		⊕										⊕
S	Heat-resistant alloys Hitzebeständige Legierungen												
H	Hard materials Harte Materialien												



SPMX



Reference / Bezeichnung	l	s	d	r	KM15	PM25	PM40	TIN21	TIN25	TIN28	TL10	TL20	TL40	ZR10
SPMX 073505	7,00	3,50	7,00	0,5								●		
SPMX 094506	9,70	4,40	9,70	0,6								●		
SPMX 115506	11,60	5,40	11,60	0,6								●		

Triangular inserts / Positive
Dreikant-Wendeschneidplatten / Positiv

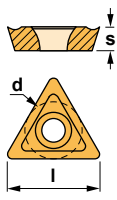

- i** Use classification / Einsatzbereich
- Continuous / Ununterbrochen
 - ◐ Slight interruption / Leicht unterbrochen
 - ✚ Interruption / Unterbrochen
- i** Availability / Verfügbarkeit
- Standard item / Standard-Artikel
 - Check availability / Verfügbarkeit prüfen

P	Steel Stahl		●	●	●	●	●	●	●	●	●	●	●
M	Stainless Rostfreier Stahl		●	●	●	●	●	●	●	●	●	●	●
K	Cast iron Guß		●	✚	✚	✚	✚	✚	✚	✚	✚	✚	✚
N	Non ferrous materials Nicht-Eisen-Metalle		●										●
S	Heat-resistant alloys Hitzebeständige Legierungen												
H	Hard materials Harte Materialien												



TCGT-AL



Reference / Bezeichnung	l	s	d	r	KM15	PM25	PM40	TIN21	TIN25	TIN28	TL10	TL20	TL40	ZR10
TCGT 110202-AL	11,00	2,38	6,35	0,2	●									○
TCGT 110204-AL	11,00	2,38	6,35	0,4	●									○
TCGT 16T302-AL	16,50	3,97	9,52	0,2	●									○
TCGT 16T304-AL	16,50	3,97	9,52	0,4	●									○
TCGT 16T308-AL	16,50	3,97	9,52	0,8	●									○



TCMT-39



Reference / Bezeichnung	l	s	d	r	KM15	PM25	PM40	TIN21	TIN25	TIN28	TL10	TL20	TL40	ZR10
TCMT 16T308-39	16,50	3,97	9,52	0,8		●			●					
TCMT 16T312-39	16,50	3,97	9,52	1,2		●			●				●	

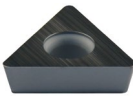

TCMW



Reference / Bezeichnung	l	s	d	r	KM15	PM25	PM40	TIN21	TIN25	TIN28	TL10	TL20	TL40	ZR10
TCMW 110204	11,00	2,38	6,35	0,4	○	●								
TCMW 16T304	16,50	3,97	9,52	0,4	●									
TCMW 16T308	16,50	3,97	9,52	0,8	●	●							○	

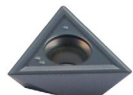

TCMX



Reference / Bezeichnung	l	s	d	r	KM15	PM25	PM40	TIN21	TIN25	TIN28	TL10	TL20	TL40	ZR10
TCMX 16T300	16,50	3,97	9,52	0,4									●	

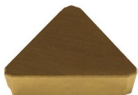

TPKN



Reference / Bezeichnung	l	s	d	r	KM15	PM25	PM40	TIN21	TIN25	TIN28	TL10	TL20	TL40	ZR10
TPKN 1103PPSN-1C	11,00	3,18	6,35	-		●			○					
TPKN 1603PDER-1A	16,50	3,18	9,52	-	●									
TPKN 1603PDSR-1C	16,50	3,18	9,52	-		●			●				●	
TPKN 2204PDER-1A	22,00	4,76	12,70	-	●									
TPKN 2204PDSR-1F	22,00	4,76	12,70	-		●			●				●	



TPKR



Reference / Bezeichnung	l	s	d	r	KM15	PM25	PM40	TIN21	TIN25	TIN28	TL10	TL20	TL40	ZR10
TPKR 1603PPSR	16,50	3,18	9,52	-					●				●	





FACE AND CHAMFERING MILLING CUTTERS PLAN- UND ANFASFRÄSER

Applications index **F24-25**
Anwendungen

Facing milling cutters **F26-43**
Planfräser

Chamfer and corner radius milling cutters **F44-59**
Anfas- und Viertelkreisfräser

Cutting data **F60-61**
Schnittdaten



F

Face milling cutters
Planfräser

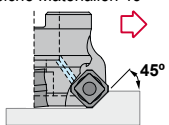
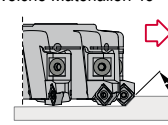
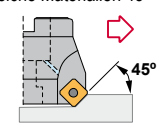
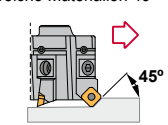
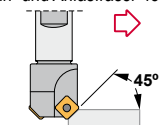
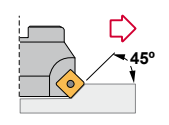
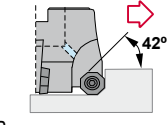
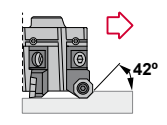
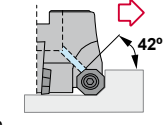
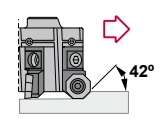
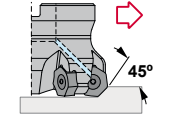
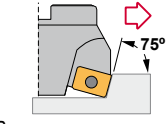
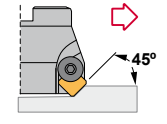
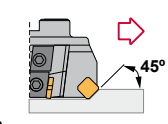
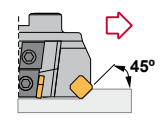
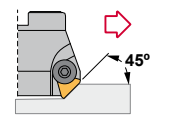
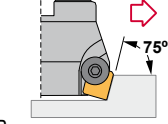
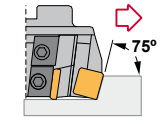
<p>1742.93 45° Soft materials 45° Weiche Materialien 45°</p>  <p>Page Seite F26 SNMX 1206..</p>	<p>1742.99 45° Soft materials 45° Weiche Materialien 45°</p>  <p>Page Seite F27 SNMX 1206..</p>	<p>1748.93 45° Soft materials 45° Weiche Materialien 45°</p>  <p>Page Seite F28 SEH.. 1204.. SEMT 1204..</p>	<p>1748.99 45° Soft materials 45° Weiche Materialien 45°</p>  <p>Page Seite F29 SEH.. 1204.. SEMT 1204..</p>	<p>1748.07 45° Facing and chamfering 45° Plan- und Anfasfräser 45°</p>  <p>SEH.. 1204.. Page SEMT 1204.. Seite F30</p>
<p>0744.90 45° Facing and chamfering 45° Plan- und Anfasfräser 45°</p>  <p>Page Seite F31 SC.. 1204..</p>	<p>1845.93 42° Multipurpose milling 42° Multifunktions-Fräser 42°</p>  <p>Page Seite F32 ODMT 0404..</p>	<p>1845.99 42° Multipurpose milling 42° Multifunktions-Fräser 42°</p>  <p>Page Seite F33 ODMT 0404..</p>	<p>1855.93 42° Multipurpose milling 42° Multifunktions-Fräser 42°</p>  <p>Page Seite F34 ODM.. 0605..</p>	<p>1855.99 42° Multipurpose milling 42° Multifunktions-Fräser 42°</p>  <p>Page Seite F35 ODM.. 0605..</p>
<p>1852.93 45° Multipurpose milling 45° Multifunktions-Fräser 45°</p>  <p>Page Seite F36 NNMU 2007..</p>	<p>1430.90 75° General application 75° Allgemeine Anwendungen 75°</p>  <p>Page Seite F37 AP.. 1604..</p>	<p>0748.90 45° First choice 45° Erste Wahl 45°</p>  <p>Page Seite F38 SEK.. 1203..</p>	<p>0748.99 45° General application 45° Allgemeine Anwendungen 45°</p>  <p>Page Seite F39 SEK.. 1203..</p>	<p>0758.99 45° Deep cutting 45° Tiefer Schnitt 45°</p>  <p>Page Seite F40 SEK.. 1504..</p>
<p>0640.90 45° Facing and chamfering 45° Plan- und Anfasfräser 45°</p>  <p>Page Seite F41 TPUN 2204..</p>	<p>0440.90 75° General application 75° Allgemeine Anwendungen 75°</p>  <p>Page Seite F42 SP.. 1203..</p>	<p>0440.99 75° General application 75° Allgemeine Anwendungen 75°</p>  <p>Page Seite F43 SP.. 1203..</p>		

Chamfer and corner radius milling cutters
Anfas- und Viertelkreisfräser

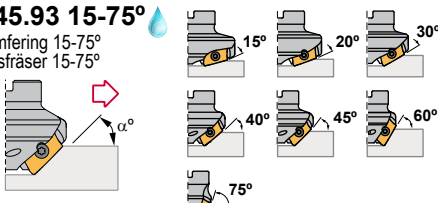
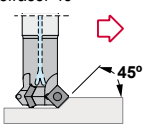
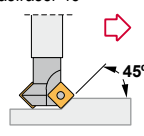
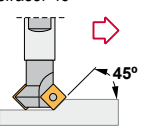
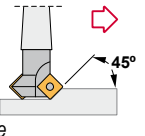
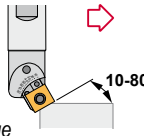
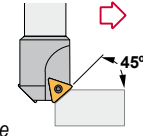
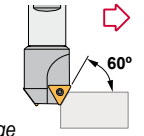
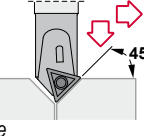
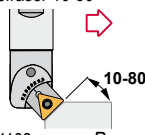
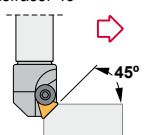
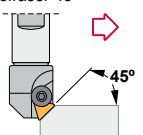
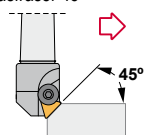
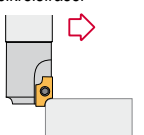
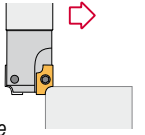
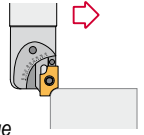
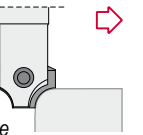
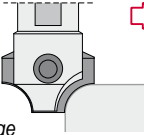
<p>1745.93 15-75° Chamfering 15-75° Anfasfräser 15-75°</p>  <p>Page Seite F44-45</p> <p>ADKT 2206..</p>	<p>0735.03 45° Chamfering 45° Anfasfräser 45°</p>  <p>Page Seite F46</p> <p>SDMT 09T3..</p>	<p>0740.00 45° Chamfering 45° Anfasfräser 45°</p>  <p>Page Seite F47</p> <p>SPM.. 1204..</p>	<p>0740.07 45° Chamfering 45° Anfasfräser 45°</p>  <p>Page Seite F47</p> <p>SPM.. 1204..</p>	
<p>0740.30 45° Chamfering 45° Anfasfräser 45°</p>  <p>Page Seite F48</p> <p>SPM.. 1204..</p>	<p>1744.07 Chamfering cutters 10-80° Anfasfräser 10-80°</p>  <p>Page Seite F49</p> <p>SC.. 1204..</p>	<p>0624.07 45° Chamfering cutters 45° Anfasfräser 45°</p>  <p>Page Seite F50</p> <p>TC.. 1102..</p>	<p>0724.07 60° Chamfering cutters 60° Anfasfräser 60°</p>  <p>Page Seite F50</p> <p>TC.. 1102..</p>	<p>0634.37 45° Chamfering 45° Anfasfräser 45°</p>  <p>Page Seite F51</p> <p>TCMX 16T3..</p>
<p>1634.07 Chamfering cutters 10-80° Anfasfräser 10-80°</p>  <p>TC.. 1102.. Page TC.. 16T3.. Seite F52</p>	<p>0630.00 45° Chamfering 45° Anfasfräser 45°</p>  <p>Page Seite F53</p> <p>TPUN 1603..</p>	<p>0630.07 45° Chamfering 45° Anfasfräser 45°</p>  <p>Page Seite F53</p> <p>TPUN 1603..</p>	<p>0630.30 45° Chamfering 45° Anfasfräser 45°</p>  <p>Page Seite F54</p> <p>TPUN 1603..</p>	<p>1235.01 Concave milling cutters Viertelkreisfräser</p>  <p>Page Seite F55</p> <p>ADMT-R 1503..</p>
<p>1235.07 Concave milling cutters Viertelkreisfräser</p>  <p>Page Seite F56</p> <p>ADMT-R 1503..</p>	<p>1725.07 Concave milling cutters Viertelkreisfräser</p>  <p>Page Seite F57</p> <p>ADMT-R 1503..</p>	<p>1345.07 Concave milling cutters Viertelkreisfräser</p>  <p>Page Seite F58</p> <p>HPKW 2504..</p>	<p>1345.06 Concave milling cutters Viertelkreisfräser</p>  <p>Page Seite F59</p> <p>HPKW 2504..</p>	



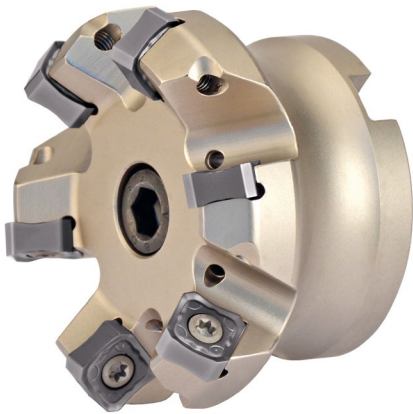

Characteristics:

Super positive milling cutter with 45° entering angle that decreases cutting forces and allows a quick feed in a limited capacity machine. It works well on hard steels, alloyed steels, stainless steels, refractory casts and aluminium alloys.

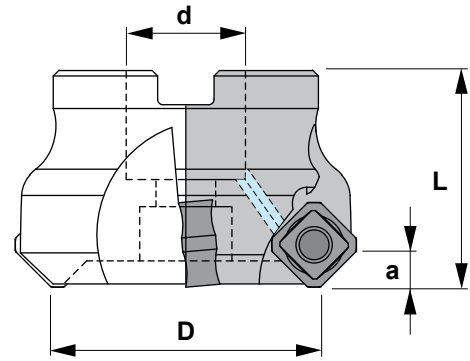

Eigenschaften:

Extra positiver Planfräser mit 45° Einstellwinkel, der die Schnittkraft reduziert und einen schnellen Vorschub in einer Maschine mit beschränkter Leistung erlaubt. Für Stahl, rostfreien Stahl, legierten Stahl, Guß und Aluminium-Legierungen empfohlen.

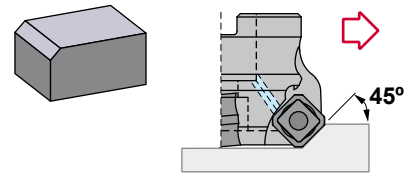

1742.93 45°

Reference Bezeichnung		D	L	d	a	Insert size Wendschneidplatte	
1742.93.050	4	50	40	22	6	SNMX 1206..	0,350
1742.93.063	6	63	50	22	6	SNMX 1206..	0,800
1742.93.080	7	80	50	27	6	SNMX 1206..	1,150
1742.93.100	8	100	50	32	6	SNMX 1206..	1,700
1742.93.125	10	125	63	40	6	SNMX 1206..	2,750
1742.90.160	12	160	63	40	6	SNMX 1206..	4,600
1742.90.200	14	200	63	60	6	SNMX 1206..	6,600

Reference Bezeichnung					Nm
1742.93.050	1550	5520	-	912,10	4.0
1742.93.063	1550	5520	-	912,10	4.0
1742.93.080	1550	5520	-	912,12	4.0
1742.93.100	1550	-	5620	912,17	4.0
1742.93.125	1550	-	5620	912,20	4.0
1742.90.160	1550	-	5620	-	4.0
1742.90.200	1550	-	5620	-	4.0

SNMX

Square negative insert. Vierkantige negative Wendschneidplatte. F19

Reference / Bez.	l	s	a
SNMX 1206..	12,70	6,35	2,36

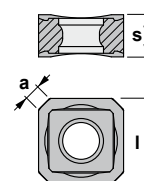

SNMX



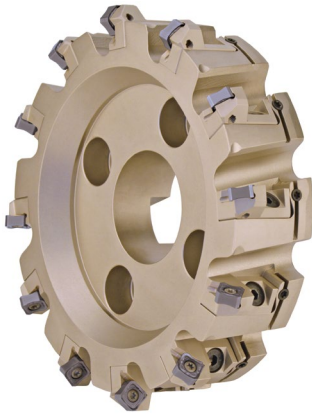

Characteristics:

Super positive milling cutter with 45° entering angle that decreases cutting forces and allows a quick feed in a limited capacity machine. It works well on hard steels, alloyed steels, stainless steels, refractory casts and aluminium alloys.

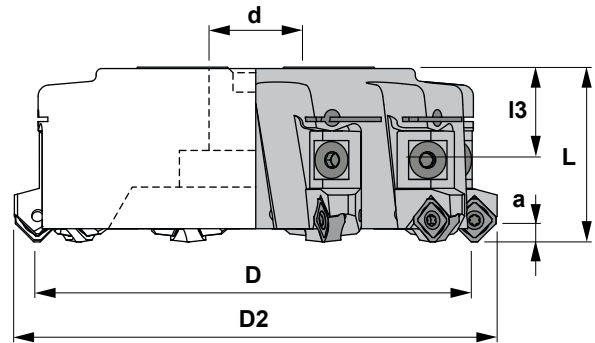

Eigenschaften:

Extra positiver Planfräser mit 45° Einstellwinkel, der die Schnittkraft reduziert und einen schnellen Vorschub in einer Maschine mit beschränkter Leistung erlaubt. Für Stahl, rostfreien Stahl, legierten Stahl, Guß und Aluminium-Legierungen empfohlen.

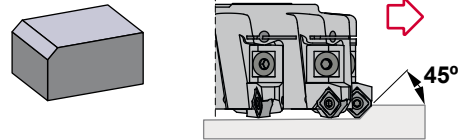

1742.99 45°

Reference Bezeichnung		D	L	d	a	Insert size Wendeschneidplatte	
1742.99.160	10	160	63	40	6	SNMX 1206..	5,450
1742.99.200	12	200	63	60	6	SNMX 1206..	9,000
1742.99.250	16	250	63	60	6	SNMX 1206..	14,250
1742.99.315	20	315	63	60	6	SNMX 1206..	31,000
1742.99.400	22	400	63	60	6	SNMX 1206..	47,500
1742.99.500	28	500	63	60	6	SNMX 1206..	85,000

Reference Bezeichnung						Nm
1742.99.160	1550	5620	6742	1788	1460	4.0
1742.99.200	1550	5620	6742	1788	1460	4.0
1742.99.250	1550	5620	6742	1788	1460	4.0
1742.99.315	1550	5620	6742	1788	1460	4.0
1742.99.400	1550	5620	6742	1788	1460	4.0
1742.99.500	1550	5620	6742	1788	1460	4.0

SNMX

Square negative insert. F19
Vierkantige negative Wendeschneidplatte.

Reference / Bez.	l	s	a
SNMX 1206..	12,70	6,35	2,36

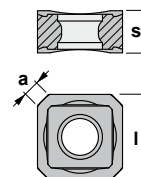

SNMX





Characteristics:

Super positive face milling cutter with 45° entering angle that decreases cutting forces and allows a quick feed in a limited capacity machine.

It works well on steels, stainless steel, alloyed steels, cast iron and aluminium alloys.

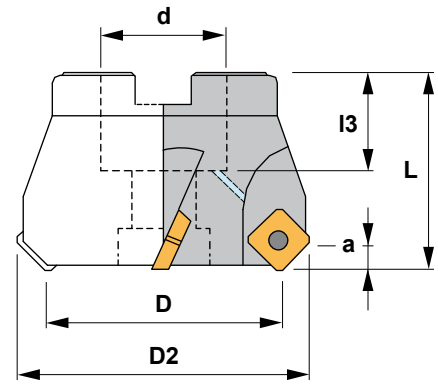

Eigenschaften:

Extra positiver Planfräser mit 45° Einstellwinkel, der die Schnittkraft reduziert und einen schnellen Vorschub in einer Maschine mit beschränkter Leistung erlaubt.

Für Stahl, rostfreien Stahl, legierten Stahl, Guß und Aluminium-Legierungen empfohlen.

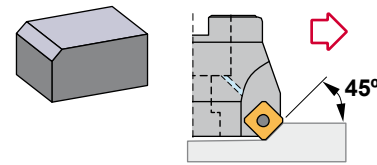

1748.93 45°

Reference Bezeichnung		D	D2	L	d	l3	a	Insert size Wendschneidplatte	
1748.93.050	4	50	62	40	22	20	6	SE.. 1204..	0,350
1748.93.063	5	63	75	50	22	20	6	SE.. 1204..	0,800
1748.93.080	6	80	92	50	27	22	6	SE.. 1204..	1,150
1748.93.100	6	100	112	50	32	25	6	SE.. 1204..	1,700
1748.93.125	7	125	132	63	40	30	6	SE.. 1204..	2,750
1748.90.160	8	160	172	63	40	30	6	SE.. 1204..	4,600
1748.90.200	10	200	212	63	60	40	6	SE.. 1204..	6,600

Reference Bezeichnung						DIN 2079	Nm
1748.93.050	1550	5520	-	912,10	-	-	4.0
1748.93.063	1550	5520	-	912,10	-	-	4.0
1748.93.080	1550	5520	-	912,12	-	-	4.0
1748.93.100	1550	-	5620	-	-	-	4.0
1748.93.125	1550	-	5620	-	-	-	4.0
1748.90.160	1550	-	5620	912,52	40	40	4.0
1748.90.200	1550	-	5620	912,56	50	50	4.0

SE.. Square positive inserts with 20° clearance. F17-18
Vierkantige positive Wendschneidplatten mit 20° Freiwinkel.

Reference / Bez.	l	s	d
SEH.. 1204..	12,70	4,76	12,70
SEMT 1204..	12,70	4,76	12,70

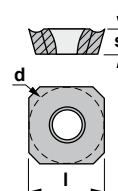



Characteristics:

Super positive face milling cutter with 45° entering angle that decreases cutting forces and allows a quick feed in a limited capacity machine.

It works well on steels, stainless steel, alloyed steels, cast iron and aluminium alloys.

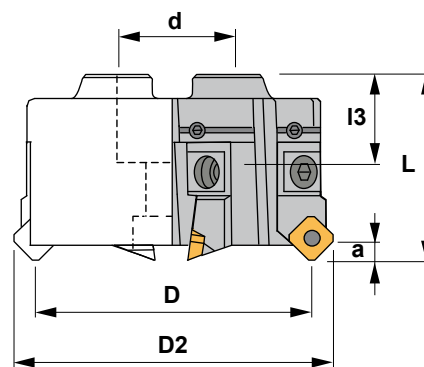

Eigenschaften:

Extra positiver Planfräser mit 45° Einstellwinkel, der die Schnittkraft reduziert und einen schnellen Vorschub in einer Maschine mit beschränkter Leistung erlaubt. Für Stahl, rostfreien Stahl, legierten Stahl, Guß und Aluminium-Legierungen empfohlen.

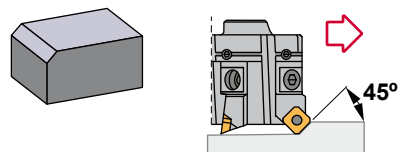

1748.99 45°

Reference Bezeichnung		D	L	d	l3	a	Insert size Wendschneidplatte	
1748.99.160	10	160	63	40	30	6	SE.. 1204..	5,450
1748.99.200	12	200	63	60	40	6	SE.. 1204..	9,000
1748.99.250	16	250	63	60	40	6	SE.. 1204..	14,250
1748.99.315	20	315	63	60	40	6	SE.. 1204..	31,000
1748.99.400	22	400	63	60	40	6	SE.. 1204..	47,500
1748.99.500	28	500	63	60	40	6	SE.. 1204..	85,000

Reference Bezeichnung							DIN 2079	Nm
1748.99.160	1550	5620	6748	1788	1460	40	40	4.0
1748.99.200	1550	5620	6748	1788	1460	50	50	4.0
1748.99.250	1550	5620	6748	1788	1460	50	50	4.0
1748.99.315	1550	5620	6748	1788	1460	50/60	50/60	4.0
1748.99.400	1550	5620	6748	1788	1460	50/60	50/60	4.0
1748.99.500	1550	5620	6748	1788	1460	50/60	50/60	4.0

SE.. Square positive inserts with 20° clearance. F17-18
Vierkantige positive Wendschneidplatten mit 20° Freiwinkel.

Reference / Bez.	l	s	d
SEH.. 1204..	12,70	4,76	12,70
SEMT 1204..	12,70	4,76	12,70

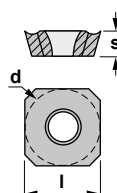

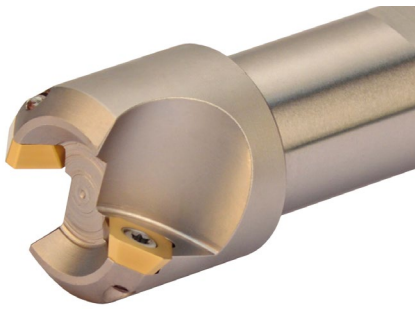

Characteristics:

Super positive face milling cutter with 45° entering angle that decreases cutting forces and allows a quick feed in a limited capacity machine.

It works well on steels, stainless steel, alloyed steels, cast iron and aluminium alloys.

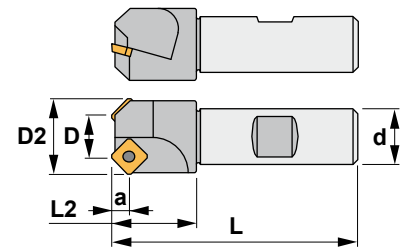

Eigenschaften:

Extra positiver Planfräser mit 45° Einstellwinkel, der die Schnittkraft reduziert und einen schnellen Vorschub in einer Maschine mit beschränkter Leistung erlaubt. Für Stahl, rostfreien Stahl, legierten Stahl, Guß und Aluminium-Legierungen empfohlen.

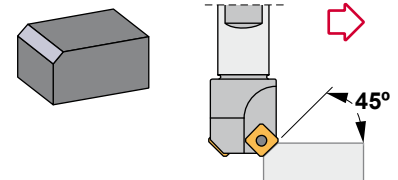

1748.07

Reference Bezeichnung		D	D2	L	L2	d	a	Insert size Wendeschneidplatte	
1748.07.032	2	32	44	125	40	32	6	SE.. 1204..	0,800
1748.07.040	3	40	52	125	40	32	6	SE.. 1204..	0,900

Reference Bezeichnung			Nm
1748.07.032	1550	5520	4.0
1748.07.040	1550	5520	4.0

SE.. Square positive inserts with 20° clearance. F17-18
Vierkantige positive Wendeschneidplatten mit 20° Freiwinkel.

Reference / Bez.	l	s	d
SEH.. 1204..	12,70	4,76	12,70
SEMT 1204..	12,70	4,76	12,70

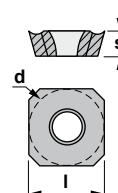

SEHT



SEHT-AL



SEHW



SEMT





Characteristics:

Positive face chamfering milling cutter with 45° entering angle that decreases cutting forces and allows a quick feed in a limited capacity machine.

It works well on steels, stainless steel, alloyed steels, cast iron and aluminium alloys.

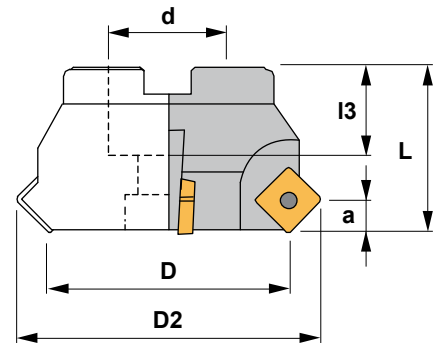

Eigenschaften:

Extra positiver Planfräser mit 45° Einstellwinkel, der die Schnittkraft reduziert und einen schnellen Vorschub in einer Maschine mit beschränkter Leistung erlaubt. Für Stahl, rostfreien Stahl, legierten Stahl, Guß und Aluminium-Legierungen empfohlen.

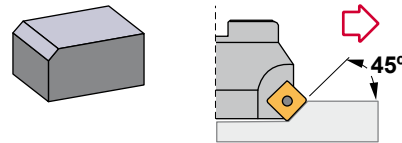

0744.90 45°

Reference Bezeichnung		D	D2	L	d	l3	a	Insert size Wendeschneidplatte	
0744.90.040	4	40	57	40	16	18	7	SC.. 1204..	0,250
0744.90.050	4	50	67	40	22	20	7	SC.. 1204..	0,400
0744.90.063	5	63	80	50	27	22	7	SC.. 1204..	0,850
0744.90.080	6	80	97	50	32	25	7	SC.. 1204..	1,300
0744.90.100	7	100	117	50	40	30	7	SC.. 1204..	2,050
0744.90.125	8	125	142	63	40	30	7	SC.. 1204..	3,250
0744.90.160	9	160	177	63	40	30	7	SC.. 1204..	4,850
0744.90.200	11	200	217	63	60	40	7	SC.. 1204..	8,350

Reference Bezeichnung						Nm
0744.90.040	1250	5520	-	1058	-	4.0
0744.90.050	1250	5520	-	912,10	-	4.0
0744.90.063	1250	5520	-	912,12	-	4.0
0744.90.080	1250	5520	-	912,16	-	4.0
0744.90.100	1250	-	5620	-	-	4.0
0744.90.125	1250	-	5620	-	-	4.0
0744.90.160	1250	-	5620	912,52	40	4.0
0744.90.200	1250	-	5620	912,56	50	4.0

SC..

Square positive inserts with 7° clearance. F17
Vierkantige positive Wendeschneidplatten mit 7° Freiwinkel.

Reference / Bez.	l	s	d
SC.. 1204..	12,70	4,76	12,70

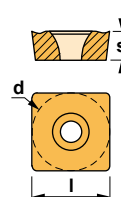

SCGT-AL



SCMT-39



SCMW





Characteristics:

Multipurpose face milling cutter with 42° entering angle that decreases cutting forces and allows a quick feed in a limited capacity machine.

It works well on steels, stainless steel, alloyed steels, cast iron and aluminium alloys.

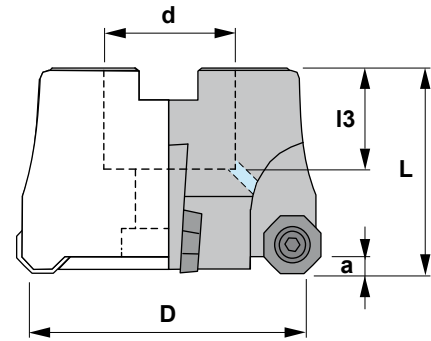

Eigenschaften: Multifunktions-Planfräser mit 42° Einstellwinkel, der die Schnittkraft reduziert und einen schnellen Vorschub in einer Maschine mit beschränkter Leistung erlaubt.

Für Stahl, rostfreien Stahl, legierten Stahl, Guß und Aluminium-Legierungen empfohlen.

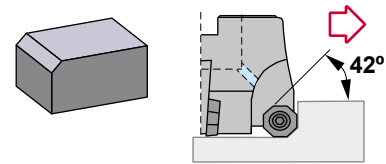

1845.93 42°

Reference Bezeichnung		D	L	d	l3	a	Insert size Wendschneidplatte	
1845.93.040	4	40	40	16	18	3	ODMT 0404..	0,250
1845.93.050	4	50	40	22	20	3	ODMT 0404..	0,350
1845.93.063	5	63	50	27	22	3	ODMT 0404..	0,700
1845.93.080	6	80	50	32	25	3	ODMT 0404..	1,200
1845.93.100	7	100	50	40	30	3	ODMT 0404..	1,850

Reference Bezeichnung					Nm
1845.93.040	1240	5515	-	1058	3.0
1845.93.050	1240	5515	-	912,10	3.0
1845.93.063	1240	5515	-	912,12	3.0
1845.93.080	1240	5515	-	912,16	3.0
1845.93.100	1240	-	5615	-	3.0

ODMT

Octogonal positive insert with 15° clearance. F15
Achtkantige positive Wendschneidplatte mit 15° Freiwinkel.

Reference / Bez.	l	s	d
ODMT 0404..	4,00	4,76	12,70

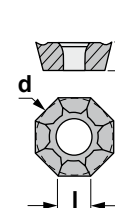

ODMT



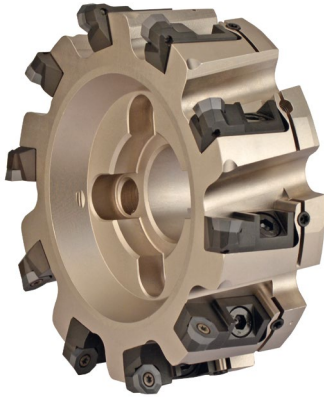

Characteristics:

Multipurpose face milling cutter with 42° entering angle that decreases cutting forces and allows a quick feed in a limited capacity machine.

It works well on steels, stainless steel, alloyed steels, cast iron and aluminium alloys.

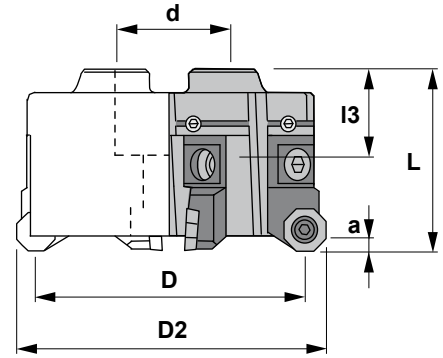

Eigenschaften: Multifunktions-Planfräser mit 42° Einstellwinkel, der die Schnittkraft reduziert und einen schnellen Vorschub in einer Maschine mit beschränkter Leistung erlaubt.

Für Stahl, rostfreien Stahl, legierten Stahl, Guß und Aluminium-Legierungen empfohlen.

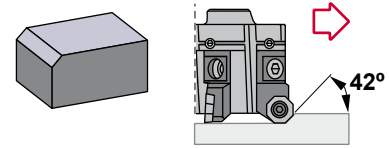

1845.99 42°

Reference Bezeichnung		D	L	d	l3	a	Insert size Wendschneidplatte	
1845.99.160	10	160	63	40	30	3	ODMT 0404..	5,450
1845.99.200	12	200	63	60	40	3	ODMT 0404..	9,000
1845.99.250	16	250	63	60	40	3	ODMT 0404..	14,250
1845.99.315	20	315	63	60	40	3	ODMT 0404..	31,000
1845.99.400	22	400	63	60	40	3	ODMT 0404..	47,500
1845.99.500	28	500	63	60	40	3	ODMT 0404..	85,000

Reference Bezeichnung							DIN 2079	Nm
1845.99.160	1240	5615	6845	1788	1460	40	40	3.0
1845.99.200	1240	5615	6845	1788	1460	50	50	3.0
1845.99.250	1240	5615	6845	1788	1460	50	50	3.0
1845.99.315	1240	5615	6845	1788	1460	50/60	50/60	3.0
1845.99.400	1240	5615	6845	1788	1460	50/60	50/60	3.0
1845.99.500	1240	5615	6845	1788	1460	50/60	50/60	3.0

ODMT

Octogonal positive insert with 15° clearance. Achtkantige positive Wendschneidplatte mit 15° Freiwinkel. F15

Reference / Bez.	l	s	d
ODMT 0404..	4,00	4,76	12,70

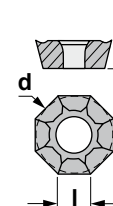

ODMT



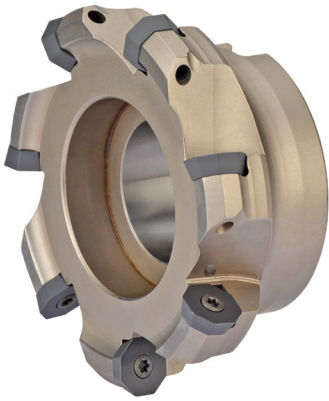

Characteristics:

Multipurpose face milling cutter with 42° entering angle that decreases cutting forces and allows a quick feed in a limited capacity machine.

It works well on steels, stainless steel, alloyed steels, cast iron and aluminium alloys.

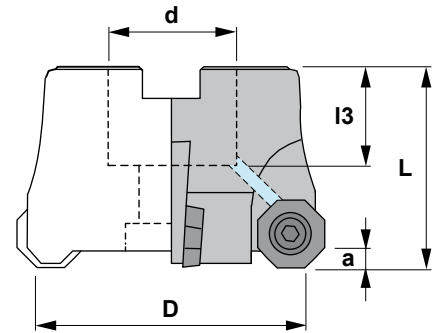

Eigenschaften: Multifunktions-Planfräser mit 42° Einstellwinkel, der die Schnittkraft reduziert und einen schnellen Vorschub in einer Maschine mit beschränkter Leistung erlaubt.

Für Stahl, rostfreien Stahl, legierten Stahl, Guß und Aluminium-Legierungen empfohlen.

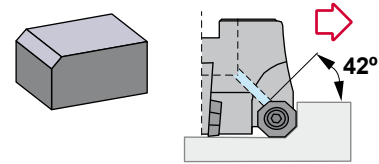

1855.93 42°

Reference Bezeichnung		D	L	d	l3	a	Insert size Wendschneidplatte	
1855.93.063	5	63	50	27	22	4	ODM.. 0605..	0,850
1855.93.080	6	80	50	32	25	4	ODM.. 0605..	1,200
1855.93.100	7	100	50	40	30	4	ODM.. 0605..	1,850
1855.93.125	8	125	63	40	30	4	ODM.. 0605..	3,250
1855.90.160	10	160	63	40	30	4	ODM.. 0605..	4,600
1855.90.200	12	200	63	60	40	4	ODM.. 0605..	9,100

Reference Bezeichnung						Nm
1855.93.063	1550	5520	-	912,12	-	4.0
1855.93.080	1550	5520	-	912,17	-	4.0
1855.93.100	1550	-	5620	-	-	4.0
1855.93.125	1550	-	5620	-	-	4.0
1855.90.160	1550	-	5620	912,52	40	4.0
1855.90.200	1550	-	5620	912,56	50	4.0

ODM..

Octogonal positive inserts with 15° clearance. F15
Achtkantige positive Wendschneidplatten mit 15° Freiwinkel.

Reference / Bez.	l	s	d
ODM.. 0605..	6,00	5,55	16,00

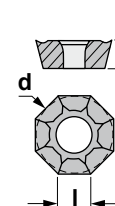

ODMT



ODMW



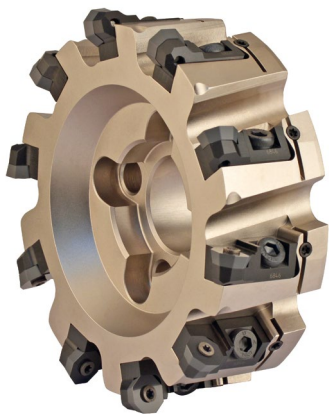

Characteristics:
Multipurpose face milling cutter with 42° entering angle that decreases cutting forces and allows a quick feed in a limited capacity machine. It works well on steels, stainless steel, alloyed steels, cast iron and aluminium alloys.

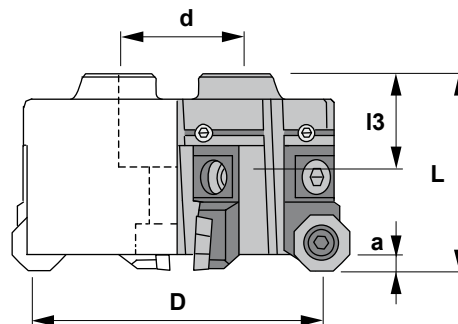

Eigenschaften: Multifunktions-Planfräser mit 42° Einstellwinkel, der die Schnittkraft reduziert und einen schnellen Vorschub in einer Maschine mit beschränkter Leistung erlaubt. Für Stahl, rostfreien Stahl, legierten Stahl, Guß und Aluminium-Legierungen empfohlen.

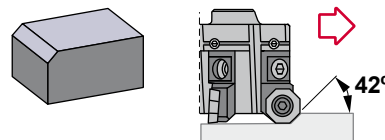

1855.99 42°

Reference Bezeichnung		D	L	d	l3	a	Insert size Wendschneidplatte	
1855.99.160	10	160	63	40	30	4	ODM.. 0605..	5,000
1855.99.200	12	200	63	60	40	4	ODM.. 0605..	7,300
1855.99.250	16	250	63	60	40	4	ODM.. 0605..	12,050
1855.99.315	20	315	63	60	40	4	ODM.. 0605..	31,000
1855.99.400	22	400	63	60	40	4	ODM.. 0605..	47,500
1855.99.500	28	500	63	60	40	4	ODM.. 0605..	85,000

Reference Bezeichnung						DIN 2079	Nm
1855.99.160	1550	5620	6846	1788	1460	40	4.0
1855.99.200	1550	5620	6846	1788	1460	50	4.0
1855.99.250	1550	5620	6846	1788	1460	50	4.0
1855.99.315	1550	5620	6846	1788	1460	50/60	4.0
1855.99.400	1550	5620	6846	1788	1460	50/60	4.0
1855.99.500	1550	5620	6846	1788	1460	50/60	4.0

ODM..

Octogonal positive inserts with 15° clearance. F15
Achtkantige positive Wendschneidplatten mit 15° Freiwinkel.

Reference / Bez.

l

s

d

ODM.. 0605..

6,00

5,55

16,00

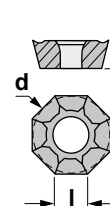

ODMT



ODMW



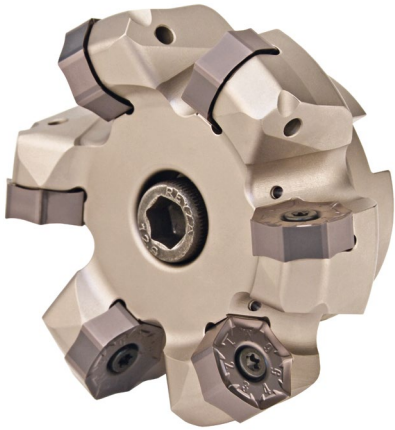

Characteristics:

Positive face chamfering milling cutter with 45° entering angle that decreases cutting forces and allows a quick feed in a limited capacity machine.

It works well on steels, stainless steel, alloyed steels, cast iron and aluminium alloys.

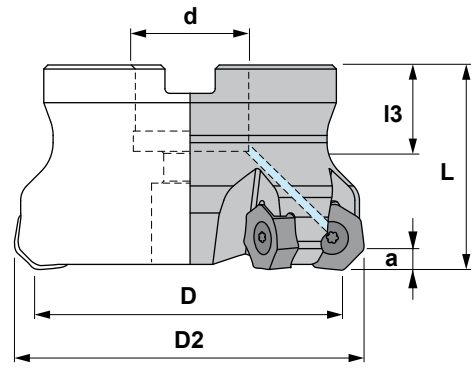

Eigenschaften:

Extra positiver Planfräser mit 45° Einstellwinkel, der die Schnittkraft reduziert und einen schnellen Vorschub in einer Maschine mit beschränkter Leistung erlaubt. Für Stahl, rostfreien Stahl, legierten Stahl, Guß und Aluminium-Legierungen empfohlen.

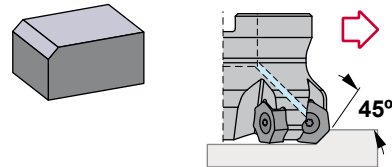

1852.93 45°

Reference Bezeichnung		D	D2	L	d	l3	a	Insert size Wendschneidplatte	
1852.93.063	5	63	74	50	22	22	5.5	NNMU 2007..	0,800
1852.93.080	6	80	91	50	27	25	5.5	NNMU 2007..	1,150
1852.93.100	7	100	111	50	32	26	5.5	NNMU 2007..	1,700
1852.93.125	8	125	136	63	40	30	5.5	NNMU 2007..	2,750
1852.90.160	10	160	171	63	40	30	5.5	NNMU 2007..	4,600

Reference Bezeichnung						Nm
1852.93.063	1250	5520	-	912,10	-	4.0
1852.93.080	1250	5520	-	912,12	-	4.0
1852.93.100	1250	-	5620	912,16	-	4.0
1852.93.125	1250	-	5620	-	-	4.0
1852.90.160	1250	-	5620	912,52	40	4.0

NNM..

Heptagonal positive insert with 15° clearance. F15
Siebeneckige positive Wendschneidplatte mit 15° Freiwinkel.

Reference / Bez.	l	s	d
NNMU 2007..	8,2	7,25	20,00

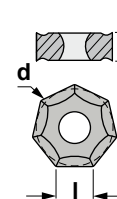

NNM..





Characteristics:

Positive milling cutter with 75° entering angle.

Recommended for manual machines as well as for C.N.C. machines.

It allows to use the edges of APMT and APKT inserts that are not used currently.

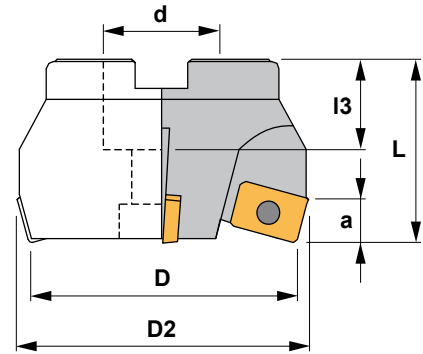

Eigenschaften: Positiver Fräser mit 75° Einstellwinkel. Für allgemeine Anwendungen in manuellen und CNC-Maschinen geeignet. Der Fräser schneidet mit den Schnittkanten der Wendeschneidplatten APMT und APKT, die normalerweise nicht benutzt werden.

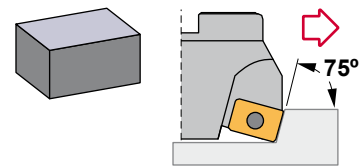

1430.90 75°

Reference Bezeichnung		D	D2	L	d	I3	a	Insert size Wendeschneidplatte	
1430.90.050	3	50	54	40	16	18	7	AP.. 1604..	0,350
1430.90.063	4	63	67	50	27	22	7	AP.. 1604..	0,700
1430.90.080	5	80	84	50	32	25	7	AP.. 1604..	1,100
1430.90.100	6	100	104	50	40	30	7	AP.. 1604..	1,900

Reference Bezeichnung					Nm
1430.90.050	1240	5515	-	1058	3.0
1430.90.063	1240	5515	-	912,12	3.0
1430.90.080	1240	5515	-	912,17	3.0
1430.90.100	1240	-	5615	912,20	3.0

AP.. Parallelogram positive inserts with 11° clearance. F11
Parallelogramme positive Wendeschneidplatten mit 11° Freiwinkel.

Reference / Bez.	l	s	d
AP.. 1604..	17,00	4,76	9,52

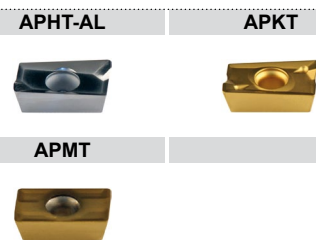



Characteristics:

Super positive milling cutter with 45° entering angle that decreases cutting forces and allows a quick feed in a limited capacity machine. It works well on hard steels, alloyed steels, stainless steels, refractory casts and aluminium alloys.

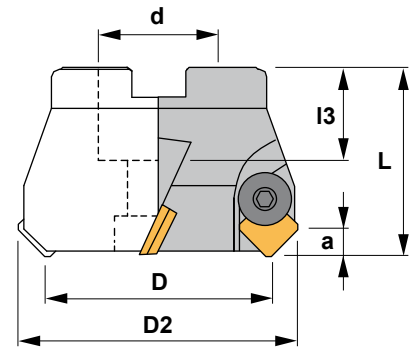

Eigenschaften:

Extra positiver Planfräser mit 45° Einstellwinkel, der die Schnittkraft reduziert und einen schnellen Vorschub in einer Maschine mit beschränkter Leistung erlaubt. Für Stahl, rostfreien Stahl, legierten Stahl, Guß und Aluminium-Legierungen empfohlen.

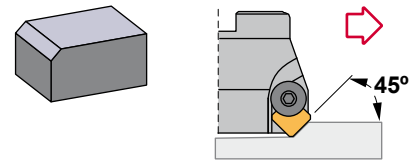

0748.90 45°

Reference Bezeichnung		D	D2	L	d	l3	a	Insert size Wendschneidplatte	
0748.90.050	4	50	63	40	22	20	6	SEK.. 1203..	0,350
0748.90.063	5	63	76	50	22	20	6	SEK.. 1203..	0,850
0748.90.080	6	80	93	50	27	22	6	SEK.. 1203..	1,200
0748.90.100	6	100	113	50	32	25	6	SEK.. 1203..	1,850
0748.90.125	7	125	138	63	40	30	6	SEK.. 1203..	3,250
0748.90.160	8	160	173	63	40	30	6	SEK.. 1203..	4,600
0748.90.200	10	200	213	63	60	40	6	SEK.. 1203..	9,100

Reference Bezeichnung								DIN 2079	Nm
0748.90.050	1006L	2063	3010	4016	5004	912,10	-	-	3.5
0748.90.063	1006L	2063	3010	4012	5004	912,10	-	-	3.5
0748.90.080	1006L	2063	3010	4012	5004	912,12	-	-	3.5
0748.90.100	1006L	2063	3010	4012	5004	912,17	-	-	3.5
0748.90.125	1006L	2063	3010	4012	5004	-	-	-	3.5
0748.90.160	1006L	2063	3010	4012	5004	912,52	40	-	3.5
0748.90.200	1006L	2063	3010	4012	5004	912,56	50	-	3.5

SEK..

Square positive inserts with 20° clearance. F18
Vierkantige positive Wendschneidplatten mit 20° Freiwinkel.

Reference / Bez.	l	s	d
SEK.. 1203..	12,70	3,18	12,70

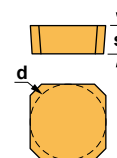

SEKN



SEKR





Characteristics:

Super positive milling cutter with 45° entering angle that decreases cutting forces and allows a quick feed in a limited capacity machine. It works well on hard steels, alloyed steels, stainless steels, refractory casts and aluminium alloys.

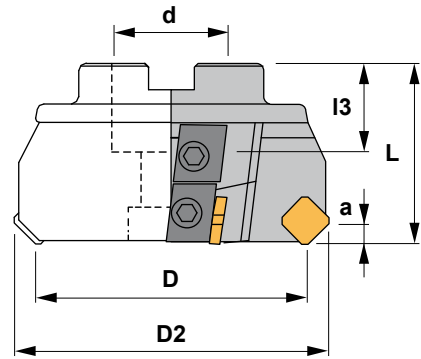

Eigenschaften:

Extra positiver Planfräser mit 45° Einstellwinkel, der die Schnittkraft reduziert und einen schnellen Vorschub in einer Maschine mit beschränkter Leistung erlaubt.

Für Stahl, rostfreien Stahl, legierten Stahl, Guß und Aluminium-Legierungen empfohlen.

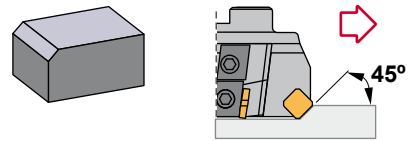

0748.99 45°

Reference Bezeichnung		D	D2	L	d	I3	a	Insert size Wendeschneidplatte	
0748.99.080	6	80	92	50	27	22	6	SEK.. 1203..	1,450
0748.99.100	8	100	112	50	32	25	6	SEK.. 1203..	2,250
0748.99.125	8	125	137	63	40	30	6	SEK.. 1203..	3,750
0748.99.160	10	160	172	63	40	30	6	SEK.. 1203..	5,000
0748.99.200	12	200	212	63	60	40	6	SEK.. 1203..	7,300
0748.99.250	16	250	262	63	60	40	6	SEK.. 1203..	12,050

Reference Bezeichnung										DIN 2079	Nm
0748.99.080	1077	5520	-	6488	6489	6918	1460	912,12	-	-	4.0
0748.99.100	1077	-	5620	6488	6489	6918	1460	912,17	-	-	4.0
0748.99.125	1077	-	5620	6488	6489	6918	1460	-	-	-	4.0
0748.99.160	1077	-	5620	6488	6489	6918	1460	912,52	40	40	4.0
0748.99.200	1077	-	5620	6488	6489	6918	1460	912,56	50	50	4.0
0748.99.250	1077	-	5620	6488	6489	6918	1460	912,56	50	50	4.0

SEK..

Square positive inserts with 20° clearance. F18
Vierkantige positive Wendeschneidplatten mit 20° Freiwinkel.

Reference / Bez.	l	s	d
SEK.. 1203..	12,70	3,18	12,70

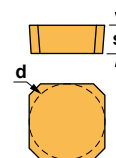

SEKN



SEKR



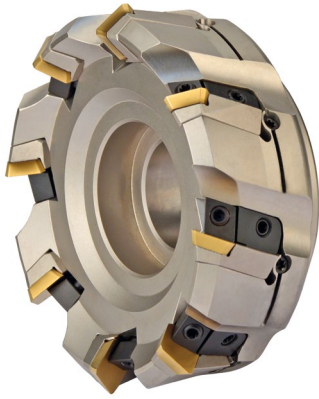

Characteristics:

Super positive milling cutter with 45° entering angle that decreases cutting forces and allows a quick feed in a limited capacity machine. It works well on hard steels, alloyed steels, stainless steels, refractory casts and aluminium alloys.

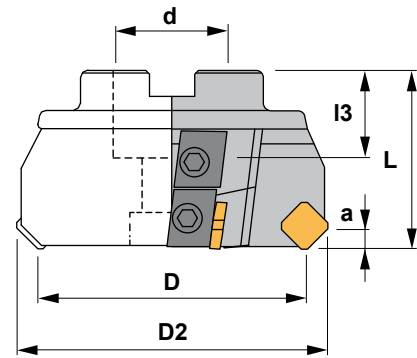

Eigenschaften:

Extra positiver Planfräser mit 45° Einstellwinkel, der die Schnittkraft reduziert und einen schnellen Vorschub in einer Maschine mit beschränkter Leistung erlaubt.

Für Stahl, rostfreien Stahl, legierten Stahl, Guß und Aluminium-Legierungen empfohlen.

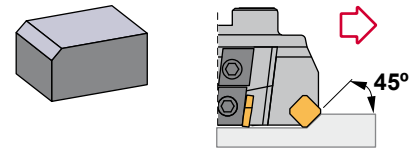

0758.99 45°

Reference Bezeichnung		D	D2	L	d	l3	a	Insert size Wendeschneidplatte	
0758.99.080	6	80	98	50	27	22	9	SEK.. 1504..	1,350
0758.99.100	8	100	118	50	32	25	9	SEK.. 1504..	2,200
0758.99.125	8	125	143	63	40	30	9	SEK.. 1504..	3,550
0758.99.160	10	160	178	63	40	30	9	SEK.. 1504..	5,450
0758.99.200	12	200	218	63	60	40	9	SEK.. 1504..	9,050
0758.99.250	16	250	268	63	60	40	9	SEK.. 1504..	13,250

Reference Bezeichnung										DIN 2079	Nm
0758.99.080	1077	5520	-	6490	6491	6920	1460	912,12		-	4.0
0758.99.100	1077	-	5620	6490	6491	6920	1460	912,17		-	4.0
0758.99.125	1077	-	5620	6490	6491	6920	1460	-		-	4.0
0758.99.160	1077	-	5620	6490	6491	6920	1460	912,52		40	4.0
0758.99.200	1077	-	5620	6490	6491	6920	1460	912,56		50	4.0
0758.99.250	1077	-	5620	6490	6491	6920	1460	912,56		50	4.0

SEK..

Square positive inserts with 20° clearance. F18
Vierkantige positive Wendeschneidplatten mit 20° Freiwinkel.

Reference / Bez.	l	s	d
SEK.. 1504..	15,88	4,76	15,88

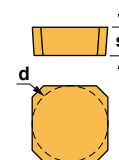

SEKN



SEKR



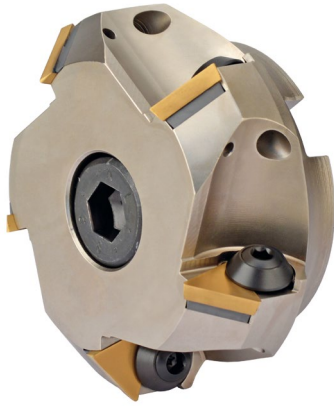

Characteristics:

General purpose positive milling cutter with 45° entering angle. Recommended for manual machines as well as for C.N.C. machines.

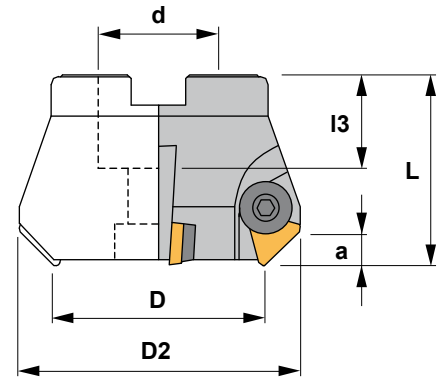

Eigenschaften:

Positiver Fräser mit 45° Einstellwinkel. Für allgemeine Anwendungen in manuellen und CNC-Maschinen geeignet.

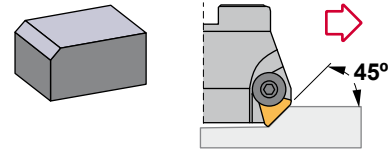

0640.90 45°

Reference Bezeichnung		D	D2	L	d	l3	a	Insert size Wendeschneidplatte	
0640.90.032	3	32	62	50	22	20	11	TPUN 2204..	0,450
0640.90.040	3	40	70	50	27	22	11	TPUN 2204..	0,700
0640.90.050	4	50	80	50	27	22	11	TPUN 2204..	0,800
0640.90.063	4	63	93	50	32	25	11	TPUN 2204..	1,300
0640.90.080	5	80	110	50	40	30	11	TPUN 2204..	1,800

Reference Bezeichnung							Nm
0640.90.032	1008	5005	2088	3022	4022	912,10	4.0
0640.90.040	1008	5005	2088	3022	4022	912,12	4.0
0640.90.050	1008	5005	2088	3022	4022	912,12	4.0
0640.90.063	1008	5005	2088	3022	4022	912,16	4.0
0640.90.080	1008	5005	2088	3022	4022	912,20	4.0

TPUN

Triangular positive insert with 11° clearance. F22
Dreikantige positive Wendeschneidplatte mit 11° Freiwinkel.

Reference / Bez.	l	s	d
TPUN 2204..	22,00	4,76	12,70

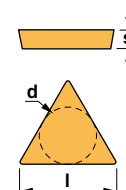



Characteristics:

General purpose positive milling cutter with 75° entering angle. Its strong inserts accept high cutting depths and high feed per teeth.

Recommended for manual machines as well as for C.N.C. machines.

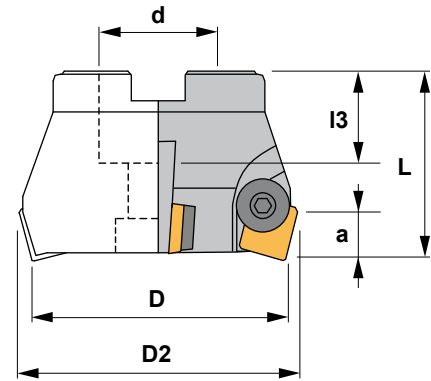

Eigenschaften:

Positiver Planfräser mit 75° Einstellwinkel für allgemeine Anwendungen. Seine starken Wendeschneidplatten akzeptieren einen hohen Vorschub pro Zahn.

Für manuelle und CNC-Maschinen geeignet.

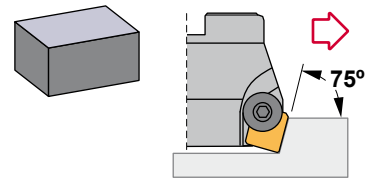

0440.90 75°

Reference Bezeichnung		D	D2	L	d	l3	a	Insert size Wendeschneidplatte	
0440.90.040	3	40	46	40	16	18	9	SP.. 1203..	0,250
0440.90.050	3	50	56	40	22	20	9	SP.. 1203..	0,300
0440.90.063	4	63	69	50	27	22	9	SP.. 1203..	0,700
0440.90.080	5	80	86	50	32	25	9	SP.. 1203..	1,100
0440.90.100	6	100	106	50	40	30	9	SP.. 1203..	1,800
0440.90.125	6	125	131	63	40	30	9	SP.. 1203..	3,500
0440.90.160	7	160	166	63	40	30	9	SP.. 1203..	5,600
0440.90.200	8	200	206	63	60	40	9	SP.. 1203..	9,150

Reference Bezeichnung							Nm
0440.90.040	1006	5004	2066	-	-	1058	3.5
0440.90.050	1006	5004	2066	3012	4012	912,10	3.5
0440.90.063	1006	5004	2066	3012	4012	912,12	3.5
0440.90.080	1006	5004	2066	3012	4012	912,17	3.5
0440.90.100	1006	5004	2066	3012	4012	912,20	3.5
0440.90.125	1006	5004	2066	3012	4012	-	3.5
0440.90.160	1006	5004	2066	3012	4012	912,52	3.5
0440.90.200	1006	5004	2066	3012	4012	912,56	3.5

SP.. Square positive inserts with 11° clearance. F19-20
Vierkantige positive Wendeschneidplatten mit 11° Freiwinkel.

Reference / Bez.	l	s	d
SP.. 1203..	12,70	3,18	12,70

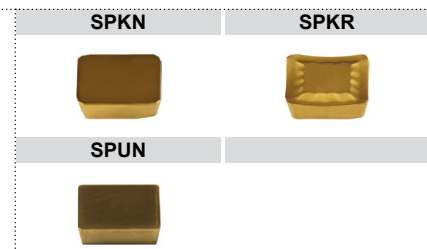
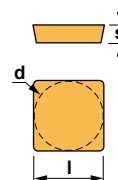



Characteristics:

General purpose positive milling cutter with 75° entering angle.

Recommended for manual machines as well as for C.N.C. machines. It is a good choice for economical machining since the SPUN type insert can be fitted.

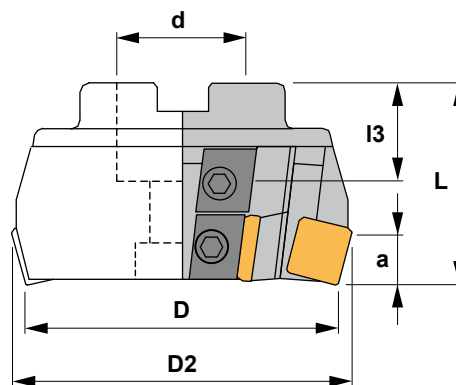

Eigenschaften:

Positiver Planfräser mit 75° Einstellwinkel für allgemeine Anwendungen.

Für manuelle und CNC-Maschinen geeignet. Es ist eine gute Wahl für eine wirtschaftliche Bearbeitung, da man die SPUN-Wendeschneidplatten verwenden kann.

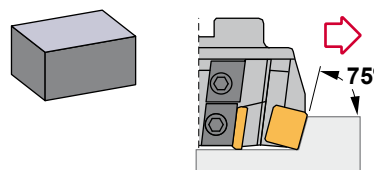

0440.99 75°

Reference Bezeichnung		D	D2	L	d	l3	a	Insert size Wendeschneidplatte	
0440.99.080	5	80	86	50	27	22	9	SP.. 1203..	1,250
0440.99.100	7	100	106	50	32	25	9	SP.. 1203..	2,000
0440.99.125	8	125	131	63	40	30	9	SP.. 1203..	3,500
0440.99.160	10	160	166	63	40	30	9	SP.. 1203..	5,750
0440.99.200	12	200	206	63	60	40	9	SP.. 1203..	9,000
0440.99.250	16	250	256	63	60	40	9	SP.. 1203..	14,200
0440.99.315	20	315	321	63	60	40	9	SP.. 1203..	31,000
0440.99.400	26	400	406	63	60	40	9	SP.. 1203..	47,500
0440.99.500	34	500	506	63	60	40	9	SP.. 1203..	85,000

Reference Bezeichnung										DIN 2079	Nm
0440.99.080	1077	5520	-	6437	6438	6914	1460	912,12	-	-	4.0
0440.99.100	1077	-	5620	6437	6438	6914	1460	912,20	-	-	4.0
0440.99.125	1077	-	5620	6437	6438	6914	1460	-	-	-	4.0
0440.99.160	1077	-	5620	6437	6438	6914	1460	912,52	40	40	4.0
0440.99.200	1077	-	5620	6437	6438	6914	1460	912,56	50	50	4.0
0440.99.250	1077	-	5620	6437	6438	6914	1460	912,56	50	50	4.0
0440.99.315	1077	-	5620	6437	6438	6914	1460	912,56	50/60	50/60	4.0
0440.99.400	1077	-	5620	6437	6438	6914	1460	912,56	50/60	50/60	4.0
0440.99.500	1077	-	5620	6437	6438	6914	1460	912,56	50/60	50/60	4.0

SP.. Square positive inserts with 11° clearance. F19-20
Vierkantige positive Wendeschneidplatten mit 11° Freiwinkel.

Reference / Bez.	l	s	d
SP.. 1203..	12,70	3,18	12,70

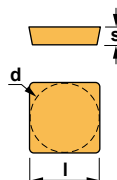

SPKN **SPKR**



SPUN



Chamfer-Plus

The new Chamfer-Plus line is designed to provide high metal removal rates while reducing production costs. The new chamfering cutters use the same inserts and hardware as the Mill-Plus square shoulder mills, allowing to increase the versatility of both cutters without additional spare parts.

Die neue Chamfer-Plus Serie wurde entwickelt, um hohe Spanabfuhr-Raten zu bieten und gleichzeitig die Produktionskosten zu reduzieren. Die neuen Anfasfräser verwenden dieselben Wendeschneidplatten und Ersatzteilen als die Mill-Plus Eckfräser, wodurch die Vielseitigkeit der beiden Fräser ohne zusätzliche Ersatzteile erhöht wird.

1745.93 15-75°

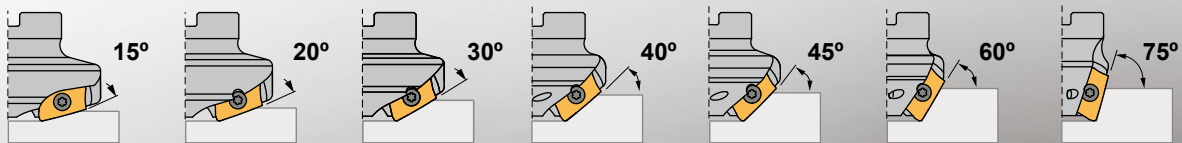

Features

- Suitable for pre-welding operations
- High helix sharp cutting
- Exerts low force
- Two helical long cutting edges
- Screw clamping

Eigenschaften

- Geeignet für Vorschweiß-Operationen
- Sehr scharfer spiralförmiger Schnitt
- Übt geringe Schnittkraft aus
- Zwei spiralförmige lange Schnittkanten
- Schraubenklammerung

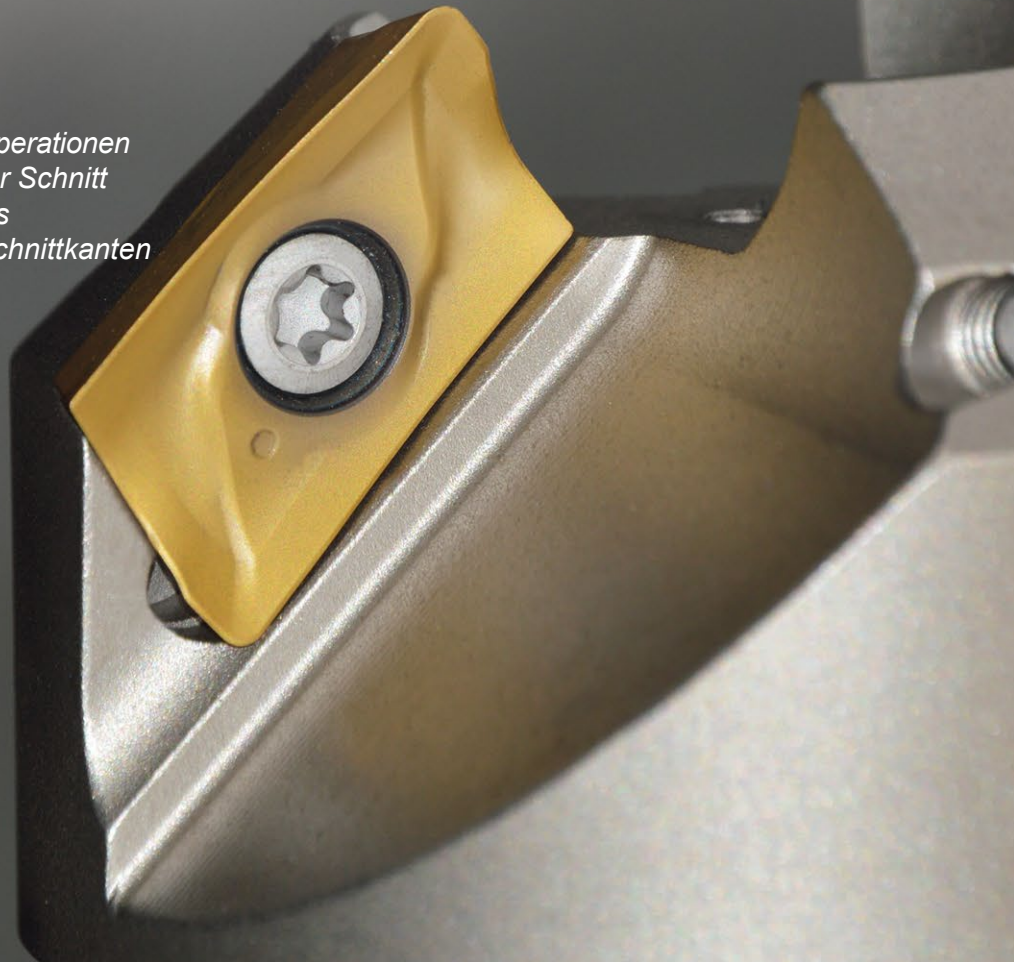

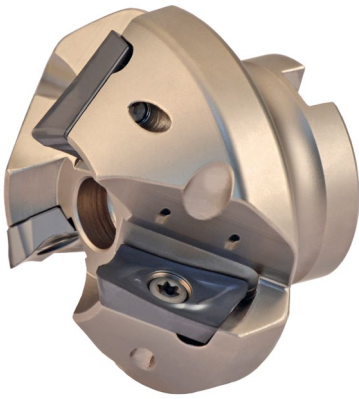

Characteristics:

Super positive face chamfering milling cutter with 15 to 75° entering angle that decreases cutting forces and allows a quick feed in a limited capacity machine. It works well on steels, stainless steel, alloyed steels, cast iron and aluminium alloys.

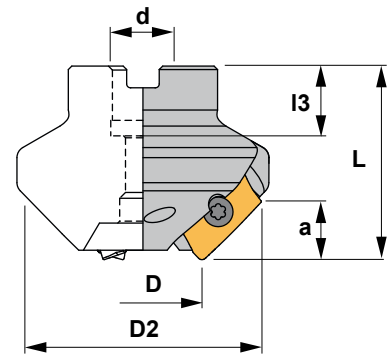

Eigenschaften:

Extra positiver Plan- und Anfasfräser mit einem Einstellwinkel von 15° bis 75°, der die Schnittkraft reduziert und einen schnellen Vorschub in einer Maschine mit beschränkter Leistung erlaubt.

Für Stahl, rostfreien Stahl, legierten Stahl, Guß und Aluminium-Legierungen empfohlen.

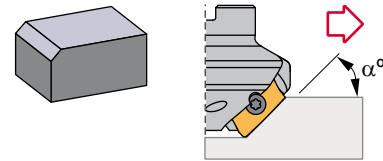

1745.93 15-75°

Reference Bezeichnung		D	D2	L	d	l3	a	Insert size Wenceschnidplatte	
1745.93.032/15	3	32	71,7	50	22	20	5	ADKT 2206..	1,074
1745.93.032/20	3	32	70,6	50	22	20	7	ADKT 2206..	0,941
1745.93.032/30	3	32	67,6	50	22	20	10	ADKT 2206..	0,803
1745.93.032/40	3	32	63,5	50	22	20	13	ADKT 2206..	0,659
1745.93.032/45	3	32	61,1	50	16	18	14	ADKT 2206..	0,538
1745.93.032/60	3	32	52,4	50	16	18	18	ADKT 2206..	0,378
1745.93.032/75	3	32	42,8	50	16	18	20	ADKT 2206..	0,258

Reference Bezeichnung				Nm
1745.93.032/15	1550	5520	912,10	4.0
1745.93.032/20	1550	5520	912,10	4.0
1745.93.032/30	1550	5520	912,10	4.0
1745.93.032/40	1550	5520	912,10	4.0
1745.93.032/45	1550	5520	1058	4.0
1745.93.032/60	1550	5520	1058	4.0
1745.93.032/75	1550	5520	1128	4.0

ADKT

Parallelogram positive insert with 15° clearance. F10
Parallelogramme positive Wenceschnidplatte mit 15° Freiwinkel.

Reference / Bez.	l	s	d
ADKT 2206..	20,00	6,74	12,70

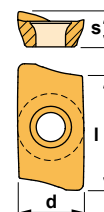

ADKT



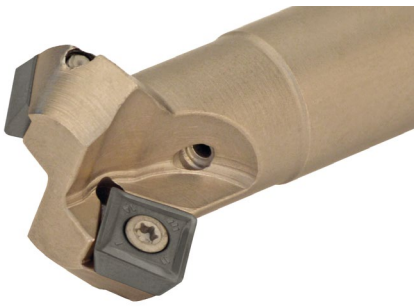

Characteristics:

Chamfering milling cutter for diversified manufacture.

Recommended for small conventional milling machines and machining centers.

Eigenschaften:

Anfasfräser für allgemeine Anwendungen.

Für kleine konventionelle Fräsmaschinen und Bearbeitungszentren geeignet.

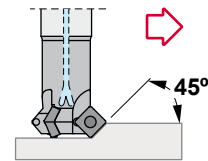
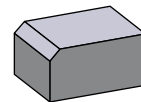
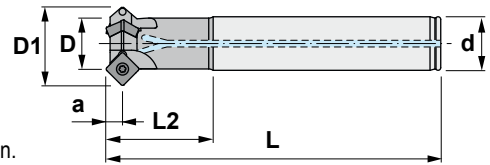

0735.03 45°

Reference Bezeichnung		D	D1	L	d	L2	a	Insert size Wendeschneidplatte	
0735.03.008	1	8	19,3	100	16	30	6	SDMT 09T3..	0,120
0735.03.016	2	16	27,5	100	20	30	6	SDMT 09T3..	0,140
0735.03.020	3	20	31,5	125	25	40	6	SDMT 09T3..	0,270

Reference Bezeichnung			Nm
0735.03.008	1430	5508	1.2
0735.03.016	1230	5508	1.2
0735.03.020	1230	5508	1.2

SDMT

Square positive insert with 15° clearance. F17
Vierkantige positive Wendeschneidplatte mit 15° Freiwinkel.

Reference / Bez.	l	s	d
SDMT 09T3..	9,52	3,97	9,52

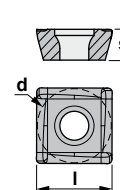

SDMT





Characteristics:
Chamfering milling cutter for diversified manufacture.
Recommended for small conventional milling machines and machining centers.

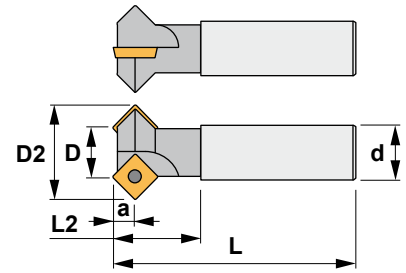

Eigenschaften:
Anfasfräser für allgemeine Anwendungen.
Für kleine konventionelle Fräsmaschinen und Bearbeitungszentren geeignet.

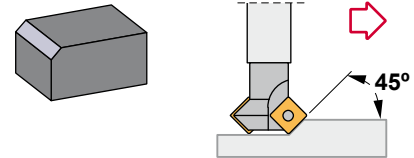

0740.00

Reference Bezeichnung		D	D2	L	L2	d	a	Insert size Wendschneidplatte	
0740.00.005	1	6,5	22	110	35	20	7	SPM.. 1204..	0,250
0740.00.020	2	20,0	37	125	35	25	7	SPM.. 1204..	0,450

Reference Bezeichnung			Nm
0740.00.005		1550	5520
0740.00.020		1550	5520

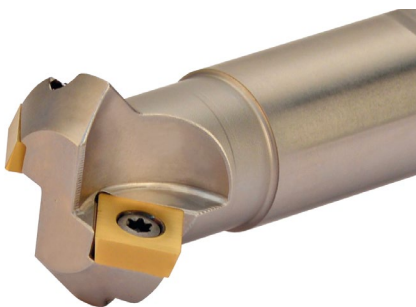

Characteristics:
Chamfering milling cutter for diversified manufacture.
Recommended for small conventional milling machines and machining centers.

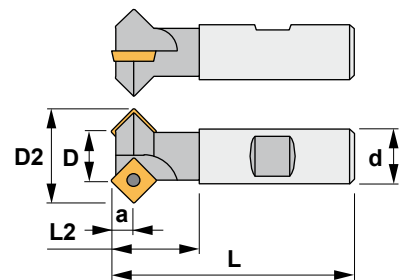

Eigenschaften:
Anfasfräser für allgemeine Anwendungen.
Für kleine konventionelle Fräsmaschinen und Bearbeitungszentren geeignet.

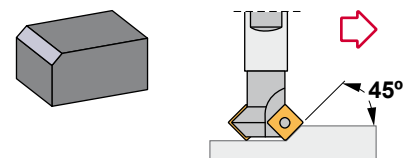

0740.07

Reference Bezeichnung		D	D2	L	L2	d	a	Insert size Wendschneidplatte	
0740.07.005	1	6,5	22	110	35	25	7	SPM.. 1204..	0,350
0740.07.020	2	20,0	37	110	35	25	7	SPM.. 1204..	0,400

Reference Bezeichnung			Nm
0740.07.005		1550	5520
0740.07.020		1550	5520

SPM..

Square positive inserts with 11° clearance. F19-20
Vierkantige positive Wendschneidplatten mit 11° Freiwinkel.

Reference / Bez.	l	s	d
SPM.. 1204..	12,70	4,76	12,70

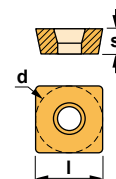

SPMT



SPMW



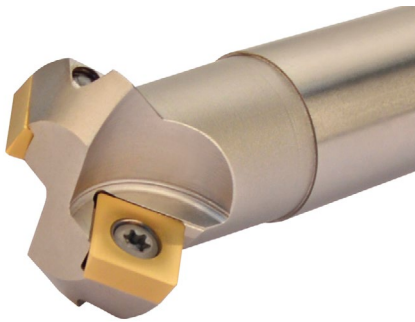

Characteristics:
Chamfering milling cutter for diversified manufacture.
Recommended for small conventional milling machines and machining centers.

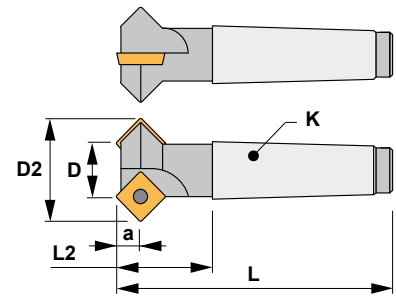

Eigenschaften:
Anfasfräser für allgemeine Anwendungen.
Für kleine konventionelle Fräsmaschinen und Bearbeitungszentren geeignet.

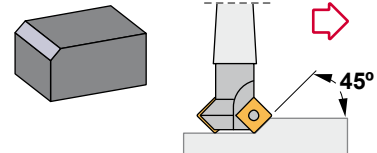

0740.30

Reference Bezeichnung		D	D2	L	L2	a	K	Insert size Wendeschneidplatte	
0740.30.005	1	6,5	22	125	39	7	MK3	SPM.. 1204..	0,300
0740.30.020	2	20,0	37	125	39	7	MK3	SPM.. 1204..	0,300

Reference Bezeichnung			Nm
0740.30.005	1550	5520	4.0
0740.30.020	1550	5520	4.0

SPM..

Square positive inserts with 11° clearance. F19-20
Vierkantige positive Wendeschneidplatten mit 11° Freiwinkel.

Reference / Bez.	l	s	d
SPM.. 1204..	12,70	4,76	12,70

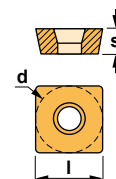

SPMT



SPMW



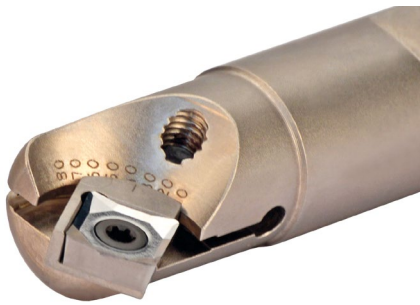

Characteristics:

Adjustable chamfering milling cutter for specific operations.
Recommended for small conventional milling machines and machining centers.

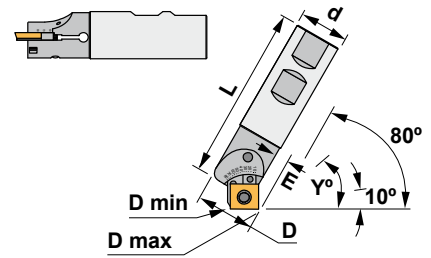

Eigenschaften:

Verstellbarer Winkelfräser zum Anfasen für spezifische Anwendungen.
Für kleine konventionelle Fräsmaschinen und Bearbeitungszentren geeignet.

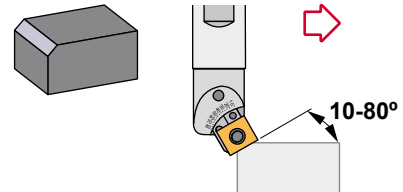

1744.0⁰27

Reference Bezeichnung		D	d	L	Y	Dmin	Dmax	Insert size Wendeschneidplatte	
1744.07.025	1	29	25	101	10°	7,5	30,0	SC.. 1204..	0,250
1744.27.025	1	29	25	176	20°	10,0	32,0	SC.. 1204..	0,500
					30°	13,0	32,5		
					40°	16,5	33,5		
					45°	17,5	33,5		
					50°	19,0	33,5		
					60°	22,0	33,5		
					70°	24,5	32,5		
					80°	27,0	31,0		

Reference Bezeichnung						Nm
1744.07.025	6944	1244	1296	5520		4.0
1744.27.025	6944	1244	1296	5520		4.0

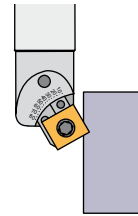
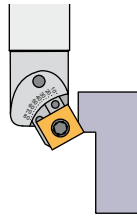
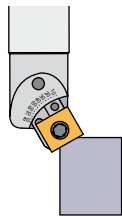

SC.. Square positive inserts with 7° clearance. F17
Vierkantige positive Wendeschneidplatten mit 7° Freiwinkel.

Reference / Bez.	l	s	d
SC.. 1204..	12,70	4,76	12,70

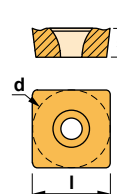

SCGT-AL



SCMT-39



SCMW





Characteristics:

Countersink milling cutter for specific operations.
Recommended for small conventional milling machines and machining centers.

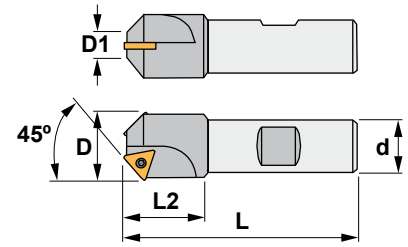

Eigenschaften:

Senker für spezifische Anwendungen.
Für kleine konventionelle Fräsmaschinen und Bearbeitungszentren geeignet.

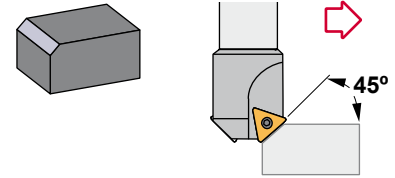

0624.07

Reference Bezeichnung		D1	D	L	L2	d	Insert size Wendeschneidplatte	
0624.07.016	1	1,2	16	70	24	12	TC.. 1102..	0,100
0624.07.021	2	8,5	21	90	30	20	TC.. 1102..	0,150

Reference Bezeichnung			Nm
0624.07.016	1425	5507	0.9
0624.07.021	1425	5507	0.9



Characteristics:

Countersink milling cutter for specific operations.
Recommended for small conventional milling machines and machining centers.

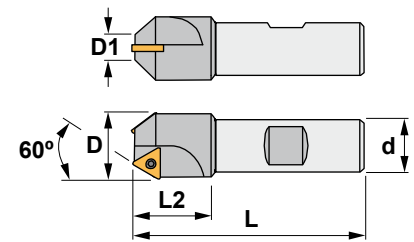

Eigenschaften:

Senker für spezifische Anwendungen.
Für kleine konventionelle Fräsmaschinen und Bearbeitungszentren geeignet.

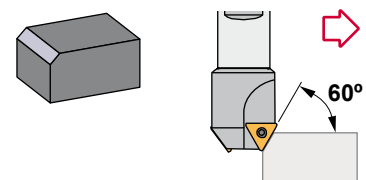

0724.07

Reference Bezeichnung		D1	D	L	L2	d	Insert size Wendeschneidplatte	
0724.07.016	1	5,4	16	70	24	12	TC.. 1102..	0,100
0724.07.026	2	15,8	26	90	30	20	TC.. 1102..	0,170

Reference Bezeichnung			Nm
0724.07.016	1425	5507	0.9
0724.07.026	1425	5507	0.9

TC..

Triangular positive inserts with 7° clearance. F21
Dreikantige positive Wendeschneidplatten mit 7° Freiwinkel.

Reference / Bez.	l	s	d
TC.. 1102..	11,00	2,38	6,35

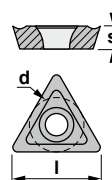

TCGT-AL



TCMT-39



TCMW

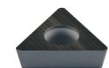



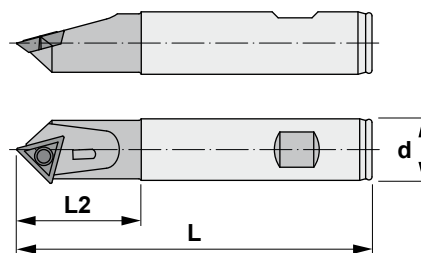

Characteristics:
Indexable spotting drill holders for spotting, engraving, grooving and chamfering on milling machines and machining centers. Also for spotting and facing on CNC lathes.



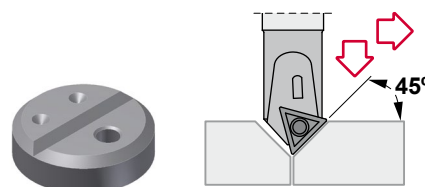



Eigenschaften:
Fräser für Wendeschneidplatten zum Anbohren, Gravieren, Nutenstechen und Anfasen auf Fräsmaschinen und Bearbeitungszentren. Auch zum Anbohren und Plansenken auf CNC-Drehmaschinen.



0634.37

Reference Bezeichnung		L	L2	d	Insert size Wendeschneidplatte	
0634.37.000	1	115,5	40,5	20	TCMX 16T3..	0,410

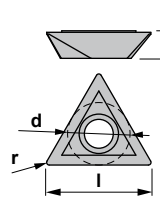
Reference Bezeichnung			Nm
0634.37.000	1440	5515	3.0

TCMX					Triangular positive insert with 7° clearance.  F21		Dreikantige positive Wendeschneidplatte mit 7° Freiwinkel.		TCMX	
Reference / Bez.	l	s	d	r						
TCMX 16T300	9,52	3,18	6,35	0,4						

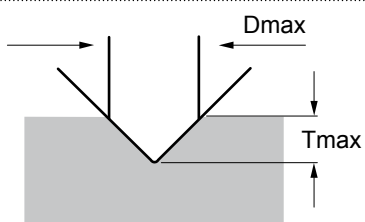

Dmax	Tmax
10	4



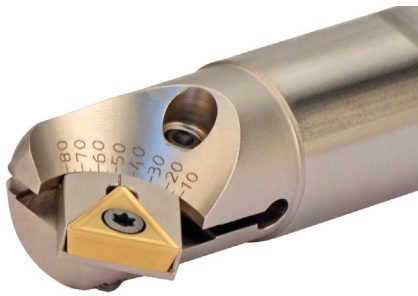

Characteristics:
Adjustable chamfering milling cutter for specific operations.
Recommended for small conventional milling machines and machining centers.

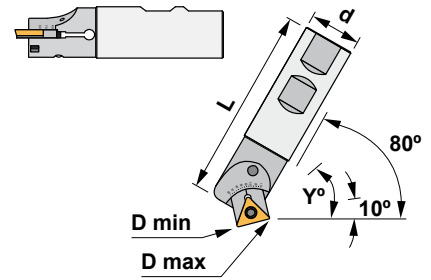

Eigenschaften:
Verstellbarer Winkelfräser zum Anfasen für spezifische Anwendungen.
Für kleine konventionelle Fräsmaschinen und Bearbeitungszentren geeignet.

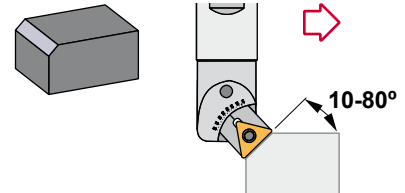

16²₃4.0⁰₂₇

Reference Bezeichnung		d	L	Y	Dmin	Dmax	Insert size Wendeschneidplatte	
1624.07.020	1	20	100	10° - 80°	5	20	TC.. 1102..	0,250
1634.07.025	1	25	100	10° - 80°	5	23	TC.. 16T3..	0,250
1634.27.025	1	25	175	10° - 80°	5	23	TC.. 16T3..	0,500

Reference Bezeichnung					Nm
1624.07.020	6921	1225	1905	5507	0.9
1634.07.025	6926	1240	1296	5515	3.0
1634.27.025	6926	1240	1296	5515	3.0

TC.. Triangular positive inserts with 7° clearance. F21
Dreikantige positive Wendeschneidplatten mit 7° Freiwinkel.

Reference / Bez.	l	s	d
TC.. 1102..	11,00	2,38	6,35
TC.. 16T3..	16,50	3,97	9,52

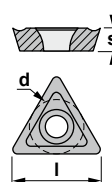

TCGT-AL



TCMT-39



TCMW

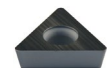



Characteristics:

General purpose positive milling cutter with 45° entering angle. Recommended for manual machines as well as for C.N.C. machines.

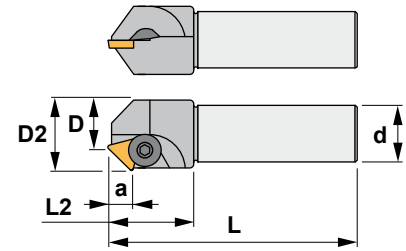

Eigenschaften:

Positiver Planfräser mit 45° Einstellwinkel für allgemeine Anwendungen. Für manuelle und CNC-Maschinen geeignet.

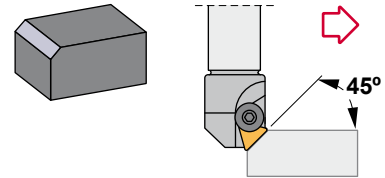

0630.00

Reference Bezeichnung		D	D2	L	L2	d	a	Insert size Wendschneidplatte	
0630.00.005	1	6,5	26,5	110	35	20	8	TPUN 1603..	0,300
0630.00.020	3	20,0	40,0	125	35	25	8	TPUN 1603..	0,500

Reference Bezeichnung				Nm
0630.00.005	1006	2064	5004	3.5
0630.00.020	1006	2064	5004	3.5



Characteristics:

General purpose positive milling cutter with 45° entering angle. Recommended for manual machines as well as for C.N.C. machines.

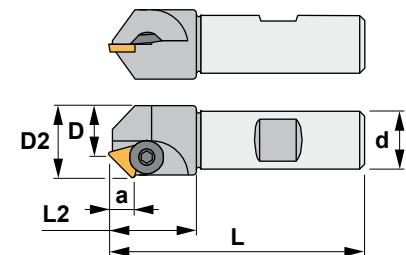

Eigenschaften:

Positiver Planfräser mit 45° Einstellwinkel für allgemeine Anwendungen. Für manuelle und CNC-Maschinen geeignet.

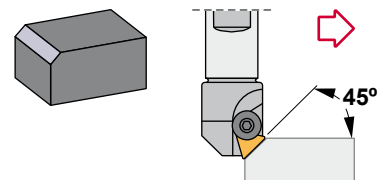

0630.07

Reference Bezeichnung		D	D2	L	L2	d	a	Insert size Wendschneidplatte	
0630.07.005	1	6,5	26,5	110	35	25	8	TPUN 1603..	0,400
0630.07.020	3	20,0	40,0	110	35	25	8	TPUN 1603..	0,450

Reference Bezeichnung				Nm
0630.07.005	1006	2064	5004	3.5
0630.07.020	1006	2064	5004	3.5

TPUN

Triangular positive insert with 11° clearance. F22
Dreikantige positive Wendschneidplatte mit 11° Freiwinkel.

Reference / Bez.	l	s	d
TPUN 1603..	16,50	3,18	9,52

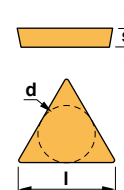



Characteristics:
General purpose positive milling cutter with 45° entering angle.
Recommended for manual machines as well as for C.N.C. machines.

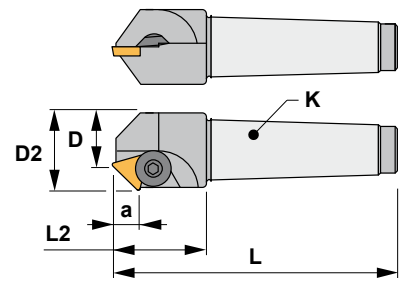

Eigenschaften:
Positiver Planfräser mit 45° Einstellwinkel für allgemeine Anwendungen.
Für manuelle und CNC-Maschinen geeignet.

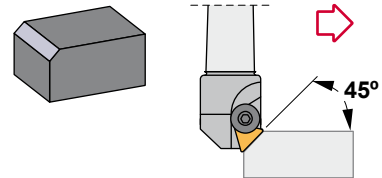

0630.30

Reference Bezeichnung		D	D2	L	L2	a	K	Insert size Wendeschneidplatte	
0630.30.005	1	6,5	26,5	125	38	8	MK3	TPUN 1603..	0,350
0630.30.020	3	20,0	40,0	125	38	8	MK3	TPUN 1603..	0,400



Reference Bezeichnung				Nm
0630.30.005	1006	2064	5004	3.5
0630.30.020	1006	2064	5004	3.5

TPUN

Triangular positive insert with 11° clearance. F22
Dreikantige positive Wendeschneidplatte mit 11° Freiwinkel.

Reference / Bez.	l	s	d
TPUN 1603..	16,50	3,18	9,52

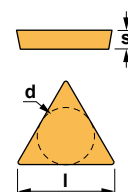

TPUN





Characteristics:
Milling cutter with concave radius.
It works well on steels, alloyed steels,
stainless steels and refractories.

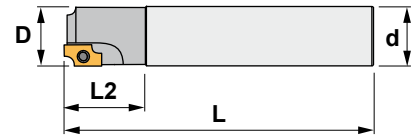

Eigenschaften:
Viertelkreisfräser mit konkavem Radius.
Dieser Eckfräser wird für Stahl, legierten
Stahl, rostfreien Stahl und hitzebeständige
Gußteile empfohlen.

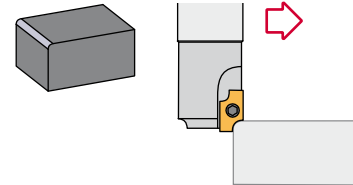

1235.01

Reference Bezeichnung		d	D	L	L2	r _{min}	r _{max}	Insert size Wendeschneidplatte	
1235.01.01701	1	16	17	120	30	1,0	2,5	ADMT 1503R1.0 / 2.5	0,200
1235.01.01703	1	16	17	120	30	3,0	5,0	ADMT 1503R3.0 / 5.0	0,200

Reference Bezeichnung			Nm
1235.01.01701	1440	5515	3.0
1235.01.01703	1440	5515	3.0

ADMT-R

Parallelogram positive inserts with 15° clearance. F10
Parallelogramme positive WSP mit 15° Freiwinkel.

Reference / Bezeichnung	r	s	d
ADMT 1503R1.0	1.0	3,18	9,52
ADMT 1503R1.5	1.5	3,18	9,52
ADMT 1503R2.0	2.0	3,18	9,52
ADMT 1503R2.5	2.5	3,18	9,52
ADMT 1503R3.0	3.0	3,18	9,52
ADMT 1503R3.5	3.5	3,18	9,52
ADMT 1503R4.0	4.0	3,18	9,52
ADMT 1503R4.5	4.5	3,18	9,52
ADMT 1503R5.0	5.0	3,18	9,52

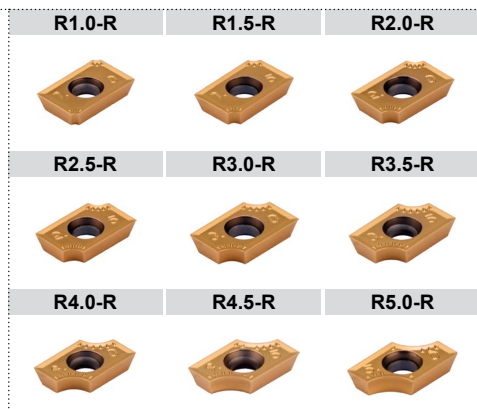
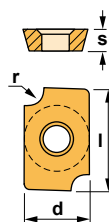



Characteristics:
Milling cutter with concave radius.
It works well on steels, alloyed steels,
stainless steels and refractories.



Eigenschaften:
Viertelkreisfräser mit konkavem Radius.
Dieser Eckfräser wird für Stahl, legierten
Stahl, rostfreien Stahl und hitzebeständige
Gußteile empfohlen.

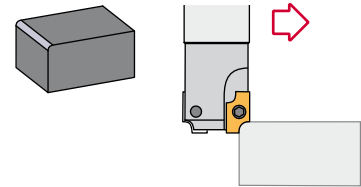

1235.07

Reference Bezeichnung		d	D	L	L2	r _{min}	r _{max}	Insert size Wendeschneidplatte	
1235.07.02201	2	20	22	120	35	1,0	2,5	ADMT 1503R1.0 / 2.5	0,320
1235.07.02203	2	20	22	120	35	3,0	5,0	ADMT 1503R3.0 / 5.0	0,530

Reference Bezeichnung			Nm
1235.07.02201	1440	5515	3.0
1235.07.02203	1440	5515	3.0

ADMT-R

Parallelogram positive inserts with 15° clearance. F10
Parallelogramme positive WSP mit 15° Freiwinkel.

Reference / Bezeichnung	r	s	d
ADMT 1503R1.0	1.0	3,18	9,52
ADMT 1503R1.5	1.5	3,18	9,52
ADMT 1503R2.0	2.0	3,18	9,52
ADMT 1503R2.5	2.5	3,18	9,52
ADMT 1503R3.0	3.0	3,18	9,52
ADMT 1503R3.5	3.5	3,18	9,52
ADMT 1503R4.0	4.0	3,18	9,52
ADMT 1503R4.5	4.5	3,18	9,52
ADMT 1503R5.0	5.0	3,18	9,52

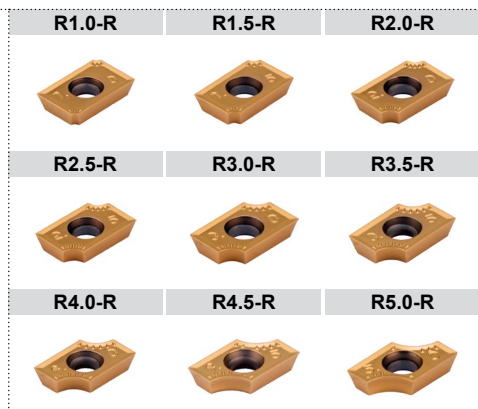
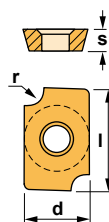



Characteristics:
Adjustable milling cutter with concave radius.
It works well on steels, alloyed steels, stainless steels and refractories.

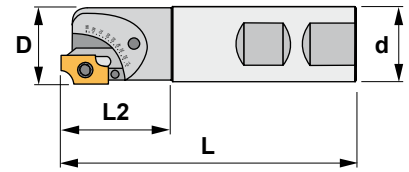

Eigenschaften:
Verstellbarer Viertelkreisfräser mit konkavem Radius.
Dieser Eckfräser wird für Stahl, legierten Stahl, rostfreien Stahl und hitzebeständige Gußteile empfohlen.

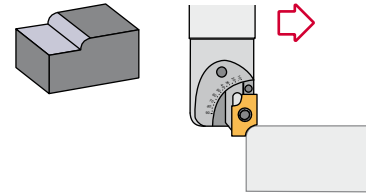

1725.0⁰/₂₇

Reference Bezeichnung		D	d	L	L2	Dmin	Dmax	Insert size Wendschneidplatte	
1725.07.025	1	25,5	25	104	37	26,5	33	ADMT-R 1503	0,250
1725.27.025	1	25,5	25	178	37	26,5	33	ADMT-R 1503	0,500

Reference Bezeichnung					Nm
1725.07.025	6925	1240	1296	5515	3.0
1725.27.025	6925	1240	1296	5515	3.0

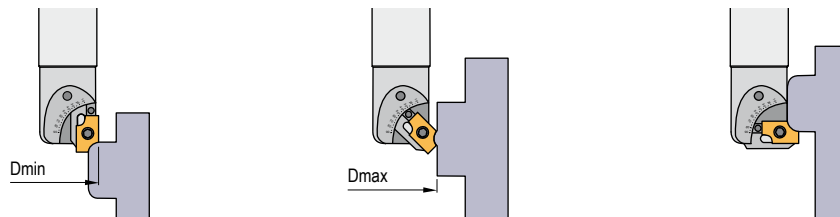

ADMT-R

Parallelogram positive inserts with 15° clearance. F10
Parallelogramme positive WSP mit 15° Freiwinkel.

Reference / Bezeichnung	r	s	d
ADMT 1503R1.0	1.0	3,18	9,52
ADMT 1503R1.5	1.5	3,18	9,52
ADMT 1503R2.0	2.0	3,18	9,52
ADMT 1503R2.5	2.5	3,18	9,52
ADMT 1503R3.0	3.0	3,18	9,52
ADMT 1503R3.5	3.5	3,18	9,52
ADMT 1503R4.0	4.0	3,18	9,52
ADMT 1503R4.5	4.5	3,18	9,52
ADMT 1503R5.0	5.0	3,18	9,52

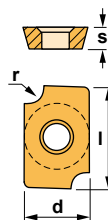





Characteristics:

Indexable cutters with concave radius.
Fully ground double cutting edge that offers an economical alternative to conventional corner rounding tools.
One cutter body for 6, 8 and 10 mm radius.

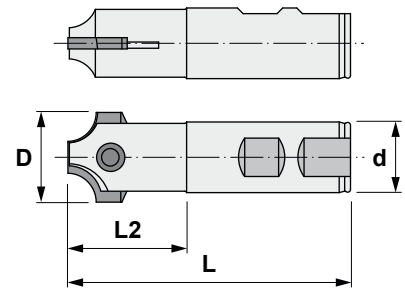

Eigenschaften:

Viertelkreisfräser mit konkavem Radius.
Völlig geschliffene doppelte Schnittkante, die eine wirtschaftliche Alternative zu den konventionellen Werkzeugen zum Kantennunden anbietet.
Ein einzelner Körper, um Radien 6, 8 und 10 mm zu machen.

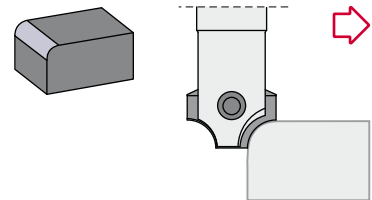

1345.07

Reference Bezeichnung		L	L2	d	D	Insert size Wendeschneidplatte	
1345.07.012	2	100	33	25	25	HPKW 2504..	0,450

Reference Bezeichnung			Nm
1345.07.012	1609	5530	7.0

HPKW

Triangular positive insert with 7° clearance. F14
Dreikantige positive Wendeschneidplatte mit 11° Freiwinkel.

Reference / Bez.	l	s	d	d2	r
HPKW 2504R06	26,50	4,00	25,00	12,00	6,00
HPKW 2504R08	26,50	4,00	25,00	12,00	8,00
HPKW 2504R10	26,50	4,00	25,00	12,00	10,00

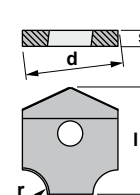

HPKW





Characteristics:

Indexable cutters with concave radius.
Fully ground double cutting edge that offers an economical alternative to conventional corner rounding tools.
One cutter body for 6, 8 and 10 mm radius.

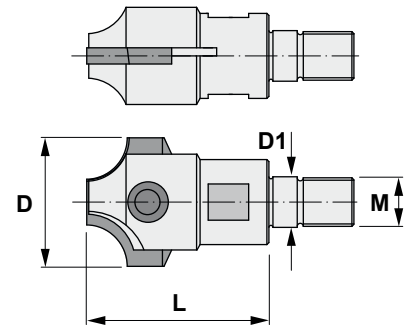

Eigenschaften:

Viertelkreisfräser mit konkavem Radius.
Völlig geschliffene doppelte Schnittkante, die eine wirtschaftliche Alternative zu den konventionellen Werkzeugen zum Kantenrunden anbietet.
Ein einzelner Körper, um Radien 6, 8 und 10 mm zu machen.

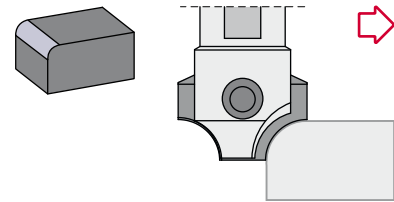

1345.06

Reference Bezeichnung		L	M	D	D1	Insert size Wendeschneidplatte	
1345.06.012	2	45	M12x1.75	25	12,5	HPKW 2504..	0,300

Reference Bezeichnung			Nm
1345.06.012	1609	5530	7.0

HPKW

Triangular positive insert with 7° clearance. F14
Dreikantige positive Wendeschneidplatte mit 11° Freiwinkel.

Reference / Bez.	l	s	d	d2	r
HPKW 2504R06	26,50	4,00	25,00	12,00	6,00
HPKW 2504R08	26,50	4,00	25,00	12,00	8,00
HPKW 2504R10	26,50	4,00	25,00	12,00	10,00

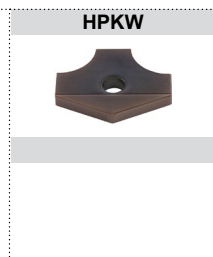
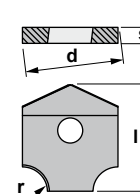

Cutting data for face milling cutters

Material	P	HB	Condition	Cutting speed m/min.					
				TIN25	TIN21	TIN28	PM25	PM40	TL40
				0.3-0.2-0.1	0.3-0.2-0.1	0.3-0.2-0.1	0.4-0.2-0.1	0.4-0.2-0.1	0.4-0.2-0.1
Unalloyed steel		110 150 310	C<0.25% C<0.80% C<1.40%	250-300-390 155-180-255 135-165-210	250-350-450 100-120-165 75-110-135	140-160-180 120-140-150 80-90-100	180-250-310 120-145-205 95-130-170	100-130-160 65-85-100 50-75-85	180-250-310 120-145-205 95-130-170
Low alloyed steel		125-225 220-450	Hardened	170-200-250 110-130-150	100-120-165 55-75-95	120-140-160 90-120-140	120-160-200 70-100-120	95-85-105 40-55-65	120-160-200 70-100-120
High alloyed steel		150-250 250-300	Hardened	140-170-225 90-110-150	90-115-150 60-75-90	60-80-90 55-60-70	110-140-180 65-90-120	60-80-90 40-50-60	110-140-180 65-90-120
High alloyed steel		150-250 250-300	High speed steel (HSS) Hardened Hardened tool steel	130-160-195	75-105-130	60-65-70	90-125-155 70-95-120	50-60-75 30-40-50	90-125-155 70-95-120
Stainless steel		150-270	Ferritic, martensitic	155-180-250	110-150-190	130-180-220	120-165-210	80-105-130	120-165-210
Steel castings		150 150-250 160-200	Unalloyed Low alloyed High alloyed	140-180-250 125-150-190 90-110-130	80-120-150 70-100-120 55-70-80	60-80-90 55-60-70	100-145-180 90-120-150 65-90-100	60-75-95 50-65-80 35-45-55	100-145-180 90-120-150 65-90-100
Stainless steel castings		150-250	Ferritic, martensitic		50-80	60-65-70	50-70-80	30-40-50	50-70-80

Material	M	HB	Condition	Cutting speed m/min.				
				TIN25	TIN21	TIN28	KM15	PM25
				0.4-0.2-0.1	0.3-0.2-0.1	0.4-0.2-0.1	0.2-0.1	0.4-0.2-0.1
Stainless steel annealed		150-220	Austenitic	180-220-280	80-150-220	130-180-220		150-240-300
Steel castings		200	Stainless, austenitic		40-70	80-120-160		50-60
Iron, nickel and cobalt base castings		180-300 220-300 220-300			40-100	70-120-140	20-40 20-40 10-20	
Titanium alloys		300-400				40-80		

Material	K	HB	Condition	Cutting speed m/min.				
				TIN25	TIN21	TIN28	KM15	PM25
				0.4-0.2-0.1	0.3-0.2-0.1	0.4-0.2-0.1	0.2-0.1	0.4-0.2-0.1
Tempered steel		HCR 50-65						15-20-30
Stainless steel castings		250	Manganese steel 12-14% Mn				12-18-20	
Malleable cast iron		110-145 200-230	Short chipping Long chipping		200-300 150-200	180-330	65-80-95 50-65-80	100-125-150 90-115-135
Grey cast iron		180 260	Low tensile strength High tensile strength		200-400 150-350	130-240 110-200	70-95-120 50-70-90	85-120-155 70-90-115
Nodular cast iron		160 250	Ferritic Pearlitic	100-130 90-110	100-250 100-180	70-140 60-120	50-65-80 45-60-70	70-90-115 65-80-100
Chilled cast iron		HCR 40-60						
Aluminium alloys		60-100 75-110	Non cast Cast				500-2100 400-2000	
Aluminium with high contents of Si			10-14% Si 14-16% Si 16-18% Si				200-1000 110-200	

Schnittdaten für Planfräser

Materialien	P	HB	Beschaffenheit	Schnittgeschwindigkeit M/Min.					
				TIN25	TIN21	TIN28	PM25	PM40	TL40
				0.3-0.2-0.1	0.3-0.2-0.1	0.3-0.2-0.1	0.4-0.2-0.1	0.4-0.2-0.1	0.4-0.2-0.1
Unlegierter Stahl		110 150 310	C<0.25% C<0.80% C<1.40%	250-300-390 155-180-255 135-165-210	250-350-450 100-120-165 75-110-135	140-160-180 120-140-150 80-90-100	180-250-310 120-145-205 95-130-170	100-130-160 65-85-100 50-75-85	180-250-310 120-145-205 95-130-170
Niedrig legierter Stahl		125-225 220-450	Vergütet	170-200-250 110-130-150	100-120-165 55-75-95	120-140-160 90-120-140	120-160-200 70-100-120	95-85-105 40-55-65	120-160-200 70-100-120
Hochlegierter Stahl		150-250 250-300	Vergütet	140-170-225 90-110-150	90-115-150 60-75-90	60-80-90 55-60-70	110-140-180 65-90-120	60-80-90 40-50-60	110-140-180 65-90-120
Hochlegierter Stahl		150-250 250-300	Schnellstahl (HSS) Vergütet Vergüteter Werkzeugstahl	130-160-195	75-105-130	60-65-70	90-125-155 70-95-120	50-60-75 30-40-50	90-125-155 70-95-120
Rostfreier Stahl		150-270	Ferritisch, Martensitisch	155-180-250	110-150-190	130-180-220	120-165-210	80-105-130	120-165-210
Stahlguß		150 150-250 160-200	Unlegiert Niedrig legiert Hochlegiert	140-180-250 125-150-190 90-110-130	80-120-150 70-100-120 55-70-80	60-80-90 55-60-70	100-145-180 90-120-150 65-90-100	60-75-95 50-65-80 35-45-55	100-145-180 90-120-150 65-90-100
Rostfreier Stahlguß		150-250	Ferritisch, Martensitisch		50-80	60-65-70	50-70-80	30-40-50	50-70-80

Materialien	M	HB	Beschaffenheit	Schnittgeschwindigkeit M/Min.				
				TIN25	TIN21	TIN28	KM15	PM25
				0.4-0.2-0.1	0.3-0.2-0.1	0.4-0.2-0.1	0.2-0.1	0.4-0.2-0.1
Rostfreier Stahl, gegläht		150-220	Austenitisch	180-220-280	80-150-220	130-180-220		150-240-300
Stahlguß		200	Rostfrei, austenitisch		40-70	80-120-160		50-60
Eisen- Nickel- und Kobalthaltiger Guß		180-300 220-300 220-300			40-100	70-120-140	20-40 20-40 10-20	
Titan-Legierungen		300-400				40-80		

Materialien	K	HB	Beschaffenheit	Schnittgeschwindigkeit M/Min.				
				TIN25	TIN21	TIN28	KM15	PM25
				0.4-0.2-0.1	0.3-0.2-0.1	0.4-0.2-0.1	0.2-0.1	0.4-0.2-0.1
Vergüteter Stahl		HCR 50-65						15-20-30
Rostfreier Stahlguß		250	Manganstahl 12-14% Mn				12-18-20	
Temperguß		110-145 200-230	Kurzspanend Langspanend		200-300 150-200	180-330	65-80-95 50-65-80	100-125-150 90-115-135
Grauguß		180 260	Niedrige Zugfestigkeit Hohe Zugfestigkeit		200-400 150-350	130-240 110-200	70-95-120 50-70-90	85-120-155 70-90-115
Kugelgraphitguß		160 250	Ferritisch Perlitisch	100-130 90-110	100-250 100-180	70-140 60-120	50-65-80 45-60-70	70-90-115 65-80-100
Kokillenhartguß		HCR 40-60						
Aluminium-Legierungen		60-100 75-110	Nicht gegossen Gegossen				500-2100 400-2000	
Aluminium mit hohem Silizium (Si)-Gehalt			10-14% Si 14-16% Si 16-18% Si				200-1000 110-200	



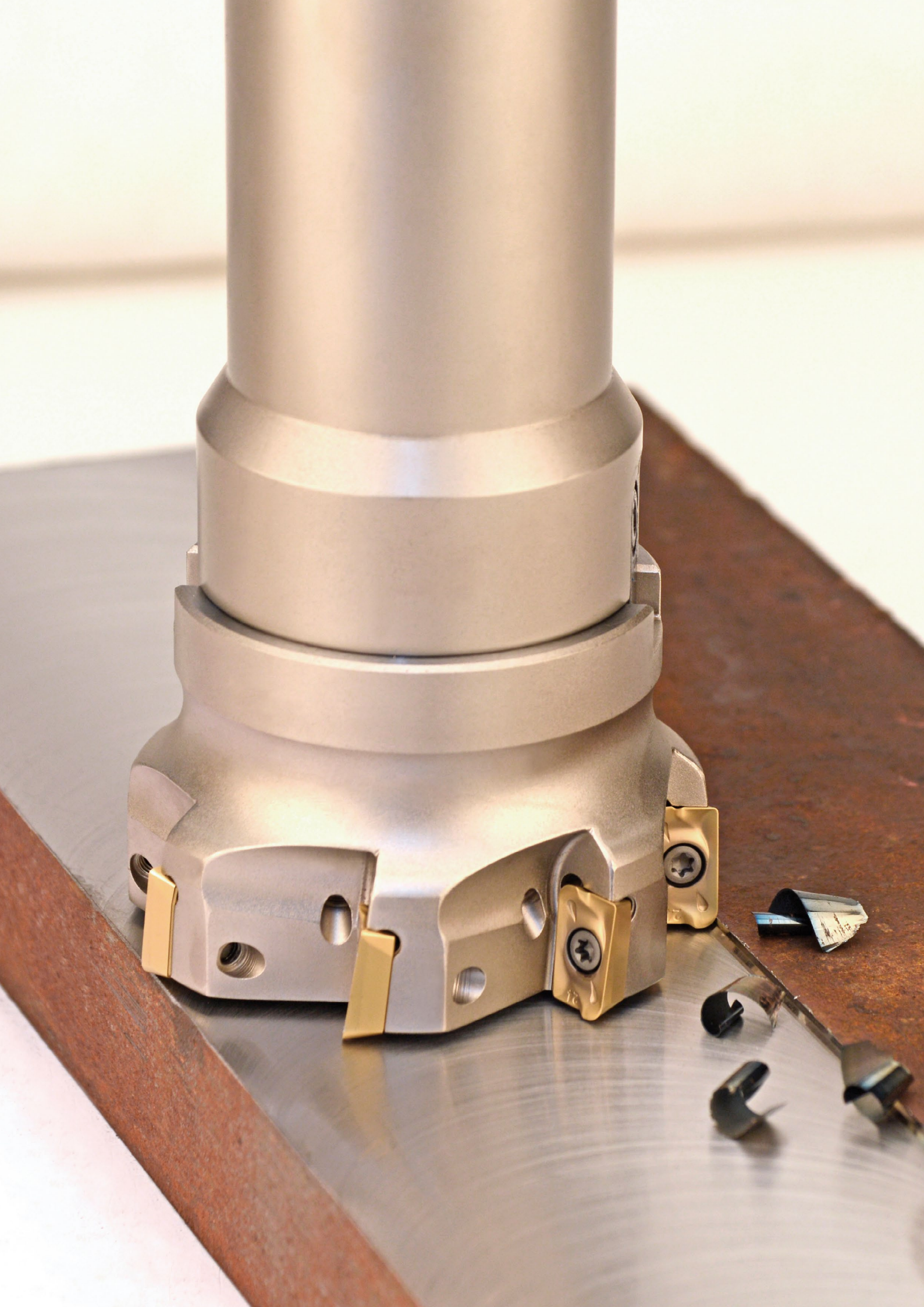



SQUARE SHOULDER CUTTERS ECKFRÄSER

Applications index **F65**
Anwendungen

Facing square shoulder cutters **F66-95**
Eckfräser

Cutting data **F96-99**
Schnittdaten



F

ECO-MILL 90°

Eco-Mill double-sided insert series provide more available cutting edges and lower cost than conventional milling cutters. The exclusive positive geometry guarantees low cutting loads and longer tool life.

Die Eco-Mill Serie mit doppelseitigen Wendeschneidplatten bietet mehr verfügbare Schnittkanten und niedrigere Kosten als die konventionelle Fräser an.







Die einzigartige positive Geometrie garantiert einen niedrigen Schnittdruck und längere Standzeiten.

■ Features / Eigenschaften

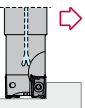
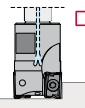
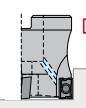
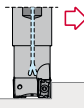
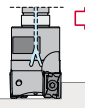
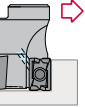
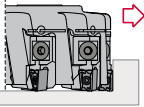
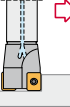
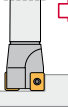
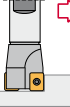
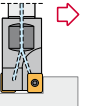
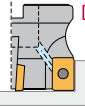
- High axial and radial positive geometry.
- Capable of multiple milling applications.
- Internal coolant supply.
- Strong pocket design.
- Sehr positive axiale und radiale Geometrie.
- Für vielfache Fräsanwendungen geeignet.
- Innere Kühlmittelzufuhr.
- Stabiles Design des Plattensitzes.

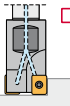
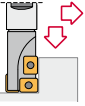
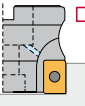
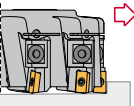
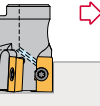
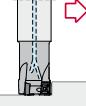
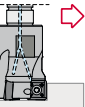
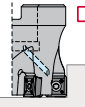
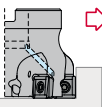
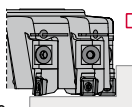
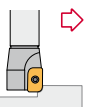
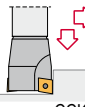
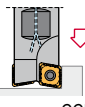

**Facing square shoulder cutters
Eckfräser**

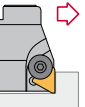
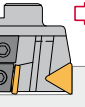
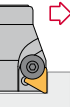
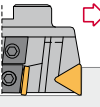
<p>1222.37 First choice 90° Erste Wahl 90°</p>  <p>Page Seite F66 LNMM 1006..</p>	<p>1222.06 First choice 90° Erste Wahl 90°</p>  <p>Page Seite F66 LNMM 1006..</p>	<p>1222.93 First choice 90° Erste Wahl 90°</p>  <p>Page Seite F67 LNMM 1006..</p>	<p>1232.37 First choice 90° Erste Wahl 90°</p>  <p>Page Seite F68 LNMM 1510..</p>	<p>1232.06 90° First choice 90° Erste Wahl 90°</p>  <p>Page Seite F69 LNMM 1510..</p>
<p>1232.93 90° First choice 90° Erste Wahl 90°</p>  <p>Page Seite F70 LNMM 1510..</p>	<p>1232.99 90° First choice 90° Erste Wahl 90°</p>  <p>Page Seite F71 LNMM 1510..</p>	<p>1220.03 90° General application 90° Allgemeine Anwendungen 90°</p>  <p>Page Seite F72 AP.. 1003..</p>	<p>1220.02 90° General application 90° Allgemeine Anwendungen 90°</p>  <p>Page Seite F73 AP.. 1003..</p>	<p>1220.07 90° General application 90° Allgemeine Anwendungen 90°</p>  <p>Page Seite F74 AP.. 1003..</p>
<p>1220.06 90° General application 90° Allgemeine Anwendungen 90°</p>  <p>Page Seite F75 AP.. 1003..</p>	<p>1220.93 90° General application 90° Allgemeine Anwendungen 90°</p>  <p>Page Seite F76 AP.. 1003..</p>	<p>1230.07 90° General application 90° Allgemeine Anwendungen 90°</p>  <p>Page Seite F77 AP.. 1604..</p>	<p>1230.02 90° General application 90° Allgemeine Anwendungen 90°</p>  <p>Page Seite F78 AP.. 1604..</p>	<p>1230.06 90° General application 90° Allgemeine Anwendungen 90°</p>  <p>Page Seite F79 AP.. 1604..</p>
<p>2230.07 90° Slot and side milling 90° Bohrnutenfräser 90°</p>  <p>Page Seite F80 AP.. 1003.. AP.. 1604..</p>	<p>1230.93 90° General application 90° Allgemeine Anwendungen 90°</p>  <p>Page Seite F81 AP.. 1604..</p>	<p>1230.99 90° General application 90° Allgemeine Anwendungen 90°</p>  <p>Page Seite F82 AP.. 1604..</p>	<p>1245.93 90° General application 90° Allgemeine Anwendungen 90°</p>  <p>Page Seite F83 ADKT 2206..</p>	<p>0235.03 90° Square and facing 90° Plan- und Eckfräsen 90°</p>  <p>Page Seite F84 SDMT 09T3..</p>
<p>0235.06 90° Square and facing 90° Plan- und Eckfräsen 90°</p>  <p>Page Seite F84 SDMT 09T3..</p>	<p>0235.93 90° Square and facing 90° Plan- und Eckfräsen 90°</p>  <p>Page Seite F85 SDMT 09T3..</p>	<p>0255.93 90° Square and facing 90° Plan- und Eckfräsen 90°</p>  <p>Page Seite F86 SDMT 1205..</p>	<p>0255.99 90° Square and facing 90° Plan- und Eckfräsen 90°</p>  <p>Page Seite F87 SDMT 1205..</p>	<p>1135.01 Convex milling cutters Konvexe Schafffräser</p>  <p>Page Seite F88 ADMW-C 1503..</p>
<p>3314.01 Multi-function centre-cutting end mill Bohrnuten-Universalfräser</p>  <p>Page Seite F89 CCKT 0602.. CCKT 1204..</p>	<p>3314.06 Multi-function centre-cutting end mill Bohrnuten-Universalfräser</p>  <p>Page Seite F89 CCKT 0602.. CCKT 1204..</p>	<p>0120.00 90° General application 90° Allgemeine Anwendungen 90°</p>  <p>Page Seite F90 TP.. 1103..</p>	<p>0130.00 90° General application 90° Allgemeine Anwendungen 90°</p>  <p>Page Seite F91 TP.. 1603..</p>	<p>0130.30 90° General application 90° Allgemeine Anwendungen 90°</p>  <p>Page Seite F91 TP.. 1603..</p>
<p>0130.90 90° General application 90° Allgemeine Anwendungen 90°</p>  <p>Page Seite F92 TP.. 1603..</p>	<p>0130.99 90° General application 90° Allgemeine Anwendungen 90°</p>  <p>Page Seite F93 TP.. 1603..</p>	<p>0140.90 90° Deep cutting 90° Tiefer Schnitt 90°</p>  <p>Page Seite F94 TP.. 2204..</p>	<p>0140.99 90° Deep cutting 90° Tiefer Schnitt 90°</p>  <p>Page Seite F95 TP.. 2204..</p>	





Characteristics:
Positive milling cutter for diversified manufacture with an exact angle of 90° that uses very strong inserts allowing deep passes and high feed per teeth.

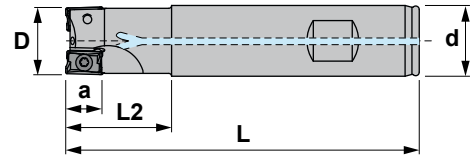

Eigenschaften:
Positiver Eckfräser für allgemeine Anwendungen mit einem genauen Einstellwinkel von 90° und stabilen Wendeschneidplatten, die hohe Schnitttiefen und einen hohen Vorschub pro Zahn erlauben.

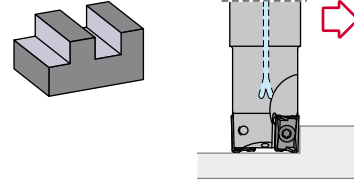

1222.37

Reference Bezeichnung		D	L	d	L2	a	Insert size Wendeschneidplatte	
1222.37.020	2	20	100	20	30	9	LNMM 1006..	0,220
1222.37.025	3	25	100	25	30	9	LNMM 1006..	0,340
1222.37.032	4	32	110	32	30	9	LNMM 1006..	0,630

Reference Bezeichnung			Nm
1222.37.020	1230	5508	1.2
1222.37.025	1230	5508	1.2
1222.37.032	1230	5508	1.2

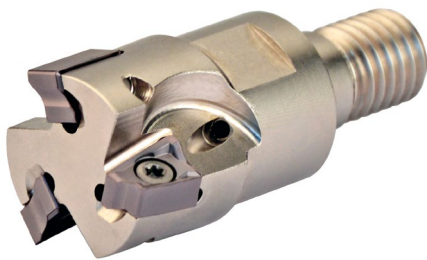

Characteristics:
Positive milling cutter for diversified manufacture with an exact angle of 90° that uses very strong inserts allowing deep passes and high feed per teeth.

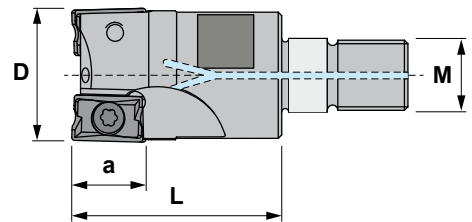

Eigenschaften:
Positiver Eckfräser für allgemeine Anwendungen mit einem genauen Einstellwinkel von 90° und stabilen Wendeschneidplatten, die hohe Schnitttiefen und einen hohen Vorschub pro Zahn erlauben.

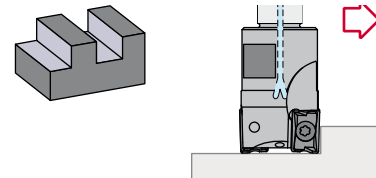

1222.06

Reference Bezeichnung		D	L	M	a	Insert size Wendeschneidplatte	
1222.06.020	2	20	30	M10	9	LNMM 1006..	0,060
1222.06.025	3	25	35	M12	9	LNMM 1006..	0,110
1222.06.032	4	32	43	M16	9	LNMM 1006..	0,250

Reference Bezeichnung			Nm
1222.06.020	1230	5508	1.2
1222.06.025	1230	5508	1.2
1222.06.032	1230	5508	1.2

LNMM

Rectangular negative insert.
Rechteckige negative Wendeschneidplatte. F14

Reference / Bez.	l	s	d	r
LNMM 1006..	10,00	6,5	6,5	0,5

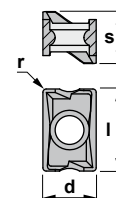

LNMM



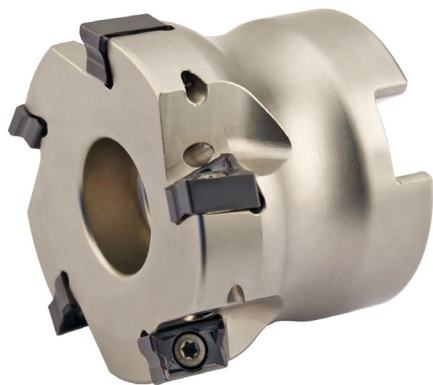

Characteristics:

Positive milling cutter for diversified manufacture with an exact angle of 90° that uses very strong inserts allowing deep passes and high feed per teeth.

Eigenschaften:

Positiver Eckfräser für allgemeine Anwendungen mit einem genauen Einstellwinkel von 90° und stabilen Wendeschneidplatten, die hohe Schnitttiefen und einen hohen Vorschub pro Zahn erlauben.

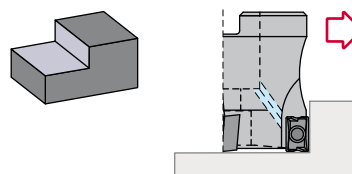
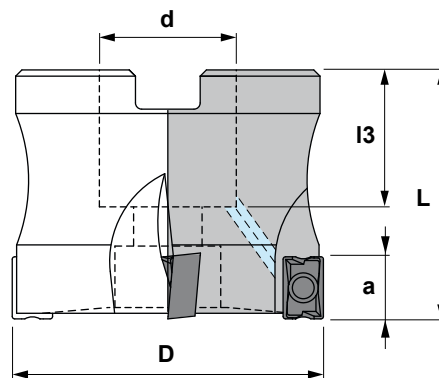

1222.93 90°

Reference Bezeichnung		D	L	d	I3	a	Insert size Wendeschneidplatte	
1222.93.032	4	32	40	16	20	9	LNMM 1006..	0,140
1222.93.040	5	40	40	16	20	9	LNMM 1006..	0,240
1222.93.050	7	50	40	22	22	9	LNMM 1006..	0,360
1222.93.063	9	63	50	22	25	9	LNMM 1006..	0,080

Reference Bezeichnung				Nm
1222.93.032	1230	5508	1058	1.2
1222.93.040	1230	5508	1058	1.2
1222.93.050	1230	5508	912,10	1.2
1222.93.063	1230	5508	912,10	1.2

LNMM

Rectangular negative insert.
Rechteckige negative Wendeschneidplatte. F14

Reference / Bez.	l	s	d	r
LNMM 1006..	10,00	6,5	6,5	0,5

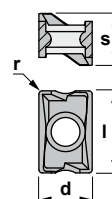

LNMM





Characteristics:
Positive milling cutter for diversified manufacture with an exact angle of 90° that uses very strong inserts allowing deep passes and high feed per teeth.

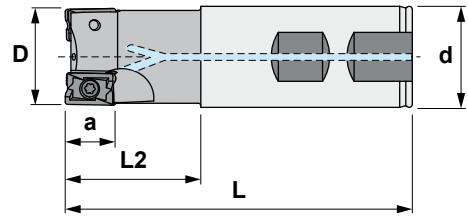

Eigenschaften:
Positiver Eckfräser für allgemeine Anwendungen mit einem genauen Einstellwinkel von 90° und stabilen Wendeschneidplatten, die hohe Schnitttiefen und einen hohen Vorschub pro Zahn erlauben.

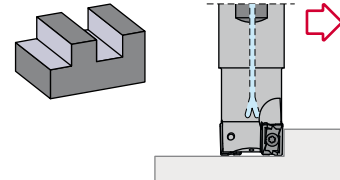

1232.37

Reference Bezeichnung		D	L	d	L2	a	Insert size Wendeschneidplatte	
1232.37.025	2	25	100	25	35	14	LNMM 1510..	0,330
1232.37.032	3	32	110	32	35	14	LNMM 1510..	0,610
1232.37.040	4	40	110	32	35	14	LNMM 1510..	0,730

Reference Bezeichnung			Nm
1232.37.025	1440	5515	3.0
1232.37.032	1240	5515	3.0
1232.37.040	1240	5515	3.0

LNMM

Rectangular negative insert.
Rechteckige negative Wendeschneidplatte. F14

Reference / Bez.	l	s	d	r
LNMM 1510..	15,00	10,00	10,00	0,8

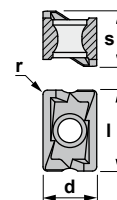

LNMM





Characteristics:

Positive milling cutter for diversified manufacture with an exact angle of 90° that uses very strong inserts allowing deep passes and high feed per teeth.

Eigenschaften:

Positiver Eckfräser für allgemeine Anwendungen mit einem genauen Einstellwinkel von 90° und stabilen Wendeschneidplatten, die hohe Schnitttiefen und einen hohen Vorschub pro Zahn erlauben.

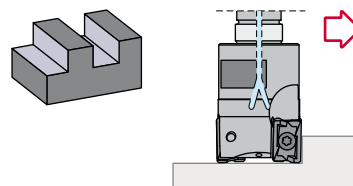
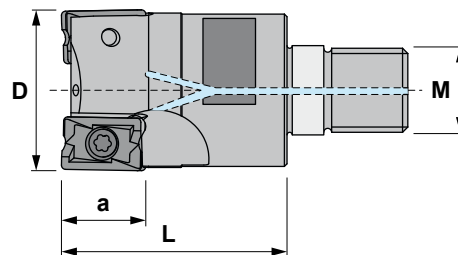

1232.06

Reference Bezeichnung		D	L	M	a	Insert size Wendeschneidplatte	
1232.06.025	2	25	35	M12	14	LNMM 1510..	0,100
1232.06.032	3	32	43	M16	14	LNMM 1510..	0,210

Reference Bezeichnung			Nm
1232.06.025	1240	5515	3.0
1232.06.032	1240	5515	3.0

LNMM

Rectangular negative insert. F14
Rechteckige negative Wendeschneidplatte.

Reference / Bez.	l	s	d	r
LNMM 1510..	15,00	10,00	10,00	0,8

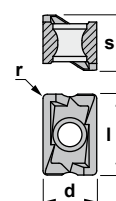

LNMM





Characteristics:

Positive milling cutter for diversified manufacture with an exact angle of 90° that uses very strong inserts allowing deep passes and high feed per teeth.

Eigenschaften:

Positiver Eckfräser für allgemeine Anwendungen mit einem genauen Einstellwinkel von 90° und stabilen Wendeschneidplatten, die hohe Schnitttiefen und einen hohen Vorschub pro Zahn erlauben.

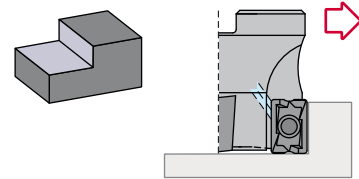
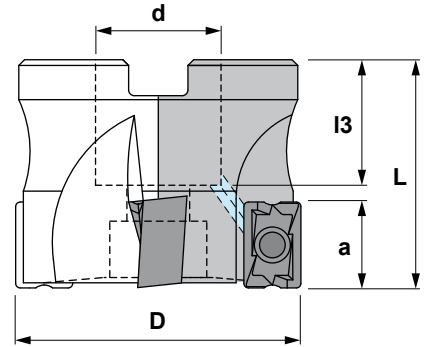

1232.93 90°

Reference Bezeichnung		D	L	d	l3	a	Insert size Wendeschneidplatte	
1232.93.040	4	40	40	16	18	14	LNMM 1510..	0,200
1232.93.050	4	50	40	22	22	14	LNMM 1510..	0,300
1232.93.063	6	63	50	27	22	14	LNMM 1510..	0,650
1232.93.080	7	80	50	27	25	14	LNMM 1510..	1,150
1232.93.100	8	100	50	32	25	14	LNMM 1510..	1,700
1232.93.125	10	125	63	40	30	14	LNMM 1510..	2,850
1232.90.160	12	160	63	40	30	14	LNMM 1510..	4,400

Reference Bezeichnung					Nm
1232.93.040	1240	5515	-	1058	3.0
1232.93.050	1240	5515	-	912,10	3.0
1232.93.063	1240	5515	-	912,12	3.0
1232.93.080	1240	5515	-	912,12	3.0
1232.93.100	1240	-	5615	912,16	3.0
1232.93.125	1240	-	5615	912,20	3.0
1232.90.160	1240	-	5615	912,52 x 4	3.0

LNMM

Rectangular negative insert.
Rechteckige negative Wendeschneidplatte. F14

Reference / Bez.	l	s	d	r
LNMM 1510..	15,00	10,00	10,00	0,8

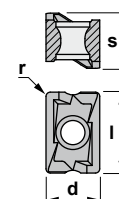

LNMM



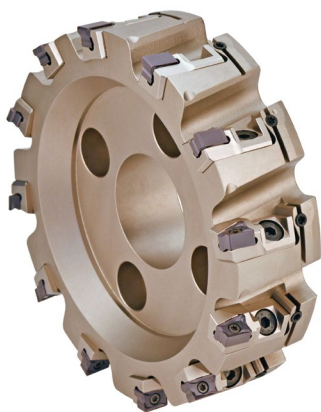

Characteristics:

Positive milling cutter for diversified manufacture with an exact angle of 90° that uses very strong inserts allowing deep passes and high feed per teeth.

Eigenschaften:

Positiver Eckfräser für allgemeine Anwendungen mit einem genauen Einstellwinkel von 90° und stabilen Wendeschneidplatten, die hohe Schnitttiefen und einen hohen Vorschub pro Zahn erlauben.

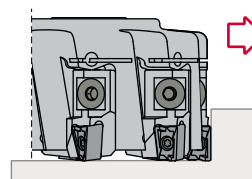
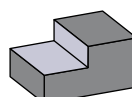
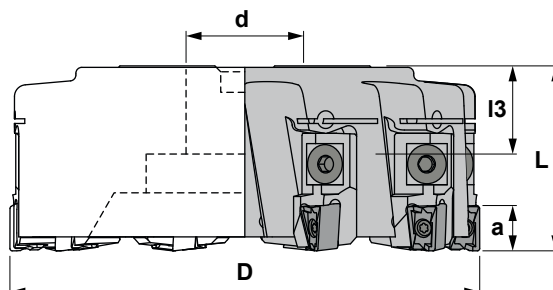

1232.99 90°

Reference Bezeichnung		D	L	d	l3	a	Insert size Wendeschneidplatte	
1232.99.160	10	160	63	40	30	14	LNMM 1510..	4,000
1232.99.200	12	200	63	60	40	14	LNMM 1510..	7,700
1232.99.250	16	250	63	60	40	14	LNMM 1510..	10,800
1232.99.315	20	315	63	60	40	14	LNMM 1510..	31,000
1232.99.400	22	400	63	60	40	14	LNMM 1510..	47,500
1232.99.500	28	500	63	60	40	14	LNMM 1510..	85,000

Reference Bezeichnung							DIN 2079	Nm
1232.99.160	1240	5615	6232	1788	1460		40	3.0
1232.99.200	1240	5615	6232	1788	1460		50	3.0
1232.99.250	1240	5615	6232	1788	1460		50	3.0
1232.99.315	1240	5615	6232	1788	1460		50/60	3.0
1232.99.400	1240	5615	6232	1788	1460		50/60	3.0
1232.99.500	1240	5615	6232	1788	1460		50/60	3.0

LNMM

Rectangular negative insert. F14
Rechteckige negative Wendeschneidplatte.

Reference / Bez.	l	s	d	r
LNMM 1510..	15,00	10,00	10,00	0,8

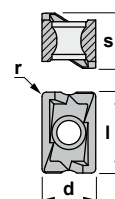

LNMM



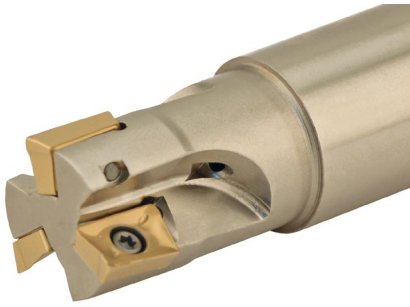

Characteristics:

Positive milling cutter for diversified manufacture with an exact angle of 90° that uses very strong inserts allowing deep passes and high feed per teeth. Recommended for conventional milling machines and machining centers.

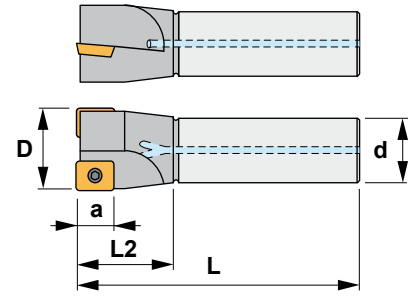

Eigenschaften:

Positiver Eckfräser für allgemeine Anwendungen mit einem genauen Einstellwinkel von 90° und stabilen Wendeschneidplatten, die hohe Schnitttiefen und einen hohen Vorschub pro Zahn erlauben.

Für konventionelle Fräsmaschinen und Bearbeitungszentren geeignet.

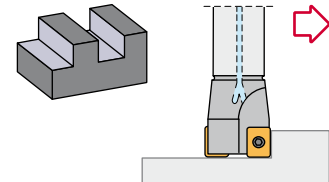

1220.03

Reference Bezeichnung		D	L	L2	d	a	Insert size Wendeschneidplatte	
1220.03.010	1	10	110	25	16	9	AP.. 1003..	0,120
1220.03.012	1	12	110	25	16	9	AP.. 1003..	0,150
1220.03.014	1	14	110	25	16	9	AP.. 1003..	0,200
1220.03.016	2	16	110	25	20	9	AP.. 1003..	0,250
1220.03.018	2	18	110	30	20	9	AP.. 1003..	0,280
1220.03.020	3	20	125	30	20	9	AP.. 1003..	0,300
1220.03.022	3	22	125	30	20	9	AP.. 1003..	0,350
1220.03.025	4	25	125	30	25	9	AP.. 1003..	0,450
1220.03.028	4	28	125	30	25	9	AP.. 1003..	0,500

Reference Bezeichnung			Nm
1220.03.010	1425	5507	0.9
1220.03.012	1425	5507	0.9
1220.03.014	1425	5507	0.9
1220.03.016	1425	5507	0.9
1220.03.018	1225	5507	0.9
1220.03.020	1225	5507	0.9
1220.03.022	1225	5507	0.9
1220.03.025	1225	5507	0.9
1220.03.028	1225	5507	0.9

AP..

Parallelogram positive inserts with 11° clearance. F11
Parallelegramme positive Wendeschneidplatten mit 11° Freiwinkel.

Reference / Bez.

l s d

AP.. 1003.. 9,52 3,18 6,35

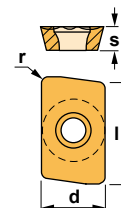

APHT-AL



APKT



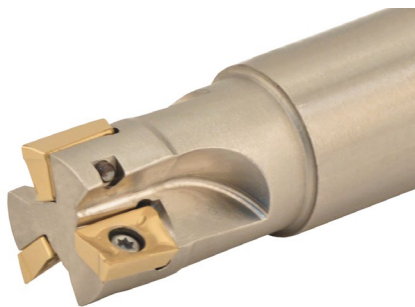

Characteristics:

Positive milling cutter for diversified manufacture with an exact angle of 90° that uses very strong inserts allowing deep passes and high feed per teeth. Recommended for conventional milling machines and machining centers.

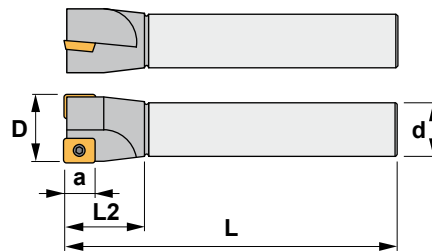

Long series / Lange Ausführung

Eigenschaften:

Positiver Eckfräser für allgemeine Anwendungen mit einem genauen Einstellwinkel von 90° und stabilen Wendeschneidplatten, die hohe Schnittiefen und einen hohen Vorschub pro Zahn erlauben.

Für konventionelle Fräsmaschinen und Bearbeitungszentren geeignet.

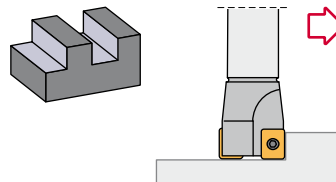

1220.02

Reference Bezeichnung		D	L	L2	d	a	Insert size Wendeschneidplatte	
1220.02.016	2	16	175	25	20	9	AP.. 1003..	0,250
1220.02.020	3	20	200	30	20	9	AP.. 1003..	0,300

Reference Bezeichnung			Nm
1220.02.016	1425	5507	0.9
1220.02.020	1225	5507	0.9

AP..

Parallelogram positive inserts with 11° clearance. F11
Parallelegramme positive Wendeschneidplatten mit 11° Freiwinkel.

Reference / Bez.

l

s

d

AP.. 1003..

9,52

3,18

6,35

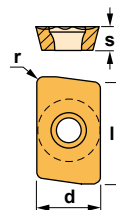

APHT-AL



APKT





Characteristics:

Positive milling cutter for diversified manufacture with an exact angle of 90° that uses very strong inserts allowing deep passes and high feed per teeth. Recommended for conventional milling machines and machining centers.

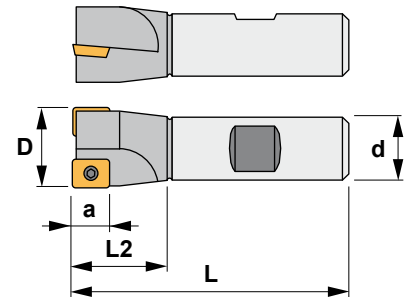

Eigenschaften:

Positiver Eckfräser für allgemeine Anwendungen mit einem genauen Einstellwinkel von 90° und stabilen Wendschneidplatten, die hohe Schnitttiefen und einen hohen Vorschub pro Zahn erlauben.

Für konventionelle Fräsmaschinen und Bearbeitungszentren geeignet.

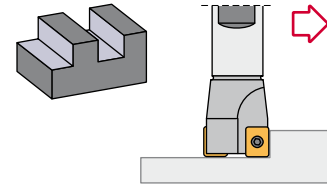

1220.07

Reference Bezeichnung		D	L	L2	d	a	Insert size Wendschneidplatte	
1220.07.012	1	12	90	25	16	9	AP.. 1003..	0,100
1220.07.016	2	16	90	25	20	9	AP.. 1003..	0,200
1220.07.020	3	20	95	30	20	9	AP.. 1003..	0,200
1220.07.025	4	25	95	30	25	9	AP.. 1003..	0,350

Reference Bezeichnung			Nm
1220.07.012	1425	5507	0.9
1220.07.016	1425	5507	0.9
1220.07.020	1225	5507	0.9
1220.07.025	1225	5507	0.9

AP..

Parallelogram positive inserts with 11° clearance. F11
Parallelogramme positive Wendschneidplatten mit 11° Freiwinkel.

Reference / Bez.

AP.. 1003..

l

9,52

s

3,18

d

6,35

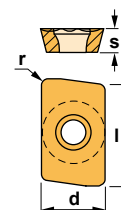

APHT-AL



APKT



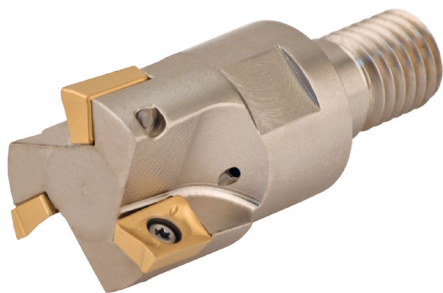

Characteristics:

Positive milling cutter for diversified manufacture with an exact angle of 90° that uses very strong inserts allowing deep passes and high feed per teeth. Recommended for conventional milling machines and machining centers.

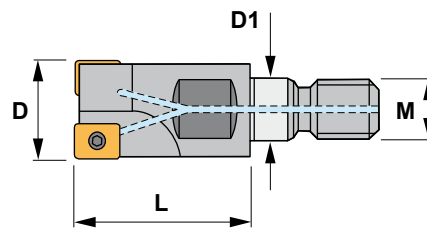

Eigenschaften:

Positiver Eckfräser für allgemeine Anwendungen mit einem genauen Einstellwinkel von 90° und stabilen Wendschneidplatten, die hohe Schnitttiefen und einen hohen Vorschub pro Zahn erlauben. Für konventionelle Fräsmaschinen und Bearbeitungszentren geeignet.

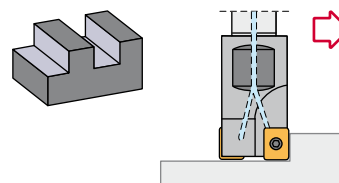

1220.06

Reference Bezeichnung		D	L	M	D1	Insert size Wendschneidplatte	
1220.06.016	2	16	23	M8	8,5	AP.. 1003..	0,040
1220.06.020	3	20	30	M10	10,5	AP.. 1003..	0,070
1220.06.025	3	25	35	M12	12,5	AP.. 1003..	0,110

Reference Bezeichnung			Nm
1220.06.016	1425	5507	0.9
1220.06.020	1225	5507	0.9
1220.06.025	1225	5507	0.9

AP..

Parallelogram positive inserts with 11° clearance. F11
Parallelegramme positive Wendschneidplatten mit 11° Freiwinkel.

Reference / Bez.	l	s	d
AP.. 1003..	9,52	3,18	6,35

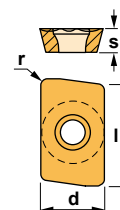

APHT-AL



APKT





Characteristics:

Positive multi-tooth milling cutter for diversified manufacture with an exact angle of 90° that uses very strong inserts allowing deep passes and high feed per teeth.

Recommended for conventional milling machines and machining centers.

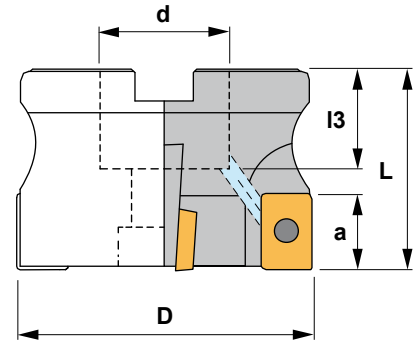

Eigenschaften:

Positiver Mehrzahn-Eckmesserkopf für allgemeine Anwendungen mit einem genauen Einstellwinkel von 90° und stabilen Wendeschneidplatten, die hohe Schnitttiefen und einen hohen Vorschub pro Zahn erlauben. Für konventionelle Fräsmaschinen und Bearbeitungszentren geeignet.

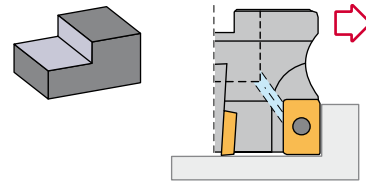

1220.93 90°

Reference Bezeichnung		D	L	d	l3	a	Insert size Wendeschneidplatte	
1220.93.032	5	32	40	16	18	9	AP.. 1003..	0,160
1220.93.040	6	40	40	16	18	9	AP.. 1003..	0,240
1220.93.050	7	50	40	22	20	9	AP.. 1003..	0,400
1220.93.063	9	63	50	22	20	9	AP.. 1003..	0,900

Reference Bezeichnung				Nm
1220.93.032	1225	5507	1058	0.9
1220.93.040	1225	5507	1058	0.9
1220.93.050	1225	5507	912,10	0.9
1220.93.063	1225	5507	912,10	0.9

AP..

Parallelogram positive inserts with 11° clearance. F11
Parallelegramme positive Wendeschneidplatten mit 11° Freiwinkel.

Reference / Bez.	l	s	d
AP.. 1003..	9,52	3,18	6,35

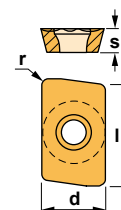

APHT-AL



APKT





Characteristics:

Positive multi-tooth milling cutter for diversified manufacture with an exact angle of 90° that uses very strong inserts allowing deep passes and high feed per teeth.

Recommended for conventional milling machines and machining centers.

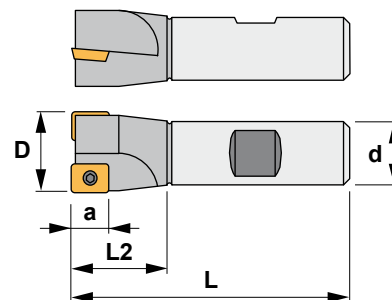

Eigenschaften:

Positiver Mehrzahn-Eckfräser für allgemeine Anwendungen mit einem genauen Einstellwinkel von 90° und stabilen Wendeschneidplatten, die hohe Schnitttiefen und einen hohen Vorschub pro Zahn erlauben.

Für konventionelle Fräsmaschinen und Bearbeitungszentren geeignet.

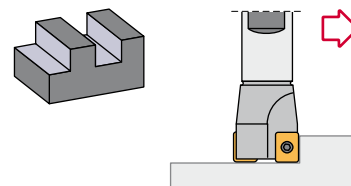

1230.07

Reference Bezeichnung		D	L	L2	d	a	Insert size Wendeschneidplatte	
1230.07.020	1	20	100	30	20	14	AP.. 1604..	0,200
1230.07.025	2	25	100	30	25	14	AP.. 1604..	0,350
1230.07.032	3	32	110	35	32	14	AP.. 1604..	0,600
1230.07.040	4	40	110	35	32	14	AP.. 1604..	0,650

Reference Bezeichnung			Nm
1230.07.020	1440	5515	3.0
1230.07.025	1440	5515	3.0
1230.07.032	1240	5515	3.0
1230.07.040	1240	5515	3.0

AP.. Parallelogram positive inserts with 11° clearance. F11
Parallelegramme positive Wendeschneidplatten mit 11° Freiwinkel.

Reference / Bez.	l	s	d
AP.. 1604..	17,00	4,76	9,52

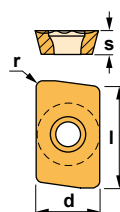

APHT-AL



APKT



APMT





Characteristics:

Positive multi-tooth milling cutter for diversified manufacture with an exact angle of 90° that uses very strong inserts allowing deep passes and high feed per teeth.

Recommended for conventional milling machines and machining centers.

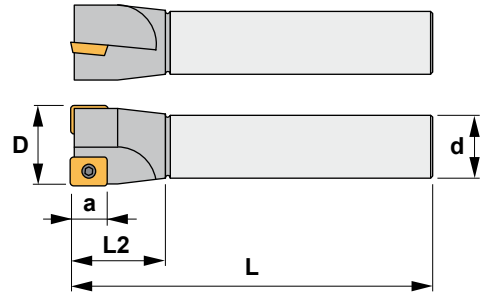

Long series / Lange Ausführung

Eigenschaften:

Positiver Mehrzahn-Eckfräser für allgemeine Anwendungen mit einem genauen Einstellwinkel von 90° und stabilen Wendeschneidplatten, die hohe Schnitttiefen und einen hohen Vorschub pro Zahn erlauben.

Für konventionelle Fräsmaschinen und Bearbeitungszentren geeignet.

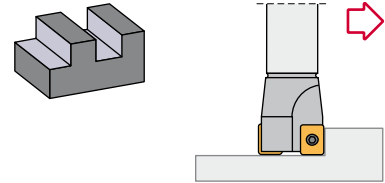

1230.02

Reference Bezeichnung		D	L	L2	d	a	Insert size Wendeschneidplatte	
1230.02.020	1	20	200	35	20	14	AP.. 1604..	0,450
1230.02.025	2	25	200	35	25	14	AP.. 1604..	0,700
1230.02.032	3	32	250	35	32	14	AP.. 1604..	1,500
1230.02.040	4	40	250	35	32	14	AP.. 1604..	1,550

Reference Bezeichnung			Nm
1230.02.020	1440	5515	3.0
1230.02.025	1440	5515	3.0
1230.02.032	1240	5515	3.0
1230.02.040	1240	5515	3.0

AP.. Parallelogram positive inserts with 11° clearance. F11
Parallelogramme positive Wendeschneidplatten mit 11° Freiwinkel.

Reference / Bez.	l	s	d
AP.. 1604..	17,00	4,76	9,52

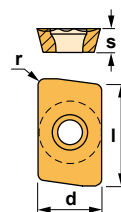

APHT-AL



APKT



APMT





Characteristics:

Positive milling cutter for diversified manufacture with an exact angle of 90° that uses very strong inserts allowing deep passes and high feed per teeth. Recommended for conventional milling machines and machining centers.

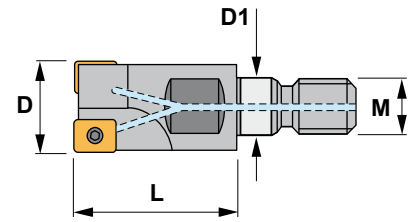

Eigenschaften:

Positiver Eckfräser für allgemeine Anwendungen mit einem genauen Einstellwinkel von 90° und stabilen Wendschneidplatten, die hohe Schnitttiefen und einen hohen Vorschub pro Zahn erlauben. Für konventionelle Fräsmaschinen und Bearbeitungszentren geeignet.

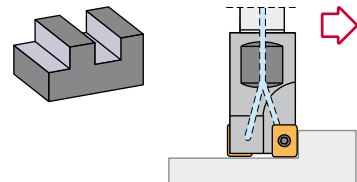

1230.06

Reference Bezeichnung		D	L	M	D1	Insert size Wendschneidplatte	
1230.06.025	2	25	35	M12	12,5	AP.. 1604..	0,110
1230.06.032	3	32	43	M16	17,0	AP.. 1604..	0,240

Reference Bezeichnung			Nm
1230.06.025	1440	5515	3.0
1230.06.032	1240	5515	3.0

AP.. Parallelogram positive inserts with 11° clearance. F11
Parallelegramme positive Wendschneidplatten mit 11° Freiwinkel.

Reference / Bez.	l	s	d
AP.. 1604..	17,00	4,76	9,52

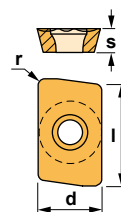

APHT-AL



APKT



APMT





Characteristics:

Super positive drill milling cutter for diversified manufacture with an exact angle of 90° that uses strong inserts allowing deep passes.

Recommended for conventional milling machines and machining centers.

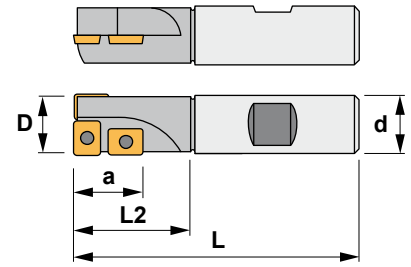

Eigenschaften:

Hochpositiver Bohrmutenfräser für allgemeine Anwendungen mit einem genauen Einstellwinkel von 90° und stabilen Wendeschneidplatten, die hohe Schnitttiefen und einen hohen Vorschub pro Zahn erlauben.

Für konventionelle Fräsmaschinen und Bearbeitungszentren geeignet.

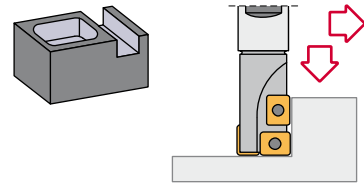

2230.07

Reference Bezeichnung		D	L	L2	d	a	Insert size Wendeschneidplatte	
2220.07.020	1+1	20	90	35	20	19	AP.. 1003..	0,200
2220.07.025	1+1	25	110	50	25	19	AP.. 1003..	0,350
2230.07.032	1+1	32	125	50	32	26	AP.. 1604..	0,600
2230.07.040	1+1	40	125	50	32	26	AP.. 1604..	0,700

Reference Bezeichnung			Nm
2220.07.020	1425	5507	0.9
2220.07.025	1425	5507	0.9
2230.07.032	1440	5515	3.0
2230.07.040	1440	5515	3.0

AP.. Parallelogram positive inserts with 11° clearance. F11
Parallelogramme positive Wendeschneidplatten mit 11° Freiwinkel.

Reference / Bez.	l	s	d
AP.. 1003..	9,52	3,18	6,35
AP.. 1604..	17,00	4,76	9,52

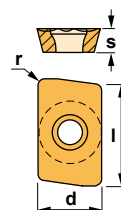

APHT-AL



APKT



APMT



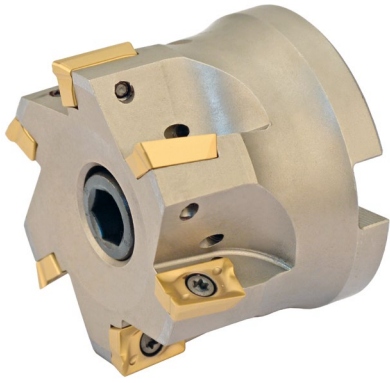

Characteristics:

Positive milling cutter for diversified manufacture with internal coolant and an exact angle of 90° that uses very strong inserts allowing deep passes and high feed per teeth.

Recommended for conventional milling machines and machining centers.

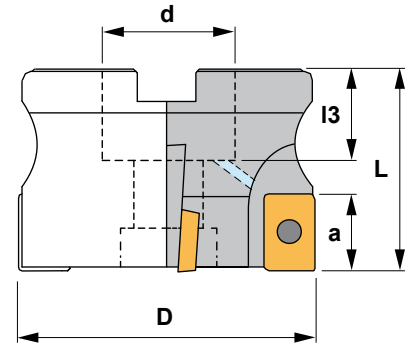

Eigenschaften:

Positiver Eckmesserkopf für allgemeine Anwendungen mit einem genauen Einstellwinkel von 90° und stabilen Wendschneidplatten, die hohe Schnitttiefen und einen hohen Vorschub pro Zahn erlauben.

Für konventionelle Fräsmaschinen und Bearbeitungszentren geeignet.

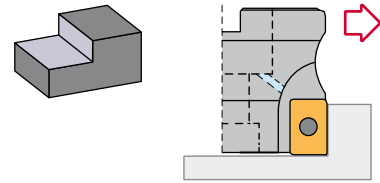

1230.93 90°

Reference Bezeichnung		D	L	d	l3	a	Insert size Wendschneidplatte	Kg
1230.93.040		40	40	16	18	14	AP.. 1604..	0,200
1230.93.050		50	40	22	20	14	AP.. 1604..	0,300
1230.93.063		63	50	27	22	14	AP.. 1604..	0,650
1230.93.080		80	50	27	22	14	AP.. 1604..	1,150
1230.93.100		100	50	32	25	14	AP.. 1604..	1,700
1230.90.125		125	63	40	30	14	AP.. 1604..	2,850
1230.90.160		160	63	40	30	14	AP.. 1604..	4,400

Reference Bezeichnung						Nm
1230.93.040	1240	5515	-	1058	-	3.0
1230.93.050	1240	5515	-	912,10	-	3.0
1230.93.063	1240	5515	-	912,12	-	3.0
1230.93.080	1240	5515	-	912,12	-	3.0
1230.93.100	1240	-	5615	912,16	-	3.0
1230.90.125	1240	-	5615	-	-	3.0
1230.90.160	1240	-	5615	912,52	40	3.0

AP.. Parallelogram positive inserts with 11° clearance. F11
Parallelogramme positive Wendschneidplatten mit 11° Freiwinkel.

Reference / Bez.	l	s	d
AP.. 1604..	17,00	4,76	9,52

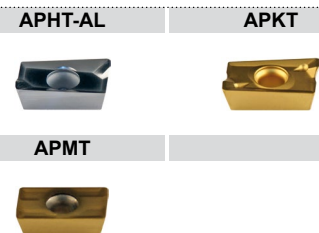
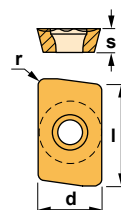



Characteristics:

Positive milling cutter for diversified manufacture with an exact angle of 90° that uses very strong inserts allowing deep passes and high feed per teeth. Recommended for conventional milling machines and machining centers.

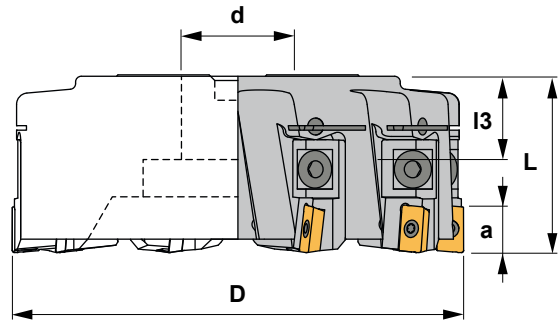

Eigenschaften:

Positiver Eckmesserkopf für allgemeine Anwendungen mit einem genauen Einstellwinkel von 90° und stabilen Wendeschneidplatten, die hohe Schnitttiefen und einen hohen Vorschub pro Zahn erlauben.

Für konventionelle Fräsmaschinen und Bearbeitungszentren geeignet.

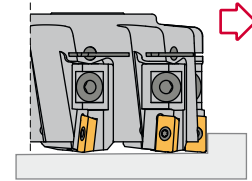
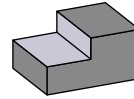

1230.99 90°

Reference Bezeichnung		D	L	d	l3	a	Insert size Wendeschneidplatte	Kg
1230.99.160	10	160	63	40	30	14	AP.. 1604..	4,000
1230.99.200	12	200	63	60	40	14	AP.. 1604..	7,700
1230.99.250	16	250	63	60	40	14	AP.. 1604..	10,800
1230.99.315	20	315	63	60	40	14	AP.. 1604..	31,000
1230.99.400	22	400	63	60	40	14	AP.. 1604..	47,500
1230.99.500	28	500	63	60	40	14	AP.. 1604..	85,000

Reference Bezeichnung							DIN 2079	Nm
1230.99.160	1240	5615	6230	1788	1460		40	3.0
1230.99.200	1240	5615	6230	1788	1460		50	3.0
1230.99.250	1240	5615	6230	1788	1460		50	3.0
1230.99.315	1240	5615	6230	1788	1460		50/60	3.0
1230.99.400	1240	5615	6230	1788	1460		50/60	3.0
1230.99.500	1240	5615	6230	1788	1460		50/60	3.0

AP.. Parallelogram positive inserts with 11° clearance. F11
Parallelogramme positive Wendeschneidplatten mit 11° Freiwinkel.

Reference / Bez.	l	s	d
AP.. 1604..	17,00	4,76	9,52

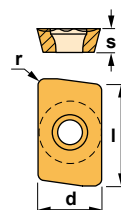

APHT-AL



APKT



APMT



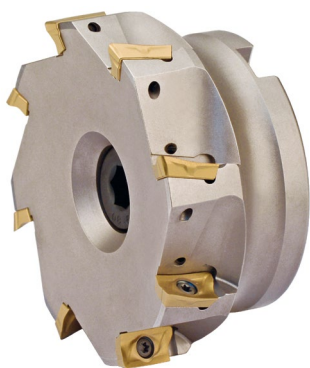

Characteristics:

Positive milling cutter for diversified manufacture with an exact angle of 90° that uses very strong inserts allowing deep passes and high feed per teeth. Recommended for conventional milling machines and machining centers.

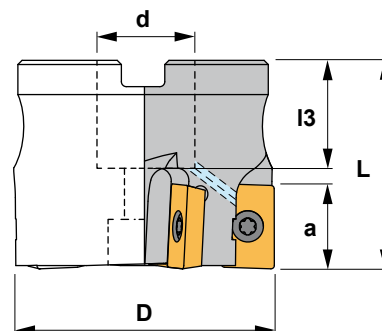

Eigenschaften:

Positiver Eckmesserkopf für allgemeine Anwendungen mit einem genauen Einstellwinkel von 90° und stabilen Wendeschneidplatten, die hohe Schnitttiefen und einen hohen Vorschub pro Zahn erlauben.

Für konventionelle Fräsmaschinen und Bearbeitungszentren geeignet.

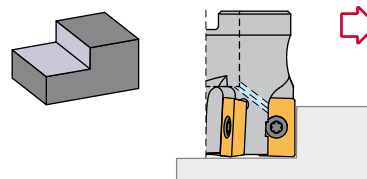

1245.93 90°

Reference Bezeichnung		D	L	d	l3	a	Insert size Wendeschneidplatte	
1245.93.050	4	50	40	22	20	19	ADKT 2206..	0,450
1245.93.063	5	63	50	27	22	19	ADKT 2206..	0,760
1245.93.080	7	80	50	27	22	19	ADKT 2206..	1,030
1245.93.100	8	100	50	32	25	19	ADKT 2206..	1,700
1245.93.125	8	125	63	40	30	19	ADKT 2206..	3,690
1245.90.160	9	160	63	40	30	19	ADKT 2206..	4,000

Reference Bezeichnung						Nm
1245.93.050	1550	5520	-	912,10	-	4.0
1245.93.063	1550	5520	-	912,12	-	4.0
1245.93.080	1550	5520	-	912,12	-	4.0
1245.93.100	1550	-	5620	912,16	-	4.0
1245.93.125	1550	-	5620	912,20	-	4.0
1245.90.160	1550	-	5620	912,52	40	4.0

ADKT

Parallelogram positive insert with 15° clearance. F10
Parallelogramme positive Wendeschneidplatte mit 15° Freiwinkel.

Reference / Bez.	l	s	d
ADKT 2206..	20,00	6,74	12,70

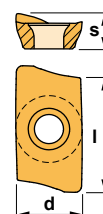

ADKT





Characteristics:

Positive milling cutter for diversified manufacture with an exact angle of 90° that uses very strong inserts allowing deep passes and high feed per teeth.

Eigenschaften:

Positiver Eckmesserkopf für allgemeine Anwendungen mit einem genauen Einstellwinkel von 90° und stabilen Wendeschneidplatten, die hohe Schnitttiefen und einen hohen Vorschub pro Zahn erlauben.

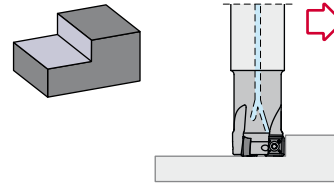
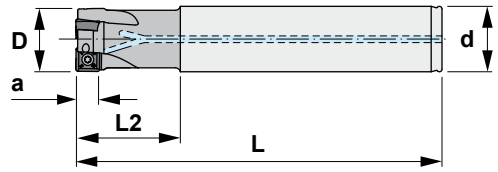

0235.03

Reference Bezeichnung		D	L	d	L2	a	Insert size Wendeschneidplatte	
0235.03.025	3	25	125	25	30	8	SDMT 09T3..	0,450
0235.03.032	4	32	150	32	30	8	SDMT 09T3..	0,510

Reference Bezeichnung			Nm
0235.03.025	1430	5508	1.2
0235.03.032	1430	5508	1.2

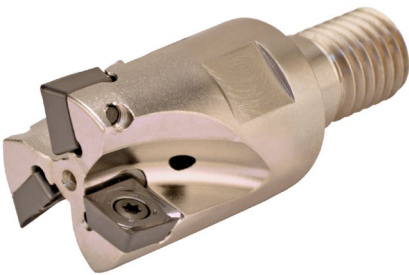

Characteristics:

Positive milling cutter for diversified manufacture with an exact angle of 90° that uses very strong inserts allowing deep passes and high feed per teeth.

Eigenschaften:

Positiver Eckmesserkopf für allgemeine Anwendungen mit einem genauen Einstellwinkel von 90° und stabilen Wendeschneidplatten, die hohe Schnitttiefen und einen hohen Vorschub pro Zahn erlauben.

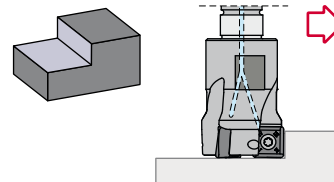
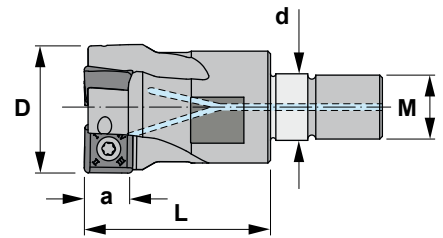

0235.06

Reference Bezeichnung		D	L	M	a	d	Insert size Wendeschneidplatte	
0235.06.025	3	25	35	M12	8	12,5	SDMT 09T3..	0,110
0235.06.032	4	32	43	M16	8	17,0	SDMT 09T3..	0,240

Reference Bezeichnung			Nm
0235.06.025	1430	5508	1.2
0235.06.032	1430	5508	1.2

SDMT

Square positive insert with 15° clearance. F17
Vierkantige positive Wendeschneidplatte mit 15° Freiwinkel.

Reference / Bez.	l	s	d
SDMT 09T3..	9,52	3,97	9,52

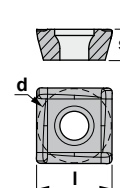

SDMT



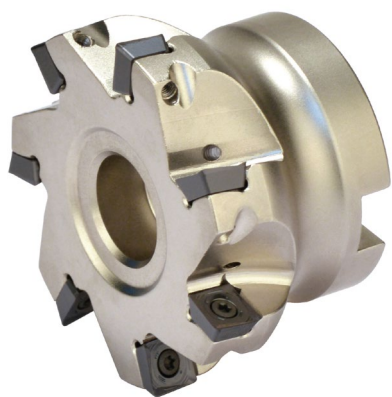

Characteristics:

Positive milling cutter for diversified manufacture with an exact angle of 90° that uses very strong inserts allowing deep passes and high feed per teeth. Recommended for conventional milling machines and machining centers.

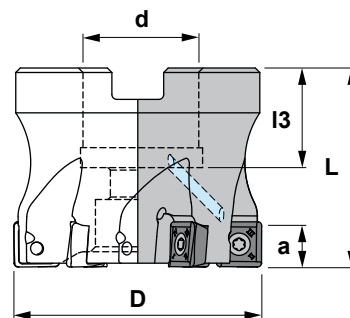

Eigenschaften:

Positiver Eckmesserkopf für allgemeine Anwendungen mit einem genauen Einstellwinkel von 90° und stabilen Wendeschneidplatten, die hohe Schnitttiefen und einen hohen Vorschub pro Zahn erlauben.

Für konventionelle Fräsmaschinen und Bearbeitungszentren geeignet.

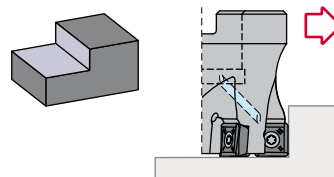

0235.93 90°

Reference Bezeichnung		D	L	d	l3	a	Insert size Wendeschneidplatte	
0235.93.040	5	40	40	16	18	8	SDMT 09T3..	0,240
0235.93.050	6	50	40	22	20	8	SDMT 09T3..	0,400
0235.93.063	7	63	50	22	20	8	SDMT 09T3..	0,900

Reference Bezeichnung			Nm
0235.93.040	1230	5508	1.2
0235.93.050	1230	5508	1.2
0235.93.063	1230	5508	1.2

SDMT

Square positive insert with 15° clearance. F17
Vierkantige positive Wendeschneidplatte mit 15° Freiwinkel.

Reference / Bez.	l	s	d
SDMT 09T3..	9,52	3,97	9,52

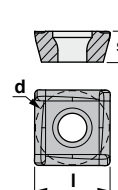

SDMT



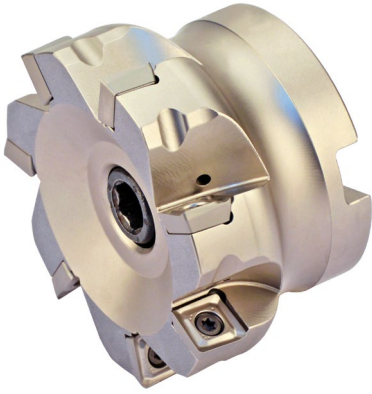

Characteristics:

Positive milling cutter for diversified manufacture with an exact angle of 90° that uses very strong inserts allowing deep passes and high feed per teeth. Recommended for conventional milling machines and machining centers.

Axial 7°
Radial -10°

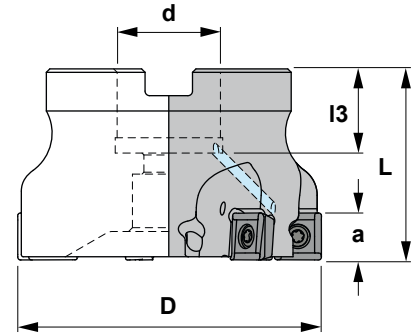

Eigenschaften:

Positiver Eckmesserkopf für allgemeine Anwendungen mit einem genauen Einstellwinkel von 90° und stabilen Wendeschneidplatten, die hohe Schnitttiefen und einen hohen Vorschub pro Zahn erlauben.

Für konventionelle Fräsmaschinen und Bearbeitungszentren geeignet.

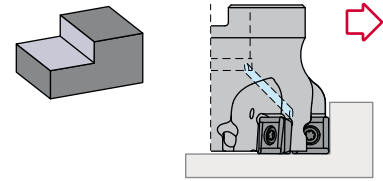

0255.93 90°

Reference Bezeichnung		D	L	d	l3	a	Insert size Wendeschneidplatte	
0255.93.040	4	40	40	16	18	11	SDMT 1205..	0,200
0255.93.050	5	50	40	22	20	11	SDMT 1205..	0,300
0255.93.063	6	63	50	27	22	11	SDMT 1205..	0,650
0255.93.080	7	80	50	27	22	11	SDMT 1205..	1,050
0255.93.100	8	100	50	32	25	11	SDMT 1205..	1,700
0255.93.125	9	125	63	40	30	11	SDMT 1205..	2,850

Reference Bezeichnung				Nm
0255.93.040	1240	5515	-	3.0
0255.93.050	1240	5515	-	3.0
0255.93.063	1240	5515	-	3.0
0255.93.080	1240	5515	-	3.0
0255.93.100	1240	-	5615	3.0
0255.93.125	1240	-	5615	3.0

SDMT

Square positive insert with 15° clearance. F17
Vierkantige positive Wendeschneidplatte mit 15° Freiwinkel.

Reference / Bez.	l	s	d
SDMT 1205..	12,35	5,00	12,35

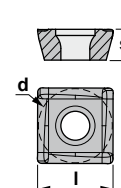

SDMT





Characteristics:
Positive milling cutter for diversified manufacture with an exact angle of 90° that uses very strong inserts allowing deep passes and high feed per teeth. Recommended for conventional milling machines and machining centers.

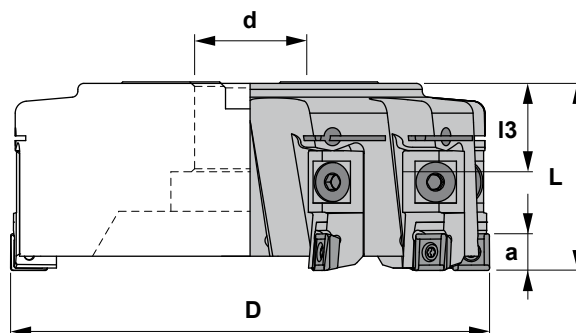

Eigenschaften:
Positiver Eckmesserkopf für allgemeine Anwendungen mit einem genauen Einstellwinkel von 90° und stabilen Wendeschneidplatten, die hohe Schnitttiefen und einen hohen Vorschub pro Zahn erlauben. Für konventionelle Fräsmaschinen und Bearbeitungszentren geeignet.

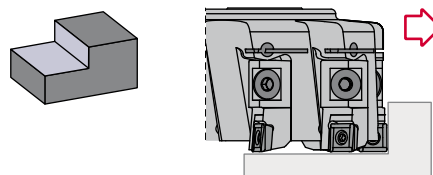

0255.99 90°

Reference Bezeichnung		D	L	d	l3	a	Insert size Wendeschneidplatte	
0255.99.160	10	160	63	40	30	11	SDMT 1205..	4,000
0255.99.200	12	200	63	60	40	11	SDMT 1205..	7,700
0255.99.250	16	250	63	60	40	11	SDMT 1205..	10,800
0255.99.315	20	315	63	60	40	11	SDMT 1205..	31,000
0255.99.400	22	400	63	60	40	11	SDMT 1205..	47,500
0255.99.500	28	500	63	60	40	11	SDMT 1205..	85,000

Reference Bezeichnung							DIN 2079	Nm
0255.99.160	1240	5615	6255	1788	1640	40	40	3.0
0255.99.200	1240	5615	6255	1788	1640	50	50	3.0
0255.99.250	1240	5615	6255	1788	1640	50	50	3.0
0255.99.315	1240	5615	6255	1788	1640	50/60	50/60	3.0
0255.99.400	1240	5615	6255	1788	1640	50/60	50/60	3.0
0255.99.500	1240	5615	6255	1788	1640	50/60	50/60	3.0

SDMT

Square positive insert with 15° clearance. F17
Vierkantige positive Wendeschneidplatte mit 15° Freiwinkel.

Reference / Bez.	l	s	d
SDMT 1205..	12,35	5,00	12,35

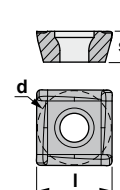

SDMT





Characteristics:
Milling cutter with convex radius.
It works well on steels, alloyed steels,
stainless steels and refractories.

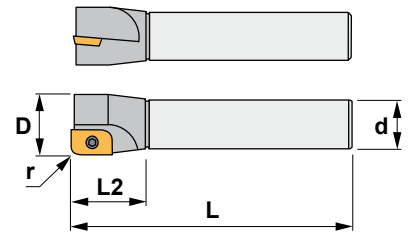

Eigenschaften:
Schaffräser mit konvexem Radius.
Für Stahl, legierten Stahl, rostfreien
Stahl und hitzebeständige Gußteile
empfohlen.

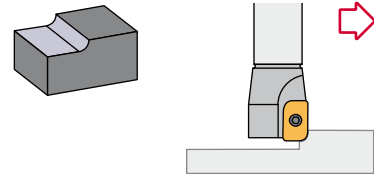

1135.01

Reference Bezeichnung		d	D	L	L2	r _{min}	r _{max}	Insert size Wendeschneidplatte	
1135.01.01610	1	16	16	120	35	1,0	3,0	ADMW-C 1503R1.0 / 3.0	0,200
1135.01.01635	1	16	16	120	35	3,5	6,0	ADMW-C 1503R3.5 / 6.0	0,200

Reference Bezeichnung			Nm
1135.01.01610	1440	5515	3.0
1135.01.01635	1440	5515	3.0

ADMW-C Parallelogram positive inserts with 15° clearance. Parallelogramme positive WSP mit 15° Freiwinkel. F10

Reference / Bezeichnung	r	s	d
ADMW 1503R1.0-C	1.00	3,18	9,52
ADMW 1503R1.5-C	1.50	3,18	9,52
ADMW 1503R2.0-C	2.00	3,18	9,52
ADMW 1503R2.5-C	2.50	3,18	9,52
ADMW 1503R3.0-C	3.00	3,18	9,52
ADMW 1503R3.5-C	3.50	3,18	9,52
ADMW 1503R4.0-C	4.00	3,18	9,52
ADMW 1503R4.5-C	4.50	3,18	9,52
ADMW 1503R5.0-C	5.00	3,18	9,52
ADMW 1503R6.0-C	6.00	3,18	9,52

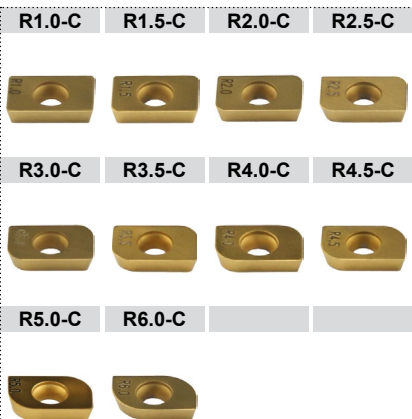
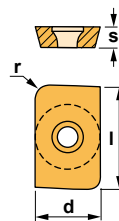



Characteristics:

Multi-function centre-cutting end mills for multiple applications: side milling, drilling and face milling.

For inserts CCKT.. see page F12.

Eigenschaften:

Multifunktions-Bohrnuten-Universalfräser zum Konturfräsen, Bohren und Nutenfräsen.

Wendeschneidplatten CCKT.. siehe Seite F12.

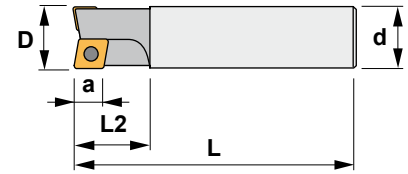

3314.0₁⁰

Reference Bezeichnung		D	d	L	L2	a	Insert size Wendeschneidplatte	
3314.00.012	1	12	16	100	25	5,0	CCKT 060204	0,120
3314.00.016	2	16	16	100	25	5,0	CCKT 060204 / 080308	0,160
3314.00.020	2	20	20	125	32	7,0	CCKT 080308 / 09T308	0,300
3314.00.025	2	25	25	125	40	7,6	CCKT 09T308 / 120408	0,480
3314.01.012	1	12	16	150	25	5,0	CCKT 060204	0,210
3314.01.016	2	16	16	175	25	5,0	CCKT 060204 / 080308	0,250
3314.01.020	2	20	20	175	32	7,0	CCKT 080308 / 09T308	0,400
3314.01.025	2	25	25	200	40	7,6	CCKT 09T308 / 120408	0,700

Reference Bezeichnung					Nm ¹	Nm ²
3314.00.012	1425	-	5507	-	0.9	-
3314.00.016	1425	1430	5507	5508	0.9	1.2
3314.00.020	1430	1440	5508	5515	1.2	3.0
3314.00.025	1440	1445	5515	5520	3.0	4.0
3314.01.012	1425	-	5507	-	0.9	-
3314.01.016	1425	1430	5507	5508	0.9	1.2
3314.01.020	1430	1440	5508	5515	1.2	3.0
3314.01.025	1440	1445	5515	5520	3.0	4.0



Characteristics:

Multi-function centre-cutting end mills for multiple applications: side milling, drilling and face milling.

For inserts CCKT.. see page F12.

Eigenschaften:

Multifunktions-Bohrnuten-Universalfräser zum Konturfräsen, Bohren und Nutenfräsen.

Wendeschneidplatten CCKT.. siehe Seite F12.

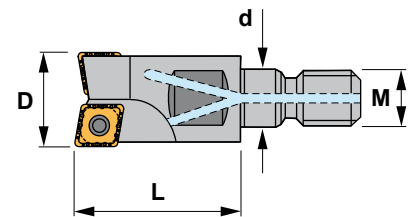

3314.06

Reference Bezeichnung		D	L	M	d	Insert size Wendeschneidplatte	
3314.06.012	1	12	23	M8	14	CCKT 060204	0,020
3314.06.016	2	16	23	M8	14	CCKT 060204 / 080308	0,030
3314.06.020	2	20	30	M10	18	CCKT 080308 / 09T308	0,060
3314.06.025	2	25	35	M12	21	CCKT 09T308 / 120408	0,095

Reference Bezeichnung					Nm ¹	Nm ²
3314.06.012	1425	-	5507	-	0.9	-
3314.06.016	1425	1430	5507	5508	0.9	1.2
3314.06.020	1430	1440	5508	5515	1.2	3.0
3314.06.025	1440	1245	5515	-	3.0	-





Characteristics:

Positive general milling cutter with 90° entering angle and short cylindric shank that uses standard triangular inserts. Recommended for conventional milling machines and machining centers. It allows to use TPUN and TPKN inserts.

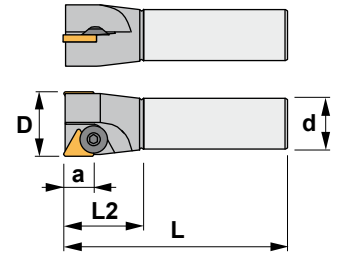

Eigenschaften:

Positiver Eckfräser mit einem Einstellwinkel von 90° und kurzem Zylinderschaft für dreikantige Standard-Wendeschneidplatten. Für konventionelle Fräsmaschinen und Bearbeitungszentren geeignet. Für TPUN und TPKN Wendeschneidplatten.

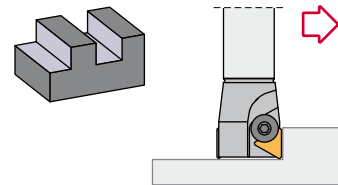

0120.00

Reference Bezeichnung		D	L	L2	d	a	Insert size Wendeschneidplatte	
0120.00.020	2	20	110	35	20	9	TP.. 1103..	0,250
0120.00.025	2	25	110	35	25	9	TP.. 1103..	0,400



Reference Bezeichnung				Nm
0120.00.020	1005	5025	2010	2.0
0120.00.025	1005	5025	2010	2.0

TP..				Triangular positive inserts with 11° clearance. F21-22		TPKN	
Reference / Bez.	l	s	d				
TP.. 1103..	11,00	3,18	6,35				

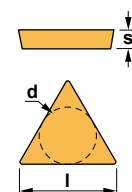



Characteristics:

Positive general milling cutter with 90° entering angle and short cylindrical shank that uses standard triangular inserts for diversified manufacture. Recommended for conventional milling machines and machining centers.

Eigenschaften:

Positiver Eckfräser mit einem Einstellwinkel von 90° und kurzem Zylinderschaft für dreikantige Standard-Wendeschneidplatten. Für konventionelle Fräsmaschinen und Bearbeitungszentren geeignet.

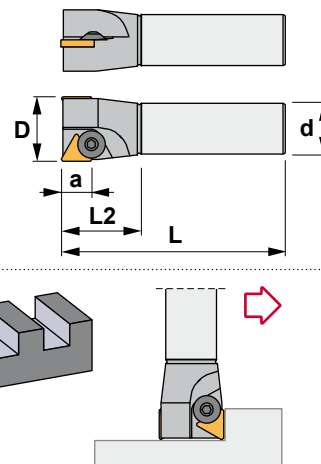

0130.00

Reference Bezeichnung		D	L	L2	d	a	Insert size Wendeschneidplatte	
0130.00.025	2	25	110	35	25	13	TP.. 1603..	0,350
0130.00.032	2	32	125	35	32	13	TP.. 1603..	0,700

Reference Bezeichnung				Nm
0130.00.025	1016	5004	2064	3.5
0130.00.032	1016	5004	2064	3.5



Characteristics:

Positive general milling cutter with 90° entering angle and Morse shank that uses standard triangular inserts for diversified manufacture. Recommended for conventional milling machines and machining centers.

Eigenschaften:

Positiver Eckfräser mit einem Einstellwinkel von 90° und Morse-Schaft für dreikantige Standard-Wendeschneidplatten. Für allgemeine Anwendungen in konventionellen Fräsmaschinen und Bearbeitungszentren geeignet.

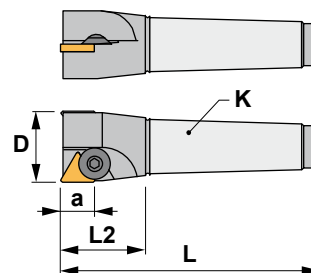

0130.30

Reference Bezeichnung		D	L	L2	a	K	Insert size Wendeschneidplatte	
0130.30.025	2	25	125	38	13	MK3	TP.. 1603..	0,300
0130.30.032	2	32	125	38	13	MK3	TP.. 1603..	0,350
0130.30.040	3	40	125	38	13	MK3	TP.. 1603..	0,450

Reference Bezeichnung				Nm
0130.30.025	1016	5004	2064	3.5
0130.30.032	1016	5004	2064	3.5
0130.30.040	1016	5004	2064	3.5

TP.. Triangular positive inserts with 11° clearance. Dreikantige positive Wendeschneidplatten mit 11° Freiwinkel. F21-22

Reference / Bez.	l	s	d
TP.. 1603..	16,50	3,18	9,52

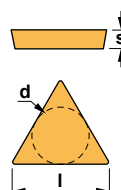

TPKN	TPKR
TPUN	



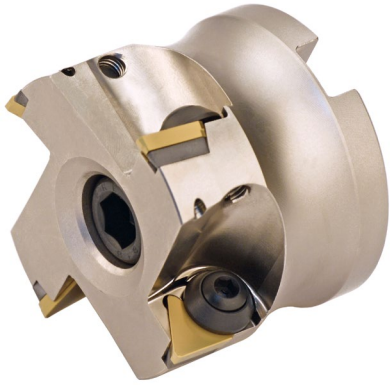

Characteristics:

Positive general milling cutter with an exact angle of 90° that uses very strong inserts allowing deep passes and high feed per teeth. Recommended for conventional milling machines and machining centers. It allows to use TPUN and TPKN inserts.

Axial 6°
Radial 1°

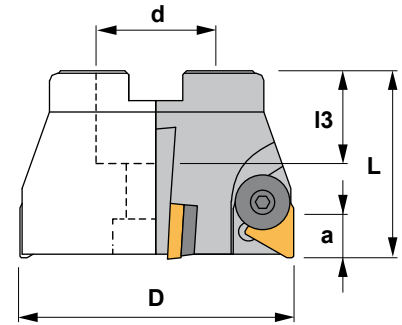

Eigenschaften:

Positiver Eckmesserkopf für allgemeine Anwendungen mit einem genauen Einstellwinkel von 90° und stabilen Wendeschneidplatten, die hohe Schnitttiefen und einen hohen Vorschub pro Zahn erlauben. Für konventionelle Fräsmaschinen und Bearbeitungszentren geeignet. Für TPUN und TPKN Wendeschneidplatten.

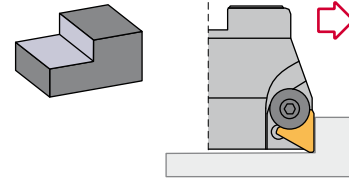

0130.90 90°

Reference Bezeichnung		D	L	d	l3	a	Insert size Wendeschneidplatte	
0130.90.040	3	40	40	16	18	13	TP.. 1603..	0,200
0130.90.050	4	50	40	22	20	13	TP.. 1603..	0,300
0130.90.050.Z=3	3	50	40	22	20	13	TP.. 1603..	0,350
0130.90.063	4	63	50	27	22	13	TP.. 1603..	0,650
0130.90.080	5	80	50	32	25	13	TP.. 1603..	1,050
0130.90.100	6	100	50	40	30	13	TP.. 1603..	1,650
0130.90.125	6	125	63	40	30	13	TP.. 1603..	2,850
0130.90.160	7	160	63	40	30	13	TP.. 1603..	4,400
0130.90.200	8	200	63	60	40	13	TP.. 1603..	8,250

Reference Bezeichnung								DIN 2079	Nm
0130.90.040	1006	5004	2064	-	-	1058	-	-	3.5
0130.90.050	1016	5004	2064	-	-	912,10	-	-	3.5
0130.90.050.Z=3	1006	5004	2064	-	-	912,10	-	-	3.5
0130.90.063	1006	5004	2064	3016	4016	912,12	-	-	3.5
0130.90.080	1006	5004	2064	3016	4016	912,16	-	-	3.5
0130.90.100	1006	5004	2064	3016	4016	912,20	-	-	3.5
0130.90.125	1006	5004	2064	3016	4016	-	-	-	3.5
0130.90.160	1006	5004	2064	3016	4016	912,52	40	-	3.5
0130.90.200	1006	5004	2064	3016	4016	912,56	50	-	3.5

TP.. Triangular positive inserts with 11° clearance. F21-22
Dreikantige positive Wendeschneidplatten mit 11° Freiwinkel.

Reference / Bez.	l	s	d
TP.. 1603..	16,50	3,18	9,52

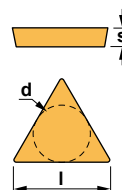

TPKN



TPKR



TPUN



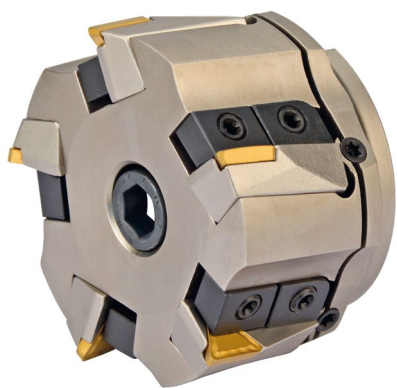

Characteristics:

Positive general milling cutter with an exact angle of 90° that uses very strong inserts allowing deep passes and high feed per teeth.

Recommended for conventional milling machines and machining centers. It allows to use TPUN and TPKN inserts.

Axial 7°
Radial -1°

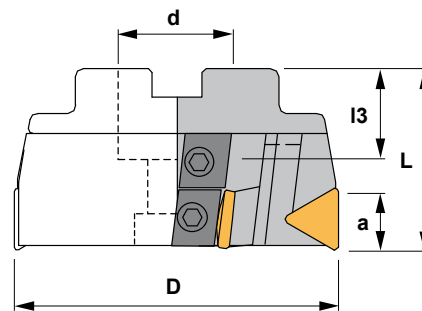

Eigenschaften:

Positiver Eckmesserkopf für allgemeine Anwendungen mit einem genauen Einstellwinkel von 90° und stabilen Wendeschneidplatten, die hohe Schnitttiefen und einen hohen Vorschub pro Zahn erlauben. Für konventionelle Fräsmaschinen und Bearbeitungszentren geeignet. Für TPUN und TPKN Wendeschneidplatten.

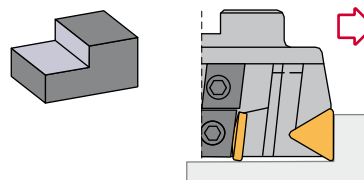

0130.99 90°

Reference Bezeichnung		D	L	d	l3	a	Insert size Wendeschneidplatte	
0130.99.052	5	52	50	16	18	13	TP.. 1603..	0,500
0130.99.063	6	63	50	22	20	13	TP.. 1603..	0,700
0130.99.080	5	80	50	27	22	13	TP.. 1603..	1,200
0130.99.100	7	100	50	32	25	13	TP.. 1603..	1,900
0130.99.125	7	125	63	40	30	13	TP.. 1603..	3,050
0130.99.160	9	160	63	40	30	13	TP.. 1603..	5,450
0130.99.200	11	200	63	60	40	13	TP.. 1603..	7,200
0130.99.250	15	250	63	60	40	13	TP.. 1603..	13,050

Reference Bezeichnung										Nm
0130.99.052	1166	5515	-	6031	6032	6526	1460	1058	-	3.0
0130.99.063	1166	5515	-	6031	6032	6526	1460	912,10	-	3.0
0130.99.080	1077	5520	-	6433	6435	6927	1460	912,12	-	4.0
0130.99.100	1077	-	5620	6433	6435	6927	1460	912,16	-	4.0
0130.99.125	1077	-	5620	6433	6435	6927	1460	-	-	4.0
0130.99.160	1077	-	5620	6433	6435	6927	1460	912,52	40	4.0
0130.99.200	1077	-	5620	6433	6435	6927	1460	912,56	50	4.0
0130.99.250	1077	-	5620	6433	6435	6927	1460	912,56	60	4.0

TP.. Triangular positive inserts with 11° clearance. F21-22
Dreikantige positive Wendeschneidplatten mit 11° Freiwinkel.

Reference / Bez.	l	s	d
TP.. 1603..	16,50	3,18	9,52

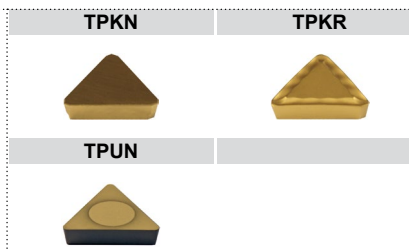
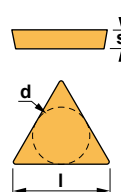

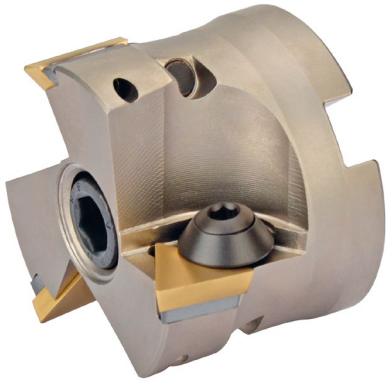

Characteristics:

Positive general milling cutter with an exact angle of 90° that uses very strong inserts allowing deep passes and high feed per teeth.

Recommended for conventional milling machines and machining centers.

It allows to use TPUN and TPKN inserts.

Axial 6°
Radial 1°

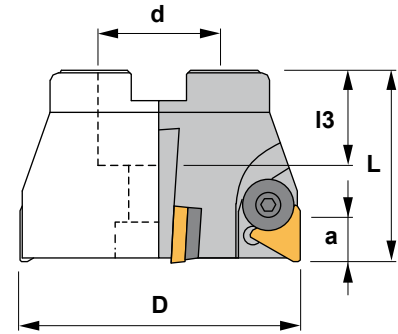

Eigenschaften:

Positiver Eckmesserkopf für allgemeine Anwendungen mit einem genauen Einstellwinkel von 90° und stabilen Wendeschneidplatten, die hohe Schnitttiefen und einen hohen Vorschub pro Zahn erlauben. Für konventionelle Fräsmaschinen und Bearbeitungszentren geeignet. Für TPUN und TPKN Wendeschneidplatten.

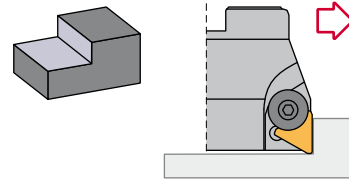

0140.90 90°

Reference Bezeichnung		D	L	d	l3	a	Insert size Wendeschneidplatte	
0140.90.063	3	63	50	27	22	18	TP.. 2204..	0,600
0140.90.080	4	80	50	32	25	18	TP.. 2204..	0,950
0140.90.100	5	100	50	40	30	18	TP.. 2204..	1,450
0140.90.125	6	125	63	40	30	18	TP.. 2204..	2,600
0140.90.160	7	160	63	40	30	18	TP.. 2204..	4,500
0140.90.200	8	200	63	60	40	18	TP.. 2204..	7,750

Reference Bezeichnung								DIN 2079	Nm
0140.90.063	1008	5005	2088	3022	4022	912,12	-	-	4.0
0140.90.080	1008	5005	2088	3022	4022	912,16	-	-	4.0
0140.90.100	1008	5005	2088	3022	4022	912,20	-	-	4.0
0140.90.125	1008	5005	2088	3022	4022	-	-	-	4.0
0140.90.160	1008	5005	2088	3022	4022	912,52	40	-	4.0
0140.90.200	1008	5005	2088	3022	4022	912,56	50	-	4.0

TP..

Triangular positive inserts with 11° clearance. F21-22
Dreikantige positive Wendeschneidplatten mit 11° Freiwinkel.

Reference / Bez.

TP.. 2204..

l

22,00

s

4,76

d

12,70

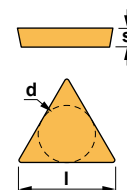

TPKN



TPUN



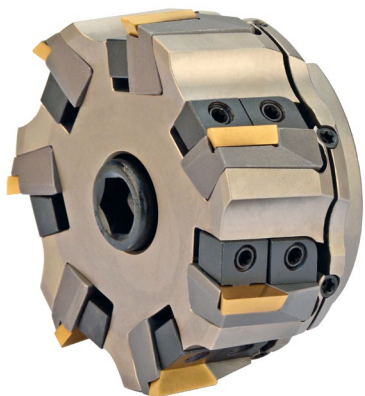

Characteristics:

Positive general milling cutter with an exact angle of 90° that uses very strong inserts allowing deep passes and high feed per teeth.

Recommended for conventional milling machines and machining centers. It allows to use TPUN and TPKN inserts.

Axial 7°
Radial -1°

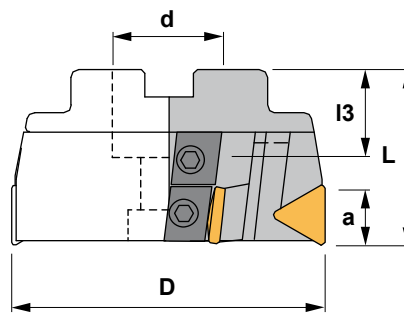

Eigenschaften:

Positiver Eckmesserkopf für allgemeine Anwendungen mit einem genauen Einstellwinkel von 90° und stabilen Wendeschneidplatten, die hohe Schnitttiefen und einen hohen Vorschub pro Zahn erlauben. Für konventionelle Fräsmaschinen und Bearbeitungszentren geeignet. Für TPUN und TPKN Wendeschneidplatten.

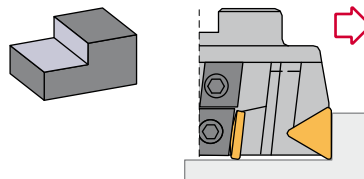

0140.99 90°

Reference Bezeichnung		D	L	d	l3	a	Insert size Wendeschneidplatte	kg
0140.99.080	5	80	50	27	22	18	TP.. 2204..	1,150
0140.99.100	7	100	50	32	25	18	TP.. 2204..	1,850
0140.99.125	7	125	63	40	30	18	TP.. 2204..	3,100
0140.99.160	9	160	63	40	30	18	TP.. 2204..	5,150
0140.99.200	11	200	63	60	40	18	TP.. 2204..	8,900
0140.99.250	15	250	63	60	40	18	TP.. 2204..	13,200

Reference Bezeichnung										DIN 2079	Nm
0140.99.080	1077	5520	-	6434	6436	6942	1460	912,12	-	-	4.0
0140.99.100	1077	-	5620	6434	6436	6942	1460	912,16	-	-	4.0
0140.99.125	1077	-	5620	6434	6436	6942	1460	-	-	-	4.0
0140.99.160	1077	-	5620	6434	6436	6942	1460	912,52	40	-	4.0
0140.99.200	1077	-	5620	6434	6436	6942	1460	912,56	50	-	4.0
0140.99.250	1077	-	5620	6434	6436	6942	1460	912,56	60	-	4.0

TP..

Triangular positive inserts with 11° clearance. F21-22
Dreikantige positive Wendeschneidplatten mit 11° Freiwinkel.

Reference / Bez.

l s d

TP.. 2204.. 22,00 4,76 12,70

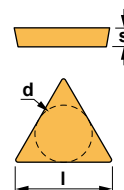

TPKN



TPUN



Cutting data for facing square shoulder cutters

Material	P	HB	Condition	Cutting speed m/min.					
				TIN25	TIN21	TIN28	PM25	PM40	TL40
				0.3-0.2-0.1	0.3-0.2-0.1	0.3-0.2-0.1	0.4-0.2-0.1	0.4-0.2-0.1	0.4-0.2-0.1
Unalloyed steel		110 150 310	C<0.25% C<0.80% C<1.40%	250-300-390 155-180-255 135-165-210	250-350-450 100-120-165 75-110-135	140-160-180 120-140-150 80-90-100	180-250-310 120-145-205 95-130-170	100-130-160 65-85-100 50-75-85	180-250-310 120-145-205 95-130-170
Low alloyed steel		125-225 220-450	Hardened	170-200-250 110-130-150	100-120-165 55-75-95	120-140-160 90-120-140	120-160-200 70-100-120	95-85-105 40-55-65	120-160-200 70-100-120
High alloyed steel		150-250 250-300	Hardened	140-170-225 90-110-150	90-115-150 60-75-90	60-80-90 55-60-70	110-140-180 65-90-120	60-80-90 40-50-60	110-140-180 65-90-120
High alloyed steel		150-250 250-300	High speed steel (HSS) Hardened Hardened tool steel	130-160-195	75-105-130	60-65-70	90-125-155 70-95-120	50-60-75 30-40-50	90-125-155 70-95-120
Stainless steel		150-270	Ferritic, Martensitic	155-180-250	110-150-190	130-180-220	120-165-210	80-105-130	120-165-210
Steel castings		150 150-250 160-200	Unalloyed Low alloyed High alloyed	140-180-250 125-150-190 90-110-130	80-120-150 70-100-120 55-70-80	60-80-90 55-60-70	100-145-180 90-120-150 65-90-100	60-75-95 50-65-80 35-45-55	100-145-180 90-120-150 65-90-100
Stainless steel castings		150-250	Ferritic, martensitic		50-80	60-65-70	50-70-80	30-40-50	50-70-80

Material	M	HB	Condition	Cutting speed m/min.				
				TIN25	TIN21	TIN28	KM15	PM25
				0.4-0.2-0.1	0.3-0.2-0.1	0.4-0.2-0.1	0.2-0.1	0.4-0.2-0.1
Stainless steel annealed		150-220	Austenitic	180-220-280	80-150-220	130-180-220		150-240-300
Steel castings		200	Stainless, austenitic		40-70	80-120-160		50-60
Iron, nickel and cobalt base castings		180-300 220-300 220-300			40-100	70-120-140	20-40 20-40 10-20	
Titanium alloys		300-400				40-80		

Material	K	HB	Condition	Cutting speed m/min.				
				TIN25	TIN21	TIN28	KM15	PM25
				0.4-0.2-0.1	0.3-0.2-0.1	0.4-0.2-0.1	0.2-0.1	0.4-0.2-0.1
Tempered steel		HCR 50-65						15-20-30
Stainless steel castings		250	Manganese steel 12-14% Mn				12-18-20	
Malleable cast iron		110-145 200-230	Short chipping Long chipping		200-300 150-200	180-330	65-80-95 50-65-80	100-125-150 90-115-135
Grey cast iron		180 260	Low tensile strength High tensile strength		200-400 150-350	130-240 110-200	70-95-120 50-70-90	85-120-155 70-90-115
Nodular cast iron		160 250	Ferritic Pearlitic	100-130 90-110	100-250 100-180	70-140 60-120	50-65-80 45-60-70	70-90-115 65-80-100
Chilled cast iron		HCR 40-60						
Aluminium alloys		60-100 75-110	Non cast Cast				500-2100 400-2000	
Aluminium with high contents of Si			10-14% Si 14-16% Si 16-18% Si				200-1000 110-200	

Schnittdaten für Eckfräser

Materialien	P	HB	Beschaffenheit	Schnittgeschwindigkeit m/min.					
				TIN25	TIN21	TIN28	PM25	PM40	TL40
				0.3-0.2-0.1	0.3-0.2-0.1	0.3-0.2-0.1	0.4-0.2-0.1	0.4-0.2-0.1	0.4-0.2-0.1
Unlegierter Stahl	110 150 310	C<0.25% C<0.80% C<1.40%	250-300-390 155-180-255 135-165-210	250-350-450 100-120-165 75-110-135	140-160-180 120-140-150 80-90-100	180-250-310 120-145-205 95-130-170	100-130-160 65-85-100 50-75-85	180-250-310 120-145-205 95-130-170	
Niedrig legierter Stahl	125-225 220-450	Vergütet	170-200-250 110-130-150	100-120-165 55-75-95	120-140-160 90-120-140	120-160-200 70-100-120	95-85-105 40-55-65	120-160-200 70-100-120	
Hochlegierter Stahl	150-250 250-300	Vergütet	140-170-225 90-110-150	90-115-150 60-75-90	60-80-90 55-60-70	110-140-180 65-90-120	60-80-90 40-50-60	110-140-180 65-90-120	
Hochlegierter Stahl	150-250 250-300	Schnellstahl (HSS) Vergütet Gehärterter Werkzeugstahl	130-160-195	75-105-130	60-65-70	90-125-155 70-95-120	50-60-75 30-40-50	90-125-155 70-95-120	
Rostfreier Stahl	150-270	Ferritisch, Martensitisch	155-180-250	110-150-190	130-180-220	120-165-210	80-105-130	120-165-210	
Stahlguß	150 150-250 160-200	Unlegiert Niedrig legiert Hochlegiert	140-180-250 125-150-190 90-110-130	80-120-150 70-100-120 55-70-80	60-80-90 55-60-70	100-145-180 90-120-150 65-90-100	60-75-95 50-65-80 35-45-55	100-145-180 90-120-150 65-90-100	
Rostfreier Stahlguß	150-250	Ferritisch, martensitisch		50-80	60-65-70	50-70-80	30-40-50	50-70-80	

Materialien	M	HB	Beschaffenheit	Schnittgeschwindigkeit m/min.				
				TIN25	TIN21	TIN28	KM15	PM25
				0.4-0.2-0.1	0.3-0.2-0.1	0.4-0.2-0.1	0.2-0.1	0.4-0.2-0.1
Rostfreier Stahl, gegläht	150-220	Austenitisch	180-220-280	80-150-220	130-180-220		150-240-300	
Stahlguß	200	Rostfrei, austenitisch		40-70	80-120-160		50-60	
Eisen- Nickel- und Kobalthaltiger Guß	180-300 220-300 220-300			40-100	70-120-140	20-40 20-40 10-20		
Titan-Legierungen	300-400				40-80			

Materialien	K	HB	Beschaffenheit	Schnittgeschwindigkeit m/min.				
				TIN25	TIN21	TIN28	KM15	PM25
				0.4-0.2-0.1	0.3-0.2-0.1	0.4-0.2-0.1	0.2-0.1	0.4-0.2-0.1
Vergüteter Stahl	HCR 50-65						15-20-30	
Rostfreier Stahlguß	250	Manganstahl 12-14% Mn				12-18-20		
Temperguß	110-145 200-230	Kurzspanend Langspanend		200-300 150-200	180-330	65-80-95 50-65-80	100-125-150 90-115-135	
Grauguß	180 260	Niedrige Zugfestigkeit Hohe Zugfestigkeit		200-400 150-350	130-240 110-200	70-95-120 50-70-90	85-120-155 70-90-115	
Kugelgraphitguß	160 250	Ferritisch Perlitisch	100-130 90-110	100-250 100-180	70-140 60-120	50-65-80 45-60-70	70-90-115 65-80-100	
Kokillenhartguß	HCR 40-60							
Aluminium-Legierungen	60-100 75-110	Nicht gegossen Gegossen				500-2100 400-2000		
Aluminium-Legierungen mit hohem Si-Gehalt		10-14% Si 14-16% Si 16-18% Si				200-1000 110-200		

Cutting data for Drill-Mill cutters

Material	P	HB	Condition	Tool diameter (D mm.)	Basic grades				Feed/tooth complete slot f_2
					TIN25	PM25	PM40	TL40	
					Cutting speed m/min.				
Unalloyed steel		110 170 250	C=0.25% C=0.8% C=1.4%	12-16 20 25 32 40	180-230 120-150 80-130	150-200 100-140 70-110	100-150 80-120 60-100	150-200 100-140 70-110	0,02-0,11 0,11-0,14 0,12-0,18 0,15-0,21 0,18-0,24
Low alloyed steel		125-225 220-450	Annealed Hardened	12-16 20 25 32 40	100-150 60-110	90-140 60-110	70-110 45-80	90-140 60-110	0,02-0,11 0,11-0,14 0,12-0,18 0,15-0,21 0,18-0,24
High alloyed steel		150-250 250-500	Annealed Hardened	12-16 20 25 32 40	80-120	80-120 50-80	60-100 40-70	80-120 50-80	0,02-0,11 0,11-0,14 0,12-0,18 0,15-0,21 0,18-0,24
Stainless steel		150-270	Ferritic / martensitic	12-16 20 25 32 40	120-160	100-130	60-100	100-130	0,02-0,11 0,11-0,14 0,12-0,18 0,15-0,21 0,18-0,24
Steel castings		150 150-220 160-200	Unalloyed Low alloyed High alloyed	12-16 20 25 32 40		80-110 50-90 50-80	70-100 40-80 40-70	80-110 50-90 50-80	0,02-0,11 0,11-0,14 0,12-0,18 0,15-0,21 0,18-0,24
Stainless steel castings		200	Ferritic / martensitic	12-16 20 25 32 40	50-80	40-70	35-60	40-70	0,02-0,11 0,11-0,14 0,12-0,18 0,15-0,21 0,18-0,24

Material	M	HB	Condition	Tool diameter (D mm.)	Basic grades				Feed/tooth complete slot f_2
					TIN25	PM25	PM40	KM15	
					Cutting speed m/min.				
Stainless steel		150-220	Austenitic	12-16 20 25 32 40	80-160	70-130	55-90		0,02-0,11 0,11-0,14 0,12-0,18 0,15-0,21 0,18-0,24
Stainless steel castings		200	Austenitic	12-16 20 25 32 40	40-70	40-60	35-55		0,02-0,11 0,11-0,14 0,12-0,18 0,15-0,21 0,18-0,24

Material	K	HB	Condition	Tool diameter (D mm.)	Basic grades				Feed/tooth complete slot f_2
					TIN25	PM25	PM40	KM15	
					Cutting speed m/min.				
Malleable cast iron		110-145 200-230	Short chipping Long chipping	12-16 20 25 32 40				90-120 80-100	0,02-0,11 0,11-0,14 0,12-0,18 0,15-0,21 0,18-0,24
Grey cast iron		180 260	Low tensile strength High tensile strength	12-16 20 25 32 40				60-120 50-100	0,02-0,11 0,11-0,14 0,12-0,18 0,15-0,21 0,18-0,24
Nodular cast iron Spheroidal graphite		160 250	Ferritic Pearlitic	12-16 20 25 32 40				50-80 40-70	0,02-0,11 0,11-0,14 0,12-0,18 0,15-0,21 0,18-0,24
Aluminium		60-150 40-180	Forged Cast	12-16 20 25 32 40				300-500 250-450	0,02-0,11 0,11-0,14 0,12-0,18 0,15-0,21 0,18-0,24
Bronze-brass alloys		60-150		12-16 20 25 32 40				80-120	0,02-0,11 0,11-0,14 0,12-0,18 0,15-0,21 0,18-0,24



D/a_e	50	40	20	10	5	2,5	2	1,5	1
f_1	4,5	4	3	2	1,5	1	1	1	1

When you trace a contour (side peripheral milling), you must multiply the f_2 value of a complete slot (see table) by the correction factor f_1 corresponding to the relationship D/a_e (milling cutter diameter/radial cutting depth) in order to get a suitable feed.

Schnittdaten für Fräser-Bohrer

Materialien	P	HB	Beschaffenheit	Werkzeug- durchmesser (D mm.)	Hauptsorten				Vorschub/Zahn (komplette Nut) f ₂
					TIN25	PM25	PM40	TL40	
					Schnittgeschwindigkeit m/min.				
Unlegierter Stahl		110 170 250	C=0.25% C=0.8% C=1.4%	12-16 20 25 32 40	180-230 120-150 80-130	150-200 100-140 70-110	100-150 80-120 60-100	150-200 100-140 70-110	0,02-0,11 0,11-0,14 0,12-0,18 0,15-0,21 0,18-0,24
Niedrig legierter Stahl		125-225 220-450	Geglüht Vergütet	12-16 20 25 32 40	100-150 60-110	90-140 60-110	70-110 45-80	90-140 60-110	0,02-0,11 0,11-0,14 0,12-0,18 0,15-0,21 0,18-0,24
Hochlegierter Stahl		150-250 250-500	Geglüht Vergütet	12-16 20 25 32 40	80-120	80-120 50-80	60-100 40-70	80-120 50-80	0,02-0,11 0,11-0,14 0,12-0,18 0,15-0,21 0,18-0,24
Rostfreier Stahl		150-270	Ferritisch/Martensitisch	12-16 20 25 32 40	120-160	100-130	60-100	100-130	0,02-0,11 0,11-0,14 0,12-0,18 0,15-0,21 0,18-0,24
Stahlguß		150 150-220 160-200	Unlegiert Niedrig legiert Hochlegiert	12-16 20 25 32 40		80-110 50-90 50-80	70-100 40-80 40-70	80-110 50-90 50-80	0,02-0,11 0,11-0,14 0,12-0,18 0,15-0,21 0,18-0,24
Rostfreier Stahlguß		200	Ferritisch/Martensitisch	12-16 20 25 32 40	50-80	40-70	35-60	40-70	0,02-0,11 0,11-0,14 0,12-0,18 0,15-0,21 0,18-0,24

Materialien	M	HB	Beschaffenheit	Werkzeug- durchmesser (D mm.)	Hauptsorten				Vorschub/Zahn (komplette Nut) f ₂
					TIN25	PM25	PM40	KM15	
					Schnittgeschwindigkeit m/min.				
Rostfreier Stahl		150-220	Austenitisch	12-16 20 25 32 40	80-160	70-130	55-90		0,02-0,11 0,11-0,14 0,12-0,18 0,15-0,21 0,18-0,24
Rostfreier Stahlguß		200	Austenitisch	12-16 20 25 32 40	40-70	40-60	35-55		0,02-0,11 0,11-0,14 0,12-0,18 0,15-0,21 0,18-0,24

Materialien	K	HB	Beschaffenheit	Werkzeug- durchmesser (D mm.)	Hauptsorten				Vorschub/Zahn (komplette Nut) f ₂
					TIN25	PM25	PM40	KM15	
					Schnittgeschwindigkeit m/min.				
Temperguß		110-145 200-230	Kurzspanend Langspanend	12-16 20 25 32 40				90-120 80-100	0,02-0,11 0,11-0,14 0,12-0,18 0,15-0,21 0,18-0,24
Grauguß		180 260	Niedrige Zugfestigkeit Hohe Zugfestigkeit	12-16 20 25 32 40				60-120 50-100	0,02-0,11 0,11-0,14 0,12-0,18 0,15-0,21 0,18-0,24
Kugelgraphitguß		160 250	Ferritisch Perlitisch	12-16 20 25 32 40				50-80 40-70	0,02-0,11 0,11-0,14 0,12-0,18 0,15-0,21 0,18-0,24
Aluminium		60-150 40-180	Geschmiedet Gegossen	12-16 20 25 32 40				300-500 250-450	0,02-0,11 0,11-0,14 0,12-0,18 0,15-0,21 0,18-0,24
Bronze- und Messing-Legierungen		60-150		12-16 20 25 32 40				80-120	0,02-0,11 0,11-0,14 0,12-0,18 0,15-0,21 0,18-0,24



D/a_e	50	40	20	10	5	2,5	2	1,5	1
f₁	4,5	4	3	2	1,5	1	1	1	1

Wenn man eine Kontur fräst (seitlich-peripherisches Fräsen), muss man den f₂ Wert von einer kompletten Nut (siehe Tabelle) durch den Korrekturfaktor f₁ welcher die Beziehung D/a_e entspricht (Durchmesser des Fräsers/Radiale Schnitttiefe) multiplizieren, damit man einen geeigneten Vorschub erhält.



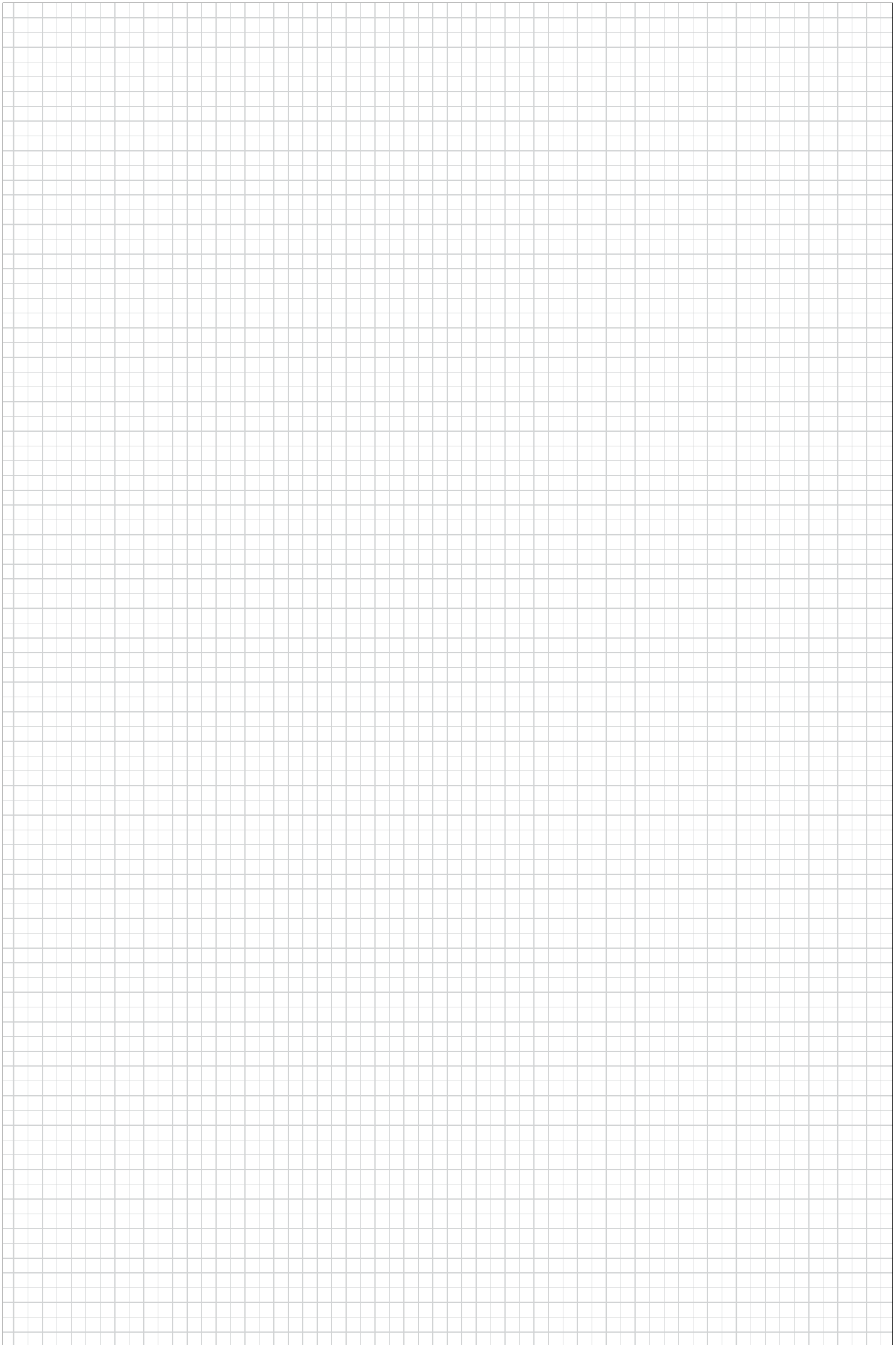

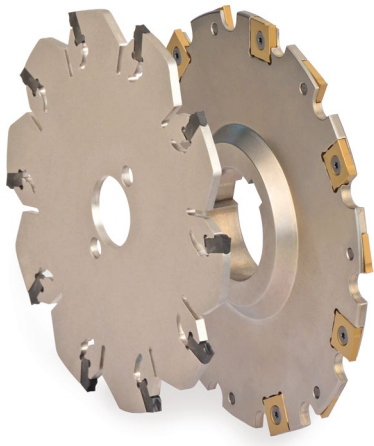

SLOT CUTTERS NUTENFRÄSER

Code system Kodifizierung	F102
Applications index Anwendungen	F103
T-Slot cutters T-Nutenfräser	F104-105
Slot cutters Scheibenfräser	F106-112
Drive-rings Mitnehmerringe	F113
Cutting data Schnittdaten	F114-115



F

Code system / Kodifizierung

15	3	0	90	100	R
1	2	3	4	5	6

1 Milling cutter type Fräsertyp

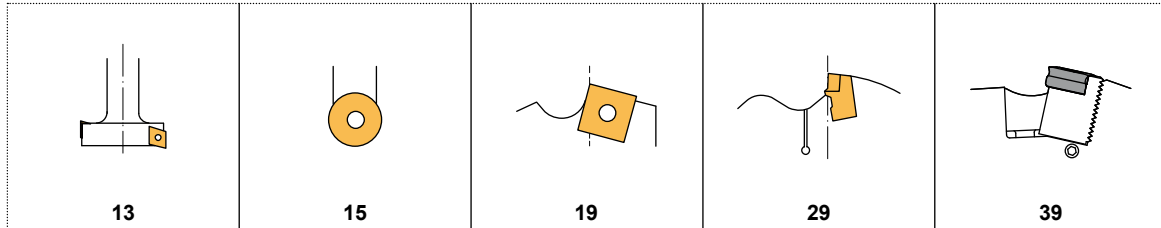

2 Insert size Wendeschneidplattengröße

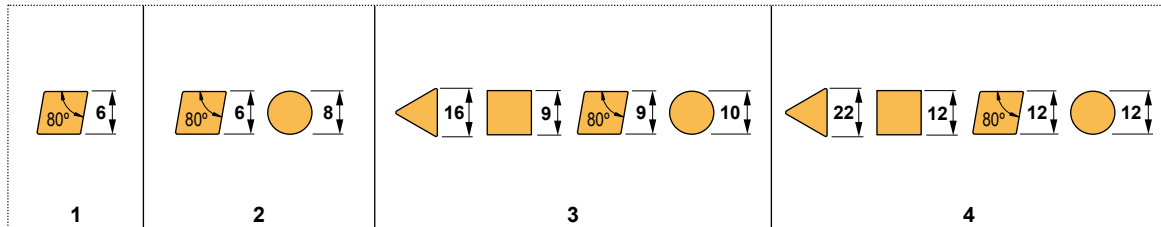

3 Clearance angle of insert Freiwinkel der Wendeschneidplatte

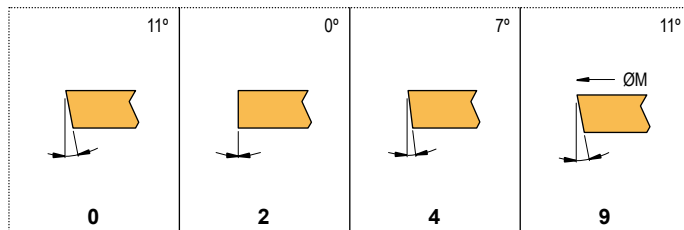

4 Type of coupling Aufnahmetyp

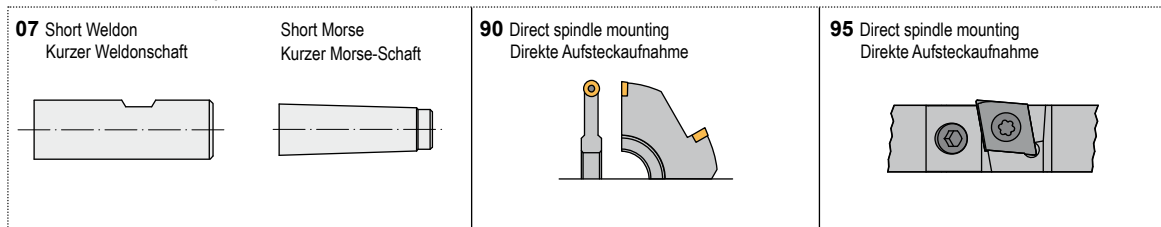

5 Diameter, mm. Durchmesser, mm.

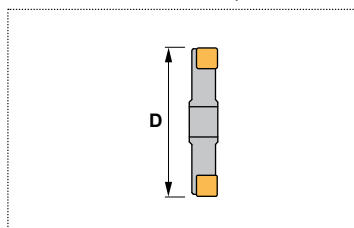

6* Cutting hand Schneidrichtung

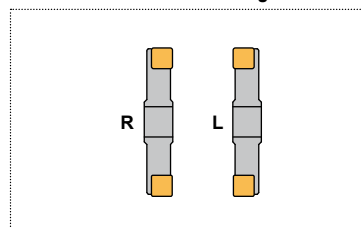

6** Cutting width Schnittbreite

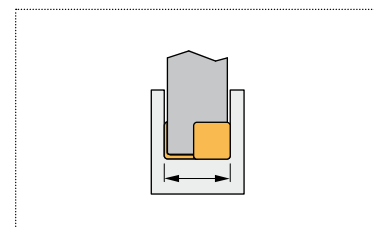

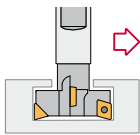
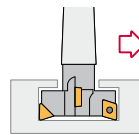

T-Slot cutters
T-Nutenfräser

<p>1314.07 T Slots 90° T-Nuten 90°</p>  <p>Page CC.. 0602.. Seite F104 CC.. 1204..</p>	<p>1314.30 T Slots 90° T-Nuten 90°</p>  <p>Page CC.. 0602.. Seite F105 CC.. 1204..</p>			
--	--	--	--	--

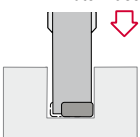
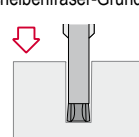
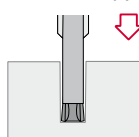
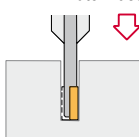
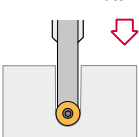
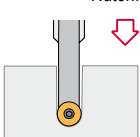
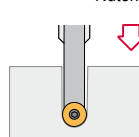
Slot cutters
Scheibenfräser

<p>3942.95 Slot milling 90° Nutenfräsen 90°</p>  <p>Page ENHQ 0904.. Seite F106 ENHQ 1206..</p>	<p>2942.90 Cutter blade body Scheibenfräser-Grundkörper</p>  <p>Page FRC.. 1,6 Seite F107 FRC.. 6,0</p>	<p>2942.07 Circular miller Zirkularfräsen</p>  <p>Page FRC.. 2,2 Seite F108 FRC.. 4,0</p>	<p>1942.90 Slot milling 89° Nutenfräsen 89°</p>  <p>Page SNHX 1102.. Seite F109 SNHX 1207..</p>	<p>1520.90 Slot milling Nutenfräsen</p>  <p>Page RPMW 0802.. Seite F110</p>
<p>1530.90 Slot milling Nutenfräsen</p>  <p>Page RPMW 1003.. Seite F111</p>	<p>1549.90 Slot milling Nutenfräsen</p>  <p>Page RPMW 1204.. Seite F112</p>			

Drive-rings
Mitnehmerringe

<p>M Drive-rings Mitnehmerringe</p>  <p>Page RPMW 1003.. Seite F111</p>	<p>MN Drive-rings Mitnehmerringe</p>  <p>Page RPMW 1204.. Seite F112</p>			
---	--	--	--	--



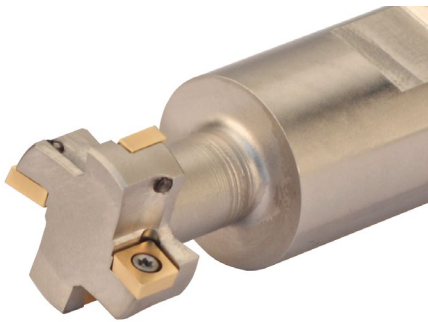

Characteristics:

T-Slot cutter with positive chip forming for all kind of materials.

It works well on steels, alloyed steels, stainless steel, refractory casts and aluminium alloys.

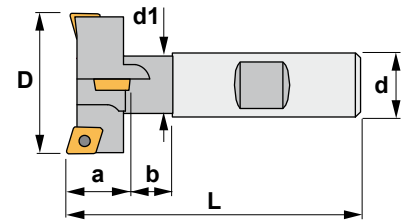

Eigenschaften:

T-Nutenfräser mit positiver Spanbildung für Materialien aller Sorten.

Für Stahl, legierten Stahl, rostfreien Stahl, hitzebeständige Gußteile und Aluminium-Legierungen empfohlen.

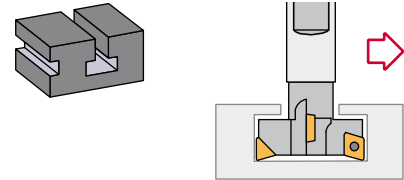

1314.07

Reference Bezeichnung		D	L	d	d1	a	b	Insert size Wendeschneidplatte	
1314.07.025.11	2+2	25	85	25	12	11	17	CC.. 0602..	0,250
1324.07.032.14	2+2	32	95	25	15	14	22	CC.. 0803..	0,300
1334.07.040.18	2+2	40	105	25	19	18	27	CC.. 09T3..	0,350
1344.07.050.22	2+2	50	120	32	25	22	34	CC.. 1204..	0,700

Reference Bezeichnung			Nm
1314.07.025.11	1225	5507	0.9
1324.07.032.14	1230	5508	1.2
1334.07.040.18	1240	5515	3.0
1344.07.050.22	1250	5520	4.0

CC..

80° rhombic positive inserts with 7° clearance. F12
80° rhombische positive Wendeschneidplatten mit 7° Freiwinkel.

Reference / Bez.	l	s	d
CC.. 0602..	6,45	2,38	6,35
CC.. 0803..	8,05	3,18	7,94
CC.. 09T3..	9,65	3,97	9,52
CC.. 1204..	12,90	4,76	12,70

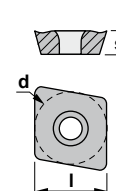

CCGT-AL



CCMW



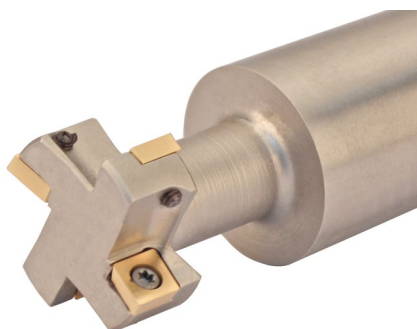

Characteristics:

T-Slot cutter with positive chip forming for all kind of materials.

It works well on steels, alloyed steels, stainless steel, refractory casts and aluminium alloys.

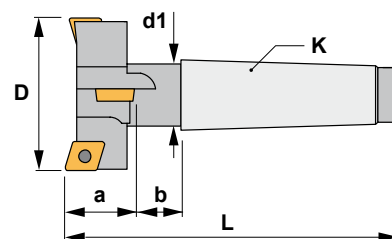

Eigenschaften:

T-Nutenfräser mit positiver Spanbildung für Materialien aller Sorten.

Für Stahl, legierten Stahl, rostfreien Stahl, hitzebeständige Gußteile und Aluminium-Legierungen empfohlen.

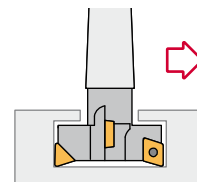
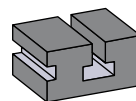

**13₄14.30
4.34**

Reference Bezeichnung		D	L	K	d1	a	b	Insert size Wendeschneidplatte	
1314.30.025.11	2+2	25	125	MK3	12	11	17	CC.. 0602..	0,275
1324.30.032.14	2+2	32	125	MK3	15	14	22	CC.. 0803..	0,300
1334.30.040.18	2+2	40	134	MK3	19	18	27	CC.. 09T3..	0,350
1344.34.050.22	2+2	50	165	MK3	25	22	34	CC.. 1204..	0,750

Reference Bezeichnung			Nm
1314.30.025.11	1225	5507	0.9
1324.30.032.14	1230	5508	1.2
1334.30.040.18	1240	5515	3.0
1344.34.050.22	1250	5520	4.0

CC..

80° rhombic positive inserts with 7° clearance. F12
80° rhombische positive Wendeschneidplatten mit 7° Freiwinkel.

Reference / Bez.

l

s

d

CC.. 0602..

6,45

2,38

6,35

CC.. 0803..

8,05

3,18

7,94

CC.. 09T3..

9,65

3,97

9,52

CC.. 1204..

12,90

4,76

12,70

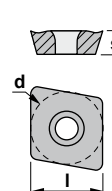

CCGT-AL



CCMW





Characteristics:

Slot cutter with an angle of 90° that uses strong inserts allowing deep passes and high feed per teeth. Suitable for flat bottom applications.

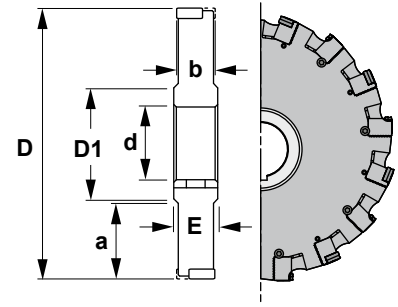

Eigenschaften:

Scheibenfräser mit einem Eingriffswinkel von 90° und stabilen Wendeschneidplatten, die hohe Schnitttiefen und einen hohen Vorschub pro Zahn erlauben. Geeignet für geraden Nutgrund.

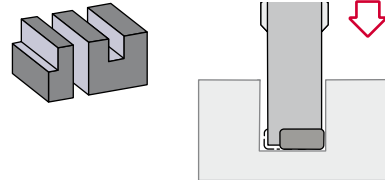

3942.95

Reference Bezeichnung		D	b min	b max	d	D1	E	a			R/L	Insert size Wendeschneidplatte	kg
3942.95.100.14	4	100	14,0	17,5	32	47	16,0	25,5	6112	1266	6938-6939	ENHQ 0904..	0,100
3942.95.125.14	5	125	14,0	17,5	40	55	16,0	34,0	6112	1066	6938-6939	ENHQ 0904..	0,900
3942.95.160.14	6	160	14,0	17,5	40	55	16,0	51,5	6112	1066	6938-6939	ENHQ 0904..	1,800
3942.95.200.14	8	200	14,0	17,5	50	69	16,0	64,5	6112	1066	6938-6939	ENHQ 0904..	2,600
3942.95.100.17,5	3	100	17,5	20,5	32	47	18,5	25,5	6113	1188	6940-6941	ENHQ 1206..	0,760
3942.95.125.17,5	4	125	17,5	20,5	40	55	18,5	34,0	6113	1888	6940-6941	ENHQ 1206..	1,130
3942.95.160.17,5	5	160	17,5	20,5	40	55	18,5	51,5	6113	1888	6940-6941	ENHQ 1206..	1,000
3942.95.200.17,5	6	200	17,5	20,5	50	69	18,5	64,5	6113	1888	6940-6941	ENHQ 1206..	3,700
3942.95.250.17,5	8	250	17,5	20,5	50	69	18,5	89,5	6113	1888	6940-6941	ENHQ 1206..	6,850
3942.95.315.17,5	10	315	17,5	20,5	60	84	18,5	114,5	6113	1888	6940-6941	ENHQ 1206..	7,000
3942.95.125.20,5	4	125	20,5	23,5	40	55	21,5	34,0	6113	1888	6940-6941	ENHQ 1206..	1,400
3942.95.160.20,5	5	160	20,5	23,5	40	55	21,5	51,5	6113	1888	6940-6941	ENHQ 1206..	2,530
3942.95.200.20,5	6	200	20,5	23,5	50	69	21,5	64,5	6113	1888	6940-6941	ENHQ 1206..	3,640
3942.95.250.20,5	8	250	20,5	23,5	50	69	21,5	89,5	6113	1888	6940-6941	ENHQ 1206..	1,000
3942.95.315.20,5	10	315	20,5	23,5	50	84	21,5	114,5	6113	1888	6940-6941	ENHQ 1206..	7,000

ENHQ

75° rhombic negative insert.
75° rhombische negative Wendeschneidplatte. **i** F13

Reference / Bezeichnung

l

s

d

ENHQ 090408R/L

9,86

4,76

9,52

ENHQ 120610R/L

13,15

6,35

12,70

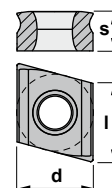

ENHQ





Characteristics:

Side milling cutter blade body.
Self-clamping tool with double prism and fixed reference point. The special shape of the chip groove in the insert slot allows a continuous chip flow.

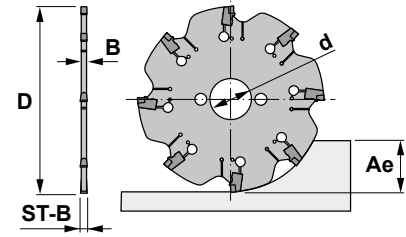

Eigenschaften:

Zirkularfräser.
Selbstklemmendes Werkzeug mit Doppelprisma und absolutem Festpunkt. Die besondere Form der Spanleitstufe in der Nut erlaubt einen kontinuierlichen Spanfluß.

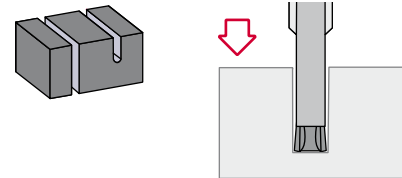

2942.90

Reference Bezeichnung		ST-B	B	D	d	Ae	Rev max. min-1 Umdrehungen max. min-1		Insert size Wendeschneidplatte	
2942.90.0801.2	4	1.6	1.2	80	16	22	1000	5733	FRC.. 1,6	0,045
2942.90.0801.8	4	2.2	1.8	80	16	22	1000	5733	FRC.. 2,2	0,070
2942.90.0802.4	4	3.0	2.4	80	16	22	1000	5733	FRC.. 3,0	0,090
2942.90.0803.0	4	4.0	3.0	80	16	22	1000	5733	FRC.. 4,0	0,115
2942.90.0804.4	4	5.0+6.0	4.4	80	16	22	1000	5733	FRC.. 5,0-6,0	0,165
2942.90.1001.2	8	1.6	1.2	100	22	28	800	5733	FRC.. 1,6	0,070
2942.90.1001.8	8	2.2	1.8	100	22	28	800	5733	FRC.. 2,2	0,105
2942.90.1002.4	8	3.0	2.4	100	22	28	800	5733	FRC.. 3,0	0,130
2942.90.1003.0	8	4.0	3.0	100	22	28	800	5733	FRC.. 4,0	0,175
2942.90.1004.4	8	5.0+6.0	4.4	100	22	28	800	5733	FRC.. 5,0-6,0	0,260
2942.90.1251.2	10	1.6	1.2	125	22	40	650	5733	FRC.. 1,6	0,110
2942.90.1251.8	10	2.2	1.8	125	22	40	650	5733	FRC.. 2,2	0,170
2942.90.1252.4	10	3.0	2.4	125	22	40	650	5733	FRC.. 3,0	0,220
2942.90.1253.0	10	4.0	3.0	125	22	40	650	5733	FRC.. 4,0	0,280
2942.90.1254.4	10	5.0+6.0	4.4	125	22	40	650	5733	FRC.. 5,0-6,0	0,410
2942.90.1602.4	15	3.0	2.4	160	32	49	500	5733	FRC.. 3,0	0,360
2942.90.1603.0	15	4.0	3.0	160	32	49	500	5733	FRC.. 4,0	0,450
2942.90.1604.4	15	5.0+6.0	4.4	160	32	49	500	5733	FRC.. 5,0-6,0	0,660
2942.90.2002.4	20	3.0	2.4	200	40	63	400	5733	FRC.. 3,0	0,570
2942.90.2003.0	20	4.0	3.0	200	40	63	400	5733	FRC.. 4,0	0,700
2942.90.2004.4	20	5.0+6.0	4.4	200	40	63	400	5733	FRC.. 5,0-6,0	1,040
2942.90.2502.4	24	3.0	2.4	250	40	88	300	5733	FRC.. 3,0	0,900
2942.90.2503.0	24	4.0	3.0	250	40	88	300	5733	FRC.. 4,0	1,125
2942.90.2504.4	24	5.0+6.0	4.4	250	40	88	300	5733	FRC.. 5,0-6,0	1,650

FRC..

Single-ended inserts.
Einseitige Wendeschneidplatten. F13

Reference / Bez.	s	r
FRC 1,6	1,6	0,15
FRC 2,2	2,2	0,20
FRC 3,0	3,0	0,20
FRC 4,0	4,0	0,20
FRC 5,0	5,0	0,30
FRC 6,0	6,0	0,30
FRCR 3,0	3,0	1,50
FRCR 4,0	4,0	2,00
FRCR 5,0	5,0	2,50
FRCR 6,0	6,0	3,00

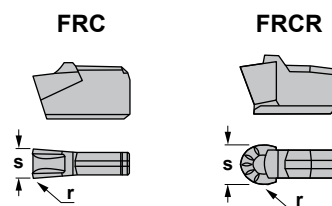

FRC



FRCR



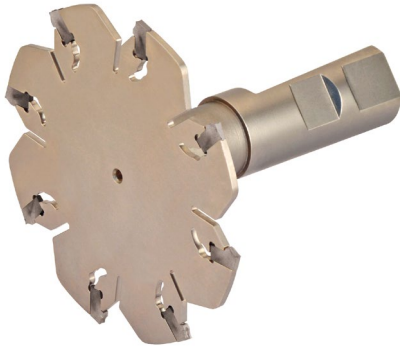

Characteristics:

Circular miller.
Self-clamping tool with double prism and fixed reference point.
Inserts can be changed in less than 10 seconds per insert without removing the cutter from the machine. The inserts are released from the prism with the help of the included assembly-key.

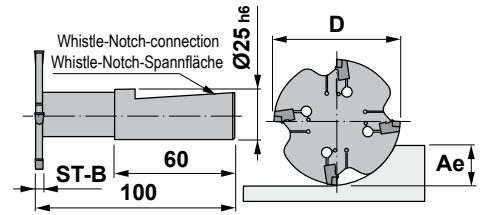

Eigenschaften:

Zirkularfräser.
Selbstklemmendes Werkzeug mit Doppelprisma und absolutem Festpunkt.
Das Austauschen der Wendeschneidplatten dauert pro Schneide kaum 10 Sekunden und kann in der Maschine, ohne Demontage des Scheibenfräasers vorgenommen werden.
Die Wendeschneidplatte wird mit Hilfe des mitgelieferten Montageschlüssels aus dem Prisma gelöst.

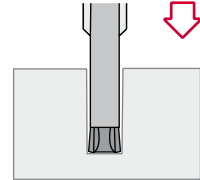
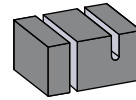

2942.07

Reference Bezeichnung		ST-B	B	D	Ae	Rev max. Umdrehungen max.	Insert size Wendeschneidplatte	
2942.07.0631.8	4	2,2	1,8	63	20	1250	FRC.. 2,2	0,370
2942.07.0632.4	4	3,0	2,4	63	20	1250	FRC.. 3,0	0,385
2942.07.0633.0	4	4,0	3,0	63	20	1250	FRC.. 4,0	0,400
2942.07.0801.8	5	2,2	1,8	80	26	1000	FRC.. 2,2	0,405
2942.07.0802.4	5	3,0	2,4	80	26	1000	FRC.. 3,0	0,430
2942.07.0803.0	5	4,0	3,0	80	26	1000	FRC.. 4,0	0,460
2942.07.1001.8	8	2,2	1,8	100	36	800	FRC.. 2,2	0,445
2942.07.1002.4	8	3,0	2,4	100	36	800	FRC.. 3,0	0,480
2942.07.1003.0	8	4,0	3,0	100	36	800	FRC.. 4,0	0,520

Reference Bezeichnung	
2942.07.0631.8	5733
2942.07.0632.4	5733
2942.07.0633.0	5733
2942.07.0801.8	5733
2942.07.0802.4	5733
2942.07.0803.0	5733
2942.07.1001.8	5733
2942.07.1002.4	5733
2942.07.1003.0	5733

FRC..

Single-ended inserts.
Einseitige Wendeschneidplatten. F13

Reference / Bez.	s	r
FRC 2,2	2,2	0,20
FRC 3,0	3,0	0,20
FRC 4,0	4,0	0,20
FRCR 3,0	3,0	1,50
FRCR 4,0	4,0	2,00

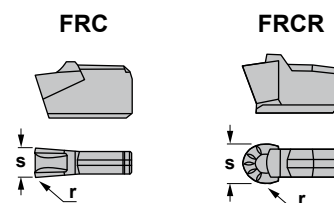

FRC



FRCR





Characteristics:

Slot cutter with an angle of 92° that uses strong inserts allowing deep passes and high feed per teeth. Positive chip forming inserts are available to machine sticky materials.

Warning!! Not suitable for flat bottom applications.

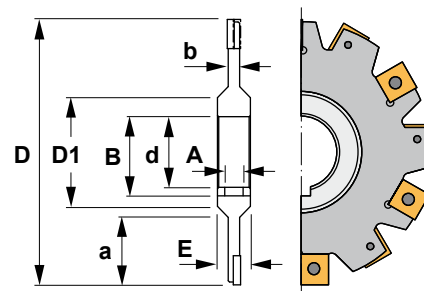

Eigenschaften:

Scheibenfräser mit einem Eingriffswinkel von 92° und starken Wendeschneidplatten, die hohe Schnittiefen und einen hohen Vorschub pro Zahn erlauben.

Wendeschneidplatten mit positivem Spanwinkel sind geeignet, um klebende Materialien zu bearbeiten.

Achtung! Nicht geeignet für geraden Nutgrund.

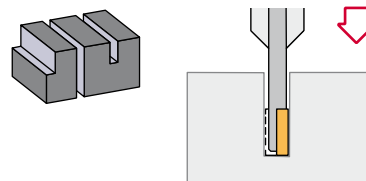

1942.90

Reference Bezeichnung		D	b	d	A	B	D1	E	a			Insert size Wendeschneidplatte	
1942.90.100.04	12	100	4	27	7	29,8	41	12	25	1735	5607	SNHX 1102..	0,200
1942.90.125.04	14	125	4	32	8	34,8	48	12	40	1735	5607	SNHX 1102..	0,350
1942.90.100.05	12	100	5	27	7	29,8	41	12	25	1835	5607	SNHX 1103..	0,250
1942.90.125.05	14	125	5	32	8	34,8	48	12	40	1835	5607	SNHX 1103..	0,400
1942.90.160.05	18	160	5	40	10	43,5	58	12	44	1835	5607	SNHX 1103..	0,650
1942.90.100.06	10	100	6	27	7	29,8	41	12	25	1745	5615	SNHX 1203..	0,300
1942.90.125.06	12	125	6	32	8	34,8	48	12	40	1745	5615	SNHX 1203..	0,450
1942.90.160.06	16	160	6	40	10	43,5	58	12	44	1745	5615	SNHX 1203..	0,750
1942.90.200.06	18	200	6	50	12	53,8	72	12	54	1745	5615	SNHX 1203..	1,150
1942.90.250.06	24	250	6	50	12	53,8	72	12	79	1745	5615	SNHX 1203..	1,800
1942.90.100.08	10	100	8	27	7	29,8	41	12	25	1846	5615	SNHX 12045..	0,350
1942.90.125.08	12	125	8	32	8	34,8	48	12	40	1846	5615	SNHX 12045..	0,550
1942.90.160.08	16	160	8	40	10	43,5	58	12	44	1846	5615	SNHX 12045..	0,950
1942.90.200.08	18	200	8	50	12	53,8	72	12	54	1846	5615	SNHX 12045..	1,550
1942.90.250.08	24	250	8	50	12	53,8	72	12	79	1846	5615	SNHX 12045..	2,400
1942.90.100.10	10	100	10	27	7	29,8	41	12	25	1845	5615	SNHX 1205..	0,400
1942.90.125.10	12	125	10	32	8	34,8	48	12	40	1845	5615	SNHX 1205..	0,700
1942.90.160.10	16	160	10	40	10	43,5	58	12	44	1845	5615	SNHX 1205..	1,150
1942.90.200.10	18	200	10	50	12	53,8	72	12	54	1845	5615	SNHX 1205..	1,900
1942.90.250.10	24	250	10	50	12	53,8	72	12	79	1845	5615	SNHX 1205..	3,050
1942.90.100.12	10	100	12	27	7	29,8	41	16	25	1847	5615	SNHX 1207..	0,500
1942.90.125.12	12	125	12	32	8	34,8	48	16	40	1847	5615	SNHX 1207..	0,850
1942.90.160.12	16	160	12	40	10	43,5	58	16	44	1847	5615	SNHX 1207..	1,400
1942.90.200.12	18	200	12	50	12	53,8	72	16	54	1847	5615	SNHX 1207..	2,350
1942.90.250.12	24	250	12	50	12	53,8	72	16	79	1847	5615	SNHX 1207..	3,750

SNHX			
Square negative insert. Vierkantige negative Wendeschneidplatte.			
Reference / Bez.	l	s	d
SNHX 1102..	11,00	2,38	11,00
SNHX 1103..	11,00	2,70	11,00
SNHX 1203..	12,70	3,18	12,70
SNHX 12045..	12,70	4,50	12,70
SNHX 1205..	12,70	5,40	12,70
SNHX 1207..	12,70	7,00	12,70

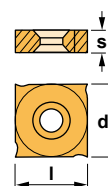



Characteristics:

Slot cutter that uses round strong inserts allowing deep passes and high feed per teeth. Positive chip forming inserts are available to machine sticky materials.

It works well on steels, alloyed steels, stainless steel, refractory casts and aluminium alloys.

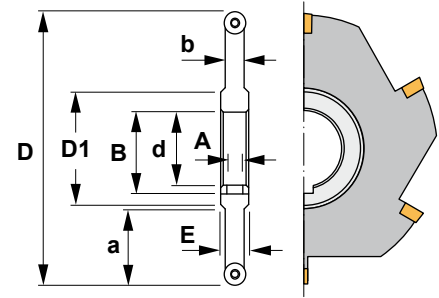

Eigenschaften:

Dieser Scheibenfräser hat starke runde Wendeschneidplatten, die hohe Schnitttiefen und einen hohen Vorschub pro Zahn erlauben. Wendeschneidplatten mit positivem Spanwinkel sind geeignet um klebende Materialien zu bearbeiten.

Für Stahl, legierten Stahl, rostfreien Stahl, hitzebeständige Gußteile und Aluminium-Legierungen empfohlen.

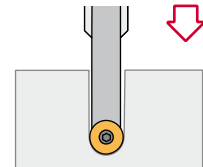
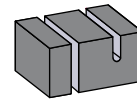

1520.90

Reference Bezeichnung		D	b	d	A	B	D1	E	a	Insert size Wendeschneidplatte	
1520.90.050	5	50	8	16	4	18,0	28	10	10	RPMW 0802M0	0,065
1520.90.063	6	63	8	22	6	24,5	35	10	12	RPMW 0802M0	0,100
1520.90.080	7	80	8	22	6	24,5	35	10	20	RPMW 0802M0	0,200
1520.90.100	8	100	8	27	7	29,8	41	10	28	RPMW 0802M0	0,300
1520.90.125	9	125	8	32	8	34,8	48	10	39	RPMW 0802M0	0,550
1520.90.160	10	160	8	40	10	43,5	58	10	49	RPMW 0802M0	0,850
1520.90.200	12	200	8	50	12	53,8	72	10	60	RPMW 0802M0	1,450

Reference Bezeichnung				Nm
1520.90.050	1230	5508	-	1.2
1520.90.063	1230	5508	-	1.2
1520.90.080	1230	5508	-	1.2
1520.90.100	1230	-	5608	1.2
1520.90.125	1230	-	5608	1.2
1520.90.160	1230	-	5608	1.2
1520.90.200	1230	-	5608	1.2

RPMW

Round positive insert with 11° clearance. F16
Runde positive Wendeschneidplatte mit 11° Freiwinkel.

Reference / Bezeichnung	s	d
RPMW 0802M0	2,38	8,00

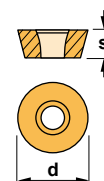

RPMW





Characteristics:

Slot cutter that uses round strong inserts allowing deep passes and high feed per teeth. Positive chip forming inserts are available to machine sticky materials.

It works well on steels, alloyed steels, stainless steel, refractory casts and aluminium alloys.

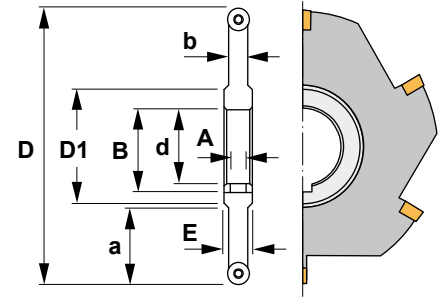

Eigenschaften:

Dieser Scheibenfräser hat starke runde Wendeschneidplatten, die hohe Schnitttiefen und einen hohen Vorschub pro Zahn erlauben. Wendeschneidplatten mit positivem Spanwinkel sind geeignet um klebende Materialien zu bearbeiten.

Für Stahl, legierten Stahl, rostfreien Stahl, hitzebeständige Gußteile und Aluminium-Legierungen empfohlen.

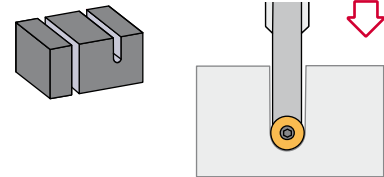

1530.90

Reference Bezeichnung		D	b	d	A	B	D1	E	a	Insert size Wendeschneidplatte	
1530.90.050	5	50	10	16	4	18,0	28	12	10	RPMW 1003M0	0,060
1530.90.063	5	63	10	22	6	24,5	35	12	12	RPMW 1003M0	0,100
1530.90.080	6	80	10	22	6	24,5	35	12	20	RPMW 1003M0	0,150
1530.90.100	7	100	10	27	7	29,8	41	12	28	RPMW 1003M0	0,350
1530.90.125	8	125	10	32	8	34,8	48	12	39	RPMW 1003M0	0,650
1530.90.160	9	160	10	40	10	43,5	58	12	49	RPMW 1003M0	1,100
1530.90.200	10	200	10	50	12	53,8	72	12	60	RPMW 1003M0	1,750
1530.90.250	12	250	10	50	12	53,8	72	12	86	RPMW 1003M0	2,800

Reference Bezeichnung				Nm
1530.90.050	1440	5515	-	3.0
1530.90.063	1240	5515	-	3.0
1530.90.080	1240	5515	-	3.0
1530.90.100	1240	-	5615	3.0
1530.90.125	1240	-	5615	3.0
1530.90.160	1240	-	5615	3.0
1530.90.200	1240	-	5615	3.0
1530.90.250	1240	-	5615	3.0

RPMW

Round positive insert with 11° clearance. Runde positive Wendeschneidplatte mit 11° Freiwinkel. F16

Reference / Bezeichnung

s

d

RPMW 1003M0

3,18

10,00

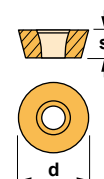

RPMW





Characteristics:

Slot cutter that uses round strong inserts allowing deep passes and high feed per teeth. Positive chip forming inserts are available to machine sticky materials.

It works well on steels, alloyed steels, stainless steel, refractory casts and aluminium alloys.

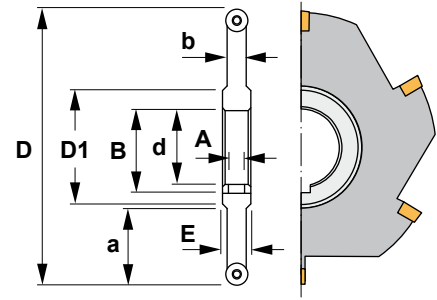

Eigenschaften:

Dieser Scheibenfräser hat starke runde Wendeschneidplatten, die hohe Schnitttiefen und einen hohen Vorschub pro Zahn erlauben. Wendeschneidplatten mit positivem Spanwinkel sind geeignet um klebende Materialien zu bearbeiten.

Für Stahl, legierten Stahl, rostfreien Stahl, hitzebeständige Gußteile und Aluminium-Legierungen empfohlen.

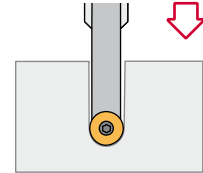
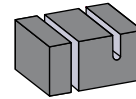

1549.90

Reference Bezeichnung		D	b	d	A	B	D1	E	a	Insert size Wendeschneidplatte	
1549.90.080	6	80	12	22	6	24,5	35	14	20	RPMW 1204M0	0,250
1549.90.100	7	100	12	27	7	29,8	41	14	28	RPMW 1204M0	0,400
1549.90.125	8	125	12	32	8	34,8	48	14	39	RPMW 1204M0	0,750
1549.90.160	9	160	12	40	10	43,5	58	14	49	RPMW 1204M0	1,200
1549.90.200	10	200	12	50	12	53,8	72	14	60	RPMW 1204M0	1,900
1549.90.250	12	250	12	50	12	53,8	72	14	86	RPMW 1204M0	3,250

Reference Bezeichnung				Nm
1549.90.080	1240	5515	-	3.0
1549.90.100	1240	-	5615	3.0
1549.90.125	1240	-	5615	3.0
1549.90.160	1240	-	5615	3.0
1549.90.200	1240	-	5615	3.0
1549.90.250	1240	-	5615	3.0

RPMW

Round positive insert with 11° clearance. F16
Runde positive Wendeschneidplatte mit 11° Freiwinkel.

Reference / Bezeichnung	s	d
RPMW 1204M0	4,76	12,00

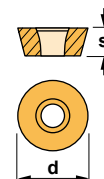

RPMW





Characteristics:
Drive-rings (set) with
cross groove.
For 2942.90 milling cutters.

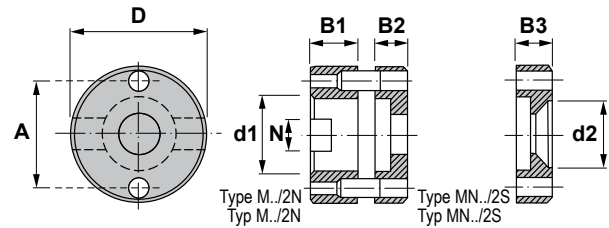

Eigenschaften:
Mitnehmerringe (Satz) mit
Quernut.
Für Scheibenfräser 2942.90.

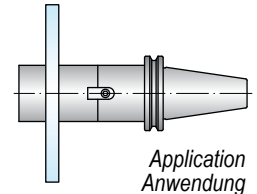

M

Reference Bezeichnung	D	d1	d2	A	B1	B2	B3	N	For side milling cutter Für Scheibenfräser	kg
M 16/2 N	32	16	10	25	13,5	10	-	8,4	80	0,130
M 22/2 N	40	22	12	32	14,5	10	-	10,4	100-125	0,200
M 32/2 N	58	32	18	46	17,5	15	-	14,4	160	0,590
M 40/2 N	70	40	22	56	19,5	17	-	16,4	200-250	0,820
M 16/2 S	32	16	10	25	13,5	-	10	8,4	80	0,125
M 22/2 S	40	22	12	32	14,5	-	10	10,4	100-125	0,190
M 32/2 S	58	32	18	46	17,5	-	15	14,4	160	0,570
M 40/2 S	70	40	22	56	19,5	-	17	16,4	200-250	0,800

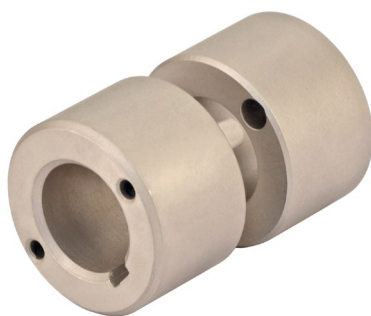

Characteristics:
Drive-rings (set) with
longitudinal groove.
For 2942.90 milling cutters.

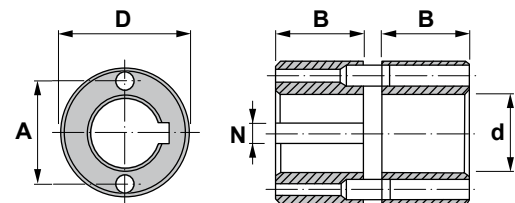

Eigenschaften:
Mitnehmerringe (Satz) mit
Längsnut.
Für Scheibenfräser 2942.90.

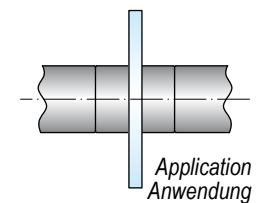

MN

Reference Bezeichnung	D	d	A	B	N	For side milling cutter Für Scheibenfräser	kg
MN 16/2	32	16	25	25	4	80	0,240
MN 22/2	40	22	32	25	6	100-125	0,340
MN 32/2	58	32	46	25	8	160	0,720
MN 40/2	70	40	56	25	10	200-250	1,010



Cutting data for slot side and face milling cutters

Cutting speed nominal values

Material	P	HB	Basic grades			
			TIN25	PM25	KM15	TL40
			Cutting speed m/min.			
Unalloyed steel		90-250	100-210	80-180		80-180
Low alloyed steel		130-400	50-150	50-140		50-140
High alloyed steel		150-500	30-90	40-90		40-90
Martensitic, Stainless steel ferritic		150-270	100-200	80-130		80-130
Steel castings		150-200	60-130	40-90		40-90

Material	M	HB	Basic grades			
			TIN25	PM25	KM15	TL40
			Cutting speed m/min.			
Austenitic, Stainless steel		150-270	80-180	50-120		20-50
Titanium		300-450			20-80	

Material	K	HB	Basic grades			
			TIN25	PM25	KM15	TL40
			Cutting speed m/min.			
Malleable cast iron		110-230			60-90	
Grey cast iron		180-260			80-120	
Nodular cast iron		160-250			60-80	
Aluminium alloys					200-600	
Bronze and brass alloys		60-150			70-150	

Machining example

Working piece

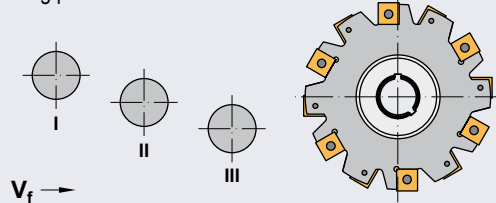

Examples

I
II
III

Average chip thickness (h_m) mm

0,08 - 0,09
0,08
0,07 - 0,08

Example I: $f_z \sim h_m$

$$\text{Example III: } f_z = h_m \sqrt{\frac{D}{a_e}}$$

Example II: f_z must be calculated between examples I and II

f_z = Feed per tooth

D = Milling cutter diameter

a_e = Radial cutting depth

h_m = Average chip thickness

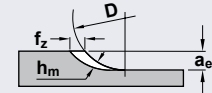

Feed nominal values

Depending on the milling cutter situation and in relationship with its diameter and the cutting depth, the average chip thickness (h_m) can considerably vary, but it will always be smaller than the feed per tooth.

When you mill a groove, the feed is distributed between two stepped inserts, which are symmetrically spaced one at each side of the milling cutter, forming together the slot. Therefore, when you use the formulae, the z value (number of teeth) must always be divided by two.

Cutting data for slot side and face milling cutters

Cutting speed nominal values - h_m 0,05-0,12

Material	P	HB	TIN25	PM25	TL40
			Cutting speed m/min.		
			Unalloyed steel	110-310	140-240
Low alloyed steel		125-450	130-210	85-180	85-180
High alloyed steel		150-500	120-80	60-120	60-120
Stainless		150-270			
Steel castings		150-250	130-210	55-115	55-115

Material	M	HB	TIN25	TL40
			Cutting speed m/min.	
			Austenitic, Stainless steel	40-90
Titanium		20-80		

Material	K	HB	KM15	PM25
			Cutting speed m/min.	
			Malleable cast iron	110-230
Grey cast iron		180-260	80-120	60-120
Nodular cast iron-S. graphite		160-250	60-80	40-80
Aluminium alloys		30-100	200-600	
Bronze and brass alloys		60-150	70-150	

Feed nominal values

The chip average thickness (h_m) must be 0,10 mm.

This corresponds to a feed per tooth of 0,3 mm in most of the operations made by a side and face milling cutter.

If the radial cutting depth (a_2) is too small compared with the milling cutter diameter, use the following formula:

$$f_z = 0,10 \sqrt{\frac{D}{a_e}}$$

NOTE:

In order to calculate the table feeds, use the half of the inserts in a three cut milling cutter and a face milling cutter in order to get the effective number of teeth.

Table feed = rpm x number of effective teeth x f_z

Schnittdaten für Scheiben- und Nutenfräser

Nennwerte der Schnittgeschwindigkeit

Materialien	P	HB	Hauptsorten			
			TIN25	PM25	KM15	TL40
			Schnittgeschwindigkeit M/min.			
Unlegierter Stahl		90-250	100-210	80-180		80-180
Niedriglegierter Stahl		130-400	50-150	50-140		50-140
Hochlegierter Stahl		150-500	30-90	40-90		40-90
Martensitisch, rostfreier Stahl, ferritisch		150-270	100-200	80-130		80-130
Stahlguß		150-200	60-130	40-90		40-90

Materialien	M	HB	Hauptsorten			
			TIN25	PM25	KM15	TL40
			Schnittgeschwindigkeit M/min.			
Austenitisch, rostfreier Stahl		150-270	80-180	50-120		20-50
Titan		300-450			20-80	

Materialien	K	HB	Hauptsorten			
			TIN25	PM25	KM15	TL40
			Schnittgeschwindigkeit M/min.			
Temperguß		110-230			60-90	
Grauguß		180-260			80-120	
Kugelgraphitguß		160-250			60-80	
Aluminium-Legierungen					200-600	
Bronze- und Messinglegierungen		60-150			70-150	

Bearbeitungsbeispiel

Werkstück

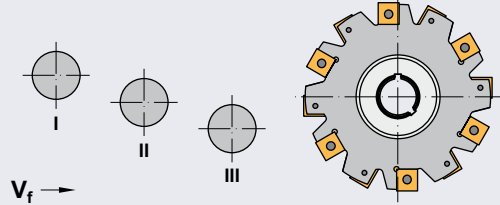

Beispiele

Durchschnittliche Dicke der Späne (h_m) mm

I	0,08 - 0,09
II	0,08
III	0,07 - 0,08

Beispiel I: $f_z \sim h_m$

$$\text{Beispiel III: } f_z = h_m \sqrt{\frac{D}{a_e}}$$

Beispiel II: f_z soll zwischen Beispiel I und Beispiel II kalkuliert werden

f_z = Vorschub pro Zahn

D = Durchmesser des Fräasers

a_e = Radiale Schnitttiefe

h_m = Durchschnittliche Spandicke

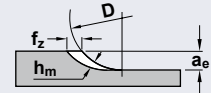

Nennwerte des Vorschubs

Die durchschnittliche Spandicke (h_m) kann erheblich variieren, es kommt auf die Situation des Fräasers und seine Beziehung mit dem Durchmesser und der Schnitttiefe an, aber sie wird immer kleiner als der Vorschub pro Zahn sein.

Wenn man eine Nut fräst, ist der Vorschub zwischen zwei gestuften Wendepunkten ausgeteilt, eine auf jeder Seite des Fräasers, die zusammen die Nute bilden. Deswegen muß der Wert z (Zähnezahl) immer durch zwei geteilt werden, wenn man diese Formel verwendet.

Schnittdaten für Nuten- Kontur- und Planfräser

Nennwerte der Schnittgeschwindigkeit - h_m 0,05-0,12

Materialien	P	HB	TIN25	PM25	TL40
			Schnittgeschwindigkeit M/min.		
			Unlegierter Stahl	110-310	140-240
Niedriglegierter Stahl		125-450	130-210	85-180	85-180
Hochlegierter Stahl		150-500	120-80	60-120	60-120
Rostfreier Stahl		150-270			
Stahlguß		150-250	130-210	55-115	55-115

Materialien	M	HB	TIN25	TL40
			Schnittgeschwindigkeit M/min.	
			Austenitisch, rostfreier Stahl	40-90
Titan		20-80		

Materialien	K	HB	KM15	PM25
			Schnittgeschwindigkeit M/min.	
			Temperguß	110-230
Grauguß		180-260	80-120	60-120
Kugelgraphitguß-S. Graphit		160-250	60-80	40-80
Aluminium-Legierungen		30-100	200-600	
Bronze- und Messinglegierungen		60-150	70-150	

Nennwerte des Vorschubs

Die durchschnittliche Dicke der Späne (h_m) muss 0,10 mm sein.

Das entspricht einem Vorschub pro Zahn von 0,3 mm, gültig für die meisten Anwendungsfälle für einen Nutenfräser.

Falls die Radialschnitttiefe (a_2) zu klein im Vergleich mit dem Fräserdurchmesser ist, sollte man folgende Formel verwenden:

$$f_z = 0,10 \sqrt{\frac{D}{a_e}}$$

BEMERKUNG:

Um den Vorschub zu berechnen, beachten Sie, daß Sie bei einem dreiseitig schneidenden Werkzeug die halbe Zähnezahl und bei einem einseitig schneidenden Werkzeug die volle Zähnezahl verwenden müssen.

Frästisch-Vorschub = rpm x effektive Zähnezahl x f_z

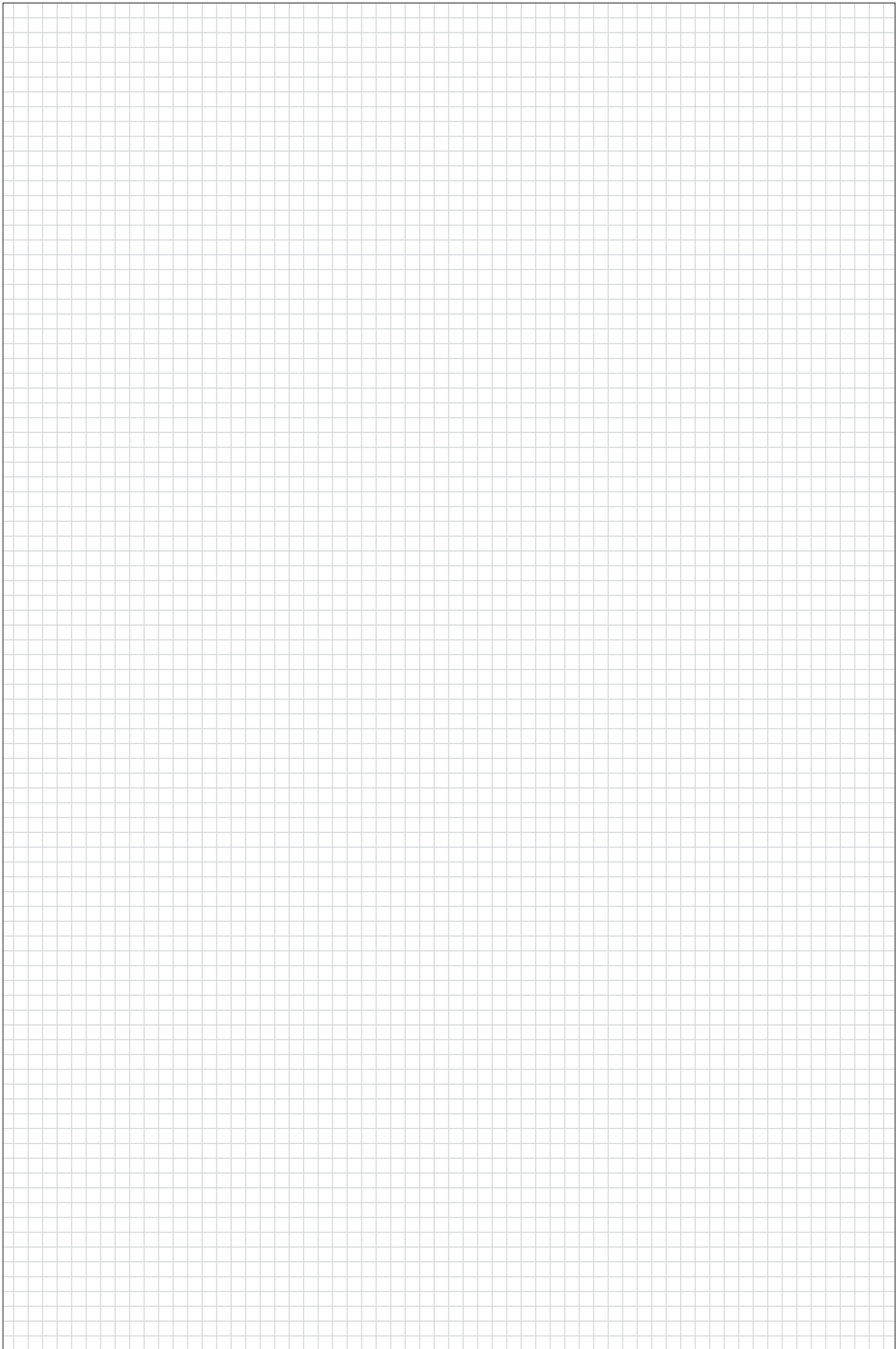



PROFILE MILLING CUTTERS PROFILFRÄSEN

Applications index Anwendungen	F119
High feed Hoher Vorschub	F120-127
Round inserts Fräser mit runden Wendeschneidplatten	F128-135
Aluminium die cutting Fräser für Aluminium-Formen	F136-138
Finishing ball nose Kugelbahnfräser zum Schlichten	F139-146



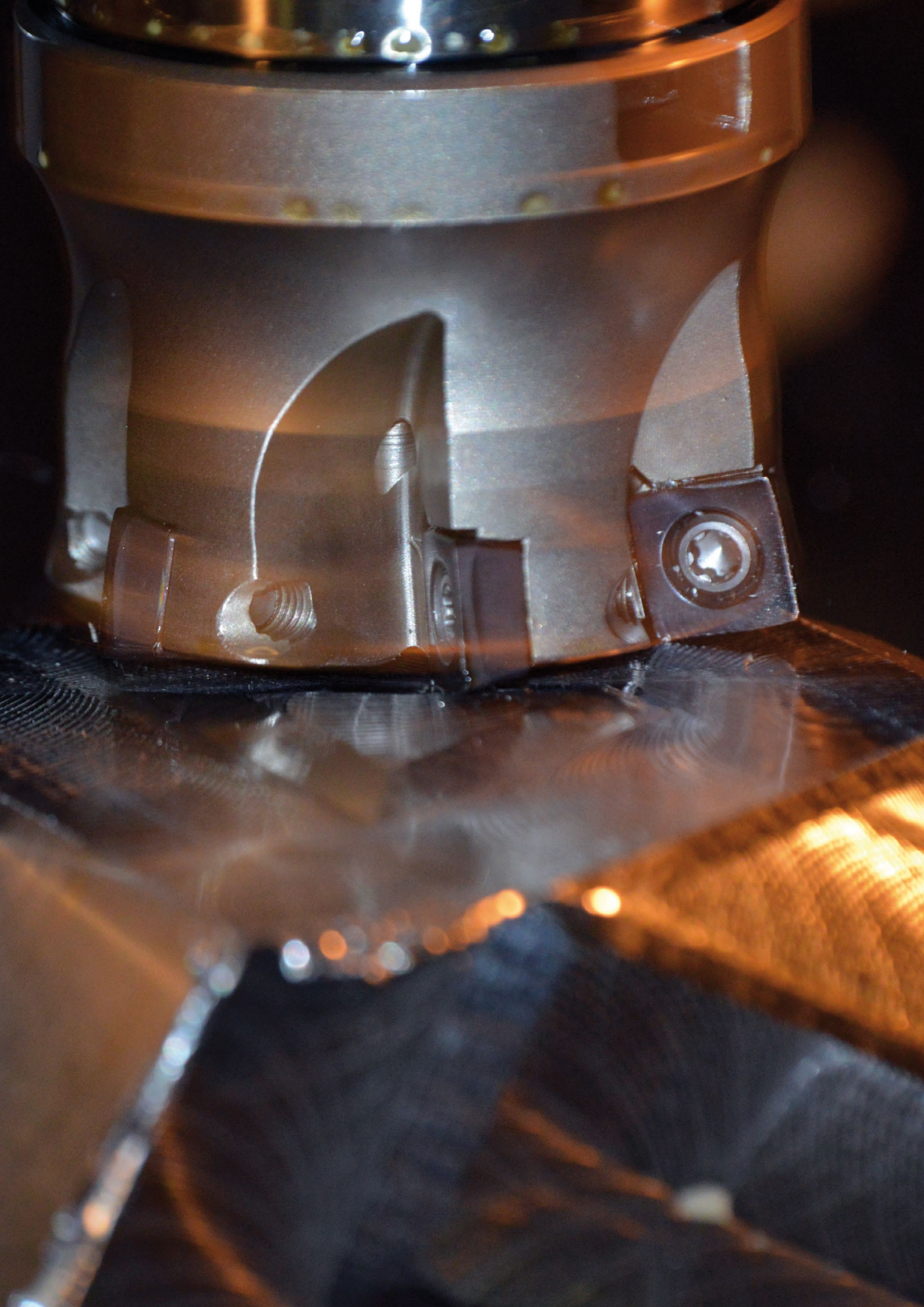



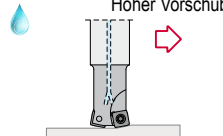
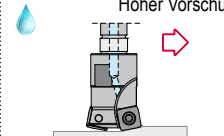
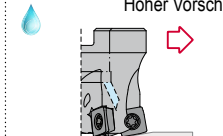
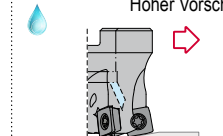

High feed Hoher Vorschub

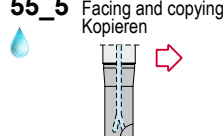
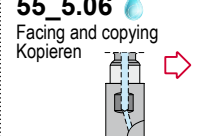
<p>1629.03 High feed Hoher Vorschub</p>  <p>SPMX 0735.. SPMX 0945.. SPMX 1155..</p> <p>Page SPMX 0735.. Seite F120 SPMX 0945.. SPMX 1155..</p>	<p>1629.06 High feed Hoher Vorschub</p>  <p>SPMX 0735.. SPMX 0945.. SPMX 1155..</p> <p>Page SPMX 0735.. Seite F121 SPMX 0945.. SPMX 1155..</p>	<p>1639.93 High feed Hoher Vorschub</p>  <p>SPMX 0945..</p> <p>Page SPMX 0945.. Seite F122</p>	<p>1649.93 High feed Hoher Vorschub</p>  <p>SPMX 1155..</p> <p>Page SPMX 1155.. Seite F123</p>	
--	--	--	---	--

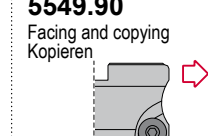

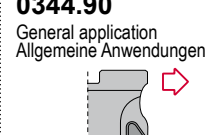

Round inserts Runde Wendeschneidplatten

<p>55_5 Facing and copying Kopieren</p>  <p>RD.. 0702.. RD.. 1604..</p> <p>Page RD.. 0702.. Seite F128 RD.. 1604..</p>	<p>55_5.06 Facing and copying Kopieren</p>  <p>RD.. 0702.. RD.. 1604..</p> <p>Page RD.. 0702.. Seite F129 RD.. 1604..</p>	<p>55_5.93 Facing and copying Kopieren</p>  <p>RD.. 12T3.. RD.. 1604..</p> <p>Page RD.. 12T3.. Seite F130 RD.. 1604..</p>	<p>5549.90 Facing and copying Kopieren</p>  <p>RPM.. 1204..</p> <p>Page RPM.. 1204.. Seite F131</p>	
--	---	---	--	--

Aluminium die cutting Fräser für Aluminium-Formen

<p>0344.06 General application Allgemeine Anwendungen</p>  <p>VCGT 1103.. VCGT 2205..</p> <p>Page VCGT 1103.. Seite F136 VCGT 2205..</p>	<p>0344.90 General application Allgemeine Anwendungen</p>  <p>VCGT 2205..</p> <p>Page VCGT 2205.. Seite F137</p>
--	--

Finishing ball nose Kugelbahnfräser zum Schlichten

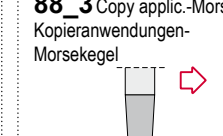
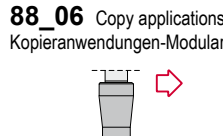
<p>85_0 Copy applic.-Cylindric Kopieranwendungen-Zylindrisch</p>  <p>HPR 10 HPR 32</p> <p>Page HPR 10 Seite F139 HPR 32</p>	<p>85_3 Copy applic.-Morse Kopieranwendungen-Morsekegel</p>  <p>HPR 25 HPR 32</p> <p>Page HPR 25 Seite F140 HPR 32</p>	<p>85_06 Copy applications Kopieranwendungen-Modular</p>  <p>HPR 10 HPR 25</p> <p>Page HPR 10 Seite F141 HPR 25</p>	<p>88_0 Copy applic.-Cylindric Kopieranwendungen-Zylindrisch</p>  <p>RPR 10 RPR 32</p> <p>Page RPR 10 Seite F142 RPR 32</p>	<p>88_3 Copy applic.-Morse Kopieranwendungen-Morsekegel</p>  <p>RPR 20 RPR 32</p> <p>Page RPR 20 Seite F143 RPR 32</p>
<p>88_06 Copy applications Kopieranwendungen-Modular</p>  <p>RPR 10 RPR 25</p> <p>Page RPR 10 Seite F144 RPR 25</p>				





Characteristics:
High feed square insert cutter for peripheral milling, ramp milling and drilling, pocket milling and copy milling.
It can be used in only one pass (roughing and finishing) and it is recommended for machining centers.

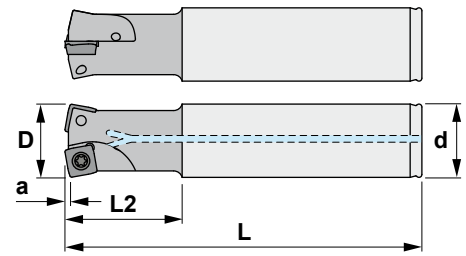

Eigenschaften:
Hoher Vorschubfräser mit vierkantigen Wendeschneidplatten zum Zirkularfräsen (Bohrlocherweiterung), Stufenfräsen, Bohren, Taschenfräsen und Kopierfräsen.
Für allgemeine Bearbeitungen mit nur einem Durchgang (Schruppen und Schlichten).
Empfohlen für Bearbeitungszentren.

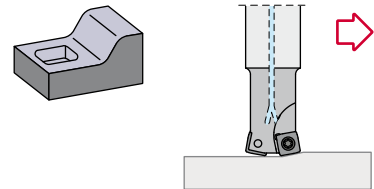

16²₄9.03

Reference Bezeichnung		D	L	L2	d	a	Insert size Wendeschneidplatte	
1629.03.016	2	16	110	20	16	0,6	SPMX 0735..	0,250
1629.03.020	3	20	130	30	20	0,9	SPMX 0735..	0,300
1629.03.025	4	25	140	40	25	0,9	SPMX 0735..	0,440
1629.03.032	5	32	150	50	32	0,9	SPMX 0735..	0,780
1639.03.025	2	25	140	40	25	1,4	SPMX 0945..	0,440
1639.03.032	4	32	150	50	32	1,4	SPMX 0945..	0,780
1639.03.035	4	35	150	50	32	1,4	SPMX 0945..	0,830
1649.03.032	3	32	150	50	32	1,8	SPMX 1155..	0,760

Reference Bezeichnung			Nm
1629.03.016	1430-IP	5510-IP	2.5
1629.03.020	1430-IP	5510-IP	2.5
1629.03.025	1430-IP	5510-IP	2.5
1629.03.032	1430-IP	5510-IP	2.5
1639.03.025	1440-IP	5515-IP	3.5
1639.03.032	1440-IP	5515-IP	3.5
1639.03.035	1440-IP	5515-IP	3.5
1649.03.032	1240-IP	5515-IP	3.5

SPMX

High feed.
Hoher Vorschub. F20

Reference / Bez.	l	s	d
SPMX 0735..	7,00	3,50	7,00
SPMX 0945..	9,70	4,40	9,70
SPMX 1155..	11,60	5,40	11,60

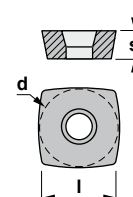



Characteristics:

High feed square insert cutter for peripheral milling, ramp milling and drilling, pocket milling and copy milling.

It can be used in only one pass (roughing and finishing) and it is recommended for machining centers.

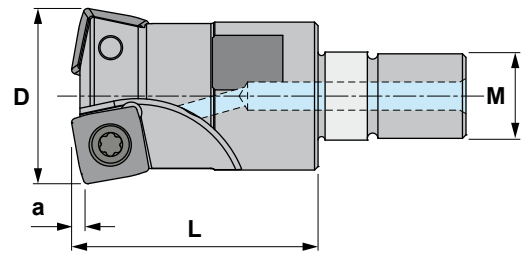

Eigenschaften:

Hoher Vorschubfräser mit vierkantigen Wendeschneidplatten zum Zirkularfräsen (Bohrlocherweiterung), Stufenfräsen, Bohren, Taschenfräsen und Kopierfräsen. Für allgemeine Bearbeitungen mit nur einem Durchgang (Schruppen und Schlichten).

Empfohlen für Bearbeitungszentren.

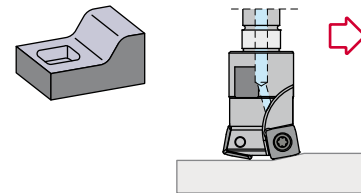

16²₄9.06

Reference Bezeichnung		D	L	M	a	Insert size Wendeschneidplatte	
1629.06.016	2	16	23	M8	0,6	SPMX 0735..	0,040
1629.06.020	3	20	30	M10	0,9	SPMX 0735..	0,050
1629.06.025	4	25	35	M12	0,9	SPMX 0735..	0,080
1629.06.032	5	32	43	M16	0,9	SPMX 0735..	0,180
1639.06.025	2	25	35	M12	1,4	SPMX 0945..	0,080
1639.06.032	4	32	43	M16	1,4	SPMX 0945..	0,180
1639.06.035	4	35	43	M16	1,4	SPMX 0945..	0,200
1639.06.042	5	42	43	M16	1,4	SPMX 0945..	0,240
1649.06.032	3	32	43	M16	1,8	SPMX 1155..	0,170
1649.06.035	3	35	43	M16	1,8	SPMX 1155..	0,180

Reference Bezeichnung			Nm
1629.06.016	1430-IP	5510-IP	2.5
1629.06.020	1430-IP	5510-IP	2.5
1629.06.025	1430-IP	5510-IP	2.5
1629.06.032	1430-IP	5510-IP	2.5
1639.06.025	1440-IP	5515-IP	3.5
1639.06.032	1440-IP	5515-IP	3.5
1639.06.035	1440-IP	5515-IP	3.5
1639.06.042	1440-IP	5515-IP	3.5
1649.06.032	1240-IP	5515-IP	3.5
1649.06.035	1240-IP	5515-IP	3.5

SPMX

High feed.
Hoher Vorschub. F20

Reference / Bez.	l	s	d
SPMX 0735..	7,00	3,50	7,00
SPMX 0945..	9,70	4,40	9,70
SPMX 1155..	11,60	5,40	11,60

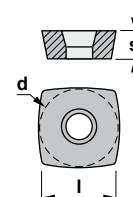

SPMX



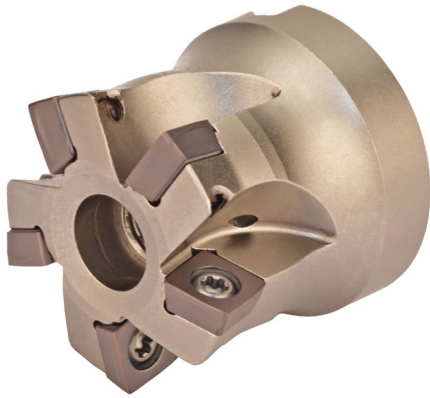

Characteristics:

High feed square insert cutter for peripheral milling, ramp milling and drilling, pocket milling and copy milling.

It can be used in only one pass (roughing and finishing) and it is recommended for machining centers.

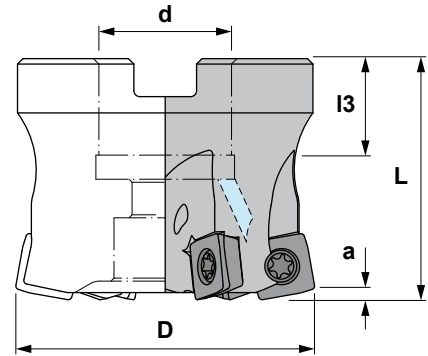

Eigenschaften:

Hoher Vorschubfräser mit vierkantigen Wendeschneidplatten zum Zirkularfräsen (Bohrlocherweiterung), Stufenfräsen, Bohren, Taschenfräsen und Kopierfräsen.

Für allgemeine Bearbeitungen mit nur einem Durchgang (Schruppen und Schlichten). Empfohlen für Bearbeitungszentren.

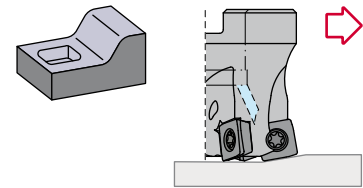

1639.93

Reference Bezeichnung		D	L	d	l3	a	Insert size Wendeschneidplatte	
1639.93.040	5	40	40	16	18	1,4	SPMX 0945..	0,190
1639.93.042	5	42	40	16	18	1,4	SPMX 0945..	0,210
1639.93.050	6	50	40	22	20	1,4	SPMX 0945..	0,320
1639.93.052	7	52	40	22	20	1,4	SPMX 0945..	0,340
1639.93.066	8	66	50	27	22	1,4	SPMX 0945..	0,780

Reference Bezeichnung				Nm
1639.93.040	1440-IP	5515-IP	1058	3.5
1639.93.042	1440-IP	5515-IP	1058	3.5
1639.93.050	1440-IP	5515-IP	912,10	3.5
1639.93.052	1440-IP	5515-IP	912,10	3.5
1639.93.066	1440-IP	5515-IP	912,12	3.5

SPMX

High feed. Hoher Vorschub. F20

Reference / Bez.	l	s	d
SPMX 0945..	9,70	4,40	9,70

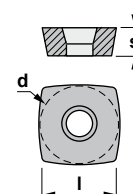

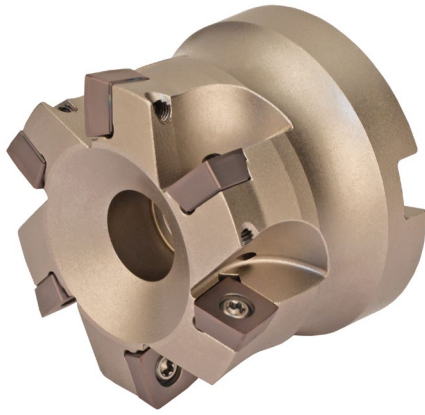

Characteristics:

High feed square insert cutter for peripheral milling, ramp milling and drilling, pocket milling and copy milling.

It can be used in only one pass (roughing and finishing) and it is recommended for machining centers.

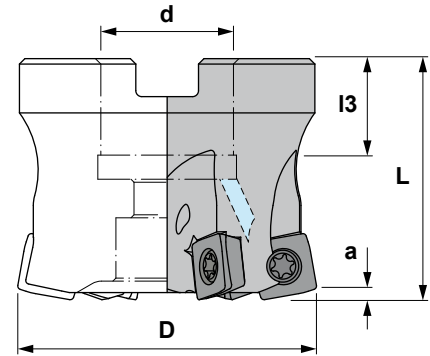

Eigenschaften:

Hoher Vorschubfräser mit vierkantigen Wendeschneidplatten zum Zirkularfräsen (Bohrlocherweiterung), Stufenfräsen, Bohren, Taschenfräsen und Kopierfräsen.

Für allgemeine Bearbeitungen mit nur einem Durchgang (Schruppen und Schlichten). Empfohlen für Bearbeitungszentren.

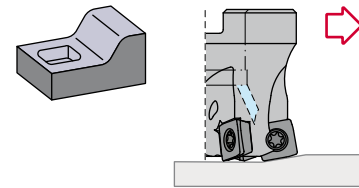

1649.93

Reference Bezeichnung		D	L	d	l3	a	Insert size Wendeschneidplatte	
1649.93.050	5	50	40	22	20	1,8	SPMX 1155..	0,290
1649.93.052	5	52	40	22	20	1,8	SPMX 1155..	0,310
1649.93.063	6	63	50	27	22	1,8	SPMX 1155..	0,720
1649.93.066	7	66	50	27	22	1,8	SPMX 1155..	0,740
1649.93.080	8	80	50	27	22	1,8	SPMX 1155..	0,980

Reference Bezeichnung				Nm
1649.93.050	1240-IP	5515-IP	912,10	3.5
1649.93.052	1240-IP	5515-IP	912,10	3.5
1649.93.063	1240-IP	5515-IP	912,12	3.5
1649.93.066	1240-IP	5515-IP	912,12	3.5
1649.93.080	1240-IP	5515-IP	912,12	3.5

SPMX

High feed. F20
Hoher Vorschub.

Reference / Bez.	l	s	d
SPMX 1155..	11,60	5,40	11,60

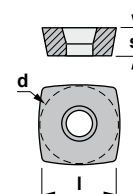

Recommended cutting conditions

Material	P	Hardness	Insert	Grade	Standard milling				High feed milling			
					Vc	fz	ap	ae	Vc	fz	ap	ae
Mild steel		<180HB	SPMX 073505	TL20	170 (120-220)	1,0	0,5/0,8	100%	200	1,0	0,4	100%
			SPMX 094506			1,2	0,5/1,0	100%		1,4	0,5	100%
			SPMX 115506			1,5	0,8/1,5	100%		1,4	0,8	100%
Carbon steel, alloyed steel		180-280HB	SPMX 073505	TL20	150 (100-200)	0,8	0,5/0,7	100%	200	1,0	0,4	100%
			SPMX 094506			1,0	0,5/0,7	100%		1,2	0,5	100%
			SPMX 115506			1,2	0,6/1,5	100%		1,2	0,8	100%
Carbon steel, alloyed steel		280-350HB	SPMX 073505	TL20	120 (80-150)	0,8	0,5/0,7	100%	180	1,0	0,3	100%
			SPMX 094506			1,0	0,5/0,7	100%		1,2	0,4	100%
			SPMX 115506			1,2	0,5/1,0	100%		1,2	0,6	100%
Alloyed tool steel		<350HB	SPMX 073505	TL20	120 (80-140)	0,8	0,5/0,7	100%	180	0,6	0,3	100%
			SPMX 094506			1,0	0,5/0,7	100%		0,8	0,4	100%
			SPMX 115506			1,0	0,5/1,0	100%		0,8	0,6	100%
Prehardened steel		35-45HRC	SPMX 073505	TL20	100 (70 (50-90))	0,6	0,4/0,6	100%	150	0,6	0,3	100%
			SPMX 094506			0,8	0,4/0,6	100%		0,8	0,4	100%
			SPMX 115506			0,8	0,4/0,8	100%		0,8	0,5	100%

Material	M	Hardness	Insert	Grade	Standard milling				High feed milling			
					Vc	fz	ap	ae	Vc	fz	ap	ae
Stainless steel		<200HB	SPMX 073505	TL20	100 (60-120)	0,4	0,5/0,7	100%	-	-	-	-
			SPMX 094506			0,4	0,5/1,0	100%		-	-	-
			SPMX 115506			0,4	0,6/1,5	100%		-	-	-
PH, Duplex		<200HB	SPMX 073505	TL20	70 (50-90)	0,4	0,3/0,5	100%	-	-	-	-
			SPMX 094506			0,4	0,3/0,5	100%		-	-	-
			SPMX 115506			0,4	0,4/0,8	100%		-	-	-

Material	K	Hardness	Insert	Grade	Standard milling				High feed milling			
					Vc	fz	ap	ae	Vc	fz	ap	ae
Grey cast iron		<200HB	SPMX 073505	TL20	150 (100-200)	1,0	0,5/0,7	100%	-	-	-	-
			SPMX 094506			1,2	0,5/0,8	100%		-	-	-
			SPMX 115506			1,2	0,6/1,5	100%		-	-	-
Ductile cast iron		<450MPa	SPMX 073505	TL20	120 (80-160)	1,0	0,4/0,6	100%	-	-	-	-
			SPMX 094506			1,0	0,4/0,6	100%		-	-	-
			SPMX 115506			1,0	0,5/0,8	100%		-	-	-

Material	H	Hardness	Insert	Grade	Standard milling				High feed milling			
					Vc	fz	ap	ae	Vc	fz	ap	ae
Hardened steel		40-55HRC	SPMX 073505	TL20	70 (50-90)	0,5	0,3/0,5	100%	120	0,6	0,3	100%
			SPMX 094506			0,6	0,3/0,5	100%		0,6	0,3	100%
			SPMX 115506			0,6	0,3/0,6	100%		0,6	0,4	100%

Configuration note

When using the milling cutter 1629, 1639 or 1649 it must be configured as a milling cutter with radius RE.
The approximate uncut portions cut of the configurations are the following:

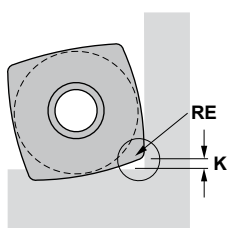

Insert size	RE	K mm
SPMX 073505	1,7	0,8
SPMX 094506	2,3	1,6
SPMX 115506	2,695	2,1

Ø16 max. Ap. 0,5

Empfohlene Schnittdaten

Materialien	P	Härte	WSP	Sorte	Standard-Fräsen				Fräsen mit hohem Vorschub			
					Vc	fz	ap	ae	Vc	fz	ap	ae
Baustahl		<180HB	SPMX 073505	TL20	170 (120-220)	1,0	0,5/0,8	100%	200	1,0	0,4	100%
			SPMX 094506			1,2	0,5/1,0	100%		1,4	0,5	100%
			SPMX 115506			1,5	0,8/1,5	100%		1,4	0,8	100%
Kohlenstoffstahl, legierter Stahl		180-280HB	SPMX 073505	TL20	150 (100-200)	0,8	0,5/0,7	100%	200	1,0	0,4	100%
			SPMX 094506			1,0	0,5/0,7	100%		1,2	0,5	100%
			SPMX 115506			1,2	0,6/1,5	100%		1,2	0,8	100%
Kohlenstoffstahl, legierter Stahl		280-350HB	SPMX 073505	TL20	120 (80-150)	0,8	0,5/0,7	100%	180	1,0	0,3	100%
			SPMX 094506			1,0	0,5/0,7	100%		1,2	0,4	100%
			SPMX 115506			1,2	0,5/1,0	100%		1,2	0,6	100%
Legierter Werkzeugstahl		<350HB	SPMX 073505	TL20	120 (80-140)	0,8	0,5/0,7	100%	180	0,6	0,3	100%
			SPMX 094506			1,0	0,5/0,7	100%		0,8	0,4	100%
			SPMX 115506			1,0	0,5/1,0	100%		0,8	0,6	100%
Vorgehärteter Stahl		35-45HRC	SPMX 073505	TL20	100 (70 (50-90))	0,6	0,4/0,6	100%	150	0,6	0,3	100%
			SPMX 094506			0,8	0,4/0,6	100%		0,8	0,4	100%
			SPMX 115506			0,8	0,4/0,8	100%		0,8	0,5	100%

Materialien	M	Härte	WSP	Sorte	Standard-Fräsen				Fräsen mit hohem Vorschub			
					Vc	fz	ap	ae	Vc	fz	ap	ae
Rostfreier Stahl		<200HB	SPMX 073505	TL20	100 (60-120)	0,4	0,5/0,7	100%	-	-	-	-
			SPMX 094506			0,4	0,5/1,0	100%		-	-	-
			SPMX 115506			0,4	0,6/1,5	100%		-	-	-
PH, Duplex		<200HB	SPMX 073505	TL20	70 (50-90)	0,4	0,3/0,5	100%	-	-	-	-
			SPMX 094506			0,4	0,3/0,5	100%		-	-	-
			SPMX 115506			0,4	0,4/0,8	100%		-	-	-

Materialien	K	Härte	WSP	Sorte	Standard-Fräsen				Fräsen mit hohem Vorschub			
					Vc	fz	ap	ae	Vc	fz	ap	ae
Grauguß		<200HB	SPMX 073505	TL20	150 (100-200)	1,0	0,5/0,7	100%	-	-	-	-
			SPMX 094506			1,2	0,5/0,8	100%		-	-	-
			SPMX 115506			1,2	0,6/1,5	100%		-	-	-
Duktiles Gußeisen		<450MPa	SPMX 073505	TL20	120 (80-160)	1,0	0,4/0,6	100%	-	-	-	-
			SPMX 094506			1,0	0,4/0,6	100%		-	-	-
			SPMX 115506			1,0	0,5/0,8	100%		-	-	-

Materialien	H	Härte	WSP	Sorte	Standard-Fräsen				Fräsen mit hohem Vorschub			
					Vc	fz	ap	ae	Vc	fz	ap	ae
Gehärteter Stahl		40-55HRC	SPMX 073505	TL20	70 (50-90)	0,5	0,3/0,5	100%	120	0,6	0,3	100%
			SPMX 094506			0,6	0,3/0,5	100%		0,6	0,3	100%
			SPMX 115506			0,6	0,3/0,6	100%		0,6	0,4	100%

Einstellungshinweis

Beim Einsatz des Fräasers 1629, 1639 oder 1649 empfehlen wir, den Fräser wie ein RE-Radiusfräser einzustellen.
Die ungefähre ungeschnittene Teile der Einstellung sind wie folgt:

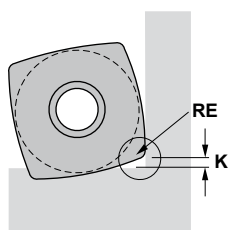

WSP-Größe	RE	K mm
SPMX 073505	1,7	0,8
SPMX 094506	2,3	1,6
SPMX 115506	2,695	2,1

Ø16 max. Ap. 0,5

Processing by direct milling is also possible

Since the cutting flute does not extend to the center, there are limitations on the ramp angle and hole diameter, but as shown below, processing by direct milling without a pilot hole is possible for ramping and helical milling.

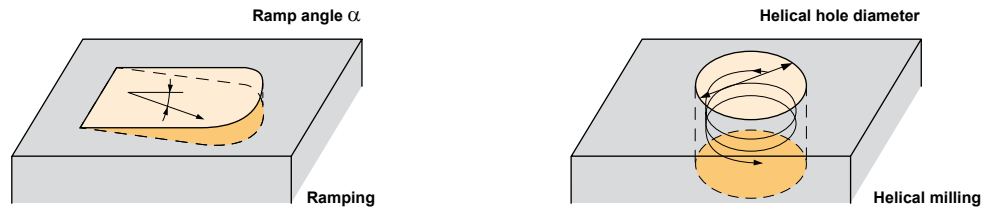

Insert size	SPMX 0735..			
Tool diameter	Ø16	Ø20	Ø25	Ø32
Maximum ramp angle α	2°	2°	2°	1°
Hole diameter	Ø21-30	Ø29-38	Ø39-48	Ø52-61

Insert size	SPMX 0945..							
Tool diameter	Ø25	Ø32	Ø35	Ø40	Ø42	Ø50	Ø52	Ø66
Maximum ramp angle α	2°	2°	2°	1°	1°	1°	1°	0,5°
Hole diameter	Ø36-48	Ø50-62	Ø56-68	Ø66-78	Ø70-82	Ø86-98	Ø90-102	Ø118-130

Insert size	SPMX 1155..						
Tool diameter	Ø32	Ø35	Ø50	Ø52	Ø63	Ø66	Ø80
Maximum ramp angle α	2°	2°	1°	1°	0,5°	0,5°	0,5°
Hole diameter	Ø47-62	Ø53-68	Ø83-98	Ø87-102	Ø109-124	Ø115-130	Ø143-158

Note

- The ramp angle α should be set within the ranges listed above. Use at ramp angles of 1° or less recommended.
- For hole diameters outside the ranges listed above, a pilot hole should be drilled before milling.

Verarbeitung durch das direkte Fräsen ist auch möglich

Da sich die Schneide bis zu das Zentrum nicht ausstreckt, gibt es Beschränkungen auf den Rampen-Winkel, und den Loch-Durchmesser. Aber zum Einwärtskopieren und zum Bohrzirkularfräsen, wie unten gezeigt, ist die Verarbeitung durch das direkte Fräsen ohne eine Vorbohrung möglich.

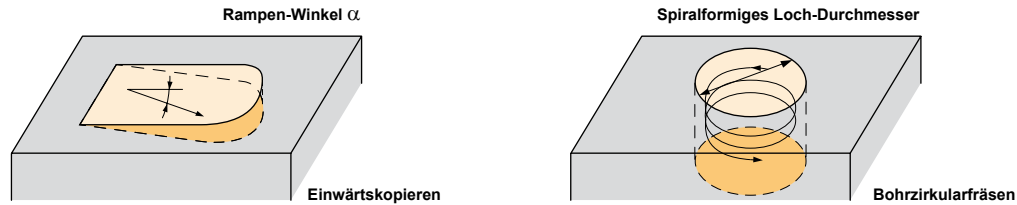

Wendeschneidplatte	SPMX 0735..			
Werkzeugdurchmesser	Ø16	Ø20	Ø25	Ø32
Maximaler Rampen-Winkel α	2°	2°	2°	1°
Lochdurchmesser	Ø21-30	Ø29-38	Ø39-48	Ø52-61

Wendeschneidplatte	SPMX 0945..							
Werkzeugdurchmesser	Ø25	Ø32	Ø35	Ø40	Ø42	Ø50	Ø52	Ø66
Maximaler Rampen-Winkel α	2°	2°	2°	1°	1°	1°	1°	0,5°
Lochdurchmesser	Ø36-48	Ø50-62	Ø56-68	Ø66-78	Ø70-82	Ø86-98	Ø90-102	Ø118-130

Wendeschneidplatte	SPMX 1155..						
Werkzeugdurchmesser	Ø32	Ø35	Ø50	Ø52	Ø63	Ø66	Ø80
Maximaler Rampen-Winkel α	2°	2°	1°	1°	0,5°	0,5°	0,5°
Lochdurchmesser	Ø47-62	Ø53-68	Ø83-98	Ø87-102	Ø109-124	Ø115-130	Ø143-158

Bemerkung

- Der Rampen-Winkel α sollte innerhalb der Auswahl gesetzt werden, die oben verzeichnet ist. Die Verwendung von Rampen-Winkeln von 1° oder weniger ist empfohlen.
- Für Loch-Diameter außerhalb der Auswahl, die oben verzeichnet ist, sollte ein Loch vor dem Fräsen gebohrt werden.



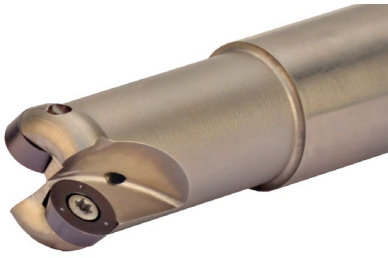

Characteristics:

Round insert end mill for slot milling, peripheral milling, ramp milling and drilling, pocket milling and copy milling.

It can be used in only one pass (roughing and finishing) and it is recommended for conventional milling machines and machining centers.

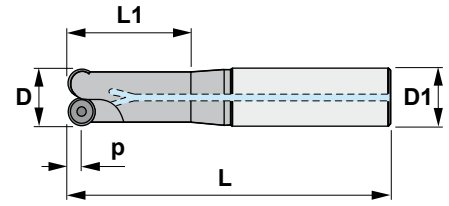

Eigenschaften:

Fräser mit runden Wendeschneidplatten zum Zirkularfräsen (Bohrlocherweiterung), Stufenfräsen, Bohren, Taschenfräsen und Kopierfräsen.

Für allgemeine Bearbeitungen mit nur einem Durchgang (Schruppen und Schlichten). Empfohlen für konventionelle Fräsmaschinen und Bearbeitungszentren.

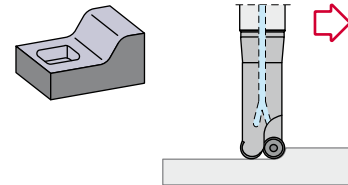

55_5

Reference Bezeichnung		D	L	D1	L1	p	Insert size Wendeschneidplatte	
5525.00.015	2	15	100	20	40	3,5	RD.. 0702M0	0,180
5525.01.015	2	15	150	20	40	3,5	RD.. 0702M0	0,300
5525.00.016	2	16	100	20	40	3,5	RD.. 0702M0	0,185
5525.01.016	2	16	150	20	40	3,5	RD.. 0702M0	0,310
5535.00.020	2	20	100	20	40	5,0	RD.. 1003M0	0,220
5535.01.020	2	20	150	20	40	5,0	RD.. 1003M0	0,340
5545.00.025	2	25	125	25	50	6,0	RD.. 12T3M0	0,460
5545.01.025	2	25	180	25	60	6,0	RD.. 12T3M0	0,670
5545.00.032	3	32	125	32	50	6,0	RD.. 12T3M0	0,740
5545.01.032	3	32	180	32	60	6,0	RD.. 12T3M0	1,080
5555.01.032	2	32	180	32	60	8,0	RD.. 1604M0	1,080

Reference Bezeichnung			Nm
5525.00.015	1425	5507	0.9
5525.01.015	1425	5507	0.9
5525.00.016	1425	5507	0.9
5525.01.016	1425	5507	0.9
5535.00.020	1435	5515	3.0
5535.01.020	1435	5515	3.0
5545.00.025	1435	5515	3.0
5545.01.025	1435	5515	3.0
5545.00.032	1435	5515	3.0
5545.01.032	1435	5515	3.0
5555.01.032	1245	5515	3.0

RD.. Round positive inserts with 15° clearance. F15-16
Runde positive Wendeschneidplatten mit 15° Freiwinkel.

Reference / Bez.	s	d
RD.. 0702M0	2,38	7,00
RD.. 1003M0	3,18	10,00
RD.. 12T3M0	3,97	12,00
RD.. 1604M0	4,76	16,00

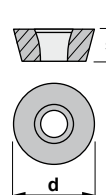



Characteristics:

Round insert end mill for slot milling, peripheral milling, ramp milling and drilling, pocket milling and copy milling.

It can be used in only one pass (roughing and finishing) and it is recommended for conventional milling machines and machining centers.

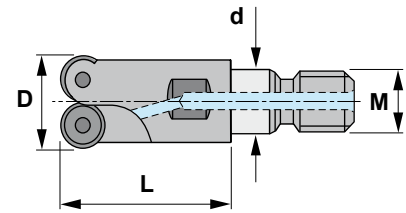

Eigenschaften:

Fräser mit runden Wendeschneidplatten zum Zirkularfräsen (Bohrlocherweiterung), Stufenfräsen, Bohren, Taschenfräsen und Kopierfräsen.

Für allgemeine Bearbeitungen mit nur einem Durchgang (Schruppen und Schlichten).
Empfohlen für konventionelle Fräsmaschinen und Bearbeitungszentren.

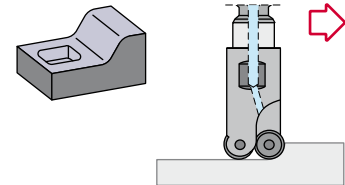

55_5.06

Reference Bezeichnung		D	L	M	d	Insert size Wendeschneidplatte	
5525.06.016	2	16	23	M8	14	RD.. 0702..	0,030
5535.06.020	2	20	30	M10	18	RD.. 1003..	0,060
5535.06.025	3	25	35	M12	21	RD.. 1003..	0,095
5535.06.035	4	35	43	M16	29	RD.. 1003..	0,225
5535.06.042	5	42	43	M16	29	RD.. 1003..	0,320
5545.06.025	2	25	43	M12	21	RD.. 12T3..	0,095
5545.06.032	3	32	43	M16	29	RD.. 12T3..	0,230
5545.06.035	3	35	43	M16	29	RD.. 12T3..	0,250
5545.06.042	4	42	43	M16	29	RD.. 12T3..	0,320
5545.06.042Z=5	5	42	43	M16	29	RD.. 12T3..	0,320
5555.06.032	2	32	43	M16	29	RD.. 1604..	0,250

Reference Bezeichnung			Nm
5525.06.016	1425	5507	0.9
5535.06.020	1435	5515	3.0
5535.06.025	1435	5515	3.0
5535.06.035	1435	5515	3.0
5535.06.042	1435	5515	3.0
5545.06.025	1435	5515	3.0
5545.06.032	1435	5515	3.0
5545.06.035	1435	5515	3.0
5545.06.042	1435	5515	3.0
5545.06.042Z=5	1435	5515	3.0
5555.06.032	1245	5515	3.0

RD.. Round positive inserts with 15° clearance. F15-16
Runde positive Wendeschneidplatten mit 15° Freiwinkel.

Reference / Bez.	s	d
RD.. 0702M0	2,38	7,00
RD.. 1003M0	3,18	10,00
RD.. 12T3M0	3,97	12,00
RD.. 1604M0	4,76	16,00

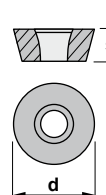

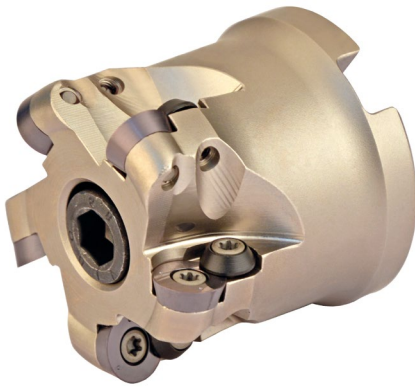

Characteristics:

Round insert cutter for slot milling, peripheral milling, ramp milling and drilling, pocket milling and copy milling.

It can be used in only one pass (roughing and finishing) and it is recommended for conventional milling machines and machining centers.

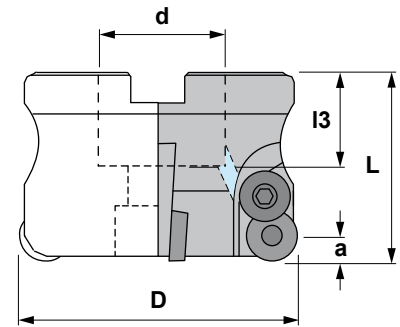

Eigenschaften:

Fräser mit runden Wendeschneidplatten zum Zirkularfräsen (Bohrlocherweiterung), Stufenfräsen, Bohren, Taschenfräsen und Kopierfräsen.

Für allgemeine Bearbeitungen mit nur einem Durchgang (Schruppen und Schlichten).

Empfohlen für konventionelle Fräsmaschinen und Bearbeitungszentren.

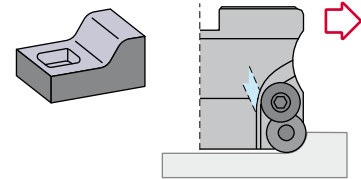

55⁴5.93

Reference Bezeichnung		D	L	d	l3	a	Insert size Wendeschneidplatte	
5545.93.052	5	52	50	22	20	6	RD.. 12T3..	0,450
5545.93.066	6	66	50	27	22	6	RD.. 12T3..	0,770
5545.93.080	7	80	50	27	22	6	RD.. 12T3..	1,200
5555.93.052	4	52	50	22	20	8	RD.. 1604..	0,350
5555.93.066	5	66	50	27	22	8	RD.. 1604..	0,700
5555.93.080	6	80	50	27	22	8	RD.. 1604..	1,050
5555.93.100	7	100	55	32	25	8	RD.. 1604..	1,800
5555.90.125	8	125	55	40	30	8	RD.. 1604..	3,500
5555.90.160	9	160	55	40	30	8	RD.. 1604..	5,600

Reference Bezeichnung					Nm	
5545.93.052	1235	2009	912,10	5515	-	3.0
5545.93.066	1235	2009	912,12	5515	-	3.0
5545.93.080	1235	2009	912,12	5515	-	3.0
5555.93.052	1245	2010	912,10	5515	-	3.0
5555.93.066	1245	2010	912,12	5515	-	3.0
5555.93.080	1245	2010	912,12	5515	-	3.0
5555.93.100	1245	2010	912,17	-	5615	3.0
5555.90.125	1245	2010	-	-	5615	3.0
5555.90.160	1245	2010	912,52	-	5615	3.0

RD.. Round positive inserts with 15° clearance. F15-16
Runde positive Wendeschneidplatten mit 15° Freiwinkel.

Reference / Bez.	s	d
RD.. 12T3M0	3,97	12,00
RD.. 1604M0	4,76	16,00

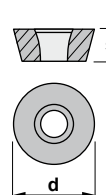

RDHW



RDMT



RDMW





Characteristics:

Round insert cutter for slot milling, peripheral milling, ramp milling and drilling, pocket milling and copy milling.

It can be used in only one pass (roughing and finishing) and it is recommended for conventional milling machines and machining centers.

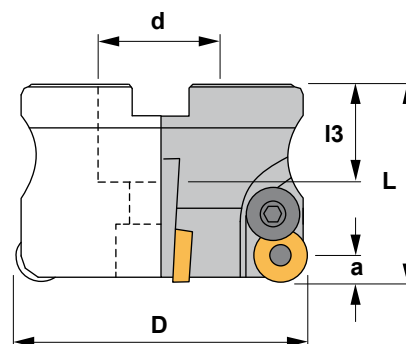

Eigenschaften:

Fräser mit runden Wendeschneidplatten zum Zirkularfräsen (Bohrlocherweiterung), Stufenfräsen, Bohren, Taschenfräsen und Kopierfräsen.

Für allgemeine Bearbeitungen mit nur einem Durchgang (Schruppen und Schlichten).
Empfohlen für konventionelle Fräsmaschinen und Bearbeitungszentren.

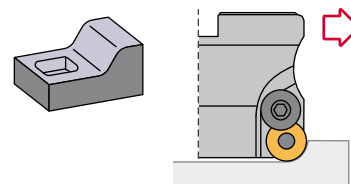

5549.90

Reference Bezeichnung		D	L	d	l3	a	Insert size Wendeschneidplatte	
5549.90.040	3	40	40	16	18	6	RPM.. 1204M0	0,200
5549.90.050	4	50	40	22	20	6	RPM.. 1204M0	0,300
5549.90.063	5	63	50	27	22	6	RPM.. 1204M0	0,650
5549.90.080	6	80	50	32	25	6	RPM.. 1204M0	1,150
5549.90.100	7	100	50	40	30	6	RPM.. 1204M0	1,750
5549.90.125	7	125	63	40	30	6	RPM.. 1204M0	3,100

Reference Bezeichnung							Nm
5549.90.040	1025	5003	1240	5515	-	1058	3.0
5549.90.050	1025	5003	1240	5515	-	912,10	3.0
5549.90.063	1025	5003	1240	5515	-	912,12	3.0
5549.90.080	1025	5003	1240	5515	-	912,17	3.0
5549.90.100	1025	5003	1240	-	5615	912,20	3.0
5549.90.125	1025	5003	1240	-	5615	-	3.0

RPM..

Round positive inserts with 11° clearance. F16
Runde positive Wendeschneidplatten mit 11° Freiwinkel.

Reference / Bez.	s	d
RPM.. 1204M0	4,76	12,00

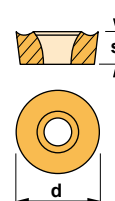

RPMT



RPMW



Material	Cutting speed Vc (m/min)	Per-flute feed rate fz (mm/tooth)	Ø12 - Ø20			Ø24 - Ø25			Ø32 - Ø35		
			Rotation speed min ⁻¹	Feed rate mm/min	Q value cm ³ /min	Rotation speed min ⁻¹	Feed rate mm/min	Q value cm ³ /min	Rotation speed min ⁻¹	Feed rate mm/min	Q value cm ³ /min
Mild steels (200 HB)	150-250	0,3-0,8	3980	3180	28,6	3180	2540	28,6	2490	2990	43,1
			Vc=250m/min fz=0,4mm/tooth ap=1,5mm ae=0,3D			3980			3180 2540 47,6 2490 2990 71,8		
Carbon steels Alloyed steels (30 HRC)	120-230	0,3-0,8	Vc=250m/min fz=0,4mm/tooth ap=1,5mm ae=0,5D			3180 2540 22,9 2550 2040 23 1990 2390 34,4			Vc=200m/min fz=0,4mm/tooth ap=1,5mm ae=0,3D		
			3180 2540 38,1 2550 2040 38,3 1990 2390 57,4			Vc=200m/min fz=0,4mm/tooth ap=1,5mm ae=0,5D			2390 960 8,6 1910 760 8,6 1490 890 12,8		
Carbon steels Alloyed steels (30-40 HRC)	100-200	0,2-0,6	Vc=150m/min fz=0,2mm/tooth ap=1,5mm ae=0,3D			2390 1430 21,5 1910 1150 21,6 1490 1340 32,2			Vc=150m/min fz=0,2mm/tooth ap=1,5mm ae=0,5D		
			1590 480 2,9 1270 380 2,9 990 450 4,3			Vc=100m/min fz=0,15mm/tooth ap=1mm ae=0,3D			1590 640 6,4 1270 510 6,4 990 590 9,4		
Carbon steels Alloyed steels (40-45 HRC)	60-150	0,15-0,3	Vc=100m/min fz=0,2mm/tooth ap=1mm ae=0,5D			1270 380 2,3 1020 310 2,3 800 360 3,5			Vc=80m/min fz=0,15mm/tooth ap=1mm ae=0,3D		
			1270 380 3,8 1020 310 3,9 800 360 5,8			Vc=80m/min fz=0,15mm/tooth ap=1mm ae=0,5D			1110 220 1,3 890 170 1,2 690 200 1,9		
Alloyed steels (50-60 HRC)	50-100	0,05-0,2	Vc=70m/min fz=0,1mm/tooth ap=1mm ae=0,3D			1110 220 2,2 890 170 2,1 690 200 3,2			Vc=70m/min fz=0,1mm/tooth ap=1mm ae=0,5D		
			3180 1590 14,3 2550 1280 14,4 1990 1490 21,5			Vc=200m/min fz=0,25mm/tooth ap=1,5mm ae=0,3D			2860 1716 25,7 2290 1370 25,7 1790 1610 38,6		
Stainless steels	150-240	0,2-0,8	Vc=180m/min fz=0,3mm/tooth ap=1,5mm ae=0,5D			2860 2290 20,6 2290 1830 20,6 1790 2150 31			Vc=180m/min fz=0,4mm/tooth ap=1,5mm ae=0,3D		
			2860 2860 42,9 2290 2290 42,9 1790 2690 64,6			Vc=180m/min fz=0,5mm/tooth ap=1,5mm ae=0,5D					

Material	Ø40 - Ø42 (R6)			Ø50 - Ø52 (R6)			Ø40 - Ø42 (R8)			Ø50 - Ø52 (R8)		
	Rotation speed min ⁻¹	Feed rate mm/min	Q value cm ³ /min	Rotation speed min ⁻¹	Feed rate mm/min	Q value cm ³ /min	Rotation speed min ⁻¹	Feed rate mm/min	Q value cm ³ /min	Rotation speed min ⁻¹	Feed rate mm/min	Q value cm ³ /min
Mild steels (200 HB)	1990	2990	71,8	1590	3180	95,4	1990	1990	47,8	1590	2390	71,7
	Vc=250m/min fz=0,5mm/tooth ap=2mm ae=0,3D			Vc=250m/min fz=0,5mm/tooth ap=2mm ae=0,3D			Vc=250m/min fz=0,5mm/tooth ap=2mm ae=0,3D			Vc=250m/min fz=0,5mm/tooth ap=2mm ae=0,3D		
Carbon steels Alloyed steels (30 HRC)	1990	4780	191,2	1590	5090	254,5	1990	3180	159	1590	3820	238,8
	Vc=250m/min fz=0,8mm/tooth ap=2mm ae=0,5D			Vc=250m/min fz=0,8mm/tooth ap=2,5mm ae=0,5D			Vc=250m/min fz=0,8mm/tooth ap=2,5mm ae=0,5D			Vc=250m/min fz=0,8mm/tooth ap=2,5mm ae=0,5D		
Carbon steels Alloyed steels (30-40 HRC)	1590	1910	45,8	1270	2030	60,9	1590	1270	30,5	1270	1520	45,6
	Vc=200m/min fz=0,4mm/tooth ap=2mm ae=0,3D			Vc=200m/min fz=0,4mm/tooth ap=2mm ae=0,3D			Vc=200m/min fz=0,4mm/tooth ap=2mm ae=0,3D			Vc=200m/min fz=0,4mm/tooth ap=2mm ae=0,3D		
Carbon steels Alloyed steels (30-40 HRC)	1590	2860	114,4	1270	3050	152,5	1590	1910	95,5	1270	2290	143,1
	Vc=200m/min fz=0,6mm/tooth ap=2mm ae=0,5D			Vc=200m/min fz=0,6mm/tooth ap=2,5mm ae=0,5D			Vc=200m/min fz=0,6mm/tooth ap=2,5mm ae=0,5D			Vc=200m/min fz=0,6mm/tooth ap=2,5mm ae=0,5D		
Carbon steels Alloyed steels (40-45 HRC)	1190	710	17	960	770	23,1	1190	480	11,5	960	580	17,4
	Vc=150m/min fz=0,2mm/tooth ap=2mm ae=0,3D			Vc=150m/min fz=0,2mm/tooth ap=2mm ae=0,3D			Vc=150m/min fz=0,2mm/tooth ap=2mm ae=0,3D			Vc=150m/min fz=0,2mm/tooth ap=2mm ae=0,3D		
Carbon steels Alloyed steels (40-45 HRC)	1190	1070	42,8	960	1150	57,5	1190	950	47,5	960	1150	71,9
	Vc=150m/min fz=0,3mm/tooth ap=2mm ae=0,5D			Vc=150m/min fz=0,4mm/tooth ap=2,5mm ae=0,5D			Vc=150m/min fz=0,4mm/tooth ap=2,5mm ae=0,5D			Vc=150m/min fz=0,4mm/tooth ap=2,5mm ae=0,5D		
Carbon steels Alloyed steels (45-50 HRC)	800	360	6,5	640	380	8,6	800	240	4,3	640	290	6,5
	Vc=100m/min fz=0,15mm/tooth ap=1,5mm ae=0,3D			Vc=100m/min fz=0,15mm/tooth ap=1,5mm ae=0,3D			Vc=100m/min fz=0,15mm/tooth ap=1,5mm ae=0,3D			Vc=100m/min fz=0,15mm/tooth ap=1,5mm ae=0,3D		
Alloyed steels (50-60 HRC)	800	480	14,4	640	510	19,1	800	320	12,8	640	380	19
	Vc=100m/min fz=0,2mm/tooth ap=1,5mm ae=0,5D			Vc=100m/min fz=0,2mm/tooth ap=2mm ae=0,5D			Vc=100m/min fz=0,2mm/tooth ap=2mm ae=0,5D			Vc=100m/min fz=0,2mm/tooth ap=2mm ae=0,5D		
Stainless steels	640	290	3,5	510	310	4,7	640	220	4	510	260	5,9
	Vc=80m/min fz=0,15mm/tooth ap=1mm ae=0,3D			Vc=80m/min fz=0,17mm/tooth ap=1,5mm ae=0,3D			Vc=80m/min fz=0,17mm/tooth ap=1,5mm ae=0,3D			Vc=80m/min fz=0,17mm/tooth ap=1,5mm ae=0,3D		
Cast iron	640	330	6,6	510	350	8,8	640	260	7,8	510	310	11,6
	Vc=80m/min fz=0,17mm/tooth ap=1mm ae=0,5D			Vc=80m/min fz=0,2mm/tooth ap=1,5mm ae=0,5D			Vc=80m/min fz=0,2mm/tooth ap=1,5mm ae=0,5D			Vc=80m/min fz=0,2mm/tooth ap=1,5mm ae=0,5D		
Cast iron	550	160	1,9	440	170	2,5	550	110	1,3	440	130	1,9
	Vc=70m/min fz=0,1mm/tooth ap=1mm ae=0,3D			Vc=70m/min fz=0,1mm/tooth ap=1mm ae=0,3D			Vc=70m/min fz=0,1mm/tooth ap=1mm ae=0,3D			Vc=70m/min fz=0,1mm/tooth ap=1mm ae=0,3D		
Cast iron	550	160	3,2	440	170	4,2	550	110	2,2	440	130	3,2
	Vc=70m/min fz=0,1mm/tooth ap=1mm ae=0,5D			Vc=70m/min fz=0,1mm/tooth ap=1mm ae=0,5D			Vc=70m/min fz=0,1mm/tooth ap=1mm ae=0,5D			Vc=70m/min fz=0,1mm/tooth ap=1mm ae=0,5D		
Cast iron	1590	1430	34,3	1270	1520	45,6	1590	950	22,8	1270	1140	34,2
	Vc=200m/min fz=0,3mm/tooth ap=2mm ae=0,3D			Vc=200m/min fz=0,3mm/tooth ap=2mm ae=0,3D			Vc=200m/min fz=0,3mm/tooth ap=2mm ae=0,3D			Vc=200m/min fz=0,3mm/tooth ap=2mm ae=0,3D		
Cast iron	1430	2150	86	1150	2300	115	1430	1720	86	1150	2070	129,4
	Vc=180m/min fz=0,5mm/tooth ap=2mm ae=0,5D			Vc=180m/min fz=0,6mm/tooth ap=2,5mm ae=0,5D			Vc=180m/min fz=0,6mm/tooth ap=2,5mm ae=0,5D			Vc=180m/min fz=0,6mm/tooth ap=2,5mm ae=0,5D		
Cast iron	1430	2150	51,6	1150	2300	69	1430	1430	34,3	1150	1730	51,9
	Vc=180m/min fz=0,5mm/tooth ap=2mm ae=0,3D			Vc=180m/min fz=0,5mm/tooth ap=2mm ae=0,3D			Vc=180m/min fz=0,5mm/tooth ap=2mm ae=0,3D			Vc=180m/min fz=0,5mm/tooth ap=2mm ae=0,3D		
Cast iron	1430	3430	137,2	1150	3680	184	1430	2290	114,5	1150	2760	172,5
	Vc=180m/min fz=0,8mm/tooth ap=2mm ae=0,5D			Vc=180m/min fz=0,8mm/tooth ap=2,5mm ae=0,5D			Vc=180m/min fz=0,8mm/tooth ap=2,5mm ae=0,5D			Vc=180m/min fz=0,8mm/tooth ap=2,5mm ae=0,5D		

Materialien	Schnittgeschwindigkeit M/Min	Vorschubwert pro Schneide Mm/Zahn	Ø12 - Ø20			Ø24 - Ø25			Ø32 - Ø35		
			Drehung-Geschwindigkeit min ⁻¹	Vorschubwert mm/min	Q-Wert cm ³ /min	Drehung-Geschwindigkeit min ⁻¹	Vorschubwert mm/min	Q-Wert cm ³ /min	Drehung-Geschwindigkeit min ⁻¹	Vorschubwert mm/min	Q-Wert cm ³ /min
Weicher Stahl (200 HB)	150-250	0,3-0,8	3980	3180	28,6	3180	2540	28,6	2490	2990	43,1
			Vc=250m/min fz=0,4mm/Zahn ap=1,5mm ae=0,3D			3980			3180 2540 47,6 2490 2990 71,8		
Kohlenstoffstahl Legierter Stahl (30 HRC)	120-230	0,3-0,8	Vc=250m/min fz=0,4mm/Zahn ap=1,5mm ae=0,5D			3180 2540 22,9 2550 2040 23 1990 2390 34,4					
			3180	2540	22,9	2550	2040	23	1990	2390	34,4
Kohlenstoffstahl Legierter Stahl (30-40 HRC)	100-200	0,2-0,6	Vc=200m/min fz=0,4mm/Zahn ap=1,5mm ae=0,3D			3180 2540 38,1 2550 2040 38,3 1990 2390 57,4					
			3180	2540	38,1	2550	2040	38,3	1990	2390	57,4
Kohlenstoffstahl Legierter Stahl (40-45 HRC)	60-150	0,15-0,3	Vc=200m/min fz=0,4mm/Zahn ap=1,5mm ae=0,5D			2390 960 8,6 1910 760 8,6 1490 890 12,8					
			2390	960	8,6	1910	760	8,6	1490	890	12,8
Kohlenstoffstahl Legierter Stahl (45-50 HRC)	60-100	0,15-0,3	Vc=150m/min fz=0,2mm/Zahn ap=1,5mm ae=0,3D			2390 1430 21,5 1910 1150 21,6 1490 1340 32,2					
			2390	1430	21,5	1910	1150	21,6	1490	1340	32,2
Legierter Stahl (50-60 HRC)	50-100	0,05-0,2	Vc=150m/min fz=0,2mm/Zahn ap=1,5mm ae=0,5D			1590 480 2,9 1270 380 2,9 990 450 4,3					
			1590	480	2,9	1270	380	2,9	990	450	4,3
Rostfreier Stahl	150-240	0,2-0,8	Vc=100m/min fz=0,15mm/Zahn ap=1mm ae=0,3D			1590 640 6,4 1270 510 6,4 990 590 9,4					
			1590	640	6,4	1270	510	6,4	990	590	9,4
Guß	100-220	0,3-1,0	Vc=100m/min fz=0,2mm/Zahn ap=1mm ae=0,5D			1270 380 2,3 1020 310 2,3 800 360 3,5					
			1270	380	2,3	1020	310	2,3	800	360	3,5
Weicher Stahl (200 HB)	150-250	0,3-0,8	Vc=80m/min fz=0,15mm/Zahn ap=1mm ae=0,3D			1270 380 3,8 1020 310 3,9 800 360 5,8					
			1270	380	3,8	1020	310	3,9	800	360	5,8
Kohlenstoffstahl Legierter Stahl (30 HRC)	120-230	0,3-0,8	Vc=80m/min fz=0,15mm/Zahn ap=1mm ae=0,5D			1110 220 1,3 890 170 1,2 690 200 1,9					
			1110	220	1,3	890	170	1,2	690	200	1,9
Kohlenstoffstahl Legierter Stahl (30-40 HRC)	100-200	0,2-0,6	Vc=70m/min fz=0,1mm/Zahn ap=1mm ae=0,3D			1110 220 2,2 890 170 2,1 690 200 3,2					
			1110	220	2,2	890	170	2,1	690	200	3,2
Kohlenstoffstahl Legierter Stahl (40-45 HRC)	60-150	0,15-0,3	Vc=70m/min fz=0,1mm/Zahn ap=1mm ae=0,5D			3180 1590 14,3 2550 1280 14,4 1990 1490 21,5					
			3180	1590	14,3	2550	1280	14,4	1990	1490	21,5
Legierter Stahl (50-60 HRC)	50-100	0,05-0,2	Vc=200m/min fz=0,25mm/Zahn ap=1,5mm ae=0,3D			2860 1716 25,7 2290 1370 25,7 1790 1610 38,6					
			2860	1716	25,7	2290	1370	25,7	1790	1610	38,6
Rostfreier Stahl	150-240	0,2-0,8	Vc=180m/min fz=0,3mm/Zahn ap=1,5mm ae=0,5D			2860 2290 20,6 2290 1830 20,6 1790 2150 31					
			2860	2290	20,6	2290	1830	20,6	1790	2150	31
Guß	100-220	0,3-1,0	Vc=180m/min fz=0,4mm/Zahn ap=1,5mm ae=0,3D			2860 2860 42,9 2290 2290 42,9 1790 2690 64,6					
			2860	2860	42,9	2290	2290	42,9	1790	2690	64,6
Weicher Stahl (200 HB)	150-250	0,3-0,8	Vc=180m/min fz=0,5mm/Zahn ap=1,5mm ae=0,5D			2860 2860 42,9 2290 2290 42,9 1790 2690 64,6					
			2860	2860	42,9	2290	2290	42,9	1790	2690	64,6

Materialien	Ø40 - Ø42 (R6)			Ø50 - Ø52 (R6)			Ø40 - Ø42 (R8)			Ø50 - Ø52 (R8)		
	Drehung-Geschwindigkeit min ⁻¹	Vorschubwert mm/min	Q-Wert cm ³ /min	Drehung-Geschwindigkeit min ⁻¹	Vorschubwert mm/min	Q-Wert cm ³ /min	Drehung-Geschwindigkeit min ⁻¹	Vorschubwert mm/min	Q-Wert cm ³ /min	Drehung-Geschwindigkeit min ⁻¹	Vorschubwert mm/min	Q-Wert cm ³ /min
Weicher Stahl (200 HB)	1990	2990	71,8	1590	3180	95,4	1990	1990	47,8	1590	2390	71,7
	Vc=250m/min fz=0,5mm/Zahn ap=2mm ae=0,3D			Vc=250m/min fz=0,5mm/Zahn ap=2mm ae=0,3D			Vc=250m/min fz=0,5mm/Zahn ap=2mm ae=0,3D			Vc=250m/min fz=0,5mm/Zahn ap=2mm ae=0,3D		
Kohlenstoffstahl Legierter Stahl (30 HRC)	1990	4780	191,2	1590	5090	254,5	1990	3180	159	1590	3820	238,8
	Vc=250m/min fz=0,8mm/Zahn ap=2mm ae=0,5D			Vc=250m/min fz=0,8mm/Zahn ap=2mm ae=0,5D			Vc=250m/min fz=0,8mm/Zahn ap=2,5mm ae=0,5D			Vc=250m/min fz=0,8mm/Zahn ap=2,5mm ae=0,5D		
Kohlenstoffstahl Legierter Stahl (30-40 HRC)	1590	1910	45,8	1270	2030	60,9	1590	1270	30,5	1270	1520	45,6
	Vc=200m/min fz=0,4mm/Zahn ap=2mm ae=0,3D			Vc=200m/min fz=0,4mm/Zahn ap=2mm ae=0,3D			Vc=200m/min fz=0,4mm/Zahn ap=2mm ae=0,3D			Vc=200m/min fz=0,4mm/Zahn ap=2mm ae=0,3D		
Kohlenstoffstahl Legierter Stahl (40-45 HRC)	1590	2860	114,4	1270	3050	152,5	1590	1910	95,5	1270	2290	143,1
	Vc=200m/min fz=0,6mm/Zahn ap=2mm ae=0,5D			Vc=200m/min fz=0,6mm/Zahn ap=2,5mm ae=0,5D			Vc=200m/min fz=0,6mm/Zahn ap=2,5mm ae=0,5D			Vc=200m/min fz=0,6mm/Zahn ap=2,5mm ae=0,5D		
Legierter Stahl (50-60 HRC)	1190	710	17	960	770	23,1	1190	480	11,5	960	580	17,4
	Vc=150m/min fz=0,2mm/Zahn ap=2mm ae=0,3D			Vc=150m/min fz=0,2mm/Zahn ap=2mm ae=0,3D			Vc=150m/min fz=0,2mm/Zahn ap=2mm ae=0,3D			Vc=150m/min fz=0,2mm/Zahn ap=2mm ae=0,3D		
Kohlenstoffstahl Legierter Stahl (45-50 HRC)	1190	1070	42,8	960	1150	57,5	1190	950	47,5	960	1150	71,9
	Vc=150m/min fz=0,3mm/Zahn ap=2mm ae=0,5D			Vc=150m/min fz=0,4mm/Zahn ap=2,5mm ae=0,5D			Vc=150m/min fz=0,4mm/Zahn ap=2,5mm ae=0,5D			Vc=150m/min fz=0,4mm/Zahn ap=2,5mm ae=0,5D		
Rostfreier Stahl	800	360	6,5	640	380	8,6	800	240	4,3	640	290	6,5
	Vc=100m/min fz=0,15mm/Zahn ap=1,5mm ae=0,3D			Vc=100m/min fz=0,15mm/Zahn ap=1,5mm ae=0,3D			Vc=100m/min fz=0,15mm/Zahn ap=1,5mm ae=0,3D			Vc=100m/min fz=0,15mm/Zahn ap=1,5mm ae=0,3D		
Guß	800	480	14,4	640	510	19,1	800	320	12,8	640	380	19
	Vc=100m/min fz=0,2mm/Zahn ap=1,5mm ae=0,5D			Vc=100m/min fz=0,2mm/Zahn ap=2mm ae=0,5D			Vc=100m/min fz=0,2mm/Zahn ap=2mm ae=0,5D			Vc=100m/min fz=0,2mm/Zahn ap=2mm ae=0,5D		
Weicher Stahl (200 HB)	640	290	3,5	510	310	4,7	640	220	4	510	260	5,9
	Vc=80m/min fz=0,15mm/Zahn ap=1mm ae=0,3D			Vc=80m/min fz=0,17mm/Zahn ap=1,5mm ae=0,5D			Vc=80m/min fz=0,17mm/Zahn ap=1,5mm ae=0,5D			Vc=80m/min fz=0,2mm/Zahn ap=1,5mm ae=0,5D		
Kohlenstoffstahl Legierter Stahl (30 HRC)	640	330	6,6	510	350	8,8	640	260	7,8	510	310	11,6
	Vc=80m/min fz=0,17mm/Zahn ap=1mm ae=0,5D			Vc=80m/min fz=0,2mm/Zahn ap=1,5mm ae=0,5D			Vc=80m/min fz=0,2mm/Zahn ap=1,5mm ae=0,5D			Vc=80m/min fz=0,2mm/Zahn ap=1,5mm ae=0,5D		
Kohlenstoffstahl Legierter Stahl (30-40 HRC)	550	160	1,9	440	170	2,5	550	110	1,3	440	130	1,9
	Vc=70m/min fz=0,1mm/Zahn ap=1mm ae=0,3D			Vc=70m/min fz=0,1mm/Zahn ap=1mm ae=0,3D			Vc=70m/min fz=0,1mm/Zahn ap=1mm ae=0,3D			Vc=70m/min fz=0,1mm/Zahn ap=1mm ae=0,3D		
Kohlenstoffstahl Legierter Stahl (40-45 HRC)	550	160	3,2	440	170	4,2	550	110	2,2	440	130	3,2
	Vc=70m/min fz=0,1mm/Zahn ap=1mm ae=0,5D			Vc=70m/min fz=0,1mm/Zahn ap=1mm ae=0,5D			Vc=70m/min fz=0,1mm/Zahn ap=1mm ae=0,5D			Vc=70m/min fz=0,1mm/Zahn ap=1mm ae=0,5D		
Legierter Stahl (50-60 HRC)	1590	1430	34,3	1270	1520	45,6	1590	950	22,8	1270	1140	34,2
	Vc=200m/min fz=0,3mm/Zahn ap=2mm ae=0,3D			Vc=200m/min fz=0,3mm/Zahn ap=2mm ae=0,3D			Vc=200m/min fz=0,3mm/Zahn ap=2mm ae=0,3D			Vc=200m/min fz=0,3mm/Zahn ap=2mm ae=0,3D		
Rostfreier Stahl	1430	2150	86	1150	2300	115	1430	1720	86	1150	2070	129,4
	Vc=180m/min fz=0,5mm/Zahn ap=2mm ae=0,5D			Vc=180m/min fz=0,6mm/Zahn ap=2,5mm ae=0,5D			Vc=180m/min fz=0,6mm/Zahn ap=2,5mm ae=0,5D			Vc=180m/min fz=0,6mm/Zahn ap=2,5mm ae=0,5D		
Guß	1430	2150	51,6	1150	2300	69	1430	1430	34,3	1150	1730	51,9
	Vc=180m/min fz=0,5mm/Zahn ap=2mm ae=0,3D			Vc=180m/min fz=0,5mm/Zahn ap=2mm ae=0,3D			Vc=180m/min fz=0,5mm/Zahn ap=2mm ae=0,3D			Vc=180m/min fz=0,5mm/Zahn ap=2mm ae=0,3D		
Weicher Stahl (200 HB)	1430	3430	137,2	1150	3680	184	1430	2290	114,5	1150	2760	172,5
	Vc=180m/min fz=0,8mm/Zahn ap=2mm ae=0,5D			Vc=180m/min fz=0,8mm/Zahn ap=2mm ae=0,5D			Vc=180m/min fz=0,8mm/Zahn ap=2,5mm ae=0,5D			Vc=180m/min fz=0,8mm/Zahn ap=2,5mm ae=0,5D		



Note for above table

- In the table shown above, cutting conditions indicate regular type conditions for flank wear to be 0,3mm in 30 minutes.
- The following formula shows the chip removal volume (Q) per unit time.
 $Q(\text{cm}^3/\text{min}) = a_p(\text{mm}) \times a_e(\text{mm}) \times V_f(\text{mm}/\text{min}) / 1000$
- In the case of slotting, feed speed could be down to 70% of the whole.
- Above table shows starting points of general cutting conditions. Please adjust according to rigidity of machine tools, tooling, conditions of work-pieces and so on.
- In steel exceeding 60HRC, please set the feed value (fz) per one edge about 1/2.

Recommended cutting conditions

Material	Cutting speed Vc (m/min)	Per-flute feed rate fz (mm/tooth)	Ø63 (R6)			Ø80 (R6)			Ø100 (R6)		
			Rotation speed min ⁻¹	Feed rate mm/min	Q value cm ³ /min	Rotation speed min ⁻¹	Feed rate mm/min	Q value cm ³ /min	Rotation speed min ⁻¹	Feed rate mm/min	Q value cm ³ /min
Mild steels (200 HB)	150-250	0,3-0,8	-	3780	142,9	-	-	-	-	-	-
			Vc=250m/min fz=0,5mm/tooth ap=2mm ae=0,3D			Vc=250m/min fz=0,8mm/tooth ap=2mm ae=0,5D			Vc=250m/min fz=0,8mm/tooth ap=2mm ae=0,5D		
			1260	6050	381,2	1000	4800	384	800	3200	320
Carbon steels Alloyed steels (30 HRC)	120-230	0,3-0,8	1010	2420	91,5	-	-	-	-	-	-
			Vc=200m/min fz=0,4mm/tooth ap=2mm ae=0,3D			Vc=200m/min fz=0,6mm/tooth ap=2mm ae=0,5D			Vc=200m/min fz=0,6mm/tooth ap=2mm ae=0,5D		
			1010	3640	229,3	800	2800	230,4	640	1920	192
Carbon steels Alloyed steels (30-40 HRC)	100-200	0,2-0,6	760	910	34,4	-	-	-	-	-	-
			Vc=150m/min fz=0,2mm/tooth ap=2mm ae=0,3D			Vc=150m/min fz=0,3mm/tooth ap=2mm ae=0,5D			Vc=150m/min fz=0,3mm/tooth ap=2mm ae=0,5D		
			760	1370	86,3	600	1080	86,4	480	720	72
Carbon steels Alloyed steels (40-45 HRC)	60-150	0,15-0,3	510	460	13	-	-	-	-	-	-
			Vc=100m/min fz=0,15mm/tooth ap=1,5mm ae=0,3D			Vc=100m/min fz=0,2mm/tooth ap=1,5mm ae=0,5D			Vc=100m/min fz=0,2mm/tooth ap=1,5mm ae=0,5D		
			510	610	28,8	400	480	28,8	320	320	24
Carbon steels Alloyed steels (45-50 HRC)	60-100	0,15-0,3	400	360	6,8	-	-	-	-	-	-
			Vc=80m/min fz=0,15mm/tooth ap=1mm ae=0,3D			Vc=80m/min fz=0,17mm/tooth ap=1mm ae=0,5D			Vc=80m/min fz=0,17mm/tooth ap=1mm ae=0,5D		
			400	410	12,9	320	330	13,2	250	210	10,5
Alloyed steels (50-60 HRC)	50-100	0,05-0,2	350	210	3,9	270	160	3,8	220	110	3,3
			Vc=70m/min fz=0,1mm/tooth ap=1mm ae=0,3D			Vc=70m/min fz=0,1mm/tooth ap=1mm ae=0,5D			Vc=70m/min fz=0,1mm/tooth ap=1mm ae=0,5D		
			350	210	6,6	270	160	6,4	220	110	5,5
Stainless steels	150-240	0,2-0,8	1010	1820	68,8	-	-	-	-	-	-
			Vc=200m/min fz=0,3mm/tooth ap=2mm ae=0,3D			Vc=180m/min fz=0,5mm/tooth ap=2mm ae=0,5D			Vc=180m/min fz=0,5mm/tooth ap=2mm ae=0,5D		
			910	2730	172	720	2160	172,8	570	1430	143
Cast iron	100-220	0,3-1,0	910	2730	103,2	-	-	-	-	-	-
			Vc=180m/min fz=0,5mm/tooth ap=2mm ae=0,3D			Vc=180m/min fz=0,5mm/tooth ap=2mm ae=0,3D			Vc=180m/min fz=0,8mm/tooth ap=2mm ae=0,5D		
			910	4370	275,3	720	3640	276,8	570	2280	228

Field data

Ramping, helical milling, feeding toward Z-AXIS

There are restrictions to ramp angle (α) and cutting depth (g) toward Z-axis because of the design of the cutting edge.

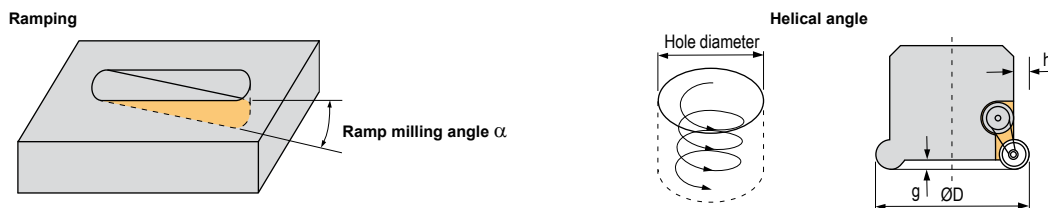

ØD	Ø40	Ø50 - Ø52	Ø63 - Ø66	Ø80	Ø100	Ø125 - Ø160
Recommended α	Below 3 degrees					Below 2 degrees
h	2,5	2,5	2,5	2,5	2,5	2,5
g	3,7	3,3	5,5	5,5	5,5	5,5
Helical hole diameter	60-78	77-100	101-124	135-158	175-198	248-255

Note

- Chips may be shattered. The wearing of safety glasses and the guard are required in the vicinity of machining.

Bemerkung zur oberer Tabelle

- Auf dieser Tabelle zeigen sich die Schnittbedingungen, die regelmäßige Fräs-Bedingungen für das Flankenverschleiß um 0,3 Mm in 30 Minuten sind.
- Folgende Formel zeigt das Spanabfuhrvolumen (Q) pro Einheitszeit.

$$Q \text{ (Cm}^3\text{/Min)} = a_p \text{ (mm)} \times a_e \text{ (mm)} \times V_f \text{ (Mm/Min)} / 1000$$
- Beim Nuteneinstechen sollte die Vorschub-Geschwindigkeit bis zu 70 % des Ganzen niedriger sein.
- Diese Tabelle zeigt die Startpunkte von allgemeinen Schnittbedingungen. Diese sollen entsprechend der Stabilität der Werkzeugmaschinen, der Bearbeitung, den Bedingungen von Werkstücken usw. angepaßt werden.
- In Stahl, der härter als 60 HRC ist, setzen Sie bitte das Schneidenwert (fz) auf die Hälfte.

Empfohlene Schnittdaten

Materialien	Schnitt-Geschwindigkeit M/Min	Vorschubwert pro Schneide Mm/Zahn	Ø63 (R6)			Ø80 (R6)			Ø100 (R6)		
			Drehung-Geschwindigkeit min ⁻¹	Vorschubwert mm/min	Q-Wert cm ³ /min	Drehung-Geschwindigkeit min ⁻¹	Vorschubwert mm/min	Q-Wert cm ³ /min	Drehung-Geschwindigkeit min ⁻¹	Vorschubwert mm/min	Q-Wert cm ³ /min
Weicher Stahl (200 HB)	150-250	0,3-0,8	-	3780	142,9	-	-	-	-	-	-
			Vc=250m/min fz=0,5mm/Zahn ap=2mm ae=0,3D								
			1260	6050	381,2	1000	4800	384	800	3200	320
Kohlenstoffstahl Legierter Stahl (30 HRC)	120-230	0,3-0,8	1010	2420	91,5	-	-	-	-	-	-
			Vc=250m/min fz=0,8mm/Zahn ap=2mm ae=0,5D								
			1010	3640	229,3	800	2800	230,4	640	1920	192
Kohlenstoffstahl Legierter Stahl (30-40 HRC)	100-200	0,2-0,6	760	910	34,4	-	-	-	-	-	-
			Vc=200m/min fz=0,4mm/Zahn ap=2mm ae=0,3D								
			760	1370	86,3	600	1080	86,4	480	720	72
Kohlenstoffstahl Legierter Stahl (40-45 HRC)	60-150	0,15-0,3	510	460	13	-	-	-	-	-	-
			Vc=200m/min fz=0,6mm/Zahn ap=2mm ae=0,5D								
			510	610	28,8	400	480	28,8	320	320	24
Kohlenstoffstahl Legierter Stahl (45-50 HRC)	60-100	0,15-0,3	400	360	6,8	-	-	-	-	-	-
			Vc=100m/min fz=0,15mm/Zahn ap=1,5mm ae=0,3D								
			400	410	12,9	320	330	13,2	250	210	10,5
Legierter Stahl (50-60 HRC)	50-100	0,05-0,2	350	210	3,9	270	160	3,8	220	110	3,3
			Vc=80m/min fz=0,17mm/Zahn ap=1mm ae=0,5D								
			350	210	6,6	270	160	6,4	220	110	5,5
Rostreier Stahl	150-240	0,2-0,8	1010	1820	68,8	-	-	-	-	-	-
			Vc=70m/min fz=0,1mm/Zahn ap=1mm ae=0,3D								
			910	2730	172	720	2160	172,8	570	1430	143
Guß	100-220	0,3-1,0	910	2730	103,2	-	-	-	-	-	-
			Vc=200m/min fz=0,3mm/Zahn ap=2mm ae=0,3D								
			910	4370	275,3	720	3640	276,8	570	2280	228
Vc=180m/min fz=0,5mm/Zahn ap=2mm ae=0,3D											
Vc=180m/min fz=0,8mm/Zahn ap=2mm ae=0,5D											

Beispiel

Einwärtskopieren, Zirkularfräsen, Vorschub zur Z-Achse

Es gibt Beschränkungen zum Rampen-Winkel (α) und Schnitttiefe (g) zur Z-Achse wegen des Designs der Schneide.

Einwärtskopieren

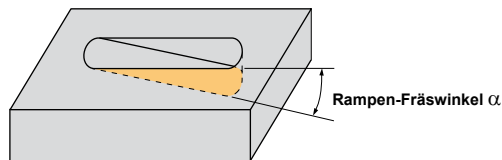

Zirkularfräsen

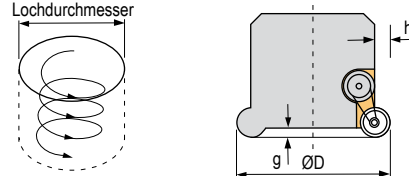

ØD	Ø40	Ø50 - Ø52	Ø63 - Ø66	Ø80	Ø100	Ø125 - Ø160
Empfohlenes α	Unter 3 Grad					Unter 2 Grad
h	2,5	2,5	2,5	2,5	2,5	2,5
g	3,7	3,3	5,5	5,5	5,5	5,5
Spiral-Lochdurchmesser	60-78	77-100	101-124	135-158	175-198	248-255

Bemerkung

- Späne können zerschmettert werden. Das Tragen der Sicherheitsbrille und die Sicherheitsabdeckung sind erforderlich in der Nähe des Bearbeitungsplatzes.



Characteristics:

General application end mill for slot milling, peripheral milling, ramp milling and drilling, pocket milling and copy milling.

Recommended for the machining of aluminium, plastics and exotic materials.

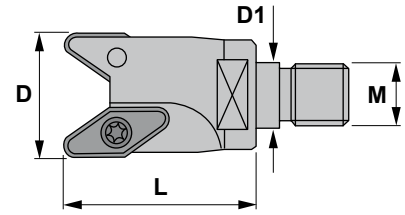

Eigenschaften:

Einschraubfräser für allgemeine Anwendungen wie Nutenfräsen, Konturfräsen, Stufenfräsen, Bohren, Taschenfräsen und Kopieren.

Für die Bearbeitung von Aluminium, Kunststoff und exotische Materialien empfohlen.

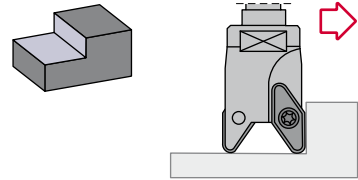

0344.06

Reference Bezeichnung		D	L	M	D1	Insert size Wendschneidplatte	
0344.06.015	2	15	35	M8	8,5	VCGT 1103..	0,040
0344.06.020	2	20	35	M10	10,5	VCGT 1103..	0,070
0344.06.025	2	25	50	M12	12,5	VCGT 1604..	0,110
0344.06.032	2	32	50	M16	17,0	VCGT 2205..	0,240
0344.06.042	3	42	50	M16	17,0	VCGT 2205..	0,400

Reference Bezeichnung			Nm
0344.06.015	1225	5507	0.9
0344.06.020	1225	5507	0.9
0344.06.025	1341	5515	3.0
0344.06.032	1250	5520	4.0
0344.06.042	1250	5520	4.0

VCGT

35° rhombic positive inserts with 7° clearance. F22
35° rhombische positive Wendschneidplatten mit 7° Freiwinkel.

Reference / Bez.	l	s	d
VCGT 1103..	11,00	3,18	6,35
VCGT 1604..	16,50	4,76	9,52
VCGT 2205..	22,10	5,56	12,70

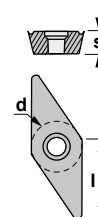

VCGT-AL



VCGT-AP





Characteristics:

General application bottom cutter for slot milling, peripheral milling, ramp milling and drilling, pocket milling and copy milling.

Recommended for the machining of aluminium, plastics and exotic materials.

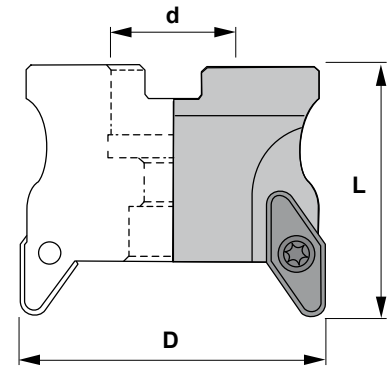

Eigenschaften:

Messerkopf für allgemeine Anwendungen wie Nutenfräsen, Konturfräsen, Stufenfräsen, Bohren, Taschenfräsen und Kopieren.

Für die Bearbeitung von Aluminium, Kunststoff und exotische Materialien empfohlen.

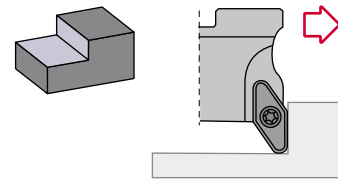

0344.90

Reference Bezeichnung		D	d	L	Insert size Wendeschneidplatte	Kg
0344.90.042	3	42	16	55	VCGT 2205..	0,180
0344.90.052	3	52	22	55	VCGT 2205..	0,350
0344.90.066	4	66	27	55	VCGT 2205..	0,800
0344.90.080	5	80	27	55	VCGT 2205..	1,150

Reference Bezeichnung			Nm
0344.90.042	1250	5520	4.0
0344.90.052	1250	5520	4.0
0344.90.066	1250	5520	4.0
0344.90.080	1250	5520	4.0

VCGT

35° rhombic positive inserts with 7° clearance. F22
35° rhombische positive Wendeschneidplatten mit 7° Freiwinkel.

Reference / Bez.	l	s	d
VCGT 2205..	22,10	5,56	12,70

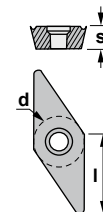

VCGT-AL



VCGT-AP



**Recommended cutting conditions
Empfohlene Schnittdaten**

Material / Materialien		Cutting speed / Schnittgeschwindigkeit	
		ZR 10 Vc (mm/min)	KM 15 Vc (mm/min)
Aluminium alloys / Aluminium-Legierungen	Rm < 280 N/mm ²	1500	1000
	Rm < 280 N/mm ²	1000	800
Copper alloys / Kupfer-Legierungen	Long chipping / Langspanend	300	250
Thermoplastics / Thermoplaste			300
Aluminium alloys / Aluminium-Legierungen	Si < 12 %	100	800
	Si < 12 %	200	
Copper alloys / Kupfer-Legierungen	Short chipping / Kurzspanend	500	400
Magnesium alloys / Magnesium-Legierungen			400
Duroplastics / Duroplaste		200	150

Maximum feed per tooth / Maximales Vorschub pro Zahn fz (mm/z) in mm

VCGT 1103..	VCGT 1604..	VCGT 2205..
0,25	0,35	0,5
0,2	0,3	0,4

**Recommendations for further applications
Weitere Anwendungsempfehlungen**

Pocket milling and axial plunging
Taschenfräsen und axiales Eintauchen

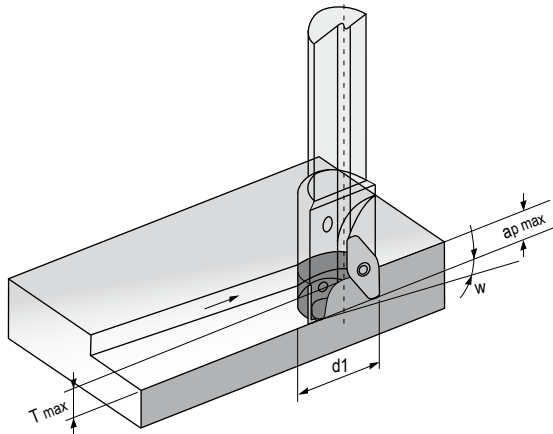

Circular milling
Zirkularfräsen

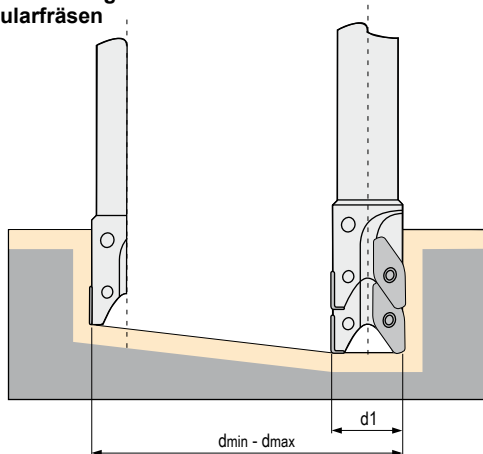

Helix angle W1 max and internal depth of cut Tmax
Helixwinkel W1 max und innere Schnitttiefe Tmax

	VCGT 110304-ALM	VCGT 160412-ALM	VCGT 220530-ALM
ap max	10	13,5	15
T max	6	8	9
W1 max degree / Grad			
15			
20	25		
25		24	
32			22
42			15
52			12
66			9
80			7

d1 mm	dmin mm	dmax mm
15	15	15
20	20	20
25	25	25
32	32	32
42	42	42
52	52	52
66	66	66
80	80	80



Characteristics:

Indexable ball nose semi-finishing and finishing cutter equipped with a positive insert that provides low cutting forces and reduced vibration.

It works well on steels, hardened steels, stainless steels and casts.

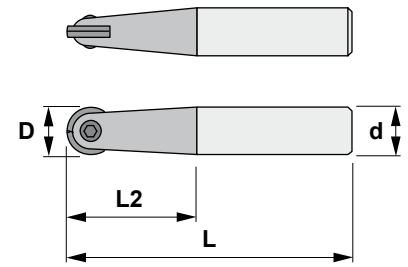

Eigenschaften:

Kugelbahnfräser zum Halb-Schlichten und Schlichten mit positiven Wendeschneidplatten, die niedrige Schnittkräfte und reduzierte Vibrationen bieten.

Für Stahl, gehärteten Stahl, rostfreien Stahl und Guß empfohlen.

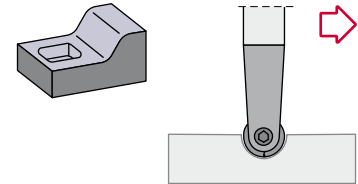

85_0

Reference Bezeichnung		D	L	L2	d	Insert size Wendeschneidplatte	
8530.00.010	2	10	105	35	12	HPR 10	0,100
8540.00.012	2	12	105	35	16	HPR 12	0,240
8550.00.016	2	16	105	45	20	HPR 16	0,260
8560.00.020	2	20	125	50	25	HPR 20	0,500
8580.00.025	2	25	125	55	32	HPR 25	0,750
8590.00.032	2	32	125	55	32	HPR 32	0,800
8530.01.010	2	10	150	50	12	HPR 10	0,200
8540.01.012	2	12	160	50	16	HPR 12	0,300
8550.01.016	2	16	180	70	20	HPR 16	0,400
8560.01.020	2	20	200	70	25	HPR 20	0,700
8580.01.025	2	25	220	100	32	HPR 25	1,250
8590.01.032	2	32	250	100	32	HPR 32	1,550

Reference Bezeichnung				Nm
8530.00.010				3.0
8540.00.012				4.0
8550.00.016				4.0
8560.00.020				4.0
8580.00.025			5530	7.0
8590.00.032			5530	7.0
8530.01.010				3.0
8540.01.012				4.0
8550.01.016				4.0
8560.01.020				4.0
8580.01.025			5530	7.0
8590.01.032			5530	7.0

HPR

Round positive insert with 11° clearance. F14
Runde positive Wendeschneidplatte mit 11° Freiwinkel.

Reference / Bezeichnung	s	d
HPR 10	2,40	10,00
HPR 12	2,50	12,00
HPR 16	3,00	16,00
HPR 20	3,00	20,00
HPR 25	4,00	25,00
HPR 32	5,00	32,00

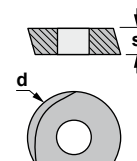



Characteristics:

Indexable ball nose semi-finishing and finishing cutter equipped with a positive insert that provides low cutting forces and reduced vibration.

It works well on steels, hardened steels, stainless steels and casts.

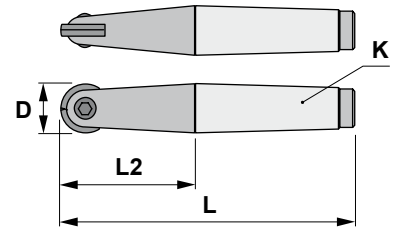

Eigenschaften:

Kugelbahnfräser zum Halb-Schlichten und Schlichten mit positiven Wendeschneidplatten, die niedrige Schnittkräfte und reduzierte Vibrationen bieten.

Für Stahl, gehärteten Stahl, rostfreien Stahl und Guß empfohlen.

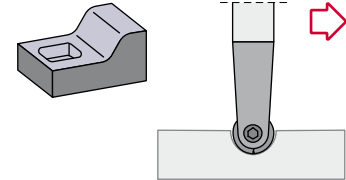

85_3

Reference Bezeichnung		D	L	K	L2	Insert size Wendeschneidplatte	
8580.34.025	2	25	215	4	135	HPR 25	1,150
8590.34.032	2	32	268	4	160	HPR 32	1,550



Reference Bezeichnung				Nm
8580.34.025	1609	-	5530	7.0
8590.34.032	1809	5515	-	3.0

HPR

Round positive insert with 11° clearance. F14
Runde positive Wendeschneidplatte mit 11° Freiwinkel.

Reference / Bez.	s	d
HPR 25	4,00	25,00
HPR 32	5,00	32,00

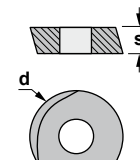

HPR





Characteristics:

Indexable ball nose semi-finishing and finishing cutter equipped with a positive insert that provides low cutting forces and reduced vibration.

It works well on steels, hardened steels, stainless steels and casts.

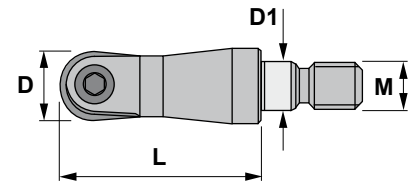

Eigenschaften:

Kugelbahnfräser zum Halb-Schlichten und Schlichten mit positiven Wendeschneidplatten, die niedrige Schnittkräfte und reduzierte Vibrationen bieten.

Für Stahl, gehärteten Stahl, rostfreien Stahl und Guß empfohlen.

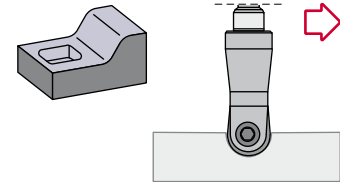

85_06

Reference Bezeichnung		D	L	M	D1	Insert size Wendeschneidplatte	
8530.06.010	2	10	23	M6	6,5	HPR 10	0,016
8540.06.012	2	12	23	M6	6,5	HPR 12	0,030
8550.06.016	2	16	30	M8	8,5	HPR 16	0,050
8560.06.020	2	20	35	M10	10,5	HPR 20	0,095
8580.06.025	2	25	40	M12	12,5	HPR 25	0,160

Reference Bezeichnung				Nm
8530.06.010	1359	5515	-	3.0
8540.06.012	1509	5520	-	4.0
8550.06.016	1519	5520	-	4.0
8560.06.020	1529	5520	-	4.0
8580.06.025	1609	-	5530	7.0

HPR

Round positive insert with 11° clearance. F14
Runde positive Wendeschneidplatte mit 11° Freiwinkel.

Reference / Bezeichnung

s

d

HPR 10	2,40	10,00
HPR 12	2,50	12,00
HPR 16	3,00	16,00
HPR 20	3,00	20,00
HPR 25	4,00	25,00

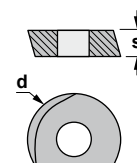

HPR





Characteristics:

Indexable ball nose mirror finishing cutter equipped with a positive insert that provides low cutting forces and reduced vibration. It works well on steels, hardened steels, stainless steels and casts.

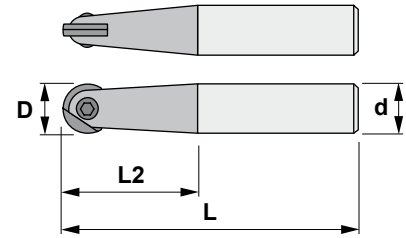

Eigenschaften:

Kugelbahnfräser zum Schlichten mit positiven Wendeschneidplatten, die niedrige Schnittkräfte und reduzierte Vibrationen bieten.

Für Stahl, gehärteten Stahl, rostfreien Stahl und Guß empfohlen.

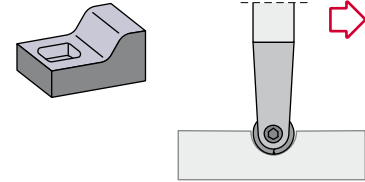

88_0

Reference Bezeichnung		D	L	d	L2	Insert size Wendeschneidplatte	
8830.00.010	2	10	105	10	50	RPR 10	0,100
8840.00.012	2	12	105	12	50	RPR 12	0,240
8850.00.016	2	16	105	16	50	RPR 16	0,260
8860.00.020	2	20	125	20	70	RPR 20	0,500
8880.00.025	2	25	125	25	70	RPR 25	0,750
8890.00.032	2	32	125	32	70	RPR 32	0,800
8830.01.010	2	10	150	10	80	RPR 10	0,200
8840.01.012	2	12	160	12	90	RPR 12	0,300
8850.01.016	2	16	180	16	100	RPR 16	0,400
8860.01.020	2	20	200	20	120	RPR 20	0,700
8880.01.025	2	25	220	25	140	RPR 25	1,250
8890.01.032	2	32	250	32	160	RPR 32	1,550

Reference Bezeichnung				Nm
8830.00.010	1353	5508	-	1.2
8840.00.012	1354	5510	-	2.0
8850.00.016	1619	5515	-	3.0
8860.00.020	1529	5520	-	4.0
8880.00.025	1609	-	5530	7.0
8890.00.032	1809	-	5530	7.0
8830.01.010	1353	5508	-	1.2
8840.01.012	1354	5510	-	2.0
8850.01.016	1619	5515	-	3.0
8860.01.020	1529	5520	-	4.0
8880.01.025	1609	-	5530	7.0
8890.01.032	1809	-	5530	7.0

RPR

Round positive insert with 11° clearance. F14
Runde positive Wendeschneidplatte mit 11° Freiwinkel.

Reference / Bezeichnung	s	d
RPR 10	2,60	10,00
RPR 12	3,00	12,00
RPR 16	4,00	16,00
RPR 20	5,00	20,00
RPR 25	6,00	25,00
RPR 32	7,00	32,00

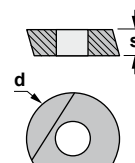



Characteristics:

Indexable ball nose mirror finishing cutter equipped with a positive insert that provides low cutting forces and reduced vibration. It works well on steels, hardened steels, stainless steels and casts.

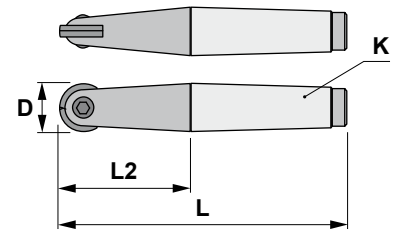

Eigenschaften:

Kugelbahnfräser zum Schlichten mit positiven Wendeschneidplatten, die niedrige Schnittkräfte und reduzierte Vibrationen bieten.

Für Stahl, gehärteten Stahl, rostfreien Stahl und Guß empfohlen.

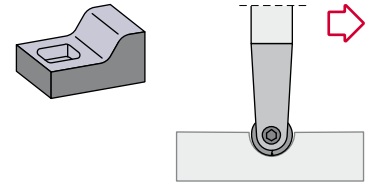

88_3

Reference Bezeichnung		D	L	K	L2	Insert size Wendeschneidplatte	
8860.30.020	2	20	190	3	115	RPR 20	0,670
8880.34.025	2	25	215	4	135	RPR 25	1,200
8890.34.032	2	32	268	4	160	RPR 32	1,650

Reference Bezeichnung				Nm
8860.30.020	1529	5520	-	4.0
8880.34.025	1609	-	5530	7.0
8890.34.032	1809	-	5530	7.0

RPR

Round positive insert with 11° clearance. F16
Runde positive Wendeschneidplatte mit 11° Freiwinkel.

Reference / Bezeichnung	s	d
RPR 20	5,00	20,00
RPR 25	6,00	25,00
RPR 32	7,00	32,00

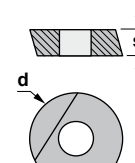

RPR





Characteristics:

Indexable ball nose mirror finishing cutter equipped with a positive insert that provides low cutting forces and reduced vibration. It works well on steels, hardened steels, stainless steels and casts.

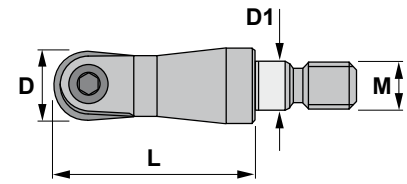

Eigenschaften:

Kugelbahnfräser zum Schlichten mit positiven Wendeschneidplatten, die niedrige Schnittkräfte und reduzierte Vibrationen bieten.

Für Stahl, gehärteten Stahl, rostfreien Stahl und Guß empfohlen.

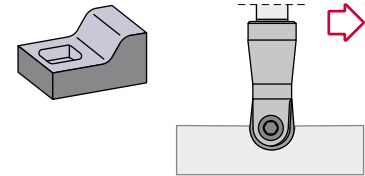

88_06

Reference Bezeichnung		D	L	K	D1	Insert size Wendeschneidplatte	
8830.06.010	2	10	23	M6	6,5	RPR 10	0,016
8840.06.012	2	12	23	M6	6,5	RPR 12	0,030
8850.06.016	2	16	30	M8	8,5	RPR 16	0,050
8860.06.020	2	20	30	M10	10,5	RPR 20	0,095
8880.06.025	2	25	35	M12	12,5	RPR 25	0,160

Reference Bezeichnung				Nm
8830.06.010	1353	5508	-	1.2
8840.06.012	1354	5510	-	2.0
8850.06.016	1619	5515	-	3.0
8860.06.020	1529	5520	-	4.0
8880.06.025	1609	-	5530	7.0

RPR

Round positive insert with 11° clearance. F16
Runde positive Wendeschneidplatte mit 11° Freiwinkel.

Reference / Bezeichnung	s	d
RPR 10	2,60	10,00
RPR 12	3,00	12,00
RPR 16	4,00	16,00
RPR 20	5,00	20,00
RPR 25	6,00	25,00

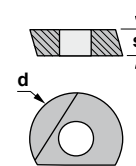

RPR



Recommended cutting conditions

Material	m/min Cutting speed	mm/tooth Feed rate	Ø8		Ø10		Ø12			
			min ⁻¹	mm/min	min ⁻¹	mm/min	min ⁻¹	mm/min		
Carbon steels Alloyed steels (30 HRC)	100-200	0,2-0,3	6370	2550	5090	2040	4240	1700		
Vc=160m/min fz=0,2mm/tooth ap=0,025D ae=0,1D										
Carbon steels Alloyed steels (30-40 HRC)	80-150	0,2-0,3	4770	1910	3820	1530	3180	1270		
Vc=120m/min fz=0,2mm/tooth ap=0,025D ae=0,1D										
Die tool steels Pre-hardened steels (30-40 HRC)	70-100	0,1-0,15	3180	640	2550	510	2120	420		
Vc=80m/min fz=0,1mm/tooth ap=0,025D ae=0,1D										
Hardened steels (55-65 HRC)	200-250	0,2-0,4	9150	3660	7320	2930	6100	2440		
Vc=230m/min fz=0,2mm/tooth ap=0,01D ae=0,02D										
Cast iron	100-200	0,3-0,4	6730	3820	5090	3050	4240	2550		
Vc=160m/min fz=0,3mm/tooth ap=0,025D ae=0,1D										

Material	m/min Cutting speed	mm/tooth Feed rate	Ø16		Ø20		Ø25		Ø30(32)	
			min ⁻¹	mm/min	min ⁻¹	mm/min	min ⁻¹	mm/min	min ⁻¹	mm/min
Carbon steels Alloyed steels (30 HRC)	100-200	0,2-0,3	2400	1600	2550	1300	2050	1030	1700	850
Vc=160m/min fz=0,25mm/tooth ap=0,05D ae=0,1D										
Carbon steels Alloyed steels (30-40 HRC)	80-150	0,2-0,3	1600	1200	1910	955	1530	765	1280	640
Vc=120m/min fz=0,25mm/tooth ap=0,05D ae=0,1D										
Die tool steels Pre-hardened steels (30-40 HRC)	70-100	0,1-0,15	3200	385	1280	310	1020	245	850	205
Vc=80m/min fz=0,12mm/tooth ap=0,05D ae=0,1D										
Hardened steels (55-65 HRC)	200-250	0,2-0,4	4575	2740	3660	2200	2930	1760	2440	1460
Vc=230m/min fz=0,3mm/tooth ap=0,01D ae=0,02D										
Cast iron	100-200	0,3-0,4	3200	2240	2550	1790	2050	1440	1700	1190
Vc=160m/min fz=0,35mm/tooth ap=0,05D ae=0,1D										

Note

- According to the machining situation, refer to the table above to determine the cutting conditions.
 - Be sure to practice safety instructions and precautions such as wearing glasses and safety shoes, and placing safety covers when you use this tool.
- This tool can be broken during machining, so failure to follow these instructions may cause personal injury.

$$n = \frac{V_c \cdot 1000}{\pi \cdot \text{Def.}} \quad (\text{Rev./min.})$$

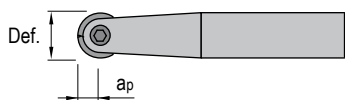

N = Spindle speed (Rev./min.)
 Vc = Cutting speed
 Def. = Effective cutting diameter
 ap = Max. Depth of cut (mm)

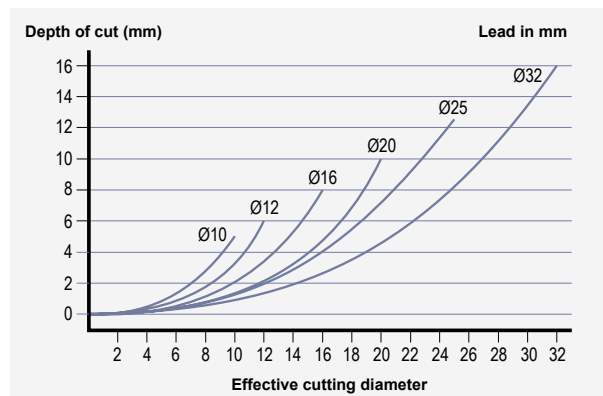

Empfohlene Schnittdaten

Materialien	mm/min Schnittgeschwindigkeit	mm/Zahn Vorschubwert	Ø8		Ø10		Ø12			
			min ⁻¹	mm/min	min ⁻¹	mm/min	min ⁻¹	mm/min		
Kohlenstoffstahl Legierter Stahl	100-200	0,2-0,3	6370	2550	5090	2040	4240	1700		
			Vc=160m/min fz=0,2mm/Zahn ap=0,025D ae=0,1D							
Kohlenstoffstahl Legierter Stahl	80-150	0,2-0,3	4770	1910	3820	1530	3180	1270		
			Vc=120m/min fz=0,2mm/Zahn ap=0,025D ae=0,1D							
Formenbaustahl Vorgehärteter Stahl	70-100	0,1-0,15	3180	640	2550	510	2120	420		
			Vc=80m/min fz=0,1mm/Zahn ap=0,025D ae=0,1D							
Gehärteter Stahl	200-250	0,2-0,4	9150	3660	7320	2930	6100	2440		
			Vc=230m/min fz=0,2mm/Zahn ap=0,01D ae=0,02D							
Guß	100-200	0,3-0,4	6730	3820	5090	3050	4240	2550		
			Vc=160m/min fz=0,3mm/Zahn ap=0,025D ae=0,1D							

Materialien	mm/min Schnittgeschwindigkeit	mm/Zahn Vorschubwert	Ø16		Ø20		Ø25		Ø30(32)	
			min ⁻¹	mm/min	min ⁻¹	mm/min	min ⁻¹	mm/min	min ⁻¹	mm/min
Kohlenstoffstahl Legierter Stahl	100-200	0,2-0,3	2400	1600	2550	1300	2050	1030	1700	850
			Vc=160m/min fz=0,25mm/Zahn ap=0,05D ae=0,1D							
Kohlenstoffstahl Legierter Stahl	80-150	0,2-0,3	1600	1200	1910	955	1530	765	1280	640
			Vc=120m/min fz=0,25mm/Zahn ap=0,05D ae=0,1D							
Formenbaustahl Vorgehärteter Stahl	70-100	0,1-0,15	3200	385	1280	310	1020	245	850	205
			Vc=80m/min fz=0,12mm/Zahn ap=0,05D ae=0,1D							
Gehärteter Stahl	200-250	0,2-0,4	4575	2740	3660	2200	2930	1760	2440	1460
			Vc=230m/min fz=0,3mm/Zahn ap=0,01D ae=0,02D							
Guß	100-200	0,3-0,4	3200	2240	2550	1790	2050	1440	1700	1190
			Vc=160m/min fz=0,35mm/Zahn ap=0,05D ae=0,1D							

Bemerkung

- Gemäß der Bearbeitungssituation, beziehen Sie sich auf der Tabelle oben, um die Schnittbedingungen zu bestimmen.
 - Sorgen Sie dafür, dass Sicherheitsinstruktionen und Vorsichtsmaßnahmen (wie das Tragen der Brille und Sicherheitsschuhe) eingehalten werden und verwenden Sie Sicherheitsabdeckungen, immer wenn Sie dieses Werkzeug einsetzen.
- Da dieses Werkzeug während der Bearbeitung brechen kann, könnte das nicht Beachten von diesen Instruktionen persönliche Verletzungen verursachen.

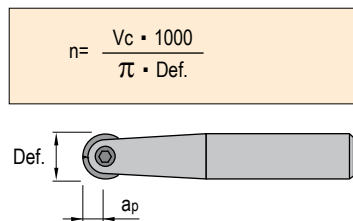

N = Spindel-Geschwindigkeit (Umdrehungen/Minute)
 Vc = Schnittgeschwindigkeit
 Def. = Wirksamer Schnittdurchmesser
 ap = Maximale Schnitttiefe (mm)

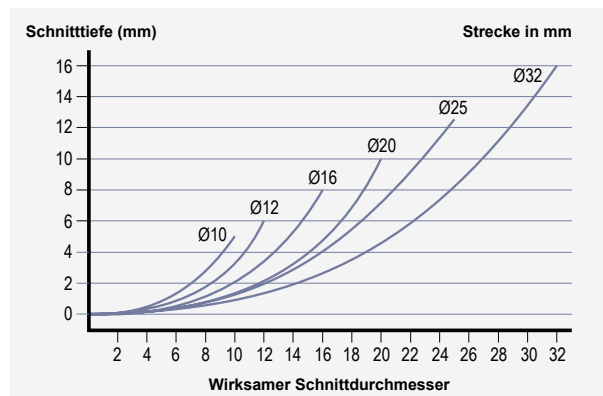

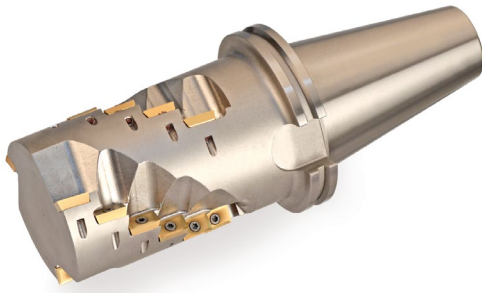

PORCUPINE CUTTERS IGELFRÄSER

Code system **F148**
Kodifizierung

Applications index **F149**
Anwendungen

Porcupine cutters **F150-152**
Igelfräser

Cutting data **F153-154**
Schnittdaten



F

Code system / Kodifizierung

2 3	3	0	50	063	65
1	2	3	4	5	6

1 Milling cutter type Fräsertyp

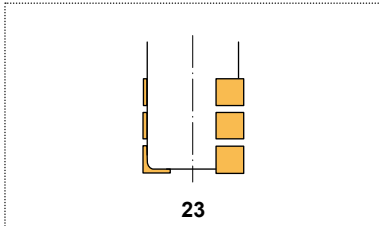

2 Insert size Wendeschneidplattengröße

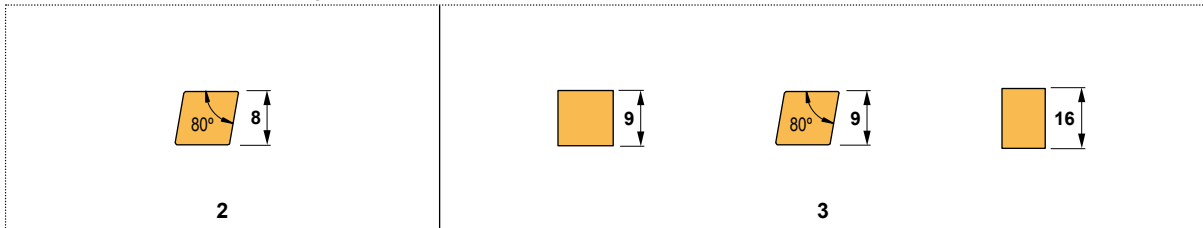

3 Clearance angle of insert Freiwinkel der Wendeschneidplatte

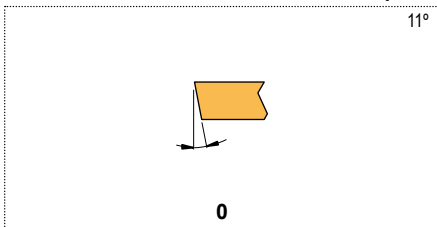

4 Type of coupling Aufnahmetyp

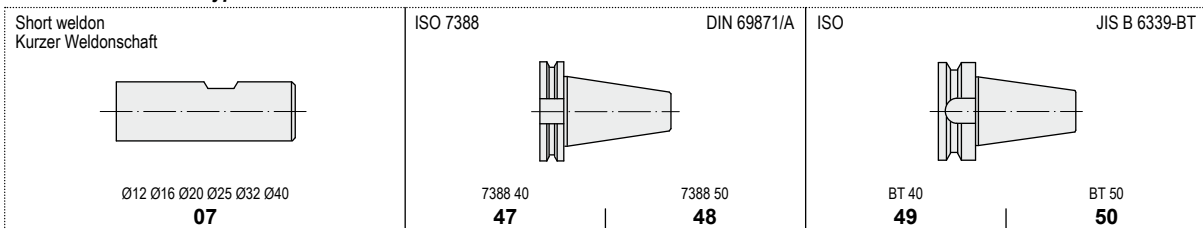

5 Diameter, mm. Durchmesser, mm.

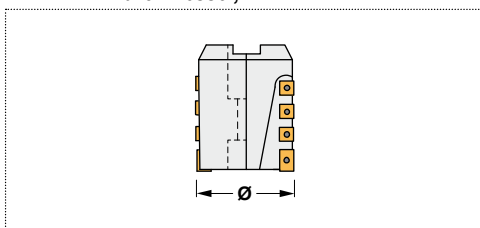

6 Cutting length Schnittlänge

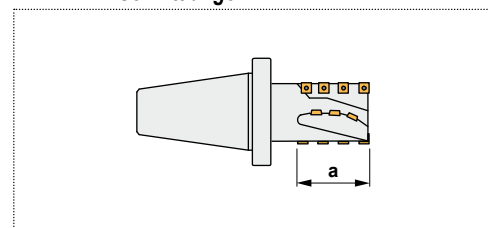

Porcupine cutters Igelfräser

2330.07

Slot and side milling 90°
Nuten- und Konturfräser 90°

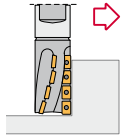

AP. 1003..
AP. 1604..

P./S. F150

2330.47
2330.48

Slot and side milling 90°
Nuten- und Konturfräser 90°

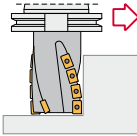

P./S. F151 AP. 1604..

2330.49
2330.50

Slot and side milling 90°
Nuten- und Konturfräser 90°

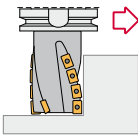

P./S. F152 AP. 1604..



F



Characteristics:

Heavy roughing milling cutter for diversified manufacture that uses very strong inserts allowing deep passes and high feed per teeth. Recommended for conventional milling machines and machining centres.

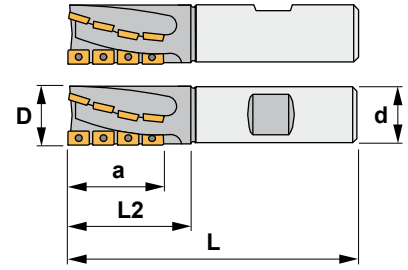

Eigenschaften:

Fräser zum schweren Schruppen mit stabilen Wendeschneidplatten, die hohe Schnitttiefen und einen hohen Vorschub pro Zahn erlauben. Für allgemeine Anwendungen in konventionellen Fräsmaschinen und Bearbeitungszentren geeignet.

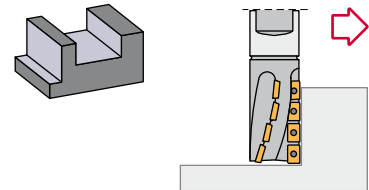

23₃0.07

Reference Bezeichnung		D	L	L2	d	a	Insert size Wendeschneidplatte	No. of inserts WSP-Anzahl	
2320.07.025.37	2	25	110	50	25	37	AP.. 1003..	8	0,400
2330.07.032.45	2	32	125	55	32	45	AP.. 1604..	6	0,650
2330.07.040.50	3	40	125	65	32	50	AP.. 1604..	12	0,800

Reference Bezeichnung			Nm
2320.07.025.37	1425	5507	0.9
2330.07.032.45	1440	5515	3.0
2330.07.040.50	1440	5515	3.0

AP.. Parallelogram positive inserts with 11° clearance. F11
Parallelogramme positive Wendeschneidplatten mit 11° Freiwinkel.

Reference / Bez.	l	s	d
AP.. 1003..	9,52	3,18	6,35
AP.. 1604..	17,00	4,76	9,52

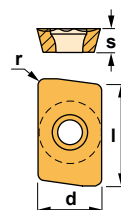

APHT-AL



APKT



APMT





Characteristics:

Heavy roughing milling cutter for diversified manufacture that uses very strong inserts allowing deep passes and high feed per teeth. Recommended for conventional milling machines and machining centres.

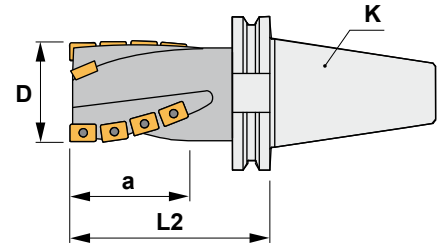

Eigenschaften:

Fräser zum schweren Schruppen mit stabilen Wendeschneidplatten, die hohe Schnitttiefen und einen hohen Vorschub pro Zahn erlauben. Für allgemeine Anwendungen in konventionellen Fräsmaschinen und Bearbeitungszentren geeignet.

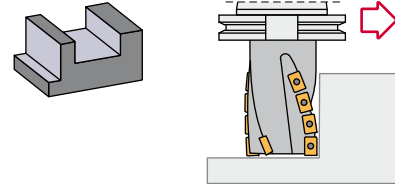

**2330.47
2330.48**

Reference Bezeichnung		D	L2	K	a	Insert size Wendeschneidplatte	No. of inserts WSP-Anzahl	
2330.47.050.65	3	50	120	40	65	AP.. 1604..	15	1,650
2330.48.050.65	3	50	130	50	65	AP.. 1604..	15	3,700
2330.48.063.65	3	63	130	50	65	AP.. 1604..	15	4,450
2330.48.080.85	3	80	140	50	80	AP.. 1604..	18	5,950

Reference Bezeichnung			Nm
2330.47.050.65	1240	5515	3.0
2330.48.050.65	1240	5515	3.0
2330.48.063.65	1240	5515	3.0
2330.48.080.85	1240	5515	3.0

AP.. Parallelogram positive inserts with 11° clearance. F11
Parallelogramme positive Wendeschneidplatten mit 11° Freiwinkel.

Reference / Bez.	l	s	d
AP.. 1604..	17,00	4,76	9,52

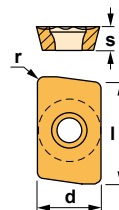

APHT-AL



APKT



APMT





Characteristics:

Heavy roughing milling cutter for diversified manufacture that uses very strong inserts allowing deep passes and high feed per teeth. Recommended for conventional milling machines and machining centres.

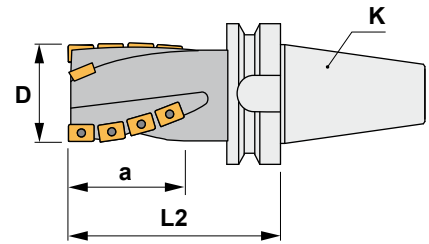

Eigenschaften:

Fräser zum schweren Schruppen mit stabilen Wendeschneidplatten, die hohe Schnitttiefen und einen hohen Vorschub pro Zahn erlauben. Für allgemeine Anwendungen in konventionellen Fräsmaschinen und Bearbeitungszentren geeignet.

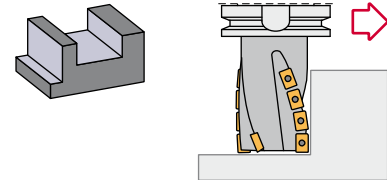

2330.49.50

Reference Bezeichnung		D	L2	K	a	Insert size Wendeschneidplatte	No. of inserts WSP-Anzahl	
2330.49.050.65	3	50	105	40	65	AP.. 1604..	12	1,700
2330.50.050.65	3	50	105	50	65	AP.. 1604..	15	3,800
2330.50.063.65	3	63	130	50	65	AP.. 1604..	15	5,100
2330.50.080.85	3	80	140	50	80	AP.. 1604..	18	6,100

Reference Bezeichnung			Nm
2330.49.050.65	1240	5515	3.0
2330.50.050.65	1240	5515	3.0
2330.50.063.65	1240	5515	3.0
2330.50.080.85	1240	5515	3.0

AP.. Parallelogram positive inserts with 11° clearance. F11
Parallelegramme positive Wendeschneidplatten mit 11° Freiwinkel.

Reference / Bez.	l	s	d
AP.. 1604..	17,00	4,76	9,52

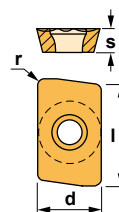

APHT-AL



APKT



APMT



Cutting data for porcupine milling cutters

Material	P	HB	Condition	Tool diameter (D mm.)	Basic grades				Feed/tooth complete slot f_2
					TIN25	TIN21	PM25	TL40	
					Cutting speed m/min.				
Unalloyed steel		110 170 250	C=0.25% C=0.8% C=1.4%	20-32 40-50	250-300 150-200 100-150		150-200 100-140 70-110	150-200 100-140 70-110	0,12-0,22 0,15-0,39
Low alloyed steel		125-225 220-450	Annealed Hardened	20-32 40-50	150-200 90-140	100-150 60-110	90-140 60-110	90-140 60-110	0,10-0,21 0,15-0,34
High alloyed steel		150-250 250-500	Annealed Hardened	20-32 40-50	130-170 90-120	80-120	80-120 50-80	80-120 50-80	0,10-0,21 0,15-0,34
Stainless steel		150-270	Ferritic / martensitic	20-32 40-50	140-190	120-160	100-130	100-130	0,12-0,22 0,15-0,34
Steel castings		150 150-220 160-200	Unalloyed Low alloyed High alloyed	20-32 40-50	130-170 110-150 80-120		80-110 50-90 50-80	80-110 50-90 50-80	0,12-0,22 0,15-0,34
Stainless steel castings		200	Ferritic / martensitic	20-32		50-80			0,10-0,21 0,15-0,34

Material	M	HB	Condition	Tool diameter (D mm.)	Basic grades				Feed/tooth complete slot f_2
					TIN25	TIN21	PM40	KM15	
					Cutting speed m/min.				
Stainless steel		150-220	Austenitic	20-32 40-50		80-160	70-130		0,12-0,23 0,15-0,37
Stainless steel castings		200	Austenitic	20-32 40-50		40-70	40-60		0,12-0,21 0,15-0,34
Heat resistant alloys Nickel or cobalt base		140-300 300-475	Annealed or solution treated Aged	20-32 40-50				15-25 12-20	0,05-0,07 0,07-0,10
Titanium alloys		300-340 320-380	Annealed or solution treated	20-32 40-50				40-80 30-60	0,07-0,10 0,10-0,15

Material	K	HB	Condition	Tool diameter (D mm.)	Basic grades				Feed/tooth complete slot f_2
					TIN25	TIN21	PM25	KM15	
					Cutting speed m/min.				
Malleable cast iron		110-145 200-230	Short chipping Long chipping	20-32 40-50				60-80 50-70	0,12-0,23 0,15-0,37
Grey cast iron		180 260	Low tensile strength High tensile strength, alloyed	20-32 40-50				70-100 50-80	0,12-0,23 0,15-0,37
Nodular cast iron Spheroidal graphite		160 250	Ferritic Pearlitic	20-32 40-50				40-60 30-50	0,10-0,21 0,15-0,34
Aluminium		60-150 40-180	Forged Cast	20-32 40-50				300-500 250-450	0,23-0,39 0,31-0,60
Bronze-brass alloys		60-150		20-32 40-50				80-120	0,15-0,31 0,23-0,39

	D/a_e	50	40	20	10	5	2,5	2	1,5	1
	f_1	4,5	4	3	2	1,5	1	1	1	1

When you trace a contour (side peripheral milling), you must multiply the f_2 value of a complete slot (see table) by the correction factor f_1 corresponding to the relationship D/a_e (milling cutter diameter/radial cutting depth) in order to get a suitable feed.



Schnittdaten für Igelfräser

Materialien	P	HB	Beschaffenheit	Werkzeug- durchmesser (D mm.)	Hauptsorten				Vorschub/Zahn (komplette Nut f ₂)
					TIN25	TIN21	PM25	TL40	
					Schnittgeschwindigkeit M/Min.				
Unlegierter Stahl		110 170 250	C=0.25% C=0.8% C=1.4%	20-32 40-50	250-300 150-200 100-150		150-200 100-140 70-110	150-200 100-140 70-110	0,12-0,22 0,15-0,39
Niedrig legierter Stahl		125-225 220-450	Geglüht Vergütet	20-32 40-50	150-200 90-140	100-150 60-110	90-140 60-110	90-140 60-110	0,10-0,21 0,15-0,34
Hochlegierter Stahl		150-250 250-500	Geglüht Vergütet	20-32 40-50	130-170 90-120	80-120	80-120 50-80	80-120 50-80	0,10-0,21 0,15-0,34
Rostfreier Stahl		150-270	Martensitisch/Ferritisch	20-32 40-50	140-190	120-160	100-130	100-130	0,12-0,22 0,15-0,34
Stahlguß		150 150-220 160-200	Unlegiert Niedrig legiert Hochlegiert	20-32 40-50	130-170 110-150 80-120		80-110 50-90 50-80	80-110 50-90 50-80	0,12-0,22 0,15-0,34
Rostfreier Stahlguß		200	Martensitisch/Ferritisch	20-32		50-80			0,10-0,21 0,15-0,34

Materialien	M	HB	Beschaffenheit	Werkzeug- durchmesser (D mm.)	Hauptsorten				Vorschub/Zahn (komplette Nut f ₂)
					TIN25	TIN21	PM40	KM15	
					Schnittgeschwindigkeit M/Min.				
Rostfreier Stahl		150-220	Austenitisch	20-32 40-50		80-160	70-130		0,12-0,23 0,15-0,37
Rostfreier Stahlguß		200	Austenitisch	20-32 40-50		40-70	40-60		0,12-0,21 0,15-0,34
Warmfeste Legierungen, Nickel- und Kobalthaltig		140-300 300-475	Geglüht oder lösungsbehandelt Gealtert	20-32 40-50				15-25 12-20	0,05-0,07 0,07-0,10
Titanlegierungen		300-340 320-380	Geglüht oder lösungsbehandelt	20-32 40-50				40-80 30-60	0,07-0,10 0,10-0,15

Materialien	K	HB	Beschaffenheit	Werkzeug- durchmesser (D mm.)	Hauptsorten				Vorschub/Zahn (komplette Nut f ₂)
					TIN25	TIN21	PM25	KM15	
					Schnittgeschwindigkeit M/Min.				
Temperguß		110-145 200-230	Kurzspanend Langspanend	20-32 40-50				60-80 50-70	0,12-0,23 0,15-0,37
Grauguß		180 260	Niedrige Zugfestigkeit Hohe Zugfestigkeit, legiert	20-32 40-50				70-100 50-80	0,12-0,23 0,15-0,37
Kugelgraphitguß		160 250	Ferritisch Perlitisch	20-32 40-50				40-60 30-50	0,10-0,21 0,15-0,34
Aluminium		60-150 40-180	Geschmiedet Gegossen	20-32 40-50				300-500 250-450	0,23-0,39 0,31-0,60
Bronze- und Messinglegierungen		60-150		20-32 40-50				80-120	0,15-0,31 0,23-0,39



D/a_e	50	40	20	10	5	2,5	2	1,5	1
f₁	4,5	4	3	2	1,5	1	1	1	1

Wenn man eine Kontur fräst (seitlich-peripherisches Fräsen), muss man den **f₂** Wert von einer kompletten Nut (siehe Tabelle) durch den Korrekturfaktor **f₁** welcher die Beziehung **D/a_e** entspricht (Durchmesser des Fräsers/Radiale Schnitttiefe) multiplizieren, damit man einen geeigneten Vorschub erhält.



SOLID CARBIDE VOLLHARTMETALL

Applications index Anwendungen	G02-09
High performance Hochleistung	G10-43
Solid carbide Vollhartmetall	G44-67
Others Andere	G68-72
Drills Bohrer	G73-88
Tungsten carbide burrs Rotierfräser	G89-93



HIGH PERFORMANCE / HOCHLEISTUNG

- Suitable
Geeignet
- Especially suitable
Besonders geeignet



Reference / Bezeichnung	6230	6240	6440	6054	6064	6164	6022
Norm / Standard	WN	WN	DIN 6527L	DIN 6527L	DIN 6527L	DIN 6527L	WN
Type / Typ	N	N	N	N	N	N	H
Length / Länge	Short / Kurz	Short / Kurz	Short / Kurz	Short / Kurz	Short / Kurz	Long / Lang	Short / Kurz
Number of flutes / Schneidenzahl	3	4	4	5	4-6	4-6	2
Spiral angle / Drallwinkel	45°	30°	39°-42°	45°	45°	45°	30°
Ø mm	3-20	3-20	3-20	6-20	3-25	3-25	1-4
Page / Seite	G10	G13	G15	G17	G20	G23	G26

Steels Stähle	<850 N/mm ²	➤➤	➤➤	➤➤	➤➤	➤➤	➤➤	➤➤
	>850 N/mm ²	➤➤		➤➤	➤➤	➤➤	➤➤	
INOX Rostfreier Stahl	<850 N/mm ²	➤➤	➤➤	➤➤	➤➤	➤➤	➤➤	➤➤
	>850 N/mm ²	➤➤		➤➤	➤➤	➤➤	➤➤	
CAST IRON GUß	Cast iron, malleable cast iron Grauguß, Temperguß	➤➤	➤➤		➤➤	➤➤	➤➤	
Ti	Titanium and titanium alloys Titan- und Titanlegierung			➤➤	➤➤	➤➤	➤➤	
Cu, Ms	Copper, brass Kupfer, Messing					➤➤	➤➤	
Al	Aluminium	➤➤	➤➤	➤➤		➤➤	➤➤	➤➤
	Plastics Kunststoffe							

Type / Typ N

For materials with normal tensile strength and hardness, up to approx. 1.100 N/mm².

Für Werkstoffe mit normaler Festigkeit und Härte, bis ca. 1.100 N/mm².

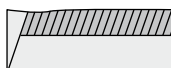

Type / Typ H

For hard and short chipping materials, up to approx. 1.400 N/mm² tensile strength.

Für harte, zähnharte und kurzspanende Werkstoffe, bis ca. 1.400 N/mm² Festigkeit.

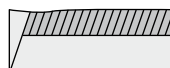

Type / Typ W

For soft, tough and long chipping materials.

Für weiche, zähe und langspanende Werkstoffe.

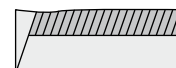

SOLID CARBIDE / VOLLHARTMETALL

- **Suitable
Geeignet**
- **Especially suitable
Besonders geeignet**



Reference / Bezeichnung	6510	6610	6520	6530	6640
Norm / Standard	WN	WN	WN	WN	DIN 6527L
Type / Typ	W	W	W	W	HR
Length / Länge	Short / Kurz	Long / Lang	Short / Kurz	Short / Kurz	Short / Kurz
Number of flutes / Schneidenzahl	1	1	2	3	4
Spiral angle / Drallwinkel	30°	30°	45°	45°	45°
Ø mm	3-12	6-12	3-16	3-16	6-20
Page / Seite	G44	G45	G46	G47	G48

Steels Stähle	<850 N/mm ²					➤➤
	>850 N/mm ²					➤➤
INOX Rostfreier Stahl	<850 N/mm ²					➤➤
	>850 N/mm ²					➤➤
CAST IRON GUß	Cast iron, malleable cast iron Grauguß, Temperguß					➤➤
Ti	Titanium and titanium alloys Titan- und Titanlegierung					
Cu, Ms	Copper, brass Kupfer, Messing			➤➤	➤➤	
Al	Aluminium	➤➤	➤➤	➤➤	➤➤	➤➤
	Plastics Kunststoffe	➤➤	➤➤	➤➤	➤➤	

Type / Typ N

For materials with normal tensile strength and hardness, up to approx. 1.100 N/mm².

Für Werkstoffe mit normaler Festigkeit und Härte, bis ca. 1.100 N/mm².

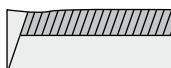

Type / Typ H

For hard and short chipping materials, up to approx. 1.400 N/mm² tensile strength.

Für harte, zähnharte und kurzspanende Werkstoffe, bis ca. 1.400 N/mm² Festigkeit.

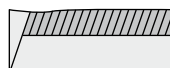

Type / Typ W

For soft, tough and long chipping materials.

Für weiche, zähe und langspanende Werkstoffe.

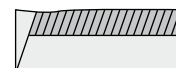

SOLID CARBIDE / VOLLHARTMETALL



6020	6021	6030	6031	6040	6041	6320	6321
WN N	WN N	WN N	WN N	WN N	WN N	WN N	WN N
Short / Kurz	Long / Lang	Short / Kurz	Long / Lang	Short / Kurz	Long / Lang	Short / Kurz	Long / Lang
2	2	3	3	4	4	2	2
30°	30°	45°	45°	30°	30°	30°	30°
1-20	1-20	1-20	1-20	1-20	1-20	2-20	2-20
G50	G52	G54	G57	G60	G62	G64	G66

»»	»»	»»	»»	»»	»»	»»	»»
»»	»»	»»	»»			»»	»»
»»	»»	»»	»»	»»	»»	»»	»»
»»	»»	»»	»»			»»	»»
»»	»»	»»	»»	»»	»»	»»	»»
»»		»»	»»	»»	»»	»»	»»



OTHERS / ANDERE

- **Suitable**
Geeignet
- **Especially suitable**
Besonders geeignet



Reference / Bezeichnung	84	86	87	88
Norm / Standard	WN	DIN 6527	DIN 6527	WN
Type / Typ	N	N	N	N
Length / Länge				
Number of flutes / Schneidenzahl	4	4-6	4-6	4
Spiral angle / Drallwinkel				90°
Ø mm	8-16	4-16	4-16	4-12
Page / Seite	G68	G69	G70	G71

Steels Stähle	<850 N/mm ²	➤➤	➤➤	➤➤	➤➤
	>850 N/mm ²	➤➤	➤➤	➤➤	➤➤
INOX Rostfreier Stahl	<850 N/mm ²	➤➤	➤➤	➤➤	➤➤
	>850 N/mm ²	➤➤	➤➤	➤➤	➤➤
CAST IRON GÜß	Cast iron, malleable cast iron Grauguß, Temperguß	➤➤	➤➤	➤➤	➤➤
Ti	Titanium and titanium alloys Titan- und Titanlegierung				
Cu, Ms	Copper, brass Kupfer, Messing	➤➤	➤➤	➤➤	➤➤
Al	Aluminium	➤➤	➤➤	➤➤	➤➤
	Plastics Kunststoffe	➤➤	➤➤	➤➤	➤➤

Type / Typ N

For materials with normal tensile strength and hardness, up to approx. 1.100 N/mm².

Für Werkstoffe mit normaler Festigkeit und Härte, bis ca. 1.100 N/mm².

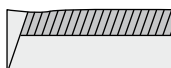

Type / Typ H

For hard and short chipping materials, up to approx. 1.400 N/mm² tensile strength.

Für harte, zäharte und kurzspanende Werkstoffe, bis ca. 1.400 N/mm² Festigkeit.

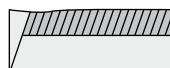



Type / Typ W

For soft, tough and long chipping materials.

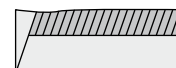
Für weiche, zähe und langspanende Werkstoffe.







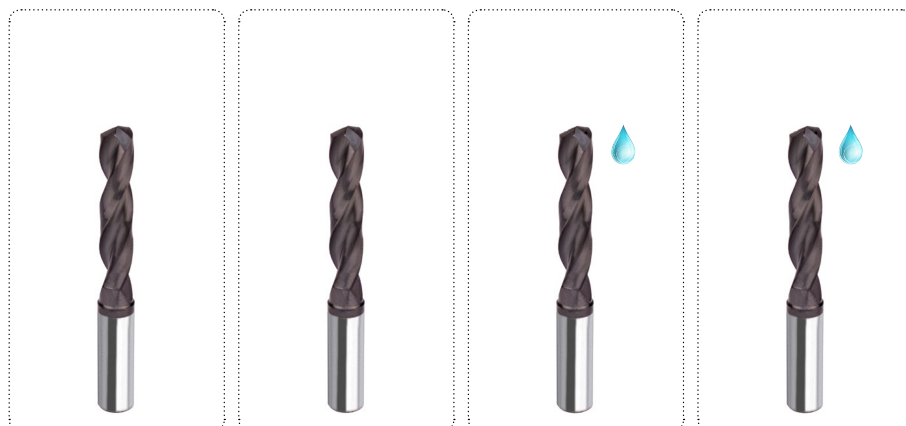





















DRILLS / BOHRER

 **Suitable**
Geeignet
 **Especially suitable**
Besonders geeignet





Reference / Bezeichnung	7320	7520	7323	7523
Norm / Standard	DIN 6537K	DIN 6537L	DIN 6537L	DIN 6537L
Type / Typ	N	N	N	N
Depth of drilling / Bohrtiefe	3xd	5xd	3xd	5xd
Number of flutes / Schneidenzahl	2	2	2	2
Coolant supply / Kühlkanäle	No / Nein	No / Nein	Yes / Ja	Yes / Ja
Spiral angle / Drallwinkel	140°	140°	140°	140°
Ø mm	3-20	3-20	3-20	3-20
Page / Seite	G73-75	G77-79	G81-83	G85-87

Steels Stähle	<850 N/mm ²				
	>850 N/mm ²				
INOX Rostfreier Stahl	<850 N/mm ²				
	>850 N/mm ²				
CAST IRON GUß	Cast iron, malleable cast iron Grauguß, Temperguß				
Ti	Titanium and titanium alloys Titan- und Titanlegierung				
Cu, Ms	Copper, brass Kupfer, Messing				
Al	Aluminium				
	Plastics Kunststoffe				







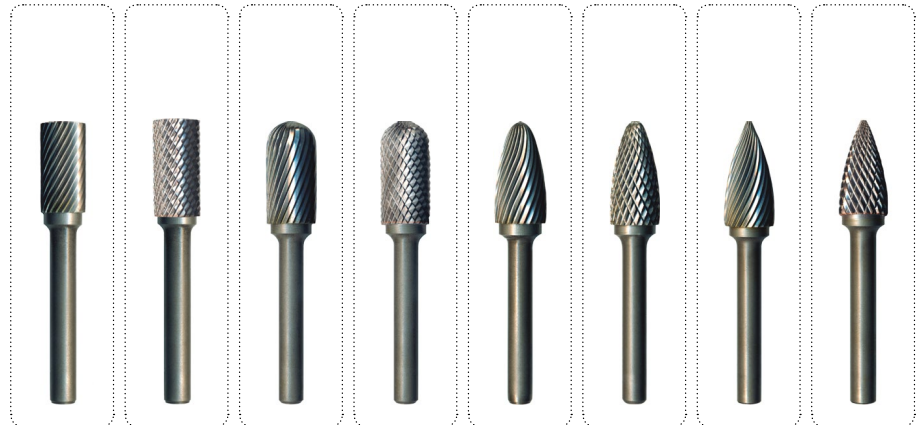





TUNGSTEN CARBIDE BURRS / ROTIERFRÄSER

 **Suitable**
Geeignet
 **Especially suitable**
Besonders geeignet



Reference / Bezeichnung	900	901	910	911	920	921	930	931
Ø mm	3-16	3-16	3-16	3-16	3-16	3-16	3-16	3-16
Page / Seite	G89	G89	G89	G89	G90	G90	G90	G90

Cutting profile
Zahnung

	A Straight Gerade Zahnung								
	B Crossed Wechselzahnung								

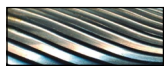

Straight
Gerade Zahnung

For general purposes such as deburring, chamfering and smoothing edges with clean surface.
Suitable for steels with high tensile strength and welding seams.

Für allgemeine Arbeiten wie Entgraten, Fasen, Kantenbrechen mit sauberer Oberfläche.
Für Stähle mit hoher Festigkeit und für Schweißnähte.



Crossed
Wechselzahnung

Suitable for hardened steels with excellent surface quality and welding seams with high tensile strength.
Hohe Oberflächengüte für gehärtete Stähle und für Schweißnähte mit hoher Festigkeit.

TUNGSTEN CARBIDE BURRS / ROTIERFRÄSER



940	941	950	951	960	961	970	971	98	99
3-16 G91	3-16 G91	3-16 G91	3-16 G91	3-16 G92	3-16 G92	3-16 G92	3-16 G92	6-16 G93	6-16 G93

Cutting profile
Zahnung

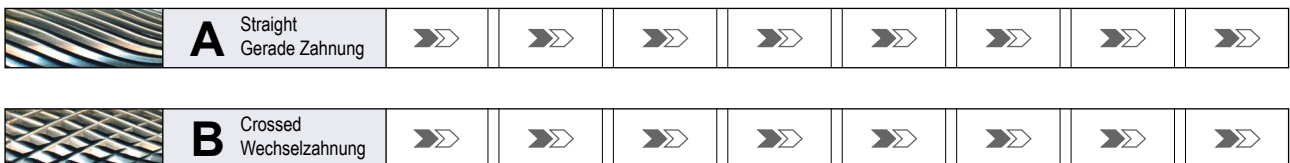

Straight
Gerade Zahnung

For general purposes such as deburring, chamfering and smoothing edges with clean surface.
Suitable for steels with high tensile strength and welding seams.

Für allgemeine Arbeiten wie Entgraten, Fasen, Kantenbrechen mit sauberer Oberfläche.
Für Stähle mit hoher Festigkeit und für Schweißnähte.



Crossed
Wechselzahnung

Suitable for hardened steels with excellent surface quality and welding seams with high tensile strength.
Hohe Oberflächengüte für gehärtete Stähle und für Schweißnähte mit hoher Festigkeit.

High performance solid carbide End Mills - Helix (Hyperlink)

Short series, three flutes



Hochleistung-VHM-Schaftfräser - Helix (Hyperlink)

Kurze Ausführung, drei Schneiden

Characteristics:

3 Fluted cutting to centre high performance solid carbide end mills with TiAlN coating. Spiral angle 35°/38°. Especially designed for slotting, contouring and finishing exotic materials. Due to the double helix angle we avoid the vibrations and get extremely high performance. The special geometry together with this coating will help you to get a soft cutting with a very long tool life. Also for universal purpose. For materials up to 55 HRC.

Eigenschaften:

3-Schneiden Hochleistung-Vollhartmetallfräser mit Zentrumschnitt und TiAlN-Beschichtung. Besonders geeignet zum Nuteneinstecken, Konturfräsen und Schlichten von exotischen Materialien. Aufgrund des doppelten Drallwinkels kann man Schwingungen vermeiden und eine höhere Leistung erreichen. Die besondere Geometrie zusammen mit der Beschichtung helfen Ihnen, einen weichen Schnitt mit einer sehr langen Standzeit zu erreichen. Auch für allgemeine Anwendungen geeignet. Für Materialien bis 55 HRC.

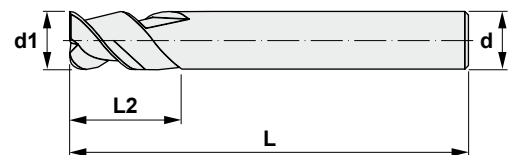
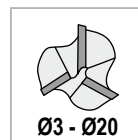
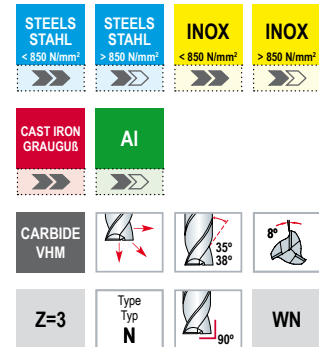

6230

Reference Bezeichnung		d1	d	L2	L
623003	3	3	6	8	50
623004	3	4	6	11	50
623005	3	5	6	13	50
623006	3	6	6	16	50
623008	3	8	8	19	60
623010	3	10	10	22	73
623012	3	12	12	26	75
623014	3	14	14	30	85
623016	3	16	16	32	92
623020	3	20	20	38	100

6230 High performance solid carbide End Mills - Helix (Hyperlink). Hochleistung-VHM-Schafffräser- Helix (Hyperlink).

Diameter / Durchmesser (Ø d1) mm	Material / Materialien											
	Unalloyed steels / Unlegierter Stahl Alloyed steels / Legierter Stahl Tool steels / Werkzeugstahl ~ HRC30 / 1000 N/mm ²				Alloyed steels / Legierter Stahl Heat resistant steels / Hitzebeständiger Stahl ~ HRC30 ~ HRC45 / 1000 ~ 1500 N/mm ²				Stainless steels / Rostfreier Stahl			
	R.P.M Min.	Feed / Vorschub mm/min.	Vc (M/Min.)	fz (mm/tooth) (Mm/Zahn)	R.P.M Min.	Feed / Vorschub mm/min.	Vc (M/Min.)	fz (mm/tooth) (Mm/Zahn)	R.P.M Min.	Feed / Vorschub mm/min.	Vc (M/Min.)	fz (mm/tooth) (Mm/Zahn)
3.0	6100	125	55	0.007	3800	85	35	0.007	3150	70	30	0.007
4.0	5150	180	65	0.012	3150	110	40	0.012	2650	90	35	0.011
5.0	4300	190	70	0.015	2550	110	40	0.014	2150	95	35	0.015
6.0	3800	210	70	0.018	2300	135	45	0.020	1950	110	35	0.019
8.0	2850	230	70	0.027	1700	120	45	0.024	1450	110	35	0.025
10.0	2200	195	70	0.030	1350	95	40	0.023	1150	95	35	0.028
12.0	1850	170	70	0.031	1150	75	45	0.022	950	75	35	0.026
14.0	1700	150	75	0.029	1050	70	45	0.022	850	70	35	0.027
16.0	1500	130	75	0.029	950	65	50	0.023	700	65	35	0.031
20.0	1150	100	70	0.029	700	50	45	0.024	550	50	35	0.030

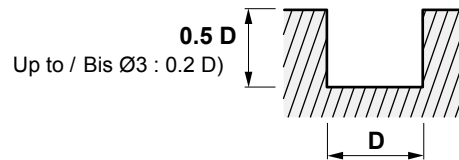

Diameter / Durchmesser (Ø d1) mm	Material / Materialien											
	Cast iron / Grauguß				Aluminium alloys / Aluminium-Legierungen				Copper, brass / Kupfer, Messing Non-ferrous metals / Nicht-Eisen-Metalle			
	R.P.M Min.	Feed / Vorschub mm/min.	Vc (M/Min.)	fz (mm/tooth) (Mm/Zahn)	R.P.M Min.	Feed / Vorschub mm/min.	Vc (M/Min.)	fz (mm/tooth) (Mm/Zahn)	R.P.M Min.	Feed / Vorschub mm/min.	Vc (M/Min.)	fz (mm/tooth) (Mm/Zahn)
3.0	6050	200	55	0.011	15400	430	145	0.009	11000	310	105	0.009
4.0	4600	185	60	0.013	11000	420	140	0.013	8800	310	110	0.012
5.0	3650	200	55	0.018	9150	420	145	0.015	6800	310	105	0.015
6.0	2950	230	55	0.026	7600	440	145	0.019	5700	340	105	0.020
8.0	2200	240	55	0.036	5700	440	145	0.026	4400	330	110	0.025
10.0	1850	255	60	0.046	4600	440	145	0.032	3400	330	105	0.032
12.0	1450	275	55	0.063	3750	430	140	0.038	2850	330	105	0.039
14.0	1300	285	55	0.073	3300	430	145	0.043	2400	330	105	0.046
16.0	1100	285	55	0.086	2850	430	145	0.050	2200	330	110	0.050
20.0	900	310	55	0.115	2200	430	140	0.065	1700	330	105	0.065

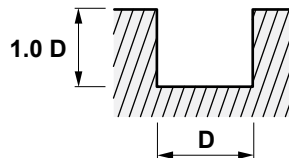

* FEED, in long and extra long types, should be reduced by around 50%.

* Bei langen und extra-langen Typen soll der Vorschub um ca.50% reduziert werden.

6230 High performance solid carbide End Mills - Helix (Hyperlink).
Hochleistung-VHM-Schaftfräser- Helix (Hyperlink).

Diameter / Durchmesser (Ø d1) mm	Material / Materialien											
	Unalloyed steels / Unlegierter Stahl Alloyed steels / Legierter Stahl Tool steels / Werkzeugstahl ~ HRC30 / 1000 N/mm ²				Alloyed steels / Legierter Stahl Heat resistant steels / Hitzebeständiger Stahl ~ HRC30 ~ HRC45 / 1000 ~ 1500 N/mm ²				Stainless steels / Rostfreier Stahl			
	R.P.M Min.	Feed / Vorschub mm/min.	Vc (M/Min.)	fz (mm/tooth) (Mm/Zahn)	R.P.M Min.	Feed / Vorschub mm/min.	Vc (M/Min.)	fz (mm/tooth) (Mm/Zahn)	R.P.M Min.	Feed / Vorschub mm/min.	Vc (M/Min.)	fz (mm/tooth) (Mm/Zahn)
3.0	7600	205	70	0.009	4750	130	45	0.009	3950	105	35	0.009
4.0	6450	365	80	0.019	3950	220	50	0.019	3300	180	40	0.018
5.0	5350	385	85	0.024	3200	230	50	0.024	2700	195	40	0.024
6.0	4750	425	90	0.030	2850	265	55	0.031	2400	215	45	0.030
8.0	3550	450	90	0.042	2150	245	55	0.038	1800	225	45	0.042
10.0	2750	390	85	0.047	1700	195	55	0.038	1450	195	45	0.045
12.0	2350	330	90	0.047	1450	160	55	0.037	1150	155	45	0.045
14.0	2100	465	90	0.074	1300	145	55	0.037	1050	140	45	0.044
16.0	1850	265	95	0.048	1150	130	60	0.038	900	130	45	0.048
20.0	1450	205	90	0.047	900	100	55	0.037	700	100	45	0.048

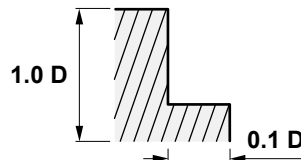

Diameter / Durchmesser (Ø d1) mm	Material / Materialien											
	Cast iron / Grauguß				Aluminium alloys / Aluminium-Legierungen				Copper, brass / Kupfer, Messing Non-ferrous metals / Nicht-Eisen-Metalle			
	R.P.M Min.	Feed / Vorschub mm/min.	Vc (M/Min.)	fz (mm/tooth) (Mm/Zahn)	R.P.M Min.	Feed / Vorschub mm/min.	Vc (M/Min.)	fz (mm/tooth) (Mm/Zahn)	R.P.M Min.	Feed / Vorschub mm/min.	Vc (M/Min.)	fz (mm/tooth) (Mm/Zahn)
3.0	6050	475	55	0.026	15400	990	145	0.021	11000	760	105	0.023
4.0	4600	485	60	0.035	11000	1035	140	0.031	8800	770	110	0.029
5.0	3650	485	55	0.044	9150	1010	145	0.037	6800	760	105	0.037
6.0	2950	570	55	0.064	7600	1100	145	0.048	5700	825	105	0.048
8.0	2200	615	55	0.093	5700	1100	145	0.064	4400	825	110	0.063
10.0	1850	640	60	0.115	4600	1100	145	0.080	3400	825	105	0.081
12.0	1450	670	55	0.154	3750	1100	140	0.098	2850	825	105	0.096
14.0	1300	705	55	0.181	3300	1100	145	0.111	2400	825	105	0.115
16.0	1100	725	55	0.220	2850	1100	145	0.129	2200	825	110	0.125
20.0	900	770	55	0.285	2200	1100	140	0.167	1700	825	105	0.162

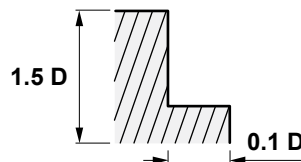

* FEED, in long and extra long types, should be reduced by around 50%.
* Bei langen und extra-langen Typen soll der Vorschub um ca.50% reduziert werden.

High performance solid carbide End Mills - Helix (Hyperlink)

Short series, four flutes



Hochleistung-VHM-Schaftfräser - Helix (Hyperlink)

Kurze Ausführung, Vier Schneiden

Characteristics:

4 Fluted cutting to centre high performance solid carbide end mills plus TiAlN coating. Spiral angle 35°/38°. Tool specially designed for slotting, contouring and finishing exotic materials.

Due to the double helix angle we avoid the vibrations and get extremely high performance. The special geometry together with this coating will help you to get a soft cutting with a very long tool life. Also for universal purpose. For materials up to 55 HRC.

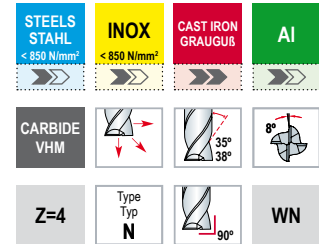

Eigenschaften:

4-Schneiden Hochleistung-Vollhartmetallfräser mit Zentrumschnitt und TiAlN-Beschichtung. Besonders geeignet zum Nuteneinstechen, Konturfräsen und Schlichten von exotischen Materialien. Aufgrund des doppelten Drallwinkels kann man Schwingungen vermeiden und eine höhere Leistung erreichen. Die besondere Geometrie zusammen mit der Beschichtung helfen Ihnen, einen weichen Schnitt mit einer sehr langen Standzeit zu erreichen. Auch für allgemeine Anwendungen geeignet. Für Materialien bis 55 HRC.

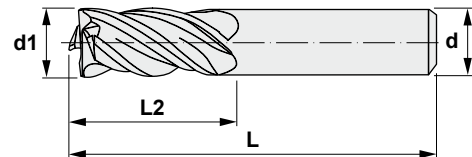
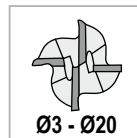

6240

Reference Bezeichnung		d1	d	L2	L
624003	4	3	6	8	50
624004	4	4	6	11	50
624005	4	5	6	13	50
624006	4	6	6	16	50
624008	4	8	8	19	60
624010	4	10	10	22	73
624012	4	12	12	26	75
624014	4	14	14	30	85
624016	4	16	16	32	92
624020	4	20	20	38	100



6240 High performance solid carbide End Mills - Helix (Hyperlink).
Hochleistung-VHM-Schaftfräser- Helix (Hyperlink).

Diameter / Durchmesser (Ø d1) mm	Material / Materialien											
	Unalloyed steels / Unlegierter Stahl Alloyed steels / Legierter Stahl Tool steels / Werkzeugstahl ~ HRC30 / 1000 N/mm ²				Alloyed steels / Legierter Stahl Heat resistant steels / Hitzebeständiger Stahl ~ HRC30 ~ HRC45 / 1000 ~ 1500 N/mm ²				Stainless steels / Rostfreier Stahl			
	R.P.M Min.	Feed / Vorschub mm/min.	Vc (M/Min.)	fz (mm/tooth) (Mm/Zahn)	R.P.M Min.	Feed / Vorschub mm/min.	Vc (M/Min.)	fz (mm/tooth) (Mm/Zahn)	R.P.M Min.	Feed / Vorschub mm/min.	Vc (M/Min.)	fz (mm/tooth) (Mm/Zahn)
3.0	7600	270	70	0.009	4750	170	45	0.009	3950	145	35	0.009
4.0	6450	485	80	0.019	3950	300	50	0.019	3300	240	40	0.018
5.0	5350	510	85	0.024	3200	305	50	0.024	2700	255	40	0.024
6.0	4750	560	90	0.029	2850	350	55	0.031	2400	280	45	0.029
8.0	3550	605	90	0.043	2150	325	55	0.038	1800	300	45	0.042
10.0	2750	520	85	0.047	1700	255	55	0.038	1450	255	45	0.044
12.0	2350	440	90	0.047	1450	215	55	0.037	1150	205	45	0.045
14.0	2100	395	90	0.047	1300	195	55	0.038	1050	190	45	0.045
16.0	1850	350	95	0.047	1150	170	60	0.037	950	170	50	0.045
20.0	1450	270	90	0.047	900	135	55	0.038	700	130	45	0.046

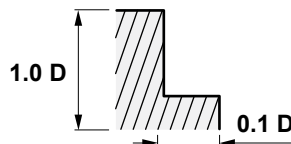

Diameter / Durchmesser (Ø d1) mm	Material / Materialien											
	Cast iron / Grauguß				Aluminium alloys / Aluminium-Legierungen				Copper, brass / Kupfer, Messing Non-ferrous metals / Nicht-Eisen-Metalle			
	R.P.M Min.	Feed / Vorschub mm/min.	Vc (M/Min.)	fz (mm/tooth) (Mm/Zahn)	R.P.M Min.	Feed / Vorschub mm/min.	Vc (M/Min.)	fz (mm/tooth) (Mm/Zahn)	R.P.M Min.	Feed / Vorschub mm/min.	Vc (M/Min.)	fz (mm/tooth) (Mm/Zahn)
3.0	6050	640	55	0.026	15400	1320	145	0.021	11000	1035	105	0.024
4.0	4600	640	60	0.035	11000	1320	140	0.030	8800	1035	110	0.029
5.0	3650	640	55	0.044	9150	1320	145	0.036	6800	1035	105	0.038
6.0	2950	770	55	0.065	7600	1430	145	0.047	5700	1100	105	0.048
8.0	2200	815	55	0.093	5700	1430	145	0.063	4400	1100	110	0.063
10.0	1850	860	60	0.116	4600	1430	145	0.078	3400	1100	105	0.081
12.0	1450	900	55	0.155	3750	1430	140	0.095	2850	1100	105	0.096
14.0	1300	945	55	0.182	3300	1430	145	0.108	2400	1100	105	0.115
16.0	1100	970	55	0.220	2850	1430	145	0.125	2200	1100	110	0.125
20.0	900	1035	55	0.288	2200	1430	140	0.163	1700	1100	105	0.162

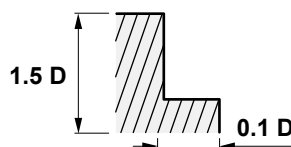

* FEED, in long and extra long types, should be reduced by around 50%.
* Bei langen und extra-langen Typen soll der Vorschub um ca.50% reduziert werden.

Solid carbide End Mill - Inox.

Four flutes

VHM-Schafffräser - Inox.

Vier Schneiden



Characteristics:

High performance carbide end mill especially suitable for cutting in austenitic stainless steels: Finishing, semi-finishing and roughing with the same tool.

Spiral angle 39°/42°. Different spiral angles effect smooth, vibrationless running and excellent surface. High cutting performance.

Eigenschaften:

Vollhartmetall-Hochleistungsfräser besonders geeignet zur Bearbeitung von austenitischen rostfreien Stählen: Schlichten, Vorschlichten und Schruppen mit einem einzigen Werkzeug. Drallwinkel 39°/42°. Die ungleiche Drallsteigung bewirkt einen ruhigen, vibrationsarmen Lauf und eine hervorragende Oberflächengüte. Hohe Zerspanungsleistung.

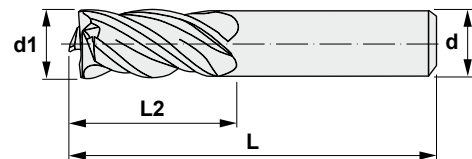
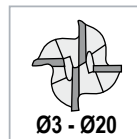
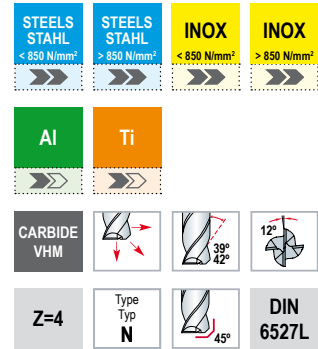

6440

Reference Bezeichnung		d1	d	L2	L
644003	4	3	6	8	50
644004	4	4	6	11	50
644005	4	5	6	13	50
644006	4	6	6	16	50
644008	4	8	8	19	60
644010	4	10	10	22	73
644012	4	12	12	26	75
644016	4	16	16	32	92
644020	4	20	20	38	100

6440 High performance solid carbide End Mills - Helix (Hyperlink).
Hochleistung-VHM-Schaftfräser- Helix (Hyperlink).

Diameter / Durchmesser (Ø d1) mm	Material / Materialien			
	Carbon steels / Kohlenstoffstahl Alloyed steels / Legierter Stahl < HRC45		Stainless steels / Rostfreier Stahl Ti alloys / Titan-Legierungen	
	R.P.M Min.	Feed / Vorschub mm/min.	R.P.M Min.	Feed / Vorschub mm/min.
3	5280	220	4400	100
4	4400	220	3630	155
5	3520	255	2970	185
6	3190	275	2640	200
8	2420	300	1980	210
10	1870	285	1540	210
12	1540	250	1320	165
16	1100	175	990	130
20	990	185	770	145

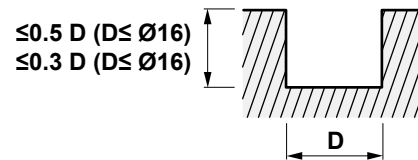
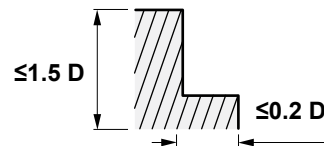

Diameter / Durchmesser (Ø d1) mm	Material / Materialien			
	Hardened steels / Gehärteter Stahl HRC45 - HRC55		Inconel	
	R.P.M Min.	Feed / Vorschub mm/min.	R.P.M Min.	Feed / Vorschub mm/min.
3	2420	50	1540	30
4	1980	45	1320	40
5	1650	100	1100	50
6	1540	100	990	50
8	1100	110	792	45
10	990	120	660	45
12	770	100	550	40
16	605	65	396	35
20	440	75	330	30

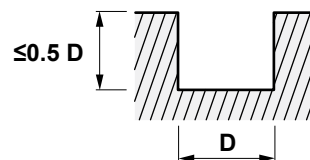
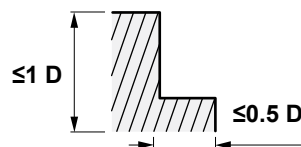

* In slotting operations use 80-100% of speed and 60-80% of feed rates.
* Beim Langlochfräsen verwenden Sie 80-100% der Geschwindigkeit und 60-80% des Vorschubs.

Solid carbide End Mills - Helix with radius

Short series, five flutes

VHM-Schafffräser - Helix mit Radius

Kurze Ausführung, fünf Schneiden



Characteristics:

High performance carbide finishing end mill for universal applications into structural steels, tool steels, treatable steels but also for stainless steels and titanium alloys up to 50 HRC.

Eigenschaften:

VHM-Hochleistungsschlichtfräser für universellen Einsatz in Baustähle, Werkzeugstähle, Vergütungsstähle, aber auch in rostfreien Stählen und Titanlegierungen bis 50 HRC.

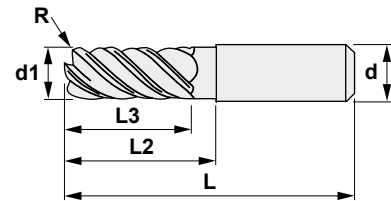
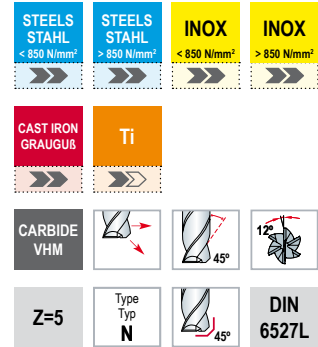

6054

Reference Bezeichnung		d1	R	d	D	L3	L2	Ø Dmin	Ø Dmax	L
6054106	5	6	0,5	6	1°	14	32	5,4	5,8	65
6054206	5	6	0,5	6	1°	14	42	5,0	5,8	65
6054306	5	6	0,5	6	1°	14	51	4,7	5,8	81
6054108	5	8	0,5	8	1°	18	42	7,2	7,8	65
6054208	5	8	0,5	8	1°	18	58	6,6	7,8	81
6054308	5	8	0,5	8	1°	18	71	6,1	7,8	109
6054110	5	10	0,5	10	1°	22	51	9,0	9,8	81
6054210	5	10	0,5	10	1°	22	71	8,3	9,8	109
6054310	5	10	0,5	10	1°	22	82	7,9	9,8	109
6054112	5	12	1,0	12	1°	26	51	11,1	11,8	81
6054212	5	12	1,0	12	1°	26	71	10,4	11,8	109
6054312	5	12	1,0	12	1°	26	86	9,9	11,8	109
6054116	5	16	2,0	16	1°	38	61	15,2	15,8	109
6054216	5	16	2,0	16	1°	38	76	14,7	15,8	109
6054316	5	16	2,0	16	1°	38	101	13,8	15,8	150
6054120	5	20	2,0	20	1°	45	71	19,1	19,8	109
6054220	5	20	2,0	20	1°	45	86	18,6	19,8	130
6054320	5	20	2,0	20	1°	45	101	18,0	19,8	150



6054 Solid carbide End Mills - Helix with radius. VHM-Schafffräser - Helix mit Radius.

Ø d1 mm	L2 mm	Material / Materialien					
		Hardened steels Gehärteter Stahl > HRC45		Alloyed steels / Legierter Stahl Cast iron GG / Grauguß GG < HRC28		Alloyed steels / Legierter Stahl Cast iron GGG / Grauguß GGG HRC28 - HRC45	
		R.P.M Min.	Feed / Vorschub mm/min.	R.P.M Min.	Feed / Vorschub mm/min.	R.P.M Min.	Feed / Vorschub mm/min.
6	32	7960	895	14590	5105	9945	3480
6	42	6630	415	9285	1045	8620	970
6	51	5440	340	7960	500	6630	415
8	42	5970	1195	10940	4375	7460	2985
8	58	4975	620	6965	1395	6465	1295
8	71	4080	510	5970	745	4975	620
10	51	4775	1435	8755	4160	5970	2835
10	71	3980	695	5570	1670	5175	1555
10	82	3265	570	4775	835	3980	695
12	51	3980	1195	7295	4010	4975	2735
12	71	3315	580	4640	1390	4310	1295
12	86	2720	475	3980	695	3315	580
16	61	2985	1195	5470	3555	3730	2425
16	76	2485	560	3480	1390	3235	1295
16	101	2040	460	2985	670	2485	560
20	71	2385	1195	4375	3720	2985	2535
20	86	1990	595	2785	1395	2585	1295
20	101	1630	490	2385	715	1990	595

Depth of cut Schnitttiefe

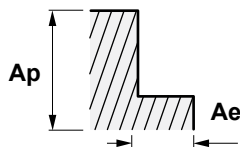

Roughing Schruppen

	A_p	A_e
short / kurz	2xd	%5 to / bis %10 x d
medium / mittel	2xd	%5 to / bis %7 x d
long / lang	1,5xd	%4 to / bis %6 x d
extra long / extra lang	1,5xd	%2 to / bis %4 x d

6054 Solid carbide End Mills - Helix with radius. VHM-Schafffräser - Helix mit Radius.

Ø d1 mm	L2 mm	Material / Materialien					
		Stainless steels / Rostfreier Stahl		Inconel		Ti alloys / Titan-Legierungen	
		R.P.M Min.	Feed / Vorschub mm/min.	R.P.M Min.	Feed / Vorschub mm/min.	R.P.M Min.	Feed / Vorschub mm/min.
6	32	9945	1120	3980	250	9285	580
6	42	7960	500	3980	170	9285	580
6	51	6630	415	3980	170	9285	580
8	42	7460	1490	2985	375	6965	1395
8	58	5970	745	2985	240	6965	870
8	71	4975	620	2985	240	6965	870
10	51	5970	1790	2385	415	5570	1670
10	71	4775	835	2385	300	5570	975
10	82	3980	695	2385	300	5570	975
12	51	4975	1495	1990	400	4640	1390
12	71	3980	695	1990	350	4640	810
12	86	3315	580	1990	350	4640	810
16	61	3730	1490	1490	335	3480	1390
16	76	2985	670	1490	355	3480	785
16	101	2485	560	1490	355	3480	785
20	71	2985	1495	1195	360	2785	1395
20	86	2385	715	1195	300	2785	835
20	101	1990	595	1195	300	2785	835

Depth of cut Schnitttiefe

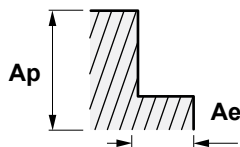

**Finishing
Schlichten**

	A_p	A_e
short / kurz	2xd	%3 x d
medium / mittel	2xd	%2 x d
long / lang	2xd	%1 x d
extra long / extra lang	2xd	%1 x d



Solid carbide End Mills. Hard cutting.
For high speed cutting (HSC) <56HRC
Short series, four-six flutes

VHM-Schafffräser. Harter Schnitt
Zum Hochgeschwindigkeitsschneiden (HSC) <56HRC
Kurze Ausführung, vier-sechs Schneiden



Characteristics:

High performance carbide finishing end mill for universal applications into structural steels, tool steels, treatable steels but also for stainless steels and titanium alloys up to 50 HRC.

Due to a very strong core and an improved face grinding with a small cutting edge chamfer, very high cutting performances with excellent surface quality will be achieved.

Eigenschaften:

VHM-Hochleistungsschichtfräser für universellen Einsatz in Baustähle, Werkzeugstähle, Vergütungsstähle, aber auch in rostfreie Stähle und Titanlegierungen bis 50 HRC.

Durch einen sehr starken Kern und einen modifizierten Stirmschliff mit einer kleinen Schnittkanten-Fase werden sehr hohe Zerspanungsleistungen mit einer hervorragenden Oberflächengüte erzielt.

STEELS STAHL < 850 N/mm ²	STEELS STAHL > 850 N/mm ²	INOX < 850 N/mm ²	INOX > 850 N/mm ²
CAST IRON GRAUGÜß	Al	Cu, Ms	Ti
CARBIDE VHM			
	Type Typ N		
Z=4-6	DIN 6527L		

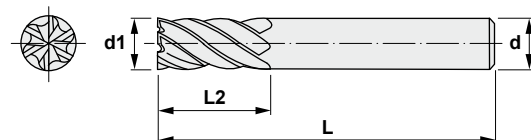
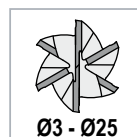

6064

Reference Bezeichnung		d1	d	L2	L
606403	4	3	3	8	38
606404	4	4	4	11	50
606405	4	5	5	13	50
606406	6	6	6	16	50
606408	6	8	8	19	60
606410	6	10	10	22	75
606412	6	12	12	26	75
606414	6	14	14	32	90
606416	6	16	16	32	100
606418	6	18	18	38	100
606420	6	20	20	38	100
606425	6	25	25	38	100

6064 Solid carbide End Mills. Hard cutting. Roughing.
VHM-Schafffräser. Harter Schnitt. Schruppen.

Diameter / Durchmesser (Ø d1) mm	Material / Materialien							
	Steels Stahl				Cast iron GG Grauguß GG		Cast iron GGG Grauguß GGG	
	<1000 N/mm ²		1000 ~ 1600 N/mm ²		<200 HB		200 ~ 300 HB	
	R.P.M Min.	Feed / Vorschub mm/min.	R.P.M Min.	Feed / Vorschub mm/min.	R.P.M Min.	Feed / Vorschub mm/min.	R.P.M Min.	Feed / Vorschub mm/min.
3	16975	4075	10610	2100	16660	4000	11670	2240
4	12730	3055	7960	1575	12495	3000	8755	1680
5	10185	2445	6365	1260	9995	2400	7000	1345
6	8490	2035	5305	1050	8330	2000	5835	1120
8	6365	2290	3980	1240	6245	2250	4375	1260
10	5095	2445	3185	1300	4995	2400	3500	1345
12	4245	2545	2655	1355	4165	2500	2920	1400
14	3640	2185	2275	1160	3570	2140	2500	1200
16	3185	1910	1990	1015	3125	1875	2190	1050
18	2830	1865	1770	955	2775	1830	1945	1015
20	2545	1835	1590	955	2500	1800	1750	1010
25	2035	1590	1270	840	2000	1560	1400	840

Diameter / Durchmesser (Ø d1) mm	Material / Materialien			
	Stainless steels / Rostfreier Stahl		Titanium alloys / Titan-Legierungen	
	R.P.M Min.	Feed / Vorschub mm/min.	R.P.M Min.	Feed / Vorschub mm/min.
3	9975	1496	7850	1180
4	7480	1122	5890	880
5	5985	898	4710	705
6	4985	748	3925	590
8	3740	561	2945	440
10	2990	898	2355	705
12	2495	897	1965	705
14	2135	769	1680	605
16	1870	673	1470	530
18	1660	698	1310	550
20	1495	718	1180	565
25	1195	575	940	450



6064 Solid carbide End Mills. Hard cutting. Finishing.
VHM-Schafffräser. Harter Schnitt. Schlichten.

Diameter / Durchmesser (Ø d1) mm	Material / Materialien							
	Steels Stahl				Cast iron GG Grauguß GG		Cast iron GGG Grauguß GGG	
	<1000 N/mm ²		1000 ~ 1600 N/mm ²		<200 HB		200 ~ 300 HB	
	R.P.M Min.	Feed / Vorschub mm/min.	R.P.M Min.	Feed / Vorschub mm/min.	R.P.M Min.	Feed / Vorschub mm/min.	R.P.M Min.	Feed / Vorschub mm/min.
3	19945	4785	13790	2730	19945	4785	14110	2710
4	14960	3590	10345	2050	14960	3590	10585	2030
5	11970	2870	8275	1640	11970	2870	8465	1625
6	9975	2395	6895	1365	9975	2395	7055	1355
8	7480	2695	5170	1615	7480	2695	5290	1525
10	5985	2870	4140	1690	5985	2870	4235	1625
12	4985	2990	3450	1760	4985	2990	3530	1695
14	4275	2565	2955	1510	4275	2565	3025	1450
16	3740	2245	2585	1320	3740	2245	2645	1270
18	3325	2195	2300	1240	3325	2195	2350	1230
20	2990	2155	2070	1240	2990	2155	2115	1220
25	2395	1865	1655	1090	2395	1865	1695	1015

Diameter / Durchmesser (Ø d1) mm	Material / Materialien			
	Stainless steels / Rostfreier Stahl		Titanium alloys / Titan-Legierungen	
	R.P.M Min.	Feed / Vorschub mm/min.	R.P.M Min.	Feed / Vorschub mm/min.
3	11990	1800	9335	1400
4	8990	1350	7000	1050
5	7195	1080	5600	840
6	5995	900	4670	700
8	4495	675	3500	525
10	3595	1080	2800	840
12	2995	1080	2335	840
14	2570	925	2000	720
16	2250	810	1750	630
18	2000	840	1555	655
20	1800	860	1400	670
25	1440	690	1120	540

Diameter / Durchmesser (Ø d1) mm	Material / Materialien									
	Prehardened steels Vorgehärteter Stahl				Hardened steels Gehärteter Stahl				Hardened steels Gehärteter Stahl	
	<35 HRC		35 - 45 HRC		46 - 55 HRC		56 - 65 HRC		66 - 70 HRC	
	R.P.M Min.	Feed / Vorschub mm/min.	R.P.M Min.	Feed / Vorschub mm/min.	R.P.M Min.	Feed / Vorschub mm/min.	R.P.M Min.	Feed / Vorschub mm/min.	R.P.M Min.	Vc (M/Min.)
3	28115	6750	27585	6620	22810	5475	17505	4200	12730	3055
4	21090	5060	20690	4965	17110	4105	13130	3150	9550	2290
5	16870	4050	16550	3970	13685	3285	10505	2520	7640	1835
6	14060	3375	13790	3310	11405	2735	8755	2100	6365	1530
8	10545	3795	10345	3725	8555	3080	6565	2365	4775	1720
10	8435	4050	8275	3970	6845	3285	5250	2520	3820	1835
12	7030	4215	6895	4140	5700	3420	4375	2625	3185	1910
14	6025	3615	5910	3545	4890	2935	3750	2250	2730	1635
16	5270	3165	5170	3105	4275	2565	3285	1970	2385	1430
18	4685	3095	4600	3035	3800	2510	2920	1925	2120	1400
20	4220	3035	4140	2980	3420	2465	2625	1890	1910	1375
25	3375	2630	3310	2580	2735	2135	2100	1640	1530	1190

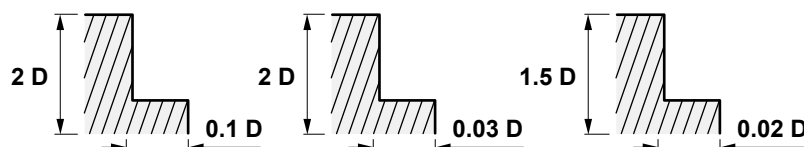

Solid carbide End Mills. Hard cutting.
For high speed cutting (HSC) <56HRC
Long series, four-six flutes

VHM-Schafffräser. Harter Schnitt
Zum Hochgeschwindigkeitsschneiden (HSC) <56HRC
Lange Ausführung, vier-sechs Schneiden



Characteristics:

High performance carbide finishing end mill for universal applications into structural steels, tool steels, treatable steels but also for stainless steels and titanium alloys up to 50 HRC.

Due to a very strong core and an improved face grinding with a small cutting edge chamfer, very high cutting performances with an excellent surface quality will be achieved.

Eigenschaften:

VHM-Hochleistungsschlichtfräser für universellen Einsatz in Baustähle, Werkzeugstähle, Vergütungsstähle, aber auch rostfreien Stählen und Titanlegierungen bis 50 HRC.

Durch einen sehr starken Kern und einen modifizierten Stirmschliff mit einer kleinen Schnittkanten-Fase werden sehr hohe Zerspanungsleistungen mit einer hervorragenden Oberflächengüte erzielt.

STEELS STAHL < 850 N/mm ²	STEELS STAHL > 850 N/mm ²	INOX < 850 N/mm ²	INOX > 850 N/mm ²
CAST IRON GRAUGUSS	Al	Cu, Ms	Ti
CARBIDE VHM			
	Type Typ N		
Z=4-6	DIN 6527L		

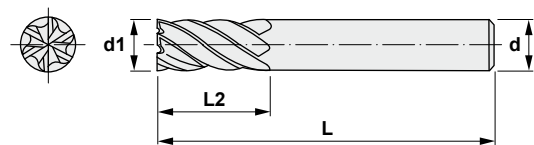

6164

Reference Bezeichnung		d1	d	L2	L
6164003	4	3	3	15	60
6164004	4	4	4	20	80
6164005	4	5	5	25	80
6164006	6	6	6	25	80
6164008	6	8	8	35	90
6164010	6	10	10	45	100
6164012	6	12	12	50	100
6164112	6	12	12	70	125
6164014	6	14	14	65	150
6164016	6	16	16	65	150
6164116	6	16	16	100	165
6164020	6	20	20	70	150
6164120	6	20	20	100	165
6164220	6	20	20	135	200
6164025	6	25	25	75	150
6164125	6	25	25	100	165
6164225	6	25	25	140	200



6164 Solid carbide End Mills. Hard cutting. Roughing.
VHM-Schafffräser. Harter Schnitt. Schruppen.

Diameter / Durchmesser (Ø d1) mm	Material / Materialien							
	Steels Stahl				Cast iron GG Grauguß GG		Cast iron GGG Grauguß GGG	
	<1000 N/mm ²		1000 ~ 1600 N/mm ²		<200 HB		200 ~ 300 HB	
	R.P.M Min.	Feed / Vorschub mm/min.	R.P.M Min.	Feed / Vorschub mm/min.	R.P.M Min.	Feed / Vorschub mm/min.	R.P.M Min.	Feed / Vorschub mm/min.
3	16975	4075	10610	2100	16660	4000	11670	2240
4	12730	3055	7960	1575	12495	3000	8755	1680
5	10185	2445	6365	1260	9995	2400	7000	1345
6	8490	2035	5305	1050	8330	2000	5835	1120
8	6365	2290	3980	1240	6245	2250	4375	1260
10	5095	2445	3185	1300	4995	2400	3500	1345
12	4245	2545	2655	1355	4165	2500	2920	1400
14	3640	2185	2275	1160	3570	2140	2500	1200
16	3185	1910	1990	1015	3125	1875	2190	1050
20	2545	1835	1590	955	2500	1800	1750	1010
25	2035	1590	1270	840	2000	1560	1400	840

Diameter / Durchmesser (Ø d1) mm	Material / Materialien			
	Stainless steels / Rostfreier Stahl		Titanium alloys / Titan-Legierungen	
	R.P.M Min.	Feed / Vorschub mm/min.	R.P.M Min.	Feed / Vorschub mm/min.
3	9975	1496	7850	1180
4	7480	1122	5890	880
5	5985	898	4710	705
6	4985	748	3925	590
8	3740	561	2945	440
10	2990	898	2355	705
12	2495	897	1965	705
14	2135	769	1680	605
16	1870	673	1470	530
20	1495	718	1180	565
25	1195	575	940	450



6164 Solid carbide End Mills. Hard cutting. Finishing.
VHM-Schafffräser. Harter Schnitt. Schlichten.

Diameter / Durchmesser (Ø d1) mm	Material / Materialien							
	Steels Stahl				Cast iron GG Grauguß GG		Cast iron GGG Grauguß GGG	
	<1000 N/mm ²		1000 ~ 1600 N/mm ²		<200 HB		200 ~ 300 HB	
	R.P.M Min.	Feed / Vorschub mm/min.	R.P.M Min.	Feed / Vorschub mm/min.	R.P.M Min.	Feed / Vorschub mm/min.	R.P.M Min.	Feed / Vorschub mm/min.
3	19945	4785	13790	2730	19945	4785	14110	2710
4	14960	3590	10345	2050	14960	3590	10585	2030
5	11970	2870	8275	1640	11970	2870	8465	1625
6	9975	2395	6895	1365	9975	2395	7055	1355
8	7480	2695	5170	1615	7480	2695	5290	1525
10	5985	2870	4140	1690	5985	2870	4235	1625
12	4985	2990	3450	1760	4985	2990	3530	1695
14	4275	2565	2955	1510	4275	2565	3025	1450
16	3740	2245	2585	1320	3740	2245	2645	1270
20	2990	2155	2070	1240	2990	2155	2115	1220
25	2395	1865	1655	1090	2395	1865	1695	1015

Diameter / Durchmesser (Ø d1) mm	Material / Materialien			
	Stainless steels / Rostfreier Stahl		Titanium alloys / Titan-Legierungen	
	R.P.M Min.	Feed / Vorschub mm/min.	R.P.M Min.	Feed / Vorschub mm/min.
3	11990	1800	9335	1400
4	8990	1350	7000	1050
5	7195	1080	5600	840
6	5995	900	4670	700
8	4495	675	3500	525
10	3595	1080	2800	840
12	2995	1080	2335	840
14	2570	925	2000	720
16	2250	810	1750	630
20	1800	860	1400	670
25	1440	690	1120	540

Diameter / Durchmesser (Ø d1) mm	Material / Materialien									
	Prehardened steels Vorgehärteter Stahl				Hardened steels Gehärteter Stahl				Hardened steels Gehärteter Stahl	
	<35 HRC		35 - 45 HRC		46 - 55 HRC		56 - 65 HRC		66 - 70 HRC	
	R.P.M Min.	Feed / Vorschub mm/min.	R.P.M Min.	Feed / Vorschub mm/min.	R.P.M Min.	Feed / Vorschub mm/min.	R.P.M Min.	Feed / Vorschub mm/min.	R.P.M Min.	Vc (M/Min.)
3	28115	6750	27585	6620	22810	5475	17505	4200	12730	3055
4	21090	5060	20690	4965	17110	4105	13130	3150	9550	2290
5	16870	4050	16550	3970	13685	3285	10505	2520	7640	1835
6	14060	3375	13790	3310	11405	2735	8755	2100	6365	1530
8	10545	3795	10345	3725	8555	3080	6565	2365	4775	1720
10	8435	4050	8275	3970	6845	3285	5250	2520	3820	1835
12	7030	4215	6895	4140	5700	3420	4375	2625	3185	1910
14	6025	3615	5910	3545	4890	2935	3750	2250	2730	1635
16	5270	3165	5170	3105	4275	2565	3285	1970	2385	1430
20	4220	3035	4140	2980	3420	2465	2625	1890	1910	1375
25	3375	2630	3310	2580	2735	2135	2100	1640	1530	1190

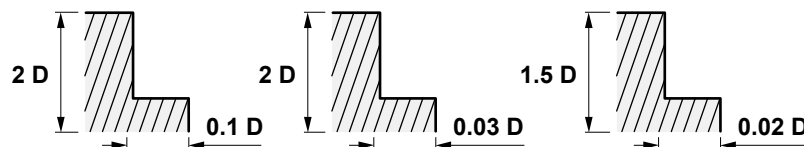

Reinforced solid carbide End Mills. Shank D6

For high speed cutting (HSC) <56HRC

Short series, two flutes

Verstärkte VHM-Schaftfräser. Schaft D6

Zum Hochgeschwindigkeitsschneiden (HSC) <56HRC

Kurze Ausführung, zwei Schneiden



Characteristics:

Recommended for milling materials with medium and high tensile strength and for HSC milling.

Eigenschaften:

Empfohlen zum Fräsen von Werkstoffen mit mittleren und hohen Zugfestigkeiten, sowie zum HSC-Fräsen.

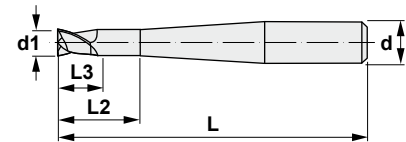
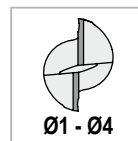
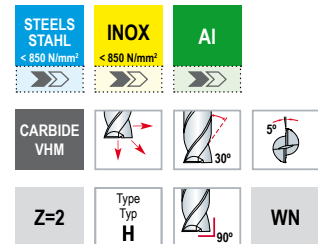

6022

Reference Bezeichnung		d1	d	L3	L2	L
6022010	2	1,0	6	1,5	5	55
6022110	2	1,0	6	1,5	12	65
6022015	2	1,5	6	1,8	5	55
6022115	2	1,5	6	1,8	12	65
6022020	2	2,0	6	2,0	10	55
6022120	2	2,0	6	2,0	16	65
6022030	2	3,0	6	2,0	9	65
6022130	2	3,0	6	2,0	15	65
6022040	2	4,0	6	2,0	12	65
6022140	2	4,0	6	2,0	20	65

**6022 Reinforced solid carbide End Mills.
Verstärkte VHM-Schaftfräser.**

Diameter / Durchmesser (Ø d1) mm	Material / Materialien							
	Carbon steels / Copper Kohlenstoffstahl / Kupfer 180 - 250 HB				Alloyed steels Legierter Stahl 25 - 35 HRC			
	Ae mm	Ap mm	R.P.M Min.	Feed / Vorschub mm/min.	Ae mm	Ap mm	R.P.M Min.	Feed / Vorschub mm/min.
1.0	0.300	0.100	36000	3240	0.270	0.090	32400	2915
1.5	0.180	0.060	25200	2070	0.162	0.054	22680	1860
2.0	0.420	0.140	21000	3150	0.378	0.126	17010	2550
3.0	0.630	0.210	16000	2400	0.567	0.189	12960	1945
4.0	0.840	0.280	11500	2300	0.756	0.252	9315	1865

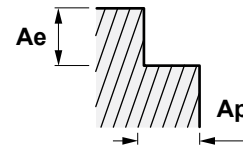
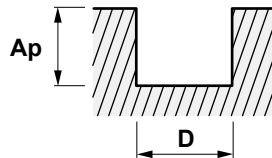

Diameter / Durchmesser (Ø d1) mm	Material / Materialien							
	Alloyed steels Legierter Stahl 35 - 45 HRC				Hardened steels Gehärteter Stahl 45 - 55 HRC			
	Ae mm	Ap mm	R.P.M Min.	Feed / Vorschub mm/min.	Ae mm	Ap mm	R.P.M Min.	Feed / Vorschub mm/min.
1.0	0.240	0.080	30600	2510	0.195	0.065	27000	1945
1.5	0.144	0.048	21420	1750	0.117	0.039	18900	1360
2.0	0.336	0.112	17850	2680	0.273	0.091	15750	1890
3.0	0.504	0.168	13600	2040	0.410	0.137	12000	1440
4.0	0.672	0.224	9775	1955	0.546	0.182	8625	1380

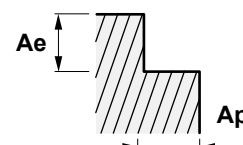
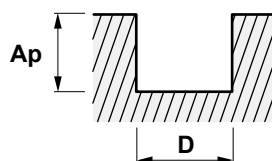

Toric-corner radius End Mills.

For high speed cutting (HSC) <62HRC

Long series, two flutes



VHM-Torus-Eckenradiusfräser

Zum Hochgeschwindigkeitsschneiden (HSC) <62HRC

Lange Ausführung, zwei Schneiden

Characteristics:

High performance carbide end mill for universal applications. Finishing, semi-finishing and roughing with the same tool. Different spiral angles effect smooth, vibrationless running and excellent surface. High cutting performance.

Eigenschaften:

Vollhartmetall-Hochleistungsfräser für allgemeine Anwendungen. Schlichten, Vorschlichten und Schruppen mit einem einzigen Werkzeug. Die ungleiche Drallsteigung bewirkt einen ruhigen, vibrationsarmen Lauf und eine hervorragende Oberflächengüte. Hohe Zerspanungsleistung.

STEELS STAHL < 850 N/mm ²	STEELS STAHL > 850 N/mm ²	INOX < 850 N/mm ²	INOX > 850 N/mm ²
CAST IRON GRAUGÜß	Al	Cu, Ms	Ti
CARBIDE VHM			
Z=2	Type Typ N	DIN 6527L	

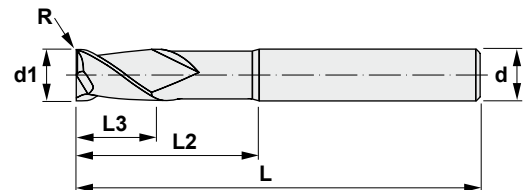

6023

Reference Bezeichnung		d1	d	L2	L3	R	L
6023001	2	1	6	5	1,5	0,25	55
6023101	2	1	6	12	1,5	0,25	65
6023002	2	2	6	10	2,0	0,2	80
6023102	2	2	6	10	2,0	0,5	80
6023202	2	2	6	10	10,0	0,2	80
6023302	2	2	6	10	10,0	0,5	80
6023003	2	3	6	15	3,0	0,2	80
6023103	2	3	6	15	3,0	0,5	80
6023203	2	3	6	15	15,0	0,2	80
6023303	2	3	6	15	15,0	0,5	80
6023004	2	4	6	20	4,0	0,2	80
6023104	2	4	6	20	4,0	0,5	80
6023204	2	4	6	20	4,0	1,0	80
6023304	2	4	6	20	20,0	0,2	80
6023404	2	4	6	20	20,0	0,5	80
6023504	2	4	6	20	20,0	1,0	80
6023005	2	5	6	25	7,0	0,2	80
6023105	2	5	6	25	7,0	0,5	80
6023205	2	5	6	25	7,0	1,0	80
6023305	2	5	6	25	25,0	0,2	80
6023405	2	5	6	25	25,0	0,5	80
6023505	2	5	6	25	25,0	1,0	80
6023006	2	6	6	13	13,0	0,2	80

6023

Reference Bezeichnung		d1	d	L2	L3	R	L
6023106	2	6	6	13	13	0,5	80
6023206	2	6	6	13	13	1,0	80
6023306	2	6	6	13	13	1,5	80
6023406	2	6	6	13	13	2,0	80
6023506	2	6	6	25	25	0,2	80
6023606	2	6	6	25	25	0,5	80
6023706	2	6	6	25	25	1,0	80
6023806	2	6	6	25	25	2,0	80
6023008	2	8	8	19	19	0,5	90
6023108	2	8	8	19	19	1,0	90
6023208	2	8	8	19	19	1,5	90
6023308	2	8	8	19	19	2,0	90
6023408	2	8	8	35	35	0,5	90
6023508	2	8	8	35	35	1,0	90
6023608	2	8	8	35	35	2,0	90
6023010	2	10	10	22	22	0,5	100
6023110	2	10	10	22	22	1,0	100
6023210	2	10	10	22	22	1,5	100
6023310	2	10	10	22	22	2,0	100
6023410	2	10	10	22	22	3,0	100
6023510	2	10	10	45	45	0,5	100
6023610	2	10	10	45	45	1,0	100
6023710	2	10	10	45	45	2,0	100
6023810	2	10	10	45	45	3,0	100
6023012	2	12	12	26	26	0,5	100
6023112	2	12	12	26	26	1,0	100
6023212	2	12	12	26	26	1,5	100
6023312	2	12	12	26	26	2,0	100
6023412	2	12	12	26	26	3,0	100
6023512	2	12	12	50	50	0,5	100
6023612	2	12	12	50	50	1,0	100
6023712	2	12	12	50	50	2,0	100
6023812	2	12	12	50	50	3,0	100



Diameter / Durchmesser (Ø d1) mm	Material / Materialien											
	Steels Stahl				Hardened steels Gehärteter Stahl				Cr-Ni alloys Cr-Ni-Legierungen		Ti alloys Titan-Legierungen	
	<1200 N/mm ²		1200 - 1600 N/mm ²		54 HRC		<68 HRC		<900 N/mm ²		<850 N/mm ²	
	R.P.M Min.	Feed / Vorschub mm/min.	R.P.M Min.	Feed / Vorschub mm/min.	R.P.M Min.	Feed / Vorschub mm/min.	R.P.M Min.	Feed / Vorschub mm/min.	R.P.M Min.	Feed / Vorschub mm/min.	R.P.M Min.	Feed / Vorschub mm/min.
1	37500	3200	35000	3000	26500	2200	13600	1200	56000	4650	48000	3950
2	37500	3100	35000	2900	26500	2100	13500	1100	56000	4550	48000	3850
3	37500	3000	35000	2800	26500	2000	13400	1000	56000	4450	48000	3700
4	28000	2550	27000	2350	19500	1800	10000	900	42000	3750	36000	3250
5	22500	2250	21000	2100	16000	1600	7500	800	33500	3300	29000	2900
6	19000	1900	17500	1900	13000	1400	6500	700	28000	3050	24000	2600
8	14000	1400	11000	1750	10000	1300	5000	650	21000	2700	18000	2350
10	11000	1750	10500	1500	8000	1100	4000	550	17000	2350	14500	2000
12	9500	1500	8500	1400	6500	1050	3500	500	14000	2250	12000	1900

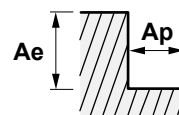
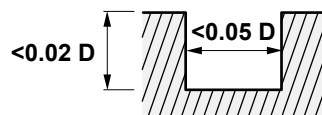



Toric-corner radius End Mills.

For high speed cutting (HSC) <62HRC

Long series, four flutes

VHM-Torus-Eckenradiusfräser

Zum Hochgeschwindigkeitsschneiden (HSC) <62HRC

Lange Ausführung, vier Schneiden

Characteristics:

High performance carbide end mill for universal applications. Finishing, semi-finishing and roughing with the same tool. Different spiral angles effect smooth, vibrationless running and excellent surface. High cutting performance.

Eigenschaften:

VHM-Hochleistungsfräser für allgemeine Anwendungen. Schlichten, Vorschlichten und Schruppen mit einem einzigen Werkzeug. Die ungleiche Drallsteigung bewirkt einen ruhigen, vibrationsarmen Lauf und eine hervorragende Oberflächengüte. Hohe Zerspanungsleistung.

STEELS STAHL < 850 N/mm ²	STEELS STAHL > 850 N/mm ²	INOX < 850 N/mm ²	INOX > 850 N/mm ²
CAST IRON GRAUGÜß	Al	Cu, Ms	Ti
CARBIDE VHM			
Z=4	Type Typ N	DIN 6527L	

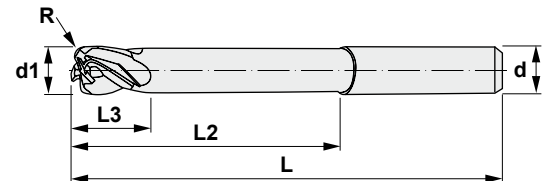

6043

Reference Bezeichnung		d1	d	L3	L2	R	L
6043002	4	2	6	2	10	0,2	80
6043102	4	2	6	2	10	0,5	80
6043202	4	2	6	10	10	0,2	80
6043302	4	2	6	10	10	0,5	80
6043003	4	3	6	3	15	0,2	80
6043103	4	3	6	3	15	0,5	80
6043203	4	3	6	15	15	0,2	80
6043303	4	3	6	15	15	0,5	80
6043004	4	4	6	4	20	0,2	80
6043104	4	4	6	4	20	0,5	80
6043204	4	4	6	4	20	1,0	80
6043304	4	4	6	20	20	0,2	80
6043404	4	4	6	20	20	0,5	80
6043504	4	4	6	20	20	1,0	80
6043006	4	6	6	13	13	0,2	80
6043106	4	6	6	13	13	0,5	80
6043206	4	6	6	13	13	1,0	80
6043306	4	6	6	13	13	1,5	80
6043406	4	6	6	13	13	2,0	80
6043506	4	6	6	25	25	0,2	80
6043606	4	6	6	25	25	0,5	80
6043706	4	6	6	25	25	1,0	80
6043806	4	6	6	25	25	2,0	80

6043

Reference Bezeichnung		d1	d	L3	L2	R	L
6043008	4	8	8	19	19	0,5	90
6043108	4	8	8	19	19	1,0	90
6043208	4	8	8	19	19	1,5	90
6043308	4	8	8	19	19	2,0	90
6043408	4	8	8	35	35	0,5	90
6043508	4	8	8	35	35	1,0	90
6043608	4	8	8	35	35	2,0	90
6043010	4	10	10	22	22	0,5	100
6043110	4	10	10	22	22	1,0	100
6043210	4	10	10	22	22	1,5	100
6043310	4	10	10	22	22	2,0	100
6043410	4	10	10	22	22	3,0	100
6043510	4	10	10	45	45	0,5	100
6043610	4	10	10	45	45	1,0	100
6043710	4	10	10	45	45	2,0	100
6043810	4	10	10	45	45	3,0	100
6043012	4	12	12	26	26	0,5	100
6043112	4	12	12	26	26	1,0	100
6043212	4	12	12	26	26	1,5	100
6043312	4	12	12	26	26	2,0	100
6043412	4	12	12	26	26	3,0	100
6043512	4	12	12	50	50	0,5	100
6043612	4	12	12	50	50	1,0	100
6043712	4	12	12	50	50	2,0	100
6043812	4	12	12	50	50	3,0	100

Diameter / Durchmesser (Ø d1) mm	Material / Materialien											
	Prehardened and hardened steels Vorgehärteter und Gehärteter Stahl <45 HRC				Hardened steels Gehärteter Stahl <55 HRC				Copper / Aluminium Kupfer / Aluminium			
	Ae mm.	Ap mm.	R.P.M Min.	Feed / Vorschub mm/min.	Ae mm.	Ap mm.	R.P.M Min.	Feed / Vorschub mm/min.	Ae mm.	Ap mm.	R.P.M Min.	Feed / Vorschub mm/min.
2	0.344	0.039	7800	880	0.344	0.037	7200	820	0.153	0.015	5900	360
3	0.493	0.049	7100	1300	0.493	0.031	6700	1300	0.271	0.019	5400	470
4	0.800	0.060	6200	1200	0.800	0.047	5200	1120	0.560	0.022	4500	630
6	1.148	0.085	2500	680	0.638	0.085	1400	400	0.468	0.034	1200	300
8	2.540	0.184	4000	1600	1.320	0.184	2400	680	1.320	0.087	2000	650
10	2.730	0.210	3200	1750	1.430	0.220	1900	540	1.450	0.094	1600	460
12	2.700	0.230	2500	1800	1.490	0.240	1500	430	1.500	0.110	1300	450

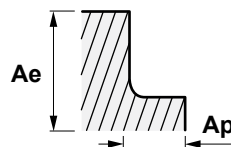



Turbo Torus End Mills.
For high speed cutting (HSC) <45HRC
Short series, four flutes

Turbo-VHM-Torusfräser
Zum Hochgeschwindigkeitsschneiden (HSC) <45HRC
Kurze Ausführung, vier Schneiden

Characteristics:
High performance carbide end mill for universal applications. Finishing, semi-finishing and roughing with the same tool. Different spiral angles effect smooth, vibrationless running and excellent surface. High cutting performance.

Eigenschaften:
VHM-Hochleistungsfräser für allgemeine Anwendungen. Schlichten, Vorschlichten und Schruppen mit einem einzigen Werkzeug. Die ungleiche Drallsteigung bewirkt einen ruhigen, vibrationsarmen Lauf und eine hervorragende Oberflächengüte. Hohe Zerspanungsleistung.

STEELS STAHL < 850 N/mm ²	STEELS STAHL > 850 N/mm ²	INOX < 850 N/mm ²	INOX > 850 N/mm ²
CAST IRON GRAUGUß	Ti		
CARBIDE VHM			
Z=4	Type Typ N	DIN 6527L	

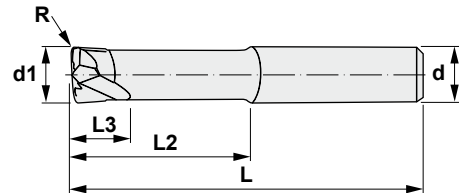

6143

Reference Bezeichnung		d1	d	L3	L2	R	L
614303	4	3	6	1,5	8	0,5	60
614304	4	4	6	2,0	8	0,5	60
614306	4	6	6	3,0	14	1,0	60
614308	4	8	8	4,0	18	2,0	63
614310	4	10	10	5,0	20	2,0	72
614312	4	12	12	6,0	22	2,0	83

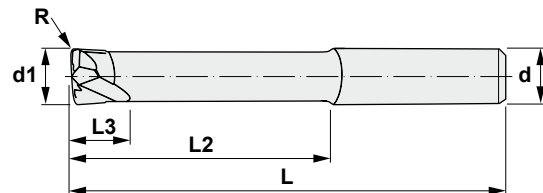

6243 Long series, four flutes
Lange Ausführung, vier Schneiden

Reference Bezeichnung		d1	d	L3	L2	R	L
624303	4	3	6	1,5	20	0,5	80
624304	4	4	6	2,0	20	0,5	80
624306	4	6	6	3,0	30	1,0	80
624308	4	8	8	4,0	40	2,0	80
624310	4	10	10	5,0	50	2,0	100
624312	4	12	12	6,0	50	2,0	110

6143 / 6243 Turbo Torus End Mills. Turbo-VHM-Torusfräser.

Conventional milling Konventionelles Fräsen

Diameter / Durchmesser (Ø d1) mm	Material / Materialien									
	Prehardened steels Vorgehärteter Stahl <40 HRC		Hardened steels Gehärteter Stahl 40 - 50 HRC		Hardened steels Gehärteter Stahl 50 - 55 HRC		Hardened steels Gehärteter Stahl 55 - 60 HRC		Hardened steels Gehärteter Stahl 60 - 65 HRC	
	R.P.M Min.	Feed / Vorschub mm/min.	R.P.M Min.	Feed / Vorschub mm/min.	R.P.M Min.	Feed / Vorschub mm/min.	R.P.M Min.	Feed / Vorschub mm/min.	R.P.M Min.	Feed / Vorschub mm/min.
3	9550	6500	6900	4150	4550	2750	2850	1150	1900	610
4	7950	7000	5750	4600	4000	3200	2550	1350	1750	700
6	5800	7650	4100	4900	2900	3500	1850	1850	1350	795
8	4350	7650	3050	4900	2200	3500	1400	1850	995	795
10	3500	7650	2450	4900	1750	3500	1100	1850	795	795
12	2900	7650	2050	4900	1450	3500	925	1850	665	795

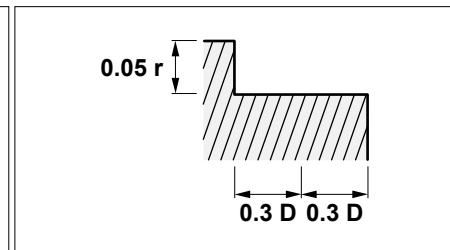
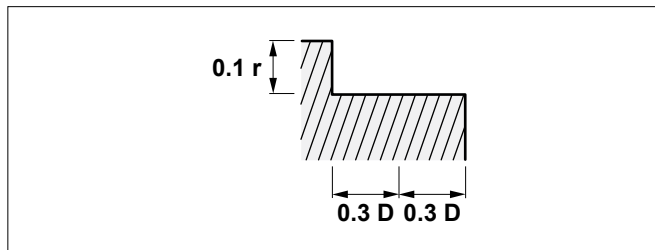

HSC milling HSC-Fräsen

Diameter / Durchmesser (Ø d1) mm	Material / Materialien									
	Prehardened steels Vorgehärteter Stahl <40 HRC		Hardened steels Gehärteter Stahl 40 - 50 HRC		Hardened steels Gehärteter Stahl 50 - 55 HRC		Hardened steels Gehärteter Stahl 55 - 60 HRC		Hardened steels Gehärteter Stahl 60 - 65 HRC	
	R.P.M Min.	Feed / Vorschub mm/min.	R.P.M Min.	Feed / Vorschub mm/min.	R.P.M Min.	Feed / Vorschub mm/min.	R.P.M Min.	Feed / Vorschub mm/min.	R.P.M Min.	Feed / Vorschub mm/min.
3	22000	16000	17000	10000	12500	8000	9500	4600	6900	2500
4	17000	17500	13000	12000	11000	9200	8000	5500	5600	2900
6	13500	18500	10500	13800	9000	11000	6400	6400	4500	3600
8	10000	18500	8000	14000	6800	11000	4800	6700	3400	4100
10	8000	18500	6400	14000	5400	11000	3800	6800	2700	2800
12	6600	18500	5300	14000	4500	11000	3200	7000	2250	3600

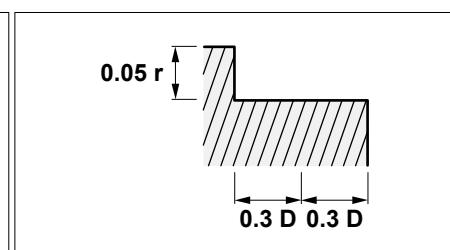
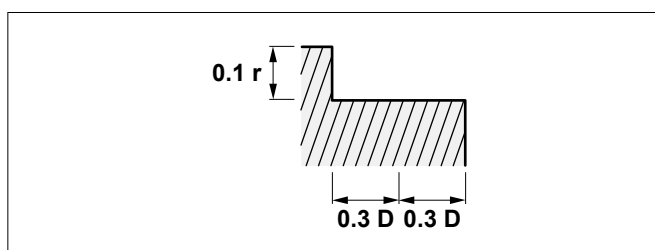

Solid carbide End Mills. HyperBall form.

Short series, four flutes

VHM-Vollradius-Schaftfräser. Form HyperBall.

Kurze Ausführung, vier Schneiden



Characteristics:

High performance carbide end mill for universal applications. Finishing, semi-finishing and roughing with the same tool. Different spiral angles effect smooth, vibrationless running and excellent surface. High cutting performance.

Eigenschaften:

VHM-Hochleistungsfräser für allgemeine Anwendungen. Schlichten, Vorschlichten und Schruppen mit einem einzigen Werkzeug. Die ungleiche Drallsteigung bewirkt einen ruhigen, vibrationsarmen Lauf und eine hervorragende Oberflächengüte. Hohe Zerspanungsleistung.

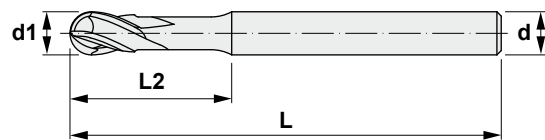
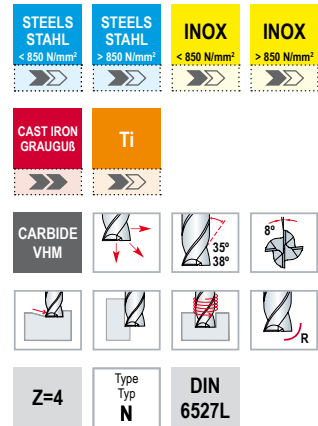

6342

Reference Bezeichnung		d1	d	L2	L
6342006	4	6	6	8	50
6342106	4	6	6	8	80
6342206	4	6	6	8	100
6342306	4	6	6	8	150
6342008	4	8	8	10	60
6342108	4	8	8	10	100
6342208	4	8	8	10	150
6342010	4	10	10	13	75
6342110	4	10	10	13	100
6342210	4	10	10	13	150
6342310	4	10	10	13	200
6342012	4	12	12	15	75
6342112	4	12	12	15	100
6342212	4	12	12	15	150
6342312	4	12	12	15	200

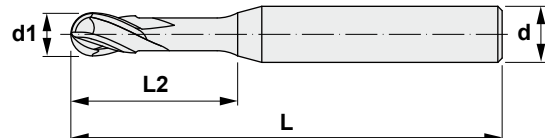
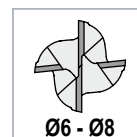

6343

Reference Bezeichnung		d1	d	L2	L
6343006	4	6	8	32	80
6343106	4	6	8	45	108
6343008	4	8	10	32	80
6343108	4	8	10	48	108

**6342 / 6343 Solid carbide End Mills. HyperBall form.
VHM-Vollradius-Schafffräser. Form HyperBall.**

**For finishing
Zum Schlichten**

Diameter / Durchmesser		Material / Materialien							
		Tool & die steel / Mold steel Werkzeugstahl / Druckgußstahl < 45 HRC		Hardened steels Gehärteter Stahl 45 ~ 55 HRC		Hardened steels Gehärteter Stahl 55 ~ 62 HRC		Hardened steels Gehärteter Stahl 62 ~ 72 HRC	
R mm	(Ø d1) mm	R.P.M Min.	Feed / Vorschub mm/min.	R.P.M Min.	Feed / Vorschub mm/min.	R.P.M Min.	Feed / Vorschub mm/min.	R.P.M Min.	Feed / Vorschub mm/min.
3	6	12700	4000	10600	3000	8500	2000	6400	1000
4	8	9500	4000	8000	3000	6400	2000	4800	1000
5	10	7600	4000	6400	3000	5100	2000	3800	1000
6	12	6400	4000	5300	3000	4200	2000	3200	1000

--	--	--	--

**For roughing and semi-finishing
Zum Schruppen und Vorschlichten**

Diameter / Durchmesser		Material / Materialien											
		Tool & die steel / Mold steel Werkzeugstahl / Druckgußstahl < 45 HRC			Hardened steels Gehärteter Stahl 45 ~ 55 HRC			Hardened steels Gehärteter Stahl 55 ~ 62 HRC			Hardened steels Gehärteter Stahl 62 ~ 72 HRC		
R mm	(Ø d1) mm	R.P.M Min.	Feed / Vorschub mm/min.	ap x Ae	R.P.M Min.	Feed / Vorschub mm/min.	ap x Ae	R.P.M Min.	Feed / Vorschub mm/min.	ap x Ae	R.P.M Min.	Feed / Vorschub mm/min.	ap x Ae
3	6	9500	3000	0.86	8000	2250	0.86	6400	1500	0.72	4800	750	0.22
4	8	7200	3000	1.54	6000	2250	1.54	4800	1500	1.28	3600	750	0.38
5	10	5700	3000	2.40	4800	2250	2.40	3800	1500	2.00	2900	750	0.60
6	12	4800	3000	3.46	4000	2250	3.46	3200	1500	2.88	2400	750	0.86

--	--	--	--



Solid carbide End Mills. Ball form. Reinforced

For high speed cutting (HSC) <62HRC

Short series (Conical form), two flutes

VHM-Vollradius-Schaftfräser. Verstärkt

Zum Hochgeschwindigkeitsschneiden (HSC) <62HRC

Kurze Ausführung (konische Form), zwei Schneiden



Characteristics:

HSC high-performance tools for mould and die making. For high-alloyed and hardened materials.



Eigenschaften:

HSC Hochleistungswerkzeuge für den Werkzeug- und Formenbau. Für hochlegierte und gehärtete Materialien.

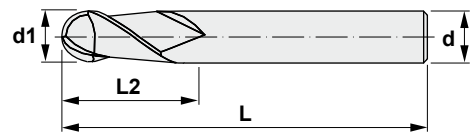
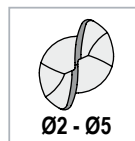

6322

Reference Bezeichnung		d1	d	L2	L
632202	2	2	6	20	60
632212	2	2	6	25	60
632203	2	3	6	20	60
632204	2	4	6	25	60
632205	2	5	6	25	60

6322 Solid carbide End Mills. Ball form. Reinforced.
VHM-Vollradius-Schafffräser. Verstärkt.

For roughing
Zum Schruppen

Diameter / Durchmesser (Ø d1) mm	Material / Materialien							
	Prehardened steels Vorgehärteter Stahl <45 HRC				Hardened steels / Stainless steels Gehärteter Stahl / Rostfreier Stahl 45 - 55 HRC			
	$\alpha \leq 15^\circ$		$\alpha > 15^\circ$		$\alpha \leq 15^\circ$		$\alpha > 15^\circ$	
	R.P.M Min.	Feed / Vorschub mm/min.	R.P.M Min.	Feed / Vorschub mm/min.	R.P.M Min.	Feed / Vorschub mm/min.	R.P.M Min.	Feed / Vorschub mm/min.
2	28800	2700	22500	1100	16200	1300	14400	580
3	22800	3000	18000	1200	13100	1500	11400	630
4	16700	3300	13000	1300	10000	1600	8300	670
5	14200	3500	11000	1300	8500	1700	7100	700

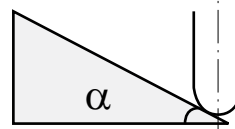
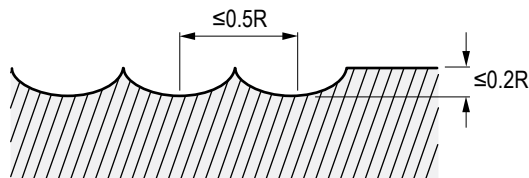

For finishing
Zum Schlichten

Diameter / Durchmesser (Ø d1) mm	Material / Materialien							
	Hardened steels Gehärteter Stahl <45 HRC				Hardened steels / Stainless steels Gehärteter Stahl / Rostfreier Stahl 45 - 55 HRC			
	$\alpha \leq 15^\circ$		$\alpha > 15^\circ$		$\alpha \leq 15^\circ$		$\alpha > 15^\circ$	
	R.P.M Min.	Feed / Vorschub mm/min.	R.P.M Min.	Feed / Vorschub mm/min.	R.P.M Min.	Feed / Vorschub mm/min.	R.P.M Min.	Feed / Vorschub mm/min.
2	28800	2900	28800	1400	22500	1800	18000	700
3	22900	3700	23400	1600	18900	2100	14900	800
4	23000	4500	18000	1800	15300	2400	11700	900
5	21000	5000	15800	1900	13500	2500	10400	1000

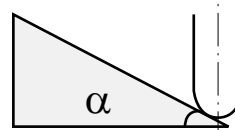
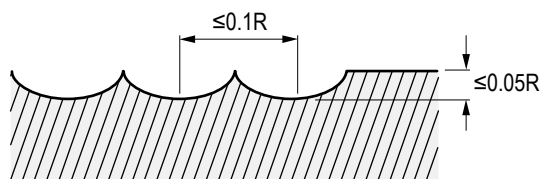



Solid carbide End Mills. Ball form. Reinforced

For high speed cutting (HSC) <62HRC

Long series (Conical form), two flutes

VHM-Vollradius-Schaftfräser. Verstärkt

Zum Hochgeschwindigkeitsschneiden (HSC) <62HRC

Lange Ausführung (konische Form), zwei Schneiden

Characteristics:

HSC high-performance tools for mould and die making. For high-alloyed and hardened materials.

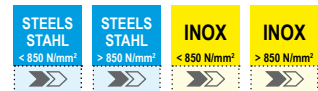

Eigenschaften:

HSC Hochleistungswerkzeuge für den Werkzeug- und Formenbau. Für hochlegierte und gehärtete Materialien.

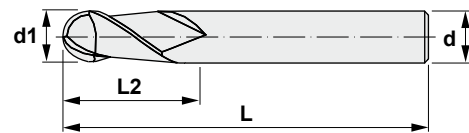
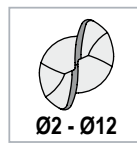

6323

Reference Bezeichnung		d1	d	L2	L
6323002	2	2	6	40	80
6323003	2	3	6	50	100
6323004	2	4	6	50	100
6323104	2	4	8	50	100
6323005	2	5	8	41	90
6323105	2	5	6	50	100
6323006	2	6	8	33	90
6323106	2	6	8	50	100
6323206	2	6	10	50	100
6323008	2	8	10	40	100
6323108	2	8	12	50	100
6323208	2	8	10	70	150
6323010	2	10	12	50	100
6323110	2	10	16	60	150
6323210	2	10	12	65	130
6323012	2	12	16	60	150

6323 Solid carbide End Mills. Ball form. Reinforced.
VHM-Vollradius-Schafffräser. Verstärkt.

For roughing
Zum Schruppen

Diameter / Durchmesser (Ø d1) mm	Material / Materialien							
	Prehardened steels Vorgehärteter Stahl <45 HRC				Hardened steels / Stainless steels Gehärteter Stahl / Rostfreier Stahl 45 - 55 HRC			
	$\alpha \leq 15^\circ$		$\alpha > 15^\circ$		$\alpha \leq 15^\circ$		$\alpha > 15^\circ$	
	R.P.M Min.	Feed / Vorschub mm/min.	R.P.M Min.	Feed / Vorschub mm/min.	R.P.M Min.	Feed / Vorschub mm/min.	R.P.M Min.	Feed / Vorschub mm/min.
2	28800	2700	22500	1100	16200	1300	14400	580
3	22800	3000	18000	1200	13100	1500	11400	630
4	16700	3300	13000	1300	10000	1600	8300	670
5	14200	3500	11000	1300	8500	1700	7100	700
6	11700	3600	9000	1400	6900	1700	5800	720
8	9000	4500	7000	1800	5400	2100	4300	830
10	7200	4500	5900	1800	4300	2000	3400	780
12	5900	4100	4800	1600	3600	1900	2900	760

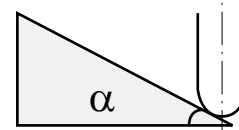
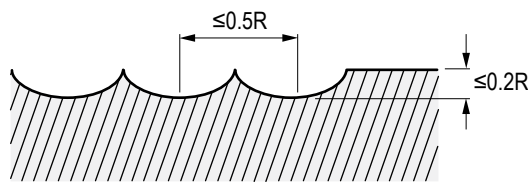

For finishing
Zum Schlichten

Diameter / Durchmesser (Ø d1) mm	Material / Materialien							
	Hardened steels Gehärteter Stahl <45 HRC				Hardened steels / Stainless steels Gehärteter Stahl / Rostfreier Stahl 45 - 55 HRC			
	$\alpha \leq 15^\circ$		$\alpha > 15^\circ$		$\alpha \leq 15^\circ$		$\alpha > 15^\circ$	
	R.P.M Min.	Feed / Vorschub mm/min.	R.P.M Min.	Feed / Vorschub mm/min.	R.P.M Min.	Feed / Vorschub mm/min.	R.P.M Min.	Feed / Vorschub mm/min.
2	28800	2900	28800	1400	22500	1800	18000	700
3	22900	3700	23400	1600	18900	2100	14900	800
4	23000	4500	18000	1800	15300	2400	11700	900
5	21000	5000	15800	1900	13500	2500	10400	1000
6	18000	5500	13500	2000	11700	2900	9000	1100
8	13500	6800	10000	2400	9000	3400	6800	1300
10	10800	6800	8100	2400	7200	3400	5400	1300
12	9000	6300	6800	2300	6000	3200	4500	1200

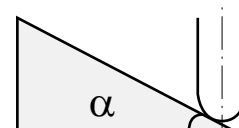
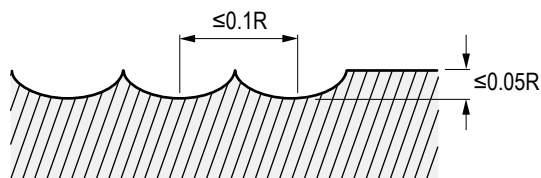



Ball form carbide End Mills. Shank D4.

For high speed cutting (HSC) <62HRC

Two flutes

VHM-Vollradius-Schaftfräser. Schaft D4.

Zum Hochgeschwindigkeitsschneiden (HSC) <62HRC

Zwei Schneiden

Characteristics:

For milling materials with medium/high tensile strength. Especially suited for HSC-copy milling.

Eigenschaften:

Für die Bearbeitung von Werkstoffen mit einer mittleren bis hohen Zugfestigkeit. Besonders geeignet zum HSC-Kopierfräsen.

STEELS STAHL < 850 N/mm ²	STEELS STAHL > 850 N/mm ²	INOX < 850 N/mm ²	INOX > 850 N/mm ²
CAST IRON GRAUGUß	Al	Cu, Ms	Ti
CARBIDE VHM			
Z=2	Type Typ H		WN

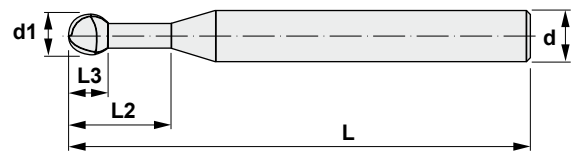
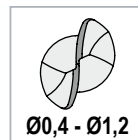

6324

Reference Bezeichnung		d1	d	L3	L2	L
632404	2	0,4	4	0,6	4	45
632405	2	0,5	4	0,7	4	45
632406	2	0,6	4	0,9	6	45
632408	2	0,8	4	1,2	8	45
632412	2	1,2	4	1,8	8	45

Diameter / Durchmesser (Ø d1) mm	Material / Materialien											
	Prehardened and hardened steels Vorgehärteter und gehärteter Stahl <45 HRC				Hardened steels Gehärteter Stahl <55 HRC				Copper Kupfer			
	Ae mm	Ap mm	R.P.M. Min.	Feed / Vorschub mm/min.	Ae mm	Ap mm	R.P.M. Min.	Feed / Vorschub mm/min.	Ae mm	Ap mm	R.P.M. Min.	Feed / Vorschub mm/min.
0.4	0.100	0.035	50000	720	0.080	0.028	41300	540	0.014	0.010	50000	710
0.5	0.120	0.040	46000	855	0.080	0.030	38300	630	0.017	0.018	52000	945
0.6	0.145	0.050	45500	830	0.110	0.040	37500	650	0.020	0.020	54000	1090
0.8	0.150	0.060	42000	880	0.150	0.050	33500	720	0.025	0.030	48000	1415
1.2	0.141	0.077	25600	575	0.112	0.061	20160	470	0.032	0.014	21760	1010

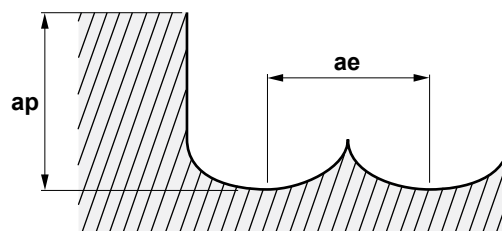



Solid carbide End Mills. Ball form with neck.

For high speed cutting (HSC) <62HRC

Short series (long neck), two flutes

VHM-Radius-Schaftfräser mit Hals.

Zum Hochgeschwindigkeitsschneiden (HSC) <62HRC

Kurze Ausführung (langer Hals), zwei Schneiden

Characteristics:

For milling materials with medium/high tensile strength. Especially suited for HSC-copy milling.

Eigenschaften:

Für die Bearbeitung von Werkstoffen mit einer mittleren bis hohen Zugfestigkeit. Besonders geeignet zum HSC-Kopierfräsen.

STEELS STAHL < 850 N/mm ²	STEELS STAHL > 850 N/mm ²	INOX < 850 N/mm ²	INOX > 850 N/mm ²
CAST IRON GRAUGÜß	Al	Cu, Ms	Ti
CARBIDE VHM			
Z=2	Type Typ H		WN

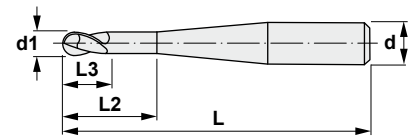
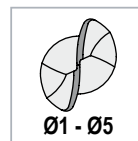

6325

Reference Bezeichnung		d1	d	L3	L2	L
632501	2	1	6	1,5	5	55
632511	2	1	6	1,5	12	65
632502	2	2	6	2,0	10	55
632512	2	2	6	3,0	14	55
632522	2	2	6	2,0	16	60
632532	2	2	6	2,0	35	75
632503	2	3	6	2,0	9	65
632513	2	3	6	2,0	15	65
632523	2	3	6	4,0	20	60
632533	2	3	6	2,0	40	80
632504	2	4	6	2,0	12	65
632514	2	4	6	5,0	20	60
632505	2	5	6	6,0	20	60



6325 Solid carbide End Mills. Ball form with neck.
VHM-Radius-Schafffräser mit Hals.

Conventional roughing / Konventionelles Schruppen

Diameter / Durchmesser (Ø d1) mm	Material / Materialien											
	Alloyed steels Legierter Stahl <1200 N/mm ²				Alloyed steels Legierter Stahl 1200 - 1450 N/mm ²				Hardened steels Gehärteter Stahl 45 - 55 HRC			
	Ae mm	Ap mm	R.P.M Min.	Feed / Vorschub mm/min.	Ae mm	Ap mm	R.P.M Min.	Feed / Vorschub mm/min.	Ae mm	Ap mm	R.P.M Min.	Feed / Vorschub mm/min.
1	0.300	0.070	38195	750	0.300	0.070	38195	750	0.250	0.055	33420	400
2	0.600	0.140	19100	1200	0.600	0.140	19100	1200	0.500	0.110	16710	600
3	0.900	0.210	12730	1600	0.900	0.210	12730	1600	0.750	0.165	11140	1000
4	1.200	0.280	9550	1700	1.200	0.280	9550	1400	1.000	0.220	8355	900
5	1.500	0.350	7640	1900	1.500	0.350	7640	1600	1.250	0.275	6685	1000

Diameter / Durchmesser (Ø d1) mm	Material / Materialien							
	Hardened steels Gehärteter Stahl 55 - 65 HRC				Hardened steels Gehärteter Stahl 65 - 70 HRC			
	Ae mm	Ap mm	R.P.M Min.	Feed / Vorschub mm/min.	Ae mm	Ap mm	R.P.M Min.	Feed / Vorschub mm/min.
1	0.250	0.035	28645	400	0.200	0.025	20690	330
2	0.500	0.070	14325	500	0.400	0.050	10345	330
3	0.750	0.105	9550	650	0.600	0.075	6895	340
4	1.000	0.140	7160	800	0.800	0.100	5170	400
5	1.250	0.175	5730	800	1.000	0.125	4140	500

HSC roughing / HSC-Schruppen

Diameter / Durchmesser (Ø d1) mm	Material / Materialien											
	Alloyed steels Legierter Stahl <1200 N/mm ²				Alloyed steels Legierter Stahl 1200 - 1450 N/mm ²				Hardened steels Gehärteter Stahl 45 - 55 HRC			
	Ae mm	Ap mm	R.P.M Min.	Feed / Vorschub mm/min.	Ae mm	Ap mm	R.P.M Min.	Feed / Vorschub mm/min.	Ae mm	Ap mm	R.P.M Min.	Feed / Vorschub mm/min.
1	0.300	0.070	79575	3200	0.300	0.070	95490	3200	0.250	0.055	68435	3000
2	0.600	0.140	39790	2800	0.600	0.140	47745	2800	0.500	0.110	34220	2300
3	0.900	0.210	26525	3200	0.900	0.210	31830	3200	0.750	0.165	22810	2200
4	1.200	0.280	19895	3400	1.200	0.280	23875	2900	1.000	0.220	17110	2500
5	1.500	0.350	15915	3600	1.500	0.350	19100	3000	1.250	0.275	13685	2600

Diameter / Durchmesser (Ø d1) mm	Material / Materialien							
	Hardened steels Gehärteter Stahl 55 - 65 HRC				Hardened steels Gehärteter Stahl 65 - 70 HRC			
	Ae mm	Ap mm	R.P.M Min.	Feed / Vorschub mm/min.	Ae mm	Ap mm	R.P.M Min.	Feed / Vorschub mm/min.
1	0.250	0.035	66845	1100	0.200	0.025	44565	800
2	0.500	0.070	33420	1000	0.400	0.050	22280	800
3	0.750	0.105	22280	1700	0.600	0.075	14855	1000
4	1.000	0.140	16710	1600	0.800	0.100	11140	900
5	1.250	0.175	13370	1800	1.000	0.125	8910	1200

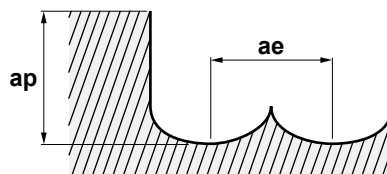

6325 Solid carbide End Mills. Ball form with neck. VHM-Radius-Schaftfräser mit Hals.

Conventional finishing / Konventionelles Schlichten

Diameter / Durchmesser (Ø d1) mm	Material / Materialien											
	Alloyed steels Legierter Stahl <1200 N/mm ²				Alloyed steels Legierter Stahl 1200 - 1450 N/mm ²				Hardened steels Gehärteter Stahl 45 - 55 HRC			
	Ae mm	Ap mm	R.P.M Min.	Feed / Vorschub mm/min.	Ae mm	Ap mm	R.P.M Min.	Feed / Vorschub mm/min.	Ae mm	Ap mm	R.P.M Min.	Feed / Vorschub mm/min.
1	0.035	0.075	41380	1900	0.035	0.075	41380	1900	0.030	0.065	33420	1500
2	0.070	0.150	20690	2300	0.070	0.150	20690	2300	0.060	0.130	16710	1900
3	0.105	0.225	13790	2700	0.105	0.225	13790	2700	0.090	0.195	11140	1700
4	0.140	0.300	10345	2600	0.140	0.300	10345	2600	0.120	0.260	8355	1600
5	0.175	0.375	8275	2400	0.175	0.375	8275	2400	0.150	0.325	6685	1700

Diameter / Durchmesser (Ø d1) mm	Material / Materialien							
	Hardened steels Gehärteter Stahl 55 - 65 HRC				Hardened steels Gehärteter Stahl 65 - 70 HRC			
	Ae mm	Ap mm	R.P.M Min.	Feed / Vorschub mm/min.	Ae mm	Ap mm	R.P.M Min.	Feed / Vorschub mm/min.
1	0.030	0.050	33420	1100	0.025	0.030	28995	1200
2	0.060	0.100	16710	2000	0.050	0.060	14480	1400
3	0.090	0.150	11140	1500	0.075	0.090	9655	1200
4	0.120	0.200	8355	1500	0.100	0.120	7240	1100
5	0.150	0.250	6685	1600	0.125	0.150	5790	1200

HSC finishing / HSC-Schlichten

Diameter / Durchmesser (Ø d1) mm	Material / Materialien											
	Alloyed steels Legierter Stahl <1200 N/mm ²				Alloyed steels Legierter Stahl 1200 - 1450 N/mm ²				Hardened steels Gehärteter Stahl 45 - 55 HRC			
	Ae mm	Ap mm	R.P.M Min.	Feed / Vorschub mm/min.	Ae mm	Ap mm	R.P.M Min.	Feed / Vorschub mm/min.	Ae mm	Ap mm	R.P.M Min.	Feed / Vorschub mm/min.
1	0.035	0.075	95490	1900	0.035	0.075	95490	1900	0.030	0.065	84350	1500
2	0.070	0.150	47745	2300	0.070	0.150	47745	2300	0.060	0.130	42175	1900
3	0.105	0.225	31830	2700	0.105	0.225	31830	2700	0.090	0.195	28115	1700
4	0.140	0.300	23875	2600	0.140	0.300	23875	2600	0.120	0.260	21090	1600
5	0.175	0.375	19100	2400	0.175	0.375	19100	2400	0.150	0.325	16870	1700

Diameter / Durchmesser (Ø d1) mm	Material / Materialien							
	Hardened steels Gehärteter Stahl 55 - 65 HRC				Hardened steels Gehärteter Stahl 65 - 70 HRC			
	Ae mm	Ap mm	R.P.M Min.	Feed / Vorschub mm/min.	Ae mm	Ap mm	R.P.M Min.	Feed / Vorschub mm/min.
1	0.030	0.050	71620	1100	0.025	0.030	55705	1200
2	0.060	0.100	35810	2000	0.050	0.060	27850	1400
3	0.090	0.150	23875	1500	0.075	0.090	18570	1200
4	0.120	0.200	17905	1500	0.100	0.120	13925	1100
5	0.150	0.250	14325	1600	0.125	0.150	11140	1200

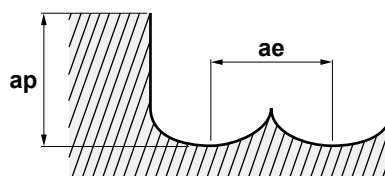

Single flute End Mills.

For aluminium and plastic materials

Short series, one flute



Einschneidiger-Schafffräser

Für Aluminium und Kunststoffe

Kurze Ausführung, eine Schneide

Characteristics:

Right-hand cutting with right-hand spiral.
Especially suited for cutting aluminium and aluminium-alloys.

Eigenschaften:

Rechtsschneidend mit Rechtsdrall.
Besonders geeignet für die Bearbeitung von Aluminium und Aluminium-Legierungen.

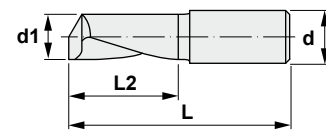
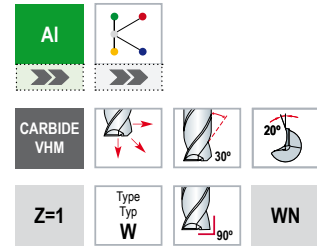

6510

Reference Bezeichnung		d1	d	L2	L
651003	1	3	3	8	38
651004	1	4	4	11	50
651005	1	5	5	13	50
651006	1	6	6	16	50
651008	1	8	8	19	60
651010	1	10	10	22	75
651012	1	12	12	26	75

Diameter / Durchmesser (Ø d1) mm	Material / Materialien							
	Acrylic / Acryl				Aluminium Aluminium alloys / Aluminium-Legierungen			
	R.P.M Min.	Feed / Vorschub mm/min.	Vc (M/Min.)	fz (mm/tooth) fz (Mm/Zahn)	R.P.M Min.	Feed / Vorschub mm/min.	Vc (M/Min.)	fz (mm/tooth) fz (Mm/Zahn)
3	25000	2400	235	0.096	18000	1700	170	0.094
4	20000	2400	250	0.120	15000	1800	190	0.120
5	15000	2200	235	0.147	12000	1800	190	0.150
6	13500	2300	255	0.170	10000	1800	190	0.180
8	10000	2400	250	0.240	7800	1900	195	0.244
10	8000	2400	250	0.300	6000	2000	190	0.333
12	6700	2300	255	0.343	5000	2200	190	0.440

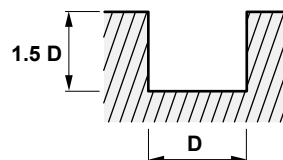

Single flute End Mills.
For aluminium and plastic materials
Long series, one flute

Einschneidiger-Schafffräser
Für Aluminium und Kunststoffe
Lange Ausführung, eine Schneide



Characteristics:
Right-hand cutting with right-hand spiral.
Especially suited for cutting aluminium and aluminium-alloys.

Eigenschaften:
Rechtsschneidend mit Rechtsdrall.
Besonders geeignet für die Bearbeitung von Aluminium und Aluminium-Legierungen.

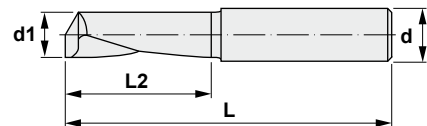
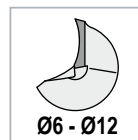
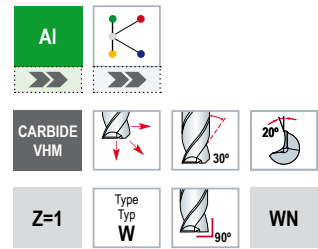

6610

Reference Bezeichnung		d1	d	L2	L
661006	1	6	6	25	80
661008	1	8	8	35	90
661010	1	10	10	45	100
661012	1	12	12	50	100

Diameter / Durchmesser (Ø d1) mm	Material / Materialien							
	Acrylic / Acryl				Aluminium Aluminium alloys / Aluminium-Legierungen			
	R.P.M Min.	Feed / Vorschub mm/min.	Vc (M/Min.)	fz (mm/tooth) fz (Mm/Zahn)	R.P.M Min.	Feed / Vorschub mm/min.	Vc (M/Min.)	fz (mm/tooth) fz (Mm/Zahn)
6	13500	2300	255	0.170	10000	1800	190	0.180
8	10000	2400	250	0.240	7800	1900	195	0.244
10	8000	2400	250	0.300	6000	2000	190	0.333
12	6700	2300	255	0.343	5000	2200	190	0.440

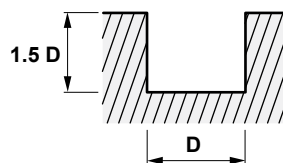



Solid carbide End Mills.

For aluminium and plastic materials

Short series, two flutes

VHM-Schafffräser

Für Aluminium und Kunststoffe

Kurze Ausführung, zwei Schneiden

Characteristics:

Recommended for milling aluminium and aluminium-alloys, plastics, copper-alloys and non-ferrous metals.

Eigenschaften:

Empfohlen zum Fräsen von Aluminium und Aluminium-Legierungen, Kunststoffen, Kupfer-Legierungen und NE-Metallen.

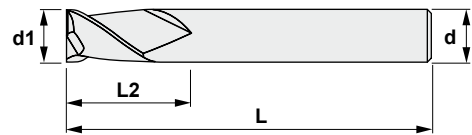
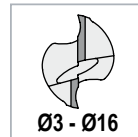
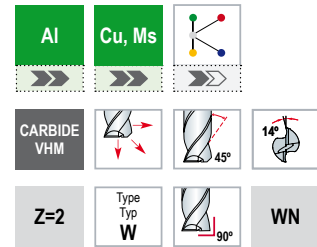

6520

Reference Bezeichnung		d1	d	L2	L
652003	2	3	6	8	50
652004	2	4	6	11	50
652005	2	5	6	13	50
652006	2	6	6	16	50
652008	2	8	8	19	60
652010	2	10	10	25	72
652012	2	12	12	30	75
652014	2	14	14	35	84
652016	2	16	16	40	92

Diameter / Durchmesser (Ø d1) mm	Material / Materialien							
	Aluminium Aluminium alloys / Aluminium-Legierungen							
	R.P.M Min.	Feed / Vorschub mm/min.	Vc (M/Min.)	fz (mm/tooth) fz (Mm/Zahn)	R.P.M Min.	Feed / Vorschub mm/min.	Vc (M/Min.)	fz (mm/tooth) fz (Mm/Zahn)
3	10000	700	95	0.035	10000	900	95	0.045
4	10000	900	125	0.045	10000	1100	125	0.055
5	10000	1000	155	0.050	10000	1300	155	0.065
6	10000	1200	190	0.060	10000	1500	190	0.075
8	8000	1400	200	0.088	8000	1800	200	0.113
10	8000	1700	250	0.106	8000	2100	250	0.131
12	8000	2100	300	0.131	8000	2600	300	0.163
14	6000	1800	265	0.150	6000	2200	265	0.183
16	6000	1900	300	0.158	6000	2400	300	0.200

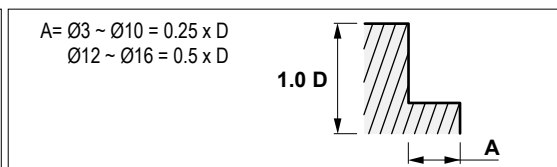
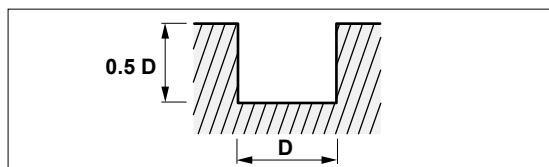



Solid carbide End Mills.
For aluminium and plastic materials
Short series, three flutes

VHM-Schafffräser
Für Aluminium und Kunststoffe
Kurze Ausführung, drei Schneiden

Characteristics:
Recommended for milling aluminium and aluminium-alloys, plastics, copper-alloys and non-ferrous metals.

Eigenschaften:
Empfohlen zum Fräsen von Aluminium und Aluminium-Legierungen, Kunststoffen, Kupfer-Legierungen und NE-Metallen.

Al	Cu, Ms	
CARBIDE VHM		
Z=3	Type Typ W	WN

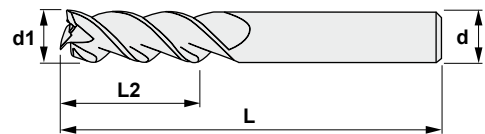
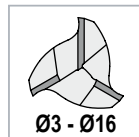

6530

Reference Bezeichnung		d1	d	L2	L
653003	3	3	6	8	50
653004	3	4	6	11	50
653005	3	5	6	13	50
653006	3	6	6	16	50
653008	3	8	8	19	60
653010	3	10	10	25	72
653012	3	12	12	30	75
653016	3	16	16	40	92

Diameter / Durchmesser (Ø d1) mm	Material / Materialien							
	Aluminium Low silicon aluminium / Siliziumarmer Aluminium							
	R.P.M Min.	Feed / Vorschub mm/min.	Vc (M/Min.)	fz (mm/tooth) fz (Mm/Zahn)	R.P.M Min.	Feed / Vorschub mm/min.	Vc (M/Min.)	fz (mm/tooth) fz (Mm/Zahn)
3	7000	940	65	0.045	7000	730	65	0.035
4	7000	1150	90	0.055	7000	940	90	0.045
5	7000	1360	110	0.065	7000	1050	110	0.050
6	7000	1580	130	0.075	7000	1250	130	0.060
8	5600	1900	140	0.113	5600	1470	140	0.088
10	5600	2200	175	0.131	5600	1780	175	0.106
12	5600	2740	210	0.163	5600	2200	210	0.131
16	4200	2520	210	0.200	4200	1990	210	0.158

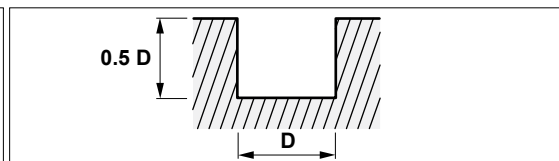
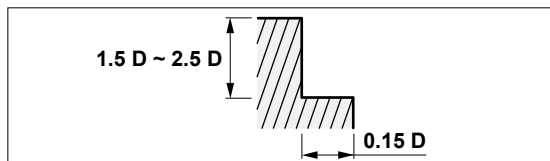

Solid carbide End Mills. For roughing.
For high speed cutting (HSC) <56HRC
Short series, four flutes



VHM-Schruppfräser
Zum Hochgeschwindigkeitsschneiden (HSC) <56HRC
Kurze Ausführung, vier Schneiden

Characteristics:

Solid carbide high performance roughing cutter, especially suitable for all kind of steels up to 1.400 N/mm², higher tensile stainless steels, grey cast iron as well as short chipping aluminium and aluminium cast. High cutting performance.

Eigenschaften:

VHM-Hochleistungs-Schruppfräser, besonders geeignet für alle Stahlwerkstoffe bis 1.400 N/mm², härteste rostfreie Stähle, Grauguß sowie kurzspanendes Aluminium und Aluminiumguß. Hohe Zerspanungsleistung.

STEELS STAHL < 850 N/mm ²	STEELS STAHL > 850 N/mm ²	INOX < 850 N/mm ²	INOX > 850 N/mm ²
CAST IRON GRAUGUß	AI		
CARBIDE VHM			
Z=4	HR		DIN 6527L

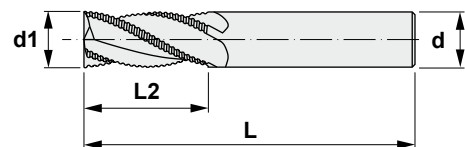
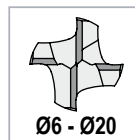

6640

Reference Bezeichnung		d1	d	L2	L
664006	4	6	6	16	50
664008	4	8	8	19	60
664010	4	10	10	22	75
664012	4	12	12	26	75
664014	4	14	14	30	90
664016	4	16	16	32	100
664020	4	20	20	38	100

6640 Solid carbide End Mills. For roughing.
VHM-Schrupfräser.

Diameter / Durchmesser (Ø d1) mm	Material / Materialien							
	Unalloyed steels / Unlegierter Stahl Alloyed steels / Legierter Stahl Tool steels / Werkzeugstahl ~ HRC30 / 1000 N/mm ²				Alloyed steels / Legierter Stahl Heat resistant steels / Hitzebeständiger Stahl ~ HRC30 ~ HRC38 / 1000 ~ 1200 N/mm ²			
	R.P.M Min.	Feed / Vorschub mm/min.	Vc (M/Min.)	fz (mm/tooth) fz (Mm/Zahn)	R.P.M Min.	Feed / Vorschub mm/min.	Vc (M/Min.)	fz (mm/tooth) fz (Mm/Zahn)
6	13250	1970	250	0.050	10550	710	200	0.022
8	9850	1970	250	0.067	7800	710	195	0.023
10	7800	1970	245	0.063	6450	710	205	0.028
12	6800	2040	255	0.075	5100	680	190	0.033
14	5800	2040	255	0.088	4400	710	195	0.040
16	5100	2040	255	0.100	4100	650	205	0.040
20	4100	1840	260	0.112	3050	480	190	0.039

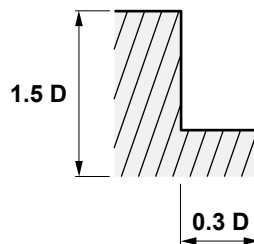

Diameter / Durchmesser (Ø d1) mm	Material / Materialien							
	Stainless steels / Rostfreier Stahl HRC38 ~ HRC45 / 1200 ~ 1400 N/mm ²				Inconel			
	R.P.M Min.	Feed / Vorschub mm/min.	Vc (M/Min.)	fz (mm/tooth) fz (Mm/Zahn)	R.P.M Min.	Feed / Vorschub mm/min.	Vc (M/Min.)	fz (mm/tooth) fz (Mm/Zahn)
6	7150	480	135	0.022	2050	160	40	0.026
8	5350	480	135	0.022	1550	150	40	0.024
10	4350	480	135	0.028	1100	160	35	0.036
12	3550	480	135	0.034	1000	160	40	0.040
14	3050	480	135	0.039	750	110	35	0.037
16	2800	430	140	0.038	700	90	35	0.032
20	2050	310	130	0.038	550	90	35	0.041

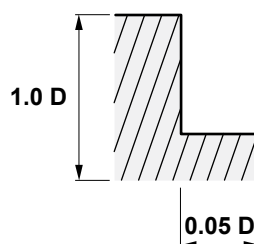

Solid carbide square End Mills.

For high speed cutting (HSC) <56HRC

Short series, two flutes



VHM-viereckige Schafffräser

Zum Hochgeschwindigkeitsschneiden (HSC) <56HRC

Kurze Ausführung, zwei Schneiden

Characteristics:

Recommended for milling in materials with medium and high tensile strength up to 1.300 N/mm².

For drilling continued by horizontal milling with exact tolerances.

Eigenschaften:

Empfohlen zum Fräsen von Werkstoffen mit mittlerer bis hoher Zugfestigkeit bis ca. 1.300 N/mm². Zum Bohren und anschließenden Längsfräsen mit genauen Toleranzen.

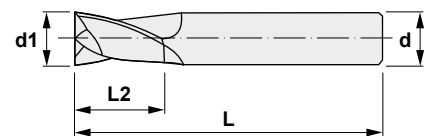
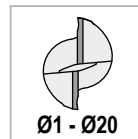
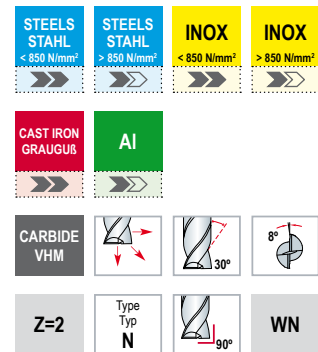

6020

Reference Bezeichnung		d1	d	L2	L
6020010	2	1,0	3	3	38
6020015	2	1,5	3	4	38
6020020	2	2,0	3	6	38
6020030	2	3,0	3	8	38
6020040	2	4,0	4	11	50
6020050	2	5,0	5	13	50
6020060	2	6,0	6	16	50
6020080	2	8,0	8	19	60
6020100	2	10,0	10	22	72
6020120	2	12,0	12	26	75
6020140	2	14,0	14	30	84
6020160	2	16,0	16	32	92
6020200	2	20,0	20	38	100

6020 Solid carbide square End Mills. VHM-viereckige Schafffräser.

Diameter / Durchmesser (Ø d1) mm	Material / Materialien											
	Unalloyed steels / Unlegierter Stahl Alloyed steels / Legierter Stahl Tool steels / Werkzeugstahl ~ HRC30 / 1000 N/mm ²				Alloyed steels / Legierter Stahl Heat resistant steels / Hitzebeständiger Stahl ~ HRC30 ~ HRC45 / 1000 ~ 1500 N/mm ²				Stainless steels / Rostfreier Stahl			
	R.P.M Min.	Feed / Vorschub mm/min.	Vc (M/Min.)	fz (mm/tooth) (Mm/Zahn)	R.P.M Min.	Feed / Vorschub mm/min.	Vc (M/Min.)	fz (mm/tooth) (Mm/Zahn)	R.P.M Min.	Feed / Vorschub mm/min.	Vc (M/Min.)	fz (mm/tooth) (Mm/Zahn)
1.0	14300	105	45	0.004	8500	65	25	0.004	7150	50	20	0.003
1.5	9350	150	45	0.008	5550	85	25	0.008	5600	80	25	0.007
2.0	7850	160	50	0.010	5150	100	30	0.010	4300	80	25	0.009
3.0	6100	180	55	0.015	3800	120	35	0.016	3150	100	30	0.016
4.0	5150	255	65	0.025	3150	155	40	0.025	2650	130	35	0.025
5.0	4300	270	70	0.031	2550	160	40	0.031	2150	135	35	0.031
6.0	3800	300	70	0.039	2300	190	45	0.041	1950	155	35	0.040
8.0	2850	325	70	0.057	1700	170	45	0.050	1450	155	35	0.053
10.0	2200	280	70	0.064	1350	135	40	0.050	1150	135	35	0.059
12.0	1850	240	70	0.065	1150	110	45	0.048	950	110	35	0.058
14.0	1700	215	75	0.063	1050	100	45	0.048	850	100	35	0.059
16.0	1500	185	75	0.062	950	95	50	0.050	700	95	35	0.068
20.0	1150	145	70	0.063	700	70	45	0.050	550	70	35	0.064

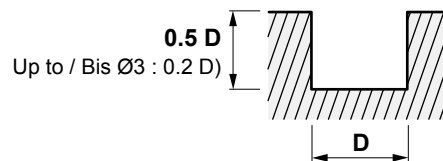

Diameter / Durchmesser (Ø d1) mm	Material / Materialien											
	Cast iron / Grauguß				Aluminium alloys / Aluminium-Legierungen				Copper, brass / Kupfer, Messing Non-ferrous metals / Nicht-Eisen-Metalle			
	R.P.M Min.	Feed / Vorschub mm/min.	Vc (M/Min.)	fz (mm/tooth) (Mm/Zahn)	R.P.M Min.	Feed / Vorschub mm/min.	Vc (M/Min.)	fz (mm/tooth) (Mm/Zahn)	R.P.M Min.	Feed / Vorschub mm/min.	Vc (M/Min.)	fz (mm/tooth) (Mm/Zahn)
1.0	18700	205	60	0.005	44000	330	140	0.004	24700	200	80	0.004
1.5	12100	205	55	0.008	27500	385	130	0.007	20300	300	95	0.007
2.0	9350	220	60	0.012	22000	460	140	0.010	16500	340	105	0.010
3.0	6050	220	55	0.018	15400	460	145	0.015	11000	340	105	0.015
4.0	4600	220	60	0.024	11000	460	140	0.021	8800	340	110	0.019
5.0	3650	220	55	0.030	9150	460	145	0.025	6800	340	105	0.025
6.0	2950	255	55	0.043	7600	485	145	0.032	5700	375	105	0.033
8.0	2200	275	55	0.063	5700	485	145	0.043	4400	375	110	0.043
10.0	1850	285	60	0.077	4600	485	145	0.053	3400	375	105	0.055
12.0	1450	295	55	0.102	3750	485	140	0.065	2850	375	105	0.066
14.0	1300	310	55	0.119	3300	485	145	0.073	2400	375	105	0.078
16.0	1100	320	55	0.145	2850	485	145	0.085	2200	375	110	0.085
20.0	900	340	55	0.189	2200	485	140	0.110	1700	375	105	0.110

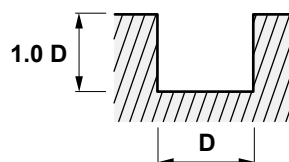



Solid carbide square End Mills.

For high speed cutting (HSC) <56HRC

Long series, two flutes

VHM-viereckige Schafffräser

Zum Hochgeschwindigkeitsschneiden (HSC) <56HRC

Lange Ausführung, zwei Schneiden

Characteristics:

Recommended for milling in materials with medium and high tensile strength up to 1.300 N/mm².

For drilling continued by horizontal milling with exact tolerances.

Eigenschaften:

Empfohlen zum Fräsen von Werkstoffen mit mittlerer bis hoher Zugfestigkeit bis ca. 1.300 N/mm². Zum Bohren und anschließenden Längsfräsen mit genauen Toleranzen.

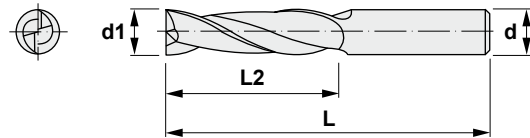
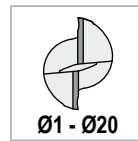
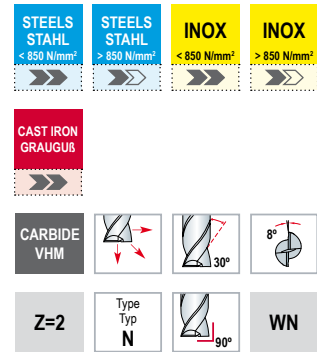

6021

Reference Bezeichnung		d1	d	L2	L
602101	2	1	3	5	60
602102	2	2	3	10	60
602103	2	3	3	15	60
602104	2	4	4	20	80
602105	2	5	5	25	80
602106	2	6	6	25	80
602108	2	8	8	35	90
602110	2	10	10	45	100
602112	2	12	12	50	100
602114	2	14	14	65	150
602116	2	16	16	65	150
602120	2	20	20	70	150

6021 Solid carbide square End Mills. VHM-viereckige Schafffräser.

Diameter / Durchmesser (Ø d1) mm	Material / Materialien											
	Unalloyed steels / Unlegierter Stahl Alloyed steels / Legierter Stahl Tool steels / Werkzeugstahl ~ HRC30 / 1000 N/mm ²				Alloyed steels / Legierter Stahl Heat resistant steels / Hitzebeständiger Stahl ~ HRC30 ~ HRC45 / 1000 ~ 1500 N/mm ²				Stainless steels / Rostfreier Stahl			
	R.P.M Min.	Feed / Vorschub mm/min.	Vc (M/Min.)	fz (mm/tooth) (Mm/Zahn)	R.P.M Min.	Feed / Vorschub mm/min.	Vc (M/Min.)	fz (mm/tooth) (Mm/Zahn)	R.P.M Min.	Feed / Vorschub mm/min.	Vc (M/Min.)	fz (mm/tooth) (Mm/Zahn)
1	14300	105	45	0.004	8500	65	25	0.004	7150	50	20	0.003
2	7850	160	50	0.010	5150	100	30	0.010	4300	80	25	0.009
3	6100	180	55	0.015	3800	120	35	0.016	3150	100	30	0.016
4	5150	255	65	0.025	3150	155	40	0.025	2650	130	35	0.025
5	4300	270	70	0.031	2550	160	40	0.031	2150	135	35	0.031
6	3800	300	70	0.039	2300	190	45	0.041	1950	155	35	0.040
8	2850	325	70	0.057	1700	170	45	0.050	1450	155	35	0.053
10	2200	280	70	0.064	1350	135	40	0.050	1150	135	35	0.059
12	1850	240	70	0.065	1150	110	45	0.048	950	110	35	0.058
14	1700	215	75	0.063	1050	100	45	0.048	850	100	35	0.059
16	1500	185	75	0.062	950	95	50	0.050	700	95	35	0.068
20	1150	145	70	0.063	700	70	45	0.050	550	70	35	0.064

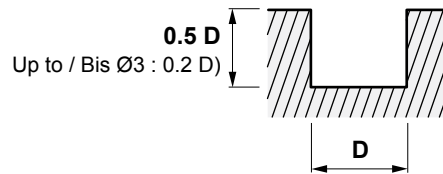

Diameter / Durchmesser (Ø d1) mm	Material / Materialien											
	Cast iron / Grauguß				Aluminium alloys / Aluminium-Legierungen				Copper, brass / Kupfer, Messing Non-ferrous metals / Nicht-Eisen-Metalle			
	R.P.M Min.	Feed / Vorschub mm/min.	Vc (M/Min.)	fz (mm/tooth) (Mm/Zahn)	R.P.M Min.	Feed / Vorschub mm/min.	Vc (M/Min.)	fz (mm/tooth) (Mm/Zahn)	R.P.M Min.	Feed / Vorschub mm/min.	Vc (M/Min.)	fz (mm/tooth) (Mm/Zahn)
1	18700	205	60	0.005	44000	330	140	0.004	24700	200	80	0.004
2	9350	220	60	0.012	22000	460	140	0.010	16500	340	105	0.010
3	6050	220	55	0.018	15400	460	145	0.015	11000	340	105	0.015
4	4600	220	60	0.024	11000	460	140	0.021	8800	340	110	0.019
5	3650	220	55	0.030	9150	460	145	0.025	6800	340	105	0.025
6	2950	255	55	0.043	7600	485	145	0.032	5700	375	105	0.033
8	2200	275	55	0.063	5700	485	145	0.043	4400	375	110	0.043
10	1850	285	60	0.077	4600	485	145	0.053	3400	375	105	0.055
12	1450	295	55	0.102	3750	485	140	0.065	2850	375	105	0.066
14	1300	310	55	0.119	3300	485	145	0.073	2400	375	105	0.078
16	1100	320	55	0.145	2850	485	145	0.085	2200	375	110	0.085
20	900	340	55	0.189	2200	485	140	0.110	1700	375	105	0.110

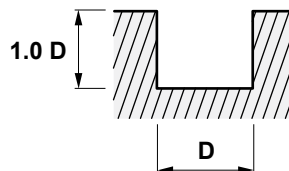

* FEED, in long and extra long types, should be reduced by around 50%.
* Bei langen und extra-langen Typen soll der Vorschub um ca.50% reduziert werden.



Solid carbide square End Mills.

For high speed cutting (HSC) <56HRC

Short series, three flutes



VHM-viereckige Schafffräser

Zum Hochgeschwindigkeitsschneiden (HSC) <56HRC

Kurze Ausführung, drei Schneiden

Characteristics:

Recommended for milling in materials with medium and high tensile strength up to 1.300 N/mm².

For drilling continued by horizontal milling with exact tolerances.

Eigenschaften:

Empfohlen zum Fräsen von Werkstoffen mit mittlerer bis hoher Zugfestigkeit bis ca. 1.300 N/mm². Zum Bohren und anschließenden Längsfräsen mit genauen Toleranzen.

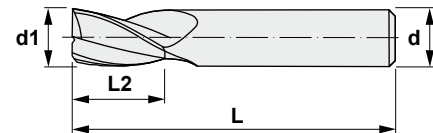
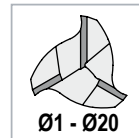
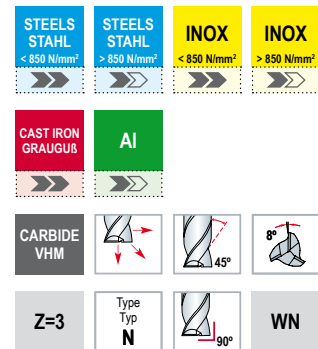

6030

Reference Bezeichnung		d1	d	L2	L
6030010	3	1,0	3	3	38
6030015	3	1,5	3	4	38
6030020	3	2,0	3	6	38
6030030	3	3,0	3	8	38
6030040	3	4,0	4	11	50
6030050	3	5,0	5	13	50
6030060	3	6,0	6	16	50
6030080	3	8,0	8	19	60
6030100	3	10,0	10	22	72
6030120	3	12,0	12	26	75
6030140	3	14,0	14	30	84
6030160	3	16,0	16	32	92
6030200	3	20,0	20	38	100

6030 Solid carbide square End Mills. Finish slotting. VHM-viereckige Schafffräser. Nuten-Schlichten.

Diameter / Durchmesser (Ø d1) mm	Material / Materialien											
	Unalloyed steels / Unlegierter Stahl Alloyed steels / Legierter Stahl Tool steels / Werkzeugstahl ~ HRC30 / 1000 N/mm ²				Alloyed steels / Legierter Stahl Heat resistant steels / Hitzebeständiger Stahl ~ HRC30 ~ HRC45 / 1000 ~ 1500 N/mm ²				Stainless steels / Rostfreier Stahl			
	R.P.M Min.	Feed / Vorschub mm/min.	Vc (M/Min.)	fz (mm/tooth) (Mm/Zahn)	R.P.M Min.	Feed / Vorschub mm/min.	Vc (M/Min.)	fz (mm/tooth) (Mm/Zahn)	R.P.M Min.	Feed / Vorschub mm/min.	Vc (M/Min.)	fz (mm/tooth) (Mm/Zahn)
1.0	14300	75	45	0.002	8500	45	25	0.002	7150	35	20	0.002
1.5	12750	105	60	0.003	5550	60	25	0.004	5600	55	25	0.003
2.0	7850	110	50	0.005	5150	70	30	0.005	4300	55	25	0.004
3.0	6100	125	55	0.007	3800	85	35	0.007	3150	70	30	0.007
4.0	5150	180	65	0.012	3150	110	40	0.012	2650	90	35	0.011
5.0	4300	190	70	0.015	2550	110	40	0.014	2150	95	35	0.015
6.0	3800	210	70	0.018	2300	135	45	0.020	1950	110	35	0.019
8.0	2850	230	70	0.027	1700	120	45	0.024	1450	110	35	0.025
10.0	2200	195	70	0.030	1350	95	40	0.023	1150	95	35	0.028
12.0	1850	170	70	0.031	1150	75	45	0.022	950	75	35	0.026
14.0	1700	150	75	0.029	1050	70	45	0.022	850	70	35	0.027
16.0	1500	130	75	0.029	950	65	50	0.023	700	65	35	0.031
20.0	1150	100	70	0.029	700	50	45	0.024	550	50	35	0.030

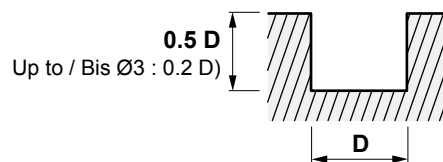

Diameter / Durchmesser (Ø d1) mm	Material / Materialien											
	Cast iron / Grauguß				Aluminium alloys / Aluminium-Legierungen				Copper, brass / Kupfer, Messing Non-ferrous metals / Nicht-Eisen-Metalle			
	R.P.M Min.	Feed / Vorschub mm/min.	Vc (M/Min.)	fz (mm/tooth) (Mm/Zahn)	R.P.M Min.	Feed / Vorschub mm/min.	Vc (M/Min.)	fz (mm/tooth) (Mm/Zahn)	R.P.M Min.	Feed / Vorschub mm/min.	Vc (M/Min.)	fz (mm/tooth) (Mm/Zahn)
1.0	18700	185	60	0.003	44000	300	140	0.002	24700	180	80	0.002
1.5	12100	185	55	0.005	27500	345	130	0.004	20300	270	95	0.004
2.0	9350	200	60	0.007	22000	420	140	0.006	16500	310	105	0.006
3.0	6050	200	55	0.011	15400	430	145	0.009	11000	310	105	0.009
4.0	4600	185	60	0.013	11000	420	140	0.013	8800	310	110	0.012
5.0	3650	200	55	0.018	9150	420	145	0.015	6800	310	105	0.015
6.0	2950	230	55	0.026	7600	440	145	0.019	5700	340	105	0.020
8.0	2200	240	55	0.036	5700	440	145	0.026	4400	330	110	0.025
10.0	1850	255	60	0.046	4600	440	145	0.032	3400	330	105	0.032
12.0	1450	275	55	0.063	3750	430	140	0.038	2850	330	105	0.039
14.0	1300	285	55	0.073	3300	430	145	0.043	2400	330	105	0.046
16.0	1100	285	55	0.086	2850	430	145	0.050	2200	330	110	0.050
20.0	900	310	55	0.115	2200	430	140	0.065	1700	330	105	0.065

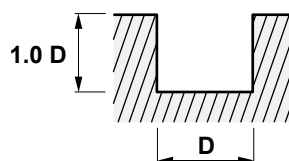

* FEED, in long and extra long types, should be reduced by around 50%.
* Bei langen und extra-langen Typen soll der Vorschub um ca.50% reduziert werden.



6030 *Solid carbide square End Mills. Finish side cutting.
VHM-viereckige Schaftfräser. Seitwärts Schlichten.*

Diameter / Durchmesser (Ø d1) mm	Material / Materialien											
	Unalloyed steels / Unlegierter Stahl Alloyed steels / Legierter Stahl Tool steels / Werkzeugstahl ~ HRC30 / 1000 N/mm ²				Alloyed steels / Legierter Stahl Heat resistant steels / Hitzebeständiger Stahl ~ HRC30 ~ HRC45 / 1000 ~ 1500 N/mm ²				Stainless steels / Rostfreier Stahl			
	R.P.M Min.	Feed / Vorschub mm/min.	Vc (M/Min.)	fz (mm/tooth) (Mm/Zahn)	R.P.M Min.	Feed / Vorschub mm/min.	Vc (M/Min.)	fz (mm/tooth) (Mm/Zahn)	R.P.M Min.	Feed / Vorschub mm/min.	Vc (M/Min.)	fz (mm/tooth) (Mm/Zahn)
1.0	17600	110	55	0.002	10250	65	30	0.002	8650	55	25	0.002
1.5	11800	160	55	0.005	7050	85	35	0.004	7050	90	35	0.004
2.0	9850	180	60	0.006	6450	120	40	0.006	5350	100	35	0.006
3.0	7600	205	70	0.009	4750	130	45	0.009	3950	105	35	0.009
4.0	6450	365	80	0.019	3950	220	50	0.019	3300	180	40	0.018
5.0	5350	385	85	0.024	3200	230	50	0.024	2700	195	40	0.024
6.0	4750	425	90	0.030	2850	265	55	0.031	2400	215	45	0.030
8.0	3550	450	90	0.042	2150	245	55	0.038	1800	225	45	0.042
10.0	2750	390	85	0.047	1700	195	55	0.038	1450	195	45	0.045
12.0	2350	330	90	0.047	1450	160	55	0.037	1150	155	45	0.045
14.0	2100	465	90	0.074	1300	145	55	0.037	1050	140	45	0.044
16.0	1850	265	95	0.048	1150	130	60	0.038	900	130	45	0.048
20.0	1450	205	90	0.047	900	100	55	0.037	700	100	45	0.048

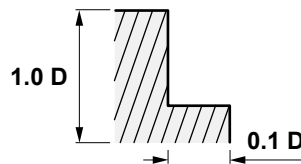

Diameter / Durchmesser (Ø d1) mm	Material / Materialien											
	Cast iron / Grauguß				Aluminium alloys / Aluminium-Legierungen				Copper, brass / Kupfer, Messing Non-ferrous metals / Nicht-Eisen-Metalle			
	R.P.M Min.	Feed / Vorschub mm/min.	Vc (M/Min.)	fz (mm/tooth) (Mm/Zahn)	R.P.M Min.	Feed / Vorschub mm/min.	Vc (M/Min.)	fz (mm/tooth) (Mm/Zahn)	R.P.M Min.	Feed / Vorschub mm/min.	Vc (M/Min.)	fz (mm/tooth) (Mm/Zahn)
1.0	18700	460	60	0.008	44000	750	140	0.006	24700	450	80	0.006
1.5	12100	460	55	0.013	27500	860	130	0.010	20300	675	95	0.011
2.0	9350	475	60	0.017	22000	1035	140	0.016	16500	770	105	0.016
3.0	6050	475	55	0.026	15400	990	145	0.021	11000	760	105	0.023
4.0	4600	485	60	0.035	11000	1035	140	0.031	8800	770	110	0.029
5.0	3650	485	55	0.044	9150	1010	145	0.037	6800	760	105	0.037
6.0	2950	570	55	0.064	7600	1100	145	0.048	5700	825	105	0.048
8.0	2200	615	55	0.093	5700	1100	145	0.064	4400	825	110	0.063
10.0	1850	640	60	0.115	4600	1100	145	0.080	3400	825	105	0.081
12.0	1450	670	55	0.154	3750	1100	140	0.098	2850	825	105	0.096
14.0	1300	705	55	0.181	3300	1100	145	0.111	2400	825	105	0.115
16.0	1100	725	55	0.220	2850	1100	145	0.129	2200	825	110	0.125
20.0	900	770	55	0.285	2200	1100	140	0.167	1700	825	105	0.162

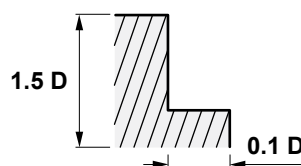

* FEED, in long and extra long types, should be reduced by around 50%.
* Bei langen und extra-langen Typen soll der Vorschub um ca.50% reduziert werden.

Solid carbide square End Mills.

For high speed cutting (HSC) <56HRC

Long series, three flutes



VHM-viereckige Schafffräser

Zum Hochgeschwindigkeitsschneiden (HSC) <56HRC

Lange Ausführung, drei Schneiden

Characteristics:

Recommended for milling in materials with medium and high tensile strength up to 1.300 N/mm².

For drilling continued by horizontal milling with exact tolerances.

Eigenschaften:

Empfohlen zum Fräsen von Werkstoffen mit mittlerer bis hoher Zugfestigkeit bis ca. 1.300 N/mm². Zum Bohren und anschließenden Längsfräsen mit genauen Toleranzen.

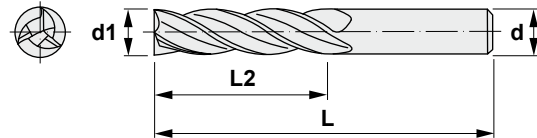
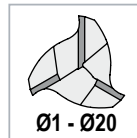
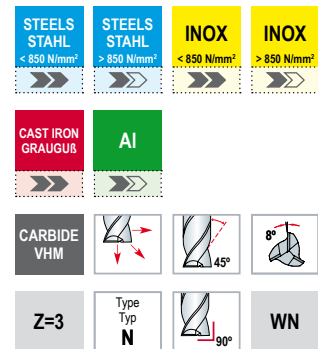

6031

Reference Bezeichnung		d1	d	L2	L
603101	3	1	3	5	60
603102	3	2	3	10	60
603103	3	3	3	15	60
603104	3	4	4	20	80
603105	3	5	5	25	80
603106	3	6	6	25	80
603108	3	8	8	35	90
603110	3	10	10	45	100
603112	3	12	12	50	100
603114	3	14	14	65	150
603116	3	16	16	65	150
603120	3	20	20	70	150



**6031 Solid carbide square End Mills. Finish slotting.
VHM-viereckige Schafffräser. Nuten-Schlichten.**

Diameter / Durchmesser (Ø d1) mm	Material / Materialien											
	Unalloyed steels / Unlegierter Stahl Alloyed steels / Legierter Stahl Tool steels / Werkzeugstahl ~ HRC30 / 1000 N/mm ²				Alloyed steels / Legierter Stahl Heat resistant steels / Hitzebeständiger Stahl ~ HRC30 ~ HRC45 / 1000 ~ 1500 N/mm ²				Stainless steels / Rostfreier Stahl			
	R.P.M Min.	Feed / Vorschub mm/min.	Vc (M/Min.)	fz (mm/tooth) (Mm/Zahn)	R.P.M Min.	Feed / Vorschub mm/min.	Vc (M/Min.)	fz (mm/tooth) (Mm/Zahn)	R.P.M Min.	Feed / Vorschub mm/min.	Vc (M/Min.)	fz (mm/tooth) (Mm/Zahn)
1	14300	75	45	0.002	8500	45	25	0.002	7150	35	20	0.002
2	7850	110	50	0.005	5150	70	30	0.005	4300	55	25	0.004
3	6100	125	55	0.007	3800	85	35	0.007	3150	70	30	0.007
4	5150	180	65	0.012	3150	110	40	0.012	2650	90	35	0.011
5	4300	190	70	0.015	2550	110	40	0.014	2150	95	35	0.015
6	3800	210	70	0.018	2300	135	45	0.020	1950	110	35	0.019
8	2850	230	70	0.027	1700	120	45	0.024	1450	110	35	0.025
10	2200	195	70	0.030	1350	95	40	0.023	1150	95	35	0.028
12	1850	170	70	0.031	1150	75	45	0.022	950	75	35	0.026
14	1700	150	75	0.029	1050	70	45	0.022	850	70	35	0.027
16	1500	130	75	0.029	950	65	50	0.023	700	65	35	0.031
20	1150	100	70	0.029	700	50	45	0.024	550	50	35	0.030

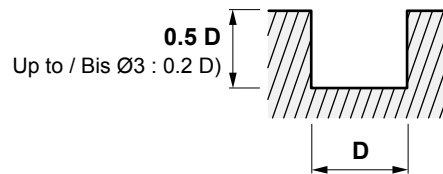

Diameter / Durchmesser (Ø d1) mm	Material / Materialien											
	Cast iron / Grauguß				Aluminium alloys / Aluminium-Legierungen				Copper, brass / Kupfer, Messing Non-ferrous metals / Nicht-Eisen-Metalle			
	R.P.M Min.	Feed / Vorschub mm/min.	Vc (M/Min.)	fz (mm/tooth) (Mm/Zahn)	R.P.M Min.	Feed / Vorschub mm/min.	Vc (M/Min.)	fz (mm/tooth) (Mm/Zahn)	R.P.M Min.	Feed / Vorschub mm/min.	Vc (M/Min.)	fz (mm/tooth) (Mm/Zahn)
1	18700	185	60	0.003	44000	300	140	0.002	24700	180	80	0.002
2	9350	200	60	0.007	22000	420	140	0.006	16500	310	105	0.006
3	6050	200	55	0.011	15400	430	145	0.009	11000	310	105	0.009
4	4600	185	60	0.013	11000	420	140	0.013	8800	310	110	0.012
5	3650	200	55	0.018	9150	420	145	0.015	6800	310	105	0.015
6	2950	230	55	0.026	7600	440	145	0.019	5700	340	105	0.020
8	2200	240	55	0.036	5700	440	145	0.026	4400	330	110	0.025
10	1850	255	60	0.046	4600	440	145	0.032	3400	330	105	0.032
12	1450	275	55	0.063	3750	430	140	0.038	2850	330	105	0.039
14	1300	285	55	0.073	3300	430	145	0.043	2400	330	105	0.046
16	1100	285	55	0.086	2850	430	145	0.050	2200	330	110	0.050
20	900	310	55	0.115	2200	430	140	0.065	1700	330	105	0.065

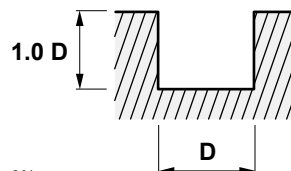

* FEED, in long and extra long types, should be reduced by around 50%.
* Bei langen und extra-langen Typen soll der Vorschub um ca.50% reduziert werden.

6031 Solid carbide square End Mills. Finish side cutting. VHM-viereckige Schafffräser. Seitwärts Schlichten.

Diameter / Durchmesser (Ø d1) mm	Material / Materialien											
	Unalloyed steels / Unlegierter Stahl Alloyed steels / Legierter Stahl Tool steels / Werkzeugstahl ~ HRC30 / 1000 N/mm ²				Alloyed steels / Legierter Stahl Heat resistant steels / Hitzebeständiger Stahl ~ HRC30 ~ HRC45 / 1000 ~ 1500 N/mm ²				Stainless steels / Rostfreier Stahl			
	R.P.M Min.	Feed / Vorschub mm/min.	Vc (M/Min.)	fz (mm/tooth) (Mm/Zahn)	R.P.M Min.	Feed / Vorschub mm/min.	Vc (M/Min.)	fz (mm/tooth) (Mm/Zahn)	R.P.M Min.	Feed / Vorschub mm/min.	Vc (M/Min.)	fz (mm/tooth) (Mm/Zahn)
1	17600	110	55	0.002	10250	65	30	0.002	8650	55	25	0.002
2	9850	180	60	0.006	6450	120	40	0.006	5350	100	35	0.006
3	7600	205	70	0.009	4750	130	45	0.009	3950	105	35	0.009
4	6450	365	80	0.019	3950	220	50	0.019	3300	180	40	0.018
5	5350	385	85	0.024	3200	230	50	0.024	2700	195	40	0.024
6	4750	425	90	0.030	2850	265	55	0.031	2400	215	45	0.030
8	3550	450	90	0.042	2150	245	55	0.038	1800	225	45	0.042
10	2750	390	85	0.047	1700	195	55	0.038	1450	195	45	0.045
12	2350	330	90	0.047	1450	160	55	0.037	1150	155	45	0.045
14	2100	465	90	0.074	1300	145	55	0.037	1050	140	45	0.044
16	1850	265	95	0.048	1150	130	60	0.038	900	130	45	0.048
20	1450	205	90	0.047	900	100	55	0.037	700	100	45	0.048

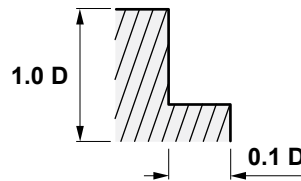

Diameter / Durchmesser (Ø d1) mm	Material / Materialien											
	Cast iron / Grauguß				Aluminium alloys / Aluminium-Legierungen				Copper, brass / Kupfer, Messing Non-ferrous metals / Nicht-Eisen-Metalle			
	R.P.M Min.	Feed / Vorschub mm/min.	Vc (M/Min.)	fz (mm/tooth) (Mm/Zahn)	R.P.M Min.	Feed / Vorschub mm/min.	Vc (M/Min.)	fz (mm/tooth) (Mm/Zahn)	R.P.M Min.	Feed / Vorschub mm/min.	Vc (M/Min.)	fz (mm/tooth) (Mm/Zahn)
1	18700	460	60	0.008	44000	750	140	0.006	24700	450	80	0.006
2	9350	475	60	0.017	22000	1035	140	0.016	16500	770	105	0.016
3	6050	475	55	0.026	15400	990	145	0.021	11000	760	105	0.023
4	4600	485	60	0.035	11000	1035	140	0.031	8800	770	110	0.029
5	3650	485	55	0.044	9150	1010	145	0.037	6800	760	105	0.037
6	2950	570	55	0.064	7600	1100	145	0.048	5700	825	105	0.048
8	2200	615	55	0.093	5700	1100	145	0.064	4400	825	110	0.063
10	1850	640	60	0.115	4600	1100	145	0.080	3400	825	105	0.081
12	1450	670	55	0.154	3750	1100	140	0.098	2850	825	105	0.096
14	1300	705	55	0.181	3300	1100	145	0.111	2400	825	105	0.115
16	1100	725	55	0.220	2850	1100	145	0.129	2200	825	110	0.125
20	900	770	55	0.285	2200	1100	140	0.167	1700	825	105	0.162

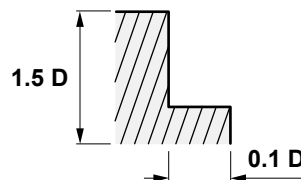

* FEED, in long and extra long types, should be reduced by around 50%.
* Bei langen und extra-langen Typen soll der Vorschub um ca.50% reduziert werden.



Solid carbide square End Mills.

For high speed cutting (HSC) <56HRC

Short series, four flutes



VHM-viereckige Schafffräser

Zum Hochgeschwindigkeitsschneiden (HSC) <56HRC

Kurze Ausführung, vier Schneiden

Characteristics:

Recommended for milling in materials with medium and high tensile strength. For milling of slots with large depth and accurate fits, as well as face and surface milling. High cutting performance in chipping and a smooth run result an excellent surface.

Eigenschaften:

Empfohlen zum Fräsen von Werkstoffen mit mittlerer bis hoher Zugfestigkeit. Zum Fräsen von Nuten mit großer Bohrtiefe und exakten Passungen, ebenso zum Stirn- und Umfangfräsen geeignet. Hohe Zerspanungsleistung und große Laufruhe ergeben eine hervorragende Oberflächengüte.

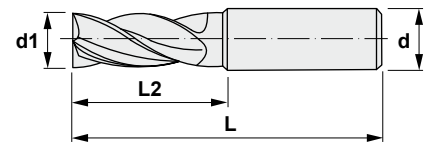
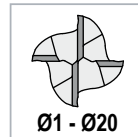
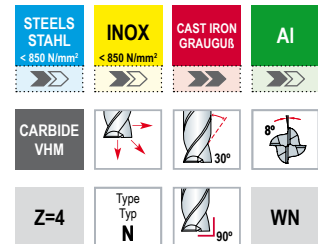

6040

Reference Bezeichnung		d1	d	L2	L
6040010	4	1,0	3	3	38
6040015	4	1,5	3	4	38
6040020	4	2,0	3	6	38
6040030	4	3,0	3	8	38
6040040	4	4,0	4	11	50
6040050	4	5,0	5	13	50
6040060	4	6,0	6	16	50
6040080	4	8,0	8	19	60
6040100	4	10,0	10	22	72
6040120	4	12,0	12	26	75
6040140	4	14,0	14	30	84
6040160	4	16,0	16	32	92
6040200	4	20,0	20	38	100

6040 Solid carbide square End Mills. VHM-viereckige Schafffräser.

Diameter / Durchmesser (Ø d1) mm	Material / Materialien											
	Unalloyed steels / Unlegierter Stahl Alloyed steels / Legierter Stahl Tool steels / Werkzeugstahl ~ HRC30 / 1000 N/mm ²				Alloyed steels / Legierter Stahl Heat resistant steels / Hitzebeständiger Stahl ~ HRC30 ~ HRC45 / 1000 ~ 1500 N/mm ²				Stainless steels / Rostfreier Stahl			
	R.P.M Min.	Feed / Vorschub mm/min.	Vc (M/Min.)	fz (mm/tooth) (Mm/Zahn)	R.P.M Min.	Feed / Vorschub mm/min.	Vc (M/Min.)	fz (mm/tooth) (Mm/Zahn)	R.P.M Min.	Feed / Vorschub mm/min.	Vc (M/Min.)	fz (mm/tooth) (Mm/Zahn)
1.0	17600	150	55	0.002	10250	85	30	0.002	8650	75	25	0.002
1.5	11800	215	55	0.005	7050	115	35	0.004	7050	120	35	0.004
2.0	9850	240	60	0.006	6450	145	40	0.006	5350	120	35	0.006
3.0	7600	270	70	0.009	4750	170	45	0.009	3950	145	35	0.009
4.0	6450	485	80	0.019	3950	300	50	0.019	3300	240	40	0.018
5.0	5350	510	85	0.024	3200	305	50	0.024	2700	255	40	0.024
6.0	4750	560	90	0.029	2850	350	55	0.031	2400	280	45	0.029
8.0	3550	605	90	0.043	2150	325	55	0.038	1800	300	45	0.042
10.0	2750	520	85	0.047	1700	255	55	0.038	1450	255	45	0.044
12.0	2350	440	90	0.047	1450	215	55	0.037	1150	205	45	0.045
14.0	2100	395	90	0.047	1300	195	55	0.038	1050	190	45	0.045
16.0	1850	350	95	0.047	1150	170	60	0.037	950	170	50	0.045
20.0	1450	270	90	0.047	900	135	55	0.038	700	130	45	0.046

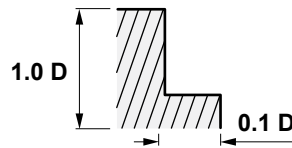

Diameter / Durchmesser (Ø d1) mm	Material / Materialien											
	Cast iron / Grauguß				Aluminium alloys / Aluminium-Legierungen				Copper, brass / Kupfer, Messing Non-ferrous metals / Nicht-Eisen-Metalle			
	R.P.M Min.	Feed / Vorschub mm/min.	Vc (M/Min.)	fz (mm/tooth) (Mm/Zahn)	R.P.M Min.	Feed / Vorschub mm/min.	Vc (M/Min.)	fz (mm/tooth) (Mm/Zahn)	R.P.M Min.	Feed / Vorschub mm/min.	Vc (M/Min.)	fz (mm/tooth) (Mm/Zahn)
1.0	18700	620	60	0.008	44000	1050	140	0.006	24700	605	80	0.006
1.5	12100	620	55	0.013	27500	1160	130	0.011	20300	910	95	0.011
2.0	9350	640	60	0.017	22000	1320	140	0.015	16500	1035	105	0.016
3.0	6050	640	55	0.026	15400	1320	145	0.021	11000	1035	105	0.024
4.0	4600	640	60	0.035	11000	1320	140	0.030	8800	1035	110	0.029
5.0	3650	640	55	0.044	9150	1320	145	0.036	6800	1035	105	0.038
6.0	2950	770	55	0.065	7600	1430	145	0.047	5700	1100	105	0.048
8.0	2200	815	55	0.093	5700	1430	145	0.063	4400	1100	110	0.063
10.0	1850	860	60	0.116	4600	1430	145	0.078	3400	1100	105	0.081
12.0	1450	900	55	0.155	3750	1430	140	0.095	2850	1100	105	0.096
14.0	1300	945	55	0.182	3300	1430	145	0.108	2400	1100	105	0.115
16.0	1100	970	55	0.220	2850	1430	145	0.125	2200	1100	110	0.125
20.0	900	1035	55	0.288	2200	1430	140	0.163	1700	1100	105	0.162

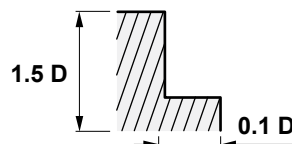

* FEED, in long and extra long types, should be reduced by around 50%.
* Bei langen und extra-langen Typen soll der Vorschub um ca.50% reduziert werden.



Solid carbide square End Mills.

For high speed cutting (HSC) <56HRC

Long series, four flutes



VHM-viereckige Schafffräser

Zum Hochgeschwindigkeitsschneiden (HSC) <56HRC

Lange Ausführung, vier Schneiden

Characteristics:

Recommended for milling in materials with medium and high tensile strength. For milling of slots with large depth and accurate fits, as well as face and surface milling. High cutting performance in chipping and a smooth run result an excellent surface.

Eigenschaften:

Empfohlen zum Fräsen von Werkstoffen mit mittlerer bis hoher Zugfestigkeit. Zum Fräsen von Nuten mit größerer Bohrtiefe und exakten Passungen, ebenso zum Stirn- und Umfangfräsen geeignet. Hohe Zerspanungsleistung und große Laufruhe ergeben eine hervorragende Oberflächengüte.

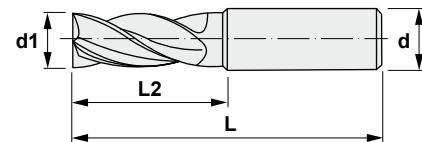
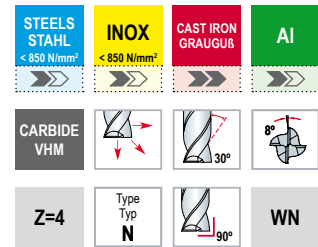

6041

Reference Bezeichnung		d1	d	L2	L
604101	4	1	3	5	60
604102	4	2	3	10	60
604103	4	3	3	15	60
604104	4	4	4	20	80
604105	4	5	5	25	80
604106	4	6	6	25	80
604108	4	8	8	35	90
604110	4	10	10	45	100
604112	4	12	12	50	100
604114	4	14	14	65	150
604116	4	16	16	65	150
604120	4	20	20	70	150

6041 Solid carbide square End Mills. VHM-viereckige Schafffräser.

Diameter / Durchmesser (Ø d1) mm	Material / Materialien											
	Unalloyed steels / Unlegierter Stahl Alloyed steels / Legierter Stahl Tool steels / Werkzeugstahl ~ HRC30 / 1000 N/mm ²				Alloyed steels / Legierter Stahl Heat resistant steels / Hitzebeständiger Stahl ~ HRC30 ~ HRC45 / 1000 ~ 1500 N/mm ²				Stainless steels / Rostfreier Stahl			
	R.P.M Min.	Feed / Vorschub mm/min.	Vc (M/Min.)	fz (mm/tooth) (Mm/Zahn)	R.P.M Min.	Feed / Vorschub mm/min.	Vc (M/Min.)	fz (mm/tooth) (Mm/Zahn)	R.P.M Min.	Feed / Vorschub mm/min.	Vc (M/Min.)	fz (mm/tooth) (Mm/Zahn)
1	17600	150	55	0.002	10250	85	30	0.002	8650	75	25	0.002
2	9850	240	60	0.006	6450	145	40	0.006	5350	120	35	0.006
3	7600	270	70	0.009	4750	170	45	0.009	3950	145	35	0.009
4	6450	485	80	0.019	3950	300	50	0.019	3300	240	40	0.018
5	5350	510	85	0.024	3200	305	50	0.024	2700	255	40	0.024
6	4750	560	90	0.029	2850	350	55	0.031	2400	280	45	0.029
8	3550	605	90	0.043	2150	325	55	0.038	1800	300	45	0.042
10	2750	520	85	0.047	1700	255	55	0.038	1450	255	45	0.044
12	2350	440	90	0.047	1450	215	55	0.037	1150	205	45	0.045
14	2100	395	90	0.047	1300	195	55	0.038	1050	190	45	0.045
16	1850	350	95	0.047	1150	170	60	0.037	950	170	50	0.045
20	1450	270	90	0.047	900	135	55	0.038	700	130	45	0.046

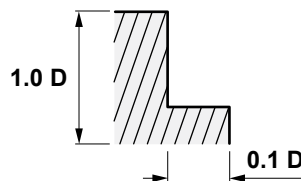

Diameter / Durchmesser (Ø d1) mm	Material / Materialien											
	Cast iron / Grauguß				Aluminium alloys / Aluminium-Legierungen				Copper, brass / Kupfer, Messing Non-ferrous metals / Nicht-Eisen-Metalle			
	R.P.M Min.	Feed / Vorschub mm/min.	Vc (M/Min.)	fz (mm/tooth) (Mm/Zahn)	R.P.M Min.	Feed / Vorschub mm/min.	Vc (M/Min.)	fz (mm/tooth) (Mm/Zahn)	R.P.M Min.	Feed / Vorschub mm/min.	Vc (M/Min.)	fz (mm/tooth) (Mm/Zahn)
1	18700	620	60	0.008	44000	1050	140	0.006	24700	605	80	0.006
2	9350	640	60	0.017	22000	1320	140	0.015	16500	1035	105	0.016
3	6050	640	55	0.026	15400	1320	145	0.021	11000	1035	105	0.024
4	4600	640	60	0.035	11000	1320	140	0.030	8800	1035	110	0.029
5	3650	640	55	0.044	9150	1320	145	0.036	6800	1035	105	0.038
6	2950	770	55	0.065	7600	1430	145	0.047	5700	1100	105	0.048
8	2200	815	55	0.093	5700	1430	145	0.063	4400	1100	110	0.063
10	1850	860	60	0.116	4600	1430	145	0.078	3400	1100	105	0.081
12	1450	900	55	0.155	3750	1430	140	0.095	2850	1100	105	0.096
14	1300	945	55	0.182	3300	1430	145	0.108	2400	1100	105	0.115
16	1100	970	55	0.220	2850	1430	145	0.125	2200	1100	110	0.125
20	900	1035	55	0.288	2200	1430	140	0.163	1700	1100	105	0.162

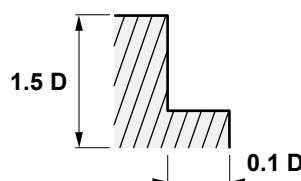

* FEED, in long and extra long types, should be reduced by around 50%.
* Bei langen und extra-langen Typen soll der Vorschub um ca.50% reduziert werden.



Solid carbide End Mills. Ball form.

For high speed cutting (HSC) <56HRC

Short series, two flutes

VHM-Radius-Schaftfräser

Zum Hochgeschwindigkeitsschneiden (HSC) <56HRC

Kurze Ausführung, zwei Schneiden



Characteristics:

Recommended for milling materials with medium/high tensile strength. Especially suited for copy milling.

Eigenschaften:

Empfohlen zum Fräsen von Werkstoffen mit mittlerer bis hoher Zugfestigkeit. Besonders geeignet zum Kopierfräsen.

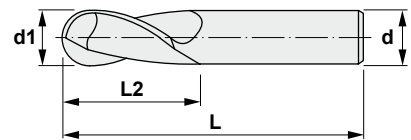
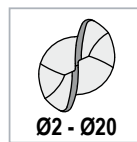
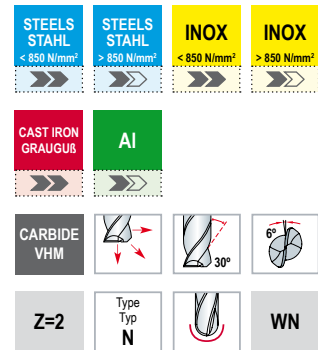

6320

Reference Bezeichnung		d1	d	L2	L
632002	2	2	3	4	38
632003	2	3	3	6	38
632004	2	4	4	8	50
632005	2	5	5	10	50
632006	2	6	6	12	50
632008	2	8	8	15	60
632010	2	10	10	20	75
632012	2	12	12	20	75
632014	2	14	14	25	90
632016	2	16	16	25	100
632018	2	18	18	30	100
632020	2	20	20	30	100

6320 Solid carbide End Mills. Ball form. VHM-Radius-Schafffräser.

Diameter / Durchmesser (Ø d1) mm	Material / Materialien											
	Unalloyed steels / Unlegierter Stahl Alloyed steels / Legierter Stahl Tool steels / Werkzeugstahl ~ HRC30 ~ 1000 N/mm²				Alloyed steels / Legierter Stahl Heat resistant steels / Hitzebeständiger Stahl HRC30 ~ HRC45 / 1000 ~ 1500 N/mm²				Hardened steels / Gehärteter Stahl HRC30 ~ HRC45 / 1000 ~ 1500 N/mm²			
	R.P.M Min.	Feed / Vorschub mm/min.	Vc (M/Min.)	fz (mm/tooth) (Mm/Zahn)	R.P.M Min.	Feed / Vorschub mm/min.	Vc (M/Min.)	fz (mm/tooth) (Mm/Zahn)	R.P.M Min.	Feed / Vorschub mm/min.	Vc (M/Min.)	fz (mm/tooth) (Mm/Zahn)
R1 x 2D	12350	640	80	0.026	9150	415	55	0.023	4000	125	25	0.016
R1.5 x 3D	11400	575	105	0.025	8550	390	80	0.023	3800	125	35	0.016
R2 x 4D	8950	630	110	0.035	7150	450	90	0.031	3600	150	45	0.021
R2.5 x 5D	7800	700	125	0.045	6200	490	95	0.040	3100	150	50	0.024
R3 x 6D	7250	870	135	0.060	5900	705	110	0.060	2700	160	50	0.030
R4 x 8D	6100	1090	155	0.089	4900	785	125	0.080	2050	190	50	0.046
R5 x 10D	5450	1330	170	0.122	4350	870	135	0.100	1750	190	55	0.054
R6 x 12D	4990	1500	190	0.150	3950	950	150	0.120	1500	210	55	0.070
R7 x 14D	4530	1495	200	0.165	3600	925	160	0.128	1300	210	55	0.081
R8 x 16D	4085	1470	205	0.180	3200	905	160	0.141	1150	210	60	0.091
R9 x 18D	3800	1425	215	0.188	3000	890	170	0.148	1050	210	60	0.100
R10 x 20D	3550	1425	225	0.201	2800	885	175	0.158	950	210	60	0.111

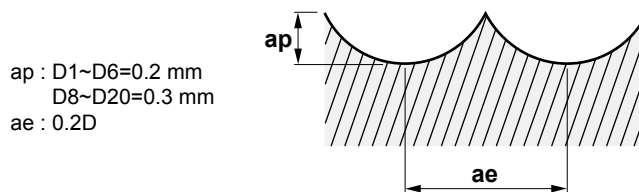

Diameter / Durchmesser (Ø d1) mm	Material / Materialien							
	Cast iron / Grauguß				Aluminium alloys / Aluminium-Legierungen			
	R.P.M Min.	Feed / Vorschub mm/min.	Vc (M/Min.)	fz (mm/tooth) (Mm/Zahn)	R.P.M Min.	Feed / Vorschub mm/min.	Vc (M/Min.)	fz (mm/tooth) (Mm/Zahn)
R1 x 2D	10500	220	65	0.010	30800	395	195	0.006
R1.5 x 3D	7050	230	65	0.016	20500	395	195	0.010
R2 x 4D	5150	285	65	0.028	15400	395	195	0.013
R2.5 x 5D	4150	330	65	0.040	12100	470	190	0.019
R3 x 6D	3400	360	65	0.053	10300	470	195	0.023
R4 x 8D	2500	460	65	0.092	7900	540	200	0.034
R5 x 10D	2050	460	65	0.112	6150	540	195	0.044
R6 x 12D	1750	460	65	0.131	5150	630	195	0.061
R7 x 14D	1400	460	60	0.164	4300	630	190	0.073
R8 x 16D	1300	460	65	0.177	3850	540	195	0.070
R9 x 18D	1100	460	60	0.209	3400	540	190	0.079
R10 x 20D	1050	420	65	0.200	2950	540	185	0.092

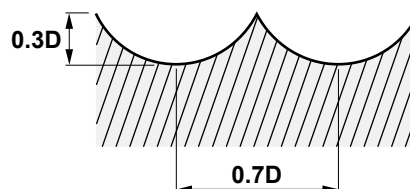

Solid carbide End Mills. Ball form.

For high speed cutting (HSC) <56HRC

Long series, two flutes



VHM-Radius-Schaftfräser

Zum Hochgeschwindigkeitsschneiden (HSC) <56HRC

Lange Ausführung, zwei Schneiden

Characteristics:

Recommended for milling materials with medium/high tensile strength. Especially suited for copy milling.

Eigenschaften:

Empfohlen zum Fräsen von Werkstoffen mit mittlerer bis hoher Festigkeit. Besonders geeignet zum Kopierfräsen.

STEELS STAHL < 850 N/mm ²	STEELS STAHL > 850 N/mm ²	INOX < 850 N/mm ²	INOX > 850 N/mm ²
CAST IRON GRAUGUß	Al		
CARBIDE VHM			
Z=2	Type Typ N		WN

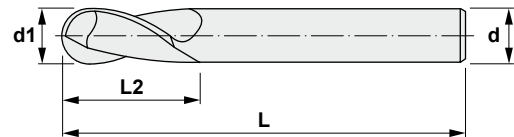
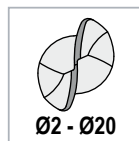

6321

Reference Bezeichnung		d1	d	L2	L
632102	2	2	3	3	60
632103	2	3	3	4	60
632104	2	4	4	5	80
632105	2	5	5	6	80
632106	2	6	6	8	80
632108	2	8	8	12	100
632110	2	10	10	15	100
632112	2	12	12	15	100
632116	2	16	16	20	150
632120	2	20	20	25	150

6321 Solid carbide End Mills. Ball form. VHM-Radius-Schafffräser.

Diameter / Durchmesser (Ø d1) mm	Material / Materialien											
	Unalloyed steels / Unlegierter Stahl Alloyed steels / Legierter Stahl Tool steels / Werkzeugstahl ~ HRC30 / ~ 1000 N/mm²				Alloyed steels / Legierter Stahl Heat resistant steels / Hitzebeständiger Stahl HRC30 ~ HRC45 / 1000 ~ 1500 N/mm²				Hardened steels / Gehärteter Stahl HRC30 ~ HRC45 / 1000 ~ 1500 N/mm²			
	R.P.M Min.	Feed / Vorschub mm/min.	Vc (M/Min.)	fz (mm/tooth) (Mm/Zahn)	R.P.M Min.	Feed / Vorschub mm/min.	Vc (M/Min.)	fz (mm/tooth) (Mm/Zahn)	R.P.M Min.	Feed / Vorschub mm/min.	Vc (M/Min.)	fz (mm/tooth) (Mm/Zahn)
R1 x 2D	12350	640	80	0.026	9150	415	55	0.023	4000	125	25	0.016
R1.5 x 3D	11400	575	105	0.025	8550	390	80	0.023	3800	125	35	0.016
R2 x 4D	8950	630	110	0.035	7150	450	90	0.031	3600	150	45	0.021
R2.5 x 5D	7800	700	125	0.045	6200	490	95	0.040	3100	150	50	0.024
R3 x 6D	7250	870	135	0.060	5900	705	110	0.060	2700	160	50	0.030
R4 x 8D	6100	1090	155	0.089	4900	785	125	0.080	2050	190	50	0.046
R5 x 10D	5450	1330	170	0.122	4350	870	135	0.100	1750	190	55	0.054
R6 x 12D	4990	1500	190	0.150	3950	950	150	0.120	1500	210	55	0.070
R8 x 16D	4085	1470	205	0.180	3200	905	160	0.141	1150	210	60	0.091
R10 x 20D	3550	1425	225	0.201	2800	885	175	0.158	950	210	60	0.111

ap : D1~D6=0.2 mm
D8~D20=0.3 mm
ae : 0.2D

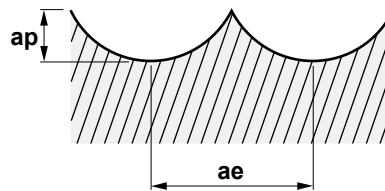

Diameter / Durchmesser (Ø d1) mm	Material / Materialien							
	Cast iron / Grauguß				Aluminium alloys / Aluminium-Legierungen			
	R.P.M Min.	Feed / Vorschub mm/min.	Vc (M/Min.)	fz (mm/tooth) (Mm/Zahn)	R.P.M Min.	Feed / Vorschub mm/min.	Vc (M/Min.)	fz (mm/tooth) (Mm/Zahn)
R1 x 2D	10500	220	65	0.010	30800	395	195	0.006
R1.5 x 3D	7050	230	65	0.016	20500	395	195	0.010
R2 x 4D	5150	285	65	0.028	15400	395	195	0.013
R2.5 x 5D	4150	330	65	0.040	12100	470	190	0.019
R3 x 6D	3400	360	65	0.053	10300	470	195	0.023
R4 x 8D	2500	460	65	0.092	7900	540	200	0.034
R5 x 10D	2050	460	65	0.112	6150	540	195	0.044
R6 x 12D	1750	460	65	0.131	5150	630	195	0.061
R8 x 16D	1300	460	65	0.177	3850	540	195	0.070
R10 x 20D	1050	420	65	0.200	2950	540	185	0.092

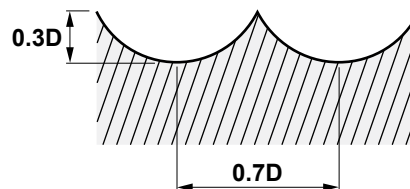

Solid carbide quarter circle cutters

DIN 6535-HA

Four flutes

VHM-Viertelkreis-Profilfräser

DIN 6535-HA

Vier Schneiden



Characteristics:

Recommended for milling in construction steels, tempered steels and cementation steels with standard tensile strength up to 1.100 N/mm² and short-chipping of non-ferrous metals.

Eigenschaften:

Empfohlen zum Fräsen von Bau-, Einsatz- und Vergütungsstählen mit normaler Zugfestigkeit bis 1.100 N/mm², sowie für kurzspanende NE-Metalle.

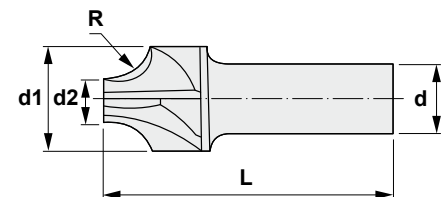
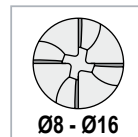
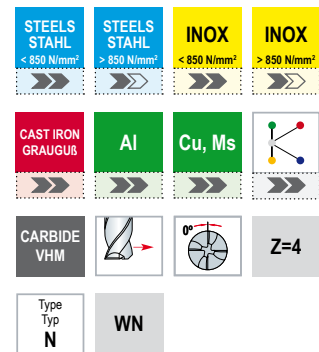

84

Reference Bezeichnung		d1	d2	d	R	L
8441.0	4	8,0	6,0	8	1,0	64
8441.5	4	8,0	5,0	8	1,5	64
8442.0	4	8,0	4,0	8	2,0	64
8442.5	4	10,0	5,0	10	2,5	67
8443.0	4	10,0	4,0	10	3,0	67
8443.5	4	12,0	5,0	12	3,5	74
8444.0	4	12,0	4,0	12	4,0	74
8445.0	4	16,0	6,0	16	5,0	83
8446.0	4	16,0	4,0	16	6,0	83

Solid carbide deburring mills 60°

DIN 6535-HB

Four-six flutes



VHM-Entgrater 60°

DIN 6535-HB

Vier-sechs Schneiden

Characteristics:

Universal range of application, especially suited for chamfering and deburring as well as contouring.

Eigenschaften:

Universeller Anwendungsbereich, besonders geeignet zum Anfasen und Entgraten sowie für Konturarbeiten.

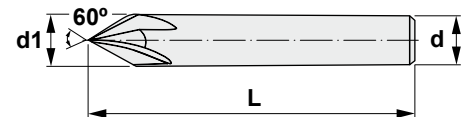
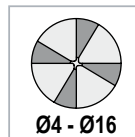
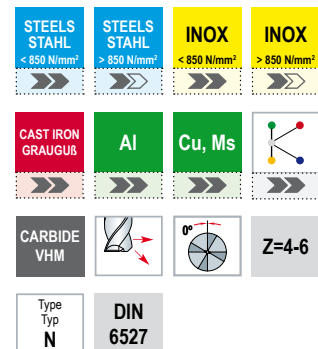

86

Reference Bezeichnung		d1	d	L
86404	4	4	4	54
86406	4	6	6	57
86408	4	8	8	63
86410	4	10	10	72
86412	4	12	12	83
86416	6	16	16	92

Solid carbide deburring mills 90°

DIN 6535-HB

Four-six flutes

VHM-Entgrater 90°

DIN 6535-HB

Vier-sechs Schneiden



Characteristics:

Universal range of application, especially suited for chamfering and deburring as well as contouring.

Eigenschaften:

Universeller Anwendungsbereich, besonders geeignet zum Anfasen und Entgraten sowie für Konturarbeiten.

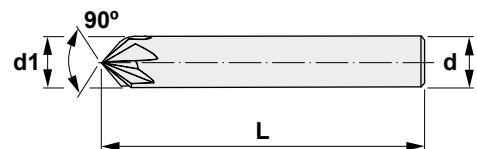
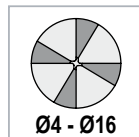
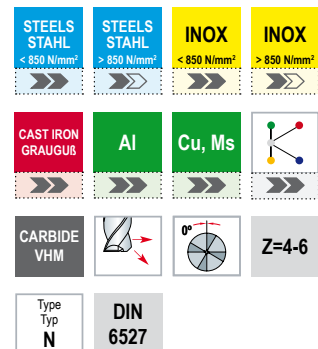

87

Reference Bezeichnung		d1	d	L
87404	4	4	4	54
87406	4	6	6	57
87408	4	8	8	63
87410	4	10	10	72
87412	4	12	12	83
87416	6	16	16	92



Solid carbide forward and reverse deburring mills.

2 x 90° DIN 6535-HA

Four flutes

VHM Vor- und Rückwärtentgrater.

2 x 90° DIN 6535-HA

Vier Schneiden

Characteristics:

Universal range of application, especially suited for chamfering, forward and reverse deburring as well as contouring.

Eigenschaften:

Universeller Anwendungsbereich, besonders geeignet zum Anfasen, Vor- und Rückwärtentgraten sowie für Konturarbeiten.

STEELS STAHL < 850 N/mm ²	STEELS STAHL > 850 N/mm ²	INOX < 850 N/mm ²	INOX > 850 N/mm ²
CAST IRON GRAUGÜß	Al	Cu, Ms	
CARBIDE VHM			
Z=4	Type Typ N	WN	

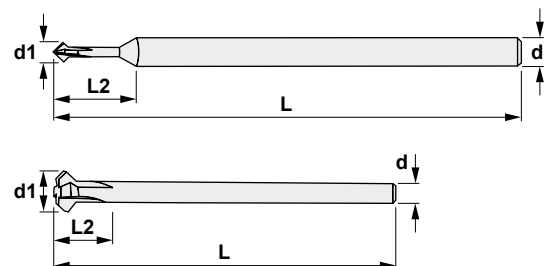

88

Reference Bezeichnung		d1	d	L2	L
88404	4	4	6	14	100
88406	4	6	6	21	100
88408	4	8	6	37	100
88410	4	10	6	38	100
88412	4	12	6	40	100



Cutting data for solid carbide (References 84, 86, 87 and 88)
Schnittdaten für Vollhartmetall (Bezeichnungen 84, 86, 87 und 88)

Diameter / Durchmesser (Ø d1) mm	Material / Materialien									
	Unalloyed steels Unlegierter Stahl <500 N/mm ²		Unalloyed steels Unlegierter Stahl 500-700 N/mm ²		Unalloyed steels Unlegierter Stahl >700 N/mm ²		Alloyed steels Legierter Stahl <1400 N/mm ²		Alloyed steels Legierter Stahl >1400 N/mm ²	
	R.P.M Min.	Feed / Vorschub mm/min.	R.P.M Min.	Feed / Vorschub mm/min.	R.P.M Min.	Feed / Vorschub mm/min.	R.P.M Min.	Feed / Vorschub mm/min.	R.P.M Min.	Feed / Vorschub mm/min.
4	11935	955	9550	570	5970	360	4775	190	3185	125
6	7955	795	6365	510	3980	240	3185	125	2120	85
8	5965	595	4775	380	2985	180	2385	95	1590	65
10	4775	670	3820	460	2385	240	1910	115	1270	75
12	3980	555	3185	380	1990	200	1590	95	1060	65
16	2985	420	2385	285	1490	150	1195	95	795	65

Diameter / Durchmesser (Ø d1) mm	Material / Materialien									
	Stainless steels Rostfreier Stahl		Cast iron Grauguß <500 N/mm ²		Cast iron Grauguß >500 N/mm ²		Cast iron Grauguß <200 N/mm ²		Cast iron Grauguß >200 N/mm ²	
	R.P.M Min.	Feed / Vorschub mm/min.	R.P.M Min.	Feed / Vorschub mm/min.	R.P.M Min.	Feed / Vorschub mm/min.	R.P.M Min.	Feed / Vorschub mm/min.	R.P.M Min.	Feed / Vorschub mm/min.
4	4060	160	8755	700	7160	430	5970	595	5170	415
6	2705	110	5835	585	4775	285	3980	475	3450	275
8	2030	80	4375	440	3580	215	2985	360	2585	205
10	1625	95	3500	420	2865	230	2385	380	2070	250
12	1355	80	2920	350	2385	190	1990	320	1725	205
16	1015	80	2190	305	1790	180	1490	270	1295	205

Diameter / Durchmesser (Ø d1) mm	Material / Materialien			
	Copper Kupfer		Aluminium alloys Aluminium-Legierungen	
	R.P.M Min.	Feed / Vorschub mm/min.	R.P.M Min.	Feed / Vorschub mm/min.
4	13925	1115	35810	3580
6	9285	740	23875	2865
8	6960	555	17905	2150
10	5570	670	14325	2865
12	4640	555	11935	2385
16	3480	555	8950	2505



Solid carbide reinforced drills.

DIN 6537K (TIALN COATING) 3xD

Diameters from 3 to 20 mm

Verstärkte VHM-Spiralbohrer

DIN 6537K (TIALN-Beschichtung) 3xD

Durchmesser von 3 bis 20 mm

Characteristics:

Especially suitable for drilling heat resistant steels, Cr-Ni steels, high carbon steel castings, grey cast iron, cast steels, manganese steels, bronze, aluminium with high percentage of silicium and other difficult-to-machine materials.

Eigenschaften:

Besonders geeignet zum Bohren von hitzebeständigen Stählen, Cr-Ni-Stählen, kohlenstoffreichen Stahlguß, Grauguß, Gußstählen, Manganstählen, Bronze, Aluminium mit einem hohen Siliziumanteil und anderen schwerzerspanbaren Werkstoffen.

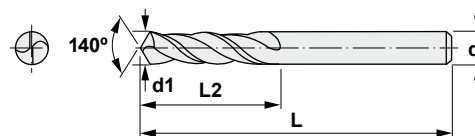
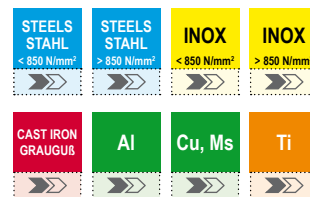

7320

Reference Bezeichnung		d1	d	L2	L
732003.0	2	3,0	6	20	62
732003.1	2	3,1	6	20	62
732003.2	2	3,2	6	20	62
732003.3	2	3,3	6	20	62
732003.4	2	3,4	6	20	62
732003.5	2	3,5	6	20	62
732003.6	2	3,6	6	20	62
732003.7	2	3,7	6	20	62
732003.8	2	3,8	6	24	66
732003.9	2	3,9	6	24	66
732004.0	2	4,0	6	24	66
732004.1	2	4,1	6	24	66
732004.2	2	4,2	6	24	66
732004.3	2	4,3	6	24	66
732004.4	2	4,4	6	24	66
732004.5	2	4,5	6	24	66
732004.6	2	4,6	6	24	66
732004.7	2	4,7	6	24	66
732004.8	2	4,8	6	28	66
732004.9	2	4,9	6	28	66
732005.0	2	5,0	6	28	66
732005.1	2	5,1	6	28	66
732005.2	2	5,2	6	28	66
732005.3	2	5,3	6	28	66



7320

Reference Bezeichnung		d1	d	L2	L
732005.4	2	5,4	6	28	66
732005.5	2	5,5	6	28	66
732005.6	2	5,6	6	28	66
732005.7	2	5,7	6	28	66
732005.8	2	5,8	6	28	66
732005.9	2	5,9	6	28	66
732006.0	2	6,0	6	28	66
732006.1	2	6,1	8	34	79
732006.2	2	6,2	8	34	79
732006.3	2	6,3	8	34	79
732006.4	2	6,4	8	34	79
732006.5	2	6,5	8	34	79
732006.6	2	6,6	8	34	79
732006.7	2	6,7	8	34	79
732006.8	2	6,8	8	34	79
732006.9	2	6,9	8	34	79
732007.0	2	7,0	8	34	79
732007.1	2	7,1	8	41	79
732007.2	2	7,2	8	41	79
732007.3	2	7,3	8	41	79
732007.4	2	7,4	8	41	79
732007.5	2	7,5	8	41	79
732007.6	2	7,6	8	41	79
732007.7	2	7,7	8	41	79
732007.8	2	7,8	8	41	79
732007.9	2	7,9	8	41	79
732008.0	2	8,0	8	41	79
732008.1	2	8,1	10	47	89
732008.2	2	8,2	10	47	89
732008.3	2	8,3	10	47	89
732008.4	2	8,4	10	47	89
732008.5	2	8,5	10	47	89
732008.6	2	8,6	10	47	89
732008.7	2	8,7	10	47	89
732008.8	2	8,8	10	47	89
732008.9	2	8,9	10	47	89
732009.0	2	9,0	10	47	89
732009.1	2	9,1	10	47	89
732009.2	2	9,2	10	47	89
732009.3	2	9,3	10	47	89
732009.4	2	9,4	10	47	89
732009.5	2	9,5	10	47	89
732009.6	2	9,6	10	47	89
732009.7	2	9,7	10	47	89
732009.8	2	9,8	10	47	89
732009.9	2	9,9	10	47	89
732010.0	2	10,0	10	47	89
732010.1	2	10,1	12	55	102
732010.2	2	10,2	12	55	102
732010.3	2	10,3	12	55	102
732010.4	2	10,4	12	55	102
732010.5	2	10,5	12	55	102
732010.6	2	10,6	12	55	102

7320

Reference Bezeichnung		d1	d	L2	L
732010.7	2	10,7	12	55	102
732010.8	2	10,8	12	55	102
732010.9	2	10,9	12	55	102
732011.0	2	11,0	12	55	102
732011.1	2	11,1	12	55	102
732011.2	2	11,2	12	55	102
732011.3	2	11,3	12	55	102
732011.4	2	11,4	12	55	102
732011.5	2	11,5	12	55	102
732011.6	2	11,6	12	55	102
732011.7	2	11,7	12	55	102
732011.8	2	11,8	12	55	102
732011.9	2	11,9	12	55	102
732012.0	2	12,0	12	55	102
732012.2	2	12,2	14	60	107
732012.5	2	12,5	14	60	107
732012.7	2	12,7	14	60	107
732012.8	2	12,8	14	60	107
732013.0	2	13,0	14	60	107
732013.1	2	13,1	14	60	107
732013.5	2	13,5	14	60	107
732013.8	2	13,8	14	60	107
732014.0	2	14,0	14	60	107
732014.5	2	14,5	16	65	115
732014.8	2	14,8	16	65	115
732016.0	2	16,0	16	65	115
732016.5	2	16,5	18	73	123
732018.0	2	18,0	18	73	123
732018.5	2	18,5	20	79	131
732020.0	2	20,0	20	79	131

**G**

7320 Solid carbide reinforced drills.
Verstärkte VHM-Spiralbohrer.

Diameter / Durchmesser (Ø d1) mm	Material / Materialien											
	Unalloyed steels Unlegierter Stahl < 700 N/mm ² Ø1.0 ~ Ø2.9 : 40 ~ 80 m/min Ø3.0 ~ : 100 m/min			Alloyed steels Legierter Stahl < 1000 N/mm ² Ø1.0 ~ Ø2.9 : 35 ~ 70 m/min Ø3.0 ~ : 75 m/min			Soft grey cast iron Weicher Grauguß < HB240, GG25 Ø1.0 ~ Ø2.9 : 60 ~ 130 m/min Ø3.0 ~ : 100 m/min			Hard grey cast iron Harter Grauguß < HB300, GG40 Ø1.0 ~ Ø2.9 : 40 ~ 90 m/min Ø3.0 ~ : 80 m/min		
	R.P.M Min.	Feed / Vorschub		R.P.M Min.	Feed / Vorschub		R.P.M Min.	Feed / Vorschub		R.P.M Min.	Feed / Vorschub	
		Min.	Max.		Min.	Max.		Min.	Max.		Min.	Max.
3	10500	0.06	0.12	7890	0.06	0.12	10500	0.06	0.12	8410	0.06	0.12
4	7920	0.08	0.16	5920	0.08	0.16	7920	0.08	0.16	6310	0.08	0.16
5	6310	0.10	0.20	4740	0.10	0.20	6310	0.10	0.20	5050	0.10	0.20
6	5270	0.12	0.24	3950	0.12	0.24	5270	0.12	0.24	4220	0.12	0.24
7	4510	0.14	0.26	3400	0.14	0.26	4510	0.14	0.26	3610	0.14	0.26
8	3950	0.16	0.28	2970	0.16	0.28	3950	0.16	0.28	3160	0.16	0.28
9	3510	0.18	0.30	2640	0.18	0.30	3510	0.18	0.30	2820	0.18	0.30
10	3160	0.20	0.30	2370	0.20	0.30	3160	0.20	0.30	2530	0.20	0.30
11	2880	0.20	0.30	2160	0.20	0.30	2880	0.20	0.30	2310	0.20	0.30
12	2640	0.21	0.30	1980	0.21	0.30	2640	0.21	0.30	2120	0.21	0.30
13	2430	0.21	0.33	1830	0.21	0.33	2430	0.21	0.33	1950	0.21	0.33
14	2260	0.22	0.35	1710	0.22	0.35	2260	0.22	0.35	1810	0.22	0.35
16	1980	0.25	0.36	1490	0.25	0.36	1980	0.25	0.36	1590	0.25	0.36
18	1760	0.28	0.38	1330	0.28	0.38	1760	0.28	0.38	1420	0.28	0.38
20	1590	0.30	0.40	1180	0.30	0.40	1590	0.30	0.40	1270	0.30	0.40





Solid carbide reinforced drills.
DIN 6537L (TIALN COATING) 5xD
Diameters from 3 to 20 mm

Verstärkte VHM-Spiralbohrer
DIN 6537L (TIALN-BESCHICHTUNG) 5XD
Durchmesser von 3 bis 20 mm

Characteristics:

Especially suitable for drilling heat resistant steels, Cr-Ni steels, high carbon steel castings, grey cast iron, cast steels, manganese steels, bronze, aluminium with high percentage of silicon and other difficult-to-machine materials.

Eigenschaften:

Besonders geeignet zum Bohren von hitzebeständigen Stählen, Cr-Ni-Stählen, kohlenstoffreichen stahlguß, Grauguß, Gußstählen, Manganstählen, Bronze, Aluminium mit einem hohen Siliziumanteil und anderen schwer zerspanbaren Werkstoffen.

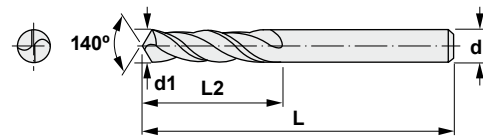

7520

Reference Bezeichnung		d1	d	L2	L
752003.0	2	3,0	6	28	66
752003.1	2	3,1	6	28	66
752003.2	2	3,2	6	28	66
752003.3	2	3,3	6	28	66
752003.4	2	3,4	6	28	66
752003.5	2	3,5	6	28	66
752003.6	2	3,6	6	28	66
752003.7	2	3,7	6	28	66
752003.8	2	3,8	6	36	74
752003.9	2	3,9	6	36	74
752004.0	2	4,0	6	36	74
752004.1	2	4,1	6	36	74
752004.2	2	4,2	6	36	74
752004.3	2	4,3	6	36	74
752004.4	2	4,4	6	36	74
752004.5	2	4,5	6	36	74
752004.6	2	4,6	6	36	74
752004.7	2	4,7	6	44	74
752004.8	2	4,8	6	44	82
752004.9	2	4,9	6	44	82
752005.0	2	5,0	6	44	82
752005.1	2	5,1	6	44	82
752005.2	2	5,2	6	44	82
752005.3	2	5,3	6	44	82



7520

Reference Bezeichnung		d1	d	L2	L
752005.4	2	5,4	6	44	82
752005.5	2	5,5	6	44	82
752005.6	2	5,6	6	44	82
752005.7	2	5,7	6	44	82
752005.8	2	5,8	6	44	82
752005.9	2	5,9	6	44	82
752006.0	2	6,0	6	44	82
752006.1	2	6,1	8	53	91
752006.2	2	6,2	8	53	91
752006.3	2	6,3	8	53	91
752006.4	2	6,4	8	53	91
752006.5	2	6,5	8	53	91
752006.6	2	6,6	8	53	91
752006.7	2	6,7	8	53	91
752006.8	2	6,8	8	53	91
752006.9	2	6,9	8	53	91
752007.0	2	7,0	8	53	91
752007.1	2	7,1	8	53	91
752007.2	2	7,2	8	53	91
752007.3	2	7,3	8	53	91
752007.4	2	7,4	8	53	91
752007.5	2	7,5	8	53	91
752007.6	2	7,6	8	53	91
752007.7	2	7,7	8	53	91
752007.8	2	7,8	8	53	91
752007.9	2	7,9	8	53	91
752008.0	2	8,0	8	53	91
752008.1	2	8,1	10	61	103
752008.2	2	8,2	10	61	103
752008.3	2	8,3	10	61	103
752008.4	2	8,4	10	61	103
752008.5	2	8,5	10	61	103
752008.6	2	8,6	10	61	103
752008.7	2	8,7	10	61	103
752008.8	2	8,8	10	61	103
752008.9	2	8,9	10	61	103
752009.0	2	9,0	10	61	103
752009.1	2	9,1	10	61	103
752009.2	2	9,2	10	61	103
752009.3	2	9,3	10	61	103
752009.4	2	9,4	10	61	103
752009.5	2	9,5	10	61	103
752009.6	2	9,6	10	61	103
752009.7	2	9,7	10	61	103
752009.8	2	9,8	10	61	103
752009.9	2	9,9	10	61	103
752010.0	2	10,0	10	61	103
752010.1	2	10,1	10	61	103
752010.2	2	10,2	12	71	118
752010.3	2	10,3	12	71	118
752010.4	2	10,4	12	71	118
752010.5	2	10,5	12	71	118

7520

Reference Bezeichnung		d1	d	L2	L
752010.6	2	10,6	12	71	118
752010.7	2	10,7	12	71	118
752010.8	2	10,8	12	71	118
752010.9	2	10,9	12	71	118
752011.0	2	11,0	12	71	118
752011.1	2	11,1	12	71	118
752011.2	2	11,2	12	71	118
752011.3	2	11,3	12	71	118
752011.4	2	11,4	12	71	118
752011.5	2	11,5	12	71	118
752011.6	2	11,6	12	71	118
752011.7	2	11,7	12	71	118
752011.8	2	11,8	12	71	118
752011.9	2	11,9	12	71	118
752012.0	2	12,0	12	71	118
752012.2	2	12,2	14	77	124
752012.5	2	12,5	14	77	124
752012.7	2	12,7	14	77	124
752012.8	2	12,8	14	77	124
752013.0	2	13,0	14	77	124
752013.1	2	13,1	14	77	124
752013.5	2	13,5	14	77	124
752013.8	2	13,8	14	77	124
752014.0	2	14,0	14	77	124
752014.5	2	14,5	16	83	133
752014.8	2	14,8	16	83	133
752016.0	2	16,0	16	83	133
752016.5	2	16,5	18	93	143
752018.0	2	18,0	18	93	143
752018.5	2	18,5	20	101	153
752020.0	2	20,0	20	101	153

**G**

7520 Solid carbide reinforced drills.
Verstärkte VHM-Spiralbohrer.

Diameter / Durchmesser (Ø d1) mm	Material / Materialien											
	Unalloyed steels Unlegierter Stahl < 700 N/mm ² Ø1.0 ~ Ø2.9 : 40 ~ 80 m/min Ø3.0 ~ : 100 m/min			Alloyed steels Legierter Stahl < 1000 N/mm ² Ø1.0 ~ Ø2.9 : 35 ~ 70 m/min Ø3.0 ~ : 75 m/min			Soft grey cast iron Weicher Grauguß < HB240, GG25 Ø1.0 ~ Ø2.9 : 60 ~ 130 m/min Ø3.0 ~ : 100 m/min			Hard grey cast iron Harter Grauguß < HB300, GG40 Ø1.0 ~ Ø2.9 : 40 ~ 90 m/min Ø3.0 ~ : 80 m/min		
	R.P.M Min.	Feed / Vorschub		R.P.M Min.	Feed / Vorschub		R.P.M Min.	Feed / Vorschub		R.P.M Min.	Feed / Vorschub	
		Min.	Max.		Min.	Max.		Min.	Max.		Min.	Max.
3	10500	0.06	0.12	7890	0.06	0.12	10500	0.06	0.12	8410	0.06	0.12
4	7920	0.08	0.16	5920	0.08	0.16	7920	0.08	0.16	6310	0.08	0.16
5	6310	0.10	0.20	4740	0.10	0.20	6310	0.10	0.20	5050	0.10	0.20
6	5270	0.12	0.24	3950	0.12	0.24	5270	0.12	0.24	4220	0.12	0.24
7	4510	0.14	0.26	3400	0.14	0.26	4510	0.14	0.26	3610	0.14	0.26
8	3950	0.16	0.28	2970	0.16	0.28	3950	0.16	0.28	3160	0.16	0.28
9	3510	0.18	0.30	2640	0.18	0.30	3510	0.18	0.30	2820	0.18	0.30
10	3160	0.20	0.30	2370	0.20	0.30	3160	0.20	0.30	2530	0.20	0.30
11	2880	0.20	0.30	2160	0.20	0.30	2880	0.20	0.30	2310	0.20	0.30
12	2640	0.21	0.30	1980	0.21	0.30	2640	0.21	0.30	2120	0.21	0.30
13	2430	0.21	0.33	1830	0.21	0.33	2430	0.21	0.33	1950	0.21	0.33
14	2260	0.22	0.35	1710	0.22	0.35	2260	0.22	0.35	1810	0.22	0.35
16	1980	0.25	0.36	1490	0.25	0.36	1980	0.25	0.36	1590	0.25	0.36
18	1760	0.28	0.38	1330	0.28	0.38	1760	0.28	0.38	1420	0.28	0.38
20	1590	0.30	0.40	1180	0.30	0.40	1590	0.30	0.40	1270	0.30	0.40





Solid carbide reinforced drills.
DIN 6537L (TIALN COATING) 3xD
WITH COOLANT SYSTEM
Diameters from 3 to 20 mm

Verstärkte VHM-Spiralbohrer
DIN 6537L (TIALN BESCHICHTUNG) 3xD
MIT KÜHLMITTELZUFUHR
Durchmesser von 3 bis 20 mm

Characteristics:

Solid carbide high performance drill with internal coolant supply for universal applications. High stability as well as universal usability due to the straight main cutting edge. The special point shape effects optimum chip breakage, high centering accuracy and less cutting forces.

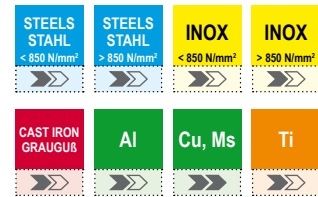

Eigenschaften:

VHM-Hochleistungsbohrer mit Innen-Kühlmittelezufuhr für universelle Anwendungen. Hohe Stabilität und universelle Einsetzbarkeit durch die gerade Hauptschneidkante. Der Spezialanschliff bewirkt einen optimalen Spanbruch, eine hohe Zentriergenauigkeit und geringe Schnittkräfte.

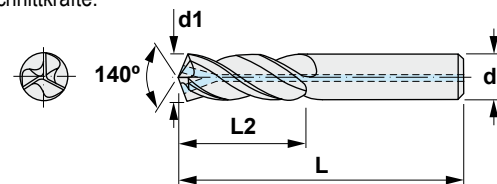
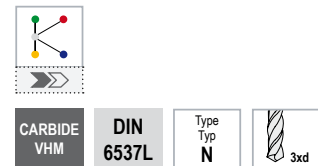



7323

Reference Bezeichnung		d1	d	L2	L
732303.0	2	3,0	6	28	66
732303.1	2	3,1	6	28	66
732303.2	2	3,2	6	28	66
732303.3	2	3,3	6	28	66
732303.4	2	3,4	6	28	66
732303.5	2	3,5	6	28	66
732303.6	2	3,6	6	28	66
732303.7	2	3,7	6	28	66
732303.8	2	3,8	6	36	74
732303.9	2	3,9	6	36	74
732304.0	2	4,0	6	36	74
732304.1	2	4,1	6	36	74
732304.2	2	4,2	6	36	74
732304.3	2	4,3	6	36	74
732304.4	2	4,4	6	36	74
732304.5	2	4,5	6	36	74
732304.6	2	4,6	6	36	74
732304.7	2	4,7	6	44	74
732304.8	2	4,8	6	44	82
732304.9	2	4,9	6	44	82
732305.0	2	5,0	6	44	82



7323 

Reference Bezeichnung		d1	d	L2	L
732305.1	2	5,1	6	44	82
732305.2	2	5,2	6	44	82
732305.3	2	5,3	6	44	82
732305.4	2	5,4	6	44	82
732305.5	2	5,5	6	44	82
732305.6	2	5,6	6	44	82
732305.7	2	5,7	6	44	82
732305.8	2	5,8	6	44	82
732305.9	2	5,9	6	44	82
732306.0	2	6,0	6	44	82
732306.1	2	6,1	8	53	91
732306.2	2	6,2	8	53	91
732306.3	2	6,3	8	53	91
732306.4	2	6,4	8	53	91
732306.5	2	6,5	8	53	91
732306.6	2	6,6	8	53	91
732306.7	2	6,7	8	53	91
732306.8	2	6,8	8	53	91
732306.9	2	6,9	8	53	91
732307.0	2	7,0	8	53	91
732307.1	2	7,1	8	53	91
732307.2	2	7,2	8	53	91
732307.3	2	7,3	8	53	91
732307.4	2	7,4	8	53	91
732307.5	2	7,5	8	53	91
732307.6	2	7,6	8	53	91
732307.7	2	7,7	8	53	91
732307.8	2	7,8	8	53	91
732307.9	2	7,9	8	53	91
732308.0	2	8,0	8	53	91
732308.1	2	8,1	10	61	103
732308.2	2	8,2	10	61	103
732308.3	2	8,3	10	61	103
732308.4	2	8,4	10	61	103
732308.5	2	8,5	10	61	103
732308.6	2	8,6	10	61	103
732308.7	2	8,7	10	61	103
732308.8	2	8,8	10	61	103
732308.9	2	8,9	10	61	103
732309.0	2	9,0	10	61	103
732309.1	2	9,1	10	61	103
732309.2	2	9,2	10	61	103
732309.3	2	9,3	10	61	103
732309.4	2	9,4	10	61	103
732309.5	2	9,5	10	61	103
732309.6	2	9,6	10	61	103
732309.7	2	9,7	10	61	103
732309.8	2	9,8	10	61	103
732309.9	2	9,9	10	61	103
732310.0	2	10,0	10	61	103
732310.1	2	10,1	10	61	103
732310.2	2	10,2	12	71	118

7323 

Reference Bezeichnung		d1	d	L2	L
732310.3	2	10,30	12	71	118
732310.4	2	10,40	12	71	118
732310.5	2	10,50	12	71	118
732310.6	2	10,60	12	71	118
732310.7	2	10,70	12	71	118
732310.8	2	10,80	12	71	118
732310.9	2	10,90	12	71	118
732311.0	2	11,00	12	71	118
732311.1	2	11,10	12	71	118
732311.2	2	11,20	12	71	118
732311.3	2	11,30	12	71	118
732311.4	2	11,40	12	71	118
732311.5	2	11,50	12	71	118
732311.6	2	11,60	12	71	118
732311.7	2	11,70	12	71	118
732311.8	2	11,80	12	71	118
732311.9	2	11,90	12	71	118
732312.0	2	12,00	12	71	118
732312.25	2	12,25	14	77	124
732312.5	2	12,50	14	77	124
732313.8	2	13,80	14	77	124
732314.0	2	14,00	14	77	124
732314.5	2	14,50	16	83	133
732314.8	2	14,80	16	83	133
732316.0	2	16,00	16	83	133
732316.5	2	16,50	18	93	143
732318.0	2	18,00	18	93	143
732318.5	2	18,50	20	101	153
732320.0	2	20,00	20	101	153

**G**

7323 Solid carbide reinforced drills.
Verstärkte VHM-Spiralbohrer.

Diameter / Durchmesser (Ø d1) mm	Material / Materialien											
	Unalloyed steels Unlegierter Stahl < 700 N/mm ² Ø1.0 ~ Ø2.9 : 50 ~ 100 m/min Ø3.0 ~ : 110 m/min			Alloyed steels Legierter Stahl < 1000 N/mm ² Ø1.0 ~ Ø2.9 : 40 ~ 90 m/min Ø3.0 ~ : 83 m/min			Soft grey cast iron Weicher Grauguß < HB240, GG25 Ø1.0 ~ Ø2.9 : 80 ~ 160 m/min Ø3.0 ~ : 110 m/min			Hard grey cast iron Harter Grauguß < HB300, GG40 Ø1.0 ~ Ø2.9 : 50 ~ 100 m/min Ø3.0 ~ : 88 m/min		
	R.P.M Min.	Feed / Vorschub		R.P.M Min.	Feed / Vorschub		R.P.M Min.	Feed / Vorschub		R.P.M Min.	Feed / Vorschub	
		Min.	Max.		Min.	Max.		Min.	Max.		Min.	Max.
3	11660	0.06	0.12	8760	0.06	0.12	11660	0.06	0.12	9340	0.06	0.12
4	8800	0.08	0.16	6570	0.08	0.16	8800	0.08	0.16	7010	0.08	0.16
5	7010	0.10	0.20	5260	0.10	0.20	7010	0.10	0.20	5610	0.10	0.20
6	5850	0.12	0.24	4380	0.12	0.24	5850	0.12	0.24	4680	0.12	0.24
7	5010	0.14	0.26	3770	0.14	0.26	5010	0.14	0.26	4010	0.14	0.26
8	4380	0.16	0.28	2390	0.16	0.28	4380	0.16	0.28	3510	0.16	0.28
9	3900	0.18	0.30	2930	0.18	0.30	3900	0.18	0.30	3130	0.18	0.30
10	3510	0.20	0.30	2630	0.20	0.30	3510	0.20	0.30	2810	0.20	0.30
11	3190	0.20	0.30	2400	0.20	0.30	3190	0.20	0.30	2560	0.20	0.30
12	2930	0.21	0.30	2200	0.21	0.30	2930	0.21	0.30	2350	0.21	0.30
13	2700	0.21	0.33	2030	0.21	0.33	2700	0.21	0.33	2160	0.21	0.33
14	2510	0.22	0.35	1890	0.22	0.35	2510	0.22	0.35	2010	0.22	0.35
16	2190	0.25	0.36	1650	0.25	0.36	2190	0.25	0.36	1760	0.25	0.36
18	1950	0.28	0.38	1470	0.28	0.38	1950	0.28	0.38	1570	0.28	0.38
20	1760	0.30	0.40	1310	0.30	0.40	1760	0.30	0.40	1410	0.30	0.40





Solid carbide reinforced drills.
DIN 6537L (TIALN COATING) 5xD
WITH COOLANT SYSTEM

Diameters from 3 to 20 mm

Verstärkte VHM-Spiralbohrer
DIN 6537L (TIALN BESCHICHTUNG) 5xD
MIT KÜHLMITTELZUFUHR

Durchmesser von 3 bis 20 mm

Characteristics:

Solid carbide high performance drill with internal coolant supply for universal applications. High stability as well as universal usability due to the straight main cutting edge. The special point shape effects optimum chip breakage, high centering accuracy and less cutting forces.



Eigenschaften:

VHM-Hochleistungsbohrer mit Innen-Kühlmittelzufuhr für universelle Anwendungen. Hohe Stabilität und universelle Einsetzbarkeit durch die gerade Hauptschneidkante. Der Spezialanschliff bewirkt einen optimalen Spanbruch, eine hohe Zentriergenauigkeit und geringe Schnittkräfte.

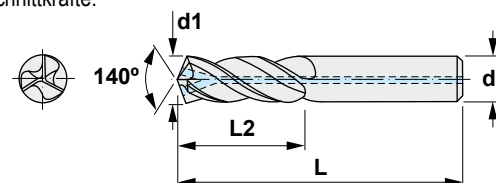

7523

Reference Bezeichnung		d1	d	L2	L
752303.0	2	3,0	6	28	66
752303.1	2	3,1	6	28	66
752303.2	2	3,2	6	28	66
752303.3	2	3,3	6	28	66
752303.4	2	3,4	6	28	66
752303.5	2	3,5	6	28	66
752303.6	2	3,6	6	28	66
752303.7	2	3,7	6	28	66
752303.8	2	3,8	6	36	74
752303.9	2	3,9	6	36	74
752304.0	2	4,0	6	36	74
752304.1	2	4,1	6	36	74
752304.2	2	4,2	6	36	74
752304.3	2	4,3	6	36	74
752304.4	2	4,4	6	36	74
752304.5	2	4,5	6	36	74
752304.6	2	4,6	6	36	74
752304.7	2	4,7	6	44	74
752304.8	2	4,8	6	44	82
752304.9	2	4,9	6	44	82
752305.0	2	5,0	6	44	82



7523 

Reference Bezeichnung		d1	d	L2	L
752305.1	2	5,1	6	44	82
752305.2	2	5,2	6	44	82
752305.3	2	5,3	6	44	82
752305.4	2	5,4	6	44	82
752305.5	2	5,5	6	44	82
752305.6	2	5,6	6	44	82
752305.7	2	5,7	6	44	82
752305.8	2	5,8	6	44	82
752305.9	2	5,9	6	44	82
752306.0	2	6,0	6	44	82
752306.1	2	6,1	8	53	91
752306.2	2	6,2	8	53	91
752306.3	2	6,3	8	53	91
752306.4	2	6,4	8	53	91
752306.5	2	6,5	8	53	91
752306.6	2	6,6	8	53	91
752306.7	2	6,7	8	53	91
752306.8	2	6,8	8	53	91
752306.9	2	6,9	8	53	91
752307.0	2	7,0	8	53	91
752307.1	2	7,1	8	53	91
752307.2	2	7,2	8	53	91
752307.3	2	7,3	8	53	91
752307.4	2	7,4	8	53	91
752307.5	2	7,5	8	53	91
752307.6	2	7,6	8	53	91
752307.7	2	7,7	8	53	91
752307.8	2	7,8	8	53	91
752307.9	2	7,9	8	53	91
752308.0	2	8,0	8	53	91
752308.1	2	8,1	10	61	103
752308.2	2	8,2	10	61	103
752308.3	2	8,3	10	61	103
752308.4	2	8,4	10	61	103
752308.5	2	8,5	10	61	103
752308.6	2	8,6	10	61	103
752308.7	2	8,7	10	61	103
752308.8	2	8,8	10	61	103
752308.9	2	8,9	10	61	103
752309.0	2	9,0	10	61	103
752309.1	2	9,1	10	61	103
752309.2	2	9,2	10	61	103
752309.3	2	9,3	10	61	103
752309.4	2	9,4	10	61	103
752309.5	2	9,5	10	61	103
752309.6	2	9,6	10	61	103
752309.7	2	9,7	10	61	103
752309.8	2	9,8	10	61	103
752309.9	2	9,9	10	61	103
752310.0	2	10,0	10	61	103
752310.1	2	10,1	10	61	103
752310.2	2	10,2	12	71	118

7523 

Reference Bezeichnung		d1	d	L2	L
752310.3	2	10,30	12	71	118
752310.4	2	10,40	12	71	118
752310.5	2	10,50	12	71	118
752310.6	2	10,60	12	71	118
752310.7	2	10,70	12	71	118
752310.8	2	10,80	12	71	118
752310.9	2	10,90	12	71	118
752311.0	2	11,00	12	71	118
752311.1	2	11,10	12	71	118
752311.2	2	11,20	12	71	118
752311.3	2	11,30	12	71	118
752311.4	2	11,40	12	71	118
752311.5	2	11,50	12	71	118
752311.6	2	11,60	12	71	118
752311.7	2	11,70	12	71	118
752311.8	2	11,80	12	71	118
752311.9	2	11,90	12	71	118
752312.0	2	12,00	12	71	118
752312.25	2	12,25	14	77	124
752312.5	2	12,50	14	77	124
752313.8	2	13,80	14	77	124
752314.0	2	14,00	14	77	124
752314.5	2	14,50	16	83	133
752314.8	2	14,80	16	83	133
752316.0	2	16,00	16	83	133
752316.5	2	16,50	18	93	143
752318.0	2	18,00	18	93	143
752318.5	2	18,50	20	101	153
752320.0	2	20,00	20	101	153

**G**

7523 Solid carbide reinforced drills. Verstärkte VHM-Spiralbohrer.

Diameter / Durchmesser (Ø d1) mm	Material / Materialien											
	Unalloyed steels Unlegierter Stahl < 700 N/mm ² Ø1.0 ~ Ø2.9 : 50 ~ 100 m/min Ø3.0 ~ : 110 m/min			Alloyed steels Legierter Stahl < 1000 N/mm ² Ø1.0 ~ Ø2.9 : 40 ~ 90 m/min Ø3.0 ~ : 83 m/min			Soft grey cast iron Weicher Grauguß < HB240, GG25 Ø1.0 ~ Ø2.9 : 80 ~ 160 m/min Ø3.0 ~ : 110 m/min			Hard grey cast iron Harter Grauguß < HB300, GG40 Ø1.0 ~ Ø2.9 : 50 ~ 100 m/min Ø3.0 ~ : 88 m/min		
	R.P.M Min.	Feed / Vorschub		R.P.M Min.	Feed / Vorschub		R.P.M Min.	Feed / Vorschub		R.P.M Min.	Feed / Vorschub	
		Min.	Max.		Min.	Max.		Min.	Max.		Min.	Max.
3	11660	0.06	0.12	8760	0.06	0.12	11660	0.06	0.12	9340	0.06	0.12
4	8800	0.08	0.16	6570	0.08	0.16	8800	0.08	0.16	7010	0.08	0.16
5	7010	0.10	0.20	5260	0.10	0.20	7010	0.10	0.20	5610	0.10	0.20
6	5850	0.12	0.24	4380	0.12	0.24	5850	0.12	0.24	4680	0.12	0.24
7	5010	0.14	0.26	3770	0.14	0.26	5010	0.14	0.26	4010	0.14	0.26
8	4380	0.16	0.28	2390	0.16	0.28	4380	0.16	0.28	3510	0.16	0.28
9	3900	0.18	0.30	2930	0.18	0.30	3900	0.18	0.30	3130	0.18	0.30
10	3510	0.20	0.30	2630	0.20	0.30	3510	0.20	0.30	2810	0.20	0.30
11	3190	0.20	0.30	2400	0.20	0.30	3190	0.20	0.30	2560	0.20	0.30
12	2930	0.21	0.30	2200	0.21	0.30	2930	0.21	0.30	2350	0.21	0.30
13	2700	0.21	0.33	2030	0.21	0.33	2700	0.21	0.33	2160	0.21	0.33
14	2510	0.22	0.35	1890	0.22	0.35	2510	0.22	0.35	2010	0.22	0.35
16	2190	0.25	0.36	1650	0.25	0.36	2190	0.25	0.36	1760	0.25	0.36
18	1950	0.28	0.38	1470	0.28	0.38	1950	0.28	0.38	1570	0.28	0.38
20	1760	0.30	0.40	1310	0.30	0.40	1760	0.30	0.40	1410	0.30	0.40



Characteristics:
900: Cylindrical - Straight.
901: Cylindrical - Crossed.

Eigenschaften:
900: Zylinder-Form - Gerade Zahnung.
901: Zylinder-Form - Wechselzahnung.

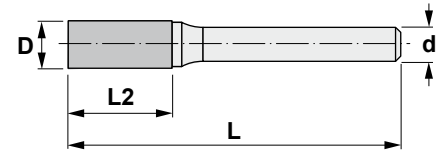

- i** Availability / Verfügbarkeit
- Standard item / Standard-Artikel
 - Check availability / Verfügbarkeit prüfen

900 - 901

Reference Bezeichnung	D	d	L	L2	K10
90003	3	3	38	14	●
90006	6	3	43	13	●
90008	8	6	65	20	●
90010	10	6	65	20	●
90012	12	6	70	25	●
90016	16	6	70	25	●
90106	6	3	43	13	●
90108	8	6	65	20	●
90110	10	6	65	20	●
90112	12	6	70	25	●
90116	16	6	70	25	●



Characteristics:
910: Cylindrical round top - Straight.
911: Cylindrical round top - Crossed.

Eigenschaften:
910: Kugelschaft-Zylinderform - Gerade Zahnung.
911: Kugelschaft-Zylinderform - Wechselzahnung.

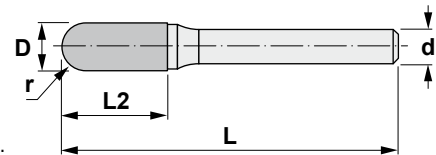

- i** Availability / Verfügbarkeit
- Standard item / Standard-Artikel
 - Check availability / Verfügbarkeit prüfen

910 - 911

Reference Bezeichnung	D	d	L	L2	r	K10
91003	3	3	38	14	1,5	●
91006	6	3	43	14	3,0	●
91008	8	6	65	20	4,0	●
91010	10	6	65	20	5,0	●
91012	12	6	70	25	6,0	●
91016	16	6	70	25	8,0	●
91106	6	3	43	14	3,0	●
91108	8	6	65	20	4,0	●
91110	10	6	65	20	5,0	●
91112	12	6	70	25	6,0	●
91116	16	6	70	25	8,0	●





Characteristics:

920: Tree radius nose - Straight.
921: Tree radius nose - Crossed.

Eigenschaften:

920: Rundkegel-Form - Gerade Zahnung.
921: Rundkegel-Form - Wechselzahnung.

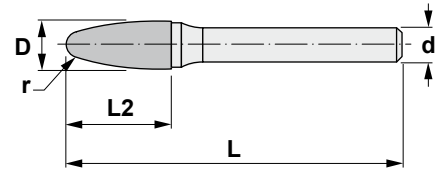

- i** Availability / Verfügbarkeit
- Standard item / Standard-Artikel
 - Check availability / Verfügbarkeit prüfen

920 - 921

Reference Bezeichnung	D	d	L	L2	r	K10
92003	3	3	38	12	0,8	●
92006	6	3	43	13	1,5	●
92008	8	6	63	18	2,0	●
92010	10	6	65	20	2,5	●
92012	12	6	70	25	3,0	●
92016	16	6	75	30	5,0	●
92106	6	3	43	13	1,5	●
92108	8	6	63	18	2,0	●
92110	10	6	65	20	2,5	●
92112	12	6	70	25	3,0	●
92116	16	6	75	30	5,0	●



Characteristics:

930: Cylindrical round top - Straight.
931: Cylindrical round top - Crossed.

Eigenschaften:

930: Spitzbogen-Form - Gerade Zahnung.
931: Spitzbogen-Form - Wechselzahnung.

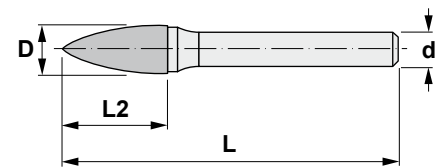

- i** Availability / Verfügbarkeit
- Standard item / Standard-Artikel
 - Check availability / Verfügbarkeit prüfen

930 - 931

Reference Bezeichnung	D	d	L	L2	K10
93003	3	3	38	12	●
93006	6	3	43	13	●
93008	8	6	65	20	●
93010	10	6	65	20	●
93012	12	6	70	25	●
93016	16	6	75	30	●
93106	6	3	43	13	●
93108	8	6	65	20	●
93110	10	6	65	20	●
93112	12	6	70	25	●
93116	16	8	75	30	●



Characteristics:

940: Cone - Straight.
941: Cone - Crossed.

Eigenschaften:

940: Spitzkegel-Form - Gerade Zahnung.
941: Spitzkegel-Form - Wechselzahnung.

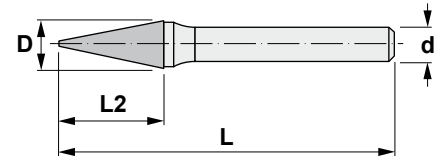

- i** Availability / Verfügbarkeit
- Standard item / Standard-Artikel
 - Check availability / Verfügbarkeit prüfen

940 - 941

Reference Bezeichnung	D	d	L	L2	K10
94003	3	3	50	12	●
94006	6	3	43	13	●
94008	8	6	63	18	●
94010	10	6	66	20	●
94012	12	6	70	25	●
94016	16	6	70	25	●
94106	6	3	43	13	●
94108	8	6	63	18	●
94110	10	6	66	20	●
94112	12	6	70	25	●
94116	16	6	70	25	●



Characteristics:

950: Olive (Egg) - Straight.
951: Olive (Egg) - Crossed.

Eigenschaften:

950: Tropfen-Form - Gerade Zahnung.
951: Tropfen-Form - Wechselzahnung.

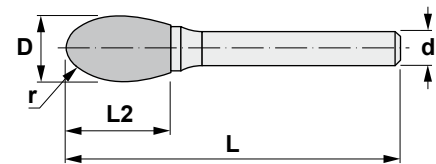

- i** Availability / Verfügbarkeit
- Standard item / Standard-Artikel
 - Check availability / Verfügbarkeit prüfen

950 - 951

Reference Bezeichnung	D	d	L	L2	r	K10
95003	3	3	38	6	1,2	●
95006	6	3	40	10	2,5	●
95008	8	6	58	13	3,7	●
95010	10	6	61	16	4,0	●
95012	12	6	65	20	5,0	●
95016	16	6	70	25	6,5	●
95106	6	3	40	10	2,5	●
95108	8	6	58	13	3,7	●
95110	10	6	61	16	4,0	●
95112	12	6	65	20	5,0	●
95116	16	6	70	25	6,5	●





Characteristics:
960: Ball - Straight.
961: Ball - Crossed.

Eigenschaften:
960: Kugel-Form - Gerade Zahnung.
961: Kugel-Form - Wechselzahnung.

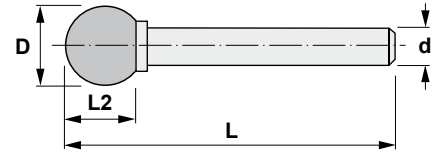

- i** Availability / Verfügbarkeit
- Standard item / Standard-Artikel
 - Check availability / Verfügbarkeit prüfen

960 - 961

Reference Bezeichnung	D	d	L	L2	K10
96003	3	3	38	2,5	●
96006	6	3	35	5,0	●
96008	8	6	52	7,0	●
96010	10	6	54	9,0	●
96012	12	6	55	10,0	●
96016	16	8	59	14,0	●
96106	6	3	35	5,0	●
96108	8	6	52	7,0	●
96110	10	6	54	9,0	●
96112	12	6	55	10,0	●
96116	16	6	59	14,0	●



Characteristics:
970: Inverted cone - Straight.
971: Inverted cone - Crossed.

Eigenschaften:
970: Winkel-Form - Gerade Zahnung.
971: Winkel-Form - Wechselzahnung.

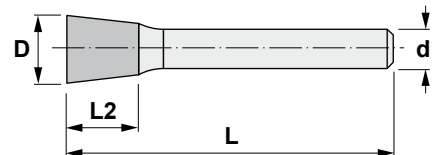

- i** Availability / Verfügbarkeit
- Standard item / Standard-Artikel
 - Check availability / Verfügbarkeit prüfen

970 - 971

Reference Bezeichnung	D	d	L	L2	K10
97003	3	3	38	3	●
97006	6	3	36	6	●
97008	8	6	53	8	●
97012	12	6	57	12	●
97106	6	3	36	6	●
97108	8	6	53	8	●
97110	10	6	55	10	●
97112	12	6	57	12	●



Characteristics:
Deburring 60°.

Eigenschaften:
Spitzkegel-Form 60°.

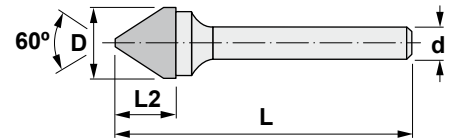

- i** Availability / Verfügbarkeit
- Standard item / Standard-Artikel
 - Check availability / Verfügbarkeit prüfen

98

Reference Bezeichnung	D	d	L	L2	K10
98006	6	6	50	6	●
98010	10	6	55	10	●
98012	12	6	57	12	●
98016	16	6	61	16	●



Characteristics:
Deburring 90°.

Eigenschaften:
Spitzkegel-Form 90°.

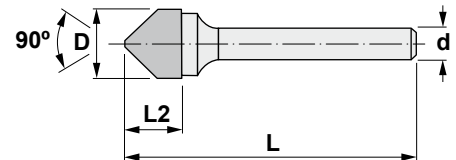

- i** Availability / Verfügbarkeit
- Standard item / Standard-Artikel
 - Check availability / Verfügbarkeit prüfen

99

Reference Bezeichnung	D	d	L	L2	K10
99006	6	6	50	6	●
99008	8	6	53	8	●
99010	10	6	55	10	●
99012	12	6	57	12	●
99016	16	6	61	16	●



Cutting data for tungsten carbide burrs

Material	Condition	HB	Kind of teeth		Cutting speed m/min
			Straight cut	Crossed cut	
Unalloyed steel	C<0,25% C<1<0,80% C,40%	110-310	● ● ●	● ● ●	800-1200 800-1200 800-1200
Low alloyed steel	Annealed Hardened	125-225 220-450	●	● ●	700-1000 600-800
High alloyed steel	Annealed Hardened	150-250 250-500	●	● ●	600-800 600-800
High alloyed steel	Annealed high speed steel (HSS) Hardened tool steel	150-250 250-350	●	● ●	600-800 600-800
Stainless steel	Ferritic-martensitic	150-270	●	●	600-800
Steel casting	Unalloyed Low alloyed High alloyed	150-250	● ● ●	● ● ●	600-800 600-800 600-800
Stainless steel	Austenitic	150-270	●	●	600-800
Stainless steel castings	Ferritic-martensitic Austenitic Manganese steel	200 200 250	● ● ●	● ● ●	400 300 160
Malleable cast iron	Ferritic - short chip Pearlitic - long chip	110-145 200-230	● ●	● ●	750 650
Grey cast iron	High traction resistant Low traction resistant	180 260	● ●	● ●	950 700
Nodular cast iron	Ferritic Pearlitic	160 250	● ●	● ●	650 550
Shell cast iron		400	●	●	160

Practical advice

- The indicated data are recommended for manual applications with a strength of 5-25N.
- Increase the cutting speed for light deburring.
- For heavy operations, for instance by a robot, the cutting speed must be reduced.



Straight cutting flutes burrs

- Best surface finishing.
- Maximum chip removal in soft materials.
- Excellent tool life.
- Produce needle chips.



Crossed cutting flutes burrs

- Allow a lower spindle speed.
- Smoother operation, even at low speeds.
- High chip removal in hard and soft materials.
- Produce short and rounded chips.

Type 90



Surfaces and smooth edges

Type 91



Radius and surfaces

Type 92



General shapes

Type 93



Curved shapes with narrow spaces

Type 94

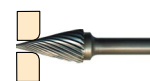

Narrow spaces

Type 95

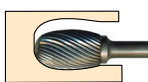

Complicated shapes

Type 96

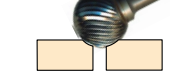

Welded shapes and holes in curved surfaces

Type 97

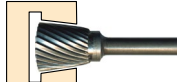

Inverted cone shape

Type 98

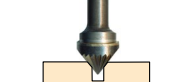

30° Degrees chamfering

Type 99

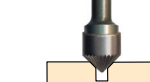

45° Degrees chamfering

Schnittbedingungen für Rotierfräser

Materialien	Beschaffenheit	HB	Zahnungsart		Schnittgeschwindigkeit m/min
			Gerade Zahnung	Wechselzahnung	
Unlegierter Stahl	C<0,25% C<1<0,80% C,40%	110-310	● ● ●	● ● ●	800-1200 800-1200 800-1200
Niedrig legierter Stahl	Geglüht Abgeschreckt	125-225 220-450	●	● ●	700-1000 600-800
Hochlegierter Stahl	Geglüht Abgeschreckt	150-250 250-500	●	● ●	600-800 600-800
Hochlegierter Stahl	Geglühter HSS Abgeschreckter Werkzeugstahl	150-250 250-350	●	● ●	600-800 600-800
Rostfreier Stahl	Ferritisch/Martensitisch	150-270	●	●	600-800
Stahlguß	Unlegiert Niedrig legiert Hochlegiert	150-250	● ● ●	● ● ●	600-800 600-800 600-800
Rostfreier Stahl	Austenitisch	150-270	●	●	600-800
Rostfreier Stahlguß	Ferritisch-Martensitisch Austenitisch Mangan-Stahl	200 200 250	● ● ●	● ● ●	400 300 160
Temperguß	Ferritisch – kurzspanend Perlitisch – langspanend	110-145 200-230	● ●	● ●	750 650
Grauguß	Hohe Zugfestigkeit Niedrige Zugfestigkeit	180 260	● ●	● ●	950 700
Kugelgraphitguß	Ferritisch Perlitisch	160 250	● ●	● ●	650 550
Kokillenguß		400	●	●	160

Praktische Empfehlungen

- Die angegebenen Bedingungen sind für manuelle Anwendungen mit einer Kraft von 5-25 N empfohlen.

- Für leichtes Entgraten, die Schnittgeschwindigkeit erhöhen.

- Für schwere Operationen, z.B. mit einem Roboter, muss die Schnittgeschwindigkeit reduziert werden.

Rotierfräser mit gerader Zahnung

- Optimale Oberflächengüte.
- Maximale Spanabfuhr in weiche Materialien.
- Ausgezeichnete Standzeit.
- Sie produzieren nagelförmige Späne.



Rotierfräser mit Wechselzahnung

- Sie erlauben eine niedrigere Drehzahl.
- Weichere Operationen auch bei langsamer Drehzahl.
- Hohe Spanabfuhr in harte und weiche Materialien.
- Sie produzieren kurze und runde Späne.



Typ 90



Für Oberflächen und glatte Kanten

Typ 91



Für Radius und Oberflächen

Typ 92



Für allgemeine Formen

Typ 93

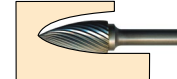

Für gebogene Formen in schmalen Konturen

Typ 94

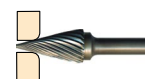

Für schmale Konturen

Typ 95

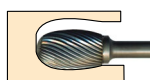

Für komplizierte Formen

Typ 96

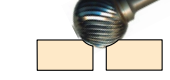

Für geschweißte Formen und für Bohrungen in gebogenen Oberflächen

Typ 97

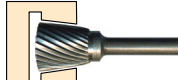

Winkelform

Typ 98

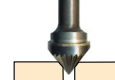

30° Grad Anfasen

Typ 99

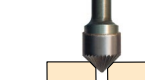

45° Grad Anfasen

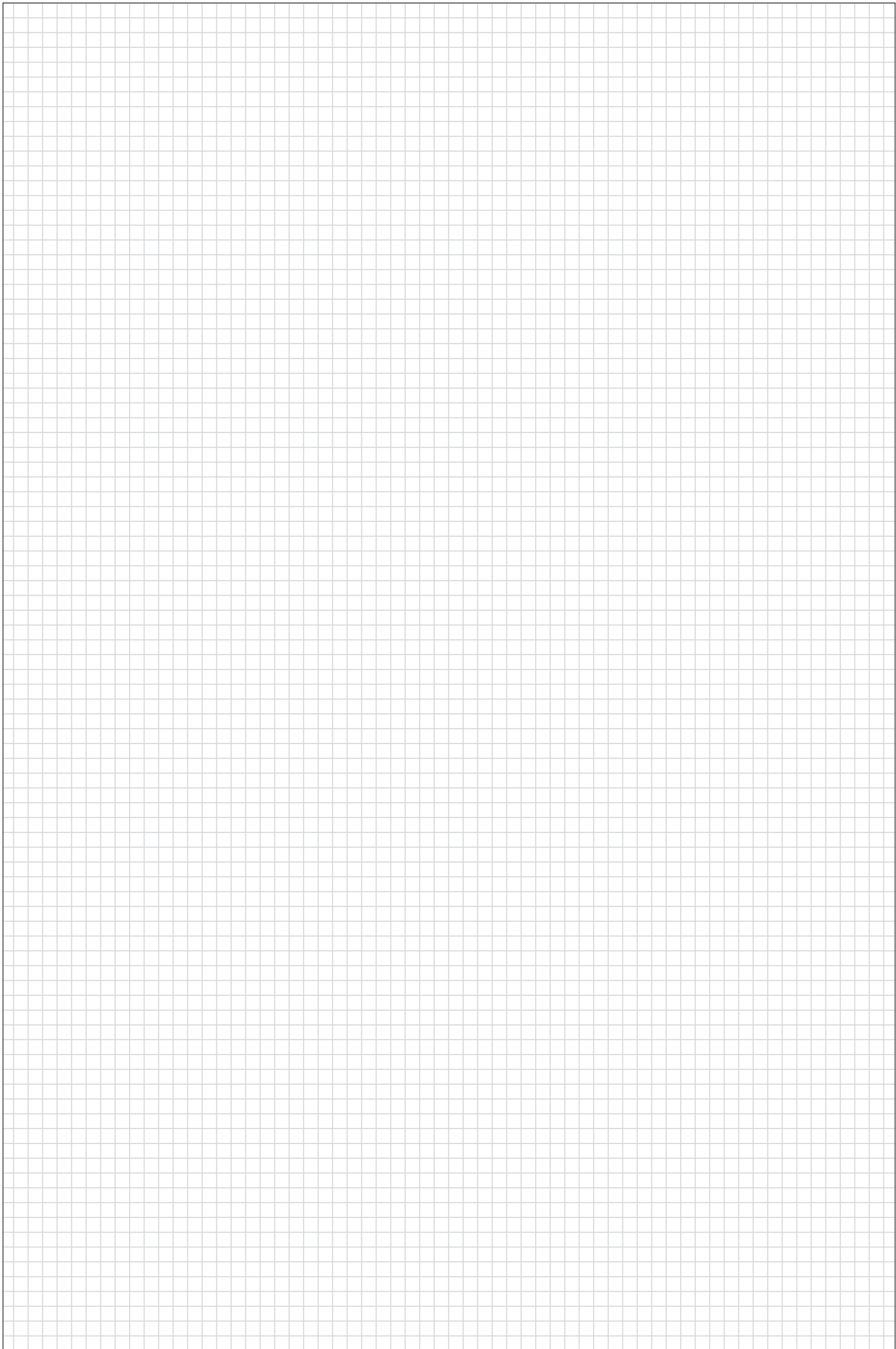

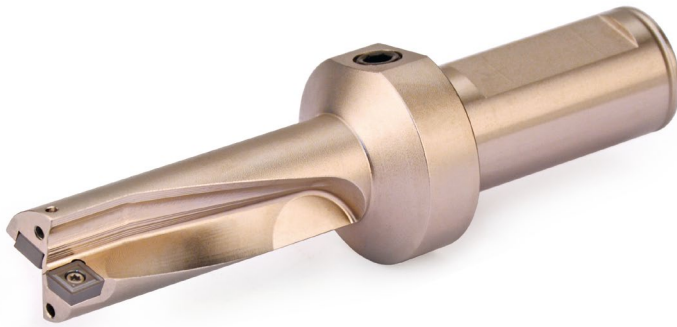

DRILLS BOHRER

Inserts for drills Wendeschneidplatten für Bohrer	H02
Code system Kodifizierung	H03
Applications index Anwendungen	H04
Drills Bohrer	H05-07
Trepanning drills Kernbohrer	H08
Spot facing and countersink milling cutters Senkfräser und Rückwärtssenker	H09-11
Technical information Technische Auskünfte	H12-13
Cutting data Schnittdaten	H14-17



H

Square inserts / Positive Vierkant-Wendeschneidplatten / Positiv

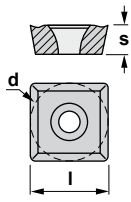

- i** Use classification / Einsatzbereich
- Continuous / Ununterbrochen
 - ◐ Slight interruption / Leicht unterbrochen
 - ⊕ Interruption / Unterbrochen
- i** Availability / Verfügbarkeit
- Standard item / Standard-Artikel
 - Check availability / Verfügbarkeit prüfen

P	Steel Stahl																			
M	Stainless Rostfreier Stahl																			
K	Cast iron Guß																			
N	Non ferrous materials Nicht-Eisen-Metalle																			
S	Heat-resistant alloys Hitzebeständige Legierungen																			
H	Hard materials Harte Materialien																			



SPMT



Reference / Bezeichnung

	l	s	d	r
SPMT 060304	6,35	3,18	6,35	0,4
SPMT 070308	7,94	3,18	7,94	0,8
SPMT 090308	9,52	3,18	9,52	0,8
SPMT 120408	12,70	4,76	12,70	0,8

KM15																				
PM25																				
PM40																				
TIN21																				
TIN25																				
TIN28																				
TL10																				
TL20																				
TL40																				
ZR10																				

80° Trigon inserts / Positive Trigon-Wendeschneidplatten 80° / Positiv

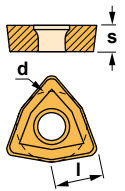

- i** Use classification / Einsatzbereich
- Continuous / Ununterbrochen
 - ◐ Slight interruption / Leicht unterbrochen
 - ⊕ Interruption / Unterbrochen
- i** Availability / Verfügbarkeit
- Standard item / Standard-Artikel
 - Check availability / Verfügbarkeit prüfen

P	Steel Stahl																			
M	Stainless Rostfreier Stahl																			
K	Cast iron Guß																			
N	Non ferrous materials Nicht-Eisen-Metalle																			
S	Heat-resistant alloys Hitzebeständige Legierungen																			
H	Hard materials Harte Materialien																			



WCMX



Reference / Bezeichnung

	l	s	d	r
WCMX 030208	3,46	2,38	5,56	0,8
WCMX 040208	3,99	2,38	6,35	0,8
WCMX 050308	5,07	3,18	7,94	0,8
WCMX 06T308	6,14	3,97	9,52	0,8
WCMX 080412	8,14	4,76	12,70	1,2

KM15																				
PM25																				
PM40																				
TIN21																				
TIN25																				
TIN28																				
TN30																				
TL20																				
TL40																				
ZR10																				



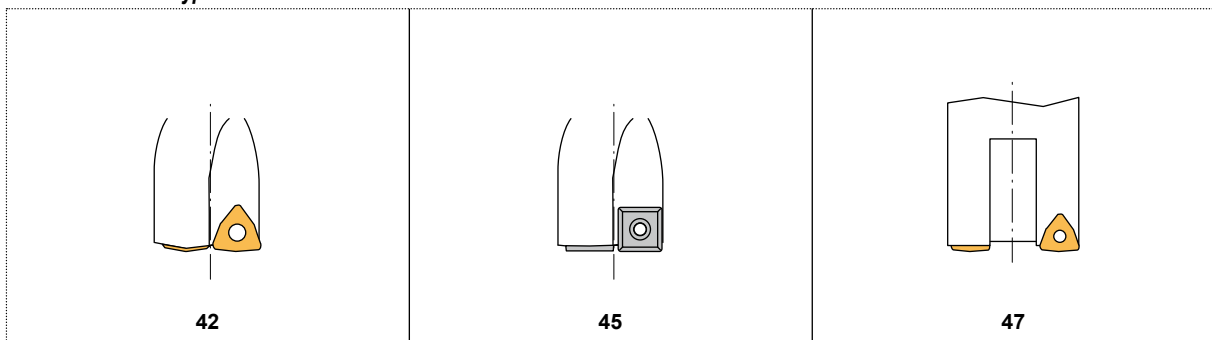

Code system / Kodifizierung

4	2	3	4	63	027
1		2	3	4	5

1 Drill type Bohrertyp

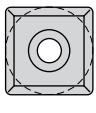
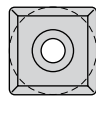
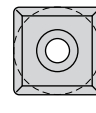
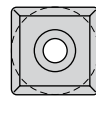

2 Insert size Wendeschneidplatte

1	2	3	4	5
 WCMX 0302	 WCMX 0402	 WCMX 0503	 WCMX 06T3	 WCMX 0804
 SPMT 0603	 SPMT 0703	 SPMT 0903	 SPMT 1204	

3 Clearance angle of insert Wendeschneidplatten-Freiwinkel

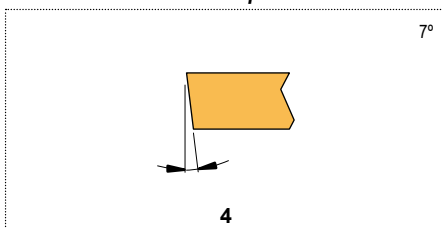

4 Shank size Schaftgröße

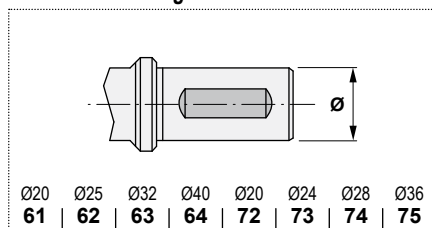

5 Diameter, mm. Durchmesser, mm.

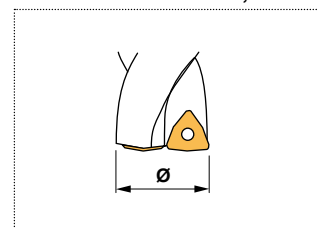

**Drills
Bohrer**

45..

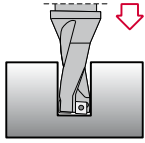

SPMT 0603..
P / S. H05 SPMT 1204..

42..

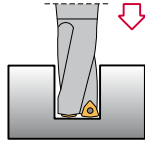

WCMX 0302..
P / S. H06 WCMX 0804..

42¹₄ 4.⁷²₇₅

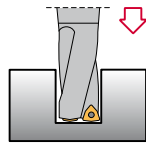

WCMX 0302..
P / S. H07 WCMX 06T3..

**Trepanning drills
Kernbohrer**

4744.64

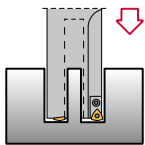

P / S. H08 WCMX 08T3..

**Spot facing and countersink milling cutters
Senkfräser und Rückwärtssenker**

02¹₃ 4.00

Spot facing milling cutters
Senkfräser

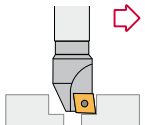

CC.. 0602..
P / S. H09 CC.. 09T3..

9614.61

Back draft spot facing
Rückwärtssenker

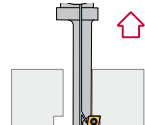

CC.. 0602..
P / S. H10 CC.. 09T3..

9624.61

Back draft spot countersink
Rückwärtssenker zum Anfasen

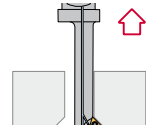

CC.. 0602..
P / S. H11 TC.. 1102..



Characteristics:

Helical flute indexable insert drill that provides faster cutting speeds and efficient chip removal for use on conventional and C.N.C. machines. It works well on steels, alloyed steels, stainless steels and refractories.
Max. hole depth = 3 x Diameter (D)

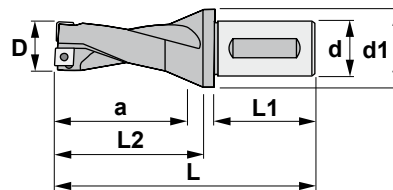

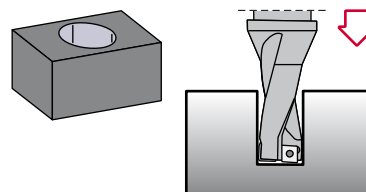

Eigenschaften:

Spiralformige Wendeschneidplatten-Bohrer um eine höhere Schnittgeschwindigkeit und einen guten Spanabfluß zu erreichen. Sie werden in konventionellen CNC-Drehmaschinen eingesetzt. Empfohlen für Stahl und auch für legierten, rostfreien und hitzebeständigen Stahl
Max. Bohrtiefe = 3 x Durchmesser (D)



45..

Reference Bezeichnung	D	L	L1	L2	a	d	d1		Nm	Insert size Wendeschneidplatte	
4514.62.015	15	120	55	56	45	25	40	1225 5507	0.9	SPMT 0603..	0,240
4514.62.016	16	121	55	56	48	25	40	1225 5507	0.9	SPMT 0603..	0,250
4514.62.017	17	127	55	54	51	25	40	1225 5507	0.9	SPMT 0603..	0,250
4514.62.017,5	17,5	127	55	56	53	25	40	1225 5507	0.9	SPMT 0603..	0,250
4514.62.018	18	128	55	57	54	25	40	1225 5507	0.9	SPMT 0603..	0,230
4514.62.018,5	18,5	130	55	59	56	25	40	1230 5507	0.9	SPMT 0603..	0,240
4514.62.019	19	131	55	60	57	25	40	1250 5507	0.9	SPMT 0603..	0,240
4514.62.020	20	136	55	64	60	25	40	1225 5507	0.9	SPMT 0603..	0,250
4524.62.022	22	142	55	69	66	25	40	1225 5507	0.9	SPMT 0703..	0,400
4524.62.024	24	150	55	76	72	25	40	1225 5507	0.9	SPMT 0703..	0,450
4524.62.025	25	154	55	79	75	25	40	1225 5507	0.9	SPMT 0703..	0,475
4534.63.026	26	162	55	81	78	32	50	1225 5510	2.0	SPMT 0903..	0,475
4534.63.027	27	165	55	84	81	32	50	1225 5520	4.0	SPMT 0903..	0,500
4534.63.028	28	169	55	87	84	32	50	1230 5510	2.0	SPMT 0903..	0,550
4534.63.029	29	172	55	90	87	32	50	1230 5510	2.0	SPMT 0903..	0,570
4534.63.030	30	177	55	94	90	32	50	1230 5510	2.0	SPMT 0903..	0,600
4534.64.031	31	186	60	97	93	40	60	1230 5510	2.0	SPMT 0903..	0,850
4534.64.032	32	189	60	100	96	40	60	1230 5510	2.0	SPMT 0903..	0,900
4534.64.034	34	196	60	106	102	40	60	1230 5510	2.0	SPMT 0903..	0,975
4544.64.035	35	200	60	109	105	40	60	1230 5510	2.0	SPMT 1204..	1,000
4544.64.038	38	211	60	118	114	40	60	1250 5520	4.0	SPMT 1204..	1,170
4544.64.039	39	214	60	121	117	40	60	1250 5520	4.0	SPMT 1204..	1,200
4544.64.040	40	218	60	124	120	40	60	1250 5520	4.0	SPMT 1204..	1,300
4544.64.042	42	225	65	130	126	40	60	1250 5520	4.0	SPMT 1204..	1,600
4544.64.043	43	229	65	133	129	40	60	1250 5520	4.0	SPMT 1204..	1,750
4544.64.045	45	237	65	140	135	40	60	1250 5520	4.0	SPMT 1204..	1,900



SPMT

Square positive insert with 11° clearance. Vierkantige positive Wendeschneidplatte mit 11° Freiwinkel.  H02

Reference / Bez.	l	s	d
SPMT 060304	6,35	3,18	6,35
SPMT 070308	7,94	3,18	7,94
SPMT 090308	9,52	3,18	9,52
SPMT 120408	12,70	4,76	12,70

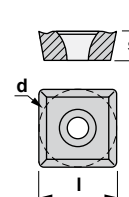

SPMT





Characteristics:

Helical flute indexable insert drill that provides faster cutting speeds and efficient chip removal for use on conventional and C.N.C. machines. It works well on steels, alloyed steels, stainless steels and refractories.
Max. hole depth = 3 x Diameter (D)

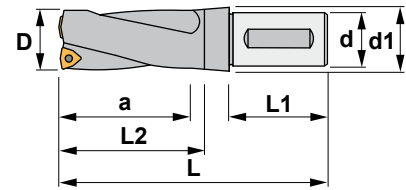

Eigenschaften:

Spiralförmige Wendeschneidplatten-Bohrer um eine höhere Schnittgeschwindigkeit und einen guten Spanabfluß zu erreichen. Sie werden in konventionellen CNC-Drehmaschinen eingesetzt. Empfohlen für Stahl und auch für legierten, rostfreien und hitzebeständigen Stahl.
Max. Bohrtiefe = 3 x Durchmesser (D)

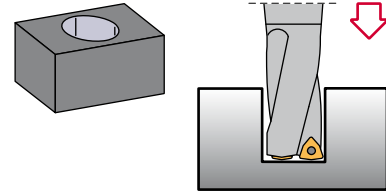

42..

Reference Bezeichnung	D	L	L1	L2	a	d	d1	Radial Adj. Radiale Anp. Dmax	Dmax	Nm	Insert size Wendeschneidplatte	kg	
4214.62.017,5	17,5	127	55	56	53	25	40	+1,00	19,5	1622 5507	0.9	WCMX 0302..	0,220
4214.62.018	18	128	55	57	54	25	40	+0,90	19,8	1622 5507	0.9	WCMX 0302..	0,230
4214.62.018,5	18,5	130	55	59	56	25	40	+0,85	20,2	1622 5507	0.9	WCMX 0302..	0,240
4214.62.019	19	131	55	60	57	25	40	+0,80	20,6	1622 5507	0.9	WCMX 0302..	0,240
4214.62.020	20	136	55	64	60	25	40	+0,75	21,5	1622 5507	0.9	WCMX 0302..	0,250
4224.62.022	22	142	55	69	66	25	40	+1,25	24,5	1225 5507	0.9	WCMX 0402..	0,400
4224.62.024	24	150	55	76	72	25	40	+0,75	25,5	1225 5507	0.9	WCMX 0402..	0,450
4224.62.025	25	154	55	79	75	25	40	+0,50	26,0	1225 5507	0.9	WCMX 0402..	0,475
4234.63.026	26	162	60	81	78	32	50	+2,50	31,0	1630 5509	1.4	WCMX 0503..	0,475
4234.63.027	27	165	60	84	81	32	50	+2,20	31,4	1630 5509	1.4	WCMX 0503..	0,500
4234.63.028	28	169	60	87	84	32	50	+2,10	32,2	1630 5509	1.4	WCMX 0503..	0,550
4234.63.029	29	172	60	90	87	32	50	+1,80	32,6	1630 5509	1.4	WCMX 0503..	0,570
4234.63.030	30	177	60	94	90	32	50	+1,80	33,0	1630 5509	1.4	WCMX 0503..	0,600
4244.64.031	31	186	65	97	93	40	60	+3,50	38,0	1635 5510	2.0	WCMX 06T3..	0,850
4244.64.032	32	189	65	100	96	40	60	+3,20	38,4	1635 5510	2.0	WCMX 06T3..	0,900
4244.64.034	34	196	65	106	102	40	60	+2,80	39,6	1635 5510	2.0	WCMX 06T3..	0,975
4244.64.035	35	200	65	109	105	40	60	+2,50	40,0	1635 5510	2.0	WCMX 06T3..	1,000
4244.64.038	38	211	65	118	114	40	60	+1,80	41,0	1635 5510	2.0	WCMX 06T3..	1,170
4244.64.039	39	214	65	121	117	40	60	+1,50	41,6	1635 5510	2.0	WCMX 06T3..	1,200
4244.64.040	40	218	65	124	120	40	60	+1,20	42,0	1635 5510	2.0	WCMX 06T3..	1,300
4254.64.042	42	225	65	130	126	40	60	+4,20	51,0	1640 5515	3.0	WCMX 0804..	1,600
4254.64.043	43	229	65	133	129	40	60	+4,00	51,4	1640 5515	3.0	WCMX 0804..	1,750
4254.64.045	45	237	65	140	135	40	60	+3,60	52,2	1640 5515	3.0	WCMX 0804..	1,900
4254.64.048	48	248	65	149	144	40	60	+2,70	53,4	1640 5515	3.0	WCMX 0804..	2,250
4254.64.049	49	251	65	152	147	40	60	+2,50	54,0	1640 5515	3.0	WCMX 0804..	2,200
4254.64.050	50	255	65	155	150	40	60	+2,20	54,4	1640 5515	3.0	WCMX 0804..	2,400
4254.64.052	52	262	65	161	156	40	60	+1,80	55,6	1640 5515	3.0	WCMX 0804..	2,500
4254.64.054	54	269	65	167	162	40	60	+1,20	56,4	1640 5515	3.0	WCMX 0804..	2,700
4254.64.055	55	274	65	171	165	40	60	+0,80	56,6	1640 5515	3.0	WCMX 0804..	2,850

WCMX

80° trigon positive insert with 7° clearance. 80° trigon positive Wendeschneidplatte mit 7° Freiwinkel. H02

Reference / Bez.	l	s	d
WCMX 0302..	3,46	2,38	5,56
WCMX 0402..	3,99	2,38	6,35
WCMX 0503..	5,07	3,18	7,94
WCMX 06T3..	6,14	3,97	9,52
WCMX 0804..	8,14	4,76	12,70

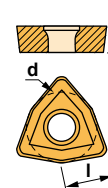

WCMX





Characteristics:

Helical flute indexable insert drill that provides faster cutting speeds and efficient chip removal for use on conventional and C.N.C. machines. It works well on steels, alloyed steels, stainless steels and refractories.
Max. hole depth = 3 x Diameter (D)

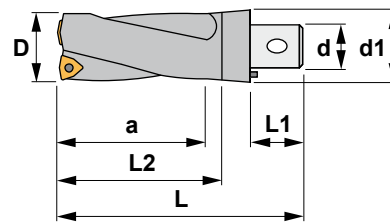

Eigenschaften:

Spiralformige Wendschneidplatten-Bohrer um eine höhere Schnittgeschwindigkeit und einen guten Spanabfluß zu erreichen. Sie werden in konventionellen CNC-Drehmaschinen eingesetzt. Empfohlen für Stahl, und auch für legierten, rostfreien und hitzebeständigen Stahl.
Max. Bohrtiefe = 3 x Durchmesser (D)

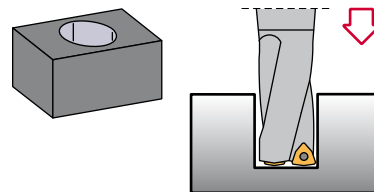

42¹₄4.72⁷²₇₅

Reference Bezeichnung	D	L	L1	L2	a	d	d1	Radial Adj. Radiale Anp. Dmax	Dmax	Nm	Insert size Wendschneidplatte	KG
4214.72.017,5	17,5	92	20	56	53	20	32	+1,00	19,5	1622 5507	WCMX 0302..	0,070
4214.72.018	18	93	20	57	54	20	32	+0,90	19,8	1622 5507	WCMX 0302..	0,080
4214.72.018,5	18,5	95	20	59	56	20	32	+0,85	20,2	1622 5507	WCMX 0302..	0,080
4214.72.019	19	96	20	60	57	20	32	+0,80	20,6	1622 5507	WCMX 0302..	0,090
4214.72.020	20	101	20	64	60	20	32	+0,75	21,5	1622 5507	WCMX 0302..	0,110
4224.73.022	22	112	25	69	66	24	40	+1,25	24,5	1225 5507	WCMX 0402..	0,320
4224.73.024	24	120	25	76	72	24	40	+0,75	26,5	1225 5507	WCMX 0402..	0,370
4224.73.025	25	124	25	79	75	24	40	+0,50	26,0	1225 5507	WCMX 0402..	0,400
4234.74.026	26	132	30	81	78	28	40	+2,50	31,0	1630 5509	WCMX 0503..	0,375
4234.74.027	27	135	30	84	81	28	40	+2,20	31,4	1630 5509	WCMX 0503..	0,400
4234.74.028	28	139	30	87	84	28	40	+2,10	32,2	1630 5509	WCMX 0503..	0,450
4234.74.029	29	142	30	90	87	28	40	+1,80	32,6	1630 5509	WCMX 0503..	0,470
4234.74.030	30	147	30	94	90	28	40	+1,80	33,0	1630 5509	WCMX 0503..	0,500
4244.75.031	31	161	40	97	93	36	50	+3,50	38,0	1635 5510	WCMX 06T3..	0,600
4244.75.032	32	164	40	100	96	36	50	+3,20	38,4	1635 5510	WCMX 06T3..	0,750
4244.75.034	34	171	40	106	102	36	50	+2,80	39,6	1635 5510	WCMX 06T3..	0,800
4244.75.035	35	175	40	109	105	36	50	+2,50	40,0	1635 5510	WCMX 06T3..	0,850
4244.75.038	38	186	40	118	114	36	50	+1,80	41,0	1635 5510	WCMX 06T3..	1,000
4244.75.039	39	189	40	121	117	36	50	+1,50	41,6	1635 5510	WCMX 06T3..	1,050
4244.75.040	40	193	40	124	120	36	50	+1,20	42,0	1635 5510	WCMX 06T3..	1,150

WCMX

80° trigon positive insert with 7° clearance. 80° trigon positive Wendschneidplatte mit 7° Freiwinkel. **H02**

Reference / Bez.

l

s

d

WCMX 0302..

3,46

2,38

5,56

WCMX 0402..

3,99

2,38

6,35

WCMX 0503..

5,07

3,18

7,94

WCMX 06T3..

6,14

3,97

9,52

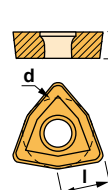

WCMX





Characteristics:

Straight flute indexable insert trepanning drill that provides faster cutting speeds and efficient chip removal for use on conventional and C.N.C. machines. It works well on steels, alloyed steels, stainless steels and refractories. Max. hole depth = 2.5 x Diameter (D)

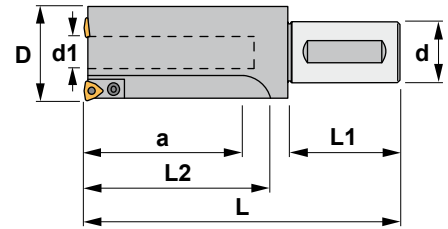

Eigenschaften:

Gerader Wendeschneidplatten-Kernbohrer um eine höhere Schnittgeschwindigkeit und einen guten Spanabfluß zu erreichen. Sie werden in konventionellen CNC-Drehmaschinen eingesetzt. Empfohlen für Stahl, und auch für legierten, rostfreien und hitzebeständigen Stahl. Max. Bohrtiefe = 2.5 x Durchmesser (D)

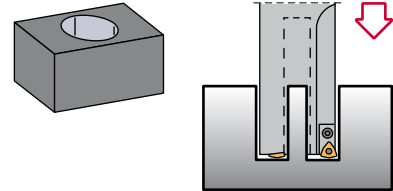

4744.64

Reference Bezeichnung	D	L	L1	L2	a	d	d1	Insert size Wendeschneidplatte	KG
4744.64.060	60	260	65	160	150	40	24	WCMX 06T3..	3,100
4744.64.065	65	275	65	175	165	40	29	WCMX 06T3..	3,700
4744.64.070	70	285	65	185	175	40	34	WCMX 06T3..	4,250
4744.64.075	75	300	65	200	190	40	39	WCMX 06T3..	5,100
4744.64.080	80	310	65	210	200	40	44	WCMX 06T3..	5,800
4744.64.085	85	325	65	225	215	40	49	WCMX 06T3..	6,500
4744.64.090	90	335	65	235	225	40	54	WCMX 06T3..	7,250
4744.64.095	95	350	65	250	240	40	59	WCMX 06T3..	8,200
4744.64.100	100	360	65	260	250	40	64	WCMX 06T3..	9,050

Reference Bezeichnung										Nm
4744.64.060	1396	5510	1405	1635	1503	5002	5005	6806	6816	2.0
4744.64.065	1396	5510	1405	1635	1503	5002	5005	6806	6816	2.0
4744.64.070	1396	5510	1405	1635	1503	5002	5005	6806	6816	2.0
4744.64.075	1396	5510	1405	1635	1503	5002	5005	6806	6816	2.0
4744.64.080	1396	5510	1405	1635	1503	5002	5005	6806	6816	2.0
4744.64.085	1396	5510	1405	1635	1503	5002	5005	6806	6816	2.0
4744.64.090	1396	5510	1405	1635	1503	5002	5005	6806	6816	2.0
4744.64.095	1396	5510	1405	1635	1503	5002	5005	6806	6816	2.0
4744.64.100	1396	5510	1405	1635	1503	5002	5005	6806	6816	2.0

WCMX

80° trigon positive insert with 7° clearance. 80° trigon positive Wendeschneidplatte mit 7° Freiwinkel. H02

Reference / Bez.	l	s	d
WCMX 06T3..	6,14	3,97	9,52

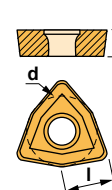

WCMX





Characteristics:
 Spot facing milling cutter for
 flat screw heads.
 For counterboring operations.

Eigenschaften:
 Fräser zum Planenken für flache
 Schraubenköpfe.
 Zum Planenken.

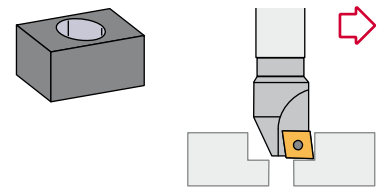
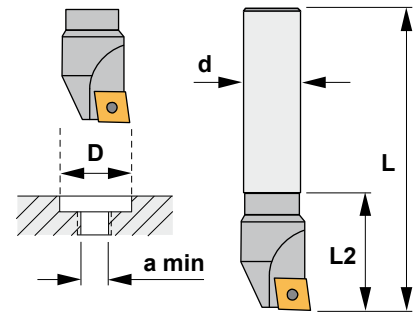

02¹₃4.00

Reference Bezeichnung		D	d	a min	L	L2		Nm	Insert size Wendeschneidplatte	
0214.00.010	1	10	12	4	85	15	1425 5507	0.9	CC.. 0602..	0,100
0214.00.011	1	11	12	4	85	15	1425 5507	0.9	CC.. 0602..	0,100
0214.00.012	1	12	12	4	85	15	1425 5507	0.9	CC.. 0602..	0,100
0214.00.013	1	13	12	5	85	15	1425 5507	0.9	CC.. 0602..	0,100
0214.00.014	1	14	12	5	85	19	1425 5507	0.9	CC.. 0602..	0,100
0214.00.015	1	15	12	5	85	19	1425 5507	0.9	CC.. 0602..	0,100
0214.00.016	1	16	12	5	85	19	1425 5507	0.9	CC.. 0602..	0,100
0234.00.017	1	17	16	5	95	30	1440 5515	3.0	CC.. 09T3..	0,125
0234.00.018	1	18	16	5	95	30	1440 5515	3.0	CC.. 09T3..	0,125
0234.00.019	1	19	16	5	95	32	1440 5515	3.0	CC.. 09T3..	0,125
0234.00.020	1	20	16	5	95	32	1440 5515	3.0	CC.. 09T3..	0,125
0234.00.022	1	22	16	6	95	32	1440 5515	3.0	CC.. 09T3..	0,150
0234.00.025	1	25	16	8	95	32	1440 5515	3.0	CC.. 09T3..	0,150
0234.00.026	1	26	16	8	95	32	1440 5515	3.0	CC.. 09T3..	0,150
0234.00.028	1	28	16	10	95	32	1440 5515	3.0	CC.. 09T3..	0,150
0234.00.030	1	30	16	10	95	32	1440 5515	3.0	CC.. 09T3..	0,150
0234.00.032	1	32	16	12	95	32	1440 5515	3.0	CC.. 09T3..	0,150
0234.00.033	1	33	16	12	95	32	1440 5515	3.0	CC.. 09T3..	0,150

CC.. 80° rhombic positive inserts with 7° clearance. F12
 80° rhombische positive Wendeschneidplatten mit 7° Freiwinkel.

Reference / Bez.	l	s	d
CC.. 0602..	6,45	2,38	6,35
CC.. 09T3..	9,65	3,97	9,52

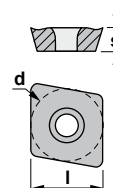

CCGT-AL



CCKT



CCMW





Characteristics:
Back draft spot facing milling cutter
with internal coolant for flat screw
heads.
For counterboring operations.

Eigenschaften:
Rückwärts-Plansenker
mit Innenkühlung für
flache Schraubenköpfe.
Zum Plansenken.

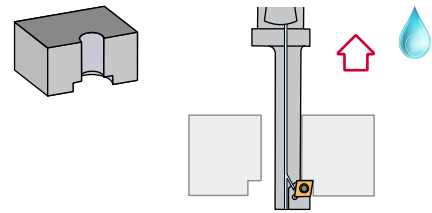
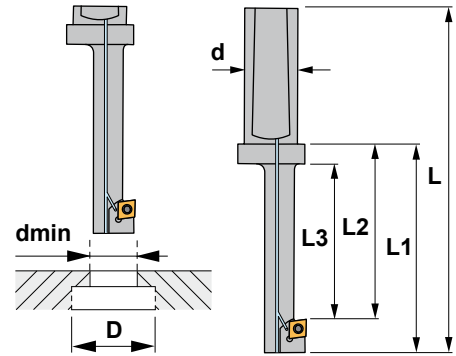

9614.61

Reference Bezeichnung		D	dmin	d	L	L1	L2	L3	D1	Insert size Wendeschneidplatte	
9614.61.018	1	18	10,5	20	112	62	47	40	25	CC.. 0602..	0,280
9614.61.020	1	20	13,0	20	113	63	52	45	25	CC.. 0602..	0,300
9614.61.024	1	24	15,0	20	118	68	57	50	25	CC.. 0602..	0,320
9614.61.026	1	26	17,0	20	128	78	67	60	25	CC.. 0602..	0,380
9614.61.030	1	30	19,0	20	138	88	77	70	25	CC.. 0602..	0,400
9614.61.033	1	33	21,0	20	152	102	82	75	25	CC.. 09T3..	0,430

Reference Bezeichnung			Nm
9614.61.018	1425	5507	0.9
9614.61.020	1425	5507	0.9
9614.61.024	1425	5507	0.9
9614.61.026	1225	5507	0.9
9614.61.030	1225	5507	0.9
9614.61.033	1440	5515	3.0

CC.. 80° rhombic positive inserts with 7° clearance. F12
80° rhombische positive Wendeschneidplatten mit 7° Freiwinkel.

Reference / Bez.	l	s	d
CC.. 0602..	6,45	2,38	6,35
CC.. 09T3..	9,65	3,97	9,52

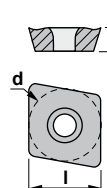

CCGT-AL



CCKT



CCMW





Characteristics:
 Back draft countersink milling cutter with internal coolant.
 Recommended for small conventional milling machines and machining centers.

Eigenschaften:
 Rückwärts-Senker mit Innenkühlung für flache Schraubenköpfe.
 Für konventionelle Fräsmaschinen und Bearbeitungszentren geeignet.

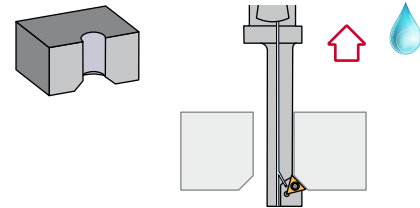
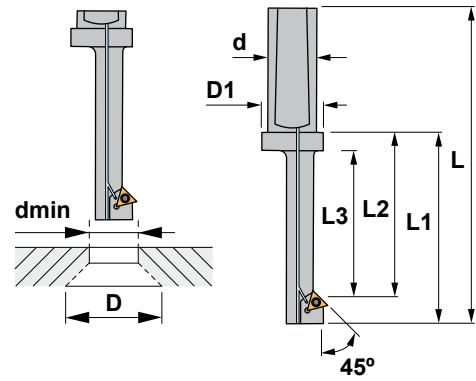

9624.61

Reference Bezeichnung		D	dmin	d	L	L1	L2	L3	D1	Insert size Wendeschneidplatte	
9624.61.015	1	15	10	20	105	55	42	35	25	CC.. 0602..	0,280
9624.61.020	1	20	14	20	110	60	47	40	25	CC.. 0602..	0,300
9624.61.023	1	23	17	20	120	70	57	50	25	TC.. 1102..	0,320
9624.61.027	1	27	21	20	140	90	77	70	25	TC.. 1102..	0,380
9624.61.031	1	31	24	20	150	100	87	80	25	TC.. 1102..	0,400

Reference Bezeichnung			Nm
9624.61.015	1425	5507	0.9
9624.61.020	1425	5507	0.9
9624.61.023	1225	5507	0.9
9624.61.027	1225	5507	0.9
9624.61.031	1225	5507	0.9

CC.. 80° rhombic positive inserts with 7° clearance. F12
 80° rhombische positive Wendeschneidplatten mit 7° Freiwinkel.

Reference / Bez.	l	s	d
CC.. 0602..	6,45	2,38	6,35

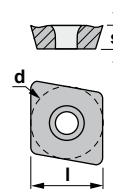

CCGT-AL



CCKT



CCMW



TC.. Triangular positive inserts with 7° clearance. F21
 Dreikantige positive Wendeschneidplatten mit 7° Freiwinkel.

Reference / Bez.	l	s	d
TC.. 1102..	6,45	2,38	6,35

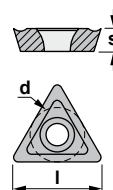

TCGT-AL



TCMT-39



TCMW

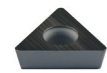

Drills - Recommendations for the assembly

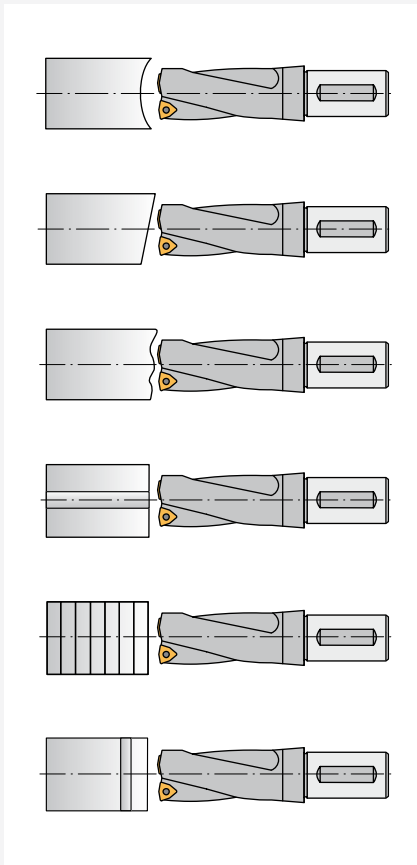

Drills for indexable inserts

A concave surface is not normally recommended because there is the possibility that the tool turns away from the center. Feed should be reduced to 1/3 of the recommended.

The surface of the tool to be drilled on should be preferably even. If the angles exceed 2° , feed should be reduced to 1/3 of the recommended.

If the starting surface is an uneven surface of the component, feed should be reduced so that the chip of the cutting edges can be avoided. The same can also happen at the way out from the tool.

When working with a hole made beforehand, this should not be bigger than 1/4 of the final size, because the tool could turn away.

There is the possibility to drill sets of more than one piece.

When the tool has a crossed hole, which is 1/4 bigger than the diameter of the drill, feed should be reduced when going through it.

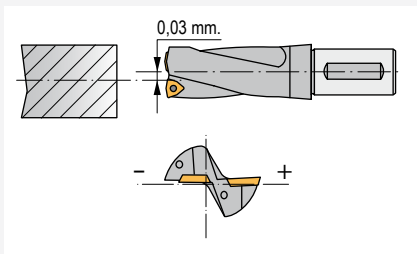

Fixed drills

The axis of the tool should not be deviated from the center of the piece more than 0,03 mm. so that the pointed tolerances are acquired.

The tool should be assembled in a way that the face of the central insert goes parallel to the cross movement axis of the machine.

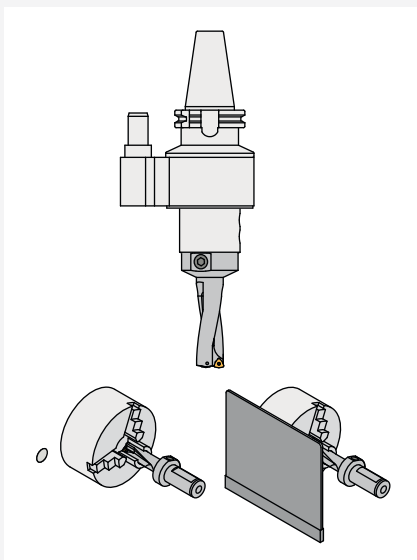

Drilling with drill-holders with housing for cutting fluid supply

When a drillholder with a housing supplier of cutting fluid is used, it has to have a fixed top so as to avoid that the housing turns around.

If the cutting fluid has some dirty rests, this could lock the rotary housing and, consequently, the supplier tube would roll up around it, which could cause a serious accident.

If the drillholder has not been used for a long time, check if it turns round in the housing before the spindle starts working.

Drilling of through-holes

When through-holes are drilled, a disk is produced after the drill has finished the hole. This disk is often thrown away at high speed and can cause injuries and accidents.

In order to avoid this accident, a suitable safety system has to be placed around the dish.

Bohrer – Einsatzempfehlungen

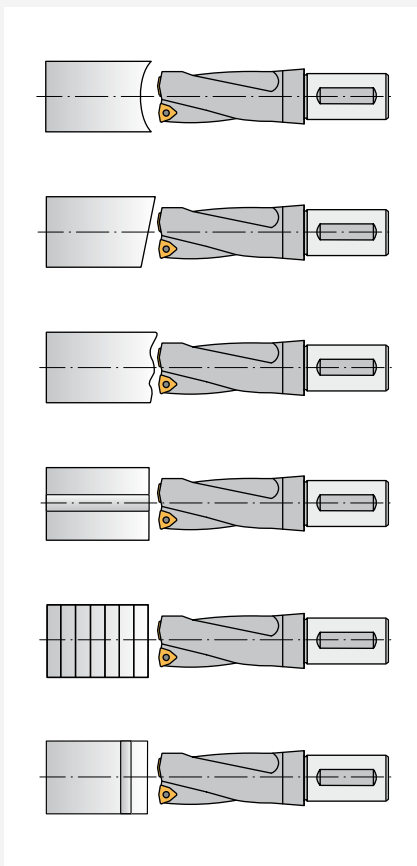

Bohrer für Wendeschneidplatten

Eine konkave Oberfläche ist normalerweise nicht empfohlen, weil die Möglichkeit besteht, daß der Bohrer von der Mitte abgelenkt wird. Der Vorschub sollte auf 1/3 des empfohlenen Wertes vermindert werden.

Die Anbohrfläche sollte wenn möglich eben sein. Wenn die Winkel mehr als 2° betragen, sollte man den Vorschub beim Anbohren auf 1/3 des empfohlenen Wertes vermindern.

Wenn man ab einer ungleichmäßigen Oberfläche beginnt, muss der Vorschub beim Anbohren reduziert werden, so daß ein Ausbröckeln der Schneidkante verhindert werden kann. Das gleiche kann auch beim Durchbohren passieren.

Wenn man in einem Werkstück bohrt, das schon angebohrt ist, darf diese vorgebohrte Bohrung nicht größer als 1/4 des gewünschten Enddurchmessers haben, da der Bohrer sonst von der Mitte abgelenkt wird.

Es ist möglich, mehrere übereinander liegende Werkstücke zu bohren.

Wenn das Werkstück eine Querbohrung von mehr als 1/4 des Bohrerdurchmessers hat, muß der Vorschub vermindert werden, wenn man durch diese Bohrung bohrt.

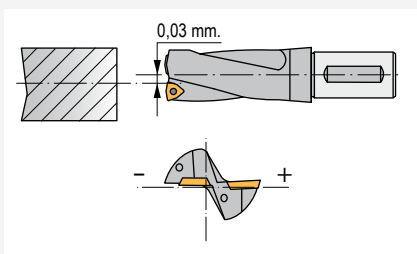

Nichtrotierende Bohrer

Die Werkzeugachse darf nicht mehr als 0,03 mm von der Mitte des Werkstücks abgelenkt sein, damit man die angegebenen Toleranzen erreichen kann.

Der Bohrer muß so positioniert werden, daß die Schneidkante der Mittelplatte parallel zur X-Achse der Maschine ist.

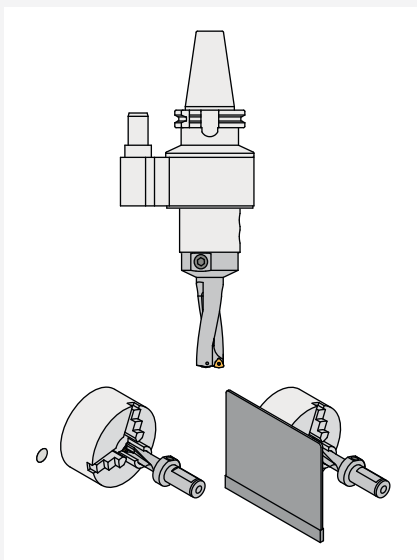

Bohren mit Halter mit Kühlmittelgehäuse

Wenn man einen Halter mit Kühlmittelgehäuse verwendet, muß eine Arretierung vorhanden sein, die das Rotieren des Gehäuses verhindert.

Falls das Kühlmittel durch Spanpartikel verschmutzt ist, könnte das Gehäuse blockieren und in diesem Fall würde das Gehäuse die Zuleitung mit sich ziehen, und ein ernsthafter Unfall könnte die Folge sein.

Wenn ein Halter mit Kühlmittelgehäuse längere Zeit nicht verwendet worden ist, muß vor Inbetriebnahme der Maschine geprüft werden, ob sich der Halter im Gehäuse leicht drehen läßt.

Bohren von Durchgangsbohrungen

Wenn man Durchgangsbohrungen bohrt, entsteht beim Austritt des Bohrers aus dem Werkstück eine Scheibe, die oft mit hoher Geschwindigkeit aus dem Spannfutter geschleudert wird und Schaden und Verletzungen verursachen kann.

Um dies zu verhindern, muß eine Schutzabdeckung um das Spannfutter vorhanden sein.



Material	HB	Condition	D mm.	Feed mm./Rev.	Cutting speed mm./min.
Unalloyed steel P	90-200	Non-hardened 0,05-0,25%C	17,5-25,4 26,0-30,0 31,0-41,3 42,0-80,0	0,04-0,08 0,06-0,10 0,08-0,12 0,08-0,12	100-250
Unalloyed steel	125-225 150-225 180-225	Non-hardened 0,25-0,55%C Non-hardened 0,55-0,80%C High carbon & carbon tool steel	17,5-25,4 26,0-30,0 31,0-41,3 42,0-80,0	0,04-0,12 0,09-0,19 0,11-0,20 0,14-0,25	100-250
Low alloyed steel	150-260	Non-hardened	17,5-25,4 26,0-30,0 31,0-41,3 42,0-80,0	0,08-0,12 0,09-0,16 0,11-0,20 0,14-0,22	90-250
Low alloyed steel	220-400	Hardened	17,5-25,4 26,0-30,0 31,0-41,3 42,0-80,0	0,06-0,10 0,08-0,15 0,08-0,15 0,11-0,20	80-220
High alloyed steel	150-250 150-250	Annealed Annealed HSS	17,5-25,4 26,0-30,0 31,0-41,3 42,0-80,0	0,08-0,12 0,09-0,18 0,11-0,22 0,14-0,25	100-220
High alloyed steel	250-350 250-400	Hardened tool steel Hardened steel	17,5-25,4 26,0-30,0 31,0-41,3 42,0-80,0	0,08-0,12 0,09-0,15 0,11-0,17 0,12-0,20	90-200
Stainless steel	150-270	Ferritic, Martensitic 13-25%Cr	17,5-25,4 26,0-30,0 31,0-41,3 42,0-80,0	0,04-0,12 0,10-0,16 0,11-0,18 0,11-0,18	90-190
Steel castings	150-270	Unalloyed	17,5-25,4 26,0-30,0 31,0-41,3 42,0-80,0	0,05-0,08 0,06-0,10 0,09-0,15 0,11-0,18	100-230
Steel castings	90-225	Low alloyed (alloying elements < 5%)	17,5-25,4 26,0-30,0 31,0-41,3 42,0-80,0	0,08-0,12 0,09-0,15 0,12-0,20 0,14-0,22	90-200
Stainless steel M	150-250	Austenitic Ni > 8%, 18-25% Cr	17,5-25,4 26,0-30,0 31,0-41,3 42,0-80,0	0,04-0,12 0,10-0,16 0,11-0,18 0,11-0,18	70-150
Malleable cast iron K	110-145	Ferritic (short chipping)	17,5-25,4 26,0-30,0 31,0-41,3 42,0-80,0	0,11-0,18 0,14-0,22 0,17-0,27 0,18-0,30	90-200
Malleable cast iron	150-270	Pearlitic (long chipping)	17,5-25,4 26,0-30,0 31,0-41,3 42,0-80,0	0,09-0,15 0,11-0,19 0,12-0,20 0,14-0,22	80-180
Grey cast iron	150-220	Low tensile strength	17,5-25,4 26,0-30,0 31,0-41,3 42,0-80,0	0,09-0,15 0,14-0,22 0,15-0,25 0,18-0,30	80-180
Grey cast iron	200-330	High tensile strength	17,5-25,4 26,0-30,0 31,0-41,3 42,0-80,0	0,09-0,15 0,12-0,20 0,14-0,22 0,15-0,25	70-150
Nodular cast iron	125-230	Ferritic	17,5-25,4 26,0-30,0 31,0-41,3 42,0-80,0	0,09-0,15 0,14-0,22 0,15-0,25 0,17-0,28	80-180
Nodular cast iron	200-300	Pearlitic	17,5-25,4 26,0-30,0 31,0-41,3 42,0-80,0	0,09-0,15 0,12-0,20 0,14-0,22 0,15-0,30	70-150
Aluminium alloys	75-150 40-100 70-125	Wrought, solution treated & aged Cast Cast, solution treated & aged	17,5-25,4 26,0-30,0 31,0-41,3 42,0-80,0	0,08-0,12 0,11-0,17 0,17-0,27 0,17-0,27	150-375
Copper and copper alloys	50-160	Free cutting alloys (pb>1%) Brass and leaded bronzes (pb<1%)	17,5-25,4 26,0-30,0 31,0-41,3 42,0-80,0	0,09-0,15 0,09-0,15 0,15-0,25 0,15-0,25	80-160



Materialien	HB	Beschaffenheit	D mm.	Vorschub mm./Rev.	Schnittgeschwindigkeit mm./min.
Unlegierter Stahl P	90-200	Nicht vergütet 0,05-0,25%C	17,5-25,4	0,04-0,08	100-250
			26,0-30,0	0,06-0,10	
			31,0-41,3	0,08-0,12	
			42,0-80,0	0,08-0,12	
Unlegierter Stahl	125-225 150-225 180-225	Nicht vergütet 0,25-0,55%C Nicht vergütet 0,55-0,80%C Stahl mit hohem Kohlenstoff-Inhalt und Kohlenstoff-Werkzeugstahl	17,5-25,4	0,04-0,12	100-250
			26,0-30,0	0,09-0,19	
			31,0-41,3	0,11-0,20	
			42,0-80,0	0,14-0,25	
Niedrig legierter Stahl	150-260	Nicht vergütet	17,5-25,4	0,08-0,12	90-250
			26,0-30,0	0,09-0,16	
			31,0-41,3	0,11-0,20	
			42,0-80,0	0,14-0,22	
Niedriglegierter Stahl	220-400	Vergütet	17,5-25,4	0,06-0,10	80-220
			26,0-30,0	0,08-0,15	
			31,0-41,3	0,08-0,15	
			42,0-80,0	0,11-0,20	
Hochlegierter Stahl	150-250 150-250	Geglüht Geglühteter HSS	17,5-25,4	0,08-0,12	100-220
			26,0-30,0	0,09-0,18	
			31,0-41,3	0,11-0,22	
			42,0-80,0	0,14-0,25	
Hochlegierter Stahl	250-350 250-400	Vergüteter Werkzeugstahl Vergüteter Stahl	17,5-25,4	0,08-0,12	90-200
			26,0-30,0	0,09-0,15	
			31,0-41,3	0,11-0,17	
			42,0-80,0	0,12-0,20	
Rostfreier Stahl	150-270	Ferritisch, Martensitisch 13-25%Cr	17,5-25,4	0,04-0,12	90-190
			26,0-30,0	0,10-0,16	
			31,0-41,3	0,11-0,18	
			42,0-80,0	0,11-0,18	
Stahlguß	150-270	Unlegiert	17,5-25,4	0,05-0,08	100-230
			26,0-30,0	0,06-0,10	
			31,0-41,3	0,09-0,15	
			42,0-80,0	0,11-0,18	
Stahlguß	90-225	Niedrig legiert (Legierungsanteile < 5%)	17,5-25,4	0,08-0,12	90-200
			26,0-30,0	0,09-0,15	
			31,0-41,3	0,12-0,20	
			42,0-80,0	0,14-0,22	
Rostfreier Stahl M	150-250	Austenitisch Ni > 8%, 18-25% Cr	17,5-25,4	0,04-0,12	70-150
			26,0-30,0	0,10-0,16	
			31,0-41,3	0,11-0,18	
			42,0-80,0	0,11-0,18	
Temperguß K	110-145	Ferritisch (kurzspanend)	17,5-25,4	0,11-0,18	90-200
			26,0-30,0	0,14-0,22	
			31,0-41,3	0,17-0,27	
			42,0-80,0	0,18-0,30	
Temperguß	150-270	Perlitisch (langspanend)	17,5-25,4	0,09-0,15	80-180
			26,0-30,0	0,11-0,19	
			31,0-41,3	0,12-0,20	
			42,0-80,0	0,14-0,22	
Grauguß	150-220	Niedrige Zugfestigkeit	17,5-25,4	0,09-0,15	80-180
			26,0-30,0	0,14-0,22	
			31,0-41,3	0,15-0,25	
			42,0-80,0	0,18-0,30	
Grauguß	200-330	Hohe Zugfestigkeit	17,5-25,4	0,09-0,15	70-150
			26,0-30,0	0,12-0,20	
			31,0-41,3	0,14-0,22	
			42,0-80,0	0,15-0,25	
Kugelgraphiteguß	125-230	Ferritisch	17,5-25,4	0,09-0,15	80-180
			26,0-30,0	0,14-0,22	
			31,0-41,3	0,15-0,25	
			42,0-80,0	0,17-0,28	
Kugelgraphiteguß	200-300	Perlitisch	17,5-25,4	0,09-0,15	70-150
			26,0-30,0	0,12-0,20	
			31,0-41,3	0,14-0,22	
			42,0-80,0	0,15-0,30	
Aluminium-Legierungen	75-150 40-100 70-125	Geschmiedet, lösungsbehandelt und gealtert Gegossen Geschmiedet, lösungsbehandelt und gealtert	17,5-25,4	0,08-0,12	150-375
			26,0-30,0	0,11-0,17	
			31,0-41,3	0,17-0,27	
			42,0-80,0	0,17-0,27	
Kupfer und Kupferlegierungen	50-160	Automatenstähle (pb>1%) Messing und bleilegierte Bronzen (pb<1%)	17,5-25,4	0,09-0,15	80-160
			26,0-30,0	0,09-0,15	
			31,0-41,3	0,15-0,25	
			42,0-80,0	0,15-0,25	



Material	P	HB	Condition	D mm.	Feed mm./Rev.	Cutting speed m/min
Unalloyed steel		90-200 125-225 150-225 180-225	Non-hardened 0,05-0,25%C Non-hardened 0,25-0,55%C Non-hardened 0,55-0,80%C High carbon & carbon tool steel	60-100	0,08-0,12 0,11-0,18 0,11-0,18 0,11-0,18	150-250 100-250 100-250 100-250
Low alloyed steel		150-260 220-400	Non-hardened Hardened	60-100	0,11-0,18 0,08-0,12	100-250 100-220
High alloyed steel		150-250 150-250 250-350 250-400	Annealed Annealed HSS Hardened tool steel Hardened steel	60-100	0,11-0,19 0,11-0,19 0,11-0,18 0,11-0,17	100-220 100-220 100-200 100-200
Stainless steel		150-270	Ferritic, martensitic 13-25%Cr	60-100	0,11-0,17	100-200
Steel castings		90-225 150-250	Unalloyed Low alloyed (< 5%)	60-100	0,12-0,20 0,11-0,17	100-200 100-150
Material	M	HB	Condition	D mm.	Feed mm./Rev.	Cutting speed m/min
Stainless steel		150-270	Austenitic Ni > 8%, 18-25% Cr	60-100	0,09-0,15	100-230
Material	K	HB	Condition	D mm.	Feed mm./Rev.	Cutting speed m/min
Malleable cast iron		110-145 150-270	Ferritic (short chipping) Pearlitic (long chipping)	60-100 60-100	0,17-0,27 0,12-0,20	100-200 90-180
Grey cast iron		150-220 200-300	Low tensile strength High tensile strength	60-100 60-100	0,15-0,25 0,14-0,22	90-180 90-150
Nodular cast iron		125-230 200-300	Ferritic Pearlitic	60-100 60-100	0,15-0,25 0,14-0,22	100-180 90-150
Aluminium alloys		75-150 40-100 70-125	Wrought, solution treated & aged Cast Cast, solution treated & aged	60-100 60-100 60-100	0,17-0,27 0,17-0,27 0,17-0,27	150-375 150-375 150-375
Copper and copper alloys		50-160	Free cutting alloys (pb>1%) Brass and leaded bronzes (pb<1%)	60-100	0,15-0,25	100-160



Materialien	P	HB	Beschaffenheit	D mm.	Vorschub mm./Rev.	Schnittgeschwindigkeit m/min
Unlegierter Stahl		90-200 125-225 150-225 180-225	Nicht vergütet 0,05-0,25%C Nicht vergütet 0,25-0,55%C Nicht vergütet 0,55-0,80%C Stahl mit hohem Kohlenstoff-Inhalt und Kohlenstoff-Werkzeugstahl	60-100	0,08-0,12 0,11-0,18 0,11-0,18 0,11-0,18	150-250 100-250 100-250 100-250
Niedrig legierter Stahl		150-260 220-400	Nicht vergütet Vergütet	60-100	0,11-0,18 0,08-0,12	100-250 100-220
Hochlegierter Stahl		150-250 150-250 250-350 250-400	Geglüht Geglühteter HSS Vergüteter Werkzeugstahl Vergüteter Stahl	60-100	0,11-0,19 0,11-0,19 0,11-0,18 0,11-0,17	100-220 100-220 100-200 100-200
Rostfreier Stahl		150-270	Ferritisch, Martensitisch 13-25%Cr	60-100	0,11-0,17	100-200
Stahlguß		90-225 150-250	Unlegiert Niedrig legiert (< 5%)	60-100	0,12-0,20 0,11-0,17	100-200 100-150
Materialien	M	HB	Beschaffenheit	D mm.	Vorschub mm./Rev.	Schnittgeschwindigkeit m/min
Rostfreier Stahl		150-270	Austenitisch Ni > 8%, 18-25% Cr	60-100	0,09-0,15	100-230
Materialien	K	HB	Beschaffenheit	D mm.	Vorschub mm./Rev.	Schnittgeschwindigkeit m/min
Temperguß		110-145 150-270	Ferritisch (kurzspanend) Perlitisch (langspanend)	60-100 60-100	0,17-0,27 0,12-0,20	100-200 90-180
Grauguß		150-220 200-300	Niedrige Zugfestigkeit Hohe Zugfestigkeit	60-100 60-100	0,15-0,25 0,14-0,22	90-180 90-150
Kugelgraphiteguß		125-230 200-300	Ferritisch Perlitisch	60-100 60-100	0,15-0,25 0,14-0,22	100-180 90-150
Aluminium-Legierungen		75-150 40-100 70-125	Geschmiedet, lösungsbehandelt und gealtert Gegossen Geschmiedet, lösungsbehandelt und gealtert	60-100 60-100 60-100	0,17-0,27 0,17-0,27 0,17-0,27	150-375 150-375 150-375
Kupfer und Kupferlegierungen		50-160	Automatenstähle (pb>1%) Messing und bleilegierte Bronzen (pb<1%)	60-100	0,15-0,25	100-160



ISO Tolerances for Shafts (ISO 286-2)
ISO Toleranzen für Aufnahmen (ISO 286-2)

Nominal Shaft Sizes (mm) / Nenn-Abmessungen der Aufnahmen (mm)																				
bigger than größer als	3	6	10	18	30	40	50	65	80	100	120	140	160	180	200	225	250	280	315	355
until bis	6	10	18	30	40	50	65	80	100	120	140	160	180	200	225	250	280	315	355	400
Micrometres / Mikrometer																				
a12	-270 -390	-280 -430	-290 -470	-300 -510	-310 -560	-320 -570	-340 -640	-360 -660	-380 -730	-410 -760	-460 -860	-520 -920	-580 -980	-660 -1120	-740 -1200	-820 -1280	-920 -1440	-1050 -1570	-1200 -1770	-1350 -1920
d6	-30 -38	-40 -49	-50 -61	-65 -78	-80 -96	-100 -119	-120 -142	-145 -170	-170 -199	-190 -222	-210 -246	-230 -264	-250 -288	-270 -306	-290 -324	-310 -348	-330 -366	-350 -384	-370 -408	-390 -426
e6	-20 -28	-25 -34	-32 -43	-40 -53	-50 -66	-60 -79	-72 -94	-85 -110	-100 -129	-110 -142	-125 -161	-145 -174	-165 -194	-185 -214	-205 -234	-225 -254	-245 -274	-265 -294	-285 -314	-305 -334
e13	-20 -200	-25 -245	-32 -302	-40 -370	-50 -440	-60 -520	-72 -612	-85 -715	-100 -820	-110 -920	-125 -1015	-145 -1110	-165 -1210	-185 -1310	-205 -1410	-225 -1510	-245 -1610	-265 -1710	-285 -1810	-305 -1910
f5	-10 -15	-13 -19	-16 -24	-20 -29	-25 -36	-30 -43	-36 -51	-43 -61	-50 -70	-56 -79	-62 -87	-70 -90	-78 -98	-86 -106	-94 -114	-102 -122	-110 -130	-118 -138	-126 -146	-134 -154
f6	-10 -18	-13 -22	-16 -27	-20 -33	-25 -41	-30 -49	-36 -58	-43 -68	-50 -79	-56 -88	-62 -98	-70 -108	-78 -118	-86 -128	-94 -138	-102 -148	-110 -158	-118 -168	-126 -178	-134 -188
f7	-10 -22	-13 -28	-16 -34	-20 -41	-25 -50	-30 -60	-36 -71	-43 -83	-50 -96	-56 -108	-62 -121	-70 -134	-78 -147	-86 -160	-94 -173	-102 -186	-110 -199	-118 -212	-126 -225	-134 -238
g5	-4 -9	-5 -11	-6 -14	-7 -16	-9 -20	-10 -23	-12 -27	-14 -32	-15 -35	-17 -40	-18 -43	-20 -47	-22 -51	-24 -55	-26 -59	-28 -63	-30 -67	-32 -71	-34 -75	-36 -79
g6	-4 -12	-5 -14	-6 -17	-7 -20	-9 -25	-10 -29	-12 -34	-14 -39	-15 -44	-17 -49	-18 -54	-20 -64	-22 -74	-24 -84	-26 -94	-28 -104	-30 -114	-32 -124	-34 -134	-36 -144
g7	-4 -16	-5 -20	-6 -24	-7 -28	-9 -34	-10 -40	-12 -47	-14 -54	-15 -61	-17 -69	-18 -75	-20 -83	-22 -97	-24 -111	-26 -125	-28 -139	-30 -147	-32 -155	-34 -161	-36 -167
h4	-0 -4	-0 -4	-0 -5	-0 -6	-0 -7	-0 -8	-0 -10	-0 -12	-0 -14	-0 -16	-0 -18	-0 -20	-0 -22	-0 -24	-0 -26	-0 -28	-0 -30	-0 -32	-0 -34	-0 -36
h5	-0 -5	-0 -6	-0 -8	-0 -9	-0 -11	-0 -13	-0 -15	-0 -18	-0 -20	-0 -23	-0 -25	-0 -28	-0 -30	-0 -32	-0 -34	-0 -36	-0 -38	-0 -40	-0 -42	-0 -44
h6	-0 -8	-0 -9	-0 -11	-0 -13	-0 -16	-0 -19	-0 -22	-0 -25	-0 -29	-0 -32	-0 -36	-0 -40	-0 -44	-0 -48	-0 -52	-0 -56	-0 -60	-0 -64	-0 -68	-0 -72
h7	-0 -12	-0 -15	-0 -18	-0 -21	-0 -25	-0 -30	-0 -35	-0 -40	-0 -46	-0 -52	-0 -57	-0 -63	-0 -69	-0 -75	-0 -81	-0 -87	-0 -93	-0 -99	-0 -105	-0 -111
h8	-0 -18	-0 -22	-0 -27	-0 -33	-0 -39	-0 -46	-0 -54	-0 -63	-0 -72	-0 -81	-0 -89	-0 -98	-0 -107	-0 -116	-0 -125	-0 -134	-0 -143	-0 -152	-0 -161	-0 -170
h9	-0 -30	-0 -36	-0 -43	-0 -52	-0 -62	-0 -74	-0 -87	-0 -100	-0 -115	-0 -130	-0 -144	-0 -159	-0 -174	-0 -189	-0 -204	-0 -219	-0 -234	-0 -249	-0 -264	-0 -279
h10	-0 -48	-0 -58	-0 -70	-0 -84	-0 -100	-0 -120	-0 -140	-0 -160	-0 -185	-0 -210	-0 -230	-0 -250	-0 -270	-0 -290	-0 -310	-0 -330	-0 -350	-0 -370	-0 -390	-0 -410
h11	-0 -75	-0 -90	-0 -110	-0 -130	-0 -160	-0 -190	-0 -220	-0 -250	-0 -290	-0 -320	-0 -360	-0 -400	-0 -440	-0 -480	-0 -520	-0 -560	-0 -600	-0 -640	-0 -680	-0 -720
h12	-0 -120	-0 -150	-0 -180	-0 -210	-0 -250	-0 -300	-0 -350	-0 -400	-0 -460	-0 -520	-0 -570	-0 -630	-0 -690	-0 -750	-0 -810	-0 -870	-0 -930	-0 -990	-0 -1050	-0 -1110
j5	+3 -2	+4 -2	+5 -3	+5 -4	+6 -5	+6 -7	+6 -9	+7 -11	+7 -13	+7 -16	+7 -18	+7 -21	+7 -24	+7 -27	+7 -30	+7 -33	+7 -36	+7 -39	+7 -42	+7 -45
j6	+6 -2	+7 -2	+8 -3	+9 -4	+11 -5	+12 -7	+13 -9	+14 -11	+16 -13	+16 -16	+18 -18	+19 -21	+20 -24	+21 -27	+22 -30	+23 -33	+24 -36	+25 -39	+26 -42	+27 -45
j7	+8 -4	+10 -5	+12 -6	+13 -8	+15 -10	+18 -12	+20 -15	+22 -18	+25 -21	+26 -26	+28 -28	+30 -33	+32 -36	+34 -41	+36 -44	+38 -48	+40 -52	+42 -56	+44 -60	+46 -64
js5	+2.5 -2.5	+3 -3	+4 -4	+4.5 -4.5	+5.5 -5.5	+6.5 -6.5	+7.5 -7.5	+9 -9	+10 -10	+11.5 -11.5	+12.5 -12.5	+14.5 -14.5	+16.5 -16.5	+18.5 -18.5	+20.5 -20.5	+22.5 -22.5	+24.5 -24.5	+26.5 -26.5	+28.5 -28.5	+30.5 -30.5
js6	+4 -4	+4.5 -4.5	+5.5 -5.5	+6.5 -6.5	+8 -8	+9.5 -9.5	+11 -11	+12.5 -12.5	+14.5 -14.5	+16.5 -16.5	+18.5 -18.5	+20.5 -20.5	+22.5 -22.5	+24.5 -24.5	+26.5 -26.5	+28.5 -28.5	+30.5 -30.5	+32.5 -32.5	+34.5 -34.5	+36.5 -36.5
js7	+6 -6	+7.5 -7.5	+9 -9	+10.5 -10.5	+12.5 -12.5	+15 -15	+17.5 -17.5	+20 -20	+22.5 -22.5	+25 -25	+27.5 -27.5	+30 -30	+32.5 -32.5	+35 -35	+37.5 -37.5	+40 -40	+42.5 -42.5	+45 -45	+47.5 -47.5	+50 -50
k5	+6 +1	+7 +1	+9 +1	+11 +2	+13 +2	+15 +2	+18 +3	+21 +3	+24 +4	+27 +4	+30 +4	+33 +5	+36 +5	+39 +6	+42 +6	+45 +7	+48 +7	+51 +8	+54 +8	+57 +9
k6	+9 +1	+10 +1	+12 +1	+15 +2	+18 +2	+21 +2	+25 +3	+28 +3	+33 +4	+36 +4	+40 +5	+44 +5	+48 +6	+52 +6	+56 +7	+60 +7	+64 +8	+68 +8	+72 +9	+76 +9
k7	+13 +1	+16 +1	+19 +1	+23 +2	+27 +2	+32 +2	+38 +3	+43 +3	+50 +4	+56 +4	+63 +5	+70 +5	+78 +6	+86 +6	+94 +7	+102 +7	+110 +8	+118 +8	+126 +9	+134 +9
m5	+9 +4	+12 +6	+15 +7	+17 +8	+20 +9	+24 +11	+28 +13	+33 +15	+37 +17	+42 +19	+47 +21	+52 +23	+57 +25	+62 +27	+67 +29	+72 +31	+77 +33	+82 +35	+87 +37	+92 +39
m6	+12 +4	+15 +6	+18 +7	+21 +8	+25 +9	+30 +11	+35 +13	+40 +15	+46 +17	+52 +19	+58 +21	+64 +23	+70 +25	+76 +27	+82 +29	+88 +31	+94 +33	+100 +35	+106 +37	+112 +39
m7	+16 +4	+21 +6	+25 +7	+29 +8	+34 +9	+41 +11	+48 +13	+55 +15	+63 +17	+72 +19	+80 +21	+89 +23	+98 +25	+107 +27	+116 +29	+125 +31	+134 +33	+143 +35	+152 +37	+161 +39
n5	+13 +8	+16 +10	+20 +12	+24 +15	+28 +17	+33 +20	+38 +23	+45 +27	+51 +31	+57 +35	+63 +39	+70 +43	+77 +47	+84 +51	+91 +55	+98 +59	+105 +63	+112 +67	+119 +71	+126 +75
n6	+16 +8	+19 +10	+23 +12	+28 +15	+33 +17	+39 +20	+45 +23	+52 +27	+60 +31	+66 +35	+73 +39	+80 +43	+87 +47	+94 +51	+101 +55	+108 +59	+115 +63	+122 +67	+129 +71	+136 +75
n7	+20 +8	+25 +10	+30 +12	+36 +15	+42 +17	+50 +20	+58 +23	+67 +27	+77 +31	+86 +35	+95 +39	+104 +43	+113 +47	+122 +51	+131 +55	+140 +59	+149 +63	+158 +67	+167 +71	+176 +75
p5	+17 +12	+21 +15	+26 +18	+31 +22	+37 +26	+45 +32	+52 +37	+61 +43	+70 +50	+79 +56	+88 +62	+97 +69	+106 +75	+115 +81	+124 +87	+133 +93	+142 +99	+151 +105	+160 +111	+169 +117
p6	+20 +12	+24 +15	+29 +18	+35 +22	+42 +26	+51 +32	+59 +37	+68 +43	+79 +50	+88 +56	+98 +62	+107 +69	+116 +75	+125 +81	+134 +87	+143 +93	+152 +99	+161 +105	+170 +111	+179 +117
r6	+23 +15	+28 +19	+34 +23	+41 +28	+50 +34	+60 +41	+62 +43	+73 +51	+76 +54	+88 +63	+90 +65	+93 +68	+106 +77	+109 +80	+113 +84	+126 +94	+130 +98	+144 +108	+144 +108	+150 +114



DIN 2080

Code system Kodifizierung	I02
Technical information Technische Auskünfte	I03
Applications index Anwendungen	I04
Arbors and adaptors DIN 2080 Aufnahmen DIN 2080	I05-24
Special tool request Sonderwerkzeug-Anfrage	I25



Code system / Kodifizierung

10	160	30	16
1	2	3	4

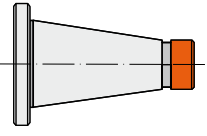
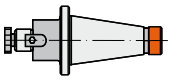
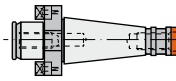
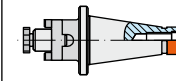
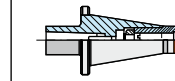
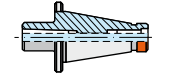
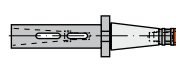
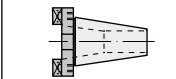
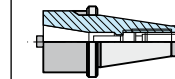
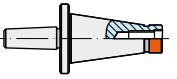
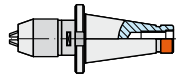
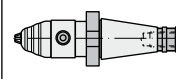
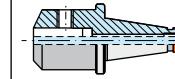
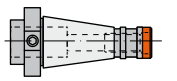
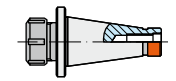
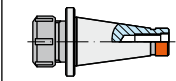
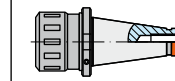
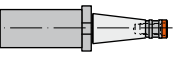
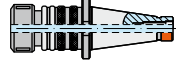
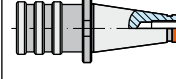
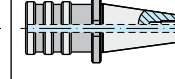
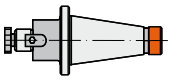
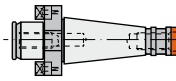
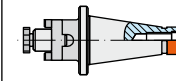
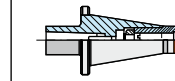
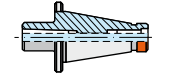
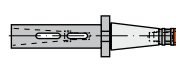
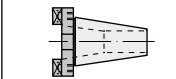
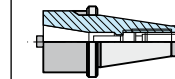
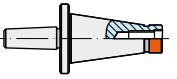
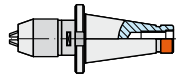
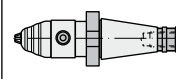
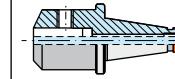
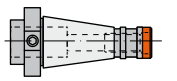
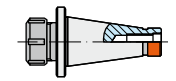
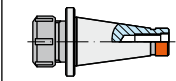
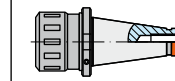
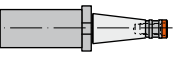
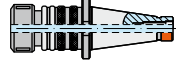
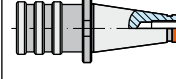
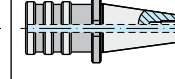
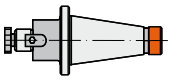
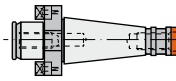
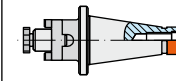
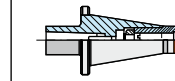
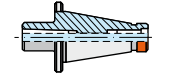
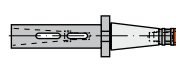
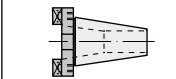
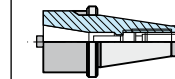
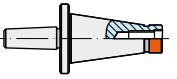
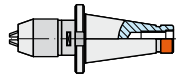
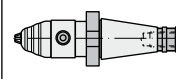
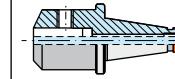
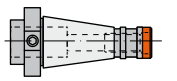
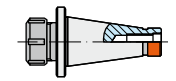
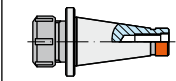
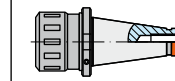
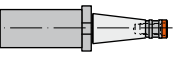
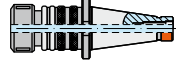
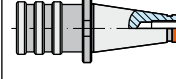
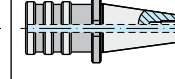
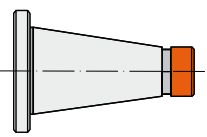
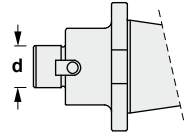
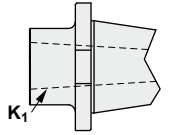
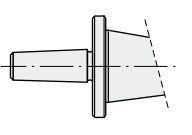
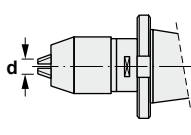
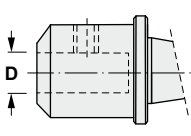
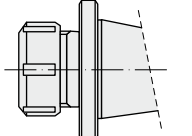
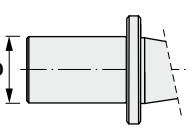
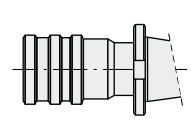
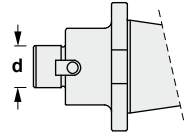
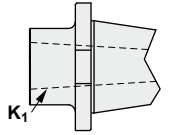
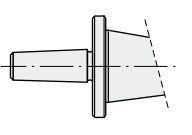
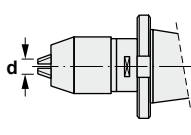
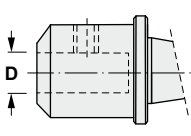
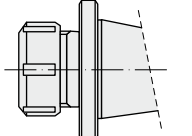
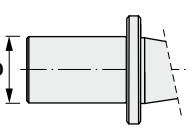
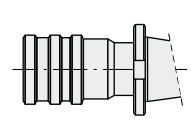
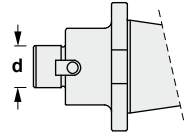
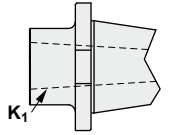
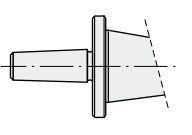
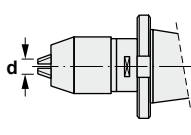
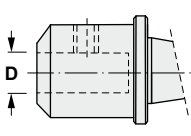
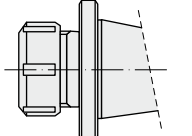
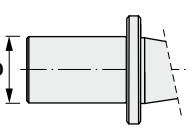
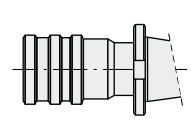
1 Model Modell  10 DIN 2080		2 Arbor type Aufnahmen-Typ <table border="1"> <tr> <td></td> <td></td> <td></td> <td></td> </tr> <tr> <td>160</td> <td>165</td> <td>180</td> <td>210</td> </tr> <tr> <td></td> <td></td> <td></td> <td></td> </tr> <tr> <td>215</td> <td>216</td> <td>220</td> <td>225</td> </tr> <tr> <td></td> <td></td> <td></td> <td></td> </tr> <tr> <td>290</td> <td>295</td> <td>296</td> <td>300</td> </tr> <tr> <td></td> <td></td> <td></td> <td></td> </tr> <tr> <td>302</td> <td>353</td> <td>453</td> <td>457</td> </tr> <tr> <td></td> <td></td> <td></td> <td></td> </tr> <tr> <td>470</td> <td>610</td> <td>620</td> <td>630</td> </tr> </table>																160	165	180	210					215	216	220	225					290	295	296	300					302	353	453	457					470	610	620	630
																																																					
160	165	180	210																																																		
																																																					
215	216	220	225																																																		
																																																					
290	295	296	300																																																		
																																																					
302	353	453	457																																																		
																																																					
470	610	620	630																																																		
3 Arbor size Aufnahmegröße ISO  DIN 2080 ISO 30 30 ISO 40 40 ISO 50 50																																																					
4 Adaptor size Adaptergröße <table border="1"> <tr> <td colspan="4">  K₁ - MORSE Ø 16 Ø 22 Ø 27 Ø 32 Ø 40 Ø 60 16 22 27 32 40 60 </td> <td colspan="4">  K₁ - ISO ISO 30 ISO 40 30 40 </td> <td colspan="3">  B12 B16 B18 12 16 18 </td> <td colspan="3">  Ø 8 Ø 13 Ø 16 8 13 16 </td> </tr> <tr> <td colspan="4">  Ø 6 ... Ø 50 6 ... 50 </td> <td colspan="4">  ER16 ER20 ER25 ER32 ER40 16 20 25 32 40 </td> <td colspan="3">  Ø 50 Ø 63 Ø 80 Ø 85 Ø 90 50 63 80 85 90 </td> <td colspan="3">  M3-M12 M4-M20 M8-M33 12 20 33 </td> </tr> </table>												 K ₁ - MORSE Ø 16 Ø 22 Ø 27 Ø 32 Ø 40 Ø 60 16 22 27 32 40 60				 K ₁ - ISO ISO 30 ISO 40 30 40				 B12 B16 B18 12 16 18			 Ø 8 Ø 13 Ø 16 8 13 16			 Ø 6 ... Ø 50 6 ... 50				 ER16 ER20 ER25 ER32 ER40 16 20 25 32 40				 Ø 50 Ø 63 Ø 80 Ø 85 Ø 90 50 63 80 85 90			 M3-M12 M4-M20 M8-M33 12 20 33																
 K ₁ - MORSE Ø 16 Ø 22 Ø 27 Ø 32 Ø 40 Ø 60 16 22 27 32 40 60				 K ₁ - ISO ISO 30 ISO 40 30 40				 B12 B16 B18 12 16 18			 Ø 8 Ø 13 Ø 16 8 13 16																																										
 Ø 6 ... Ø 50 6 ... 50				 ER16 ER20 ER25 ER32 ER40 16 20 25 32 40				 Ø 50 Ø 63 Ø 80 Ø 85 Ø 90 50 63 80 85 90			 M3-M12 M4-M20 M8-M33 12 20 33																																										

AT3 TECHNICAL CHARACTERISTICS OF THE TOOLHOLDERS AT3 TECHNISCHE EIGENSCHAFTEN DER AUFNAHMEN

MATERIAL:

- Chromium-manganese carburised steel 1.7131 (16MnCr5).

EXECUTION:

- Carburised, hardened and tempered.
- Surface hardness HRC 58±2 (670±40 HV30)
- Depth of carburised layer minimum 0,5 mm.
- Tensile strength in core minimum 800 N/mm2 after carburizing.

ACCURACY:

- Taper according to DIN 254
- Taper angle:
tolerance AT 3 DIN 7178 part 1 and DIN 2080 part 1.
- Other tolerances according to DIN 7160 and 7168.
- Taper surface roughness RZ<0,001 mm.

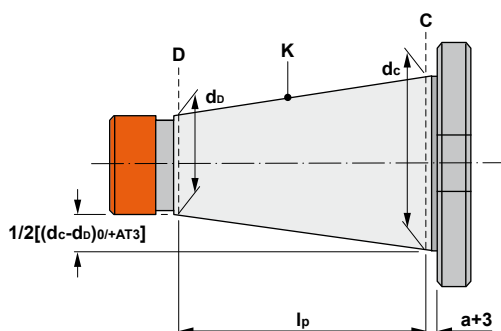

TOLERANCE AT:

- Indicates the tolerance of measuring plane D between the real and the theoretical value of the taper conicity.
- This value of measuring plane D must always be less (negative), never more (positive) in order to GUARANTEE a good toolholder fixation at the bigger taper diameter.

MATERIALIEN:

- Legierter aufgekohlter Stahl mit Chrom-Mangan 1.7131 (16MnCr5).

KONSTRUKTIONS DATEN:

- Aufgekühlt, gehärtet und angelassen.
- Oberflächenhärte HRC 58±2 (670±40 HV30)
- Aufgekühlt auf minimum 0,5 mm Tiefe.
- Zugfestigkeit im Kern minimum 800 N/mm2 nach der Aufkohlung.

GENAUIGKEIT:

- Dorn nach DIN 254
- Kegelminkel:
Toleranz AT 3 DIN 7178 Teil 1 und DIN 2080 Teil 1.
- Andere Toleranzen entsprechend DIN 7160 und 7168.
- Rauigkeit der Oberfläche RZ<0,001 mm.

K	AT3 mm
ISO 30	0,002
ISO 40	0,003
ISO 45	0,003
ISO 50	0,004
ISO 60	0,005

TOLERANZ AT:

- Zeigt die Toleranz auf der Messebene D zwischen dem tatsächlichen Wert der Kegelkonizität und dem theoretischen Wert.
- Dieser Wert auf der Messebene D sollte immer minus (negativ) sein, nie plus (positiv), um für einen guten Halt des Futter in den größeren Durchmesser des Kegels zu GARANTIEREN.

10 DIN 2080

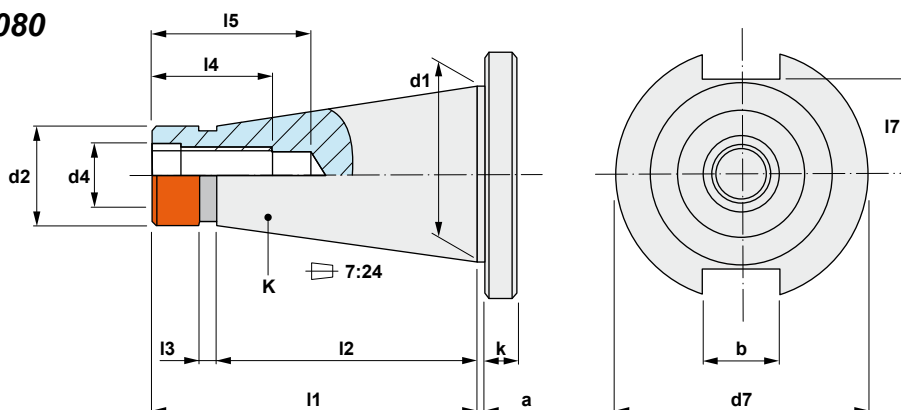

K	a ±0,2	b H12	d1	d2	d4	d7	k	l1	l2	l3	l4	l5 min	l7 max
30	1,6	16,1	31,75	17,4	M12	50,0	8	68,4	48,4	3	24	33,5	16,2
40	1,6	16,1	44,45	25,3	M16	63,0	10	93,4	65,4	5	32	42,5	22,5
45	3,2	19,3	57,15	32,4	M20	80,0	12	106,8	82,8	6	40	52,5	29,0
50	3,2	25,7	69,85	39,6	M24	97,5	12	126,8	101,8	8	47	61,5	35,3
60	3,2	25,7	107,95	60,2	M30	156,0	16	206,8	161,8	10	59	76,0	60,0

Arbors and adaptors DIN 2080
Aufnahmen DIN 2080

10.160



Page / Seite 105

10.165



Page / Seite 106

10.180



Page / Seite 107

10.210



Page / Seite 108

10.215



Page / Seite 109

10.216



Page / Seite 110

10.220



Page / Seite 111

10.225



Page / Seite 112

10.290



Page / Seite 113

10.295



Page / Seite 114

10.296



Page / Seite 115

10.300



Page / Seite 116

10.302



Page / Seite 117

10.353



Page / Seite 118

10.453



Page / Seite 119

10.457



Page / Seite 120

10.470



Page / Seite 121

10.610



Page / Seite 122

10.620



Page / Seite 123

10.630



Page / Seite 124







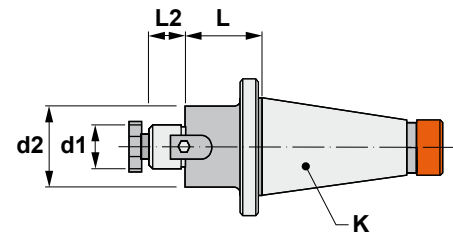

Characteristics:
Shell mill adaptor.
DIN 2080 / ISO 3937
For cutters with driving
slot DIN 138.

Eigenschaften:
Aufsteckfräsdorne.
DIN 2080 / ISO 3937
Für Fräser mit Quernut DIN 138.



10.160

Reference Bezeichnung	K ISO	d1 h6	L	L2	d2				
10.160.30.16	30	16	30	17	38	10008	86016	11103	0,480
10.160.30.22	30	22	30	19	48	10010	86022	11004	0,570
10.160.30.27	30	27	30	21	58	10012	86027	11005	0,700
10.160.30.32	30	32	35	24	78	10016	86032	11105	0,840
10.160.40.16	40	16	30	17	38	10008	86016	11103	0,950
10.160.40.16/100	40	16	100	17	38	10008	86016	11103	1,370
10.160.40.22	40	22	30	19	48	10010	86022	11004	1,040
10.160.40.22/100	40	22	100	19	48	10010	86022	11004	1,830
10.160.40.27	40	27	30	21	58	10012	86027	11005	1,160
10.160.40.27/100	40	27	100	21	58	10012	86027	11005	2,310
10.160.40.32	40	32	35	24	63	10016	86032	11105	1,320
10.160.40.32/125	40	32	125	24	63	10016	86032	11105	3,134
10.160.40.40	40	40	40	27	73	10020	86040	11006	1,620
10.160.50.16	50	16	35	17	38	10008	86016	11103	2,840
10.160.50.16/150	50	16	150	17	38	10008	86016	11103	3,600
10.160.50.22	50	22	35	19	48	10010	86022	11004	2,950
10.160.50.22/150	50	22	150	19	48	10010	86022	11004	4,270
10.160.50.27	50	27	35	21	58	10012	86027	11005	3,070
10.160.50.27/150	50	27	150	21	58	10012	86027	11005	5,070
10.160.50.32	50	32	40	24	63	10016	86032	11105	3,230
10.160.50.32/150	50	32	150	24	63	10016	86032	11105	6,370
10.160.50.40	50	40	40	27	73	10020	86040	11006	3,990
10.160.50.40/150	50	40	150	27	73	10020	86040	11006	7,190
10.160.50.50	50	50	40	30	90	10024	86050	11008	3,990



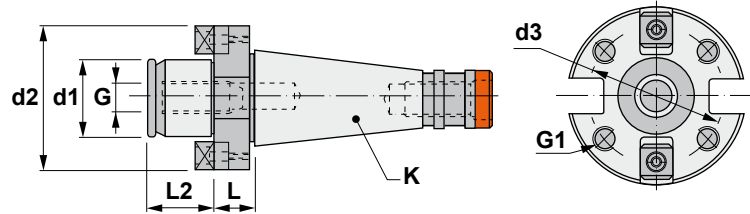

Characteristics:
Adaptor for indexable milling cutters.
DIN 2080 / DIN 6357 - Form A

Eigenschaften:
Zwischenhülsen für Fräser.
DIN 2080 / DIN 6357 - Form A



10.165

Reference Bezeichnung	K ISO	d1 g5	L	d2	d3	G	G1	L2	
10.165.40.40	40	40	20	89	66,7	M-20	M-12	30	1,410
10.165.50.40	50	40	30	89	66,7	M-20	M-12	30	3,430
10.165.50.60	50	60	30	129	101,6	M-30	M-16	40	4,210

Reference Bezeichnung	2x 	2x 
10.165.40.40	80040	11006
10.165.50.40	80040	11006
10.165.50.60	80060	11012

**Characteristics:**



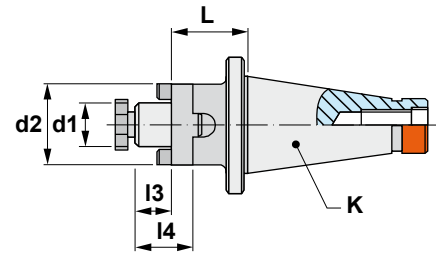

Combi-Shell mill adaptor.
DIN 2080 / DIN 6358 - Form A
For cutters with keyway or driving slot DIN 138.

Eigenschaften:

Kombi-Aufsteckfräsdorne
DIN 2080 / DIN 6358 - Form A
Für Fräser mit Längsnut
oder Stirnmitnehmer DIN 138.



10.180

Reference Bezeichnung	K ISO	d1 h6	L	I3	I4	d2				
10.180.30.16	30	16	35	17	27	32	10008	60116	88016	0,560
10.180.30.22	30	22	35	19	31	40	10010	60122	88022	0,690
10.180.30.27	30	27	35	21	33	48	10012	60127	88027	0,830
10.180.30.32	30	32	50	24	38	58	10016	60132	88032	1,360
10.180.40.16	40	16	52	17	27	32	10008	60116	88016	1,130
10.180.40.16/125	40	16	125	17	27	32	10008	60116	88016	1,670
10.180.40.22	40	22	52	19	31	40	10010	60122	88022	1,310
10.180.40.22/125	40	22	125	19	31	40	10010	60122	88022	2,250
10.180.40.27	40	27	52	21	33	48	10012	60127	88027	1,530
10.180.40.27/125	40	27	125	21	33	48	10012	60127	88027	2,930
10.180.40.32	40	32	52	24	38	58	10016	60132	88032	1,840
10.180.40.32/125	40	32	125	24	38	58	10016	60132	88032	3,390
10.180.40.40	40	40	52	27	41	70	10020	60140	88040	2,430
10.180.50.16	50	16	55	17	27	32	10008	60116	88016	3,120
10.180.50.16/125	50	16	125	17	27	32	10008	60116	88016	3,650
10.180.50.22	50	22	55	19	31	40	10010	60122	88022	3,340
10.180.50.22/125	50	22	125	19	31	40	10010	60122	88022	3,650
10.180.50.22/200	50	22	200	19	31	40	10010	60122	88022	5,130
10.180.50.27	50	27	55	21	33	48	10012	60127	88027	3,520
10.180.50.27/125	50	27	125	21	33	48	10012	60127	88027	4,860
10.180.50.27/200	50	27	200	21	33	48	10012	60127	88027	6,220
10.180.50.32	50	32	55	24	38	58	10016	60132	88032	3,830
10.180.50.32/125	50	32	125	24	38	58	10016	60132	88032	5,980
10.180.50.32/200	50	32	200	24	38	58	10016	60132	88032	8,280
10.180.50.40	50	40	55	27	41	70	10020	60140	88040	4,420
10.180.50.40/125	50	40	125	27	41	70	10020	60140	88040	6,770
10.180.50.50	50	50	55	30	46	90	10024	60150	88050	4,400





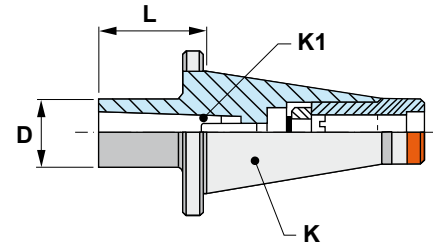

Characteristics:
Reducing adaptors.
DIN 2080 / DIN 6364 - Form A ISO 5415
For tools with Morse taper shank and
drawbar thread DIN 228-A.

Eigenschaften:
Reduzierhülsen.
DIN 2080 / DIN 6364 - Form A ISO 5415
Für Werkzeuge mit Morsekegel und
Anzugsgewinde DIN 228-A.



10.210

Reference Bezeichnung	K ISO	K1 MORSE	L	D	
10.210.30.01	30	1	50	25	0,480
10.210.30.02	30	2	50	32	0,570
10.210.30.03	30	3	76	40	0,750
10.210.40.01	40	1	50	25	0,940
10.210.40.02	40	2	50	32	0,940
10.210.40.03	40	3	65	40	1,110
10.210.40.04	40	4	95	48	1,520
10.210.50.01	50	1	60	25	2,940
10.210.50.02	50	2	60	32	2,960
10.210.50.03	50	3	65	40	3,020
10.210.50.04	50	4	65	48	3,070
10.210.50.05	50	5	100	63	3,540

Reference Bezeichnung			
10.210.30.01	16004	19312	11406
10.210.30.02	16005	19315	12110
10.210.30.03	16005	19318	12012
10.210.40.01	16105	19516	11506
10.210.40.02	16205	19416	12110
10.210.40.03	16205	19420	11312
10.210.40.04	16205	19322	12016
10.210.50.01	16205	19624	11206
10.210.50.02	16205	19324	11210
10.210.50.03	16205	19524	11512
10.210.50.04	16205	19424	12016
10.210.50.05	16205	19338	11020

**Characteristics:**

Reducing adaptors.
DIN 2080 / DIN 6383 - ISO 4202
For tools with Morse taper shank
and tang according to DIN 228-B.

Eigenschaften:

Reduzierhülsen.
DIN 2080 / DIN 6383 - ISO 4202
Für Werkzeuge mit Morsekegel
und Austreiblappen nach DIN
228-B.

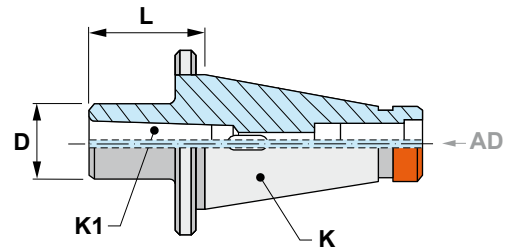

10.215

Reference Bezeichnung	K ISO	K1 MORSE	L	D	
10.215.30.01	30	1	50	25	0,470
10.215.30.02	30	2	50	32	0,490
10.215.30.03	30	3	76	40	0,720
10.215.40.01	40	1	50	25	0,870
10.215.40.02	40	2	50	32	0,900
10.215.40.03	40	3	65	40	1,050
10.215.40.04	40	4	95	48	1,380
10.215.50.01	50	1	45	25	2,790
10.215.50.02	50	2	60	32	2,890
10.215.50.03	50	3	65	40	2,920
10.215.50.04	50	4	70	48	2,940
10.215.50.05	50	5	105	63	3,370



Characteristics:

Long reducing adaptors. DIN 2080 For tools with Morse taper shank and tang according to DIN 228-B.

Eigenschaften:

Lange Reduzierhülsen. DIN 2080 Für Werkzeuge mit Morsekegel und Austreiblappen nach DIN 228-B.

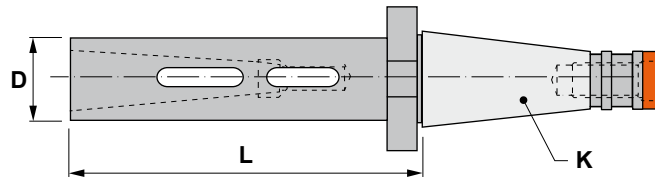

10.216

Reference Bezeichnung	K ISO	K1 MORSE	L	D	
10.216.40.02	40	2	110	32	1,320
10.216.40.03	40	3	135	40	1,720
10.216.40.04	40	4	160	48	2,240
10.216.50.02	50	2	115	32	3,290
10.216.50.03	50	3	140	40	3,740
10.216.50.04	50	4	165	48	4,270
10.216.50.05	50	5	215	63	6,000



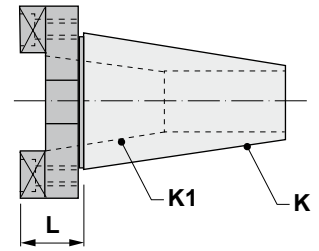

Characteristics:
Reducing adaptors.
DIN 2080
For tools with DIN 2080 ISO
taper shank.

Eigenschaften:
Reduzierhülsen.
DIN 2080
Für Werkzeuge mit DIN 2080
ISO Kegel.



10.220

Reference Bezeichnung	K ISO	K1 ISO	L	
10.220.40.30	40	30	19	0,740
10.220.50.30	50	30	23	2,580
10.220.50.40	50	40	23	2,470

Reference Bezeichnung	2x 	2x 
10.220.40.30	80440	11006
10.220.50.30	80440	11006
10.220.50.40	80440	11006





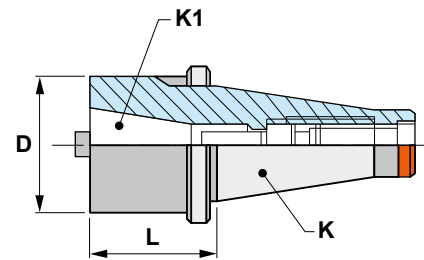

Characteristics:
Reducing adaptors.
DIN 2080
For tools with DIN 2080 ISO
taper shank.

Eigenschaften:
Reduzierhülsen.
DIN 2080
Für Werkzeuge mit DIN 2080
ISO Kegel.



10.225

Reference Bezeichnung	K ISO	K1 ISO	L	D	
10.225.40.30	40	30	50	50	1,190
10.225.50.30	50	30	50	50	3,050
10.225.50.40	50	40	50	63	3,140

Reference Bezeichnung			
10.225.40.30	16205	19420	11312
10.225.50.30	16205	19524	11512
10.225.50.40	16205	19424	12016

**Characteristics:**

Drill chuck adaptors.
DIN 2080
For drill chucks with DIN 238 taper.

Eigenschaften:

Bohrfutteraufnahmen.
DIN 2080
Für Bohrfutter mit DIN 238 Kegel.

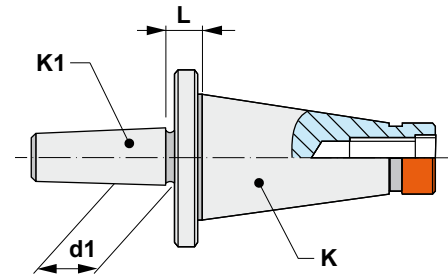

10.290

Reference Bezeichnung	K ISO	K1 DIN 238	L	d1	 Kg
10.290.30.12	30	B-12	15	12,065	0,390
10.290.30.16	30	B-16	15	15,733	0,380
10.290.30.18	30	B-18	15	17,437	0,360
10.290.40.12	40	B-12	17	12,065	0,860
10.290.40.16	40	B-16	17	15,733	0,880
10.290.40.18	40	B-18	17	17,437	0,890
10.290.50.16	50	B-16	20	15,733	2,880
10.290.50.18	50	B-18	20	17,437	2,920

MU

 I199

Ref. / Bez.	Accessories / Zubehör
MU	Standard keyless drill chucks DIN 238 Standard Schnellspann-Bohrfutter DIN 238



MP

 I200

Ref. / Bez.	Accessories / Zubehör
MP	Super precision keyless drill chucks DIN 238 Höchst-Genauigkeit-Selbstspannbohrfutter DIN 238



MK

 I201

Ref. / Bez.	Accessories / Zubehör
MK	Super precision keyless drill chucks DIN 238 with gripping tongue Höchst-Genauigkeit-Selbstspannbohrfutter DIN 238 mit Schlüsselflächen





Characteristics:
Self clamping short precision
drill chucks.
DIN 2080
For right turn only.

*** SUPPLIED WITH WRENCH**

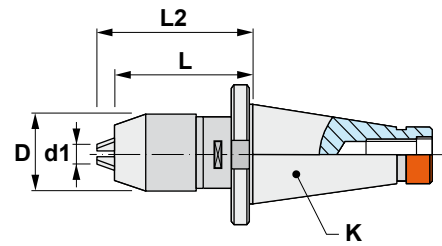

Eigenschaften:
Selbstspann-Kurzbohrfutter,
Genauigkeitsausführung.
DIN 2080
Nur für rechtslaufende Bearbeitungen.

*** LIEFERUNG MIT SCHLÜSSEL**



10.295

Reference Bezeichnung	K ISO	d1	D	L	L2 max	
10.295.30.08	30	0,3-8	38	70	76	1,000
10.295.40.08	40	0,3-8	38	63	69	1,400
10.295.40.13	40	1-13	48	78	89	1,700
10.295.40.16	40	3-16	55	90	101	2,100
10.295.50.13	50	1-13	48	71	101	3,600
10.295.50.16	50	3-16	55	72	83	3,750

Reference Bezeichnung		
10.295.30.08	50008	11206
10.295.40.08	50008	11206
10.295.40.13	50013	11108
10.295.40.16	50016	11108
10.295.50.13	50013	11108
10.295.50.16	50016	11108



Characteristics:
CNC-Universal precision
drill chucks.
DIN 2080
For left and right hand turn.

*** SUPPLIED WITH WRENCH**

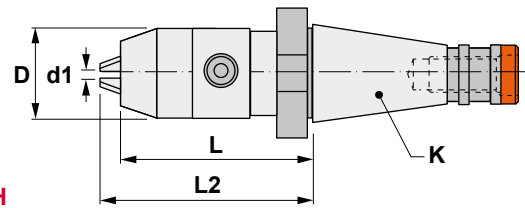

Eigenschaften:
CNC-Universal Bohrfutter,
Genauigkeitausführung.
DIN 2080
Für links- und rechtslaufende
Bearbeitungen.

*** LIEFERUNG MIT SCHLÜSSEL**



10.296

Reference Bezeichnung	K ISO	d1	D	L	L2 max	
10.296.40.13	40	1-13	54	82	91	1,840
10.296.40.16	40	3-16	57	85	92	2,000
10.296.50.13	50	1-13	54	85	94	3,320
10.296.50.16	50	3-16	57	88	95	3,420

Reference Bezeichnung		3x 
10.296.40.13	5006	60313
10.296.40.16	5006	60313
10.296.50.13	5006	60313
10.296.50.16	5006	60313





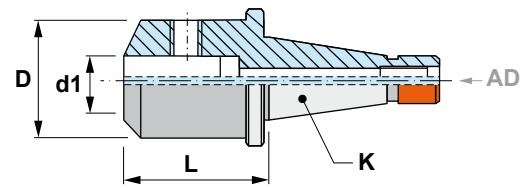

Characteristics:
Weldon end mill adaptor.
DIN 2080 / DIN 6359
Form A ISO 5414
For cutters with cylindrical shank and Weldon flat DIN 1835-B.



Eigenschaften:
Zylinderschaft-Aufnahme Weldon.
DIN 2080 / DIN 6359
Form A ISO 5414
Für Fräser mit zylindrischem Schaft und Weldon-Fläche DIN 1835-B.

10.300

Reference Bezeichnung	K ISO	d1 h4	L	D		
10.300.30.06	30	6	40	25	15106	0,410
10.300.30.08	30	8	40	28	15108	0,430
10.300.30.10	30	10	40	35	15110	0,500
10.300.30.12	30	12	40	42	15212	0,560
10.300.30.14	30	14	40	44	15212	0,580
10.300.30.16	30	16	50	48	15314	0,750
10.300.30.18	30	18	50	50	15314	0,760
10.300.40.06	40	6	50	25	15106	0,880
10.300.40.08	40	8	50	28	15108	0,950
10.300.40.10	40	10	50	35	15110	1,010
10.300.40.12	40	12	50	42	15212	1,110
10.300.40.14	40	14	63	44	15212	1,290
10.300.40.16	40	16	63	48	15314	1,370
10.300.40.18	40	18	63	50	15314	1,400
10.300.40.20	40	20	63	52	15216	1,410
10.300.40.25	40	25	80	65	2 x 15218	2,180
10.300.40.32	40	32	80	72	2 x 15220	2,550
10.300.40.40	40	40	102	90	2 x 15220	4,120
10.300.50.06	50	6	63	25	15106	2,850
10.300.50.08	50	8	63	28	15108	2,890
10.300.50.10	50	10	63	35	15110	2,940
10.300.50.12	50	12	63	42	15212	3,140
10.300.50.14	50	14	63	44	15212	3,130
10.300.50.16	50	16	63	48	15314	3,180
10.300.50.18	50	18	63	50	15314	3,220
10.300.50.20	50	20	63	52	15216	3,270
10.300.50.25	50	25	80	65	2 x 15218	3,980
10.300.50.32	50	32	80	72	2 x 15220	4,210
10.300.50.40	50	40	90	90	2 x 15220	5,310
10.300.50.50	50	50	100	98	2 x 15024	6,060

42.300

 1182

Ref. / Bez. Accessories / Zubehör

42.300 Short and long reducing bushings DIN 1835-B Form A and B
Kurze und lange Reduzierhülsen DIN 1835-B Form A und B



**Characteristics:**

Short end mill adaptor.

DIN 2080

For cutters and tooling with cylindrical shank and Weldon flat DIN 1835-B.

Eigenschaften:



Kurze Aufsteckfräsdorne.

DIN 2080

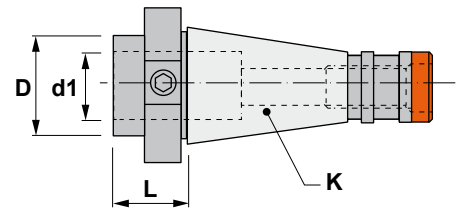
Für Fräser und Werkzeuge mit zylindrischem Schaft und Weldon-Fläche DIN 1835-B.



10.302

Reference Bezeichnung	K ISO	d1 h4	L	D		
10.302.30.16	30	16	20	32	15114	0,400
10.302.30.20	30	20	34	36	15014	0,390
10.302.40.16	40	16	22	44	15214	0,850
10.302.40.20	40	20	22	44	15116	0,800
10.302.40.25	40	25	22	44	15016	0,710
10.302.50.16	50	16	16	-	15314	2,710
10.302.50.20	50	20	16	-	15216	2,640
10.302.50.25	50	25	16	-	15118 + 15218	2,540
10.302.50.32	50	32	16	-	15020 + 15120	2,330

42.610

 I183

Ref. / Bez.

Accessories / Zubehör

42.610

Tapping head with axial compensation DIN 1835-B

Gewindeschneidfutter mit Längenausgleich DIN 1835-B



42.620

 I184

Ref. / Bez.

Accessories / Zubehör

42.620

Quick change tapping head with axial compensation DIN 1835-B+E

Gewindeschneid-Schnellwechselfutter mit Längenausgleich DIN 1835-B + E





Characteristics:
Collet chucks for DIN 6388 collets.
DIN 2080
For tools with cylindrical shank
DIN 1835-B.
* Ball bearing nut, see page: I220

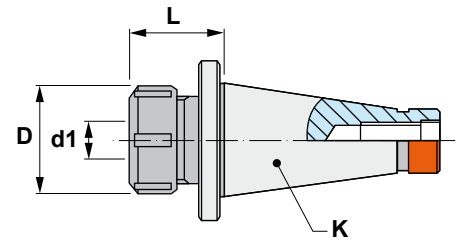





*** SUPPLIED WITHOUT WRENCH**

Eigenschaften:
Spannzangenfutter für Spannzangen DIN 6388.
DIN 2080
Für Werkzeuge mit zylindrischem Schaft DIN 1835-B.
* Für Kugellager-Mutter, siehe Seite: I220

*** LIEFERUNG OHNE SCHLÜSSEL**

10.353

Reference Bezeichnung	K ISO	L	d1	D				
10.353.30.16	30	43	2-16	43	43316	50116	19216	0,490
10.353.30.25	30	70	3-25	60	43325	50125	19216	0,880
10.353.40.16	40	50	2-16	43	43316	50116	19216	0,970
10.353.40.25	40	63	3-25	60	43325	50125	19224	1,200
10.353.40.32	40	90	4-32	72	43332	50132	19224	1,840
10.353.50.25	50	63	3-25	60	43325	50125	19224	2,660
10.353.50.32	50	70	4-32	72	43332	50132	19230	3,330

BXX

 I206-208

Ref. / Bez.	Accessories / Zubehör
BXX	Collets with double slot DIN 6388 - Form B Spannzangen mit Doppelnut DIN 6388 - Form B



**Characteristics:**

Collet chucks for DIN 6499 (ER) collets.
DIN 2080
For tools with cylindrical shank.

* Ball bearing nut, see page: I221

*** SUPPLIED WITHOUT WRENCH**

Eigenschaften:



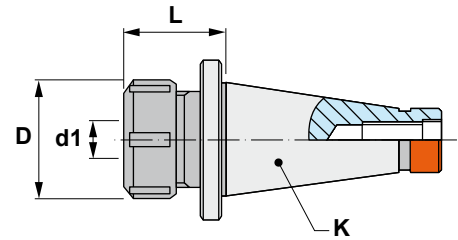

Spannzangenfutter für Spannzangen
DIN 6499 (ER).
DIN 2080
Für Werkzeuge mit zylindrischem Schaft.

* Für Kugellager-Mutter, siehe Seite: I221

*** LIEFERUNG OHNE SCHLÜSSEL**



10.453

Reference Bezeichnung	K ISO		L	d1	D	D1				
10.453.30.16	30	ER16	35	0,5-10	32	-	45316	50216	19210	0,329
10.453.30.20	30	ER20	38	1-13	35	-	45320	50220	19212	0,324
10.453.30.25	30	ER25	42	1-16	42	-	45325	50225	19216	0,480
10.453.30.32	30	ER32	50	2-20	50	-	45332	50232	19218	0,520
10.453.40.25	40	ER25	44	1-16	42	-	45325	50225	19216	0,920
10.453.40.32	40	ER32	48	2-20	50	-	45332	50232	19218	0,950
10.453.40.32/070	40	ER32	70	2-20	50	-	45332	50232	19218	1,140
10.453.40.32/100	40	ER32	100	2-20	50	50	45332	50232	19218	1,506
10.453.40.32/150	40	ER32	150	2-20	50	50	45332	50232	19218	2,050
10.453.40.40	40	ER40	51	3-30	63	-	45340	50240	19224	1,070
10.453.40.40/100	40	ER40	100	3-30	63	63	45340	50240	19224	1,400
10.453.50.25	50	ER25	46	1-16	42	-	45325	50225	19216	2,870
10.453.50.25/150	50	ER25	150	1-16	42	42	45325	50225	19216	3,600
10.453.50.32	50	ER32	60	2-20	50	-	45332	50232	19218	2,960
10.453.50.32/100	50	ER32	100	2-20	50	50	45332	50232	19218	3,080
10.453.50.32/150	50	ER32	150	2-20	50	50	45332	50232	19218	3,920
10.453.50.40	50	ER40	60	3-30	63	-	45340	50240	19224	3,120
10.453.50.40/150	50	ER40	150	3-30	63	63	45340	50240	19224	4,530
10.453.50.50	50	ER50	65	6-34	78	-	45350	50250	19230	3,270

ERXX

 I210-212

Reference / Bezeichnung

ERXX

**40.453..**

 I180

Reference / Bezeichnung

40.453..

**ERCXX**

 I215-216

Reference / Bezeichnung

ERCXX

**40.455..**

 I181

Reference / Bezeichnung

40.455..

**ERTXX**

 I217-218

Reference / Bezeichnung

ERTXX





Characteristics:
Mechanical collet chucks with high tightening torque and precision.
DIN 2080
For DIN 6499 (ER) collets.

The alternative to hydraulic or other systems.
With central coolant supply.

*** SUPPLIED WITH WRENCH**

Eigenschaften:
Mechanisches Spannzangenfutter mit hohem Anzugsmoment.
DIN 2080.
Für Spannzangen DIN 6499 (ER).

Die Alternative zu hydraulischen und anderen Systemen.
Mit Innenkühlung.

*** LIEFERUNG MIT SCHLÜSSEL**

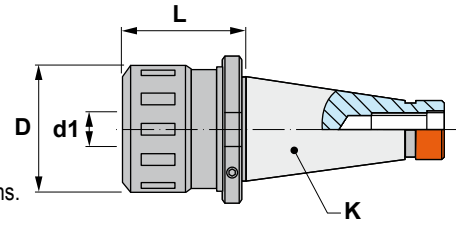

10.457

Reference Bezeichnung	K ISO		L	d1	D				
10.457.40.32	40	ER32	80	2-20	54	45732	50704	19006	1,620
10.457.50.32	50	ER32	85	2-20	54	45732	50704	19006	3,630
10.457.50.40	50	ER40	97	3-30	65	45740	50706	19010	4,570

ERXX

 I210-212

Ref. / Bez. Accessories / Zubehör

ERXX Collets with double slot DIN 6499 - Form B (ER)
Spannzangen mit Doppelnut DIN 6499 - Form B (ER)



ERCXX

 I215-216

Ref. / Bez. Accessories / Zubehör

ERCXX Sealed collets DIN 6499 (ER)
Abgedichtete Spannzangen DIN 6499 (ER)





Characteristics:
Blank adaptors.

Eigenschaften:
Rohlinge mit
weichem Schaft.

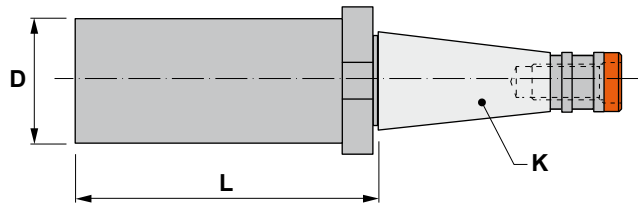

10.470

Reference Bezeichnung	K ISO	D	L	 Kg
10.470.30.40	30	40,5	160	1,920
10.470.40.63/250	40	63,5	250	6,760
10.470.50.95/315	50	95,5	315	18,470



Characteristics:

Tapping head with axial compensation.
DIN 2080
With DIN 6499 (ER) collets and central coolant supply.
Compensation in compression (C) and tension (T).
Compression can be blocked by turning the rear ring (A).
Control of threading depth.

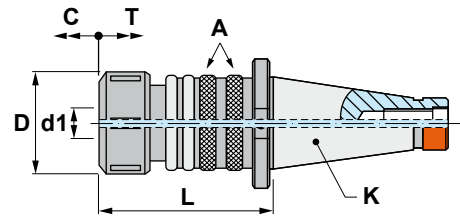





*** SUPPLIED WITH WRENCH**

Eigenschaften:

Gewindeschneidfutter mit Längenausgleich DIN 2080.
Befestigung mit Spannzangen 6499 (ER) und mit Innenkühlung.
Ausgleich der Kompression (C) und der Traktion (T).
Die Kompression kann mit dem Ring (A) blockiert werden.
Kontrolle der Gewindetiefe.

*** LIEFERUNG MIT SCHLÜSSEL**

10.610

Reference Bezeichnung	K ISO			d1	L	D	C	T			
10.610.30.16	30	ER16	M3-M12	100,5	28	5,5	6,0	45316	50216	0,900	
10.610.40.16	40	ER16	M3-M12	88,5	28	5,5	6,0	45316	50216	1,300	
10.610.40.25	40	ER25	M4-M20	112,0	42	10,5	7,5	45325	50225	1,850	
10.610.40.40	40	ER40	M8-M33	128,0	63	10,0	10,0	45340	50240	3,050	
10.610.50.16	50	ER16	M3-M12	82,5	28	5,5	6,0	45316	50216	3,100	
10.610.50.25	50	ER25	M4-M20	106,0	42	10,5	7,5	45325	50225	3,650	
10.610.50.40	50	ER40	M8-M33	122,0	63	10,0	10,0	45340	50240	4,850	

ERXX

 I210-212

Ref. / Bez. Accessories / Zubehör

ERXX Collets with double slot DIN 6499 - Form B (ER)
Spannzangen mit Doppelnut DIN 6499 - Form B (ER)



ERCXX

 I215-216

Ref. / Bez. Accessories / Zubehör

ERCXX Sealed collets DIN 6499 (ER)
Abgedichtete Spannzangen DIN 6499 (ER)



ERTXX

 I217-218

Ref. / Bez. Accessories / Zubehör

ERTXX Collets DIN 6499 - Form Mexin (ER)
Spannzangen DIN 6499 - Form Mexin (ER)



40.453..

 I180

Ref. / Bez. Accessories / Zubehör

40.453.. Collet chucks for DIN 6499 (ER) collets
Spannzangenfutter für DIN 6499 (ER) Spannzangen



40.455..

 I181

Ref. / Bez. Accessories / Zubehör

40.455.. Long collet chucks for DIN 6499 (ER) collets
Lange Spannzangenfutter für DIN 6499 (ER) Spannzangen



**Characteristics:**

Quick change tapping head with axial compensation. DIN 2080
With Bilz system tap chucks bushings.

Compensation in compression (C) and tension (T).



Eigenschaften:

Gewindeschneid-Schnellwechselfutter mit Längenausgleich. DIN 2080
Mit Schnellwechseleinsätzen Bilz-System.

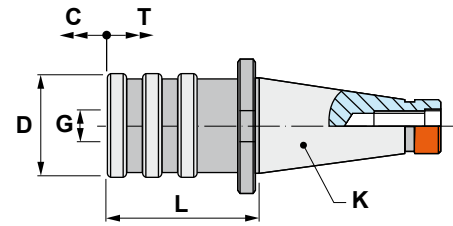
Ausgleich der Kompression (C) und der Traktion (T).



10.620

Reference Bezeichnung	K ISO	N ^G Ø	d1	L	D	C	T			
10.620.30.12	30	1 19	M3-M12	41	38	9	9	710XX	750XX	0,580
10.620.40.12	40	1 19	M3-M12	52	38	9	9	710XX	750XX	1,070
10.620.40.20	40	2 31	M8-M20	77	55	15	15	720XX	760XX	1,460
10.620.40.33	40	3 48	M14-M33	97	79	24	24	730XX	770XX	3,500
10.620.50.12	50	1 19	M3-M12	41	38	9	9	710XX	750XX	4,600
10.620.50.20	50	2 31	M8-M20	79	55	15	15	720XX	760XX	4,600
10.620.50.33	50	3 48	M14-M33	125	79	24	24	730XX	770XX	5,090

710XX..730XX

 I202

Ref. / Bez.

Accessories / Zubehör

710XX..730XX

Quick change adapters without overload clutch
Schnellwechseleinsätze ohne Sicherheitskupplung



750XX..770XX

 I203

Ref. / Bez.

Accessories / Zubehör

750XX..770XX

Quick change adapters with overload clutch
Schnellwechseleinsätze mit Sicherheitskupplung





Characteristics:
Quick change tapping head for rigid tapping.
With Bilz system tap chucks bushings.

With inner coolant.

Eigenschaften:
Gewindeschneid-Schnellwechselfutter ohne Längenausgleich.
Mit Schnellwechseleinsätzen Bilz-System.

Mit Innenkühlung.

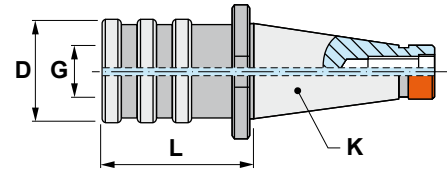

10.630

Reference Bezeichnung	K ISO	N ^G N° Ø		L	D			
10.630.30.12	30	1 19	M3-M12	50	33	710XX	750XX	1,000
10.630.40.12	40	1 19	M3-M12	52	33	710XX	750XX	1,000
10.630.40.20	40	2 31	M8-M20	74	50	720XX	760XX	1,500
10.630.40.33	40	3 48	M14-M33	115	72	730XX	770XX	3,500
10.630.50.12	50	1 19	M3-M12	55	33	710XX	750XX	4,600
10.630.50.20	50	2 31	M8-M20	78	50	720XX	760XX	4,600
10.630.50.33	50	3 48	M14-M33	83	72	730XX	770XX	5,500

710XX..730XX

i I202

Ref. / Bez.

Accessories / Zubehör

710XX..730XX

Quick change adapters without overload clutch
Schnellwechseleinsätze ohne Sicherheitskupplung



750XX..770XX

i I203

Ref. / Bez.

Accessories / Zubehör

750XX..770XX

Quick change adapters with overload clutch
Schnellwechseleinsätze mit Sicherheitskupplung



1 TYPE / TYP

10.160	10.165	10.180	10.210	10.215
10.216	10.220	10.225	10.290	10.295
10.296	10.300	10.302	10.353	10.453
10.457	10.470	10.610	10.620	10.630

2 DIMENSION / ABMESSUNGEN

30	40	50	60
-----------	-----------	-----------	-----------

3 LENGTH / LÄNGE (L)

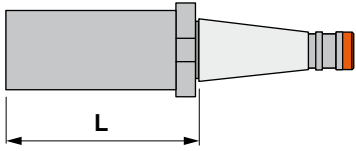
	<hr/> <hr/> <hr/> <hr/> <hr/>
---	-------------------------------

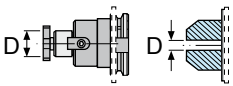
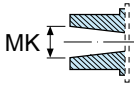
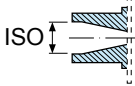
<p>Ø DIAMETER / DURCHMESSER</p> 	<p>MK</p> 	<p>ISO</p> 	<p>COLLET SPANNZANGEN</p>

NOTES / BEMERKUNGEN: _____







DIN 69871-A

Code system Kodifizierung	128
Technical information Technische Auskünfte	129
Applications index Anwendungen	130-31
Arbors and adaptors DIN 69871-A Aufnahmen DIN 69871-A	132-75
Antivibratory adaptors DIN 69871-A Schwingungsgedämpfte Aufnahmen DIN 69871-A	135-37,60
Sets Sätze	163
Special tool request Sonderwerkzeug-Anfrage	176



Code system / Kodifizierung

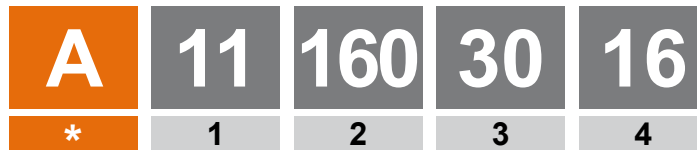

* Antivibratory adaptors
Schwingungsgedämpfte Aufnahmen

1 Model Modell

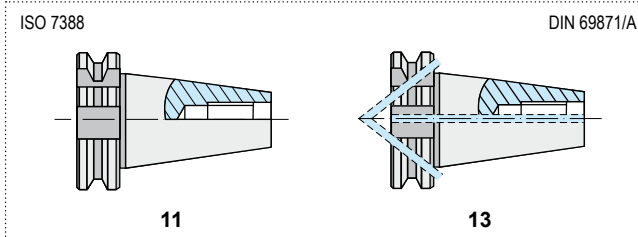

3 Arbor size Aufnahmegröße

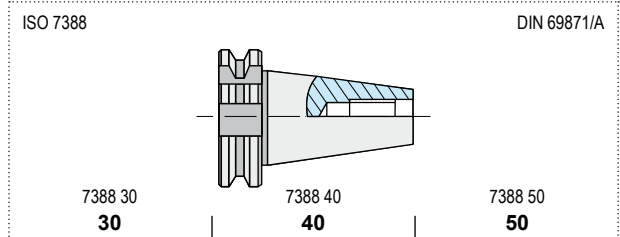

2 Arbor type Aufnahmen-Typ

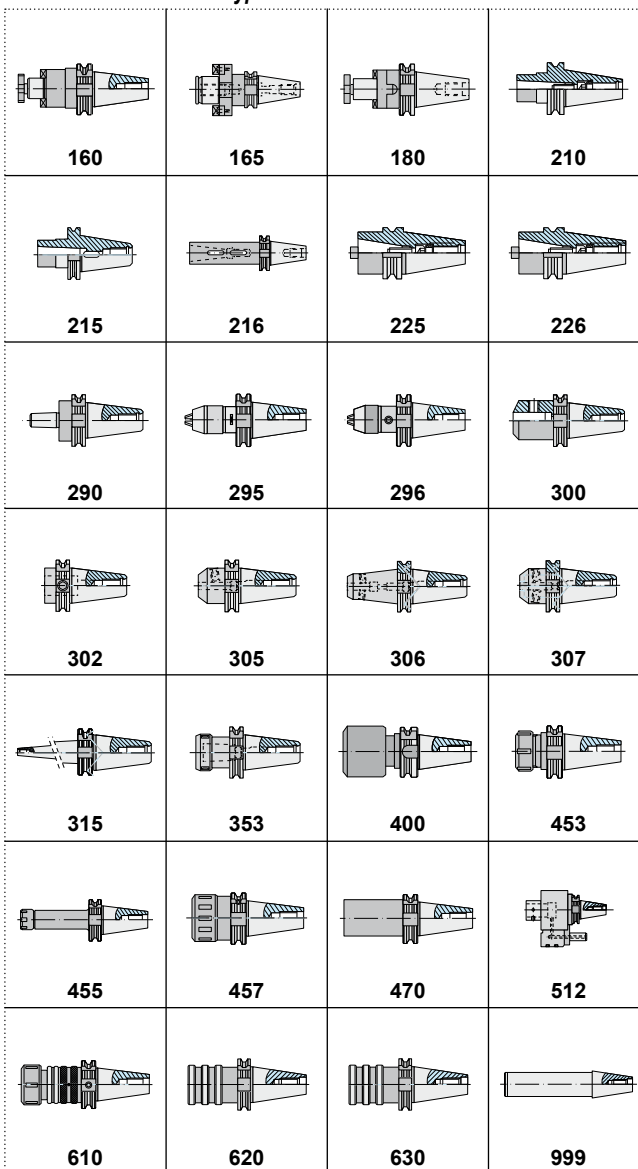

4 Adaptor size Adaptergröße

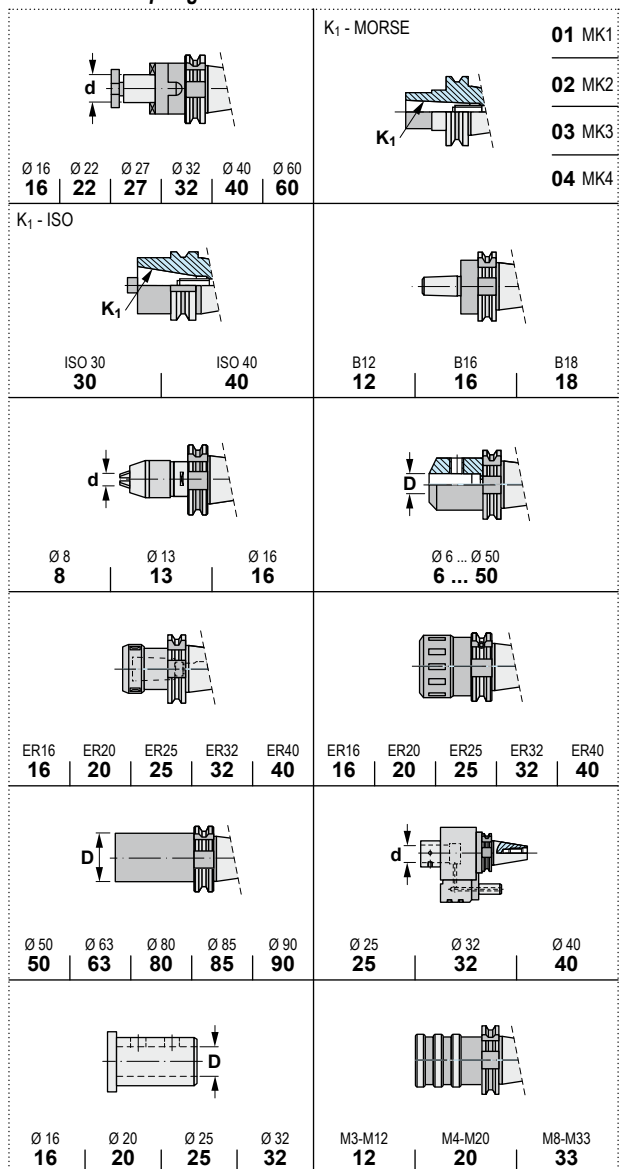

AT3 TECHNICAL CHARACTERISTICS OF THE TOOLHOLDERS AT3 TECHNISCHE EIGENSCHAFTEN DER AUFNAHMEN

MATERIAL:

- Chromium-manganese carburised steel 1.7131 (16MnCr5).

EXECUTION:

- Carburised, hardened and tempered.
- Surface hardness HRC 58±2 (670±40 HV30)
- Depth of carburised layer minimum 0,5 mm.
- Tensile strength in core minimum 800 N/mm2 after carburizing.

ACCURACY:

- Taper according to DIN 254
- Taper angle:
tolerance AT 3 DIN 7178 part 1 and DIN 2080 part 1.
- Other tolerances according to DIN 7160 and 7168.
- Taper surface roughness RZ<0,001 mm.

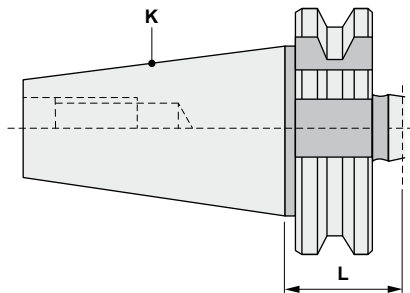

PREBALANCED TOOLHOLDERS VORGEWUCHTETE AUFNAHMEN

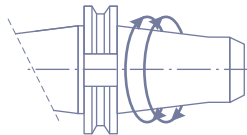

ISO 40 ▶ 8000 rpm

ISO 50 ▶ 8000 rpm

MATERIALIEN:

- Legierter aufgekohlter Stahl mit Chrom-Mangan 1.7131 (16MnCr5).

KONSTRUKTIONS DATEN:

- Aufgekühlt, gehärtet und angelassen.
- Oberflächenhärte HRC 58±2 (670±40 HV30)
- Aufgekühlt auf minimum 0,5 mm Tiefe.
- Zugfestigkeit im Kern minimum 800 N/mm2 nach der Aufkohlung.

GENAUIGKEIT:

- Dorn nach DIN 254
- Kegelwinkel:
Toleranz AT 3 DIN 7178 Teil 1 und DIN 2080 Teil 1.
- Andere Toleranzen entsprechend DIN 7160 und 7168.
- Rauigkeit der Oberfläche RZ<0,001 mm.

K	AT3 mm
ISO 30	0,002
ISO 40	0,003
ISO 45	0,003
ISO 50	0,004
ISO 60	0,005

TOLERANCE AT:

- Indicates the tolerance of measuring plane D between the real and the theoretical value of the taper conicity.
- This value of measuring plane D must always be less (negative), never more (positive) in order to GUARANTEE a good toolholder fixation at the bigger taper diameter.

TOLERANZ AT:

- Zeigt die Toleranz auf der Messebene D zwischen dem tatsächlichen Wert der Kegelkonizität und dem theoretischen Wert.
- Dieser Wert auf der Messebene D sollte immer minus (negativ) sein, nie plus (positiv), um für einen guten Halt des Futter in den größeren Durchmesser des Kegels zu GARANTIEREN.

11 DIN 69871/A-AD

FORM A: SIMILAR DIN 69871 AD

ÄHNLICH WIE DIN 69871 AD

Without through hole / Ohne Durchgangsbohrung

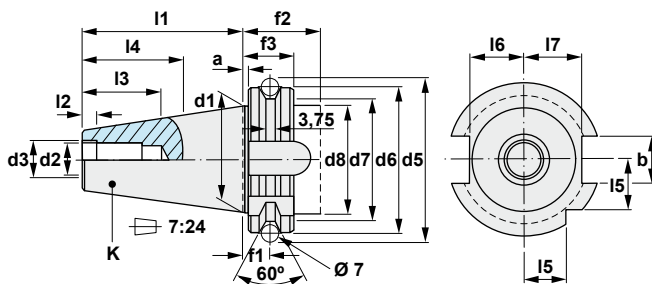

K	a1±0,1	b H12	d1	d2	d3 H7	d5±0,5	d6 0/-0,1	d7 0/-0,5	d8 max
30	3,2	16,1	31,75	M 12	13	59,30	50,00	44,30	45
40	3,2	16,1	44,45	M 16	17	72,30	63,55	56,25	50
50	3,2	25,7	69,85	M 24	25	107,25	97,50	91,25	80
50	3,2	25,7	107,95	M 30	32	164,75	155,00	147,70	130

K	f1±0,1	f2 min	f3 0/-0,1	l1	l2	l3 min	l4 min	l5 0/-0,3	l6 0/-0,4	l7 0/-0,4	d9	e1±0,1	e2 max
30	11,1	35	19,1	47,80	5,5	24	33,5	15,0	16,4	19,0	4	21	5,0
40	11,1	35	19,1	68,40	8,2	32	42,5	18,5	22,8	25,0	4	27	5,0
50	11,1	35	19,1	101,75	11,5	47	61,5	30,0	35,5	37,7	6	42	7,0
50	11,1	35	19,1	161,80	14,0	59	76,0	49,0	54,2	59,3	8	66	9,2

13 DIN 69871/B

FORM B: SIMILAR DIN 69871 AD+B

ÄHNLICH WIE DIN 69871 AD+B

With central coolant feed and through the collar
Mit zentraler Kühlmittelzufuhr und durch den Bund

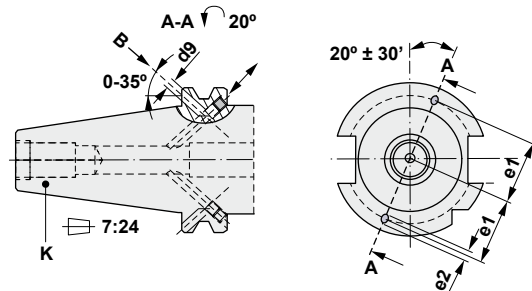

Arbors and adaptors DIN 69871-A
Aufnahmen DIN 69871-A

11.160



Page / Seite 132

13.160



Page / Seite 133

11.165



Page / Seite 138

11.180



Page / Seite 139

11.210



Page / Seite 140

13.210



Page / Seite 141

11.215



Page / Seite 142

13.215



Page / Seite 143

11.216



Page / Seite 144

11.225



Page / Seite 145

11.226



Page / Seite 146

11.290



Page / Seite 147

11.295



Page / Seite 148

11.296



Page / Seite 149

13.296



Page / Seite 150

11.300



Page / Seite 151

13.300



Page / Seite 152

11.302



Page / Seite 153

13.302



Page / Seite 154

11.305



Page / Seite 155

13.306



Page / Seite 156-57

13.307



Page / Seite 158

13.315



Page / Seite 159

11.353



Page / Seite 161

11.400



Page / Seite 162

11.453



Page / Seite 164

13.453



Page / Seite 165

11.455



Page / Seite 166

11.457





Page / Seite 167

13.457



Page / Seite 168

Arbors and adaptors DIN 69871-A
Aufnahmen DIN 69871-A

<p>11.470</p>  <p>Page / Seite 169</p>	<p>11.512</p>  <p>Page / Seite 170</p>	<p>11.610</p>  <p>Page / Seite 171</p>	<p>13.610</p>  <p>Page / Seite 172</p>	<p>11.620</p>  <p>Page / Seite 173</p>
<p>11.630</p>  <p>Page / Seite 174</p>	<p>11.999</p>  <p>Page / Seite 175</p>			

Antivibratory adaptors DIN 69871-A
Schwingungsgedämpfte Aufnahmen DIN 69871-A

<p>A11.160IK Cylindrical Zylindrische Form</p>  <p>Page / Seite 135</p>	<p>A11.160 Cylindrical Zylindrische Form</p>  <p>Page / Seite 136</p>	<p>A11.160 Conical Konische Form</p>  <p>Page / Seite 137</p>	<p>A11.315IK</p>  <p>Page / Seite 160</p>	<p>A11.315</p>  <p>Page / Seite 160</p>
--	--	--	---	--

Sets DIN 69871-A
Sätze DIN 69871-A

<p>SET-C20/32</p>  <p>Page / Seite 163</p>				
--	--	--	--	--







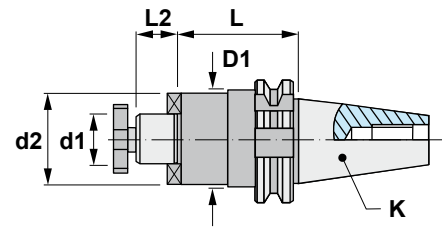

Characteristics:
Shell mill adaptors.
DIN 69871-A
For cutters with driving slot DIN 138.

Eigenschaften:
Aufsteckfräsdorne.
DIN 69871-A
Für Fräser mit Quernut DIN 138.



11.160

Reference Bezeichnung	K ISO	d1 h6	L	L2	d2	D1				
11.160.30.16	30	16	40	17	38	-	10008	86016	11103	0,620
11.160.30.22	30	22	40	19	48	-	10010	86022	11004	0,800
11.160.30.27	30	27	40	21	58	-	10012	86027	11005	0,740
11.160.40.16	40	16	35	17	38	-	10008	86016	11103	1,080
11.160.40.16/100	40	16	100	17	38	38	10008	86016	11103	1,470
11.160.40.22	40	22	35	19	48	-	10010	86022	11004	1,160
11.160.40.22/100	40	22	100	19	48	48	10010	86022	11004	2,130
11.160.40.27	40	27	60	21	58	-	10012	86027	11005	1,360
11.160.40.27/100	40	27	100	21	58	58	10012	86027	11005	2,710
11.160.40.32	40	32	60	24	63	-	10016	86032	11105	1,820
11.160.40.32/125	40	32	125	24	78	63	10016	86032	11105	3,000
11.160.40.40	40	40	60	27	73	-	10020	86040	11006	2,200
11.160.50.16	50	16	35	17	38	-	10008	86016	11103	2,990
11.160.50.16/100	50	16	100	17	38	-	10008	86016	11103	3,220
11.160.50.16/150	50	16	150	17	38	-	10008	86016	11103	4,040
11.160.50.22	50	22	35	19	48	-	10010	86022	11004	3,130
11.160.50.22/100	50	22	100	19	48	-	10010	86022	11004	3,620
11.160.50.22/150	50	22	150	19	48	-	10010	86022	11004	4,660
11.160.50.27	50	27	40	21	58	-	10012	86027	11005	3,440
11.160.50.27/100	50	27	100	21	58	-	10012	86027	11005	4,080
11.160.50.27/150	50	27	150	21	58	-	10012	86027	11005	5,240
11.160.50.32	50	32	50	24	78	-	10016	86032	11105	4,150
11.160.50.32/100	50	32	100	24	78	-	10016	86032	11105	3,250
11.160.50.32/150	50	32	150	24	78	-	10016	86032	11105	7,910
11.160.50.40	50	40	50	27	88	80	10020	86040	11006	4,120
11.160.50.40/150	50	40	150	27	88	80	10020	86040	11006	7,460
11.160.50.50	50	50	65	30	90	-	10024	86050	11008	5,300





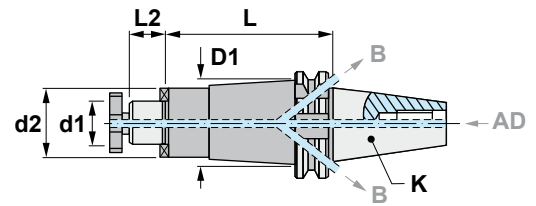

Characteristics:
Shell mill adaptors.
DIN 69871-A
For cutters with driving slot
DIN 138.
With inner coolant AD+B.



Eigenschaften:
Aufsteckfräsdorne.
DIN 69871-A
Für Fräser mit Quernut DIN 138.
Mit Innenkühlung AD+B

13.160

Reference Bezeichnung	K ISO	d1 h6	L	L2	d2	D1				
13.160.40.16	40	16	35	17	38	-	10008	86016	11103	1,070
13.160.40.16/100	40	16	100	17	38	38	10008	86016	11003	1,540
13.160.40.22	40	22	35	19	48	-	10010	86022	11004	1,120
13.160.40.22/100	40	22	100	19	48	48	10010	86022	11004	2,020
13.160.40.27	40	27	60	21	58	-	10012	86027	11005	1,360
13.160.40.27/100	40	27	100	21	58	58	10012	86027	11005	2,030
13.160.40.32	40	32	60	24	63	-	10016	86032	11105	1,850
13.160.40.32/125	40	32	125	24	78	63	10016	86032	11105	2,730
13.160.40.40	40	40	60	27	73	-	10020	86040	11006	2,060
13.160.50.16	50	16	35	17	38	-	10008	86016	11103	2,850
13.160.50.16/100	50	16	100	17	38	-	10008	86016	11103	3,220
13.160.50.16/150	50	16	150	17	38	-	10008	86016	11103	3,780
13.160.50.22	50	22	35	19	48	-	10010	86022	11004	2,990
13.160.50.22/100	50	22	100	19	48	-	10010	86022	11004	3,400
13.160.50.22/150	50	22	150	19	48	-	10010	86022	11004	4,170
13.160.50.27	50	27	40	21	58	-	10012	86027	11005	3,250
13.160.50.27/100	50	27	100	21	58	-	10012	86027	11005	4,450
13.160.50.27/150	50	27	150	21	58	-	10012	86027	11005	5,290
13.160.50.32	50	32	50	24	78	-	10016	86032	11105	3,990
13.160.50.32/100	50	32	100	24	78	-	10016	86032	11105	4,580
13.160.50.32/150	50	32	150	24	78	-	10016	86032	11105	7,560
13.160.50.40	50	40	50	27	88	80	10020	86040	11006	3,920
13.160.50.40/150	50	40	150	27	88	80	10020	86040	11006	8,190
13.160.50.50	50	50	65	30	90	-	10024	86050	11008	4,990

Antivibratory adaptors Schwingungsgedämpfte Aufsteckfräsdorne

SPECIAL FOR MOULD AND DIE MAKERS

Vibration reduced up to 60% compared to any other conventional shell mill adaptor, as they are manufactured with materials and mechanisms having antivibration properties.

BESONDERS EMPFOHLEN FÜR WERKZEUG- UND FORMENBAU

60% weniger Schwingungen im Vergleich mit anderen konventionellen Aufsteckfräsdornen, da diese Ausführung mit schwingungsdämpfenden Materialien und Mechanismen hergestellt wird.

COMPARISON WHEN USING AN ANTIVIBRATORY TOOLHOLDER

VERGLEICH ZWISCHEN EINER KONVENZIONELLEN UND EINER SCHWINGUNGSGEDÄMPFTEN AUFNAHME

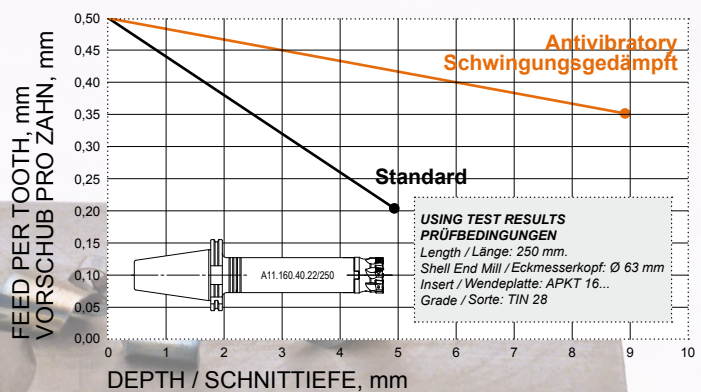





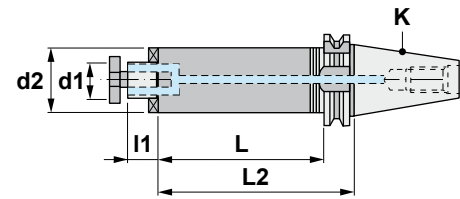

Characteristics:
Cylindrical antivibratory shell mill adaptors. DIN 69871-A
For cutters with driving slot DIN 138.
With internal coolant.

Eigenschaften:
Zylindrische schwingungsgedämpfte Aufsteckfräsdorne.
DIN 69871-A
Für Fräser mit Quernut DIN 138.
Mit Innenkühlung.



A11.160IK

Reference Bezeichnung	K ISO	d1 h6	L2	L	l1	d2				
A11.160.40.16/200-38IK	40	16	200	181	17	38	10008	86016	11103	2,510
A11.160.40.16/300-38IK	40	16	300	281	17	38	10008	86016	11103	3,370
A11.160.40.22/200-48IK	40	22	200	181	19	48	10010	86022	11004	3,070
A11.160.40.22/300-48IK	40	22	300	281	19	48	10010	86022	11004	4,890
A11.160.40.27/200-58IK	40	27	200	181	21	58	10012	86027	11005	3,630
A11.160.50.16/200-38IK	50	16	200	181	17	38	10008	86016	11103	4,391
A11.160.50.16/300-38IK	50	16	300	281	17	38	10008	86016	11103	5,886
A11.160.50.22/200-48IK	50	22	200	181	19	48	10010	86022	11004	6,226
A11.160.50.22/300-48IK	50	22	300	281	19	48	10010	86022	11004	5,900
A11.160.50.27/200-58IK	50	27	200	181	21	58	10012	86027	11005	6,846
A11.160.50.27/300-58IK	50	27	300	281	21	58	10012	86027	11005	6,846
A11.160.50.32/300-78IK	50	32	300	281	24	78	10016	86032	11105	10,576





Characteristics:



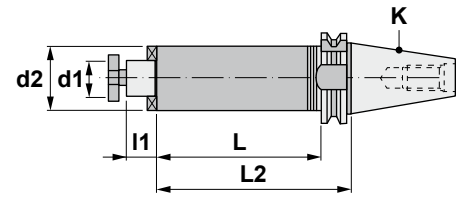

Cylindrical antivibratory shell mill adaptors. DIN 69871-A
Für Fräser mit Quernut DIN 138.

Eigenschaften:

Zylindrische schwingungsgedämpfte Aufsteckfräsdorne.
DIN 69871-A
Für Fräser mit Quernut DIN 138.



A11.160

Reference Bezeichnung	K ISO	d1 h6	L2	L	l1	d2				
A11.160.40.16/150-38	40	16	150	131	17	38	10008	86016	11103	2,030
A11.160.40.16/200-38	40	16	200	181	17	38	10008	86016	11103	2,510
A11.160.40.16/250-38	40	16	250	231	17	38	10008	86016	11103	2,920
A11.160.40.16/300-38	40	16	300	281	17	38	10008	86016	11103	3,370
A11.160.40.22/150-48	40	22	150	131	19	48	10010	86022	11004	2,370
A11.160.40.22/200-48	40	22	200	181	19	48	10010	86022	11004	3,070
A11.160.40.22/250-48	40	22	250	231	19	48	10010	86022	11004	4,180
A11.160.40.22/300-48	40	22	300	281	19	48	10010	86022	11004	4,890
A11.160.40.27/150-58	40	27	150	131	21	58	10012	86027	11005	2,850
A11.160.40.27/200-58	40	27	200	181	21	58	10012	86027	11005	3,630
A11.160.40.27/250-58	40	27	250	231	21	58	10012	86027	11005	4,440
A11.160.40.27/300-58	40	27	300	281	21	58	10012	86027	11005	5,350
A11.160.50.16/150-38	50	16	150	131	17	38	10008	86016	11103	4,230
A11.160.50.16/200-38	50	16	200	181	17	38	10008	86016	11103	4,391
A11.160.50.16/250-38	50	16	250	231	17	38	10008	86016	11103	5,280
A11.160.50.16/300-38	50	16	300	281	17	38	10008	86016	11103	5,886
A11.160.50.16/400-38	50	16	400	381	17	38	10008	86016	11103	5,886
A11.160.50.22/200-48	50	22	200	181	19	48	10010	86022	11004	6,226
A11.160.50.22/250-48	50	22	250	231	19	48	10010	86022	11004	5,330
A11.160.50.22/300-48	50	22	300	281	19	48	10010	86022	11004	5,900
A11.160.50.22/400-48	50	22	400	381	19	48	10010	86022	11004	7,276
A11.160.50.22/500-48	50	22	500	481	19	48	10010	86022	11004	8,470
A11.160.50.22/200-60	50	22	200	181	19	60	10010	86022	11004	7,276
A11.160.50.22/250-60	50	22	250	231	19	60	10010	86022	11004	7,810
A11.160.50.22/300-60	50	22	300	281	19	60	10010	86022	11004	8,140
A11.160.50.22/400-60	50	22	400	381	19	60	10010	86022	11004	9,240
A11.160.50.22/500-60	50	22	500	481	19	60	10010	86022	11004	12,280
A11.160.50.27/200-58	50	27	200	181	21	58	10012	86027	11005	6,846
A11.160.50.27/250-58	50	27	250	231	21	58	10012	86027	11005	7,130
A11.160.50.27/300-58	50	27	300	281	21	58	10012	86027	11005	6,846
A11.160.50.27/400-58	50	27	400	381	21	58	10012	86027	11005	6,846
A11.160.50.27/500-58	50	27	500	481	21	58	10012	86027	11005	8,140
A11.160.50.32/200-78	50	32	200	181	24	78	10016	86032	11105	7,556
A11.160.50.32/250-78	50	32	250	231	24	78	10016	86032	11105	9,576
A11.160.50.32/300-78	50	32	300	281	24	78	10016	86032	11105	10,576
A11.160.50.32/400-78	50	32	400	381	24	78	10016	86032	11105	13,076
A11.160.50.32/500-78	50	32	500	481	24	78	10016	86032	11105	16,076





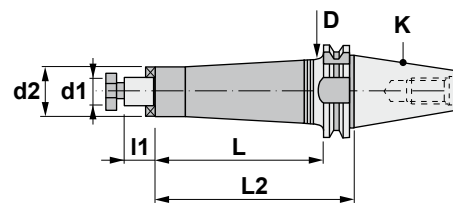

Characteristics:
 Conical antivibratory shell mill adaptors.
 DIN 69871-A
 For cutters with driving slot DIN 138.

Eigenschaften:
 Konische schwingungsgedämpfte
 Aufsteckfräsdorne.
 DIN 69871-A
 Für Fräser mit Quernut DIN 138.



A11.160

Reference Bezeichnung	K ISO	d1 h6	L2	L	D	l1	d2				
A11.160.40.16/150	40	16	150	131	50	17	38	10008	86016	11103	2,200
A11.160.40.16/200	40	16	200	181	50	17	38	10008	86016	11103	2,710
A11.160.40.16/250	40	16	250	231	50	17	38	10008	86016	11103	3,250
A11.160.40.16/300	40	16	300	281	50	17	38	10008	86016	11103	3,740
A11.160.40.22/150	40	22	150	131	50	19	48	10010	86022	11004	2,640
A11.160.40.22/200	40	22	200	181	50	19	48	10010	86022	11004	3,320
A11.160.40.22/250	40	22	250	231	50	19	48	10010	86022	11004	4,030
A11.160.40.22/300	40	22	300	281	50	19	48	10010	86022	11004	4,750
A11.160.50.16/150	50	16	150	131	80	17	38	10008	86016	11103	4,610
A11.160.50.16/200	50	16	200	181	80	17	38	10008	86016	11103	5,886
A11.160.50.16/250	50	16	250	231	80	17	38	10008	86016	11103	5,940
A11.160.50.16/300	50	16	300	281	80	17	38	10008	86016	11103	6,750
A11.160.50.16/400	50	16	400	381	80	17	38	10008	86016	11103	10,540
A11.160.50.22/200	50	22	200	181	80	19	48	10010	86022	11004	5,780
A11.160.50.22/250	50	22	250	231	80	19	48	10010	86022	11004	6,550
A11.160.50.22/300	50	22	300	281	80	19	48	10010	86022	11004	7,380
A11.160.50.22/400	50	22	400	381	80	19	48	10010	86022	11004	10,426
A11.160.50.22/500	50	22	500	481	80	19	48	10010	86022	11004	11,530
A11.160.50.27/200	50	27	200	181	80	21	58	10012	86027	11005	6,550
A11.160.50.27/250	50	27	250	231	80	21	58	10012	86027	11005	7,500
A11.160.50.27/300	50	27	300	281	80	21	58	10012	86027	11005	8,600
A11.160.50.27/400	50	27	400	381	80	21	58	10012	86027	11005	10,670
A11.160.50.27/500	50	27	500	481	80	21	58	10012	86027	11005	13,520





Characteristics:

Adaptors for indexable milling cutters. DIN 69871-A/ DIN 6357 - Form A

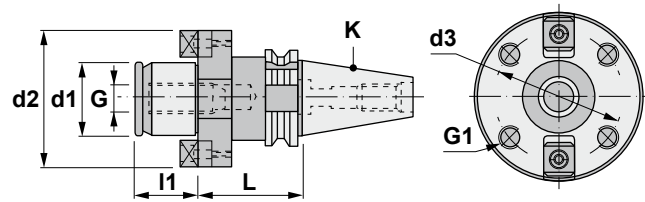

Eigenschaften:

Zwischenhülsen für Fräser. DIN 69871-A/ DIN 6357 - Form A



11.165

Reference Bezeichnung	K ISO	d1 g5	L	d2	d3	G	G1	I1	
11.165.40.40	40	40	60	89	66,7	M-20	M-12	30	2,540
11.165.50.40	50	40	70	89	66,7	M-20	M-12	30	5,190
11.165.50.60	50	60	70	129	101,6	M-30	M-16	40	7,010

Reference Bezeichnung		
11.165.40.40	80040	11006
11.165.50.40	80040	11006
11.165.50.60	80060	11012

**Characteristics:**



Combi-Shell mill adaptor.
DIN 69871-A / DIN 6358 - Form B
For cutters with keyway or driving slot
DIN 138.

Eigenschaften:

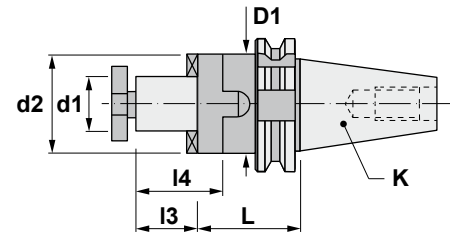
Kombi-Aufsteckfräsdorne.
DIN 69871-A / DIN 6358 - Form B
Für Fräser mit Längsnut oder
Stirnmitnehmer DIN 138.



11.180

Reference Bezeichnung	K ISO	d1 h6	L	I3	I4	d2	D1				
11.180.30.16	30	16	50	17	27	32	-	10008	60116	88016	0,660
11.180.30.22	30	22	50	19	31	40	-	10010	60122	88022	0,680
11.180.30.27	30	27	55	21	33	48	-	10012	60127	88027	1,000
11.180.40.16	40	16	55	17	27	32	-	10008	60116	88016	1,140
11.180.40.16/100	40	16	100	17	27	32	35	10008	60116	88016	1,490
11.180.40.22	40	22	55	19	31	40	-	10010	60122	88022	1,300
11.180.40.22/100	40	22	100	19	31	40	48	10010	60122	88022	1,900
11.180.40.27	40	27	55	21	33	48	-	10012	60127	88027	1,510
11.180.40.27/100	40	27	100	21	33	48	48	10012	60127	88027	2,040
11.180.40.32	40	32	60	24	38	58	-	10016	60132	88032	1,820
11.180.40.32/100	40	32	100	24	38	58	58	10016	60132	88032	2,660
11.180.40.40	40	40	60	27	41	70	-	10020	60140	88040	2,210
11.180.50.16	50	16	55	17	27	32	-	10008	60116	88016	3,010
11.180.50.16/100	50	16	100	17	27	32	35	10008	60116	88016	3,590
11.180.50.22	50	22	55	19	31	40	-	10010	60122	88022	3,250
11.180.50.22/100	50	22	100	19	31	40	48	10010	60122	88022	3,820
11.180.50.27	50	27	55	21	33	48	-	10012	60127	88027	3,400
11.180.50.27/100	50	27	100	21	33	48	60	10012	60127	88027	4,300
11.180.50.32	50	32	55	24	38	58	-	10016	60132	88032	3,750
11.180.50.32/100	50	32	100	24	38	58	78	10016	60132	88032	5,260
11.180.50.40	50	40	55	27	41	70	-	10020	60140	88040	3,750
11.180.50.40/100	50	40	100	27	41	70	78	10020	60140	88040	5,820
11.180.50.50	50	50	70	30	46	90	-	10024	60150	88050	5,730





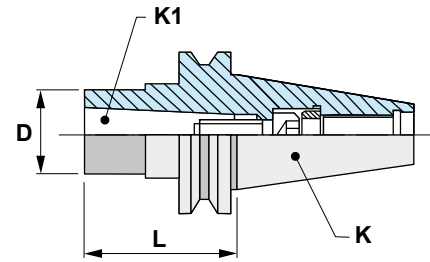

Characteristics:
Reducing adaptors.
DIN 69871-A / ISO 3937
For tools with Morse taper shank
and drawbar thread DIN 228-A.

Eigenschaften:
Reduzierhülsen.
DIN 69871-A / ISO 3937
Für Werkzeuge mit Morsekegel
und Anzugsgewinde DIN 228-A.



11.210

Reference Bezeichnung	K ISO	K1 MORSE	L	D	
11.210.30.01	30	1	50	25	0,530
11.210.30.02	30	2	70	32	0,670
11.210.30.03	30	3	100	40	1,000
11.210.40.01	40	1	50	25	1,000
11.210.40.02	40	2	50	32	0,990
11.210.40.03	40	3	70	40	1,170
11.210.40.04	40	4	95	48	1,410
11.210.50.01	50	1	45	25	2,870
11.210.50.02	50	2	60	32	2,950
11.210.50.03	50	3	65	40	3,060
11.210.50.04	50	4	70	48	3,080
11.210.50.05	50	5	100	63	3,480

Reference Bezeichnung			
11.210.30.01	16105	19312	11106
11.210.30.02	16105	19315	12110
11.210.30.03	16105	19318	12012
11.210.40.01	16205	19516	11206
11.210.40.02	16205	19416	18010
11.210.40.03	16205	19420	11312
11.210.40.04	16205	19322	12016
11.210.50.01	16205	19624	11206
11.210.50.02	16205	19324	11110
11.210.50.03	16205	19524	11212
11.210.50.04	16205	19424	12016
11.210.50.05	16205	19338	11020





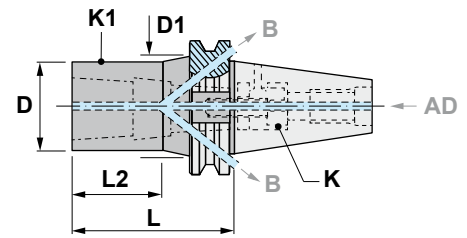

Characteristics:
Reducing adaptors.
DIN 69871-A / ISO 3937
For tools with Morse taper shank
and drawbar thread DIN 228-A.

Eigenschaften:
Reduzierhülsen.
DIN 69871-A / ISO 3937.
Für Werkzeuge mit Morsekegel
und Anzugsgewinde DIN 228-A.



13.210

Reference Bezeichnung	K ISO	K1 MORSE	L	D	D1	L2	
13.210.40.01	40	1	50	25	45	16	1,010
13.210.40.02	40	2	50	32	50	19	1,020
13.210.40.03	40	3	70	40	50	42	1,160
13.210.40.04	40	4	95	48	-	-	1,420
13.210.50.01	50	1	45	25	80	16	3,060
13.210.50.02	50	2	60	32	80	23	3,520
13.210.50.03	50	3	65	40	80	28	3,530
13.210.50.04	50	4	70	48	80	37	3,360
13.210.50.05	50	5	100	63	80	66	3,400

Reference Bezeichnung			
13.210.40.01	16205	19516	18006
13.210.40.02	16205	19416	18010
13.210.40.03	16205	19420	18012
13.210.40.04	16205	19322	18016
13.210.50.01	16205	19624	18006
13.210.50.02	16205	19324	18110
13.210.50.03	16205	19524	18112
13.210.50.04	16205	19424	18016
13.210.50.05	16205	19338	18020





Characteristics:
Reducing adaptors.
DIN 69871-A
For tools with Morse taper shank
and tang. DIN 228-B.

Eigenschaften:
Reduzierhülsen.
DIN 69871-A
Für Werkzeuge mit Morsekegel
und Austreiblappen. DIN 228-B.

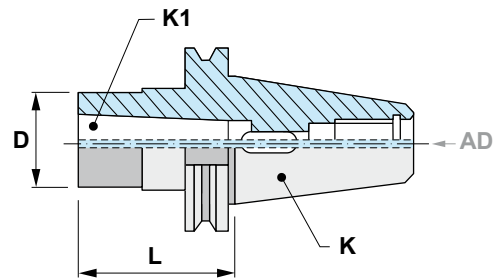

11.215

Reference Bezeichnung	K ISO	K1 MORSE	L	D	
11.215.30.01	30	1	50	25	0,490
11.215.30.02	30	2	60	32	0,550
11.215.30.03	30	3	80	40	0,760
11.215.40.01	40	1	50	25	0,920
11.215.40.02	40	2	50	32	0,940
11.215.40.03	40	3	70	40	1,090
11.215.40.04	40	4	95	48	1,330
11.215.50.01	50	1	45	25	2,810
11.215.50.02	50	2	60	32	2,870
11.215.50.03	50	3	65	40	2,910
11.215.50.04	50	4	95	48	3,150
11.215.50.05	50	5	105	63	3,340



Characteristics:
Reducing adaptors.
DIN 69871-A
For tools with Morse taper shank
and tang. DIN 228-B.

Eigenschaften:
Reduzierhülsen.
DIN 69871-A
Für Werkzeuge mit Morsekegel
und Austreiblappen. DIN 228-B.

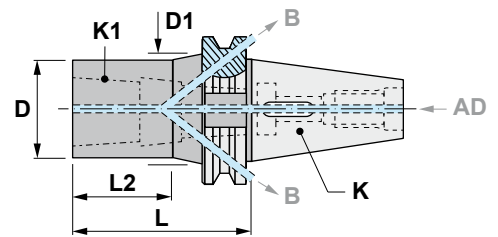

13.215

Reference Bezeichnung	K ISO	K1 MORSE	L	D	D1	L2	
13.215.40.01	40	1	50	25	45	16	0,940
13.215.40.02	40	2	50	32	50	18	0,970
13.215.40.03	40	3	70	40	50	42	1,100
13.215.40.04	40	4	95	48	-	-	1,310
13.215.50.01	50	1	45	25	80	16	3,080
13.215.50.02	50	2	60	32	80	23	3,400
13.215.50.03	50	3	65	40	80	28	3,380
13.215.50.04	50	4	95	48	80	49	3,460
13.215.50.05	50	5	105	63	80	71	3,410



Characteristics:
Long reducing adaptors.
DIN 69871-A
For tools with Morse taper shank
and tang. DIN 228-B.

Eigenschaften:
Lange Reduzierhülsen.
DIN 69871-A
Für Werkzeuge mit Morsekegel
und Austreiblappen. DIN 228-B.

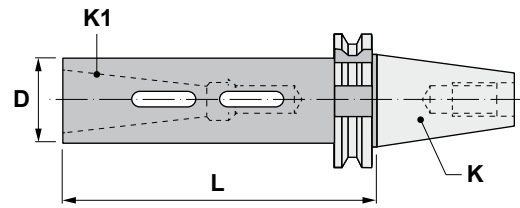

11.216

Reference Bezeichnung	K ISO	K1 MORSE	L	D	
11.216.30.01	30	1	115	25	0,750
11.216.30.02	30	2	125	32	0,960
11.216.30.03	30	3	145	40	1,320
11.216.40.01	40	1	115	25	1,200
11.216.40.02	40	2	125	32	1,440
11.216.40.03	40	3	145	40	1,770
11.216.40.04	40	4	165	48	2,230
11.216.50.01	50	1	120	25	2,980
11.216.50.02	50	2	135	32	3,410
11.216.50.03	50	3	155	40	3,810
11.216.50.04	50	4	180	48	4,380
11.216.50.05	50	5	215	63	5,840





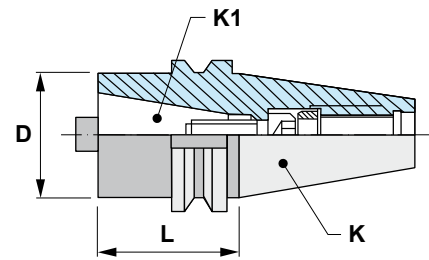

Characteristics:
Reducing adaptors.
DIN 69871-A
For tools with DIN 2080 ISO
taper shank.

Eigenschaften:
Reduzierhülsen.
DIN 69871-A
Für Werkzeuge mit DIN 2080
Kegel.



11.225

Reference Bezeichnung	K ISO	K1 DIN 2080	L	D	
11.225.40.30	40	30	50	50	1,200
11.225.40.40	40	40	100	63	2,060
11.225.50.30	50	30	50	50	3,110
11.225.50.40	50	40	70	63	3,750
11.225.50.50	50	50	120	97	6,120

Reference Bezeichnung			
11.225.40.30	16205	19320	11312
11.225.40.40	16205	19322	12016
11.225.50.30	16205	19524	11112
11.225.50.40	16205	19424	12016
11.225.50.50	16205	19438	12024







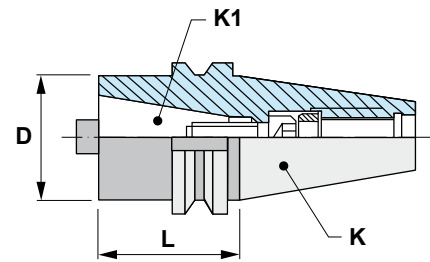

Characteristics:
Reducing adaptors.
DIN 69871-A
For tools with DIN 69871-A
and BT shanks.

Eigenschaften:
Reduzierhülsen.
DIN 69871-A.
Für Werkzeuge mit DIN 69871-A
und BT Kegel.



11.226

Reference Bezeichnung	K ISO	K1 DIN 69871 JIS B 6339-BT	L	D	
11.226.40.30	40	30	50	50	1,170
11.226.40.40	40	40	100	63	2,090
11.226.50.30	50	30	50	50	2,800
11.226.50.40	50	40	70	63	3,550
11.226.50.50	50	50	120	97	6,240

Reference Bezeichnung			
11.226.40.30	16205	19320	11412
11.226.40.40	16205	19322	12116
11.226.50.30	16205	19524	11412
11.226.50.40	16205	19424	12116
11.226.50.50	16205	19438	12124



Characteristics:
Drill chuck adaptors.
DIN 69871-A
For drill chucks with DIN 238 taper.

Eigenschaften:
Bohrfutteraufnahmen.
DIN 69871-A.
Für Bohrfutter mit DIN 238 Kegel.

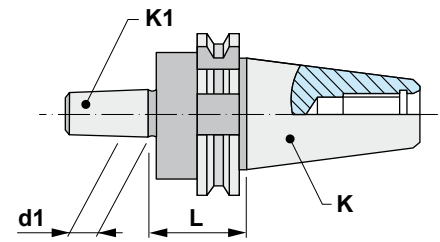

11.290

Reference Bezeichnung	K ISO	K1 DIN	L	d1	
11.290.30.12	30	B-12	25	12,065	0,450
11.290.30.16	30	B-16	25	15,733	0,450
11.290.40.12	40	B-12	25	12,065	0,910
11.290.40.16	40	B-16	25	15,733	0,930
11.290.40.18	40	B-18	25	17,780	0,950
11.290.50.16	50	B-16	25	15,733	2,850
11.290.50.18	50	B-18	25	17,780	2,850

MU

 I199

Ref. / Bez.	Accessories / Zubehör
MU	Standard keyless drill chucks DIN 238 Standard Schnellspann-Bohrfutter DIN 238



MP

 I200

Ref. / Bez.	Accessories / Zubehör
MP	Super precision keyless drill chucks DIN 238 Höchst-Genauigkeit-Selbstspannbohrfutter DIN 238



MK

 I201

Ref. / Bez.	Accessories / Zubehör
MK	Super precision keyless drill chucks DIN 238 with gripping tongue Höchst-Genauigkeit-Selbstspannbohrfutter DIN 238 mit Schlüsselflächen





Characteristics:

Self clamping short precision drill chucks.
DIN 69871-A
For right turn only.

*** SUPPLIED WITH WRENCH**

Eigenschaften:

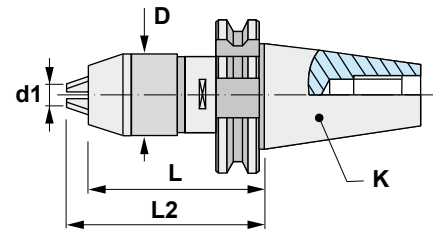

Selbstspann-Kurzbohrfutter,
Genauigkeitsausführung.
DIN 69871-A.
Nur für rechtslaufende Bearbeitungen.

*** LIEFERUNG MIT SCHLÜSSEL**



11.295

Reference Bezeichnung	K ISO	d1	D	L	L2 max	
11.295.30.08	30	0,3-8	38	77	83	0,980
11.295.40.08	40	0,3-8	38	70	76	1,500
11.295.40.13	40	1-13	48	80	91	1,620
11.295.40.16	40	3-16	55	97	108	2,040
11.295.50.13	50	1-13	48	78	89	3,470
11.295.50.16	50	3-16	55	76	89	3,700

Reference Bezeichnung		
11.295.30.08	50008	11206
11.295.40.08	50008	11206
11.295.40.13	50013	11108
11.295.40.16	50016	11108
11.295.50.13	50013	11108
11.295.50.16	50016	11108



Characteristics:
CNC-Universal precision drill chucks.
DIN 69871-A
For left and right hand turn.

*** SUPPLIED WITH WRENCH**

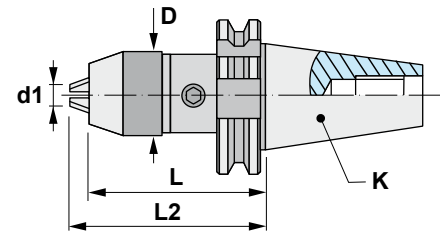

Eigenschaften:
CNC-Universal Bohrfutter,
Genauigkeitsausführung.
DIN 69871-A.
Für links- und rechtslaufende
Bearbeitungen.

*** LIEFERUNG MIT SCHLÜSSEL**



11.296

Reference Bezeichnung	K ISO	d1	D	L	L2 max	KG
11.296.40.13	40	1-13	54	91	100	1,550
11.296.40.16	40	3-16	57	94	101	1,830
11.296.50.13	50	1-13	54	93	102	3,500
11.296.50.16	50	3-16	57	96	103	3,760

Reference Bezeichnung		3x 
11.296.40.13	5006	60313
11.296.40.16	5006	60313
11.296.50.13	5006	60313
11.296.50.16	5006	60313





Characteristics:
CNC-Universal precision drill chucks.
DIN 69871-A
For left and right hand turn.

*** SUPPLIED WITH WRENCH**

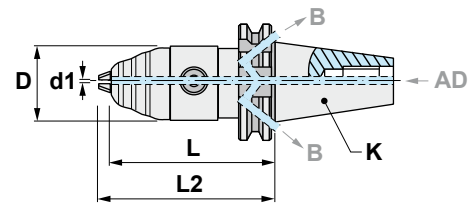

Eigenschaften:
CNC-Universal Bohrfutter,
Genauigkeitsausführung.
DIN 69871-A.
Für links- und rechtslaufende
Bearbeitungen.

*** LIEFERUNG MIT SCHLÜSSEL**



13.296

Reference Bezeichnung	K ISO	d1	D	L	L2 max	
13.296.40.13	40	1-13	54	91	100	1,920
13.296.40.16	40	3-16	57	94	101	2,100
13.296.50.13	50	1-13	54	93	102	3,420
13.296.50.16	50	3-16	57	96	103	3,690

Reference Bezeichnung		3x 
13.296.40.13	5006	60313
13.296.40.16	5006	60313
13.296.50.13	5006	60313
13.296.50.16	5006	60313

**Characteristics:**



Weldon end mill adaptors.
DIN 69871-A
For cutters with cylindrical shank
and Weldon flat DIN 1835-B.

Eigenschaften:

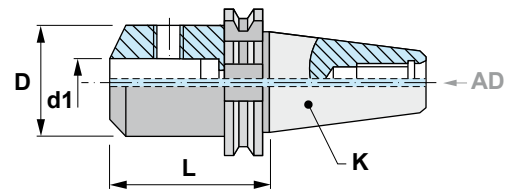
Zylinderschaft-Aufnahme Weldon.
DIN 69871-A.
Für Fräser mit zylindrischem Schaft
und Weldon-Fläche DIN 1835-B.



11.300

Reference Bezeichnung	K ISO	d1 H4	L	D		
11.300.30.06	30	6	50	25	15106	0,500
11.300.30.08	30	8	50	28	15108	0,520
11.300.30.10	30	10	50	35	15110	0,610
11.300.30.12	30	12	50	42	15212	0,620
11.300.30.14	30	14	50	44	15212	0,625
11.300.30.16	30	16	63	48	15314	0,850
11.300.30.18	30	18	63	50	15314	0,880
11.300.40.06	40	6	50	25	15106	0,940
11.300.40.08	40	8	50	28	15108	0,970
11.300.40.10	40	10	50	35	15110	1,030
11.300.40.12	40	12	50	42	15212	1,120
11.300.40.14	40	14	50	44	15212	1,130
11.300.40.16	40	16	63	48	15314	1,340
11.300.40.18	40	18	63	50	15314	1,370
11.300.40.20	40	20	63	52	15216	1,380
11.300.40.25	40	25	100	65	2 x 15218	2,370
11.300.40.32	40	32	100	72	2 x 15220	2,710
11.300.40.40	40	40	120	90	2 x 15220	4,280
11.300.50.06	50	6	63	25	15106	2,860
11.300.50.08	50	8	63	28	15108	2,890
11.300.50.10	50	10	63	35	15110	2,920
11.300.50.12	50	12	63	42	15212	3,070
11.300.50.14	50	14	63	44	15212	3,110
11.300.50.16	50	16	63	48	15314	3,170
11.300.50.18	50	18	63	50	15314	3,190
11.300.50.20	50	20	63	52	15216	3,260
11.300.50.25	50	25	80	65	2 x 15218	3,910
11.300.50.32	50	32	100	72	2 x 15220	4,670
11.300.50.40	50	40	120	90	2 x 15220	6,310
11.300.50.50	50	50	120	98	2 x 15024	6,700

42.300

 I182

Ref. / Bez.

Accessories / Zubehör

42.300

Short and long reducing bushings DIN 1835-B Form A and B
Kurze und lange Reduzierhülsen DIN 1835-B Form A und B





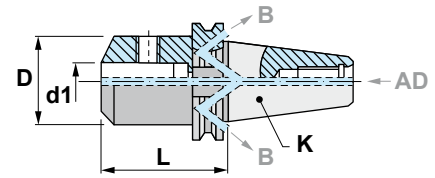

Characteristics:
Weldon end mill adaptors.
DIN 69871-A
For cutters with cylindrical shank
and Weldon flat DIN 1835-B.



Eigenschaften:
Zylinderschaft-Aufnahme Weldon.
DIN 69871-A.
Für Fräser mit zylindrischem
Schaft und Weldon-Fläche DIN
1835-B.

13.300

Reference Bezeichnung	K ISO	d1 H4	L	D		
13.300.40.06	40	6	50	25	15106	0,930
13.300.40.08	40	8	50	28	15108	0,980
13.300.40.10	40	10	50	35	15110	1,050
13.300.40.12	40	12	50	42	15212	1,090
13.300.40.14	40	14	50	44	15212	1,120
13.300.40.16	40	16	63	48	15314	1,350
13.300.40.18	40	18	63	50	15314	1,370
13.300.40.20	40	20	63	52	15216	1,350
13.300.40.25	40	25	100	65	2 x 15218	2,360
13.300.40.32	40	32	100	72	2 x 15220	2,580
13.300.40.40	40	40	120	90	2 x 15220	4,260
13.300.50.06	50	6	63	25	15106	2,940
13.300.50.08	50	8	63	28	15108	2,780
13.300.50.10	50	10	63	35	15110	2,960
13.300.50.12	50	12	63	42	15212	3,070
13.300.50.14	50	14	63	44	15212	3,060
13.300.50.16	50	16	63	48	15314	3,110
13.300.50.18	50	18	63	50	15314	3,200
13.300.50.20	50	20	63	52	15216	3,220
13.300.50.25	50	25	80	65	2 x 15218	3,880
13.300.50.32	50	32	100	72	2 x 15220	4,690
13.300.50.40	50	40	120	90	2 x 15220	6,290
13.300.50.50	50	50	120	98	2 x 15024	6,740

42.300

 1182

Ref. / Bez.

Accessories / Zubehör

42.300

Short and long reducing bushings DIN 1835-B Form A and B
Kurze und lange Reduzierhülsen DIN 1835-B Form A und B



**Characteristics:**

Short end mill adaptors.

DIN 69871-A

For cutters and tooling with cylindrical shank and Weldon flat DIN 1835-B.

Eigenschaften:

Kurze Aufsteckfräsdorne.

DIN 69871-A.

Für Fräser und Werkzeuge mit zylindrischem Schaft und Weldon-Fläche DIN 1835-B.

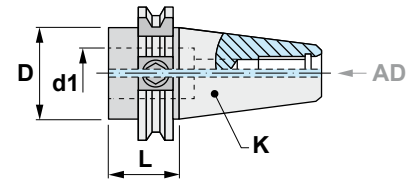

11.302

Reference Bezeichnung	K ISO	d1 H4	L	D	
11.302.30.16	30	16	32	32	0,440
11.302.30.20	30	20	34	36	0,500
11.302.40.16	40	16	35	44	0,980
11.302.40.20	40	20	35	44	1,000
11.302.40.25	40	25	35	45	0,850
11.302.40.32	40	32	45	50	0,820
11.302.50.16	50	16	35	70	3,140
11.302.50.20	50	20	35	70	3,100
11.302.50.25	50	25	35	70	2,980
11.302.50.32	50	32	35	70	2,830

Reference Bezeichnung	
11.302.30.16	15114
11.302.30.20	15014
11.302.40.16	15214
11.302.40.20	15116
11.302.40.25	15016
11.302.40.32	15020
11.302.50.16	15314
11.302.50.20	15216
11.302.50.25	15118 + 15218
11.302.50.32	15020 + 15120



Characteristics:
Short end mill adaptors.
DIN 69871-A
For cutters and tooling with cylindrical shank and Weldon flat DIN 1835-B.

Eigenschaften:
Kurze Aufsteckfräsdorne.
DIN 69871-A.
Für Fräser und Werkzeuge mit zylindrischem Schaft und Weldon-Fläche DIN 1835-B.

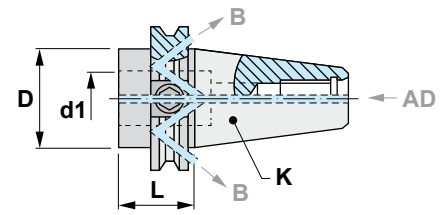

13.302

Reference Bezeichnung	K ISO	d1 H4	L	D	KG
13.302.40.16	40	16	35	44	0,950
13.302.40.20	40	20	35	44	0,890
13.302.40.25	40	25	35	45	0,840
13.302.40.32	40	32	45	50	0,800
13.302.50.16	50	16	35	70	3,030
13.302.50.20	50	20	35	70	3,070
13.302.50.25	50	25	35	70	2,910
13.302.50.32	50	32	35	70	2,790

Reference Bezeichnung	
13.302.40.16	15214
13.302.40.20	15116
13.302.40.25	15016
13.302.40.32	15020
13.302.50.16	15314
13.302.50.20	15216
13.302.50.25	15118 + 15218
13.302.50.32	15020 + 15120

42.610

I183

Ref. / Bez. Accessories / Zubehör

42.610 Tapping head with axial compensation DIN 1835-B
Gewindeschneidfutter mit Längenausgleich DIN 1835-B



42.620

I184

Ref. / Bez. Accessories / Zubehör

42.620 Quick change tapping head with axial compensation DIN 1835-B+E
Gewindeschneid-Schnellwechselfutter mit Längenausgleich DIN 1835-B+E



**Characteristics:**

End mill adaptors type Whistle-Notch.
DIN 69871-A

For tools with cylindrical shank and
tightening inclined flat DIN 1835-E.



Eigenschaften:

Whistle-Notch Zylinderschaft-Aufnahme.
DIN 69871-A.

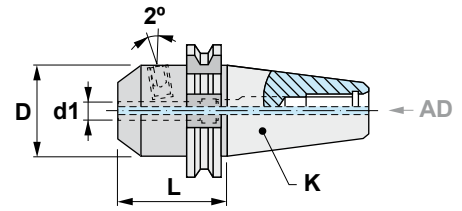
Für Werkzeuge mit zylindrischem Schaft
und geneigter Spannfläche DIN 1835-E.



11.305

Reference Bezeichnung	K ISO	d1 H4	L	D			
11.305.30.06	30	6	50	25	19005	15106	0,560
11.305.30.08	30	8	50	28	19106	15108	0,560
11.305.30.10	30	10	50	35	19008	15110	0,640
11.305.30.12	30	12	50	42	19110	15212	0,700
11.305.30.14	30	14	50	44	19110	15212	0,660
11.305.30.16	30	16	63	48	19012	15314	0,880
11.305.30.18	30	18	63	50	19012	15314	0,850
11.305.40.06	40	6	50	25	19005	15106	0,960
11.305.40.08	40	8	50	28	19106	15108	0,980
11.305.40.10	40	10	50	35	19008	15110	1,050
11.305.40.12	40	12	50	42	19110	15212	1,140
11.305.40.14	40	14	50	44	19110	15212	1,150
11.305.40.16	40	16	63	48	19012	15314	1,360
11.305.40.18	40	18	63	50	19012	15314	1,370
11.305.40.20	40	20	63	52	19016	15216	1,380
11.305.40.25	40	25	100	65	19020	2 x 15218	2,370
11.305.40.32	40	32	100	72	19020	2 x 15220	2,700
11.305.50.06	50	6	63	25	19005	15106	2,900
11.305.50.08	50	8	63	28	19106	15108	2,920
11.305.50.10	50	10	63	35	19008	15110	3,060
11.305.50.12	50	12	63	42	19110	15212	3,100
11.305.50.14	50	14	63	44	19110	15212	3,160
11.305.50.16	50	16	63	48	19012	15314	3,250
11.305.50.18	50	18	63	50	19012	15314	3,380
11.305.50.20	50	20	63	52	19016	15216	3,280
11.305.50.25	50	25	80	65	19020	2 x 15218	3,990
11.305.50.32	50	32	100	72	19020	2 x 15220	4,700
11.305.50.40	50	40	120	90	19020	2 x 15220	6,400





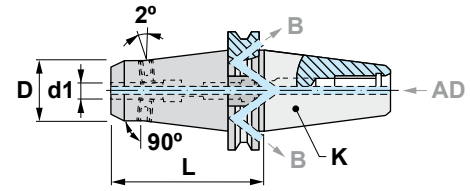

Characteristics:
Combined end mill adaptors type
Weldon / Whistle-Notch.
DIN 69871-A
For tools with cylindrical shank and
tightening inclined flat DIN 1835-B+E.



Eigenschaften:
Kombi-Aufnahme Typ Weldon /
Whistle-Notch.
DIN 69871-A.
Für Werkzeuge mit zylindrischem
Schaft und geneigter Spannfläche
DIN 1835-B+E.

13.306

Reference Bezeichnung	K ISO	d1 H4	L	D	D1	2x 	
13.306.40.06/100	40	6	100	22	28	15006	1,170
13.306.40.06/130	40	6	130	22	28	15006	1,220
13.306.40.06/160	40	6	160	22	33	15006	1,410
13.306.40.08/100	40	8	100	24	30	15008	1,130
13.306.40.08/130	40	8	130	24	30	15008	1,260
13.306.40.08/160	40	8	160	24	35	15008	1,480
13.306.40.10/100	40	10	100	30	38	15010	1,410
13.306.40.10/130	40	10	130	30	38	15010	1,480
13.306.40.10/160	40	10	160	30	39	15010	1,690
13.306.40.12/100	40	12	100	32	40	15012	1,340
13.306.40.12/130	40	12	130	32	40	15012	1,610
13.306.40.12/160	40	12	160	32	43	15012	1,870
13.306.40.14/100	40	14	100	32	40	15012	1,360
13.306.40.14/130	40	14	130	32	40	15012	1,540
13.306.40.14/160	40	14	160	32	44	15012	1,840
13.306.40.16/100	40	16	100	36	44	15114	1,450
13.306.40.16/130	40	16	130	36	44	15114	1,740
13.306.40.16/160	40	16	160	36	44	15114	1,960
13.306.40.18/100	40	18	100	38	46	15114	1,490
13.306.40.18/130	40	18	130	38	46	15114	1,800
13.306.40.18/160	40	18	160	38	46	15114	2,110
13.306.40.20/100	40	20	100	44	50	15116	1,650
13.306.40.20/130	40	20	130	44	50	15116	2,060
13.306.40.20/160	40	20	160	44	50	15116	2,420
13.306.40.25/100	40	25	100	50	50	15018	1,760
13.306.40.25/130	40	25	130	50	50	4 x 15018	2,220
13.306.40.25/160	40	25	160	50	50	4 x 15018	2,620

Reference Bezeichnung	K ISO	d1 H4	L	D	D1	2x 	
13.306.50.06/130	50	6	130	22	28	15006	3,050
13.306.50.06/160	50	6	160	22	33	15006	3,250
13.306.50.06/200	50	6	200	22	36	15006	3,500
13.306.50.08/130	50	8	130	24	30	15008	3,100
13.306.50.08/160	50	8	160	24	35	15008	3,350
13.306.50.08/200	50	8	200	24	38	15008	3,600
13.306.50.10/130	50	10	130	30	38	15010	3,330
13.306.50.10/160	50	10	160	30	39	15010	3,600
13.306.50.10/200	50	10	200	30	43	15010	4,000
13.306.50.12/130	50	12	130	32	40	15012	3,360
13.306.50.12/160	50	12	160	32	43	15012	3,660
13.306.50.12/200	50	12	200	32	46	15012	4,100
13.306.50.14/130	50	14	130	32	40	15012	3,370
13.306.50.14/160	50	14	160	32	44	15012	3,670
13.306.50.14/200	50	14	200	32	48	15012	4,200
13.306.50.16/130	50	16	130	36	44	15114	3,600
13.306.50.16/160	50	16	160	36	44	15114	3,800
13.306.50.16/200	50	16	200	36	50	15114	4,400
13.306.50.18/130	50	18	130	38	46	15114	3,600
13.306.50.18/160	50	18	160	38	46	15114	3,920
13.306.50.18/200	50	18	200	38	52	15114	4,610
13.306.50.20/100	50	20	100	44	50	15116	3,280
13.306.50.20/130	50	20	130	44	50	15116	3,840
13.306.50.20/160	50	20	160	44	50	15116	4,300
13.306.50.20/200	50	20	200	44	55	15116	4,900
13.306.50.25/130	50	25	130	50	56	4 x 15018	4,200
13.306.50.25/160	50	25	160	50	60	4 x 15018	4,800
13.306.50.25/200	50	25	200	50	64	4 x 15018	5,600
13.306.50.32/200	50	32	200	58	72	4 x 15120	6,500
13.306.50.40/200	50	40	200	66	80	4 x 15120	6,670



I



Characteristics:

Combined end mill adaptors type Weldon / Whistle-Notch.

DIN 69871-A

For tools with cylindrical shank and tightening inclined flat DIN 1835-B+E. Coolant distribution trough the centre or through the flange of the tool.

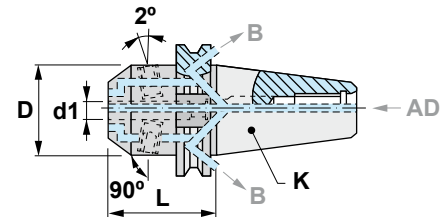



Eigenschaften:

Kombi-Aufnahme Typ Weldon / Whistle-Notch.

DIN 69871-A.

Für Werkzeuge mit zylindrischem Schaft und geneigter Spannfläche DIN 1835-B+E. Kühlmittel-Verteilung durch die Zentralbohrung oder durch den Bund.

13.307

Reference Bezeichnung	K ISO	d1 H4	L	D		2x 	
13.307.40.06	40	6	50	25	19005	15106	0,970
13.307.40.08	40	8	50	28	19106	15108	0,990
13.307.40.10	40	10	50	35	19008	15110	1,060
13.307.40.12	40	12	50	42	19110	15212	1,140
13.307.40.14	40	14	50	44	19110	15212	1,160
13.307.40.16	40	16	63	48	19012	15314	1,350
13.307.40.18	40	18	63	50	19012	15314	1,380
13.307.40.20	40	20	63	52	19016	15216	1,380
13.307.40.25	40	25	100	65	19020	4 x 15218	2,360
13.307.40.32	40	32	100	72	19020	4 x 15220	2,560
13.307.50.06	50	6	63	25	19005	15106	2,910
13.307.50.08	50	8	63	28	19106	15108	2,840
13.307.50.10	50	10	63	35	19008	15110	2,920
13.307.50.12	50	12	63	42	19110	15212	3,210
13.307.50.14	50	14	63	44	19110	15212	3,080
13.307.50.16	50	16	63	48	19012	15314	3,210
13.307.50.18	50	18	63	50	19012	15314	3,350
13.307.50.20	50	20	63	52	19016	15216	3,300
13.307.50.25	50	25	80	65	19020	4 x 15218	3,970
13.307.50.32	50	32	100	72	19020	4 x 15220	4,740
13.307.50.40	50	40	120	90	19020	4 x 15220	5,990



Characteristics:
Mill adaptors.
DIN 69871-A
For frontal end mill support
screwed shanks.

Eigenschaften:
Spannfutter.
DIN 69871-A.
Für Einschraubfräser.

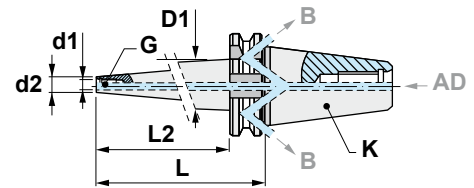

13.315

Reference Bezeichnung	K ISO	L	d1	G	d2	L2	D1	
13.315.40.10/045	40	45	10,5	M10	18	25	20	0,910
13.315.40.10/070	40	70	10,5	M10	18	50	23	0,960
13.315.40.10/120	40	120	10,5	M10	18	100	29	1,150
13.315.40.12/045	40	45	12,5	M12	21	25	24	0,920
13.315.40.12/070	40	70	12,5	M12	21	50	26	0,980
13.315.40.12/120	40	120	12,5	M12	21	100	32	1,260
13.315.40.16/045	40	45	17,0	M16	29	25	32	0,930
13.315.40.16/070	40	70	17,0	M16	29	50	35	1,040
13.315.40.16/120	40	120	17,0	M16	29	100	40	1,530
13.315.50.12/070	50	70	12,5	M12	21	50	26	2,810
13.315.50.12/120	50	120	12,5	M12	21	100	32	3,110
13.315.50.12/170	50	170	12,5	M12	21	150	37	3,450
13.315.50.16/070	50	70	17,0	M16	29	50	35	2,910
13.315.50.16/120	50	120	17,0	M16	29	100	40	3,370
13.315.50.16/170	50	170	17,0	M16	29	150	45	3,910



Characteristics:

Antivibratory end mill adaptors. DIN 69871-A
For frontal end mill support screwed shanks.
Manufactured with materials and mechanisms having antivibration properties.
Standard and extra long lengths, suitable for moulding and special manufactures.

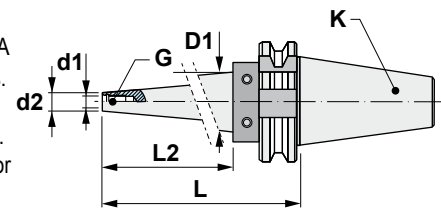

PRE-BALANCED

ISO-40: 15.000 r.p.m. G-6,3

ISO-50: 10.000 r.p.m. G-6,3

Eigenschaften:

Schwingungsgedämpfte
Aufsteckfräsdorne für Einschraubfräser. DIN 69871-A
Hergestellt mit schwingungsdämpfenden Materialien und Mechanismen.
Standard und extralange Ausführungen sind für Werkzeug- und Formenbau besonders geeignet.

VORGEWUCHTET

ISO-40: 15.000 r.p.m. G-6,3

ISO-50: 10.000 r.p.m. G-6,3

A11.315

Reference Bezeichnung	K ISO	L2	D1	L	D	d1	G	d2	⚖️
A11.315.40.10/200	40	165	35	200	50	10,5	M10	18	1,740
A11.315.40.10/250	40	215	41	250	50	10,5	M10	18	2,160
A11.315.40.10/300	40	265	46	300	50	10,5	M10	18	2,750
A11.315.40.12/200	40	165	38	200	50	12,5	M12	21	2,110
A11.315.40.12/250	40	215	44	250	50	12,5	M12	21	2,410
A11.315.40.12/300	40	265	49	300	50	12,5	M12	21	3,080
A11.315.40.16/200	40	165	46	200	50	17,0	M16	29	2,310
A11.315.40.16/250	40	215	48	250	50	17,0	M16	29	2,740
A11.315.40.16/300	40	265	50	300	50	17,0	M16	29	3,400
A11.315.50.12/250	50	215	44	250	80	12,5	M12	21	4,790
A11.315.50.12/300	50	265	49	300	80	12,5	M12	21	5,120
A11.315.50.12/400	50	365	60	400	80	12,5	M12	21	6,950
A11.315.50.16/250	50	215	52	250	80	17,0	M16	29	5,510
A11.315.50.16/300	50	265	57	300	80	17,0	M16	29	6,140
A11.315.50.16/400	50	365	68	400	80	17,0	M16	29	7,580
A11.315.50.16/500	50	465	78	500	80	17,0	M16	29	11,680

A11.315IK

Reference Bezeichnung	K ISO	L2	D1	L	D	d1	G	d2	⚖️
A11.315.40.10/200IK	40	165	35	200	50	10,5	M10	18	1,740
A11.315.40.10/250IK	40	215	41	250	50	10,5	M10	18	2,160
A11.315.40.12/200IK	40	165	38	200	50	12,5	M12	21	2,110
A11.315.40.12/250IK	40	215	44	250	50	12,5	M12	21	2,410
A11.315.40.16/250IK	40	215	48	250	50	17,0	M16	29	2,740
A11.315.50.12/300IK	50	265	49	300	80	12,5	M12	21	5,120
A11.315.50.16/300IK	50	265	57	300	80	17,0	M16	29	6,140

**Characteristics:**

Collet chucks for DIN 6388 collets.
DIN 69871-A
For tools with cylindrical shank
DIN 1835-B.
* Ball bearing nut, see page: I220

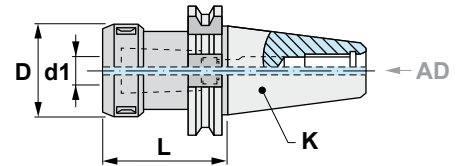





*** SUPPLIED WITHOUT WRENCH**

Eigenschaften:

Spannzangenfutter für Spannzangen
DIN 6388.
DIN 69871-A.
Für Werkzeuge mit zylindrischem
Schaft DIN 1835-B.
* Für Kugellager-Mutter, siehe Seite: I220

*** LIEFERUNG OHNE SCHLÜSSEL**

11.353

Reference Bezeichnung	K ISO	L	d1	D				
11.353.30.16	30	65	2-16	43	43316	50116	19216	0,900
11.353.30.25	30	70	3-25	60	43325	50125	19216	0,960
11.353.40.16	40	70	2-16	43	43316	50116	19216	1,120
11.353.40.16/120	40	120	2-16	43	43316	50116	19216	1,300
11.353.40.25	40	70	3-25	60	43325	50125	19224	1,270
11.353.40.25/120	40	120	3-25	60	43325	50125	19224	1,910
11.353.40.32	40	90	4-32	72	43332	50132	19224	1,780
11.353.50.16	50	70	2-16	43	43316	50116	19216	3,000
11.353.50.25	50	70	3-25	60	43325	50125	19224	2,690
11.353.50.25/120	50	120	3-25	60	43325	50125	19224	3,440
11.353.50.32	50	80	4-32	72	43332	50132	19230	3,560

BXX

 I206-208

Ref. / Bez.

Accessories / Zubehör

BXX

Collets with double slot DIN 6388 - Form B

Spannzangen mit Doppelnut DIN 6388 - Form B





Characteristics:
Strong hold collet chuck for cylindrical collets.
DIN 69871-A

Eigenschaften:
Kraftspannfutter für zylindrische Spannzangen.
DIN 69871-A

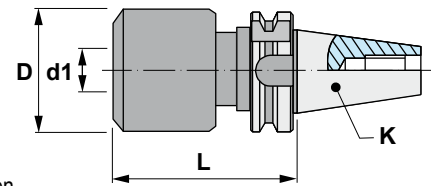

11.400

Reference Bezeichnung	K ISO	L	d1	D	
11.400.40.20	40	105	20	54	1,950
11.400.40.32	40	105	32	72	2,550
11.400.50.20	50	105	20	54	3,850
11.400.50.32	50	105	32	72	4,450

Complements (Collets type C) / Zubehör (Spannzangen Typ C)

Reference / Bezeichnung	d	D	L
C2006	6	20	55
C2008	8	20	55
C2010	10	20	55
C2012	12	20	55
C2016	16	20	55
C3206	6	32	65
C3208	8	32	65
C3210	10	32	65
C3212	12	32	65
C3216	16	32	65
C3220	20	32	65
C3225	25	32	65

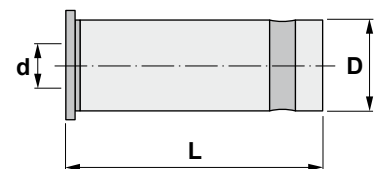

**Characteristics:**

Set of strong hold milling chuck and collets.
DIN 69871-A / BT

Eigenschaften:

Satz mit Kraftspannfutter und Spannzangen.
DIN 69871-A / BT

SET-C20/32

Reference Bezeichnung	DIN	Composition Bestehend aus	 Kg
SET-11.40.C20	DIN 69871-A	1 x 11.400.40.20 + 5 collets / Spannzangen	4,500
SET-11.40.C32	DIN 69871-A	1 x 11.400.40.32 + 7 collets / Spannzangen	6,700
SET-11.50.C32	DIN 69871-A	1 x 11.400.50.32 + 7 collets / Spannzangen	9,150





Characteristics:
Collet chucks for DIN 6499 (ER) collets.
DIN 69871-A
For tools with cylindrical shank DIN 1835-B.
* Ball bearing nut, see page: I221

Eigenschaften:
Spannzangenfutter DIN 69871-A für
Spannzangen DIN 6499 (ER).
Für Werkzeuge mit zylindrischem Schaft
DIN 1835-B.
* Für Kugellager-Mutter, siehe Seite: I221

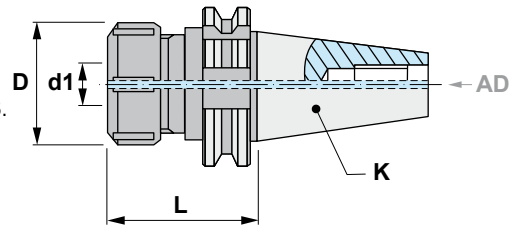

*** SUPPLIED WITHOUT WRENCH**
*** LIEFERUNG OHNE SCHLÜSSEL**

11.453

Reference Bezeichnung	K ISO		L	d1	D				
11.453.30.16	30	ER16	55	0,5-10	32	45316	50216	19210	0,490
11.453.30.20	30	ER20	55	1-13	35	45320	50220	19212	0,500
11.453.30.25	30	ER25	55	1-16	42	45325	50225	19216	0,530
11.453.30.32	30	ER32	60	2-20	50	45332	50232	19218	0,600
11.453.40.16	40	ER16	70	0,5-10	32	45316	50216	19210	0,990
11.453.40.16/100	40	ER16	100	0,5-10	32	45316	50216	19210	1,100
11.453.40.16/150	40	ER16	150	0,5-10	32	45316	50216	19210	1,280
11.453.40.20	40	ER20	70	1-13	35	45320	50220	19212	1,020
11.453.40.20/100	40	ER20	100	1-13	35	45320	50220	19212	1,170
11.453.40.20/150	40	ER20	150	1-13	35	45320	50220	19212	1,400
11.453.40.25	40	ER25	70	1-16	42	45325	50225	19216	1,090
11.453.40.25/100	40	ER25	100	1-16	42	45325	50225	19216	1,160
11.453.40.25/150	40	ER25	150	1-16	42	45325	50225	19216	1,780
11.453.40.32	40	ER32	70	2-20	50	45332	50232	19222	1,150
11.453.40.32/100	40	ER32	100	2-20	50	45332	50232	19222	1,310
11.453.40.32/150	40	ER32	150	2-20	50	45332	50232	19222	1,650
11.453.40.40	40	ER40	70	3-30	63	45340	50240	19224	1,280
11.453.40.40/100	40	ER40	100	3-30	63	45340	50240	19224	1,340
11.453.40.40/150	40	ER40	150	3-30	63	45340	50240	19224	2,430
11.453.50.16/100	50	ER16	100	0,5-10	32	45316	50216	19210	3,010
11.453.50.16/150	50	ER16	150	0,5-10	32	45316	50216	19210	3,100
11.453.50.20/100	50	ER20	100	1-13	35	45320	50220	19212	3,100
11.453.50.20/150	50	ER20	150	1-13	35	45320	50220	19212	3,300
11.453.50.25	50	ER25	70	1-16	42	45325	50225	19216	2,980
11.453.50.25/150	50	ER25	150	1-16	42	45325	50225	19216	3,540
11.453.50.32	50	ER32	70	2-20	50	45332	50232	19222	3,030
11.453.50.32/100	50	ER32	100	2-20	50	45332	50232	19222	3,100
11.453.50.32/150	50	ER32	150	2-20	50	45332	50232	19222	3,890
11.453.50.40	50	ER40	80	3-30	63	45340	50240	19224	3,310
11.453.50.40/150	50	ER40	150	3-30	63	45340	50240	19224	4,690
11.453.50.50	50	ER50	90	10-34	78	45350	50250	19230	3,700

ERXX I210-212

Reference / Bezeichnung

ERXX



40.453.. I180

Reference / Bezeichnung

40.453..



ERCXX I215-216

Reference / Bezeichnung

ERCXX



40.455.. I181

Reference / Bezeichnung

40.455..



ERTXX I217-218

Reference / Bezeichnung

ERTXX



**Characteristics:**



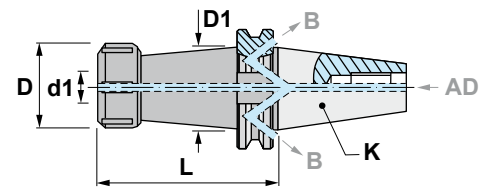

Collet chucks for DIN 6499 (ER) collets.
DIN 69871-A
For tools with cylindrical shank
DIN 1835-B.
* Ball bearing nut, see page: I221

**Eigenschaften:**

Spannzangenfutter DIN 69871-A für
Spannzangen DIN 6499 (ER).
Für Werkzeuge mit zylindrischem Schaft
DIN 1835-B.
* Für Kugellager-Mutter, siehe Seite: I221

*** SUPPLIED WITHOUT WRENCH**
*** LIEFERUNG OHNE SCHLÜSSEL**

13.453

Reference Bezeichnung	K ISO		L	d1	D	D1				
13.453.40.16	40	ER16	70	0,5-10	32	-	45316	50216	19210	0,980
13.453.40.16/100	40	ER16	100	0,5-10	32	28	45316	50216	19210	1,090
13.453.40.16/150	40	ER16	150	0,5-10	32	28	45316	50216	19210	1,260
13.453.40.20	40	ER20	70	1-13	35	-	45320	50220	19212	1,020
13.453.40.20/100	40	ER20	100	1-13	35	34	45320	50220	19212	1,160
13.453.40.20/150	40	ER20	150	1-13	35	34	45320	50220	19212	1,400
13.453.40.25	40	ER25	70	1-16	42	-	45325	50225	19216	1,080
13.453.40.25/150	40	ER25	150	1-16	42	42	45325	50225	19216	1,690
13.453.40.32	40	ER32	70	2-20	50	-	45332	50232	19222	1,140
13.453.40.32/100	40	ER32	100	2-20	50	50	45332	50232	19222	1,310
13.453.40.32/150	40	ER32	150	2-20	50	50	45332	50232	19222	2,010
13.453.40.40	40	ER40	70	3-30	63	-	45340	50240	19224	1,270
13.453.40.40/150	40	ER40	150	3-30	63	63	45340	50240	19224	1,970
13.453.50.16/100	50	ER16	100	0,5-10	32	28	45316	50216	19210	2,910
13.453.50.16/150	50	ER16	150	0,5-10	32	28	45316	50216	19210	3,070
13.453.50.20/100	50	ER20	100	1-13	35	34	45320	50220	19212	3,030
13.453.50.20/150	50	ER20	150	1-13	35	34	45320	50220	19212	3,260
13.453.50.25	50	ER25	70	1-16	42	-	45325	50225	19216	2,960
13.453.50.25/150	50	ER25	150	1-16	42	42	45325	50225	19216	3,530
13.453.50.32	50	ER32	70	2-20	50	-	45332	50232	19222	2,980
13.453.50.32/100	50	ER32	100	2-20	50	50	45332	50232	19222	3,050
13.453.50.32/150	50	ER32	150	2-20	50	50	45332	50232	19222	3,820
13.453.50.32/200	50	ER32	200	2-20	50	50	45332	50232	19222	4,150
13.453.50.40	50	ER40	80	3-30	63	-	45340	50240	19224	3,320
13.453.50.40/150	50	ER40	150	3-30	63	63	45340	50240	19224	4,670
13.453.50.40/200	50	ER40	200	3-30	63	63	45340	50240	19224	4,958
13.453.50.50	50	ER50	90	10-34	78	-	45350	50250	19230	2,950

ERXX
 I210-212

Reference / Bezeichnung

ERXX

**40.453..**
 I180

Reference / Bezeichnung

40.453..

**ERCXX**
 I215-216

Reference / Bezeichnung

ERCXX

**40.455..**
 I181

Reference / Bezeichnung

40.455..

**ERTXX**
 I217-218

Reference / Bezeichnung

ERTXX





Characteristics:
Long collet chuck for
DIN 6499 (ER) collets.
DIN 69871-A
For tools with cylindrical shank
With "mini" collet nut.

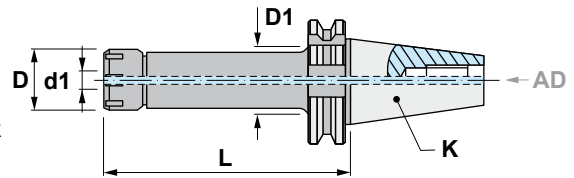

*** SUPPLIED WITHOUT WRENCH**

Eigenschaften:
Lange Spannzangenfutter für
Spannzangen DIN 6499 (ER).
DIN 69871-A
Für Werkzeuge mit zylindrischem
Schaft.
Mit "Mini"-Spannmutter.

*** LIEFERUNG OHNE SCHLÜSSEL**

11.455

Reference Bezeichnung	K ISO		L	d1	D	D1				
11.455.40.16/100	40	ER16	100	0,5-10	22	22	45516	50916	19210	1,050
11.455.40.16/130	40	ER16	130	0,5-10	22	22	45516	50916	19210	1,140
11.455.40.16/160	40	ER16	160	0,5-10	22	22	45516	50916	19210	1,200
11.455.40.16/200	40	ER16	200	0,5-10	22	22	45516	50916	19210	1,310
11.455.40.20/100	40	ER20	100	1-13	28	28	45520	50920	19212	1,180
11.455.40.20/160	40	ER20	160	1-13	28	28	45520	50920	19212	1,430
11.455.40.25/100	40	ER25	100	1-16	35	35	45525	50925	19216	1,380
11.455.40.25/160	40	ER25	160	1-16	35	35	45525	50925	19216	1,770

ERXX

 I210-212

Ref. / Bez. Accessories / Zubehör

ERXX Collets with double slot DIN 6499 - Form B (ER)
Spannzangen mit Doppelnut DIN 6499 - Form B (ER)



ERCXX

 I215-216

Ref. / Bez. Accessories / Zubehör

ERCXX Sealed collets DIN 6499 (ER)
Abgedichtete Spannzangen DIN 6499 (ER)



ERTXX

 I217-218

Ref. / Bez. Accessories / Zubehör

ERTXX Collets DIN 6499 - Form Mexin (ER)
Spannzangen DIN 6499 - Form Mexin (ER)





Characteristics:

Mechanical collet chuck with high tightening torque and precision.

DIN 69871-A

For DIN 6499 (ER) collets.

The alternative to hydraulic or other systems. Central coolant supply.

*** SUPPLIED WITH WRENCH**

Eigenschaften:

Mechanisches Spannzangenfutter mit hohem Anzugsmoment.

DIN 69871-A

Für Spannzangen DIN 6499 (ER).

Die Alternative zu hydraulischen und anderen Systemen. Mit Innenkühlung.

*** LIEFERUNG MIT SCHLÜSSEL**

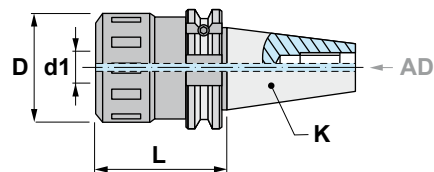

11.457

Reference Bezeichnung	K ISO		L	d1	D				
11.457.40.32	40	ER32	80	2-20	54	45732	50704	19006	1,420
11.457.50.32	50	ER32	110	2-20	54	45732	50704	19006	3,580
11.457.50.40	50	ER40	120	3-30	65	45740	50706	19010	4,480

ERXX

 I210-212

Ref. / Bez.

Accessories / Zubehör

ERXX

Collets with double slot DIN 6499 - Form B (ER)
Spannzangen mit Doppelnut DIN 6499 - Form B (ER)



ERCXX

 I215-216

Ref. / Bez.

Accessories / Zubehör

ERCXX

Sealed collets DIN 6499 (ER)
Abgedichtete Spannzangen DIN 6499 (ER)





Characteristics:

Mechanical collet chuck with high tightening torque and precision.
DIN 69871-A
For DIN 6499 (ER) collets.

The alternative to hydraulic or other systems. Central coolant supply.

*** SUPPLIED WITH WRENCH**

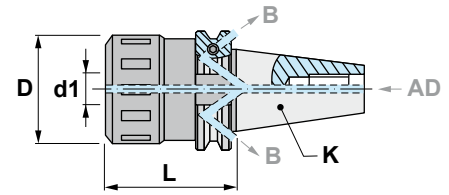





Eigenschaften:

Mechanisches Spannzangenfutter mit hohem Anzugsmoment.
DIN 69871-A
Für Spannzangen DIN 6499 (ER).

Die Alternative zu hydraulischen und anderen Systemen. Mit Innenkühlung.

*** LIEFERUNG MIT SCHLÜSSEL**

13.457

Reference Bezeichnung	K ISO		L	d1	D				
13.457.40.32	40	ER32	80	2-20	54	45732	50704	19006	1,420
13.457.50.32	50	ER32	110	2-20	54	45732	50704	19006	3,560
13.457.50.40	50	ER40	120	3-30	65	45740	50706	19010	4,530

ERXX

 I210-212

Ref. / Bez. Accessories / Zubehör

ERXX Collets with double slot DIN 6499 - Form B (ER)
Spannzangen mit Doppelnut DIN 6499 - Form B (ER)



ERCXX

 I215-216

Ref. / Bez. Accessories / Zubehör

ERCXX Sealed collets DIN 6499 (ER)
Abgedichtete Spannzangen DIN 6499 (ER)





Characteristics:
Blank adaptors.
DIN 69871-A

Eigenschaften:
Rohlinge.
DIN 69871-A

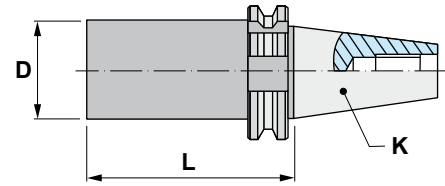

11.470

Reference Bezeichnung	K ISO	D	L	 Kg
11.470.30.40	30	40,5	160	1,940
11.470.40.63/250	40	63,5	250	6,450
11.470.50.95/315	50	95,5	315	19,000



Characteristics:

Cooling fluid supply unit.
DIN 69871-A similar to DIN 6359
For tools with cylindrical shank
DIN 1835-B/E.
* Other sizes are manufactured on request.

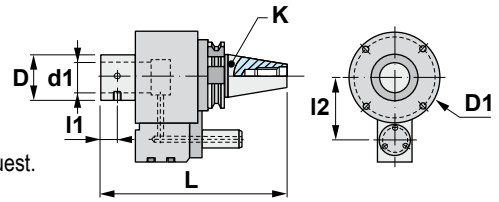



rpm max 4.000 min. -1 □ 25 bar max

Eigenschaften:

Drehverteiler für Innenkühlung.
DIN 69871-A ähnlich wie DIN 6359
für Werkzeuge mit zylindrischem
Schaft DIN 1835-B/E
* Andere Größen werden auf Anfrage hergestellt.

11.512

Reference Bezeichnung	K ISO	d1 G6	L	D	D1	I1	I2*		
11.512.40.25	40	25	152	45	95	15	65	14116	5,150
11.512.40.32	40	32	152	48	95	16	65	14116	5,490
11.512.50.32	50	32	152	48	90	24	80	14116	7,550
11.512.50.40	50	40	152	58	90	17	80	14116	7,680

Complements of 512 group / Zubehör von gruppe 512

Ref. / Bez.	D	d	D1	L
512.25.16	25	16	33	60
512.25.20		20	33	60
512.32.16	32	16	40	60
512.32.20		20	40	60
512.32.25		25	40	60
512.40.16	40	16	48	60
512.40.20		20	48	60
512.40.25		25	48	60
512.40.32		32	48	60
512.00.00				

512..

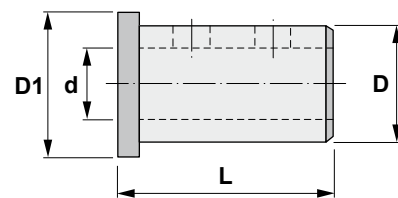

512.00.00

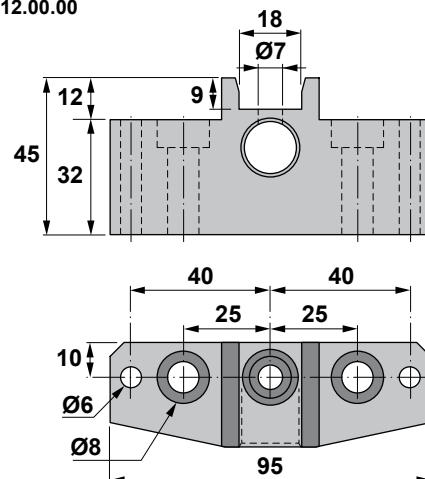



Characteristics:

Tapping head with axial compensation.
DIN 69871-A
For DIN 6499 (ER) collets and with central coolant supply.
Compensation in compression (C) and tension (T). Compression can be blocked by turning the rear ring (A).

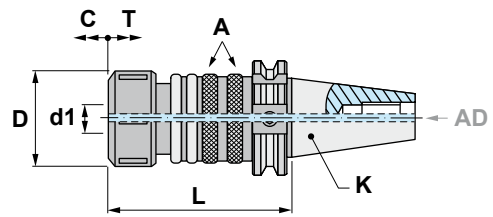

*** SUPPLIED WITH WRENCH**

Eigenschaften:

Gewindeschneidfutter mit Längenausgleich DIN 69871-A. Befestigung mit Spannzangen 6499 (ER) und mit Innenkühlung. Ausgleich der Kompression (C) und der Traktion (T). Die Kompression kann mit dem Ring (A) blockiert werden.

*** LIEFERUNG MIT SCHLÜSSEL**

11.610

Reference Bezeichnung	K ISO			d1	L	D	C	T			
11.610.30.16	30	ER16	M3-M12	99	28	5,5	6,0	45316	50216	0,890	
11.610.40.16	40	ER16	M3-M12	100	28	5,5	6,0	45316	50216	1,300	
11.610.40.25	40	ER25	M4-M20	125	42	10,5	7,5	45325	50225	1,690	
11.610.40.40	40	ER40	M8-M33	141	63	10,0	10,0	45340	50240	3,200	
11.610.50.16	50	ER16	M3-M12	100	28	5,5	6,0	45316	50216	3,620	
11.610.50.25	50	ER25	M4-M20	134	42	10,5	7,5	45325	50225	4,150	
11.610.50.40	50	ER40	M8-M33	150	63	10,0	10,0	45340	50240	4,520	

ERXX

I210-212

Ref. / Bez. Accessories / Zubehör

ERXX Collets with double slot DIN 6499 - Form B (ER)
Spannzangen mit Doppelnut DIN 6499 - Form B (ER)



ERCXX

I215-216

Ref. / Bez. Accessories / Zubehör

ERCXX Sealed collets DIN 6499 (ER)
Abgedichtete Spannzangen DIN 6499 (ER)



ERTXX

I217-218

Ref. / Bez. Accessories / Zubehör

ERTXX Collets DIN 6499 - Form Mexin (ER)
Spannzangen DIN 6499 - Form Mexin (ER)



40.453..

I180

Ref. / Bez. Accessories / Zubehör

40.453.. Collet chucks for DIN 6499 (ER) collets
Spannzangenfutter für DIN 6499 (ER) Spannzangen



40.455..

I181

Ref. / Bez. Accessories / Zubehör

40.455.. Long collet chucks for DIN 6499 (ER) collets
Lange Spannzangenfutter für DIN 6499 (ER) Spannzangen





Characteristics:

Tapping head with axial compensation.
DIN 69871-A

For DIN 6499 (ER) collets and with central coolant supply.

Compensation in compression (C) and tension (T). Compression can be blocked by turning the rear ring (A).

Control of threading depth.

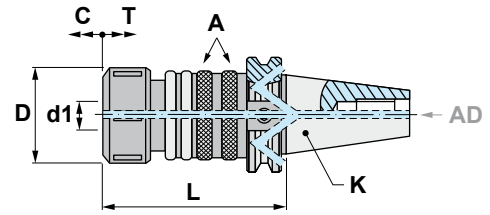

*** SUPPLIED WITH WRENCH**

Eigenschaften:

Gewindeschneidfutter mit Längenausgleich DIN 69871-A.

Befestigung mit Spannzangen 6499 (ER) und mit Innenkühlung.

Ausgleich der Kompression (C) und der Traktion (T). Die Kompression kann mit dem Ring (A) blockiert werden. Kontrolle der Gewindetiefe.

*** LIEFERUNG MIT SCHLÜSSEL**

13.610

Reference Bezeichnung	K ISO			d1	L	D	C	T		
13.610.40.16	40	ER16	M3-M12	100	28	5,5	6,0	45316	50216	1,430
13.610.40.25	40	ER25	M4-M20	125	42	10,5	7,5	45325	50225	1,990
13.610.40.40	40	ER40	M8-M33	141	63	10,0	10,0	45340	50240	3,200
13.610.50.16	50	ER16	M3-M12	100	28	5,5	6,0	45316	50216	3,480
13.610.50.25	50	ER25	M4-M20	134	42	10,5	7,5	45325	50225	4,150
13.610.50.40	50	ER40	M8-M33	150	63	10,0	10,0	45340	50240	5,360

ERXX

I210-212

Ref. / Bez. Accessories / Zubehör

ERXX Collets with double slot DIN 6499 - Form B (ER)
Spannzangen mit Doppelnut DIN 6499 - Form B (ER)



ERCXX

I215-216

Ref. / Bez. Accessories / Zubehör

ERCXX Sealed collets DIN 6499 (ER)
Abgedichtete Spannzangen DIN 6499 (ER)



ERTXX

I217-218

Ref. / Bez. Accessories / Zubehör

ERTXX Collets DIN 6499 - Form Mexin (ER)
Spannzangen DIN 6499 - Form Mexin (ER)



40.453..

I180

Ref. / Bez. Accessories / Zubehör

40.453.. Collet chucks for DIN 6499 (ER) collets
Spannzangenfutter für DIN 6499 (ER) Spannzangen



40.455..

I181

Ref. / Bez. Accessories / Zubehör

40.455.. Long collet chucks for DIN 6499 (ER) collets
Lange Spannzangenfutter für DIN 6499 (ER) Spannzangen



**Characteristics:**

Quick change tapping head with axial compensation.

DIN 69871-A

With Bilz system tap chucks bushings.

Compensation in compression (C) and tension (T).

Eigenschaften:

Gewindeschneid-Schnellwechselfutter mit Längenausgleich.



DIN 69871-A

Mit Schnellwechseleinsätze Bilz-System.

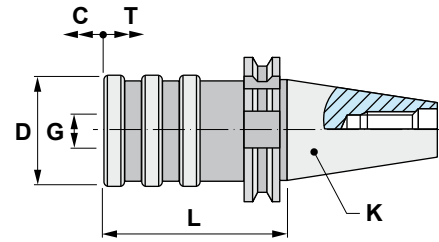
Ausgleich der Kompression (C) und der Traktion (T).



11.620

Reference Bezeichnung	K ISO	N ^o G Ø	d1	L	D	C	T			
11.620.30.12	30	1 19	M3-M12	63	38	9	9	710XX	750XX	0,620
11.620.40.12	40	1 19	M3-M12	68	38	9	9	710XX	750XX	1,060
11.620.40.20	40	2 31	M8-M20	93	55	15	15	720XX	760XX	1,660
11.620.40.33	40	3 48	M14-M33	138	79	24	24	730XX	770XX	3,490
11.620.50.12	50	1 19	M3-M12	80	38	9	9	710XX	750XX	2,960
11.620.50.20	50	2 31	M8-M20	102	55	15	15	720XX	760XX	3,410
11.620.50.33	50	3 48	M14-M33	135	79	24	24	730XX	770XX	5,110

710XX..730XX

 I202

Ref. / Bezeichnung

Accessories / Zubehör

710XX..730XX

Quick change adapters without overload clutch

Schnellwechseleinsätze ohne Sicherheitskupplung



750XX..770XX

 I203

Ref. / Bezeichnung

Accessories / Zubehör

750XX..770XX

Quick change adapters with overload clutch

Schnellwechseleinsätze mit Sicherheitskupplung





Characteristics:

Quick change tapping head for rigid tapping. DIN69871-A.
With Bilz system tap chucks bushings.

With central coolant.



Eigenschaften:

Gewindeschneid-Schnellwechselfutter ohne Längenausgleich.
DIN69871-A
Mit Schnellwechseleinsätze Bilz-System.

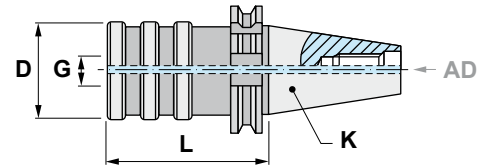
Mit Innenkühlung.



11.630

Reference Bezeichnung	K ISO	N ^o . Ø	d1	L	D			
11.630.30.12	30	1 19	M3-M12	60	33	710XX	750XX	1,000
11.630.40.12	40	1 19	M3-M12	67	33	710XX	750XX	1,040
11.630.40.20	40	2 31	M8-M20	90	50	720XX	760XX	1,510
11.630.40.33	40	3 48	M14-M33	117	72	730XX	770XX	3,150
11.630.50.12	50	1 19	M3-M12	78	33	710XX	750XX	3,100
11.630.50.20	50	2 31	M8-M20	101	50	720XX	760XX	3,830
11.630.50.33	50	3 48	M14-M33	125	72	730XX	770XX	5,200

710XX..730XX



Ref. / Bezeichnung

Accessories / Zubehör

710XX..730XX

Quick change adapters without overload clutch
Schnellwechseleinsätze ohne Sicherheitskupplung



750XX..770XX



Ref. / Bezeichnung

Accessories / Zubehör

750XX..770XX

Quick change adapters with overload clutch
Schnellwechseleinsätze mit Sicherheitskupplung





Characteristics:
Test arbors.
DIN 69871-A

Eigenschaften:
Prüfdorne.
DIN 69871-A

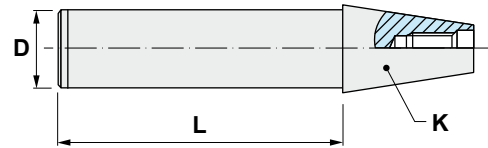

11.999

Reference Bezeichnung	K ISO	L	D	 Kg
11.999.30	30	300	32	4,450
11.999.40	40	300	40	5,450
11.999.50	50	300	50	7,000

1 TYPE / TYP

11.160	11.165	11.180	11.210	11.215	11.216	11.225	11.226	11.290
11.295	11.296	11.300	11.302	11.305	11.353	11.400	11.453	11.455
11.457	11.470	11.512	11.610	11.620	11.630	A11.160IK	A11.160	A11.160
A11.315IK	A11.315	13.160	13.210	13.215	13.296	13.300	13.302	13.306
13.307	13.315	13.453	13.457	13.610				

2 DIMENSION / ABMESSUNGEN

30	40	50	60
-----------	-----------	-----------	-----------

3 LENGTH / LÄNGE (L)

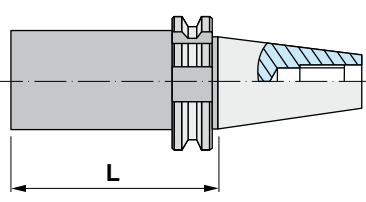
	<hr/> <hr/> <hr/> <hr/> <hr/>
---	-------------------------------

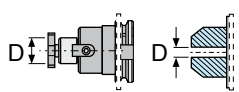
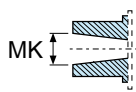
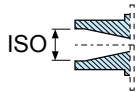
<p>Ø DIAMETER / DURCHMESSER</p> 	<p>MK</p> 	<p>ISO</p> 	<p>COLLET SPANNZANGEN</p>

NOTES / BEMERKUNGEN: _____



HSK DIN 69893-1

Code system Kodifizierung	178
Technical information Technische Auskünfte	179
Applications index Anwendungen	180
Arbors and adaptors HSK DIN 69893-1 Aufnahmen HSK DIN 69893-1	181-96
Antivibratory adaptors HSK DIN 69893-1 Schwingungsgedämpfte Aufnahmen HSK DIN 69893-1	182-83,91
Special tool request Sonderwerkzeug-Anfrage	197



AT3 TECHNICAL CHARACTERISTICS OF THE TOOLHOLDERS AT3 TECHNISCHE EIGENSCHAFTEN DER AUFNAHMEN

MATERIAL:

- Chromium-manganese carburised steel 1.7131 (16MnCr5).

EXECUTION:

- Carburised, hardened and tempered.
- Surface hardness HRC 58±2 (670±40 HV30)
- Depth of carburised layer minimum 0,5 mm.
- Tensile strength in core minimum 800 N/mm² after carburizing.

ACCURACY:

- Taper according to DIN 254
- Taper angle:
tolerance AT 3 DIN 7178 part 1 and DIN 2080 part 1.
- Other tolerances according to DIN 7160 and 7168.
- Taper surface roughness RZ<0,001 mm.

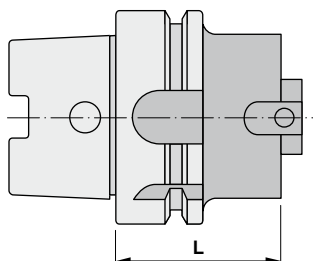

PREBALANCED TOOLHOLDERS VORGEWUCHTETE AUFNAHMEN

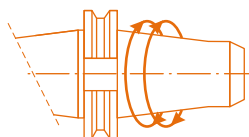

ISO 40 ▶ 8000 rpm ISO 50 ▶ 8000 rpm

MATERIALIEN:

- Legierter aufgekohlter Stahl mit Chrom-Mangan 1.7131 (16MnCr5).

KONSTRUKTIONS DATEN:

- Aufgekühlt, gehärtet und angelassen.
- Oberflächenhärte HRC 58±2 (670±40 HV30)
- Aufgekühlt auf minimum 0,5 mm Tiefe.
- Zugfestigkeit im Kern minimum 800 N/mm² nach der Aufkohlung.

GENAUIGKEIT:

- Dorn nach DIN 254
- Kegelminkel:
Toleranz AT 3 DIN 7178 Teil 1 und DIN 2080 Teil 1.
- Andere Toleranzen entsprechend DIN 7160 und 7168.
- Rauigkeit der Oberfläche RZ<0,001 mm.

K	AT3 mm
ISO 30	0,002
ISO 40	0,003
ISO 45	0,003
ISO 50	0,004
ISO 60	0,005

TOLERANCE AT:

- Indicates the tolerance of measuring plane D between the real and the theoretical value of the taper conicity.
- This value of measuring plane D must always be less (negative), never more (positive) in order to GUARANTEE a good toolholder fixation at the bigger taper diameter.

TOLERANZ AT:

- Zeigt die Toleranz auf der Messebene D zwischen dem tatsächlichen Wert der Kegelminkelkonizität und dem theoretischen Wert.
- Dieser Wert auf der Messebene D sollte immer minus (negativ) sein, nie plus (positiv), um für einen guten Halt des Futter in den größeren Durchmesser des Kegels zu GARANTIEREN.

16 DIN 69893-HSK-A

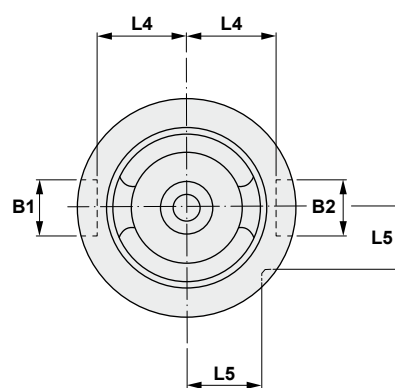
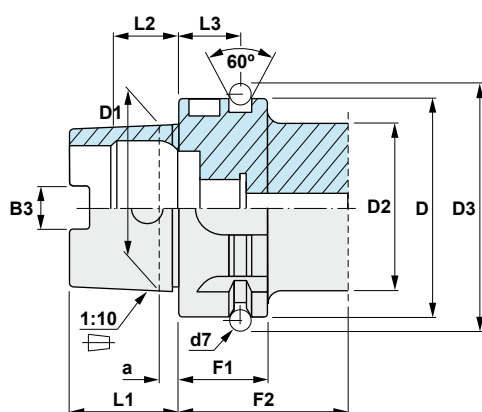

HSK	Dh10	D1	D2 max	D3 -0,1	B1 H10	B2 H10	B3±0,4	d7	L1 -0,2	L2Js10	L3±0,1	L4 -0,2	L5 -0,3	F1 -0,1	F2 min	a
32	32	24	26	37,0	9	7	7,05	4	16	8,92	16	13,0	9,5	20	35	3,2
40	40	30	34	45,0	11	9	8,05	4	20	11,42	16	17,0	12,0	20	35	4,0
50	50	38	42	59,3	14	12	10,54	7	25	14,13	18	21,0	15,5	26	42	5,0
63	63	48	53	72,3	18	16	12,54	7	32	18,13	18	26,5	20,0	26	42	3,3
80	80	60	67	88,8	20	18	16,04	7	40	22,85	18	34,0	25,0	26	42	8,0
100	100	75	85	109,75	22	20	20,02	7	50	28,56	20	44,0	31,5	29	45	10,0

Arbors and adaptors HSK DIN 69893-1
Aufnahmen HSK DIN 69893-1

16.160



Page / Seite 181

16.180



Page / Seite 184

16.210



Page / Seite 185

16.215



Page / Seite 186

16.296



Page / Seite 187

16.300



Page / Seite 188-89

16.305



Page / Seite 190

16.315



Page / Seite 192

16.453



Page / Seite 193

16.455



Page / Seite 194

16.470



Page / Seite 195

16.999



Page / Seite 196

Antivibratory adaptors HSK DIN 69893-1
Schwingungsgedämpfte Aufnahmen HSK DIN 69893-1

A16.160IK



Page / Seite 182

A16.160



Page / Seite 183

A16.315IK



Page / Seite 191



Characteristics:



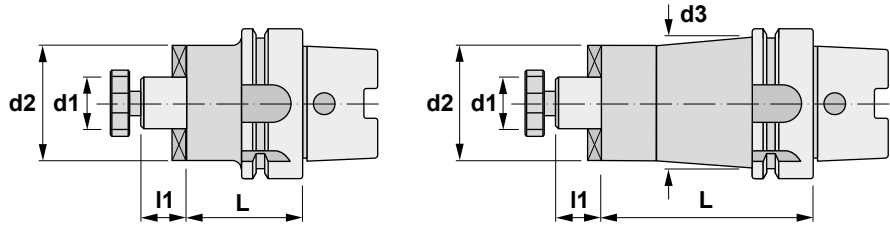

Shell mill adaptors. DIN 69893-1 / HSK Form A
For cutters with driving slot DIN 138.

Eigenschaften:

Aufsteckfräsdorne DIN 69893-1 / HSK Form A.
Für Fräser mit Quernut DIN 138.



16.160

Reference Bezeichnung	HSK	d1	L	l1	d2	d3				
16.160.063.16	63	16	50	17	38	-	10008	86016	11103	0,880
16.160.063.16/100	63	16	100	17	38	46	10008	86016	11103	1,420
16.160.063.16/160	63	16	160	17	38	46	10008	86016	11103	2,050
16.160.063.22	63	22	50	19	47	-	10010	86022	11004	1,020
16.160.063.22/100	63	22	100	19	47	53	10010	86022	11004	1,810
16.160.063.22/160	63	22	160	19	48	53	10010	86022	11004	2,720
16.160.063.27	63	27	60	21	58	-	10012	86027	11005	1,420
16.160.063.27/100	63	27	100	21	58	-	10012	86027	11005	2,240
16.160.063.27/160	63	27	160	21	58	-	10012	86027	11005	3,450
16.160.063.32	63	32	60	24	64	-	10016	86032	11105	1,620
16.160.063.32/100	63	32	100	24	64	-	10016	86032	11105	2,470
16.160.063.32/160	63	32	160	24	64	-	10016	86032	11105	3,960
16.160.063.40	63	40	60	27	80	-	10020	86040	11006	2,130
16.160.063.40/100	63	40	100	27	80	-	10020	86040	11006	3,960
16.160.100.16	100	16	50	17	38	-	10008	86016	11103	2,320
16.160.100.22	100	22	50	19	48	-	10010	86022	11004	2,450
16.160.100.27	100	27	50	21	55	-	10012	86027	11005	2,570
16.160.100.32	100	32	50	24	64	-	10016	86032	11105	2,740
16.160.100.40	100	40	60	27	80	-	10020	86040	11006	3,490





Characteristics:



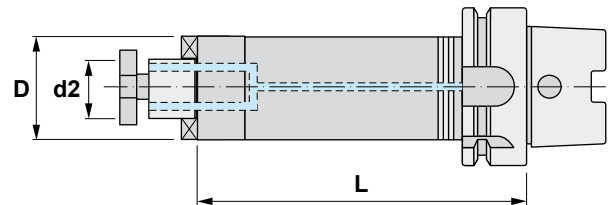

Cylindrical antivibratory shell mill adaptors.
DIN 69893-1 / HSK Form A
For cutters with driving slot DIN 138.
With internal coolant.

Eigenschaften:

Schwingungsgedämpfte Aufsteckfräsdorne.
DIN 69893-1 / HSK Form A
Für Fräser mit Quernut DIN 138.
Mit Innenkühlung.



A16.160IK

Reference Bezeichnung	HSK	L	D	d2				
A16.160.063.16/200-38IK	63	200	38	16	10008	86016	11103	2,150
A16.160.063.16/300-38IK	63	300	38	16	10008	86016	11103	3,000
A16.160.063.22/200-48IK	63	200	48	22	10010	86022	11004	3,100
A16.160.063.22/300-48IK	63	300	48	22	10010	86022	11004	4,480
A16.160.063.27/300-58IK	63	300	58	27	10012	86027	11005	4,230
A16.160.100.16/200-38IK	100	200	38	16	10008	86016	11103	3,580
A16.160.100.16/300-38IK	100	300	38	16	10008	86016	11103	4,430
A16.160.100.22/200-48IK	100	200	48	22	10010	86022	11004	4,510
A16.160.100.22/300-48IK	100	300	48	22	10010	86022	11004	5,890
A16.160.100.27/200-58IK	100	200	58	27	10012	86027	11005	5,630
A16.160.100.27/300-58IK	100	300	58	27	10012	86027	11005	7,640
A16.160.100.32/300-78IK	100	300	78	32	10016	86032	11105	10,210



Characteristics:

Cylindrical antivibratory shell mill adaptors.
 DIN 69893-1 / HSK Form A
 For cutters with driving slot DIN 138.

Eigenschaften:

Schwingungsgedämpfte Aufsteckfräsdorne.
 DIN 69893-1 / HSK Form A
 Für Fräser mit Quernut DIN 138.

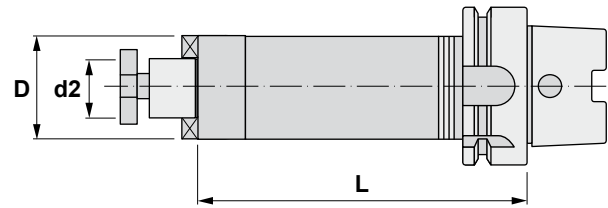

A16.160

Reference Bezeichnung	HSK	L	D	d2				
A16.160.063.16/200-38	63	200	38	16	10008	86016	11103	2,150
A16.160.063.16/300-38	63	300	38	16	10008	86016	11103	3,000
A16.160.063.22/200-48	63	200	48	22	10010	86022	11004	3,100
A16.160.063.22/300-48	63	300	48	22	10010	86022	11004	4,480
A16.160.063.27/200-58	63	200	58	27	10012	86027	11005	4,230
A16.160.100.16/200-38	100	200	38	16	10008	86016	11103	3,580
A16.160.100.16/300-38	100	300	38	16	10008	86016	11103	4,430
A16.160.100.22/200-48	100	200	48	22	10010	86022	11004	4,510
A16.160.100.22/300-48	100	300	48	22	10010	86022	11004	5,890
A16.160.100.27/200-58	100	200	58	27	10012	86027	11005	5,630
A16.160.100.27/300-58	100	300	58	27	10012	86027	11005	7,640
A16.160.100.32/300-78	100	300	78	32	10016	86032	11105	10,210

SPECIAL FOR MOULD AND DIE MAKERS

Vibration reduced up to 60% compared to any other conventional shell mill adaptor, as they are manufactured with materials and mechanisms having antivibration properties.

BESONDERS EMPFOHLEN FÜR WERKZEUG- UND FORMENBAU

60% weniger Schwingungen im Vergleich mit anderen konventionellen Aufsteckfräsdornen, da diese Ausführung mit schwingungsdämpfenden Materialien und Mechanismen hergestellt wird.

COMPARISON WHEN USING AN ANTIVIBRATORY TOOLHOLDER

VERGLEICH ZWISCHEN EINER KONVENZIONELLEN UND EINER SCHWINGUNGSGEDÄMPFTEN AUFNAHME

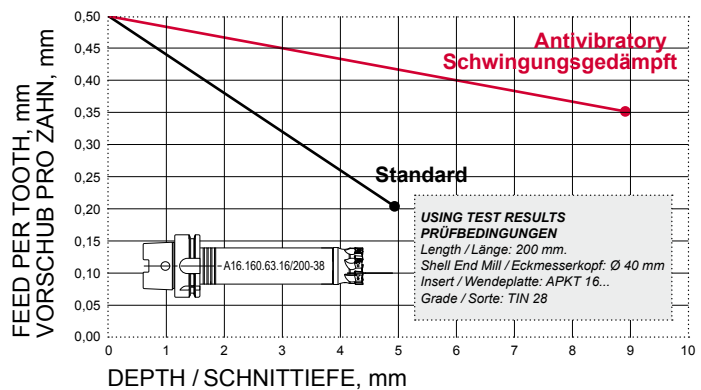



Characteristics:



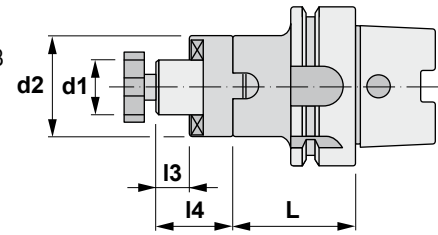

Combi-Shell mill adaptor.
HSK Form A / DIN 69893-1 / DIN 6358 - Form B
For cutters with keyway or driving slot DIN 138.

Eigenschaften:

Kombi-Aufsteckfräsdorne.
HSK Form A / DIN 69893-1 / DIN 6358 - Form B
Für Fräser mit Längsnut oder Stimmritzhemer DIN 138



16.180

Reference Bezeichnung	HSK	d1 h6	L	l3	l4	d2				
16.180.063.16	63	16	55	17	27	32	10008	60116	88016	0,910
16.180.063.16/100	63	16	100	17	27	32	10008	60116	88016	1,170
16.180.063.22	63	22	55	19	31	40	10010	60122	88022	1,090
16.180.063.22/100	63	22	100	19	31	40	10010	60122	88022	1,510
16.180.063.27	63	27	55	21	33	48	10012	60127	88027	1,290
16.180.063.27/100	63	27	100	21	33	48	10012	60127	88027	1,910
16.180.063.32	63	32	60	24	38	58	10016	60132	88032	1,740
16.180.063.32/100	63	32	100	24	38	58	10016	60132	88032	2,550
16.180.063.40	63	40	60	27	41	70	10020	60140	88040	2,270
16.180.063.40/100	63	40	100	27	41	70	10020	60140	88040	3,460
16.180.100.16	100	16	55	17	27	32	10008	60116	88016	2,350
16.180.100.22	100	22	55	19	31	40	10010	60122	88022	2,520
16.180.100.27	100	27	55	21	33	48	10012	60127	88027	2,710
16.180.100.32	100	32	60	24	38	58	10016	60132	88032	3,110
16.180.100.40	100	40	60	27	41	70	10020	60140	88040	3,590





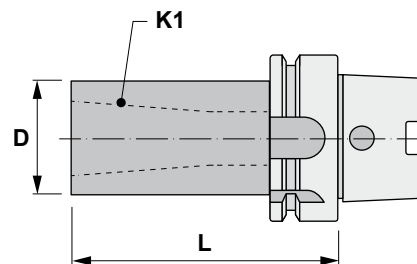

Characteristics:
Reducing adaptors.
DIN 69893-1 / HSK Form A
For tools with Morse taper shank
and drawbar thread DIN 228-A.

Eigenschaften:
Reduzierhülsen.
DIN 69893-1 / HSK Form A
Für Werkzeuge mit Morsekegel
und Anzugsgewinde DIN 228-A.



16.210

Reference Bezeichnung	HSK	K1 MORSE	L	D	
16.210.063.01	63	1	100	25	0,890
16.210.063.02	63	2	120	32	1,110
16.210.063.03	63	3	140	40	1,490
16.210.063.04	63	4	160	48	1,960
16.210.100.02	100	2	120	32	2,530
16.210.100.03	100	3	150	40	2,990
16.210.100.04	100	4	170	48	3,500
16.210.100.05	100	5	200	63	4,630

Reference Bezeichnung			
16.210.063.01	16205	19624	18006
16.210.063.02	16205	19324	18110
16.210.063.03	16205	19524	18112
16.210.063.04	16205	19424	18016
16.210.100.02	16205	19324	18110
16.210.100.03	16205	19524	18112
16.210.100.04	16205	19424	18016
16.210.100.05	16205	19338	18020





Characteristics:
Reducing adaptors.
DIN 69893-1 / HSK Form A
For tools with Morse taper shank
and tang or drawbar DIN 228-B.

Eigenschaften:
Reduzierhülsen.
DIN 69893-1 / HSK Form A.
Für Werkzeuge mit Morsekegel
und Austreibblappen oder
Anzugsgewinde DIN 228-B.

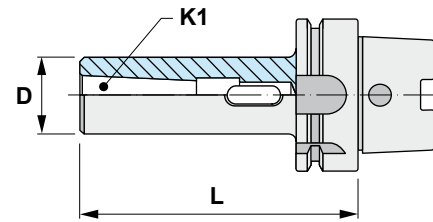

16.215

Reference Bezeichnung	HSK	K1 MORSE	L	D	
16.215.063.01	63	1	100	25	0,890
16.215.063.02	63	2	120	32	1,110
16.215.063.03	63	3	140	40	1,490
16.215.063.04	63	4	160	48	1,960
16.215.100.02	100	2	120	32	2,530
16.215.100.03	100	3	150	40	2,990
16.215.100.04	100	4	170	48	3,500
16.215.100.05	100	5	200	63	4,630



Characteristics:
CNC-Universal precision drill chucks.
DIN 69893-1 / HSK Form A
For left and right hand turn and with
internal coolant.

*** SUPPLIED WITH WRENCH**

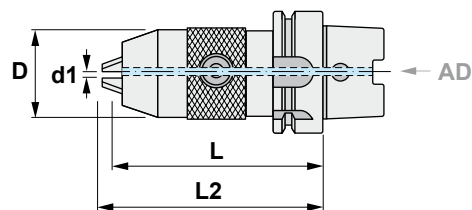

Eigenschaften:
CNC-Universal Bohrfutter,
Genauigkeitsausführung DIN
69893-1 / HSK Form A
Für links- und rechtslaufende
Bearbeitungen und mit Innenkühlung.

*** LIEFERUNG MIT SCHLÜSSEL**



16.296

Reference Bezeichnung	HSK	d1	D	L	L2 max	
16.296.063.13	63	1-13	54	98	107	1,480
16.296.063.16	63	3-16	57	109	108	1,750
16.296.100.13	100	1-13	54	110	119	3,070
16.296.100.16	100	3-16	57	113	120	3,370

Reference Bezeichnung		3x 
16.296.063.13	5006	60313
16.296.063.16	5006	60313
16.296.100.13	5006	60313
16.296.100.16	5006	60313





Characteristics:

Weldon end mill adaptors. DIN 69893-1 / HSK Form A.

For cutters with cylindrical shank and Weldon flat DIN 1835-B.



Eigenschaften:

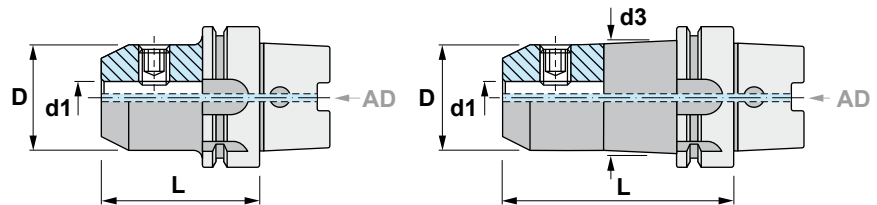

Zylinderschaft-Aufnahme Weldon DIN 69893-1 / HSK Form A.

Für Fräser mit zylindrischem Schaft und Weldon-Fläche DIN 1835-B.



16.300

Reference Bezeichnung	HSK	d1 H4	L	D	d3		
16.300.063.06	63	6	65	25	-	15106	0,780
16.300.063.06/160	63	6	160	25	30	15106	1,210
16.300.063.08	63	8	65	28	-	15108	0,810
16.300.063.08/160	63	8	160	28	32	15108	1,310
16.300.063.10	63	10	65	35	-	15110	0,900
16.300.063.10/160	63	10	160	35	32	15110	1,680
16.300.063.12	63	12	80	42	-	15212	1,150
16.300.063.12/160	63	12	160	42	45	15212	2,030
16.300.063.14	63	14	80	44	-	15212	1,190
16.300.063.14/160	63	14	160	44	48	15212	2,150
16.300.063.16	63	16	80	48	-	15314	1,290
16.300.063.16/160	63	16	160	48	52	15314	2,410
16.300.063.18	63	18	80	50	-	15314	1,330
16.300.063.18/160	63	18	160	50	52	15314	2,460
16.300.063.20	63	20	80	52	-	15216	1,360
16.300.063.20/160	63	20	160	52	-	15216	2,500
16.300.063.25	63	25	110	65	-	2 x 15218	2,280
16.300.063.32	63	32	110	72	-	2 x 15220	2,480
16.300.100.06	100	6	80	25	-	15106	2,280
16.300.100.06/160	100	6	160	25	30	15106	2,660
16.300.100.08	100	8	80	28	-	15108	2,320
16.300.100.08/160	100	8	160	28	32	15108	2,750
16.300.100.10	100	10	80	35	-	15110	2,440
16.300.100.10/160	100	10	160	35	32	15110	3,100
16.300.100.12	100	12	80	42	-	15212	2,570
16.300.100.12/160	100	12	160	42	45	15212	3,450
16.300.100.14	100	14	80	44	-	15212	2,600
16.300.100.14/160	100	14	160	44	48	15212	3,570
16.300.100.16	100	16	100	48	-	15314	2,950
16.300.100.16/160	100	16	160	48	52	15314	3,810
16.300.100.18	100	18	100	50	-	15314	2,990
16.300.100.18/160	100	18	160	50	52	15314	3,850

Reference Bezeichnung	HSK	d1 H4	L	D	d3		
16.300.100.20	100	20	100	52	-	15216	3,040
16.300.100.20/160	100	20	160	52	-	15216	3,890
16.300.100.25	100	25	100	65	-	2 x 15218	3,550
16.300.100.25/160	100	25	160	65	-	2 x 15218	4,890
16.300.100.32	100	32	100	72	-	2 x 15220	3,780
16.300.100.40	100	40	100	80	-	2 x 15024	3,960

42.300

 1182

Ref. / Bez.	Accessories / Zubehör
42.300	Short and long reducing bushings DIN 1835-B Form A and B Kurze und lange Reduzierhülsen DIN 1835-B Form A und B





Characteristics:



End mill adaptors type Whistle-Notch.
DIN 69893-1 / HSK Form A.
For tools with cylindrical shank and
tightening inclined flat DIN 1835-E.

Eigenschaften:

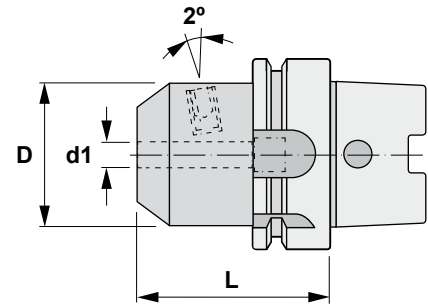
Whistle-Notch Zylinderschaft-Aufnahme.
DIN 69893-1 / HSK Form A.
Für Werkzeuge mit zylindrischem Schaft
und geneigter Spannfläche DIN 1835-E.



16.305

Reference Bezeichnung	HSK	d1 H4	L	D			
16.305.063.06	63	6	80	25	19005	15106	0,830
16.305.063.08	63	8	80	28	19106	15108	0,880
16.305.063.10	63	10	80	35	19008	15110	1,000
16.305.063.12	63	12	90	42	19110	15212	1,250
16.305.063.14	63	14	90	44	19110	15212	1,300
16.305.063.16	63	16	100	48	19012	15314	1,540
16.305.063.18	63	18	100	50	19012	15314	1,590
16.305.063.20	63	20	100	52	19016	15216	1,650
16.305.063.25	63	25	110	65	19020	15218	2,280
16.305.063.32	63	32	115	72	19020	15220	2,610
16.305.100.06	100	6	90	25	19005	15106	2,320
16.305.100.08	100	8	90	28	19106	15108	2,370
16.305.100.10	100	10	90	35	19008	15110	2,510
16.305.100.12	100	12	100	42	19110	15212	2,770
16.305.100.14	100	14	100	44	19110	15212	2,820
16.305.100.16	100	16	100	48	19012	15314	2,940
16.305.100.18	100	18	100	50	19012	15314	2,990
16.305.100.20	100	20	100	52	19016	15216	3,040
16.305.100.25	100	25	120	65	19020	15218	4,000
16.305.100.32	100	32	120	72	19020	15220	4,290
16.305.100.40	100	40	130	80	19020	15220	4,850





Characteristics:

Antivibratory end mill adaptors.
 HSK DIN 69893-1
 For frontal end mill support screwed shanks.
 Manufactured with materials and mechanisms having antivibration properties.
 Standard and extra long lengths, suitable for moulding and special manufactures.
 With internal coolant.

PRE-BALANCED

ISO-40: 15.000 r.p.m. G-6,3
 ISO-50: 10.000 r.p.m. G-6,3

Eigenschaften:

Schwingungsgedämpfte Aufsteckfräsdome für Einschraubfräser.
 HSK DIN 69893-1
 Hergestellt mit schwingungsdämpfenden Materialien und Mechanismen.
 Standard und extralange Ausführungen sind für Werkzeug- und Formenbau besonders geeignet.
 Mit Innenkühlung.

VORGEWUCHTET

ISO-40: 15.000 r.p.m. G-6,3
 ISO-50: 10.000 r.p.m. G-6,3

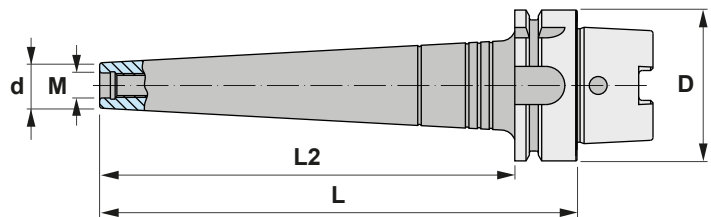

A16.315IK

Reference Bezeichnung	K ISO	L	d	M	L2	D	
A16.315.63.10/200IK	63	200	18	M10	174	63	1,290
A16.315.63.10/250IK	63	250	18	M10	224	63	1,500
A16.315.63.12/200IK	63	200	21	M12	174	63	1,340
A16.315.63.12/250IK	63	250	21	M12	224	63	1,550
A16.315.63.16/250IK	63	250	29	M16	224	63	2,130
A16.315.100.12/300IK	100	300	21	M12	271	100	3,580
A16.315.100.16/300IK	100	300	29	M16	271	100	4,400





Characteristics:
Milling cutter arbors for screw-on
type milling cutters.
DIN 69893-1 / HSK Form A.

Eigenschaften:
Spannfutter für Einschraubfräser.
DIN 69893-1 / HSK Form A.

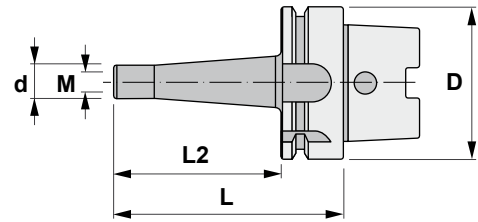

16.315

Reference Bezeichnung	HSK	L	d	M	L2	D	
16.315.063.10/050	63	76	18	10	50	63	0,760
16.315.063.10/100	63	126	18	10	100	63	1,020
16.315.063.12/050	63	76	21	12	50	63	0,780
16.315.063.12/100	63	126	21	12	100	63	1,070
16.315.063.16/050	63	76	29	16	50	63	0,900
16.315.063.16/100	63	126	29	16	100	63	1,210
16.315.100.10/100	100	129	18	10	100	100	2,330
16.315.100.10/150	100	179	18	10	150	100	2,510
16.315.100.12/100	100	129	21	12	100	100	2,360
16.315.100.12/150	100	179	21	12	150	100	2,560
16.315.100.16/100	100	129	29	16	100	100	2,440
16.315.100.16/150	100	179	29	16	150	100	2,710



Characteristics:

Collet chucks for DIN 6499 (ER) collets. DIN 69893-1 / HSK Form A

For tools with cylindrical shank DIN 1835-B.

* Ball bearing nut, see page: I221

*** SUPPLIED WITHOUT WRENCH**

Eigenschaften:

Spannzangenfutter für Spannzangen DIN 6499 (ER). DIN 69893-1 / HSK Form A



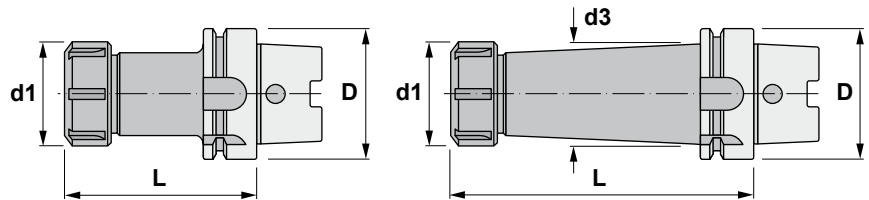

Für Werkzeuge mit zylindrischem Schaft DIN 1835-B.

* Für Kugellager-Mutter, siehe Seite: I221

*** LIEFERUNG OHNE SCHLÜSSEL**



16.453

Reference Bezeichnung	HSK		L	d1	D	d3			
16.453.063.16	63	ER16	100	0,5-10	32	-	45316	50216	0,910
16.453.063.16/160	63	ER16	160	0,5-10	32	32	45316	50216	1,050
16.453.063.20	63	ER20	100	1-13	35	-	45320	50220	1,020
16.453.063.20/160	63	ER20	160	1-13	35	35	45320	50220	1,490
16.453.063.25	63	ER25	100	1-16	42	-	45325	50225	1,260
16.453.063.25/160	63	ER25	160	1-16	42	42	45325	50225	1,940
16.453.063.32	63	ER32	100	2-20	50	-	45332	50232	1,630
16.453.063.32/160	63	ER32	160	2-20	50	50	45332	50232	2,720
16.453.063.40	63	ER40	100	3-30	63	-	45340	50240	2,220
16.453.063.40/160	63	ER40	160	3-30	63	-	45340	50240	3,140
16.453.100.25	100	ER25	100	1-16	42	-	45325	50225	2,710
16.453.100.25/160	100	ER25	160	1-16	42	42	45325	50225	3,370
16.453.100.32	100	ER32	100	2-20	50	-	45332	50232	3,070
16.453.100.32/160	100	ER32	160	2-20	50	50	45332	50232	4,000
16.453.100.40	100	ER40	100	3-30	63	-	45340	50240	3,640
16.453.100.40/160	100	ER40	160	3-30	63	63	45340	50240	5,110

ERXX

 I210-212

Reference / Bezeichnung

ERXX



40.453..

 I180

Reference / Bezeichnung

40.453..



ERCXX

 I215-216

Reference / Bezeichnung

ERCXX



40.455..

 I181

Reference / Bezeichnung

40.455..



ERTXX

 I217-218

Reference / Bezeichnung

ERTXX





Characteristics:

Long collet chucks for DIN 6499 (ER) collets. DIN 69893-1 / HSK Form A
For tools with cylindrical shank.
With "mini" collet nut.

*** SUPPLIED WITHOUT WRENCH**



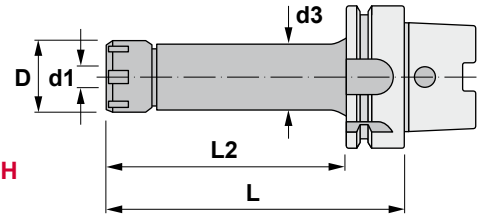

Eigenschaften:

Lange Spannzangenfutter für Spannzangen DIN 6499 (ER).
DIN 69893-1 / HSK Form A
Für Werkzeuge mit zylindrischem Schaft.
Mit "Mini"-Spannmutter.

*** LIEFERUNG OHNE SCHLÜSSEL**



16.455

Reference Bezeichnung	HSK		L	d1	D	L2	d3				
16.455.063.16	63	ER16	100	0,5-10	22	-	-	45516	50916	19210	0,880
16.455.063.16/160	63	ER16	160	0,5-10	22	100	30	45516	50916	19210	1,040
16.455.063.20/160	63	ER20	160	1-13	28	100	30	45520	50920	19212	1,260
16.455.063.25/160	63	ER25	160	1-16	35	100	30	45525	50925	19216	1,640

ERXX

 I210-212

Ref. / Bez. Accessories / Zubehör

ERXX Collets with double slot DIN 6499 - Form B (ER)
Spannzangen mit Doppelnut DIN 6499 - Form B (ER)



ERCXX

 I215-216

Ref. / Bez. Accessories / Zubehör

ERCXX Sealed collets DIN 6499 (ER)
Abgedichtete Spannzangen DIN 6499 (ER)



ERTXX

 I217-218

Ref. / Bez. Accessories / Zubehör

ERTXX Collets DIN 6499 - Form Mexin (ER)
Spannzangen DIN 6499 - Form Mexin (ER)





Characteristics:
Blank adaptors.
DIN 69893-1 / HSK Form A

Eigenschaften:
Rohlinge.
DIN 69893-1 / HSK Form A

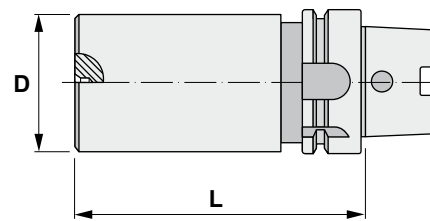

16.470

Reference Bezeichnung	HSK	D	L	
16.470.063.063/250	63	63	250	6,100
16.470.063.080/250	63	80	250	10,160
16.470.100.063/200	100	63	200	7,010
16.470.100.080/250	100	80	250	11,980
16.470.100.090/300	100	90	300	17,010





Characteristics:
Test arbors.
DIN 69893-1 / HSK Form A

Eigenschaften:
Prüfdorne.
DIN 69893-1 / HSK Form A

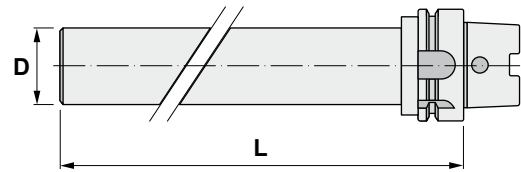

16.999

Reference Bezeichnung	HSK	L	D	 Kg
16.999.063	63	346	40	3,470
16.999.100	100	329	50	6,760



1 TYPE / TYP

A16.160IK 	A16.160 	16.160 	16.180 	16.210 
16.215 	16.296 	16.300 	16.305 	A16.315IK 
16.315 	16.453 	16.455 	16.470 	

2 DIMENSION / ABMESSUNGEN

63	100
-----------	------------

3 LENGTH / LÄNGE (L)

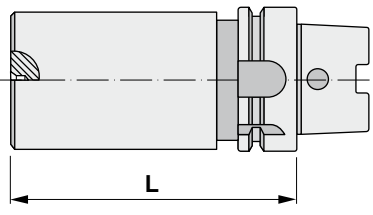
	<hr/> <hr/> <hr/> <hr/> <hr/> <hr/>
---	-------------------------------------

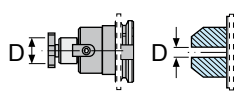
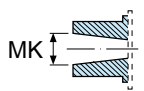
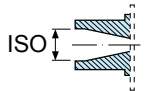
Ø DIAMETER / DURCHMESSER	MK	ISO	COLLET SPANNZANGEN
			

NOTES / BEMERKUNGEN:







JIS B 6339-BT

Code system Kodifizierung	I100
Technical information Technische Auskünfte	I101
Applications index Anwendungen	I102-103
Arbors and adaptors JIS B 6339-BT Aufnahmen JIS B 6339-BT	I104-145
Antivibratory adaptors JIS B 6339-BT Schwingungsgedämpfte Aufnahmen JIS B 6339-BT	I106-107,130
Sets Sätze	I133
Special tool request Sonderwerkzeug-Anfrage	I146



Code system / Kodifizierung

A	20	160	30	16
*	1	2	3	4

* Antivibratory adaptors
Schwingungsgedämpfte Aufnahmen

1 Model Modell

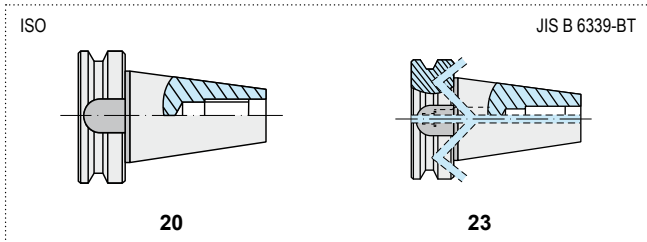

3 Arbor size Aufnahmengröße

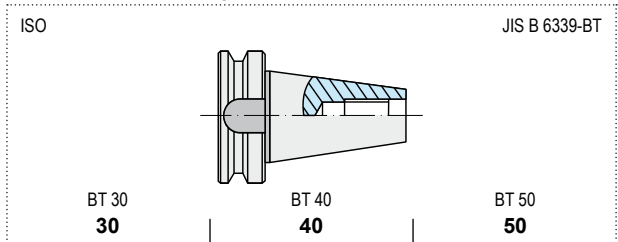

2 Arbor type Aufnahmen-Typ

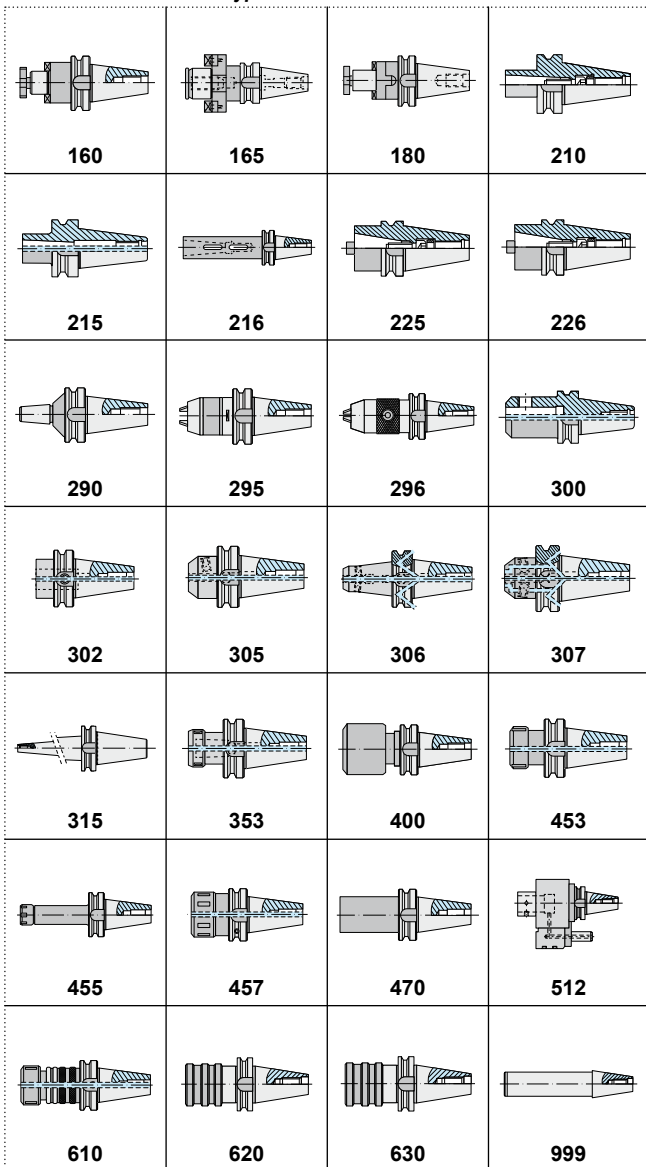

4 Adaptor size Adaptergröße

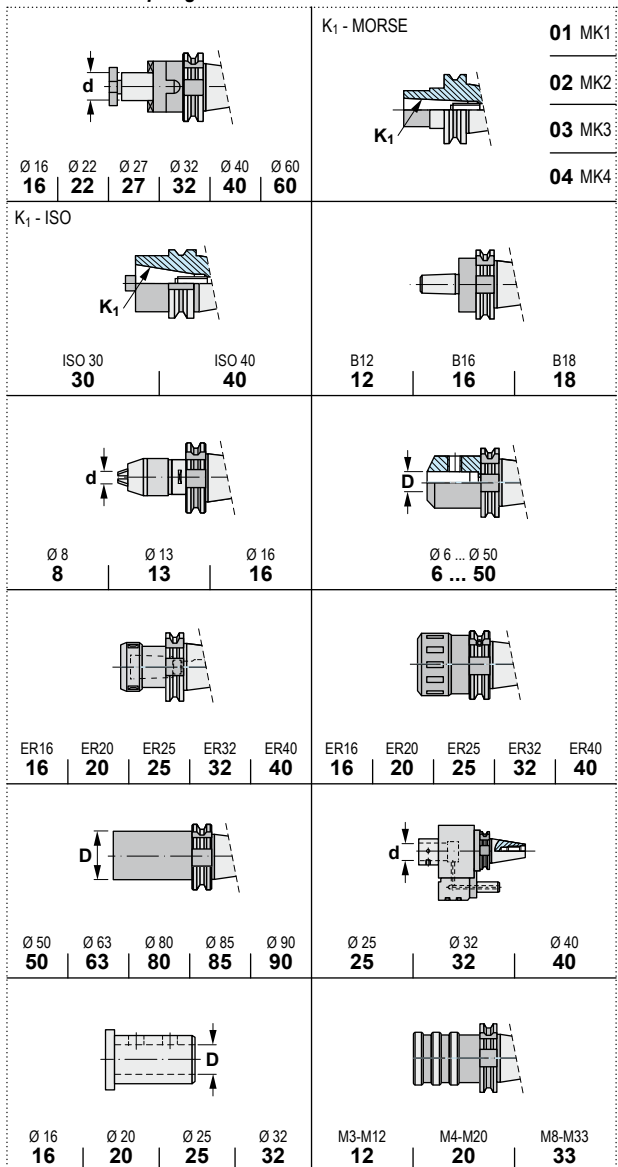

AT3 TECHNICAL CHARACTERISTICS OF THE TOOLHOLDERS AT3 TECHNISCHE EIGENSCHAFTEN DER AUFNAHMEN

MATERIAL:

- Chromium-manganese carburised steel 1.7131 (16MnCr5).

EXECUTION:

- Carburised, hardened and tempered.
- Surface hardness HRC 58±2 (670±40 HV30)
- Depth of carburised layer minimum 0,5 mm.
- Tensile strength in core minimum 800 N/mm2 after carburizing.

ACCURACY:

- Taper according to DIN 254
- Taper angle:
tolerance AT 3 DIN 7178 part 1 and DIN 2080 part 1.
- Other tolerances according to DIN 7160 and 7168.
- Taper surface roughness RZ<0,001 mm.

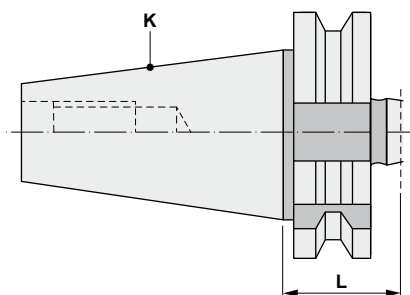

PREBALANCED TOOLHOLDERS VORGEWUCHTETE AUFNAHMEN

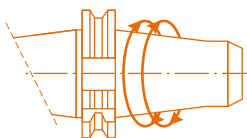

ISO 40 ▶ 8000 rpm ISO 50 ▶ 8000 rpm

MATERIALIEN:

- Legierter aufgekohlter Stahl mit Chrom-Mangan 1.7131 (16MnCr5).

KONSTRUKTIONS DATEN:

- Aufgekohlt, gehärtet und angelassen.
- Oberflächenhärte HRC 58±2 (670±40 HV30)
- Aufgekohlt auf minimum 0,5 mm Tiefe.
- Zugfestigkeit im Kern minimum 800 N/mm2 nach der Aufkohlung.

GENAUIGKEIT:

- Dorn nach DIN 254
- Kegelwinkel:
Toleranz AT 3 DIN 7178 Teil 1 und DIN 2080 Teil 1.
- Andere Toleranzen entsprechend DIN 7160 und 7168.
- Rauigkeit der Oberfläche RZ<0,001 mm.

K	AT3 mm
ISO 30	0,002
ISO 40	0,003
ISO 45	0,003
ISO 50	0,004
ISO 60	0,005

TOLERANCE AT:

- Indicates the tolerance of measuring plane D between the real and the theoretical value of the taper conicity.
- This value of measuring plane D must always be less (negative), never more (positive) in order to GUARANTEE a good toolholder fixation at the bigger taper diameter.

TOLERANZ AT:

- Zeigt die Toleranz auf der Messebene D zwischen dem tatsächlichen Wert der Kegelkonizität und dem theoretischen Wert.
- Dieser Wert auf der Messebene D sollte immer minus (negativ) sein, nie plus (positiv), um für einen guten Halt des Futter in den größeren Durchmesser des Kegels zu GARANTIEREN.

20 JIS B 6339 - BT

FORM A: SIMILAR DIN 69871 AD

ÄHNLICH WIE DIN 69871 AD

Without through hole / Ohne Durchgangsbohrung

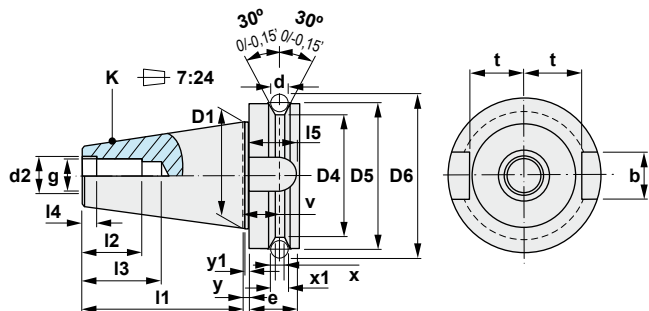

K	D1	l1±0,2	d2 H8	g 6H	l2 min	l3 min	l4+0,5/0	b H12	l5 min	t 0/-0,2
30	31,75	48,4	12,5	M 12	24	34	7	16,1	17	16,3
35	38,10	56,4	12,5	M 12	24	34	7	16,1	20	19,6
40	44,45	65,4	17,0	M 16	30	43	9	16,1	21	22,6
45	57,15	82,8	21,0	M 20	38	53	11	19,3	26	29,1
50	69,85	101,8	25,0	M 24	45	62	13	25,7	31	35,1

K	D4	D5 h8	e	V±0,1	X	X1±0,1/0	y±0,4	y1±0,5/0	d9	e1±0,1	e2 max
30	38	46	20	13,6	4	8	2	7	4	21	5
35	43	53	22	14,6	5	10	2	7	-	-	-
40	53	63	25	16,6	5	10	2	9	4	27	5
45	73	85	30	21,2	6	12	3	11	5	35	6
50	85	100	35	23,2	7	15	3	13	6	42	7

23 JIS B 6339 - BT

FORM B: SIMILAR DIN 69871 AD+B

ÄHNLICH WIE DIN 69871 AD+B

With central coolant feed and through the collar
Mit zentraler Kühlmittelzufuhr und durch den Bund

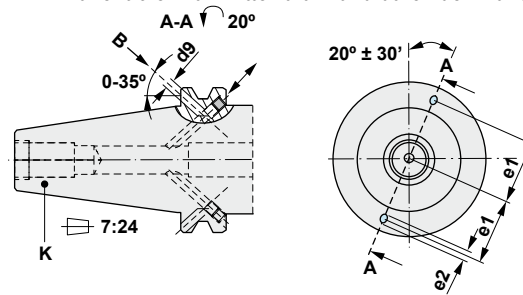

Arbors and adaptors JIS B 6339-BT
Aufnahmen JIS B 6339-BT

20.160



Page / Seite I104

23.160



Page / Seite I105

20.165



Page / Seite I108

20.180



Page / Seite I109

20.210



Page / Seite I110

23.210



Page / Seite I111

20.215



Page / Seite I112

23.215



Page / Seite I113

20.216



Page / Seite I114

20.225



Page / Seite I115

20.226



Page / Seite I116

20.290



Page / Seite I117

20.295



Page / Seite I118

20.296



Page / Seite I119

23.296



Page / Seite I120

20.300



Page / Seite I121

23.300



Page / Seite I122

20.302



Page / Seite I123

23.302



Page / Seite I124

20.305



Page / Seite I125

23.306



Page / Seite I126-127

23.307



Page / Seite I128

23.315



Page / Seite I129

20.353



Page / Seite I131

20.400



Page / Seite I132

20.453



Page / Seite I134

23.453



Page / Seite I135

20.455



Page / Seite I136

20.457



Page / Seite I137

23.457



Page / Seite I138

Arbors and adaptors JIS B 6339-BT
Aufnahmen JIS B 6339-BT

<p>20.470</p>  <p>Page / Seite I139</p>	<p>20.512</p>  <p>Page / Seite I140</p>	<p>20.610</p>  <p>Page / Seite I141</p>	<p>23.610</p>  <p>Page / Seite I142</p>	<p>20.620</p>  <p>Page / Seite I143</p>
<p>20.630</p>  <p>Page / Seite I144</p>	<p>20.999</p>  <p>Page / Seite I145</p>			

Antivibratory adaptors JIS B 6339-BT
Schwingungsgedämpfte Aufnahmen JIS B 6339-BT

<p>A20.160 Cylindrical Zylindrische Form</p>  <p>Page / Seite I106</p>	<p>A20.160 Conical Konische Form</p>  <p>Page / Seite I107</p>	<p>A20.315</p>  <p>Page / Seite I130</p>		
---	---	---	--	--

Sets JIS B 6339-BT
Sätze JIS B 6339-BT

<p>SET-C20/32</p>  <p>Page / Seite I133</p>				
---	--	--	--	--







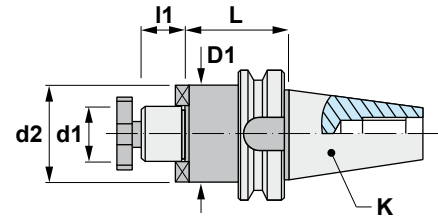

Characteristics:
Shell mill adaptors.
JIS B 6339-BT
For cutters with driving slot DIN 138.

Eigenschaften:
Aufsteckfräsdorne.
JIS B 6339-BT
Für Fräser mit Quernut DIN 138.



20.160

Reference Bezeichnung	K ISO	d1 h6	L	I1	d2	D1				
20.160.30.16	30	16	40	17	38	-	10008	86016	11103	0,620
20.160.30.22	30	22	40	19	48	-	10010	86022	11004	0,700
20.160.30.27	30	27	45	21	58	-	10012	86027	11005	0,870
20.160.40.16	40	16	40	17	38	-	10008	86016	11103	1,190
20.160.40.16/100	40	16	100	17	38	38	10008	86016	11103	1,580
20.160.40.22	40	22	45	19	48	-	10010	86022	11004	1,290
20.160.40.22/100	40	22	100	19	48	48	10010	86022	11004	2,180
20.160.40.27	40	27	50	21	58	-	10012	86027	11005	1,650
20.160.40.27/100	40	27	100	21	58	58	10012	86027	11005	2,420
20.160.40.32	40	32	50	24	63	-	10016	86032	11105	1,730
20.160.40.32/125	40	32	125	24	78	63	10016	86032	11105	3,100
20.160.40.40	40	40	55	27	73	-	10020	86040	11006	2,130
20.160.50.16	50	16	55	17	38	-	10008	86016	11103	4,100
20.160.50.16/150	50	16	150	17	38	38	10008	86016	11103	4,880
20.160.50.22	50	22	55	19	48	-	10010	86022	11004	4,150
20.160.50.22/150	50	22	150	19	48	48	10010	86022	11004	5,500
20.160.50.27	50	27	60	21	58	-	10012	86027	11005	4,280
20.160.50.27/150	50	27	150	21	58	58	10012	86027	11005	6,300
20.160.50.32	50	32	60	24	78	-	10016	86032	11105	4,320
20.160.50.32/150	50	32	150	24	78	63	10016	86032	11105	8,300
20.160.50.40	50	40	65	27	88	-	10020	86040	11006	5,370
20.160.50.40/150	50	40	150	27	88	73	10020	86040	11006	9,530
20.160.50.50	50	50	65	30	90	-	10024	86050	11008	5,700



Characteristics:
Shell mill adaptors.
JIS B 6339-BT
For cutters with driving slot
DIN 138.



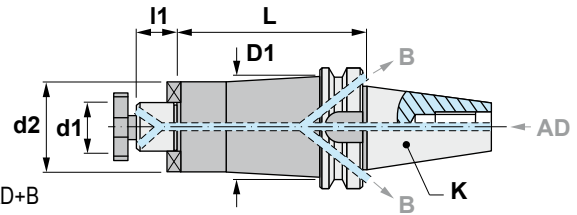

Similar to DIN 69871 - Form AD+B

Eigenschaften:
Aufsteckfräsdorne.
JIS B 6339-BT.
Für Fräser mit Quernut
DIN 138.

Ähnlich wie DIN 69871 - Form AD+B



23.160

Reference Bezeichnung	K ISO	d1 h6	L	l1	d2	D1				
23.160.40.16	40	16	40	17	38	-	10008	86016	11103	1,150
23.160.40.16/100	40	16	100	17	38	38	10008	86016	11103	1,450
23.160.40.22	40	22	45	19	48	-	10010	86022	11004	1,310
23.160.40.22/100	40	22	100	19	48	48	10010	86022	11004	2,080
23.160.40.27	40	27	50	21	58	-	10012	86027	11005	1,570
23.160.40.27/100	40	27	100	21	58	58	10012	86027	11005	2,590
23.160.40.32	40	32	50	24	63	-	10016	86032	11105	1,700
23.160.40.32/125	40	32	125	24	78	63	10016	86032	11105	3,140
23.160.40.40	40	40	55	27	73	-	10020	86040	11006	2,070
23.160.50.16	50	16	55	17	38	-	10008	86016	11108	3,780
23.160.50.16/150	50	16	150	17	38	38	10008	86016	11108	4,590
23.160.50.22	50	22	55	19	48	-	10010	86022	11004	3,970
23.160.50.22/150	50	22	150	19	48	48	10010	86022	11004	5,230
23.160.50.27	50	27	60	21	58	-	10012	86027	11005	4,230
23.160.50.27/150	50	27	150	21	58	58	10012	86027	11005	6,010
23.160.50.32	50	32	60	24	78	-	10016	86032	11105	4,340
23.160.50.32/150	50	32	150	24	78	63	10016	86032	11105	6,400
23.160.50.40	50	40	65	27	88	-	10020	86040	11006	5,250
23.160.50.40/150	50	40	150	27	88	73	10020	86040	11006	9,130
23.160.50.50	50	50	65	30	90	-	10024	86050	11008	5,560





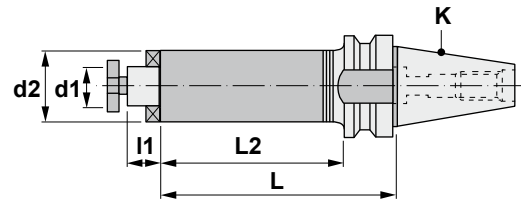

Characteristics:
Cylindrical antivibratory shell mill adaptors. JIS B 6339-BT
For cutters with driving slot DIN 138.

Eigenschaften:
Zylindrische schwingungsgedämpfte Aufsteckfräsdorne.
JIS B 6339-BT
Für Fräser mit Quernut DIN 138.



A20.160

Reference Bezeichnung	K ISO	d1 h6	L	L2	l1	d2				
A20.160.40.16/150-38	40	16	150	123	17	38	10008	86016	11103	2,110
A20.160.40.16/200-38	40	16	200	173	17	38	10008	86016	11103	2,560
A20.160.40.16/250-38	40	16	250	223	17	38	10008	86016	11103	3,000
A20.160.40.16/300-38	40	16	300	273	17	38	10008	86016	11103	3,450
A20.160.40.22/150-48	40	22	150	123	19	48	10010	86022	11004	2,790
A20.160.40.22/200-48	40	22	200	173	19	48	10010	86022	11004	3,500
A20.160.40.22/250-48	40	22	250	223	19	48	10010	86022	11004	4,210
A20.160.40.22/300-48	40	22	300	273	19	48	10010	86022	11004	4,920
A20.160.40.27/150-58	40	27	150	123	21	58	10012	86027	11005	3,620
A20.160.40.27/200-58	40	27	200	173	21	58	10012	86027	11005	4,660
A20.160.40.27/250-58	40	27	250	223	21	58	10012	86027	11005	5,690
A20.160.40.27/300-58	40	27	300	273	21	58	10012	86027	11005	6,730
A20.160.50.16/150-38	50	16	150	112	17	38	10008	86016	11103	4,720
A20.160.50.16/200-38	50	16	200	162	17	38	10008	86016	11103	5,160
A20.160.50.16/250-38	50	16	250	212	17	38	10008	86016	11103	5,610
A20.160.50.16/300-38	50	16	300	262	17	38	10008	86016	11103	6,060
A20.160.50.16/400-38	50	16	400	362	17	38	10008	86016	11103	6,950
A20.160.50.22/200-48	50	22	200	162	19	48	10010	86022	11004	6,050
A20.160.50.22/250-48	50	22	250	212	19	48	10010	86022	11004	6,760
A20.160.50.22/300-48	50	22	300	262	19	48	10010	86022	11004	7,470
A20.160.50.22/400-48	50	22	400	362	19	48	10010	86022	11004	8,890
A20.160.50.22/500-48	50	22	500	462	19	48	10010	86022	11004	10,310
A20.160.50.22/200-58	50	22	200	162	19	58	10010	86022	11004	7,110
A20.160.50.22/250-58	50	22	250	212	19	58	10010	86022	11004	8,150
A20.160.50.22/300-58	50	22	300	262	19	58	10010	86022	11004	9,180
A20.160.50.22/400-58	50	22	400	362	19	58	10010	86022	11004	11,260
A20.160.50.22/500-58	50	22	500	462	19	58	10010	86022	11004	13,330
A20.160.50.27/200-58	50	27	200	162	21	58	10012	86027	11005	7,140
A20.160.50.27/250-58	50	27	250	212	21	58	10012	86027	11005	8,180
A20.160.50.27/300-58	50	27	300	262	21	58	10012	86027	11005	9,210
A20.160.50.27/400-58	50	27	400	362	21	58	10012	86027	11005	11,290
A20.160.50.27/500-58	50	27	500	462	21	58	10012	86027	11005	13,360
A20.160.50.32/200-78	50	32	200	162	24	78	10016	86032	11105	9,890
A20.160.50.32/250-78	50	32	250	212	24	78	10016	86032	11105	11,760
A20.160.50.32/300-78	50	32	300	262	24	78	10016	86032	11105	13,640
A20.160.50.32/400-78	50	32	400	362	24	78	10016	86032	11105	17,390
A20.160.50.32/500-78	50	32	500	462	24	78	10016	86032	11105	21,140



Characteristics:
 Conical antivibratory shell mill adaptors. JIS B 6339-BT
 For cutters with driving slot DIN 138.

Eigenschaften:
 Konische schwingungsgedämpfte Aufsteckfräsdorne.
 JIS B 6339-BT
 Für Fräser mit Quernut DIN 138.

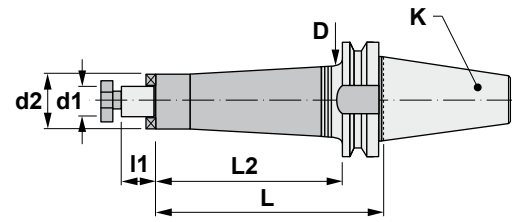

A20.160

Reference Bezeichnung	K ISO	d1 h6	L	L2	D	I1	d2				
A20.160.40.16/150	40	16	150	123	50	17	38	10008	86016	11103	2,550
A20.160.40.16/200	40	16	200	173	50	17	38	10008	86016	11103	3,150
A20.160.40.16/250	40	16	250	223	50	17	38	10008	86016	11103	3,750
A20.160.40.16/300	40	16	300	273	50	17	38	10008	86016	11103	4,350
A20.160.40.22/150	40	22	150	123	50	19	48	10010	86022	11004	2,750
A20.160.40.22/200	40	22	200	173	50	19	48	10010	86022	11004	3,430
A20.160.40.22/250	40	22	250	223	50	19	48	10010	86022	11004	4,110
A20.160.40.22/300	40	22	300	273	50	19	48	10010	86022	11004	4,790
A20.160.50.16/150	50	16	150	112	80	17	38	10008	86016	11103	6,510
A20.160.50.16/200	50	16	200	162	80	17	38	10008	86016	11103	7,630
A20.160.50.16/250	50	16	250	212	80	17	38	10008	86016	11103	8,750
A20.160.50.16/300	50	16	300	262	80	17	38	10008	86016	11103	9,860
A20.160.50.16/400	50	16	400	362	80	17	38	10008	86016	11103	12,100
A20.160.50.22/200	50	22	200	162	80	19	48	10010	86022	11004	8,100
A20.160.50.22/250	50	22	250	212	80	19	48	10010	86022	11004	9,400
A20.160.50.22/300	50	22	300	262	80	19	48	10010	86022	11004	10,680
A20.160.50.22/400	50	22	400	362	80	19	48	10010	86022	11004	13,260
A20.160.50.22/500	50	22	500	462	80	19	48	10010	86022	11004	15,840
A20.160.50.27/200	50	27	200	162	80	21	58	10012	86027	11005	8,790
A20.160.50.27/250	50	27	250	212	80	21	58	10012	86027	11005	10,310
A20.160.50.27/300	50	27	300	262	80	21	58	10012	86027	11005	11,830
A20.160.50.27/400	50	27	400	362	80	21	58	10012	86027	11005	14,870
A20.160.50.27/500	50	27	500	462	80	21	58	10012	86027	11005	17,920

SPECIAL FOR MOULD AND DIE MAKERS

Vibration reduced up to 60% compared to any other conventional shell mill adaptor, as they are manufactured with materials and mechanisms having antivibration properties.

BESONDERS EMPFOHLEN FÜR WERKZEUG- UND FORMENBAU

60% weniger Schwingungen im Vergleich mit anderen konventionellen Aufsteckfräsdornen, da diese Ausführung mit schwingungsdämpfenden Materialien und Mechanismen hergestellt wird.

COMPARISON WHEN USING AN ANTIVIBRATORY TOOLHOLDER

VERGLEICH ZWISCHEN EINER KONVENZIONELLEN UND EINER SCHWINGUNGSGEDÄMPFTEN AUFNAHME

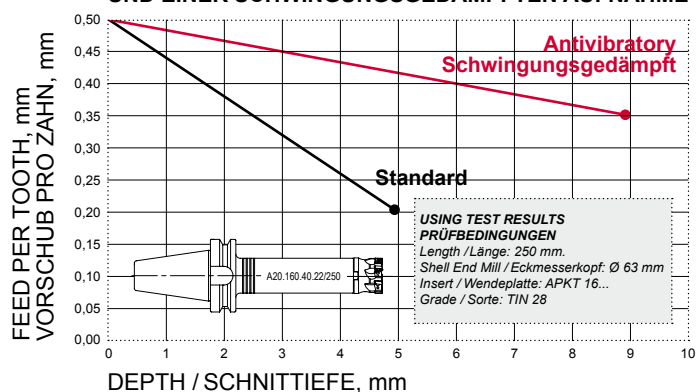



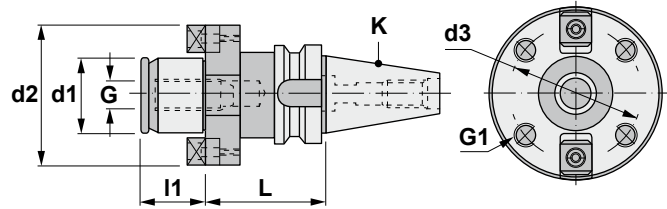

Characteristics:
Adaptors for indexable milling cutters.
JIS B 6339-BT / DIN 6357 - Form A

Eigenschaften:
Zwischenhülsen für Fräser.
JIS B 6339-BT / DIN 6357 - Form A



20.165

Reference Bezeichnung	K ISO	d1 g5	L	d2	d3	G	G1	I1	
20.165.40.40	40	40	60	89	66,7	M-20	M-12	30	2,700
20.165.50.40	50	40	70	89	66,7	M-20	M-12	30	5,510
20.165.50.60	50	60	80	129	101,6	M-30	M-16	40	8,100

Reference Bezeichnung	2x 	2x 
20.165.40.40	80040	11006
20.165.50.40	80040	11006
20.165.50.60	80060	11012



Characteristics:
Combi-Shell mill adaptor.
JIS B 6339-BT
For cutters with keyway or driving slot
DIN 138.

Eigenschaften:
Kombi-Aufsteckfräsdorne.
JIS B 6339-BT
Für Fräser mit Längsnut oder
Stimmitnehmer DIN 138.

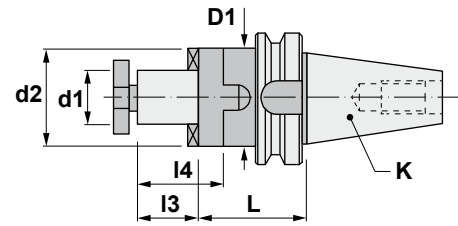

20.180

Reference Bezeichnung	K ISO	d1 h6	L	I3	I4	d2	D1				
20.180.30.16	30	16	50	17	27	32	-	10008	60116	88016	0,620
20.180.30.22	30	22	50	19	31	40	-	10010	60122	88022	0,790
20.180.30.27	30	27	55	21	33	48	-	10012	60127	88027	0,730
20.180.40.16	40	16	55	17	27	32	-	10008	60116	88016	1,260
20.180.40.16/100	40	16	100	17	27	32	35	10008	60116	88016	1,510
20.180.40.22	40	22	55	19	31	40	-	10010	60122	88022	1,390
20.180.40.22/100	40	22	100	19	31	40	48	10010	60122	88022	1,970
20.180.40.27	40	27	55	21	33	48	-	10012	60127	88027	1,560
20.180.40.27/100	40	27	100	21	33	48	48	10012	60127	88027	2,170
20.180.40.32	40	32	60	24	38	58	-	10016	60132	88032	1,560
20.180.40.32/100	40	32	100	24	38	58	58	10016	60132	88032	2,780
20.180.40.40	40	40	60	27	41	70	-	10020	60140	88040	1,800
20.180.50.16	50	16	70	17	27	32	-	10008	60116	88016	4,100
20.180.50.16/125	50	16	125	17	27	32	35	10008	60116	88016	4,480
20.180.50.22	50	22	70	19	31	40	-	10010	60122	88022	4,230
20.180.50.22/125	50	22	125	19	31	40	48	10010	60122	88022	4,950
20.180.50.27	50	27	70	21	33	48	-	10012	60127	88027	4,170
20.180.50.27/125	50	27	125	21	33	48	60	10012	60127	88027	5,420
20.180.50.32	50	32	70	24	38	58	-	10016	60132	88032	4,360
20.180.50.32/125	50	32	125	24	38	58	78	10016	60132	88032	6,270
20.180.50.40	50	40	70	27	41	70	-	10020	60140	88040	4,520
20.180.50.40/125	50	40	125	27	41	70	78	10020	60140	88040	6,950
20.180.50.50	50	50	70	30	46	90	-	10024	60150	88050	5,000





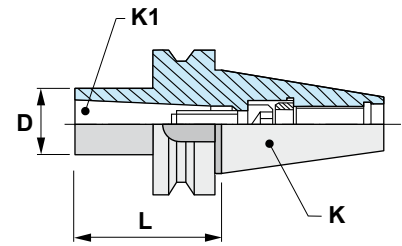

Characteristics:
Reducing adaptors.
JIS B 6339-BT
For tools with Morse taper shank
and drawbar thread
DIN 228-A.

Eigenschaften:
Reduzierhülsen.
JIS B 6339-BT
Für Werkzeuge mit Morsekegel
und Anzugsgewinde DIN 228-A.



20.210

Reference Bezeichnung	K ISO	K1 MORSE	L	D	
20.210.30.01	30	1	50	25	0,510
20.210.30.02	30	2	65	32	0,590
20.210.30.03	30	3	80	40	0,760
20.210.40.01	40	1	50	25	1,080
20.210.40.02	40	2	50	32	1,130
20.210.40.03	40	3	70	40	1,270
20.210.40.04	40	4	95	48	1,520
20.210.50.01	50	1	45	25	3,850
20.210.50.02	50	2	60	32	3,860
20.210.50.03	50	3	65	40	3,870
20.210.50.04	50	4	70	48	3,870
20.210.50.05	50	5	100	63	4,020

Reference Bezeichnung			
20.210.30.01	16105	19312	11106
20.210.30.02	16105	19315	12110
20.210.30.03	16105	19318	12012
20.210.40.01	16205	19516	11206
20.210.40.02	16205	19416	18010
20.210.40.03	16205	19420	11312
20.210.40.04	16205	19322	12016
20.210.50.01	16205	19624	11206
20.210.50.02	16205	19324	11110
20.210.50.03	16205	19524	11212
20.210.50.04	16205	19424	12016
20.210.50.05	16205	19338	11020



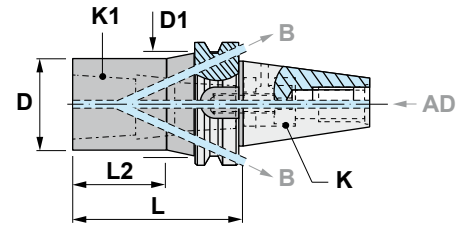

Characteristics:
Reducing adaptors.
JIS B 6339-BT
For tools with Morse taper shank and drawbar thread DIN 228-A.
Similar to DIN 69871 - Form AD+B



Eigenschaften:
Reduzierhülsen.
JIS B 6339-BT
Für Werkzeuge mit Morsekegel und Anzugsgewinde DIN 228-A.
Ähnlich wie DIN 69871 - Form AD+B

23.210

Reference Bezeichnung	K ISO	K1 MORSE	L	D	D1	L2	kg
23.210.40.01	40	1	50	25	45	16	1,050
23.210.40.02	40	2	50	32	50	19	1,090
23.210.40.03	40	3	70	40	50	42	1,270
23.210.40.04	40	4	95	48	-	-	1,480
23.210.50.01	50	1	45	25	80	16	3,680
23.210.50.02	50	2	60	32	80	23	3,920
23.210.50.03	50	3	65	40	80	28	3,910
23.210.50.04	50	4	70	48	80	37	3,790
23.210.50.05	50	5	100	63	80	66	4,080

Reference Bezeichnung			
23.210.40.01	16205	19516	18006
23.210.40.02	16205	19416	18010
23.210.40.03	16205	19420	18012
23.210.40.04	16205	19322	18016
23.210.50.01	16205	19624	18006
23.210.50.02	16205	19324	18110
23.210.50.03	16205	19524	18112
23.210.50.04	16205	19424	18016
23.210.50.05	16205	19338	18020





Characteristics:
Reducing adaptors.
JIS B 6339-BT
For tools with Morse taper shank
and tang DIN 228-B shank.

Eigenschaften:
Reduzierhülsen.
JIS B 6339-BT
Für Werkzeuge mit Morsekegel
und Austreiblappen DIN 228-B.

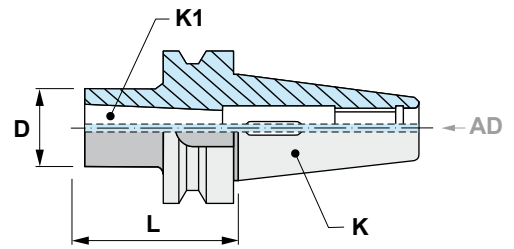

20.215

Reference Bezeichnung	K ISO	K1 MORSE	L	D	
20.215.30.01	30	1	50	25	0,470
20.215.30.02	30	2	62	32	0,530
20.215.30.03	30	3	78	40	0,600
20.215.40.01	40	1	50	25	1,060
20.215.40.02	40	2	50	32	1,070
20.215.40.03	40	3	70	40	1,180
20.215.40.04	40	4	95	48	1,390
20.215.50.01	50	1	45	25	3,750
20.215.50.02	50	2	60	32	3,770
20.215.50.03	50	3	65	40	3,800
20.215.50.04	50	4	95	48	4,000
20.215.50.05	50	5	105	63	4,100



Characteristics:
Reducing adaptors.
JIS B 6339-BT
For tools with Morse taper shank
and tang DIN 228-B.
Similar to DIN 69871 - Form AD+B

Eigenschaften:
Reduzierhülsen.
JIS B 6339-BT
Für Werkzeuge mit Morsekegel
und Austreibblappen DIN 228-B.
Ähnlich wie DIN 69871 - Form AD+B

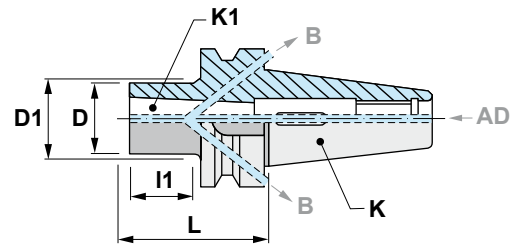

23.215

Reference Bezeichnung	K ISO	K1 MORSE	L	D	D1	I1	
23.215.40.01	40	1	50	25	45	16	1,080
23.215.40.02	40	2	50	32	50	18	1,080
23.215.40.03	40	3	70	40	50	42	1,170
23.215.40.04	40	4	95	48	-	-	1,380
23.215.50.01	50	1	45	25	80	16	3,730
23.215.50.02	50	2	60	32	80	23	3,650
23.215.50.03	50	3	65	40	80	28	3,930
23.215.50.04	50	4	95	48	80	49	3,930
23.215.50.05	50	5	105	63	80	71	3,830





Characteristics:

Long reducing adaptors. JIS B 6339-BT
For tools with Morse taper shank and tang
DIN 228-B.

Eigenschaften:

Lange Reduzierhülsen. JIS B 6339-BT
Für Werkzeuge mit Morsekegel
und Austreibblappen DIN 228-B.

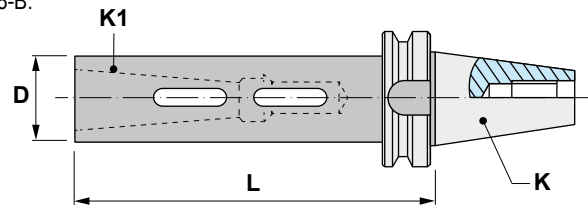

20.216

Reference Bezeichnung	K ISO	K1 MORSE	L	D	
20.216.30.01	30	1	115	25	0,760
20.216.30.02	30	2	125	32	0,930
20.216.30.03	30	3	145	40	1,320
20.216.40.01	40	1	115	25	1,250
20.216.40.02	40	2	125	32	1,540
20.216.40.03	40	3	145	40	1,890
20.216.50.01	50	1	120	25	4,100
20.216.50.02	50	2	135	32	4,290
20.216.50.03	50	3	155	40	4,650
20.216.50.04	50	4	180	48	5,130
20.216.50.05	50	5	215	63	6,330





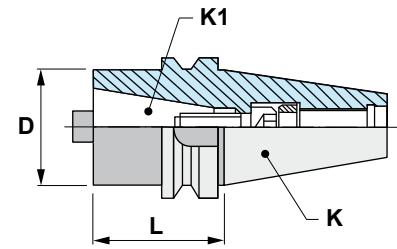

Characteristics:
Reducing adaptors.
JIS B 6339-BT
For tools with DIN 2080 taper shank.

Eigenschaften:
Reduzierhülsen.
JIS B 6339-BT
Für Werkzeuge mit DIN 2080 Kegel.



20.225

Reference Bezeichnung	K ISO	K1 DIN 2080	L	D	
20.225.40.30	40	30	50	50	1,200
20.225.40.40	40	40	100	63	2,230
20.225.50.30	50	30	50	50	3,810
20.225.50.40	50	40	70	63	3,980
20.225.50.50	50	50	120	97	6,440

Reference Bezeichnung			
20.225.40.30	16205	19320	11312
20.225.40.40	16205	19322	12016
20.225.50.30	16205	19524	11112
20.225.50.40	16205	19424	12016
20.225.50.50	16205	19438	12024





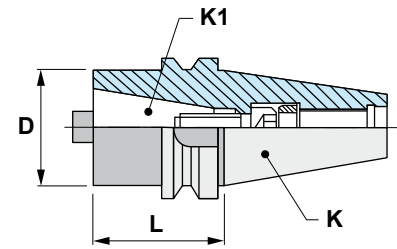

Characteristics:
Reducing adaptors.
JIS B 6339-BT
For tools with DIN 69871-A and
BT shanks.

Eigenschaften:
Reduzierhülsen.
JIS B 6339-BT
Für Werkzeuge mit DIN 69871-A
und BT Kegel.



20.226

Reference Bezeichnung	K ISO	K1 DIN 69871 JIS B 6339-BT	L	D	
20.226.40.30	40	30	50	50	1,210
20.226.40.40	40	40	100	63	2,250
20.226.50.30	50	30	50	50	3,840
20.226.50.40	50	40	70	63	4,090
20.226.50.50	50	50	120	97	6,580

Reference Bezeichnung			
20.226.40.30	16205	19320	11412
20.226.40.40	16205	19322	12116
20.226.50.30	16205	19524	11412
20.226.50.40	16205	19424	12116
20.226.50.50	16205	19438	12124



Characteristics:
Drill chuck adaptors.
JIS B 6339-BT
For drill chucks with DIN 238 taper.

Eigenschaften:
Bohrfutteraufnahmen.
JIS B 6339-BT
Für Bohrfutter mit DIN 238 Kegel.

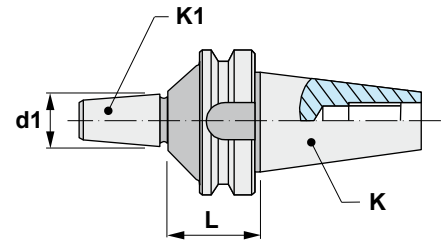

20.290

Reference Bezeichnung	K ISO	K1 DIN	L	d1	
20.290.30.12	30	B-12	27	12,065	0,460
20.290.30.16	30	B-16	27	15,733	0,490
20.290.40.12	40	B-12	32	12,065	1,070
20.290.40.16	40	B-16	32	15,733	1,090
20.290.40.18	40	B-18	32	17,780	1,100
20.290.50.16	50	B-16	43	15,733	3,880
20.290.50.18	50	B-18	43	17,780	3,790

MU

 I199

Ref. / Bez. Accessories / Zubehör

MU Standard keyless drill chucks DIN 238
Standard Schnellspann-Bohrfutter DIN 238



MP

 I200

Ref. / Bez. Accessories / Zubehör

MP Super precision keyless drill chucks DIN 238
Höchst-Genauigkeit-Selbstspannbohrfutter DIN 238



MK

 I201

Ref. / Bez. Accessories / Zubehör

MK Super precision keyless drill chucks DIN 238 with gripping tongue
Höchst-Genauigkeit-Selbstspannbohrfutter DIN 238 mit Schlüsselflächen





Characteristics:

Self clamping short precision drill chucks.
JIS B 6339-BT
For right turn only.

*** SUPPLIED WITH WRENCH**

Eigenschaften:

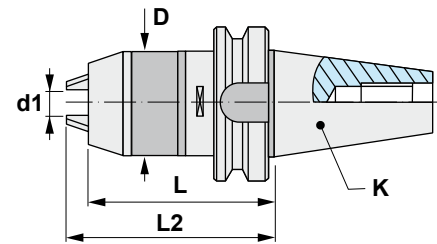

Selbstspann-Kurzbohrfutter,
Genauigkeitsausführung.
JIS B 6339-BT
Nur für rechtslaufende Bearbeitungen.

*** LIEFERUNG MIT SCHLÜSSEL**



20.295

Reference Bezeichnung	K ISO	d1	D	L	L2 max	
20.295.30.08	30	0,3-8	38	73	79	1,100
20.295.40.08	40	0,3-8	38	78	84	1,500
20.295.40.13	40	1-13	48	86	97	1,900
20.295.40.16	40	3-16	55	105	116	2,300
20.295.50.13	50	1-13	48	97	108	4,600
20.295.50.16	50	3-16	55	95	106	4,700

Reference Bezeichnung		
20.295.30.08	50008	11206
20.295.40.08	50008	11206
20.295.40.13	50013	11108
20.295.40.16	50016	11108
20.295.50.13	50013	11108
20.295.50.16	50016	11108



Characteristics:
CNC-Universal precision drill chucks.
JIS B 6339-BT
For left and right hand turn.

*** SUPPLIED WITH WRENCH**

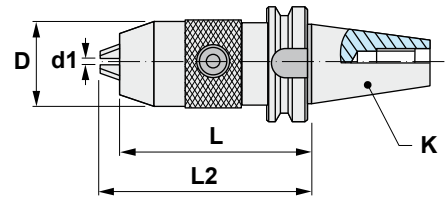

Eigenschaften:
CNC-Universal Bohrfutter,
Genauigkeitsausführung.
JIS B 6339-BT
Für links- und rechtslaufende Bearbeitungen.

*** LIEFERUNG MIT SCHLÜSSEL**



20.296

Reference Bezeichnung	K ISO	d1	D	L	L2 max	
20.296.40.13	40	1-13	54	96	105	2,040
20.296.40.16	40	3-16	57	99	106	2,220
20.296.50.13	50	1-13	54	107	116	4,380
20.296.50.16	50	3-16	57	110	117	4,480

Reference Bezeichnung		3x 
20.296.40.13	5006	60313
20.296.40.16	5006	60313
20.296.50.13	5006	60313
20.296.50.16	5006	60313





Characteristics:
CNC-Universal precision drill chucks.
JIS B 6339-BT
For left and right hand turn.

*** SUPPLIED WITH WRENCH**

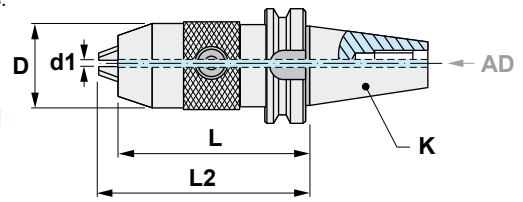

Eigenschaften:
CNC-Universal Bohrfutter,
Genauigkeitsausführung.
JIS B 6339-BT
Für links- und rechtslaufende
Bearbeitungen.

*** LIEFERUNG MIT SCHLÜSSEL**



23.296

Reference Bezeichnung	K ISO	d1	D	L	L2 max	
23.296.40.13	40	1-13	54	96	105	2,040
23.296.40.16	40	3-16	57	99	106	2,220
23.296.50.13	50	1-13	54	107	116	4,380
23.296.50.16	50	3-16	57	110	117	4,480

Reference Bezeichnung		3x 
23.296.40.13	5006	60313
23.296.40.16	5006	60313
23.296.50.13	5006	60313
23.296.50.16	5006	60313

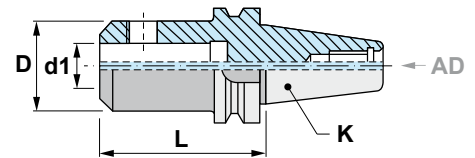

**Characteristics:**

Weldon end mill adaptors.
JIS B 6339-BT
For cutters with cylindrical shank
and Weldon flat DIN 1835-B.

**Eigenschaften:**

Zylinderschaft-Aufnahme Weldon.
JIS B 6339-BT
Für Fräser mit zylindrischem
Schaft und Weldon-Fläche
DIN 1835-B.

20.300

Reference Bezeichnung	K ISO	d1 H4	L	D		
20.300.30.06	30	6	50	25	15106	0,500
20.300.30.08	30	8	50	28	15108	0,520
20.300.30.10	30	10	50	35	15110	0,610
20.300.30.12	30	12	50	42	15212	0,620
20.300.30.14	30	14	50	44	15212	0,625
20.300.30.16	30	16	63	48	15314	0,850
20.300.30.18	30	18	63	50	15314	0,880
20.300.40.06	40	6	50	25	15106	0,940
20.300.40.08	40	8	50	28	15108	0,970
20.300.40.10	40	10	50	35	15110	1,030
20.300.40.12	40	12	50	42	15212	1,120
20.300.40.14	40	14	50	44	15212	1,130
20.300.40.16	40	16	63	48	15314	1,340
20.300.40.18	40	18	63	50	15314	1,370
20.300.40.20	40	20	63	52	15216	1,380
20.300.40.25	40	25	100	65	2 x 15218	2,370
20.300.40.32	40	32	100	72	2 x 15220	2,710
20.300.40.40	40	40	120	90	2 x 15220	4,280
20.300.50.06	50	6	63	25	15106	2,860
20.300.50.08	50	8	63	28	15108	2,890
20.300.50.10	50	10	63	35	15110	2,920
20.300.50.12	50	12	63	42	15212	3,070
20.300.50.14	50	14	63	44	15212	3,110
20.300.50.16	50	16	63	48	15314	3,170
20.300.50.18	50	18	63	50	15314	3,190
20.300.50.20	50	20	63	52	15216	3,260
20.300.50.25	50	25	80	65	2 x 15218	3,910
20.300.50.32	50	32	100	72	2 x 15220	4,670
20.300.50.40	50	40	120	90	2 x 15220	6,310
20.300.50.50	50	50	120	98	2 x 15024	6,700

42.300

 I182

Ref. / Bez.

Accessories / Zubehör

42.300

Short and long reducing bushings DIN 1835-B Form A and B
Kurze und lange Reduzierhülsen DIN 1835-B Form A und B





Characteristics:
Weldon end mill adaptors.
JIS B 6339-BT
For cutters with cylindrical shank
and Weldon flat DIN 1835-B.



Similar to DIN 69871 - Form AD+B

Eigenschaften:
Zylinderschaft-Aufnahme Weldon.
JIS B 6339-BT
Für Fräser mit zylindrischem
Schaft und Weldon-Fläche
DIN 1835-B.

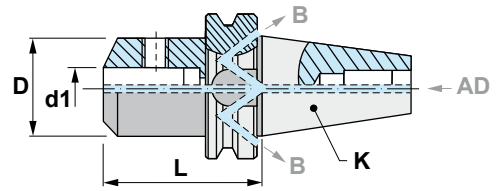
Ähnlich wie DIN 69871 - Form AD+B



23.300

Reference Bezeichnung	K ISO	d1 H4	L	D		
23.300.40.06	40	6	50	25	15106	1,070
23.300.40.08	40	8	50	28	15108	1,090
23.300.40.10	40	10	63	35	15110	1,230
23.300.40.12	40	12	63	42	15212	1,300
23.300.40.14	40	14	63	44	15212	1,320
23.300.40.16	40	16	63	48	15314	1,380
23.300.40.18	40	18	63	50	15314	1,390
23.300.40.20	40	20	63	52	15216	1,410
23.300.40.25	40	25	90	65	2 x 15218	2,250
23.300.40.32	40	32	100	72	2 x 15220	2,730
23.300.40.40	40	40	110	90	2 x 15220	3,960
23.300.50.06	50	6	63	25	15106	3,770
23.300.50.08	50	8	63	28	15108	3,790
23.300.50.10	50	10	65	35	15110	3,850
23.300.50.12	50	12	80	42	15212	4,000
23.300.50.14	50	14	80	44	15212	4,020
23.300.50.16	50	16	80	48	15314	4,100
23.300.50.18	50	18	80	50	15314	4,200
23.300.50.20	50	20	80	52	15216	4,250
23.300.50.25	50	25	100	65	2 x 15218	4,870
23.300.50.32	50	32	105	72	2 x 15220	5,180
23.300.50.40	50	40	120	90	2 x 15220	5,900
23.300.50.50	50	50	120	98	2 x 15024	6,930

42.300

 1182

Ref. / Bez. Accessories / Zubehör

42.300 Short and long reducing bushings DIN 1835-B Form A and B
Kurze und lange Reduzierhülsen DIN 1835-B Form A und B



**Characteristics:**

Short end mill adaptors.

JIS B 6339-BT

For cutters and tooling with cylindrical shank and Weldon flat DIN 1835-B.

Eigenschaften:

Kurze Aufsteckfräsdorne.

JIS B 6339-BT

Für Fräser und Werkzeuge mit zylindrischem Schaft und Weldon-Fläche DIN 1835-B.

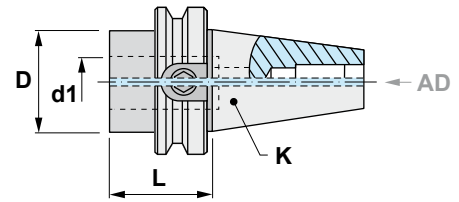

20.302

Reference Bezeichnung	K ISO	d1 H4	L	D	
20.302.30.16	30	16	32	32	0,400
20.302.30.20	30	20	34	36	0,370
20.302.40.16	40	16	35	45	1,060
20.302.40.20	40	20	35	45	1,000
20.302.40.25	40	25	35	45	0,920
20.302.40.32	40	32	45	50	0,880
20.302.50.16	50	16	44	70	3,800
20.302.50.20	50	20	44	70	3,730
20.302.50.25	50	25	44	70	3,620
20.302.50.32	50	32	44	70	3,470

Reference Bezeichnung	
20.302.30.16	15114
20.302.30.20	15014
20.302.40.16	15214
20.302.40.20	15116
20.302.40.25	15016
20.302.40.32	15020
20.302.50.16	15314
20.302.50.20	15216
20.302.50.25	15118 + 15218
20.302.50.32	15020 + 15120





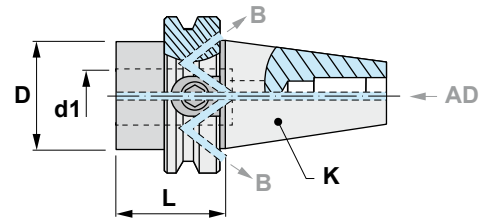

Characteristics:
Short end mill adaptors.
JIS B 6339-BT
For cutters and tooling with cylindrical shank and Weldon flat DIN 1835-B.
Similar to DIN 69871 - Form AD+B



Eigenschaften:
Kurze Aufsteckfräsdorne.
JIS B 6339-BT
Für Fräser und Werkzeuge mit zylindrischem Schaft und Weldon-Fläche DIN 1835-B.
Ähnlich wie DIN 69871 - Form AD+B

23.302

Reference Bezeichnung	K ISO	d1 H4	L	D	
23.302.40.16	40	16	35	45	1,070
23.302.40.20	40	20	35	45	0,990
23.302.40.25	40	25	35	45	0,890
23.302.40.32	40	32	45	50	0,880
23.302.50.16	50	16	44	70	3,880
23.302.50.20	50	20	44	70	3,710
23.302.50.25	50	25	44	70	3,620
23.302.50.32	50	32	44	70	3,450

Reference Bezeichnung	
23.302.40.16	15214
23.302.40.20	15116
23.302.40.25	15016
23.302.40.32	15020
23.302.50.16	15314
23.302.50.20	15216
23.302.50.25	15118 + 15218
23.302.50.32	15020 + 15120

42.610

 I183

Ref. / Bez. Accessories / Zubehör

42.610 Tapping head with axial compensation DIN 1835-B
Gewindeschneidfutter mit Längenausgleich DIN 1835-B



42.620

 I184

Ref. / Bez. Accessories / Zubehör

42.620 Quick change tapping head with axial compensation DIN 1835-B+E
Gewindeschneid-Schnellwechselfutter mit Längenausgleich DIN 1835-B+E



**Characteristics:**

End mill adaptors type Whistle-Notch.

JIS B 6339-BT

For tools with cylindrical shank and tightening inclined flat DIN 1835-E.

Eigenschaften:



Whistle-Notch Zylinderschaft-Aufnahme.

JIS B 6339-BT

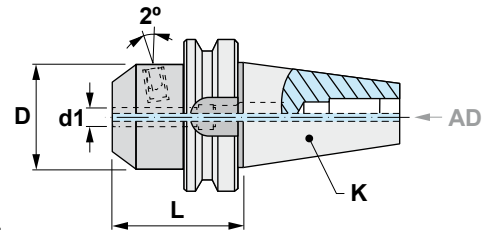
Für Werkzeuge mit zylindrischem Schaft und geneigter Spannfläche DIN 1835-E.



20.305

Reference Bezeichnung	K ISO	d1 H4	L	D			
20.305.30.06	30	6	50	25	19005	15106	0,550
20.305.30.08	30	8	50	28	19106	15108	0,540
20.305.30.10	30	10	50	35	19008	15110	0,590
20.305.30.12	30	12	50	42	19110	15212	0,660
20.305.30.14	30	14	50	44	19110	15212	0,630
20.305.30.16	30	16	50	48	19012	15314	0,650
20.305.30.18	30	18	60	50	19012	15314	0,820
20.305.40.06	40	6	50	25	19005	15106	1,100
20.305.40.08	40	8	50	28	19106	15108	1,140
20.305.40.10	40	10	63	35	19008	15110	1,260
20.305.40.12	40	12	50	42	19110	15212	1,320
20.305.40.14	40	14	50	44	19110	15212	1,360
20.305.40.16	40	16	63	48	19012	15314	1,430
20.305.40.18	40	18	63	50	19012	15314	1,440
20.305.40.20	40	20	63	52	19016	15216	1,430
20.305.40.25	40	25	90	65	19020	2 x 15218	2,240
20.305.40.32	40	32	100	72	19020	2 x 15220	2,730
20.305.50.06	50	6	63	25	19005	15106	3,700
20.305.50.08	50	8	63	28	19106	15108	3,730
20.305.50.10	50	10	65	35	19008	15110	3,810
20.305.50.12	50	12	80	42	19110	15212	4,160
20.305.50.14	50	14	80	44	19110	15212	4,070
20.305.50.16	50	16	80	48	19012	15314	4,110
20.305.50.18	50	18	80	50	19012	15314	4,190
20.305.50.20	50	20	80	52	19016	15216	4,170
20.305.50.25	50	25	100	65	19020	2 x 15218	5,010
20.305.50.32	50	32	105	72	19020	2 x 15220	5,270
20.305.50.40	50	40	120	90	19020	2 x 15220	6,650





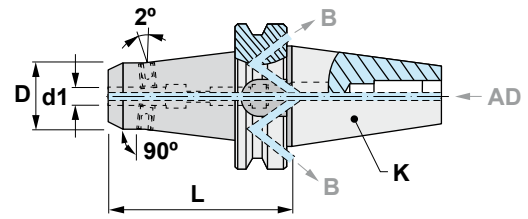

Characteristics:
Combined end mill adaptors type
Weldon / Whistle-Notch.
JIS B 6339-BT
For tools with cylindrical shank and
tightening inclined flat DIN 1835-
B+E.
Similar to DIN 69871 - Form AD+B



Eigenschaften:
Kombi-Aufnahme Typ Weldon /
Whistle-Notch.
JIS B 6339-BT.
Für Werkzeuge mit zylindrischem
Schaft und geneigter Spannfläche
DIN 1835-B+E.
Ähnlich wie DIN 69871 - Form AD+B

23.306

Reference Bezeichnung	K ISO	d1 H4	L	D	D1	2x 	
23.306.40.06/100	40	6	100	22	28	15006	1,240
23.306.40.06/130	40	6	130	22	28	15006	1,340
23.306.40.06/160	40	6	160	22	33	15006	1,560
23.306.40.08/100	40	8	100	24	30	15008	1,270
23.306.40.08/130	40	8	130	24	30	15008	1,420
23.306.40.08/160	40	8	160	24	35	15008	1,620
23.306.40.10/100	40	10	100	30	38	15010	1,460
23.306.40.10/130	40	10	130	30	38	15010	1,630
23.306.40.10/160	40	10	160	30	39	15010	1,850
23.306.40.12/100	40	12	100	32	40	15012	1,440
23.306.40.12/130	40	12	130	32	40	15012	1,730
23.306.40.12/160	40	12	160	32	43	15012	1,950
23.306.40.14/100	40	14	100	32	40	15012	1,470
23.306.40.14/130	40	14	130	32	40	15012	1,650
23.306.40.14/160	40	14	160	32	44	15012	2,200
23.306.40.16/100	40	16	100	36	44	15114	1,580
23.306.40.16/130	40	16	130	36	44	15114	1,830
23.306.40.16/160	40	16	160	36	44	15114	2,100
23.306.40.18/100	40	18	100	38	46	15114	1,600
23.306.40.18/130	40	18	130	38	46	15114	1,900
23.306.40.18/160	40	18	160	38	46	15114	2,700
23.306.40.20/100	40	20	100	44	50	15116	1,710
23.306.40.20/130	40	20	130	44	50	15116	2,070
23.306.40.20/160	40	20	160	44	50	15018	2,490
23.306.40.25/130	40	25	130	50	50	15018	2,240
23.306.40.25/160	40	25	160	50	50	15018	2,660
23.306.50.06/130	50	6	130	22	28	15006	3,970
23.306.50.06/160	50	6	160	22	33	15006	4,140
23.306.50.06/200	50	6	200	22	36	15006	4,440
23.306.50.08/130	50	8	130	24	30	15008	3,950
23.306.50.08/160	50	8	160	24	35	15008	4,240
23.306.50.08/200	50	8	200	24	38	15008	4,530
23.306.50.10/130	50	10	130	30	38	15010	4,250
23.306.50.10/160	50	10	160	30	39	15010	4,470
23.306.50.10/200	50	10	200	30	43	15010	4,900

Reference Bezeichnung	K ISO	d1 H4	L	D	D1	2x 	
23.306.50.12/130	50	12	130	32	40	15012	4,270
23.306.50.12/160	50	12	160	32	43	15012	4,570
23.306.50.12/200	50	12	200	32	46	15012	4,980
23.306.50.14/130	50	14	130	32	40	15012	4,230
23.306.50.14/160	50	14	160	32	44	15012	4,490
23.306.50.14/200	50	14	200	32	48	15012	5,100
23.306.50.16/130	50	16	130	36	44	15114	4,340
23.306.50.16/160	50	16	160	36	44	15114	4,610
23.306.50.16/200	50	16	200	36	50	15114	5,230
23.306.50.18/130	50	18	130	38	46	15114	4,390
23.306.50.18/160	50	18	160	38	46	15114	4,770
23.306.50.18/200	50	18	200	38	52	15114	5,340
23.306.50.20/130	50	20	130	44	50	15116	4,640
23.306.50.20/160	50	20	160	44	50	15116	4,950
23.306.50.20/200	50	20	200	44	55	15116	5,650
23.306.50.25/130	50	25	130	50	56	4 x 15018	4,800
23.306.50.25/160	50	25	160	50	60	4 x 15018	5,440
23.306.50.25/200	50	25	200	50	64	4 x 15018	6,270
23.306.50.32/200	50	32	200	58	72	4 x 15120	7,050



I



Characteristics:

Combined end mills adaptors type Weldon / Whistle-Notch.

JIS B 6339-BT

For tools with cylindrical shank and tightening inclined flat DIN 1835-B+E. Similar to DIN 69871 - Form AD+B

Coolant distribution through the centre or through the flange of the tool.

Eigenschaften:

Kombi-Aufnahme Typ Weldon/ Whistle-Notch. JIS B 6339-BT



Für Werkzeuge mit zylindrischem Schaft und geneigter Spannfläche DIN 1835-B+E.

Ähnlich wie DIN 69871 - Form AD+B

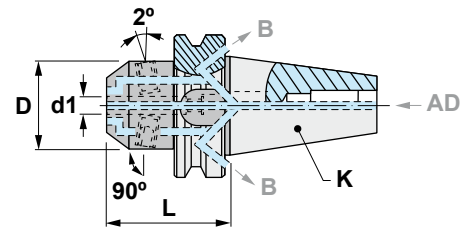
Kühlmittel-Verteilung durch die Zentralbohrung oder durch den Bund.



23.307

Reference Bezeichnung	K ISO	d1 H4	L	D		2x 	
23.307.40.06	40	6	50	25	19005	15106	1,080
23.307.40.08	40	8	50	28	19106	15108	1,130
23.307.40.10	40	10	63	35	19008	15110	1,200
23.307.40.12	40	12	63	42	19110	15212	1,280
23.307.40.14	40	14	63	44	19110	15212	1,290
23.307.40.16	40	16	63	48	19012	15314	1,440
23.307.40.18	40	18	63	50	19012	15314	1,360
23.307.40.20	40	20	63	52	19016	15216	1,380
23.307.40.25	40	25	90	65	19020	4 x 15218	2,190
23.307.40.32	40	32	100	72	19020	4 x 15220	2,700
23.307.50.06	50	6	63	25	19005	15106	3,850
23.307.50.08	50	8	63	28	19106	15108	3,690
23.307.50.10	50	10	65	35	19008	15110	3,950
23.307.50.12	50	12	80	42	19110	15212	3,880
23.307.50.14	50	14	80	44	19110	15212	3,910
23.307.50.16	50	16	80	48	19012	15314	3,990
23.307.50.18	50	18	80	50	19012	15314	4,290
23.307.50.20	50	20	80	52	19016	15216	4,050
23.307.50.25	50	25	100	65	19020	4 x 15218	4,950
23.307.50.32	50	32	105	72	19020	4 x 15220	5,310
23.307.50.40	50	40	120	90	19020	4 x 15220	6,770

**Characteristics:**

Mill adaptors.
JIS B 6339-BT
For frontal end mill support
screwed shanks.
Similar to DIN 69871 - Form AD+B

Eigenschaften:

Spannfutter.
JIS B 6339-BT
Für Einschraubfräser.
Ähnlich wie DIN 69871 - Form AD+B

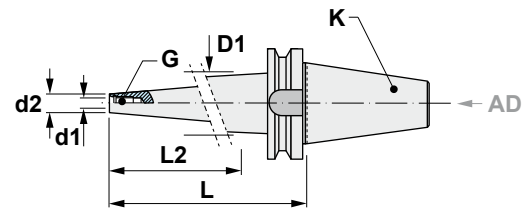

23.315

Reference Bezeichnung	K ISO	L	d1	G	d2	L2	D1	KG
23.315.40.10/055	40	55	10,5	M10	18	25	20	1,040
23.315.40.10/080	40	80	10,5	M10	18	50	23	1,110
23.315.40.10/130	40	130	10,5	M10	18	100	29	1,350
23.315.40.12/055	40	55	12,5	M12	21	25	24	1,100
23.315.40.12/080	40	80	12,5	M12	21	50	26	1,140
23.315.40.12/130	40	130	12,5	M12	21	100	32	1,430
23.315.40.16/055	40	55	17,0	M16	29	25	32	1,100
23.315.40.16/080	40	80	17,0	M16	29	50	35	1,200
23.315.40.16/130	40	130	17,0	M16	29	100	40	1,710
23.315.50.12/090	50	90	12,5	M12	21	50	26	4,100
23.315.50.12/140	50	140	12,5	M12	21	100	32	4,150
23.315.50.12/190	50	190	12,5	M12	21	150	37	4,480
23.315.50.16/090	50	90	17,0	M16	29	50	35	3,950
23.315.50.16/140	50	140	17,0	M16	29	100	40	4,360
23.315.50.16/190	50	190	17,0	M16	29	150	45	4,950



Characteristics:

Antivibratory end mill adaptors.

JIS B 6339-BT

For frontal end mill support screwed shanks.

Manufactured with materials and mechanisms having antivibration properties. Standard and extra long lengths, suitable for moulding and special manufactures.

PRE-BALANCED

ISO-40: 15.000 r.p.m. G-6,3

ISO-50: 10.000 r.p.m. G-6,3

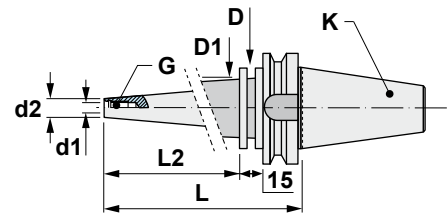

Eigenschaften:

Schwingungsgedämpfte Aufsteckfräsdorne für Einschraubfräser. JIS B 6339-BT

Hergestellt mit schwingungsdämpfenden Materialien und Mechanismen.

Standard und extralange Ausführungen sind für Werkzeug- und Formenbau besonders geeignet.

VORGEWUCHTET

ISO-40: 15.000 r.p.m. G-6,3

ISO-50: 10.000 r.p.m. G-6,3

A20.315

Reference Bezeichnung	K ISO	L2	D1	L	D	d1	G	d2	
A20.315.40.10/200	40	158	35	200	50	10,5	M10	18	1,970
A20.315.40.10/250	40	208	40	250	50	10,5	M10	18	2,260
A20.315.40.10/300	40	258	45	300	50	10,5	M10	18	2,820
A20.315.40.12/200	40	158	38	200	50	12,5	M12	21	2,000
A20.315.40.12/250	40	208	43	250	50	12,5	M12	21	2,490
A20.315.40.12/300	40	258	44	300	50	12,5	M12	21	3,130
A20.315.40.16/200	40	158	43	200	50	17,0	M16	29	2,490
A20.315.40.16/250	40	208	44	250	50	17,0	M16	29	2,810
A20.315.40.16/300	40	258	47	300	50	17,0	M16	29	3,450
A20.315.50.12/250	50	197	42	250	80	12,5	M12	21	5,250
A20.315.50.12/300	50	247	47	300	80	12,5	M12	21	5,910
A20.315.50.12/400	50	347	57	400	80	12,5	M12	21	7,580
A20.315.50.16/300	50	247	55	300	80	17,0	M16	29	6,800
A20.315.50.16/400	50	347	65	400	80	17,0	M16	29	9,000
A20.315.50.16/500	50	447	76	500	80	17,0	M16	29	12,000



Characteristics:
Collet chucks for DIN 6388 collets.
JIS B 6339-BT
For tools with cylindrical shank
DIN 1835-B.

* Ball bearing nut, see page: I220

*** SUPPLIED WITHOUT WRENCH**

Eigenschaften:
Spannzangenfutter für Spannzangen
DIN6388. JIS B 6339-BT
Für Werkzeuge mit zylindrischem
Schaft DIN 1835-B.

* Für Kugellager-Mutter, siehe Seite: I220

*** LIEFERUNG OHNE SCHLÜSSEL**

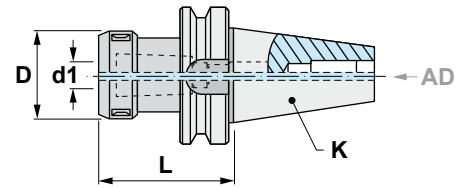

20.353

Reference Bezeichnung	K ISO	L	d1	D				
20.353.30.16	30	65	2-16	43	43316	50116	19216	0,650
20.353.30.25	30	70	3-25	60	43325	50125	19216	0,830
20.353.40.16	40	70	2-16	43	43316	50116	19216	1,210
20.353.40.16/120	40	120	2-16	43	43316	50116	19216	1,580
20.353.40.25	40	70	3-25	60	43325	50125	19224	1,320
20.353.40.25/120	40	120	3-25	60	43325	50125	19224	1,880
20.353.40.32	40	90	4-32	72	43332	50132	19224	1,790
20.353.50.16	50	70	2-16	43	43316	50116	19216	3,850
20.353.50.16/120	50	120	2-16	43	43316	50116	19216	4,170
20.353.50.25	50	85	3-25	60	43325	50125	19224	4,100
20.353.50.25/140	50	140	3-25	60	43325	50125	19224	4,980
20.353.50.32	50	90	4-32	72	43332	50132	19230	4,220

BXX

I206-208

Ref. / Bez.	Accessories / Zubehör
BXX	Collets with double slot DIN 6388 - Form B Spannzangen mit Doppelnut DIN 6388 - Form B





Characteristics:
Strong hold collet chuck for cylindrical collets.
JIS B 6339-BT

Eigenschaften:
Kraftspannfutter für zylindrische Spannzangen.
JIS B 6339-BT

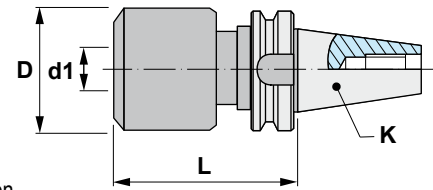

20.400

Reference Bezeichnung	K ISO	L	d1	D	
20.400.40.20	40	105	20	54	1,950
20.400.40.32	40	105	32	72	2,550
20.400.50.20	50	105	20	54	3,850
20.400.50.32	50	105	32	72	4,450

Complements (collets type C) / Zubehör (Spannzangen typ C)

Reference / Bezeichnung	d	D	L
C2006	6	20	55
C2008	8	20	55
C2010	10	20	55
C2012	12	20	55
C2016	16	20	55
C3206	6	32	65
C3208	8	32	65
C3210	10	32	65
C3212	12	32	65
C3216	16	32	65
C3220	20	32	65
C3225	25	32	65

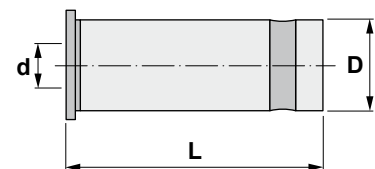

**Characteristics:**

Set of strong hold milling chuck and collets.
JIS B 6339-BT

Eigenschaften:

Satz mit Kraftspannfutter und Spannzangen.
JIS B 6339-BT

SET-C20/32

Reference Bezeichnung	JIS	Composition Bestehend aus	
SET-20.40.C20	JIS B 6339-BT	1 x 20.400.40.20 + 5 collets / Spannzangen	4,500
SET-20.40.C32	JIS B 6339-BT	1 x 20.400.40.32 + 7 collets / Spannzangen	6,800
SET-20.50.C32	JIS B 6339-BT	1 x 20.400.50.32 + 7 collets / Spannzangen	9,300





Characteristics:

Collet chucks for DIN 6499 (ER) collets.
JIS B 6339-BT

For tools with cylindrical shank
DIN 1835-B.

* Ball bearing nut, see page: I221

*** SUPPLIED WITHOUT WRENCH**

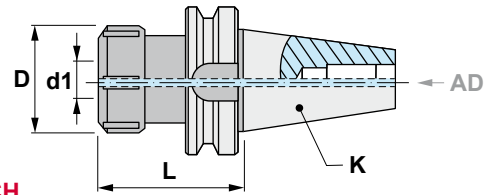

Eigenschaften:

Spannzangenfutter für Spannzangen
DIN 6499 (ER).





JIS B 6339-BT

Für Werkzeuge mit zylindrischem Schaft
DIN 1835-B.

* Für Kugellager-Mutter, siehe Seite: I221

*** LIEFERUNG OHNE SCHLÜSSEL**

20.453

Reference Bezeichnung	K ISO		L	d1	D				
20.453.30.16	30	ER16	55	0,5-10	32	45316	50216	19210	0,490
20.453.30.20	30	ER20	55	1-13	35	45320	50220	19212	0,490
20.453.30.25	30	ER25	55	1-16	42	45325	50225	19216	0,520
20.453.30.32	30	ER32	60	2-20	50	45332	50232	19218	0,580
20.453.40.16	40	ER16	70	0,5-10	32	45316	50216	19210	1,130
20.453.40.16/100	40	ER16	100	0,5-10	32	45316	50216	19210	1,230
20.453.40.16/150	40	ER16	150	0,5-10	32	45316	50216	19210	1,400
20.453.40.20	40	ER20	70	1-13	35	45320	50220	19212	1,120
20.453.40.20/100	40	ER20	100	1-13	35	45320	50220	19212	1,320
20.453.40.20/150	40	ER20	150	1-13	35	45320	50220	19212	1,550
20.453.40.25	40	ER25	70	1-16	42	45325	50225	19216	1,200
20.453.40.25/100	40	ER25	100	1-16	42	45325	50225	19216	1,690
20.453.40.25/150	40	ER25	150	1-16	42	45325	50225	19216	1,790
20.453.40.32	40	ER32	70	2-20	50	45332	50232	19222	1,230
20.453.40.32/100	40	ER32	100	2-20	50	45332	50232	19222	2,090
20.453.40.32/150	40	ER32	150	2-20	50	45332	50232	19222	2,180
20.453.40.40	40	ER40	70	3-30	63	45340	50240	19224	1,340
20.453.40.40/150	40	ER40	150	3-30	63	45340	50240	19224	2,280
20.453.50.16/100	50	ER16	100	0,5-10	32	45316	50216	19210	3,840
20.453.50.16/150	50	ER16	150	0,5-10	32	45316	50216	19210	4,080
20.453.50.20/100	50	ER20	100	1-13	35	45320	50220	19212	3,950
20.453.50.20/150	50	ER20	150	1-13	35	45320	50220	19212	4,060
20.453.50.25	50	ER25	70	1-16	42	45325	50225	19216	3,830
20.453.50.25/150	50	ER25	150	1-16	42	45325	50225	19216	4,360
20.453.50.32	50	ER32	70	2-20	50	45332	50232	19222	3,850
20.453.50.32/100	50	ER32	100	2-20	50	45332	50232	19222	4,660
20.453.50.32/150	50	ER32	150	2-20	50	45332	50232	19222	4,530
20.453.50.40	50	ER40	80	3-30	63	45340	50240	19224	4,060
20.453.50.40/150	50	ER40	150	3-30	63	45340	50240	19224	5,240
20.453.50.50	50	ER50	90	10-34	78	45350	50250	19230	4,290

ERXX ⓘ I210-212

Reference / Bez.

ERXX



ERCXX ⓘ I215-216

Reference / Bez.

ERCXX



ERTXX ⓘ I217-218

Reference / Bez.

ERTXX



40.453.. ⓘ I180

Reference / Bez.

40.453..



40.455.. ⓘ I181

Reference / Bez.

40.455..





Characteristics:

Collet chucks for DIN 6499 (ER) collets. JIS B 6339-BT
For tools with cylindrical shank DIN 1835-B.
Similar to DIN 69871 - Form AD+B
* Ball bearing nut, see page: I221

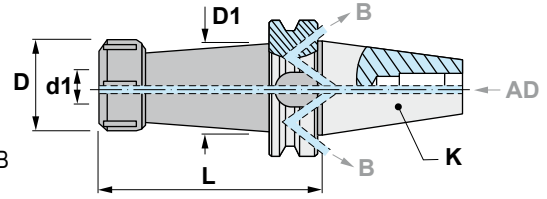





*** SUPPLIED WITHOUT WRENCH**

Eigenschaften:

Spannzangenfutter für Spannzangen
DIN 6499 (ER). JIS B 6339-BT.
Für Werkzeuge mit zylindrischem
Schaft DIN 1835-B.
Ähnlich wie DIN 69871 - Form AD+B
* Für Kugellager-Mutter, siehe Seite: I221

*** LIEFERUNG OHNE SCHLÜSSEL**

23.453

Reference Bezeichnung	K ISO		L	d1	D	D1				
23.453.40.16	40	ER16	70	0,5-10	32	-	45316	50216	19210	1,140
23.453.40.16/100	40	ER16	100	0,5-10	32	28	45316	50216	19210	1,310
23.453.40.16/150	40	ER16	150	0,5-10	32	28	45316	50216	19210	1,390
23.453.40.20	40	ER20	70	1-13	35	-	45320	50220	19212	1,140
23.453.40.20/100	40	ER20	100	1-13	35	34	45320	50220	19212	1,480
23.453.40.20/150	40	ER20	150	1-13	35	34	45320	50220	19212	1,520
23.453.40.25	40	ER25	70	1-16	42	-	45325	50225	19216	1,200
23.453.40.25/150	40	ER25	150	1-16	42	42	45325	50225	19216	1,850
23.453.40.32	40	ER32	70	2-20	50	-	45332	50232	19222	1,230
23.453.40.32/150	40	ER32	150	2-20	50	50	45332	50232	19222	2,100
23.453.40.40	40	ER40	70	3-30	63	-	45340	50240	19224	1,340
23.453.40.40/150	40	ER40	150	3-30	63	63	45340	50240	19224	2,430
23.453.50.16/100	50	ER16	100	0,5-10	32	28	45316	50216	19210	3,870
23.453.50.16/150	50	ER16	150	0,5-10	32	28	45316	50216	19210	4,170
23.453.50.20/100	50	ER20	100	1-13	35	28	45320	50220	19212	3,910
23.453.50.20/150	50	ER20	150	1-13	35	28	45320	50220	19212	4,360
23.453.50.25	50	ER25	70	1-16	42	-	45325	50225	19216	3,810
23.453.50.25/150	50	ER25	150	1-16	42	42	45325	50225	19216	4,320
23.453.50.32	50	ER32	70	2-20	50	-	45332	50232	19222	3,810
23.453.50.32/100	50	ER32	100	2-20	50	50	45332	50232	19222	4,660
23.453.50.32/150	50	ER32	150	2-20	50	50	45332	50232	19222	5,190
23.453.50.40	50	ER40	80	3-30	63	-	45340	50240	19224	3,950
23.453.50.40/150	50	ER40	150	3-30	63	63	45340	50240	19224	5,180
23.453.50.50	50	ER50	90	10-34	78	-	45350	50250	19230	4,230

ERXX ⓘ I210-212
Reference / Bez.
ERXX



ERCXX ⓘ I215-216
Reference / Bez.
ERCXX



ERTXX ⓘ I217-218
Reference / Bez.
ERTXX



40.453.. ⓘ I180
Reference / Bez.
40.453..



40.455.. ⓘ I181
Reference / Bez.
40.455..





Characteristics:
Long collet chuck for DIN 6499 (ER) collets.
JIS B 6339-BT
For tools with cylindrical shank.
With "mini" collet nut.

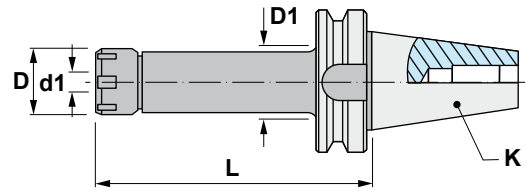

*** SUPPLIED WITHOUT WRENCH**

Eigenschaften:
Lange Spannzangenfutter für Spannzangen DIN 6499 (ER).
JIS B 6339-BT
Für Werkzeuge mit zylindrischem Schaft.
Mit "Mini"-Spannmutter.

*** LIEFERUNG OHNE SCHLÜSSEL**

20.455

Reference Bezeichnung	K ISO		L	d1	D	D1				
20.455.40.16/100	40	ER16	100	0,5-10	22	22	45516	50916	19210	1,230
20.455.40.16/130	40	ER16	130	0,5-10	22	22	45516	50916	19210	1,310
20.455.40.16/160	40	ER16	160	0,5-10	22	22	45516	50916	19210	1,390
20.455.40.20/100	40	ER20	100	1-13	28	28	45520	50920	19212	1,350
20.455.40.20/160	40	ER20	160	1-13	28	28	45520	50920	19212	1,580
20.455.40.25/100	40	ER25	100	1-16	35	35	45525	50925	19216	1,600
20.455.40.25/160	40	ER25	160	1-16	35	35	45525	50925	19216	1,990

ERXX

 I210-212

Ref. / Bez. Accessories / Zubehör

ERXX Collets with double slot DIN 6499 - Form B (ER)
Spannzangen mit Doppelnut DIN 6499 - Form B (ER)



ERCXX

 I215-216

Ref. / Bez. Accessories / Zubehör

ERCXX Sealed collets DIN 6499 (ER)
Abgedichtete Spannzangen DIN 6499 (ER)



ERTXX

 I217-218

Ref. / Bez. Accessories / Zubehör

ERTXX Collets DIN 6499 - Form Mexin (ER)
Spannzangen DIN 6499 - Form Mexin (ER)





Characteristics:
Mechanical collet chuck with high tightening torque and precision.
JIS B 6339-BT
For DIN 6499 (ER) collets.
The alternative to hydraulic or other systems. With central coolant supply.

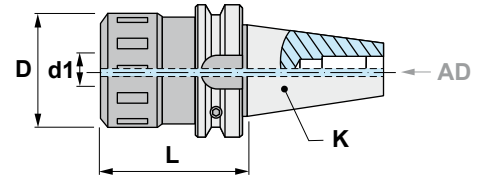





*** SUPPLIED WITH WRENCH**

Eigenschaften:
Mechanisches Spannzangenfutter mit hohem Anzugsmoment.
JIS B 6339-BT
Für Spannzangen DIN 6499 (ER).
Die Alternative zu hydraulischen und anderen Systemen. Mit Innenkühlung.

*** LIEFERUNG MIT SCHLÜSSEL**

20.457

Reference Bezeichnung	K ISO		L	d1	D				
20.457.40.32	40	ER32	80	2-20	54	45732	50704	19006	1,420
20.457.50.32	50	ER32	110	2-20	54	45732	50704	19006	4,610
20.457.50.40	50	ER40	120	3-30	65	45740	50706	19010	5,500

ERXX

 I210-212

Ref. / Bez. Accessories / Zubehör

ERXX Collets with double slot DIN 6499 - Form B (ER)
Spannzangen mit Doppelnut DIN 6499 - Form B (ER)



ERCXX

 I215-216

Ref. / Bez. Accessories / Zubehör

ERCXX Sealed collets DIN 6499 (ER)
Abgedichtete Spannzangen DIN 6499 (ER)





Characteristics:

Mechanical collet chuck with high tightening torque and precision.
JIS B 6339-BT
For DIN 6499 (ER) collets.
The alternative to hydraulic or other systems. With central coolant supply.

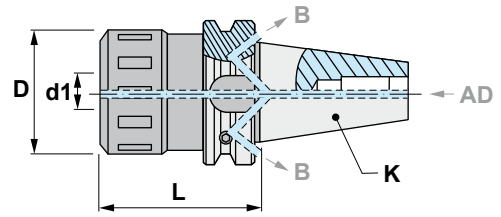





*** SUPPLIED WITH WRENCH**

Eigenschaften:

Mechanisches Spannzangenfutter mit hohem Anzugsmoment.
JIS B 6339-BT
Für Spannzangen DIN 6499 (ER).
Die Alternative zu hydraulischen und anderen Systemen. Mit Innenkühlung.

*** LIEFERUNG MIT SCHLÜSSEL**

23.457

Reference Bezeichnung	K ISO		L	d1	D				
23.457.40.32	40	ER32	80	2-20	54	45732	50704	19006	1,750
23.457.50.32	50	ER32	110	2-20	54	45732	50704	19006	4,380
23.457.50.40	50	ER40	120	3-30	65	45740	50706	19010	5,470

ERXX

 I210-212

Ref. / Bez. Accessories / Zubehör

ERXX Collets with double slot DIN 6499 - Form B (ER)
Spannzangen mit Doppelnut DIN 6499 - Form B (ER)



ERCXX

 I215-216

Ref. / Bez. Accessories / Zubehör

ERCXX Sealed collets DIN 6499 (ER)
Abgedichtete Spannzangen DIN 6499 (ER)





Characteristics:
Blank adaptors.
JIS B 6339-BT

Eigenschaften:
Rohlinge.
JIS B 6339-BT

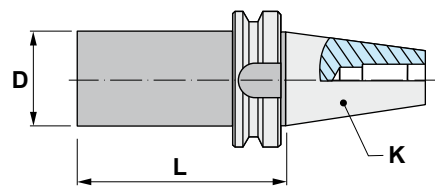

20.470

Reference Bezeichnung	K ISO	D	L	
20.470.30.40	30	40,5	160	2,170
20.470.40.63/250	40	63,5	250	6,570
20.470.50.95/315	50	95,5	315	19,000



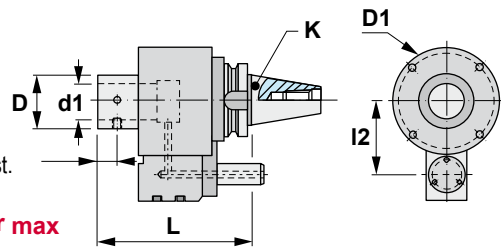

Characteristics:
Cooling fluid supply unit.
JIS B 6339-BT similar to DIN 6359
For tools with cylindrical shank
DIN 1835-B/E.
* Other sizes are manufactured on request.



rpm max 4.000 min. -1 ± 25 bar max

Eigenschaften:
Drehverteiler für Innenkühlung.
JIS B 6339-BT ähnlich wie DIN 6359.
Für Werkzeuge mit zylindrischem
Schaft DIN 1835-B/E.
* Andere Größen werden auf Anfrage hergestellt.

20.512

Reference Bezeichnung	K ISO	d1 G6	L	D	D1	I1	I2*		
20.512.40.25	40	25	152	45	95	15	65	14116	5,780
20.512.40.32	40	32	152	48	95	16	65	14116	5,640
20.512.50.32	50	32	152	48	110	16	80	14116	8,100
20.512.50.40	50	40	166	58	110	17	80	14116	8,140

Complements of 512 group / Zubehör von gruppe 512

Reference / Bezeichnung	D	d	D1	L
512.25.16	25	16	33	60
512.25.20		20	33	60
512.32.16	32	16	40	60
512.32.20		20	40	60
512.32.25		25	40	60
512.40.16	40	16	48	60
512.40.20		20	48	60
512.40.25		25	48	60
512.40.32		32	48	60
512.00.00				

512..

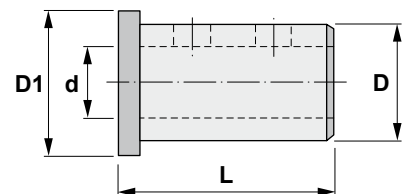

512.00.00

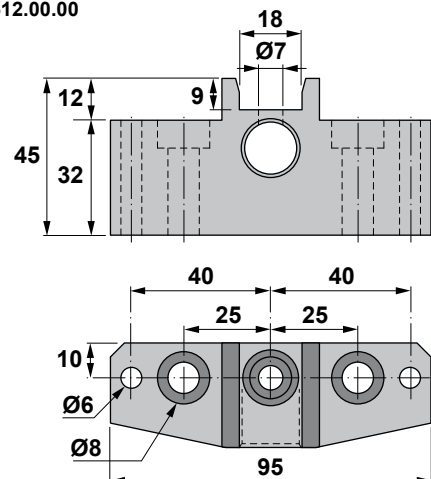

**Characteristics:**

Tapping head with axial compensation.

JIS B 6339-BT

For DIN 6499 (ER) collets and with central coolant supply.

Compensation in compression (C) and tension (T). Compression can be blocked by turning the rear ring (A). Control of threading depth.

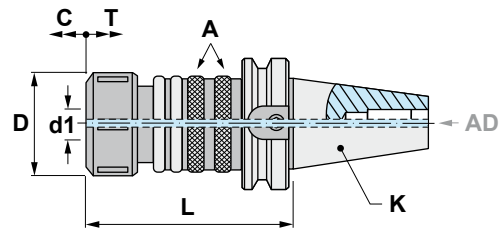



*** SUPPLIED WITH WRENCH****Eigenschaften:**

Gewindeschneidfutter mit Längenausgleich JIS B 6339-BT.

Befestigung mit Spannzangen 6499 (ER) und mit Innenkühlung.

Ausgleich der Kompression (C) und der Traktion (T). Die Kompression kann mit dem Ring (A) blockiert werden. Kontrolle der Gewindetiefe.

*** LIEFERUNG MIT SCHLÜSSEL****20.610**

Reference Bezeichnung	K ISO			d1	L	D	C	T			
20.610.30.16	30	ER16	M3-M12	99	28	5,5	6,0	45316	50216	0,580	
20.610.40.16	40	ER16	M3-M12	100	28	5,5	6,0	45316	50216	1,560	
20.610.40.25	40	ER25	M4-M20	125	42	10,5	7,5	45325	50225	2,170	
20.610.40.40	40	ER40	M8-M33	141	63	10,0	10,0	45340	50240	3,440	
20.610.50.16	50	ER16	M3-M12	100	28	5,5	6,0	45316	50216	4,230	
20.610.50.25	50	ER25	M4-M20	134	42	10,5	7,5	45325	50225	4,960	
20.610.50.40	50	ER40	M8-M33	150	63	10,0	10,0	45340	50240	6,230	

ERXX
 I210-212

Ref. / Bez.	Accessories / Zubehör
ERXX	Collets with double slot DIN 6499 - Form B (ER) Spannzangen mit Doppelnut DIN 6499 - Form B (ER)

**ERCXX**
 I215-216

Ref. / Bez.	Accessories / Zubehör
ERCXX	Sealed collets DIN 6499 (ER) Abgedichtete Spannzangen DIN 6499 (ER)

**ERTXX**
 I217-218

Ref. / Bez.	Accessories / Zubehör
ERTXX	Collets DIN 6499 - Form Mexin (ER) Spannzangen DIN 6499 - Form Mexin (ER)

**40.453..**
 I180

Ref. / Bez.	Accessories / Zubehör
40.453..	Collet chucks for DIN 6499 (ER) collets Spannzangenfutter für DIN 6499 (ER) Spannzangen

**40.455..**
 I181

Ref. / Bez.	Accessories / Zubehör
40.455..	Long collet chucks for DIN 6499 (ER) collets Lange Spannzangenfutter für DIN 6499 (ER) Spannzangen





Characteristics:
Tapping head with axial compensation.
JIS B 6339-BT
For DIN 6499 (ER) collets and with central coolant supply.
Compensation in compression (C) and tension (T). Compression can be blocked by turning the rear ring (A). Control of threading depth.

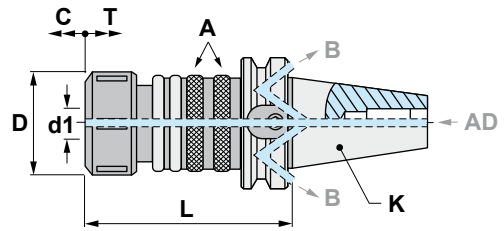

*** SUPPLIED WITH WRENCH**

Eigenschaften:
Gewindeschneidfutter mit Längenausgleich JIS B 6339-BT.
Befestigung mit Spannzangen 6499 (ER) und mit Innenkühlung.
Ausgleich der Kompression (C) und der Traktion (T). Die Kompression kann mit dem Ring (A) blockiert werden. Kontrolle der Gewindetiefe.

*** LIEFERUNG MIT SCHLÜSSEL**

23.610

Reference Bezeichnung	K ISO			d1	L	D	C	T			
23.610.40.16	40	ER16	M3-M12	100	28	5,5	6,0	45316	50216	1,540	
23.610.40.25	40	ER25	M4-M20	125	42	10,5	7,5	45325	50225	2,170	
23.610.40.40	40	ER40	M8-M33	141	63	10,0	10,0	45340	50240	3,440	
23.610.50.16	50	ER16	M3-M12	100	28	5,5	6,0	45316	50216	4,300	
23.610.50.25	50	ER25	M4-M20	134	42	10,5	7,5	45325	50225	4,960	
23.610.50.40	50	ER40	M8-M33	150	63	10,0	10,0	45340	50240	6,230	

ERXX

I210-212

Ref. / Bez. Accessories / Zubehör

ERXX Collets with double slot DIN 6499 - Form B (ER)
Spannzangen mit Doppelnut DIN 6499 - Form B (ER)



ERCXX

I215-216

Ref. / Bez. Accessories / Zubehör

ERCXX Sealed collets DIN 6499 (ER)
Abgedichtete Spannzangen DIN 6499 (ER)



ERTXX

I217-218

Ref. / Bez. Accessories / Zubehör

ERTXX Collets DIN 6499 - Form Mexin (ER)
Spannzangen DIN 6499 - Form Mexin (ER)



40.453..

I180

Ref. / Bez. Accessories / Zubehör

40.453.. Collet chucks for DIN 6499 (ER) collets
Spannzangenfutter für DIN 6499 (ER) Spannzangen



40.455..

I181

Ref. / Bez. Accessories / Zubehör

40.455.. Long collet chucks for DIN 6499 (ER) collets
Lange Spannzangenfutter für DIN 6499 (ER) Spannzangen





Characteristics:

Quick change tapping head with axial compensation.
JIS B 6339-BT
With Bilz system tap chuck bushings.

Compensation in compression (C) and tension (T).

Eigenschaften:

Gewindeschneid-Schnellwechselfutter mit Längenausgleich.
JIS B 6339-BT
Mit Schnellwechseleinsätze Bilz-System.

Ausgleich der Kompression (C) und der Traktion (T).

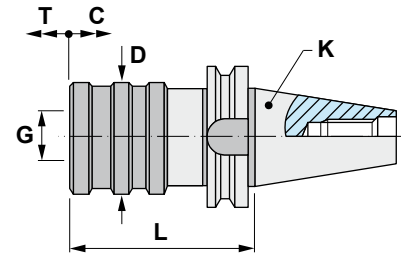

20.620

Reference Bezeichnung	K ISO	N° Ø	d1	L	D	C	T			
20.620.30.12	30	1 19	M3-M12	63	38	9	9	710XX	750XX	1,000
20.620.40.12	40	1 19	M3-M12	68	38	9	9	710XX	750XX	1,220
20.620.40.20	40	2 31	M8-M20	93	55	15	15	720XX	760XX	1,700
20.620.40.33	40	3 48	M14-M33	138	79	24	24	730XX	770XX	3,710
20.620.50.12	50	1 19	M3-M12	80	38	9	9	710XX	750XX	3,940
20.620.50.20	50	2 31	M8-M20	102	55	15	15	720XX	760XX	4,420
20.620.50.33	50	3 48	M14-M33	135	79	24	24	730XX	770XX	5,630

710XX..730XX

I202

Ref. / Bezeichnung

Accessories / Zubehör

710XX..730XX

Quick change adapters without overload clutch
Schnellwechseleinsätze ohne Sicherheitskupplung



750XX..770XX

I203

Ref. / Bezeichnung

Accessories / Zubehör

750XX..770XX

Quick change adapters with overload clutch
Schnellwechseleinsätze mit Sicherheitskupplung





Characteristics:

Quick change tapping head for rigid tapping.
With Bilz system tap chuck bushings.

With central coolant.

Eigenschaften:

Gewindeschneid-Schnellwechselfutter ohne Längenausgleich.
JIS B 6339-BT
Mit Schnellwechseleinsätze Bilz-System.

Mit Innenkühlung.

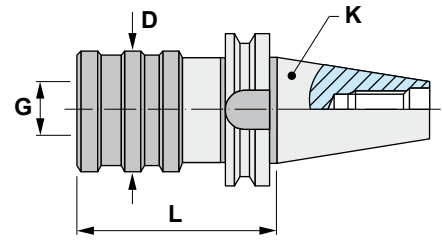

20.630

Reference Bezeichnung	K ISO	N ^o . N ^o . Ø	d1	L	D			
20.630.30.12	30	1 19	M3-M12	60	33	710XX	750XX	1,000
20.630.40.12	40	1 19	M3-M12	67	33	710XX	750XX	1,170
20.630.40.20	40	2 31	M8-M20	90	50	720XX	760XX	1,620
20.630.40.33	40	3 48	M14-M33	117	72	730XX	770XX	2,000
20.630.50.12	50	1 19	M3-M12	78	33	710XX	750XX	4,600
20.630.50.20	50	2 31	M8-M20	101	50	720XX	760XX	4,600
20.630.50.33	50	3 48	M14-M33	125	72	730XX	770XX	5,000

710XX..730XX

I202

Ref. / Bezeichnung Accessories / Zubehör

710XX..730XX Quick change adapters without overload clutch
Schnellwechseleinsätze ohne Sicherheitskupplung



750XX..770XX

I203

Ref. / Bezeichnung Accessories / Zubehör

750XX..770XX Quick change adapters with overload clutch
Schnellwechseleinsätze mit Sicherheitskupplung





Characteristics:
Test arbors.
JIS B 6339-BT

Eigenschaften:
Prüfdorne.
JIS B 6339-BT

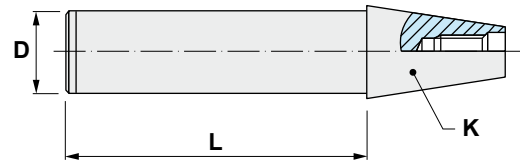

20.999

Reference Bezeichnung	K ISO	L	D	
20.999.30	30	300	32	2,160
20.999.40	40	300	40	3,710
20.999.50	50	300	50	7,780

1 TYPE / TYP

20.160	20.165	20.180	20.210	20.215	20.216	20.225	20.226	20.290
20.295	20.296	20.300	20.302	20.305	20.353	20.400	20.453	20.455
20.457	20.470	20.512	20.610	20.620	20.630	A20.160	A20.160	A20.315
23.160	23.210	23.215	23.296	23.300	23.302	23.306	23.307	23.315
23.453	23.457	23.610						

2 DIMENSION / ABMESSUNGEN

30	40	50	60
-----------	-----------	-----------	-----------

3 LENGTH / LÄNGE (L)

<p>Ø DIAMETER / DURCHMESSER</p>	<p>MK</p>	<p>ISO</p>	<p>COLLET SPANNZANGEN</p>

NOTES / BEMERKUNGEN: _____



BORING HEADS BOHRKÖPFE

Code system Kodifizierung	I148-151
Technical information Technische Auskünfte	I152
Applications index Anwendungen	I153
Adjustable boring bars Verstellbare Bohrstangen	I154
Boring heads Bohrköpfe	I155-163
Arbors for boring heads Aufnahmen für Bohrköpfe	I164-170
Sets Sätze	I171
Special tool request Sonderwerkzeug-Anfrage	I172



Code system - Boring heads Kodifizierung - Bohrköpfe

63	12	2430
1	2	3

1 Holder style Haltertyp

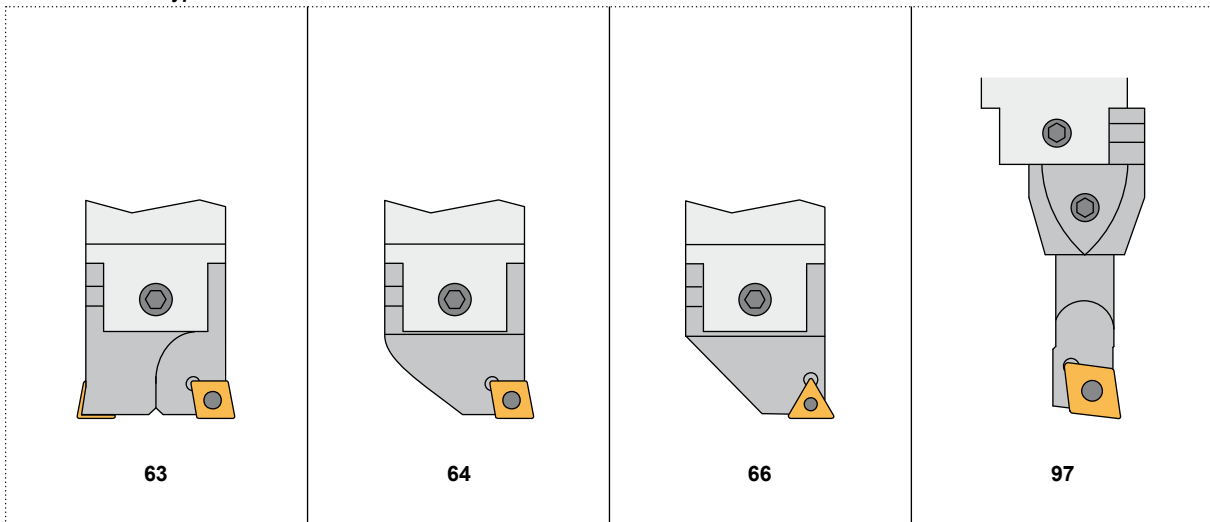

2 Adapter size, mm. Adaptergröße, mm.

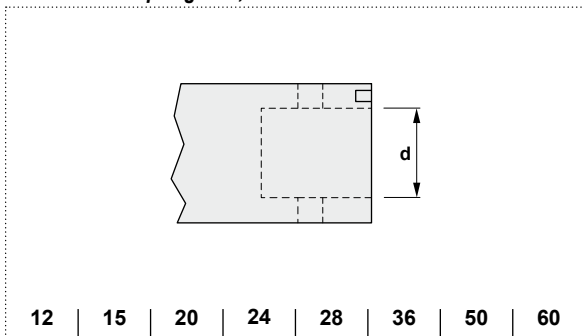

3 Diameter (Min.-Max.), mm. Durchmesser (Min.-Max.), mm.

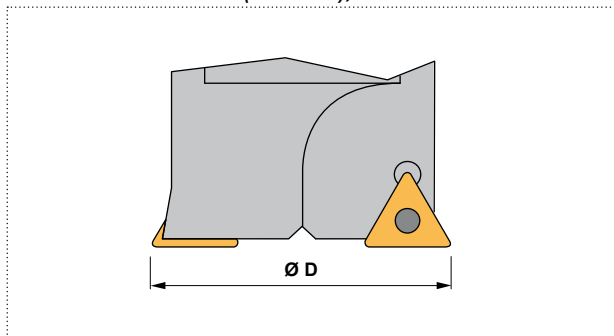

Code system - Arbors for boring heads Kodifizierung - Aufnahmen für Bohrköpfe

10 700 30 12 / 100

1 2 3 4 5



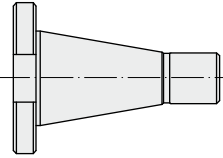
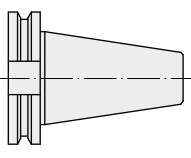
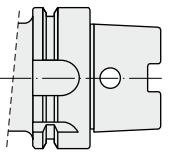
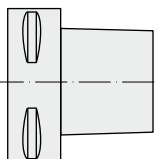
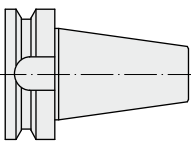

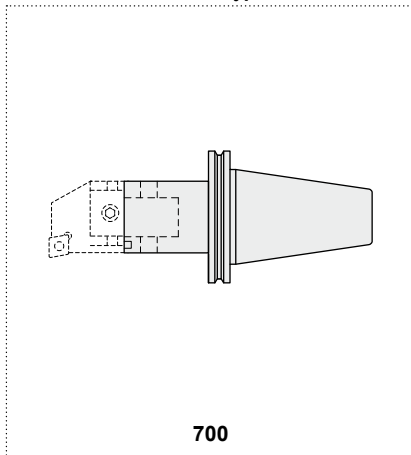

1 Machining center Modell

 10	DIN 2080	 11	ISO 7388	 16	DIN 69871/A HSK DIN 69893-1
 18	PSC ISO 26623-1	 20	ISO	JIS B 6339-BT	

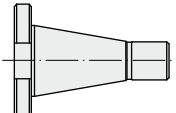
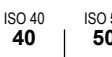
2 Adapter type Aufnahmen-Typ

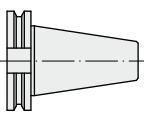

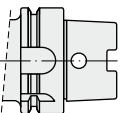
3 Connection dimension Aufnahmengröße

 ISO 30	 ISO 40	 ISO 50	 7388 30	 7388 40	 7388 50	 50	 63	 100
PSC			ISO 26623-1			ISO		
						DIN 69871/A HSK DIN 69893-1		
						JIS B 6339-BT		
						BT 30 30		
						BT 40 40		
						BT 50 50		

4 Adapter size, mm. Adaptergröße, mm.

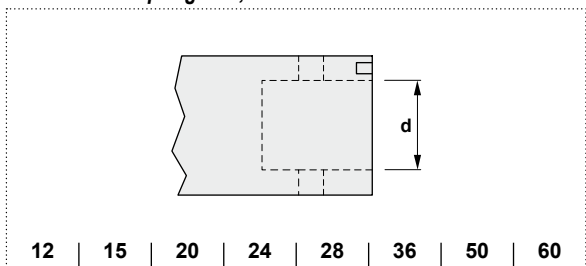

5 Adapter length, mm. Adapterlänge, mm.

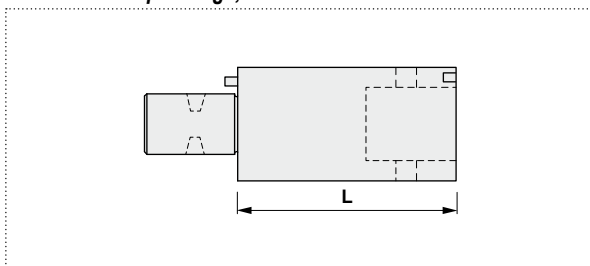

Code system - Arbors for boring heads Kodifizierung - Aufnahmen für Bohrköpfe

60 **12** **12** / **20**
1 2 3 4

1 Adapter type
Aufnahmen-Typ

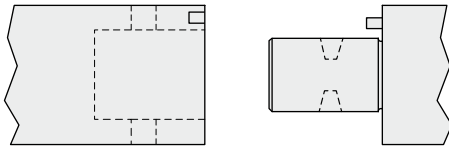

60

2 Adapter size, mm.
Adaptergröße, mm.

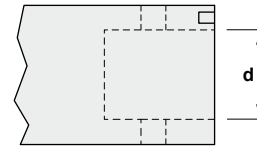

12 | 15 | 20 | 24 | 28 | 36 | 50 | 60

3 Shank diameter, mm.
Schaftdurchmesser, mm.

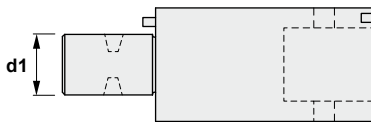

4 Adapter length, mm.
Adapterlänge, mm.

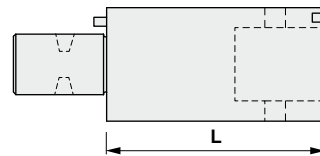

60 **62** **12**
1 2 3

1 Adapter type
Aufnahmen-Typ

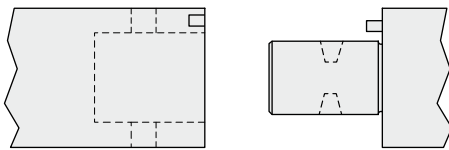

60

2 Shank diameter
Schaftdurchmesser

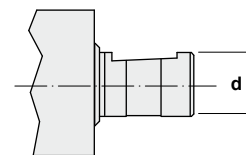





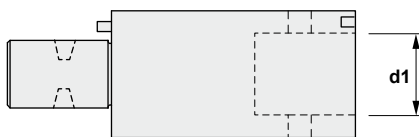

62 | 63 | 64

3 Adapter size, mm.
Adaptergröße, mm.

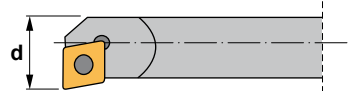
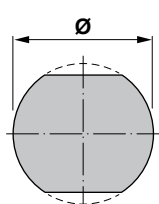
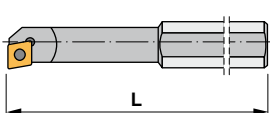
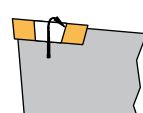

Code system - Tools for boring heads Kodifizierung - Werkzeuge für Bohrköpfe

S	08	16	F	S	C	L	C	R	06
1	2	3	4	5	6	7	8	9	10

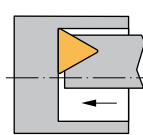
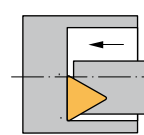
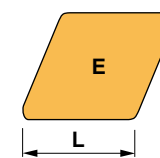
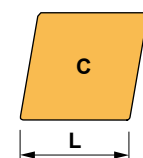
<p>1 Type of bar Schaft-Ausführung</p> <p>A Steel shank with coolant hole Bohrstange aus Stahl mit Kühlmittelzufuhr</p> <p>S Steel shank Standard-Bohrstange aus Stahl</p>	<p>2 Minimum diameter, mm. Minimum Durchmesser, mm.</p> 	<p>3 Bar diameter, mm. Schaftdurchmesser, mm.</p> 														
<p>4 Bar length, mm. Werkzeuglänge, mm.</p>  <table border="1"> <tr> <td>70</td> <td>80</td> <td>90</td> <td>100</td> <td>110</td> <td>115</td> <td>Special Sonderausführung:</td> </tr> <tr> <td>E</td> <td>F</td> <td>G</td> <td>H</td> <td>I</td> <td>J</td> <td>X</td> </tr> </table>	70	80	90	100	110	115	Special Sonderausführung:	E	F	G	H	I	J	X	<p>5 Clamping method of insert Klemmsystem</p>  <p>S</p>	<p>6 Insert shape Wendeplatten-Form</p>   <p>C T</p>
70	80	90	100	110	115	Special Sonderausführung:										
E	F	G	H	I	J	X										
<p>7 Holder style Einstellwinkel</p>  <p>F</p>  <p>L</p>	<p>8 Clearance angle of insert Wendeschneidplatten-Freiwinkel</p>  <p>C</p>  <p>P</p>															
<p>9 Hand Bearbeitungsrichtung</p>  <p>L</p>  <p>R</p>	<p>10 Cutting edge length, mm. Schneidkantenlänge, mm.</p>  <p>E</p>  <p>C</p>															



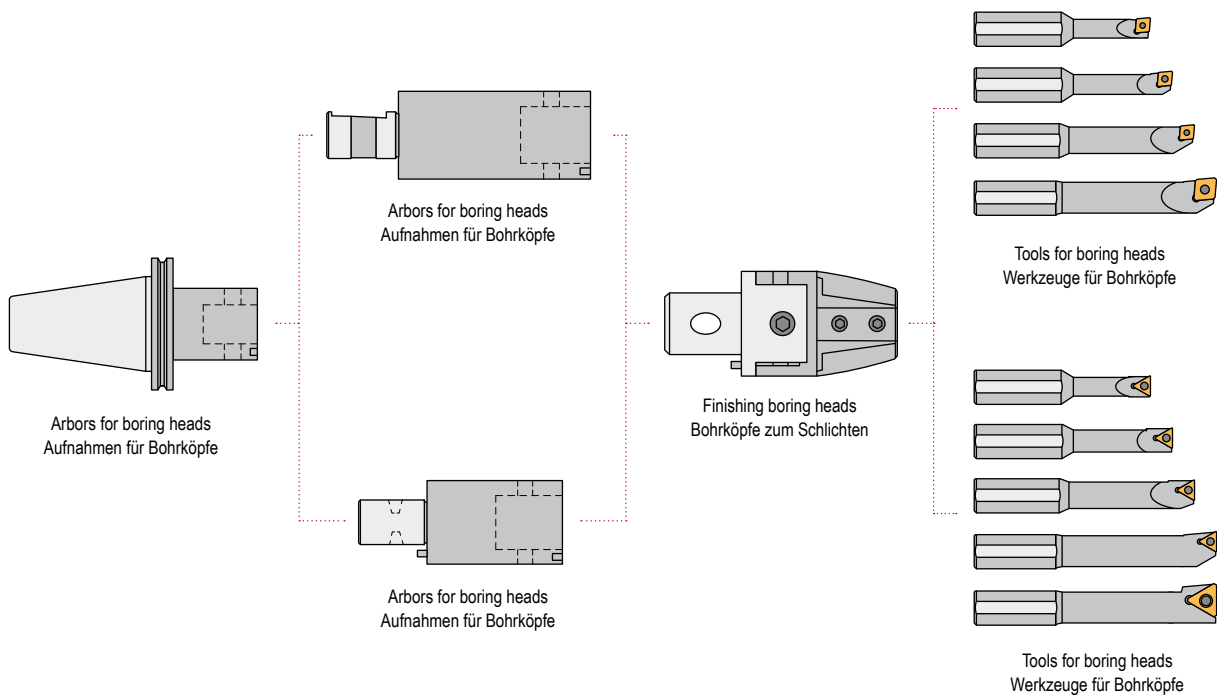
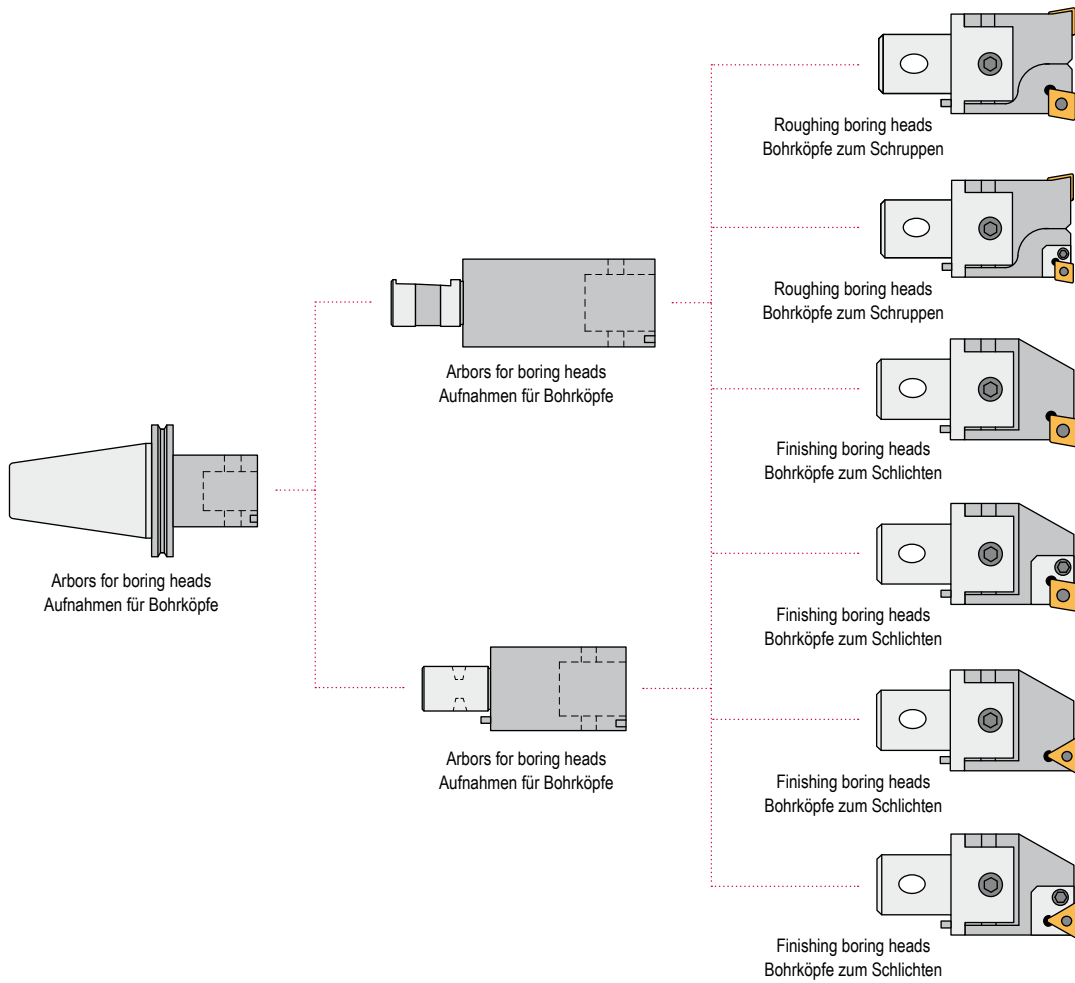

Adjustable boring bars Verstellbare Bohrstangen

6114.0⁰7

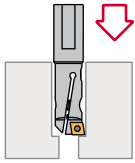

Page
Seite 1154

Boring heads Bohrköpfe

97.15/24

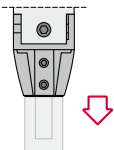

Page
Seite 1155

SCLC

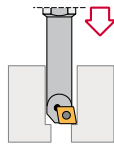

Page CC.. 0602..
Seite 1156 CC.. 09T3..

STFC

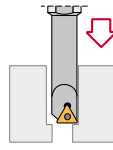

Page TC.. 0902..
Seite 1157 TC.. 16T3..

63.12/28

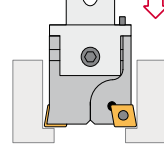

Page CC.. 0602..
Seite 1158 CC.. 1204..

63.36/60

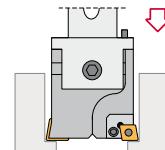

Page
Seite 1159 CC.. 1204..

64.12/28

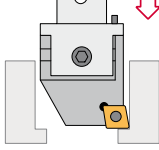

Page CC.. 0602..
Seite 1160 CC.. 1204..

64.36/60

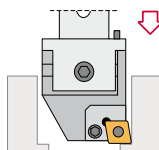

Page
Seite 1161 CC.. 1204..

66.20/28

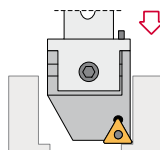

Page
Seite 1162 TC.. 16T3..

66.36/60

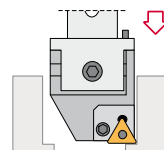

Page
Seite 1163 TC.. 16T3..

Arbors for boring heads Aufnahmen für Bohrköpfe

10.700
DIN 2080

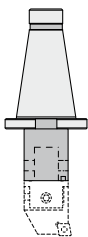

Page
Seite 1164

11.700
DIN 69871-A

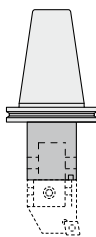

Page
Seite 1165

16.700
DIN 69893-1 / FORM A

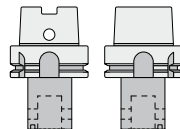

Page
Seite 1166

18.700
PSC ISO 26623-1

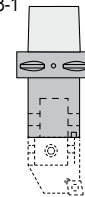

Page
Seite 1167

20.700
MAS BT

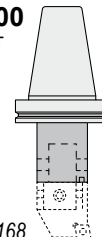

Page
Seite 1168

60.62/64

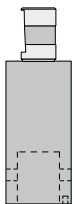

Page
Seite 1169

60.12/24

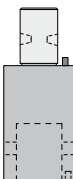

Page
Seite 1170



Characteristics:
Adjustable boring bars.

Eigenschaften:
Verstellbare Bohrstan-
gen.

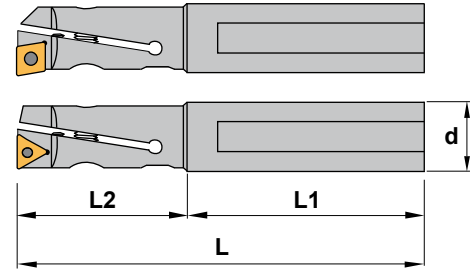
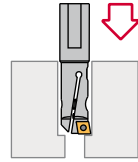

6114.0₂7

Reference Bezeichnung	L	L1	L2	d	Dmin	Dmax	Insert size Wendeschneidplatte	
6114.07.012	105	70	35	12	12	15	CC.. 0602..	0,080
6114.07.015	110	60	50	16	15	20	CC.. 0602..	0,110
6114.07.020	120	60	60	20	20	25	TC.. 1102..	0,160
6114.07.025	140	70	70	25	25	30	TC.. 16T3..	0,280
6114.07.030	160	70	90	25	30	35	TC.. 16T3..	0,360
6114.27.012	175	145	30	12	12	15	CC.. 0602..	0,150
6114.27.015	175	125	50	16	15	20	CC.. 0602..	0,260
6114.27.020	200	140	60	20	20	25	TC.. 1102..	0,430
6114.27.025	200	130	70	25	25	30	TC.. 16T3..	0,550
6114.27.030	200	110	90	25	30	35	TC.. 16T3..	0,500

Reference Bezeichnung								Nm
6114.07.012	1550	1503	1425	-	5015	5520	5507	0.9
6114.07.015	1261	1534	1425	1534	5002	5525	5507	0.9
6114.07.020	1182	1515	1225	1515	5025	5525	5507	0.9
6114.07.025	1908	1517	1240	1517	5025 / 5005	-	5515	3.0
6114.07.030	1910	1517	1240	1518	5025 / 5006	-	5515	3.0
6114.27.012	1550	1503	1425	-	5015	5520	5507	0.9
6114.27.015	1261	1534	1425	1534	5002	5525	5507	0.9
6114.27.020	1182	1515	1225	1515	5025	5525	5507	0.9
6114.27.025	1908	1517	1240	1517	5025 / 5005	-	5515	3.0
6114.27.030	1910	1517	1240	1518	5025 / 5006	-	5515	3.0

CC.. 80° Rhombische positive Wendeschneidplatten mit 7° Freiwinkel. F21

Reference / Bez.	l	s	d
CC.. 0602..	6,45	2,38	6,35

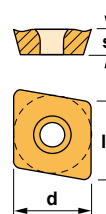

CCGT-AL



CCMT



CCMW



TC.. Dreikantige positive Wendeschneidplatten mit 7° Freiwinkel. F21

Reference / Bez.	l	s	d
TC.. 0902..	9,62	2,38	5,55
TC.. 16T3..	16,50	3,97	9,52

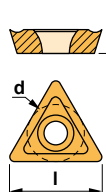

TCGT-AL



TCMT-39



TCMW





Characteristics:
Finishing boring heads.
With graduated dial.
Read-out precision 0,01 mm Ø.

Eigenschaften:
Bohrköpfe zum Schlichten.
Mit Einstellscheibe.
Ablesegenauigkeit 0,01 mm Ø.

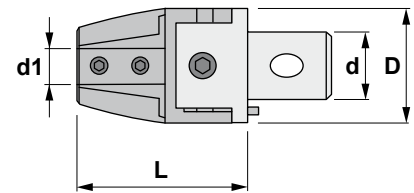

97.15/24

Reference Bezeichnung	D	L	d	d1	Dmin	Dmax	
97.15.08	27	50	15	8	10	21	0,170
97.20.08	32	58	20	8	10	21	0,280
97.20.10	32	58	20	10	13	25	0,290
97.24.10	42	70	24	10	13	29	0,650
97.24.12	42	70	24	12	16	34	0,620
97.24.16	42	70	24	16	20	38	0,600

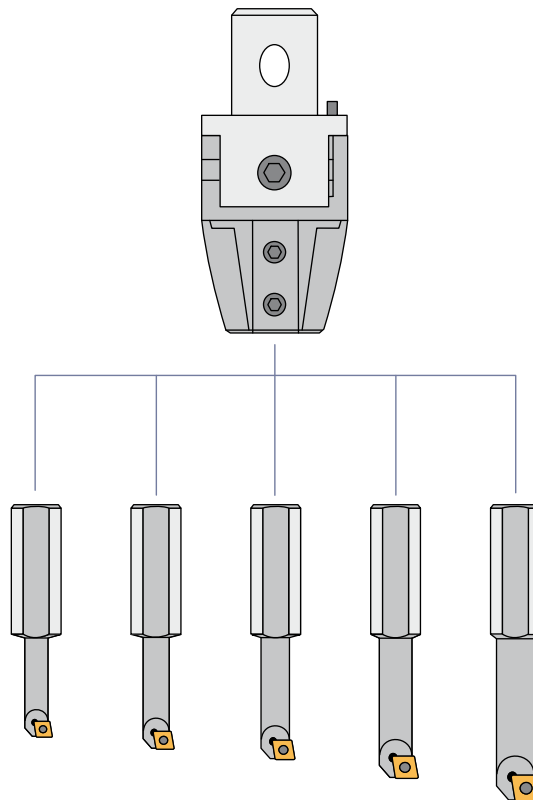

SCLC / STFC



Characteristics:

Tool for boring heads equipped with rhombic positive insert (angle 80°).

The center screw ensures good rigidity and chip flow.

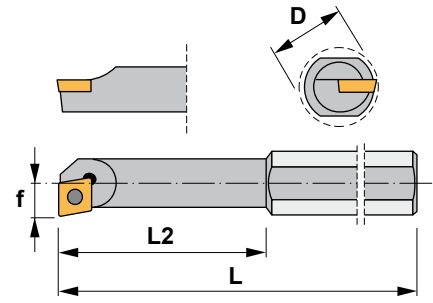

Eigenschaften:

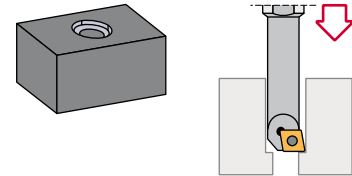

Bohrstange mit einer rhombischen positiven Wendeschneidplatte (80° Winkel).

Die zentrale Schraube garantiert eine gute Starrheit und einen guten Spanabfluß.



SCLC

Reference Bezeichnung	D	L	L2	f	Bore range Bohrungsbereich		Insert size Wendeschneidplatte	Kg
					min	max		
S0816F SCLC R 06	16	80	35	4	10	28	CC.. 0602..	0,070
S1016G SCLC R 06	16	90	45	6	13	31	CC.. 0602..	0,100
S1216H SCLC R 06	16	100	57	7	16	34	CC.. 0602..	0,100
S1616I SCLC R 09	16	110	73	9	20	38	CC.. 09T3..	0,150

Reference Bezeichnung			Nm
S0816F SCLC R 06	1425	5507	0.9
S1016G SCLC R 06	1425	5507	0.9
S1216H SCLC R 06	1425	5507	0.9
S1616I SCLC R 09	1440	5515	3.0

CC.. 80° rhombic positive inserts with 7° clearance.  F12
80° Rhombische positive Wendeschneidplatten mit 7° Freiwinkel.

Reference / Bez.	l	s	d
CC.. 0602..	6,45	2,38	6,35
CC.. 09T3..	9,65	3,97	9,52

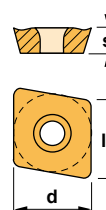

CCGT-AL



CCMT



CCMW



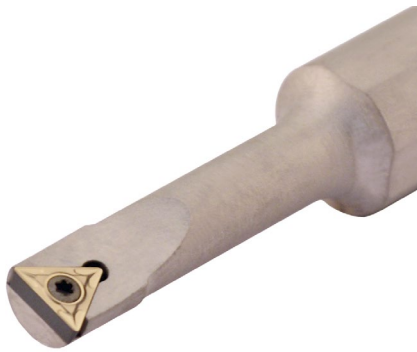

Characteristics:
Tool for boring heads equipped with triangular positive insert.
The center screw ensures good rigidity and chip flow.

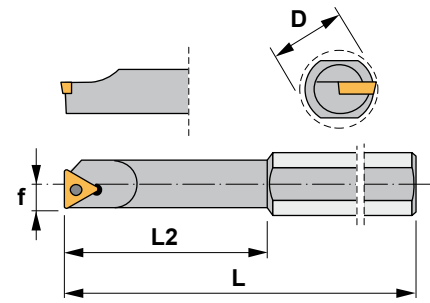

Eigenschaften:
Bohrstange für Bohrköpfe mit dreieckigen positiven Wendeschneidplatten.
Die zentrale Schraube garantiert eine gute Starrheit und einen guten Spanabfluß.

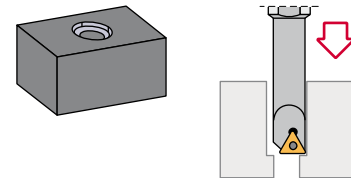

STFC

Reference Bezeichnung	D	L	L2	f	Bore range Bohrungsbereich min max		Insert size Wendeschneidplatte	kg
S0816F STFC R 09	16	80	35	5	10	28	TC.. 0902..	0,090
S1016G STFC R 09	16	90	45	6	13	31	TC.. 0902..	0,100
S1216H STFC R 09	16	100	57	7	16	34	TC.. 0902..	0,100
S1616I STFC R 09	16	110	73	9	20	38	TC.. 0902..	0,100
S1616I STFC R 16	16	110	73	11	20	38	TC.. 16T3..	0,150

Reference Bezeichnung			Nm
S0816F STFC R 09	1222	5506	0.6
S1016G STFC R 09	1222	5506	0.6
S1216H STFC R 09	1222	5506	0.6
S1616I STFC R 09	1222	5506	0.6
S1616I STFC R 16	1425	5515	3.0

TC.. <small>Triangular positive inserts with 7° clearance. Dreikantige positive Wendeschneidplatten mit 7° Freiwinkel. F21</small>					
Reference / Bez.	l	s	d		
TC.. 0902..	9,62	2,38	5,55		
TC.. 16T3..	16,50	3,97	9,52		

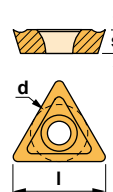

TCGT-AL

TCMT-39



TCMW





Characteristics:
Roughing boring heads.

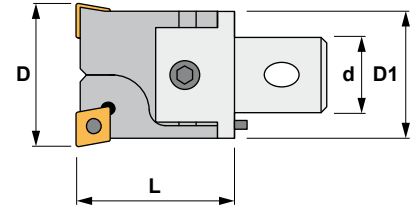

Eigenschaften:
Bohrkopf zum Schruppen.

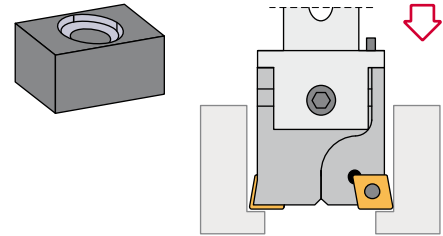

63.12/28

Reference Bezeichnung	D1	L	d	Dmin	Dmax	Insert size Wendeschneidplatte	kg
63.12.2430	22	34	12	24	30	CC.. 0602..	0,075
63.15.2940	27	42	15	29	40	CC.. 09T3..	0,150
63.20.3950	32	45	20	39	50	CC.. 09T3..	0,250
63.24.4965	42	56	24	49	65	CC.. 1204..	0,500
63.28.6382	54	56	28	63	82	CC.. 1204..	1,000

Reference Bezeichnung					Nm
63.12.2430	1425	5607	5003	5002	0.9
63.15.2940	1240	5615	5004	5002	3.0
63.20.3950	1240	5615	5004	5025	3.0
63.24.4965	1250	5620	5005	5003	4.0
63.28.6382	1250	5620	5006	5003	4.0

CC.. 80° rhombic positive inserts with 7° clearance. F12
80° Rhombische positive Wendeschneidplatten mit 7° Freiwinkel.

Reference / Bez.	l	s	d
CC.. 0602..	6,45	2,38	6,35
CC.. 09T3..	9,65	3,97	9,52
CC.. 1204..	12,90	4,76	12,70

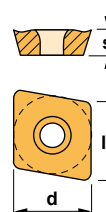

CCGT-AL



CCMT



CCMW





Characteristics:
Roughing boring heads.

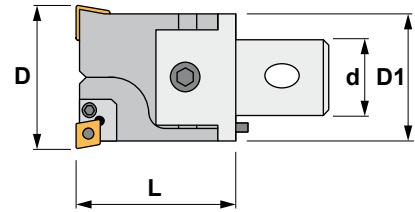

Eigenschaften:
Bohrkopf zum Schrappen.

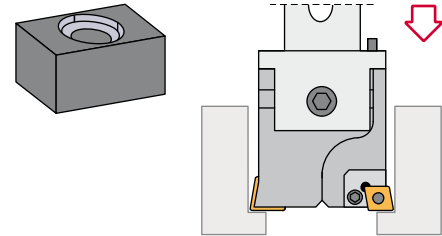

63.36/60

Reference Bezeichnung	D1	L	d	Dmin	Dmax	Insert size Wendeschneidplatte	Kg
63.36.080102	68	86	36	80	102	CC.. 1204..	2,200
63.50.100125	85	100	50	100	125	CC.. 1204..	4,000
63.60.125160	110	100	60	125	160	CC.. 1204..	6,550
63.60.160220	145	100	60	160	220	CC.. 1204..	8,700

Reference Bezeichnung						Nm
63.36.080102	1250	5620	5508	5004	6412	4.0
63.50.100125	1250	5620	5508	5005	6412	4.0
63.60.125160	1250	5620	5508	5005	6412	4.0
63.60.160220	1250	5620	5508	5005	6412	4.0

CC.. 80° rhombic positive inserts with 7° clearance. F12
80° Rhombische positive Wendeschneidplatten mit 7° Freiwinkel.

Reference / Bez.	l	s	d
CC.. 1204..	12,90	4,76	12,70

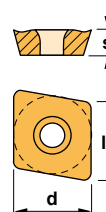

CCGT-AL



CCMT



CCMW





Characteristics:
Finishing boring heads.
With graduated dial.
Read-out precision 0,01 mm Ø.

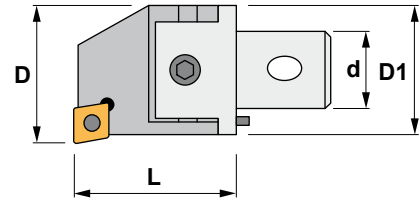

Eigenschaften:
Bohrköpfe zum Schlichten.
Mit Einstellscheibe.
Ablesegenauigkeit 0,01 mm Ø.

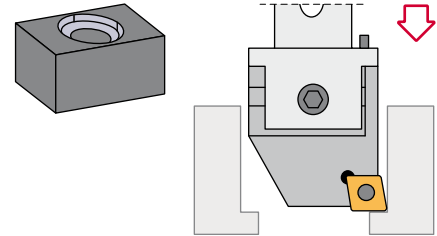

64.12/28

Reference Bezeichnung	D1	L	d	Dmin	Dmax	Insert size Wendeschneidplatte	kg
64.12.2430	22	34	12	24	30	CC.. 0602..	0,075
64.15.2940	27	42	15	29	40	CC.. 09T3..	0,150
64.20.3950	32	45	20	39	50	CC.. 09T3..	0,250
64.24.4965	42	56	24	49	65	CC.. 1204..	0,450
64.28.6382	54	56	28	63	82	CC.. 1204..	0,900

Reference Bezeichnung					Nm
64.12.2430	1425	5607	5003	5002	0.9
64.15.2940	1240	5615	5004	5002	3.0
64.20.3950	1240	5615	5004	5025	3.0
64.24.4965	1250	5620	5005	5003	4.0
64.28.6382	1250	5620	5006	5003	4.0

CC.. 80° rhombic positive inserts with 7° clearance. F12
80° Rhombische positive Wendeschneidplatten mit 7° Freiwinkel.

Reference / Bez.	l	s	d
CC.. 0602..	6,45	2,38	6,35
CC.. 09T3..	9,65	3,97	9,52
CC.. 1204..	12,90	4,76	12,70

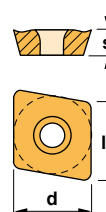

CCGT-AL



CCMT



CCMW





Characteristics:
Finishing boring heads.
With graduated dial.
Read-out precision 0,01 mm Ø.

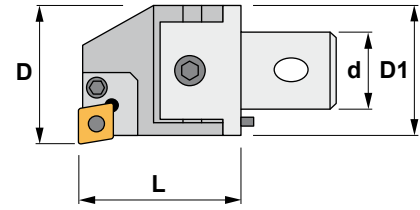

Eigenschaften:
Bohrköpfe zum Schlichten.
Mit Einstellscheibe.
Ablesegenauigkeit 0,01 mm Ø.

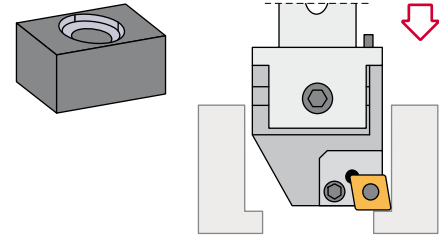

64.36/60

Reference Bezeichnung	D1	L	d	Dmin	Dmax	Insert size Wendeschneidplatte	Kg
64.36.080102	68	86	36	80	102	CC.. 1204..	2,050
64.50.100125	85	100	50	100	125	CC.. 1204..	3,700
64.60.125160	110	100	60	125	160	CC.. 1204..	6,150
64.60.160220	145	100	60	160	220	CC.. 1204..	8,050

Reference Bezeichnung						Nm
64.36.080102	1250	5620	5508	5004	6412	4.0
64.50.100125	1250	5620	5508	5005	6412	4.0
64.60.125160	1250	5620	5508	5005	6412	4.0
64.60.160220	1250	5620	5508	5005	6412	4.0

CC.. 80° rhombic positive inserts with 7° clearance. F12
80° Rhombische positive Wendeschneidplatten mit 7° Freiwinkel.

Reference / Bez.	l	s	d
CC.. 1204..	12,90	4,76	12,70

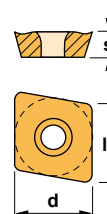

CCGT-AL



CCMT



CCMW





Characteristics:
Finishing boring heads.
With graduated dial.
Read-out precision 0,01 mm Ø.

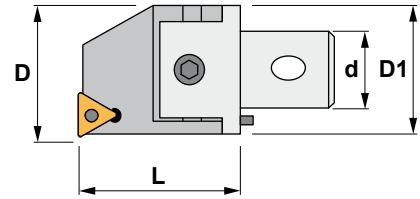

Eigenschaften:
Bohrköpfe zum Schlichten.
Mit Einstellscheibe.
Ablesegenauigkeit 0,01 mm Ø.

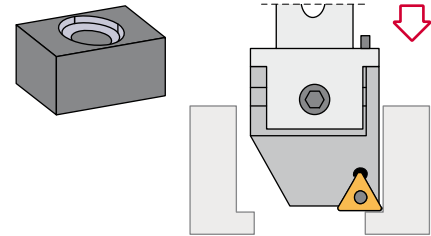

66.20/28

Reference Bezeichnung	D1	L	d	Dmin	Dmax	Insert size Wendeschneidplatte	KG
66.20.3950	32	45	20	39	50	TC.. 16T3..	0,250
66.24.4965	42	56	24	49	65	TC.. 16T3..	0,450
66.28.6382	54	66	28	63	82	TC.. 16T3..	0,900

Reference Bezeichnung					Nm
66.20.3950	1240	5615	5004	5025	3.0
66.24.4965	1240	5615	5005	5003	4.0
66.28.6382	1240	5615	5006	5003	4.0

TC.. Triangular positive inserts with 7° clearance. F21
Dreikantige positive Wendeschneidplatten mit 7° Freiwinkel.

Reference / Bez.	l	s	d
TC.. 16T3..	16,50	3,97	9,52

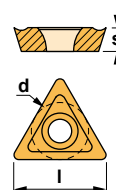

TCGT-AL



TCMT-39



TCMW

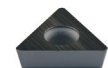



Characteristics:
Finishing boring heads.
With graduated dial.
Read-out precision 0,01 mm Ø.

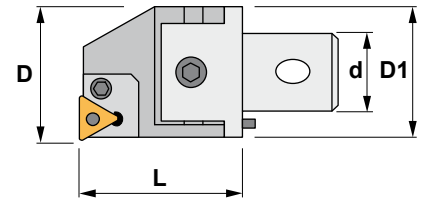

Eigenschaften:
Bohrköpfe zum Schlichten.
Mit Einstellscheibe.
Ablesegenauigkeit 0,01 mm Ø.

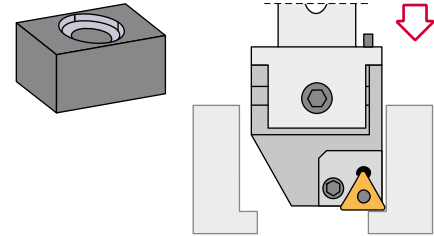

66.36/60

Reference Bezeichnung	D1	L	d	Dmin	Dmax	Insert size Wendeschneidplatte	KG
66.36.080102	68	86	36	80	102	TC.. 16T3..	2,050
66.50.100125	85	100	50	100	125	TC.. 16T3..	3,700
66.60.125160	110	100	60	125	160	TC.. 16T3..	6,150
66.60.160220	145	100	60	160	220	TC.. 16T3..	8,050

Reference Bezeichnung						Nm
66.36.080102	1240	5615	5508	5004	6416	4.0
66.50.100125	1240	5615	5508	5005	6416	4.0
66.60.125160	1240	5615	5508	5005	6416	4.0
66.60.160220	1240	5615	5508	5005	6416	4.0

TC.. <small>Triangular positive inserts with 7° clearance. Dreikantige positive Wendeschneidplatten mit 7° Freiwinkel.</small> F21					
Reference / Bez.	l	s	d	TCGT-AL	TCMT-39
TC.. 16T3..	16,50	3,97	9,52		
				TCMW	

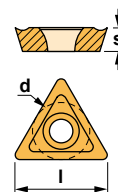



Characteristics:
Arbors for boring heads.
DIN 2080

Eigenschaften:
Aufnahmen für Bohrköpfe.
DIN 2080

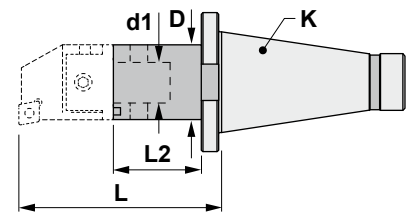

10.700

Reference Bezeichnung	K ISO	D	L	L2	d1	
10.700.30.12/100	30	22	113	79	12	0,450
10.700.30.15/100	30	27	113	100	15	0,550
10.700.30.20/100	30	32	113	68	20	0,600
10.700.40.12/100	40	22	115	81	12	0,950
10.700.40.15/100	40	27	115	73	15	1,050
10.700.40.20/100	40	32	115	70	20	1,100
10.700.40.24/160	40	42	175	119	24	1,850
10.700.40.28/160	40	54	175	109	28	2,300
10.700.40.36/160	40	68	176	90	36	2,500
10.700.50.12/100	50	22	119	85	12	2,850
10.700.50.15/100	50	27	119	77	15	2,900
10.700.50.20/130	50	32	149	104	20	3,150
10.700.50.24/160	50	42	179	123	24	3,700
10.700.50.28/160	50	54	179	113	28	4,250
10.700.50.36/200	50	68	220	134	36	5,650
10.700.50.50/200	50	85	281	181	50	6,350
10.700.50.60/260	50	100	281	181	60	11,000



Characteristics:
Arbors for boring heads.
DIN 69871-A

Eigenschaften:
Aufnahmen für Bohrköpfe.
DIN 69871-A

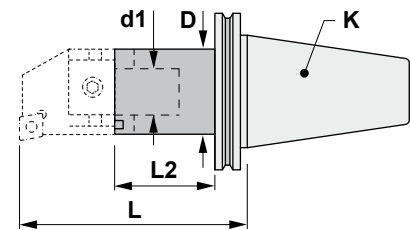

11.700

Reference Bezeichnung	K ISO	D	L	L2	d1	 Kg
11.700.40.12/100	40	22	138	104	12	1,200
11.700.40.15/100	40	27	138	96	15	1,250
11.700.40.20/100	40	32	138	93	20	1,500
11.700.40.24/160	40	42	182	126	24	1,900
11.700.40.28/160	40	54	182	116	28	2,300
11.700.40.36/160	40	68	183	97	36	2,600
11.700.50.12/100	50	22	138	104	12	3,350
11.700.50.15/100	50	27	138	96	15	3,400
11.700.50.20/130	50	32	168	123	20	3,600
11.700.50.24/160	50	42	198	142	24	4,200
11.700.50.28/160	50	54	198	132	28	4,700
11.700.50.36/200	50	68	223	137	36	5,650
11.700.50.50/200	50	85	224	124	50	6,200
11.700.50.60/260	50	100	284	184	60	10,850





Characteristics:
Arbors for boring heads.
DIN 69893-1 / Form A

Eigenschaften:
Aufnahmen für Bohrköpfe.
DIN 69893-1 / Form A

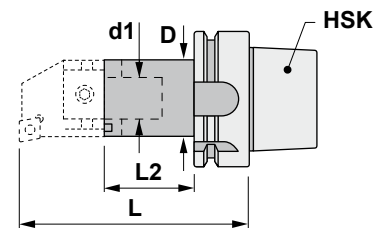
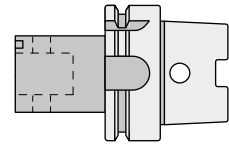

16.700

Reference Bezeichnung	HSK	D	L	L2	d1	
16.700.63.12/055	63	22	81	47	12	0,700
16.700.63.12/110	63	22	136	102	12	0,840
16.700.63.15/065	63	27	91	49	15	0,730
16.700.63.15/110	63	27	110	68	15	0,910
16.700.63.20/075	63	32	101	56	20	0,780
16.700.63.20/120	63	32	120	75	20	1,050





Characteristics:
Arbors for boring heads.
PSC ISO 26623-1

Eigenschaften:
Aufnahmen für Bohrköpfe.
PSC ISO 26623-1

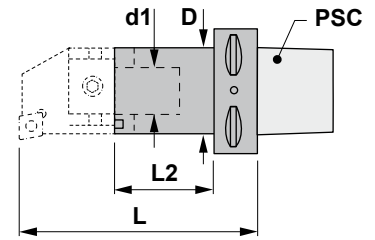

18.700

Reference Bezeichnung	PSC	D	L	L2	d1	
18.700.63.12/055	63	22	77	43	12	0,750
18.700.63.12/110	63	22	132	98	12	0,920
18.700.63.15/065	63	27	87	45	15	0,880
18.700.63.15/110	63	27	132	90	15	1,080
18.700.63.20/075	63	32	97	52	20	1,000
18.700.63.20/120	63	32	142	97	20	1,280





Characteristics:
Arbors for boring heads.
MAS BT

Eigenschaften:
Aufnahmen für Bohrköpfe.
MAS BT

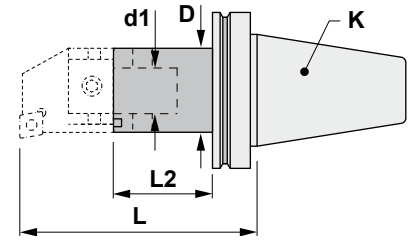

20.700

Reference Bezeichnung	K ISO	D	L	L2	d1	
20.700.40.12/100	40	22	130	96	12	1,200
20.700.40.15/100	40	27	130	88	15	1,250
20.700.40.20/100	40	32	130	100	20	1,600
20.700.40.24/160	40	42	190	134	24	2,050
20.700.40.28/160	40	54	190	124	28	2,550
20.700.40.36/160	40	68	181	95	36	2,550
20.700.50.12/100	50	22	141	107	12	3,850
20.700.50.15/100	50	27	141	99	15	3,950
20.700.50.20/130	50	32	171	126	20	4,200
20.700.50.24/160	50	42	201	145	24	5,200
20.700.50.28/160	50	54	201	135	28	5,800
20.700.50.36/200	50	68	242	156	36	6,650
20.700.50.50/200	50	85	242	142	50	7,400
20.700.50.60/260	50	100	302	202	60	12,300



Characteristics:
Extensions DIN 1835 for the
arbors for boring heads.

Eigenschaften:
Verlängerungen DIN 1835 für
die Aufnahmen für Bohrköpfe.

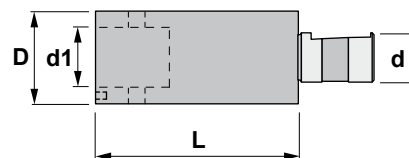

60.62/64

Reference Bezeichnung	D	d	L	d1	
60.62.12	22	20	20	12	0,050
60.62.15	27	20	30	15	0,100
60.63.12	22	20	30	12	0,120
60.63.15	27	20	45	15	0,230
60.63.20	32	25	35	20	0,320
60.64.12	22	20	52	12	0,210
60.64.15	27	20	52	15	0,290
60.64.20	32	20	52	20	0,400
60.64.24	42	25	60	24	0,500





Characteristics:
Extensions for the arbors for boring heads.

Eigenschaften:
Verlängerungen für die Aufnahmen für Bohrköpfe.

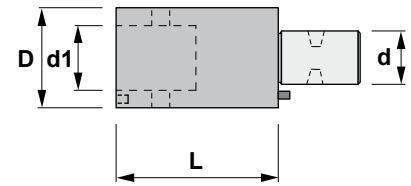

60.12/24

Reference Bezeichnung	D	d	L	d1	
60.12.12/20	22	12	20	12	0,050
60.12.12/30	22	12	30	12	0,100
60.15.15/30	27	15	30	15	0,130
60.15.15/45	27	15	45	15	0,190
60.20.20/35	32	20	35	20	0,200
60.20.20/52	32	20	52	20	0,270
60.24.24/40	42	24	40	24	0,400
60.24.24/60	42	24	60	24	0,600



Characteristics:
Set of roughing boring head and boring bars.

Eigenschaften:
Satz mit Bohrkopf und Bohrstangen zum Schruppen.

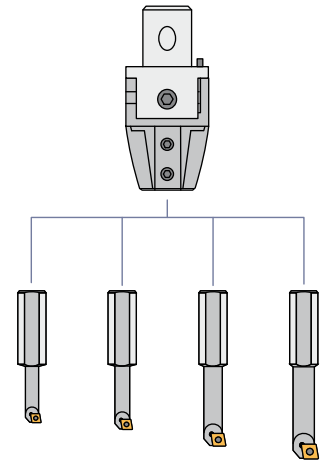

SET-97

Reference Bezeichnung	Boring head Bohrkopf	Boring bars Bohrstangen	Bore range Bohrungsbereich		kg
			min	max	
SET-97 SCLC	97.24.16	S0816F SCLC R 06	10	28	1,020
		S1016G SCLC R 06	13	31	
		S1216H SCLC R 06	16	34	
		S1616I SCLC R 09	20	38	



Characteristics:
Set of roughing boring head and boring bars.

Eigenschaften:
Satz mit Bohrkopf und Bohrstangen zum Schruppen.

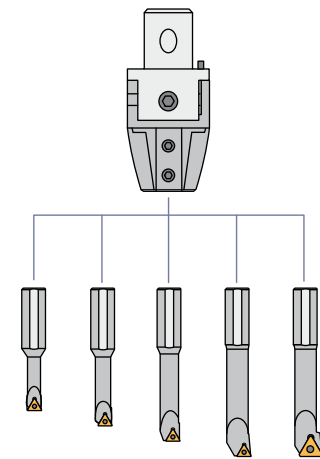

SET-97

Reference Bezeichnung	Boring head Bohrkopf	Boring bars Bohrstangen	Bore range Bohrungsbereich		kg
			min	max	
SET-97 STFC	97.24.16	S0816F STFC R09	10	28	1,140
		S1016G STFC R 09	13	31	
		S1216H STFC R 09	16	34	
		S1216I STFC R 09	20	38	
		S1616I STFC R 16	20	38	



1 TYPE / TYP

10.700



11.700



16.700



18.700



20.700



60.62/24



60.12/24



2 DIMENSION / ABMESSUNGEN

ISO

30

40

50

HSK

63

PSC

63

3 LENGTH / LÄNGE (L)

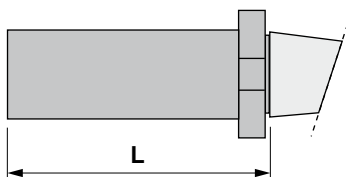

Ø DIAMETER / DURCHMESSER



COLLET
SPANNZANGEN

NOTES / BEMERKUNGEN:



CYLINDRICAL SHANKS ZYLINDRISCHE SCHÄFTE







Code system Kodifizierung	I174
Technical information Technische Auskünfte	I175
Applications index Anwendungen	I175
Cylindrical shanks Zylindrische Schäfte	I176-184

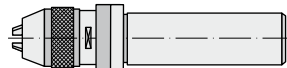

Code system / Kodifizierung

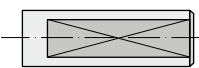
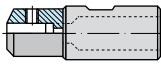
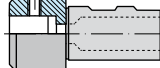
40 **315** **32** **16** - **250E**

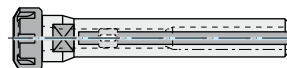
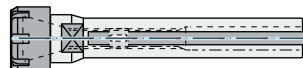
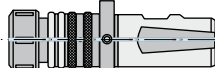
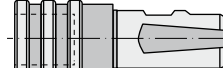
1 2 3 4 5

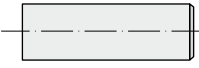
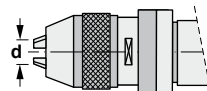
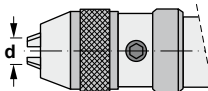
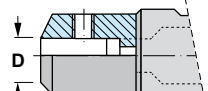
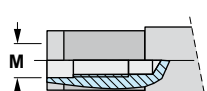
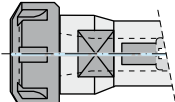
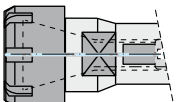
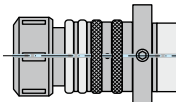
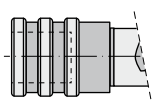
1 Shank type Schaftausführung		2 Adaptor type Aufnahmen-Typ	
Cylindric / Zylindrisch DIN 1835-A			
40		295	296
Cylindric / Zylindrisch DIN 1835-A		FORM A 	FORM B 
42 43		300	315
Cylindric / Zylindrisch DIN 1835-A			
Ø 16 Ø 20 Ø 25 Ø 32 Ø 40 Ø 50 16 20 25 32 40 50		453	455
			
		610	620
3 Shank size Schaftgröße		4 Adaptor size Adaptergröße	
			
Ø 16 Ø 20 Ø 25 Ø 32 Ø 40 Ø 50 16 20 25 32 40 50		Ø 0 - Ø 8 Ø 0 - Ø 13 Ø 3 - Ø 16 8 13 16	Ø 0 - Ø 8 Ø 1 - Ø 13 Ø 3 - Ø 16 8 13 16
			
		Ø 6 ... Ø 20 6 ... 20	Ø 6 ... Ø 20 6 ... 20
			
		ER16 ER20 ER25 ER32 ER40 16 20 25 32 40	ER16 ER25 ER40 16 25 40
			
		ER16 ER25 ER40 16 25 40	M3-M12 M8-M20 M14-M33 12 20 33
5 E = Antivibration shank (Carbide) E = Schwingungsgedämpfter Schaft (Hartmetall)			

AT3 TECHNICAL CHARACTERISTICS OF THE TOOLHOLDERS AT3 TECHNISCHE EIGENSCHAFTEN DER AUFNAHMEN

MATERIAL:

- Chromium-manganese carburized steel 1.7131 (16MnCr5).

EXECUTION:

- Carburized, hardened and tempered.
- Surface hardness HRC 58±2 (670±40 HV30)
- Depth of carburized layer minimum 0,5 mm.
- Tensile strength in core minimum 800 N/mm2 after carburizing.

ACCURACY:

- Taper according to DIN 254
- Taper angle:
tolerance AT 3 DIN 7178 part 1 and DIN 2080 part 1.
- Other tolerances according to DIN 7160 and 7168.
- Taper surface roughness RZ<0,001 mm.

TOLERANCE AT:

- Indicates the tolerance of measuring plane D between the real and the theoretical value of the taper conicity.
- This value of measuring plane D must always be less (negative), never more (positive) in order to GUARANTEE a good toolholder fixation at the bigger taper diameter.

MATERIALIEN:

- Legierter aufgekohlter Stahl mit Chrom-Mangan 1.7131 (16MnCr5).

KONSTRUKTIONS DATEN:

- Aufgekühlt, gehärtet und angelassen.
- Oberflächenhärte HRC 58±2 (670±40 HV30)
- Aufgekühlt auf minimum 0,5 mm Tiefe.
- Zugfestigkeit im Kern minimum 800 N/mm2 nach der Aufkohlung.

GENAUIGKEIT:

- Dorn nach DIN 254
- Kegelwinkel:
Toleranz AT 3 DIN 7178 Teil 1 und DIN 2080 Teil 1.
- Andere Toleranzen entsprechend DIN 7160 und 7168.
- Rauigkeit der Oberfläche RZ<0,001 mm.

TOLERANZ AT:

- Zeigt die Toleranz auf der Messebene D zwischen dem tatsächlichen Wert der Kegelkonizität und dem theoretischen Wert.
- Dieser Wert auf der Messebene D sollte immer minus (negativ) sein, nie plus (positiv), um für einen guten Halt des Futters in den größeren Durchmesser des Kegels zu GARANTIEREN.

CYLINDRICAL SHANKS ZYLINDRISCHE SCHÄFTE

DIN 1835A/B
 DIN 1835B+E

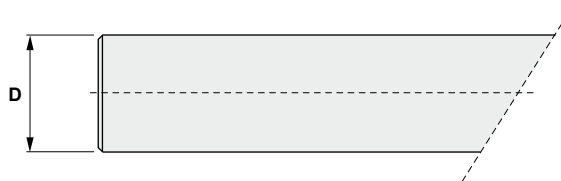

B h6

16

20

25

32

40

50

Cylindrical shanks Zylindrische Schäfte

40.295



Page
Seite 1176

43.296



Page
Seite 1177

40.315



Page
Seite 1178

40.315E

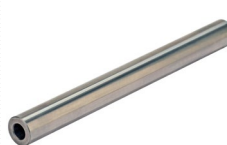

Page
Seite 1179

40.453



Page
Seite 1180

40.455



Page
Seite 1181

42.300



Page
Seite 1182

42.610



Page
Seite 1183

42.620



Page
Seite 1184



Characteristics:

Self clamping short precision drill chucks.

DIN 1835-A

For right turn only.

*** SUPPLIED WITH WRENCH**

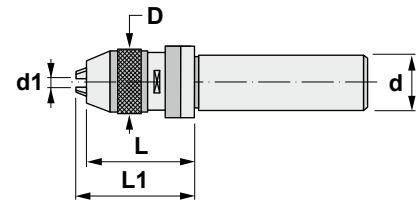

Eigenschaften:

Kurze Selbstspann-Bohrfutter,



Genauigkeit-Ausführung nach DIN 1835-A.

Nut für Rechtsumdrehung.

*** LIEFERUNG MIT SCHLÜSSEL**

40.295

Reference Bezeichnung	d	d1	D	L	L1 max	
40.295.25.08	25	0,3-8	38	66	73	0,850
40.295.30.08	30	0,3-8	38	66	73	1,300
40.295.32.08	32	0,3-8	38	66	73	1,850
40.295.32.13	32	1-13	48	80	92	2,250
40.295.40.13	40	1-13	48	80	92	2,500
40.295.40.16	40	3-16	55	84	96	3,650
40.295.50.16	50	3-16	55	84	96	3,850

Reference Bezeichnung		
40.295.25.08	50008	11206
40.295.30.08	50008	11206
40.295.32.08	50008	11206
40.295.32.13	50013	11108
40.295.40.13	50013	11108
40.295.40.16	50013	11108
40.295.50.16	50016	11108



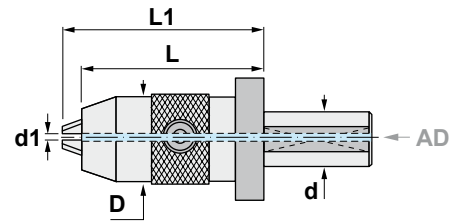

Characteristics:
CNC-Universal precision drill chucks.
DIN 1835-A
For left and right hand turn.
*** SUPPLIED WITH WRENCH**

Eigenschaften:
CNC-Universal Bohrfutter,
Genauigkeit-Ausführung nach DIN 1835-A.
Für Links- und Rechtsumdrehung.
*** LIEFERUNG MIT SCHLÜSSEL**



43.296

Reference Bezeichnung	d	d1	D	L	L1 max	
43.296.25.13	25	1-13	54	82	91	1,400
43.296.32.13	32	1-13	54	82	91	1,560
43.296.32.16	32	3-16	57	85	92	1,640

Reference Bezeichnung		
43.296.25.13	5006	60313
43.296.32.13	5006	60313
43.296.32.16	5006	60313





Characteristics:
Cylindrical modular shanks.
For modular milling heads.

Eigenschaften:
Zylindrische Modular-Schäfte.
Für Modular-Fräsköpfe.

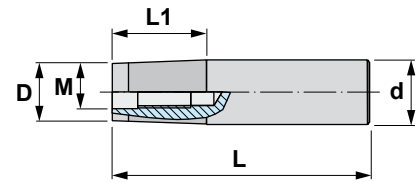

40.315

Reference Bezeichnung	d	L	M	D	L1	
40.315.20.10	20	125	M10	18	25	0,300
40.315.25.12	25	125	M12	21	40	0,450
40.315.32.16	32	150	M16	30	45	0,880





Characteristics:
Cylindrical modular shanks.
For modular milling heads.
E= Carbide
Antivibration shank

Eigenschaften:
Zylindrische Modular-Schäfte.
Für Modular-Fräsköpfe.
E= Hartmetall
Schwingungsgedämpfter Schaft

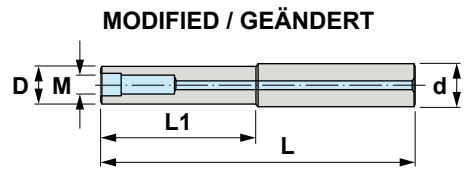
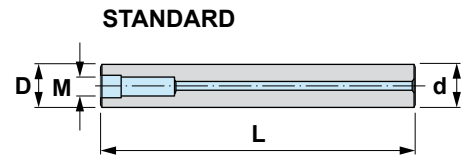

40.315E

Reference Bezeichnung	d	L	M	D	L1*	
40.315.12.06/100E	12	100	M6	12	-	0,230
40.315.16.08/100E	16	100	M8	16	-	0,405
40.315.12.06/150E	12	150	M6	12	-	0,265
40.315.16.08/150E	16	150	M8	16	-	0,470
40.315.20.10/150E	20	150	M10	20	-	0,755
40.315.25.12/150E	25	150	M12	25	-	1,105
40.315.20.10/200E	20	200	M10	20	-	1,005
40.315.25.12/200E	25	200	M12	25	-	1,460
40.315.32.16/250E	32	250	M16	32	-	1,510

* L1 (Upon request) / (Auf Anfrage)





Characteristics: Collet chucks for DIN 6499 (ER) system. DIN 1835-A
For tools with cylindrical shank.

WITH CLAMPING FLAT FOR CNC LATHES AND TURRET LATHES

*** SUPPLIED WITHOUT WRENCH**



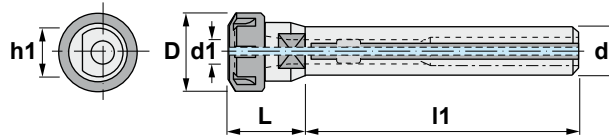

Eigenschaften: Spannzangenfutter für Spannzangen DIN 6499 (ER). DIN 1835-A
Für Werkzeuge mit Zylinderschaft.

MIT SPANNFLÄCHE FÜR CNC-DREHMASCHINEN UND REVOLVERDREHBÄNKE

*** LIEFERUNG OHNE SCHLÜSSEL**



40.453

Reference Bezeichnung	d		L	d1	l1	D	h1				
40.453.20.16/050	20	ER16	31	0,5-10	50	32	19,5	45316	50216	19210	0,150
40.453.20.16/100	20	ER16	31	0,5-10	100	32	19,5	45316	50216	19210	0,260
40.453.20.16/160	20	ER16	31	0,5-10	160	32	19,5	45316	50216	19210	0,350
40.453.20.25/050	20	ER25	46	1,0-16	50	42	19,5	45325	50225	19210	0,300
40.453.20.25/100	20	ER25	46	1,0-16	100	42	19,5	45325	50225	19210	0,380
40.453.20.25/160	20	ER25	46	1,0-16	160	42	19,5	45325	50225	19210	0,470
40.453.20.32/050	20	ER32	53	2,0-20	50	50	19,5	45332	50232	19210	0,440
40.453.20.32/100	20	ER32	53	2,0-20	100	50	19,5	45332	50232	19210	0,520
40.453.25.20/100	25	ER20	28	1,0-13	100	35	24,0	45320	50220	19212	0,390
40.453.25.25/050	25	ER25	40	1,0-16	50	42	24,0	45325	50225	19216	0,350
40.453.25.25/100	25	ER25	40	1,0-16	100	42	24,0	45325	50225	19216	0,420
40.453.25.32/050	25	ER32	53	2,0-20	50	50	24,0	45332	50232	19216	0,440
40.453.25.32/100	25	ER32	53	2,0-20	100	50	24,0	45332	50232	19216	0,540
40.453.25.40/060	25	ER40	60	3,0-30	60	63	24,0	45340	50240	19216	0,730
40.453.32.32/050	32	ER32	48	2,0-20	50	50	31,0	45332	50232	19218	0,550
40.453.32.32/100	32	ER32	48	2,0-20	100	50	31,0	45332	50232	19218	0,620
40.453.32.40/070	32	ER40	60	3,0-30	70	63	31,0	45340	50240	19218	0,860
40.453.40.32/080	40	ER32	38	2,0-20	80	50	38,0	45332	50232	19218	0,830
40.453.40.40/080	40	ER40	60	3,0-30	80	63	38,0	45340	50240	19218	1,240

ERXX

 I210-212

Ref. / Bez. Accessories / Zubehör

ERXX Collets with double slot DIN 6499 - Form B (ER)
Spannzangen mit Doppelnut DIN 6499 - Form B (ER)



ERCXX

 I215-216

Ref. / Bez. Accessories / Zubehör

ERCXX Sealed collets DIN 6499 (ER)
Abgedichtete Spannzangen DIN 6499 (ER)



ERTXX

 I217-218

Ref. / Bez. Accessories / Zubehör

ERTXX Collets DIN 6499 - Form Mexin (ER)
Spannzangen DIN 6499 - Form Mexin (ER)





Characteristics:
Long collet chucks for
DIN 6499 (ER) collets.
DIN 1835-A
For tools with cylindrical shank.

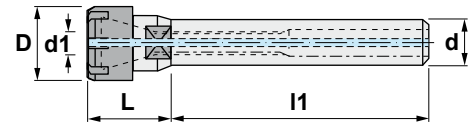





WITH "MINI" COLLET NUT
*** SUPPLIED WITHOUT WRENCH**

Eigenschaften:
Lange Spannzangenfutter für Spannzangen DIN 6499
(ER).
DIN 1835-A
Für Werkzeuge mit Zylinderschaft.

MIT SPANNMUTTER "MINI"
*** LIEFERUNG OHNE SCHLÜSSEL**

40.455

Reference Bezeichnung	d		L	d1	D	l1				
40.455.12.16/080	12	ER16	38	0,5-10	22	80	45516	50916	19106	0,100
40.455.16.16/080	16	ER16	38	0,5-10	22	80	45516	50916	19210	0,100
40.455.16.16/100	16	ER16	38	0,5-10	22	100	45516	50916	19210	0,170
40.455.16.16/160	16	ER16	38	0,5-10	22	160	45516	50916	19210	0,230
40.455.16.20/100	16	ER20	42	1,0-13	28	100	45520	50920	19210	0,190
40.455.20.16/060	20	ER16	31	0,5-10	22	60	45516	50916	19210	0,130
40.455.20.16/100	20	ER16	31	0,5-10	22	100	45516	50916	19210	0,340
40.455.20.16/160	20	ER16	31	0,5-10	22	160	45516	50916	19210	0,320
40.455.20.16/200	20	ER16	31	1,0-10	22	200	45516	50916	19210	0,650
40.455.20.20/060	20	ER20	36	1,0-13	28	60	45520	50920	19212	0,300
40.455.20.20/100	20	ER20	36	1,0-13	28	100	45520	50920	19212	0,230
40.455.20.20/160	20	ER20	36	1,0-13	28	160	45520	50920	19212	0,300
40.455.25.20/240	25	ER20	36	1,0-13	28	240	45520	50920	19216	1,040

ERXX

 I210-212

Ref. / Bez. Accessories / Zubehör

ERXX Collets with double slot DIN 6499 - Form B (ER)
Spannzangen mit Doppelnut DIN 6499 - Form B (ER)



ERCXX

 I215-216

Ref. / Bez. Accessories / Zubehör

ERCXX Sealed collets DIN 6499 (ER)
Abgedichtete Spannzangen DIN 6499 (ER)



ERTXX

 I217-218

Ref. / Bez. Accessories / Zubehör

ERTXX Collets DIN 6499 - Form Mexin (ER)
Spannzangen DIN 6499 - Form Mexin (ER)





Characteristics:

Short and long reducing bushings.

For cutters with cylindrical shank and Weldon flat DIN 1835-B.



Eigenschaften:

Kurze und lange Reduzierhülsen für Fräser mit

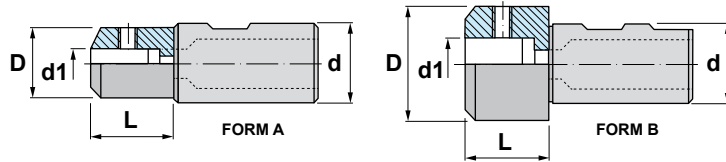
Zylinderschaft und Weldonfläche DIN 1835-B.



42.300

Reference Bezeichnung	d	d1 H5	L	D	FORM		
42.300.20.06	40	6	30	25	B	15106	0,170
42.300.20.08	40	8	30	28	B	15108	0,200
42.300.20.10	40	10	35	35	B	15110	0,330
42.300.20.12	40	12	35	42	B	15212	0,410
42.300.20.14	40	14	35	44	B	15212	0,410
42.300.20.16	40	16	60	48	B	15314	0,790
42.300.20.18	40	18	60	50	B	15314	0,800
42.300.25.06	40	6	30	25	A	15106	0,250
42.300.25.08	40	8	30	28	A	15108	0,275
42.300.25.10	40	10	35	35	B	15110	0,410
42.300.25.12	40	12	35	42	B	15212	0,460
42.300.25.14	40	14	35	44	B	15212	0,500
42.300.25.16	50	16	40	48	B	15314	0,600
42.300.32.06	50	6	30	25	A	15106	0,400
42.300.32.08	50	8	30	28	A	15108	0,460
42.300.32.10	50	10	35	35	B	15110	0,520
42.300.32.12	50	12	35	42	B	15212	0,570
42.300.32.14	50	14	35	44	B	15212	0,590
42.300.32.16	50	16	40	48	B	15314	0,700
42.300.32.18	50	18	40	50	B	15314	0,750
42.300.32.20	50	20	40	52	B	15216	0,770



Characteristics:

Tapping head with axial compensation.
DIN 1835-B
For DIN 6499 (ER) collets and with
central coolant supply.

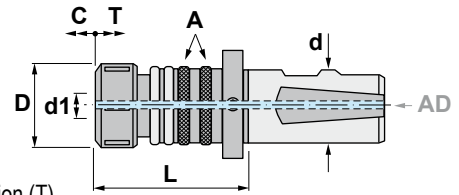

Compensation in compression (C) and tension (T).
Compression can be blocked by turning the rear ring (A).
Control of threading depth.

*** SUPPLIED WITH WRENCH**





Eigenschaften:

Gewindeschneid-Wechselfutter mit Axial-Längenausgleich DIN 1835-B.
Befestigung mit Spannzangen DIN6499 (ER) und mit Innenkühlung.

Ausgleich der Kompression (C) und der Traktion (T). Die Kompression
kann mit dem Ring (A) blockiert werden. Kontrolle der Gewindetiefe.

*** LIEFERUNG MIT SCHLÜSSEL**

42.610

Reference Bezeichnung	d			d1	L	D	C	T			
42.610.20.16	20	ER16	M3-M12	65	28	5,5	6,0	45316	50216	0,430	
42.610.25.16	25	ER16	M3-M12	67	28	5,5	6,0	45316	50216	0,440	
42.610.25.25	25	ER25	M4-M20	90	42	10,5	7,5	45325	50225	0,840	
42.610.25.40	25	ER40	M8-M33	106	63	10,0	10,0	45340	50240	1,320	
42.610.32.40	32	ER40	M8-M33	106	63	10,0	10,0	45340	50240	1,480	

ERXX

 I210-212

Ref. / Bez. Accessories / Zubehör

ERXX Collets with double slot DIN 6499 - Form B (ER)
Spannzangen mit Doppelnut DIN 6499 - Form B (ER)



ERCXX

 I215-216

Ref. / Bez. Accessories / Zubehör

ERCXX Sealed collets DIN 6499 (ER)
Abgedichtete Spannzangen DIN 6499 (ER)



ERTXX

 I217-218

Ref. / Bez. Accessories / Zubehör

ERTXX Collets DIN 6499 - Form Mexin (ER)
Spannzangen DIN 6499 - Form Mexin (ER)



40.453..

 I180

Ref. / Bez. Accessories / Zubehör

40.453.. Collet chucks for DIN 6499 (ER) collets
Spannzangenfutter für DIN 6499 (ER) Spannzangen



40.455..

 I181

Ref. / Bez. Accessories / Zubehör

40.455.. Long collet chucks for DIN 6499 (ER) collets
Lange Spannzangenfutter für DIN 6499 (ER) Spannzangen





Characteristics:

Quick change tapping head with axial compensation.
DIN 1835-B+E
With Bilz system tap chucks bushings.

Compensation in compression (C) and tension (T).

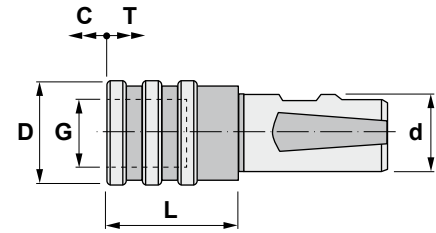

Eigenschaften:

Gewindeschneid-Schnellwechselfutter mit Axial-Längenausgleich mit Gewindebohrer-Buchsen System Bilz.
DIN 1835-B+E

Ausgleich der Kompression (C) und der Traktion (T).

42.620

Reference Bezeichnung	d	N° G Ø	d1	L	D	C	T			
42.620.20.12	20	1 19	M3-M12	41	38	9	9	710XX	750XX	0,350
42.620.20.20	20	2 31	M8-M20	63	55	15	15	720XX	760XX	0,860
42.620.25.12	25	1 19	M3-M12	41	38	9	9	710XX	750XX	0,430
42.620.25.20	25	2 31	M8-M20	63	55	15	15	720XX	760XX	0,880
42.620.32.12	32	1 19	M3-M12	41	38	9	9	710XX	750XX	0,600
42.620.32.20	32	2 31	M8-M20	63	55	15	15	720XX	760XX	1,050
42.620.32.33	32	3 48	M14-M33	97	79	24	24	730XX	770XX	2,690
42.620.40.12	40	1 19	M3-M12	41	38	9	9	710XX	750XX	0,200
42.620.40.20	40	2 31	M8-M20	63	55	15	15	720XX	760XX	1,200
42.620.40.33	40	3 48	M14-M33	97	79	24	24	730XX	770XX	1,200

710XX..730XX

I202

Ref. / Bezeichnung

Accessories / Zubehör

710XX..730XX

Quick change adapters without overload clutch
Schnellwechseleinsätze ohne Sicherheitskupplung



750XX..770XX

I203

Ref. / Bezeichnung

Accessories / Zubehör

750XX..770XX

Quick change adapters with overload clutch
Schnellwechseleinsätze mit Sicherheitskupplung





MORSE SHANKS MORSE SCHÄFTE

Code system Kodifizierung	I186
Technical information Technische Auskünfte	I187
Applications index Anwendungen	I188
Morse shanks Morse Schäfte	I189-194



Code system / Kodifizierung

30	315	03	08
1	2	3	4

1 *Machining center Modell*

Morse DIN 228

30 | 36

Morse DIN 228

37

3 *Machining center size Aufnahmengröße*

Morse shank
Morse Schäfte

DIN 228

MK2 | MK3 | MK4 | MK5
02 | 03 | 04 | 05

2 *Adaptor type Aufnahmen-Typ*

215	290	295
296	315	453

4 *Adaptor size Adaptergröße*

K ₁ - MORSE						
MK1 MK2 MK3 MK4 01 02 03 04	B12 B16 B18 12 16 18			Ø0-Ø8 Ø0-Ø13 Ø3-Ø16 8 13 16		
Ø1-Ø13 Ø3-Ø16 13 16	M M M M 08 10 12 16			ER32 ER40 32 40		

AT3 TECHNICAL CHARACTERISTICS OF THE TOOLHOLDERS AT3 TECHNISCHE EIGENSCHAFTEN DER AUFNAHMEN

MATERIAL:

- Chromium-manganese carburized steel 1.7131 (16MnCr5).

EXECUTION:

- Carburized, hardened and tempered.
- Surface hardness HRC 58±2 (670±40 HV30)
- Depth of carburized layer minimum 0,5 mm.
- Tensile strength in core minimum 800 N/mm² after carburizing.

ACCURACY:

- Taper according to DIN 254
- Taper angle:
tolerance AT 3 DIN 7178 part 1 and DIN 2080 part 1.
- Other tolerances according to DIN 7160 and 7168.
- Taper surface roughness RZ<0,001 mm.

TOLERANCE AT:

- Indicates the tolerance of measuring plane D between the real and the theoretical value of the taper conicity.
- This value of measuring plane D must always be less (negative), never more (positive) in order to GUARANTEE a good toolholder fixation at the bigger taper diameter.

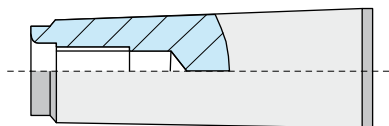

MATERIALIEN:

- Legierter aufgekohlter Stahl mit Chrom-Mangan 1.7131 (16MnCr5).

KONSTRUKTIONS DATEN:

- Aufgekohlt, gehärtet und angelassen.
- Oberflächenhärte HRC 58±2 (670±40 HV30)
- Aufgekohlt auf minimum 0,5 mm Tiefe.
- Zugfestigkeit im Kern minimum 800 N/mm² nach der Aufkohlung.

GENAUIGKEIT:

- Dorn nach DIN 254
- Kegelminkel:
Toleranz AT 3 DIN 7178 Teil 1 und DIN 2080 Teil 1.
- Andere Toleranzen entsprechend DIN 7160 und 7168.
- Rauigkeit der Oberfläche RZ<0,001 mm.

TOLERANZ AT:

- Zeigt die Toleranz auf der Messebene D zwischen dem tatsächlichen Wert der Kegelonizität und dem theoretischen Wert.
- Dieser Wert auf der Messebene D sollte immer minus (negativ) sein, nie plus (positiv), um für einen guten Halt des Futter in den größeren Durchmesser des Kegels zu GARANTIEREN.

MORSE SHANKS MORSE SCHÄPFTE DIN 228A/B

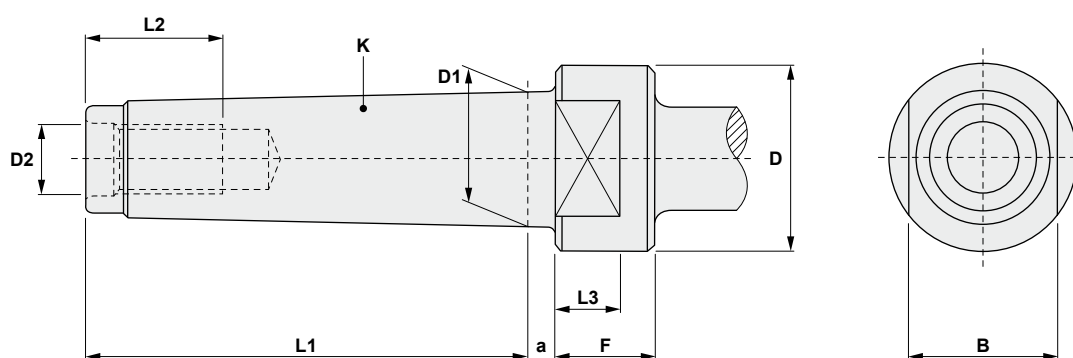

MORSE	L1	L2	L3	D	D1	D2	F min	B d9	a
1	53,5	16	-	-	12,065	M 6	-	-	3,5
2	64,0	24	-	-	17,780	M 10	-	-	5,0
3	81,0	24	12	36	23,825	M 12	18	24	5,0
4	102,5	32	15	43	31,267	M 16	23	32	6,5
5	129,5	40	18	60	44,399	M 20	28	45	6,5
6	182,0	47	25	84	63,348	M 24	39	65	8,0

Morse shanks
Morse Schäfte

30.315



Page
Seite 1189

36.453



Page
Seite 1190

37.215



Page
Seite 1191

37.290



Page
Seite 1192

37.295



Page
Seite 1193

37.296



Page
Seite 1194





Characteristics:
Morse modular shanks.
For modular milling heads.

Eigenschaften:
Morse Modular-Schäfte.
Für Modular-Fräsköpfe.

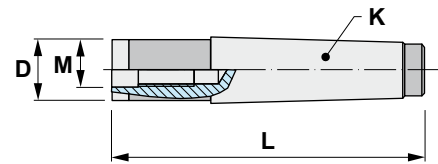

30.315

Reference Bezeichnung	K MORSE	L	M	D	 Kg
30.315.03.08	3	125	M8	14	0,290
30.315.03.10	3	125	M10	18	0,300
30.315.03.12	3	125	M12	21	0,305
30.315.04.16	4	154	M16	29	0,670





Characteristics:
Threaded Morse taper chuck
for ER collets DIN 6499/B



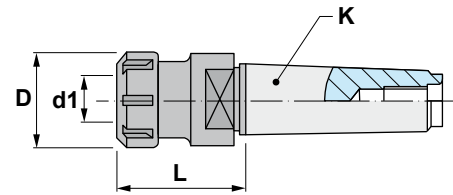

*** SUPPLIED WITHOUT WRENCH**

Eigenschaften:
Spannzangenaufnahme mit
Morsekegel und Anzugsgewinde
für "ER" Spannzangen nach
DIN6499/B

*** LIEFERUNG OHNE SCHLÜSSEL**



36.453

Reference Bezeichnung	K MORSE		L	d1	D				
36.453.03.32	3	ER32	70	2-20	50	45332	50232	19218	0,600
36.453.03.40	3	ER40	80	4-30	63	45340	50240	19224	0,950
36.453.04.32	4	ER32	60	2-20	50	45332	50232	19218	0,700
36.453.04.40	4	ER40	81	4-30	63	45340	50240	19224	1,200

ERXX

 I210-212

Ref. / Bez. Accessories / Zubehör

ERXX Collets with double slot DIN 6499 - Form B (ER)
Spannzangen mit Doppelnut DIN 6499 - Form B (ER)



ERCXX

 I215-216

Ref. / Bez. Accessories / Zubehör

ERCXX Sealed collets DIN 6499 (ER)
Abgedichtete Spannzangen DIN 6499 (ER)





Characteristics:
Precision drill chuck arbors.
DIN 2185

Eigenschaften:
Kegel-Aufsteckdorne für
Bohrfutteraufnahmen.
DIN 2185

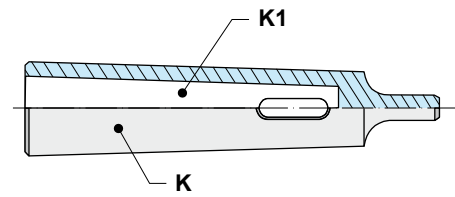

37.215

Reference Bezeichnung	K MORSE	K1 MORSE	
37.215.02.01	2	1	0,230
37.215.03.01	3	1	0,200
37.215.03.02	3	2	0,170
37.215.04.02	4	2	0,450
37.215.04.03	4	3	0,380
37.215.05.03	5	3	1,170
37.215.05.04	5	4	1,030



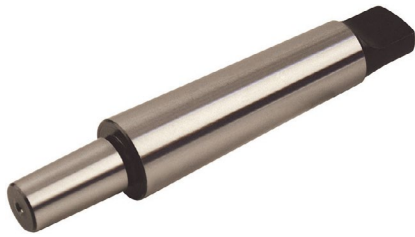

Characteristics:
Drill sleeves.
DIN 238

Eigenschaften:
Reduzierhülsen.
DIN 238

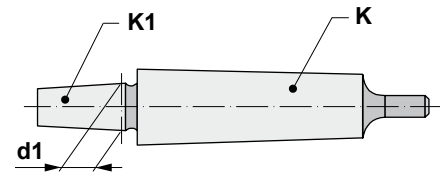

37.290

Reference Bezeichnung	K MORSE	K1 DIN	d1	
37.290.02.12	2	B-12	12,065	0,100
37.290.02.16	2	B-16	15,733	0,160
37.290.02.18	2	B-18	17,780	0,200
37.290.03.12	3	B-12	12,065	0,150
37.290.03.16	3	B-16	15,733	0,320
37.290.03.18	3	B-18	17,780	0,400
37.290.04.16	4	B-16	15,733	0,630
37.290.04.18	4	B-18	17,780	0,660

MU

 I199

Ref. / Bez. Accessories / Zubehör

MU Standard keyless drill chucks DIN 238
Standard Schnellspann-Bohrfutter DIN 238



MP

 I200

Ref. / Bez. Accessories / Zubehör

MP Super precision keyless drill chucks DIN 238
Höchst-Genauigkeit-Selbstspannbohrfutter DIN 238



MK

 I201

Ref. / Bez. Accessories / Zubehör

MK Super precision keyless drill chucks DIN 238 with gripping tongue
Höchst-Genauigkeit-Selbstspannbohrfutter DIN 238 mit Schlüsselflächen





Characteristics:
Self clamping short precision drill
chucks.
For right turn only.

*** SUPPLIED WITH WRENCH**

Eigenschaften:
Kurze Selbstspann-Bohrfutter,
Genauigkeits-Ausführung.
Nut für Rechtsumdrehung.

*** LIEFERUNG MIT SCHLÜSSEL**

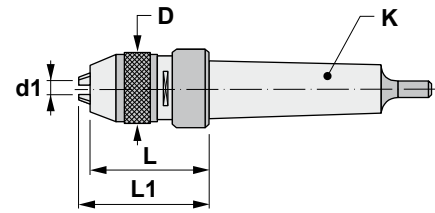

37.295

Reference Bezeichnung	K MORSE	d1	D	L	L1 max	
37.295.02.08	2	0 - 8	35	56	65	0,800
37.295.02.13	2	0-13	51	81	95	1,060
37.295.03.13	3	0-13	51	81	95	1,320
37.295.03.16	3	3-16	56	85	98	1,720
37.295.04.13	4	0-13	51	81	95	1,880
37.295.04.16	4	3-16	56	85	98	1,980

Reference Bezeichnung	
37.295.02.08	50008
37.295.02.13	50013
37.295.03.13	50013
37.295.03.16	50016
37.295.04.13	50013
37.295.04.16	50016





Characteristics:
CNC-Universal precision drill chucks.
For left and right hand turn.

As the Morse shank is part of the drill chuck, it can solve the coupling problems of any other system.

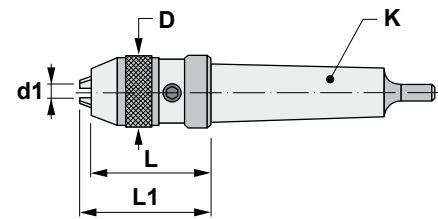

*** SUPPLIED WITH WRENCH**



Eigenschaften:
CNC-Universal Bohrfutter, Genauigkeits-Ausführung.
Für Links- und Rechtsumdrehung.

Da der Morse-Schaft ein Teil des Bohrfutters ist, löst er die Kupplungsprobleme von anderen Systemen.

*** LIEFERUNG MIT SCHLÜSSEL**

37.296

Reference Bezeichnung	K MORSE	d1	D	L	L1 max	
37.296.02.13	2	1-13	54	85	94	1,320
37.296.03.13	3	1-13	54	85	94	1,480
37.296.03.16	3	3-16	57	88	95	1,550
37.296.04.13	4	1-13	54	85	94	1,800
37.296.04.16	4	3-16	57	88	95	1,880

Reference Bezeichnung		3x 
37.296.02.13	5006	60313
37.296.03.13	5006	60313
37.296.03.16	5006	60313
37.296.04.13	5006	60313
37.296.04.16	5006	60313



ACCESSORIES ZUBEHÖR

Applications index Anwendungen	I196-197
Revolving lathe centres Zentrierspitze	I198
Drill chucks Bohrfutter	I199-201
Quick change adapters Wechseleinsätze für Gewindebohrer	I202-203
Selection table of tap adapters Auswahltable von Wechseleinsätzen für Gewindebohrer	I204-205
Collets Spannzangen	I206-218
Wrenches Schlüssel	I219
Nuts for collet chucks Spannmutter für Spannzangen	I220-222
Pull studs Anzugsbolzen	I223-227
Assembly fixtures Montagevorrichtungen	I228



**Revolving lathe centres
Zentrierspitze**

RC



Page / Seite I198

RN



Page / Seite I198

**Quick change adapters
Wechseleinsätze für Gewindebohrer**

7¹/₂0XX
3



Page / Seite I202

7⁵/₆0XX
7



Page / Seite I203

**Drill chucks
Bohrfutter**

MU



Page / Seite I199

MP



Page / Seite I200

MK



Page / Seite I201

**Collets
Spannzangen**

BXX



Page / Seite I206-208

ERXX



Page / Seite I210-212

SET-ER



Page / Seite I213

ERBXX



Page / Seite I214

ERCXX



Page / Seite I215-216

ERTXX



Page / Seite I217-218

**Wrenches
Schlüssel**

50XX



Page / Seite I219

50XX



Page / Seite I219

50XX



Page / Seite I219

50XX















Page / Seite I219



Nuts for collet chucks
Spannmutter für Spannzangen

<p>433XX</p>  <p>Page / Seite I220</p>	<p>431XX</p>  <p>Page / Seite I220</p>	<p>453XX</p>  <p>Page / Seite I221</p>	<p>451XX</p>  <p>Page / Seite I221</p>	<p>455XX</p>  <p>Page / Seite I222</p>
<p>456XX</p>  <p>Page / Seite I222</p>	<p>457XX</p>  <p>Page / Seite I222</p>			

Pull studs
Anzugsbolzen

<p>91.. DIN 69872-A</p>  <p>Page / Seite I223</p>	<p>91.. DIN 69872-B</p>  <p>Page / Seite I223</p>	<p>91.. DIN 69872-B</p>  <p>Page / Seite I223</p>	<p>91.. ISO 7388/2-B</p>  <p>Page / Seite I224</p>	<p>91.. ISO 7388/2-B</p>  <p>Page / Seite I224</p>
<p>91.. ISO 7388/2-A</p>  <p>Page / Seite I224</p>	<p>91.. ISO 7388/2-A</p>  <p>Page / Seite I225</p>	<p>91.. MAHO-OTT / DIN 69871, BT</p>  <p>Page / Seite I225</p>		
<p>92.. BT-TYPE / TYP I</p>  <p>Page / Seite I226</p>	<p>92.. BT-TYPE / TYP II</p>  <p>Page / Seite I226</p>	<p>92.. BT-TYPE / TYP III</p>  <p>Page / Seite I226</p>		<p>9... SPECIAL / SONDER</p>  <p>Page / Seite I227</p>

Assembly fixtures
Montagevorrichtungen

<p>02_70/80</p>  <p>Page / Seite I228</p>	<p>02_71/81</p>  <p>Page / Seite I228</p>			
---	---	--	--	--





Characteristics:

All-round revolving lathe centre with extended centerpoint. It enlarges the work area between centerpoint and workpiece and improves the workpiece accessibility.

Eigenschaften:

Mitlaufende Allround-Zentrierspitze mit verlängerter Laufspitze. Sie vergrößert den Arbeitsraum zwischen Spitze und Werkstück und verbessert die Werkstückzugänglichkeit.

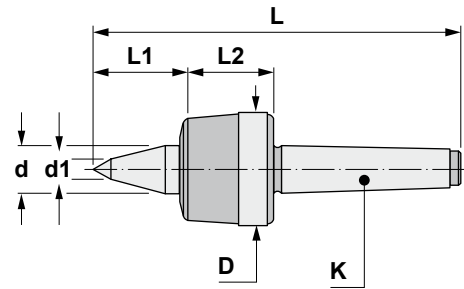

RC

Reference Bezeichnung	K	D	d	d1	L1	L2	L	⚖️
R-300-C	MK3	49	22	10	38	47	174	0,900
R-400-C	MK4	63	30	11	46	52	207	1,950
R-500-C	MK5	85	35	18	64	64	266	4,000



Characteristics:

All-round revolving lathe centre, standard design. An economic solution for almost every standard workholding situation.

Eigenschaften:

Mitlaufende Allround-Zentrierspitze, Standard-Ausführung. Eine wirtschaftliche Lösung für nahezu jede Standard-Spannsituation.

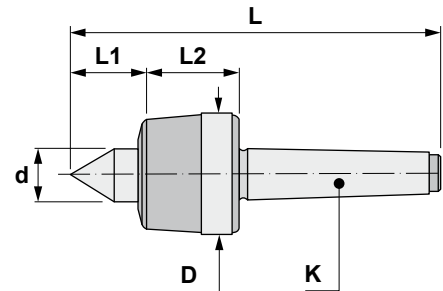

RN

Reference Bezeichnung	K	D	d	L1	L2	L	⚖️
R-200-N	MK2	42	18	24	39	137	0,500
R-300-N	MK3	49	22	29	47	163	0,850
R-400-N	MK4	63	30	35	52	196	1,900
R-500-N	MK5	85	35	48	64	250	3,950



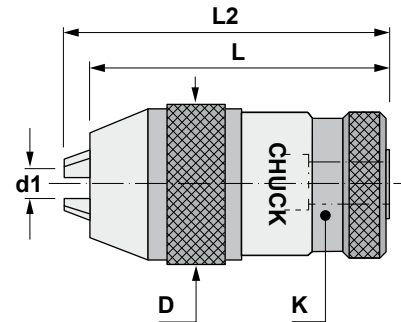

Characteristics:
Keyless drill chucks, standard class.
DIN 238

Eigenschaften:
Selbstspann-Bohrfutter, Standard-Ausführung.
DIN 238



MU

Reference Bezeichnung	K DIN 238	d1	D	L	L2	
MU08B12	B-12	0,8-8	37	72	78	0,340
MU10B12	B-12	0,8-10	40	79	86	0,610
MU13B16	B-16	1-13	47	93	103	0,940
MU16B16	B-16	3-16	52	95	105	1,150
MU16B18	B-18	3-16	52	95	105	1,140
MU20B18	B-18	5-20	64	121	131	2,250

Reference Bezeichnung	3x 
MU08B12	60328
MU10B12	60330
MU13B16	60333
MU16B16	60336
MU16B18	60336
MU20B18	60336





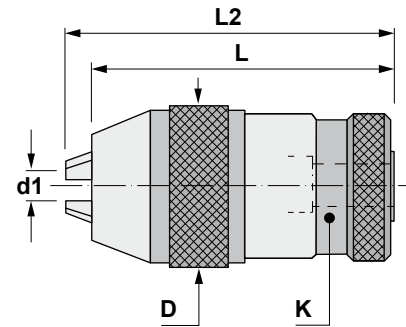

Characteristics:
Super precision keyless drill chucks.
DIN 238

Eigenschaften:
Höchst-Genauigkeit-Selbstspannbohrfutter.
DIN 238



MP

Reference Bezeichnung	K DIN 238	d1	D	L	L2	
MP08B12	B-12	0,3-8	38	67	74	0,500
MP10B12	B-12	0,5-10	43	81	89	0,720
MP10B16	B-16	0,5-10	43	81	89	0,740
MP13B16	B-16	1-13	49	91	103	0,990
MP16B16	B-16	3-16	55	95	107	1,320
MP16B18	B-18	3-16	55	95	107	1,270

Reference Bezeichnung	3x 
MP08B12	60308
MP10B12	60310
MP10B16	60310
MP13B16	60313
MP16B16	60313
MP16B18	60313



Characteristics:

Super precision keyless drill chucks, with supplementary gripping tongue.
DIN 238

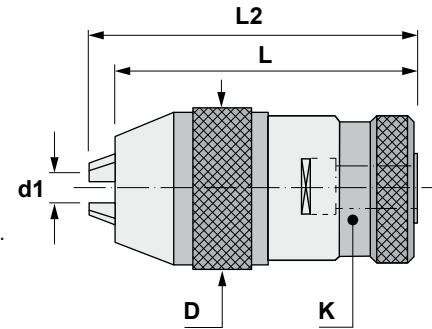

Eigenschaften:

Höchst-Genauigkeit-Selbstspannbohrfutter mit Schlüssel­flächen zur Spannkrafterhöhung.
DIN 238



MK

Reference Bezeichnung	K DIN 238	d1	D	L	L2	
MK08B12	B-12	0,3-8	38	67	74	0,480
MK10B12	B-12	0,5-10	43	81	89	0,940
MK10B16	B-16	0,5-10	43	81	89	0,940
MK13B16	B-16	1-13	49	91	103	1,150
MK16B16	B-16	3-16	55	95	107	1,540
MK16B18	B-18	3-16	55	95	107	1,260

Reference Bezeichnung		3x 
MK08B12	50008	60308
MK10B12	50010	60310
MK10B16	50010	60310
MK13B16	50013	60313
MK16B16	50016	60313
MK16B18	50016	60313





Characteristics:

Quick change adapter without overload clutch.
BILZ system.

Eigenschaften:

Wechseleinsatz für Gewindebohrer ohne
Sicherheitskupplung.
BILZ System.

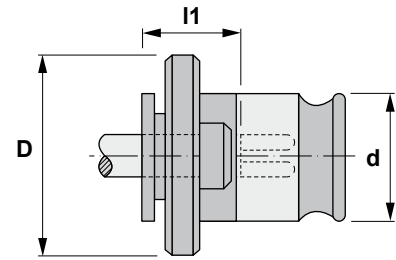

7¹/₂0XX

Reference Bezeichnung	DIN d1 x a	d	D	l1
71002	2,8 x 2,1	19	30	11
71003	3,5 x 2,7	19	30	11
71004	4,0 x 3,0	19	30	11
71005	4,5 x 3,4	19	30	11
71006	5,5 x 4,3	19	30	11
71007	6,0 x 4,9	19	30	11
71008	7,0 x 5,5	19	30	11
71009	8,0 x 6,2	19	30	11
71010	9,0 x 7,0	19	30	11
71011	10,0 x 8,0	19	30	11
71012	11,0 x 9,0	19	30	11
71013	12,0 x 9,0	19	30	11
72007	6,0 x 4,9	31	48	11
72008	7,0 x 5,5	31	48	11
72009	8,0 x 6,2	31	48	11
72010	9,0 x 7,0	31	48	11
72011	10,0 x 8,0	31	48	11
72012	11,0 x 9,0	31	48	11
72013	12,0 x 9,0	31	48	11
72014	14,0 x 11,0	31	48	11
72015	16,0 x 12,0	31	48	11
72016	18,0 x 14,5	31	48	11
72017	20,0 x 16,0	31	48	11
72018	22,0 x 18,0	31	48	11
73012	11,0 x 9,0	48	70	14
73013	12,0 x 9,0	48	70	14
73014	14,0 x 11,0	48	70	14
73015	16,0 x 12,0	48	70	14
73016	18,0 x 14,5	48	70	14
73017	20,0 x 16,0	48	70	14
73018	22,0 x 18,0	48	70	14
73019	25,0 x 20,0	48	70	14
73020	28,0 x 22,0	48	70	14
73021	32,0 x 24,0	48	70	14
73022	36,0 x 29,0	48	70	14



Characteristics:

Quick change adapter with overload clutch.
BILZ system.

Eigenschaften:

Wechseleinsatz für Gewindebohrer mit
Sicherheitskupplung.
BILZ System.

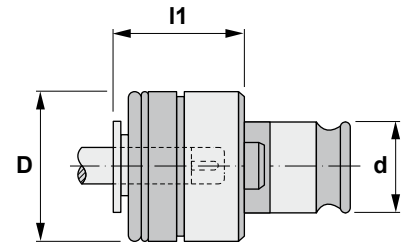

760XX

Reference Bezeichnung	DIN d1 x a	d	D	l1
75002	2,8 x 2,1	19	32	25
75003	3,5 x 2,7	19	32	25
75004	4,0 x 3,0	19	32	25
75005	4,5 x 3,4	19	32	25
75006	5,5 x 4,3	19	32	25
75007	6,0 x 4,9	19	32	25
75008	7,0 x 5,5	19	32	25
75009	8,0 x 6,2	19	32	25
75010	9,0 x 7,0	19	32	25
75011	10,0 x 8,0	19	32	25
75012	11,0 x 9,0	19	32	25
75013	12,0 x 9,0	19	32	25
76007	6,0 x 4,9	31	50	34
76008	7,0 x 5,5	31	50	34
76009	8,0 x 6,2	31	50	34
76010	9,0 x 7,0	31	50	34
76011	10,0 x 8,0	31	50	34
76012	11,0 x 9,0	31	50	34
76013	12,0 x 9,0	31	50	34
76014	14,0 x 11,0	31	50	34
76015	16,0 x 12,0	31	50	34
76016	18,0 x 14,5	31	50	34
76017	20,0 x 16,0	31	50	34
76018	22,0 x 18,0	31	50	34
77010	9,0 x 7,0	48	72	45
77012	11,0 x 7,0	48	72	45
77013	12,0 x 9,0	48	72	45
77014	14,0 x 11,0	48	72	45
77015	16,0 x 12,0	48	72	45
77016	18,0 x 14,5	48	72	45
77017	20,0 x 16,0	48	72	45
77018	22,0 x 18,0	48	72	45
77019	25,0 x 20,0	48	72	45
77020	28,0 x 22,0	48	72	45
77021	32,0 x 24,0	48	72	45
77022	36,0 x 29,0	48	72	45



Selection table of tap adapters
Auswahltabelle von Wechseleinsätzen für Gewindebohrer

"XX"	Ø x □	DIN 352	DIN 5156/ 5157	DIN 371	DIN 374	DIN 376	DIN 371	DIN 374/ 376
01	2,5 x 2,1	M 1/1,8		M 1/1,8	M 3,5	M 3,5	1/16"	
							Nr. 0/1	
02	2,8 x 2,1	M 2		M 2	M 4	M 4	3/32"	
		M 2,2		M 2,2			Nr. 2	
		M 2,5		M 2,5			Nr. 3	
03	3,5 x 2,7	M 3		M 3	M 5	M 5	1/8"	
							Nr. 4	
							Nr. 5	
04	4 x 3	M 3,5		M 3,5	M 5,5	M 5,5	Nr. 6	
05	4,5 x 3,4	M 4		M 4	M 6	M 6	5/32"	
							Nr. 8	
06	5,5 x 4,3				M 7	M 7		
07	6 x 4,9	M 4,5	G 1/16"	M 4,5	M 8	M 8	Nr. 10/12	
		M 5		M 5			3/16"	1/4"
		M 6		M 6			7/32"	5/16"
		M 7						
		M 8						
08	7 x 5,5	M 10	G 1/8"	M 7	M 10	M 10	1/4"	3/8"
09	8 x 6,2	M 11		M 8	M 11	M 11	5/16"	7/16"
10	9 x 7	M 12		M 9	M 12	M 12	3/8"	1/2"
11	10 x 8			M 10				
12	11 x 9	M 14	G 1/4"		M 14	M 14	9/16"	
13	12 x 9	M 16	G 3/8"		M 16	M 16	5/8"	
14	14 x 11	M 18			M 18	M 18	11/16"	
								3/4"
15	16 x 12	M 20	G 1/2"		M 20	M 20	13/16"	
16	18 x 14,5	M 22	G 5/8"		M 22	M 22	7/8"	
		M 24			M 24	M 24	15/16"	
17	20 x 16	M 27	G 3/4"		M 27	M 27	1"	
18	22 x 18	M 30	G 7/8"		M 30	M 30	1.1/8"	
19	25 x 20	M 33	G 1"		M 33	M 33	1.1/4"	
20	28 x 22	M 36	G 1.1/8"		M 36	M 36	1.3/8"	
21	32 x 24	M 39	G 1.1/4"		M 39	M 39	1.1/2"	
		M 42			M 42	M 42	1.5/8"	
22	36 x 29	M 45	G 1.3/8"		M 45	M 45	1.3/4"	
		M 48	G 1.1/2"		M 48	M 48		1.7/8"



A = REDUCED SHANK / B = REINFORCED SHANK
A = REDUZIERTER AUFNAHME / B = VERSTÄRKTE AUFNAHME

"XX"	Ø X □	M - MF		UNC - UNF		BSW - BSF		BA
		A	B	A	B	A	B	A
30	2,24 x 1,8	M 3		Nr. 5		1/8		
31	2,5 x 2	M 3,5	M 1,0/2	Nr. 6	Nr. 0			Nr. 11
					Nr. 1			Nr. 10
								Nr. 9
32	2,8 x 2,24		M 2,2		Nr. 2			Nr. 8
			M 2,5		Nr. 3			Nr. 7
								Nr. 6
33	3,15 x 2,5	M 4	M 3		Nr. 4		1/8	Nr. 5
				Nr. 8	Nr. 5			
34	3,55 x 2,8	M 4,5	M 3,5	Nr. 10	Nr. 6	3/16		Nr. 4
35	4 x 3,15	M 5	M 4	Nr. 12		7/32		
36	4,5 x 3,55	M 6	M 4,5	1/4	Nr. 8	1/4		Nr. 3
37	5 x 4		M 5		Nr. 10		3/16	Nr. 2
38	5,6 x 4,5	M 7			Nr. 12	9/32	7/32	Nr. 1
39	6,3 x 5	M 8	M 6	5/16	1/4	5/16	1/4	Nr. 0
40	7,1 x 5,6	M 9	M 7	3/8		3/8	9/32	
41	8 x 6,3	M 10	M 8	7/16	5/16	7/16	5/16	
42	9 x 7,1	M 12	M 9	1/2		1/2		
11	10 x 8		M 10		3/8		3/8	
43	11,2 x 9	M 14		9/16		9/16		
44	12,5 x 10	M 16		5/8		5/8		
45	14 x 11,2	M 18				11/16		
		M 20		3/4		3/4		
46	16 x 12,5	M 22		7/8		7/8		
47	18 x 14	M 24		1		1		
17	20 x 16	M 27		1.1/8		1.1/8		
		M 30						
48	22,4 x 18	M 33		1.1/4		1.1/4		
19	25 x 20	M 36		1.3/8		1.3/8		
49	28 x 22,4	M 39		1.1/2		1.1/2		
		M 42				1.5/8		
50	31,5 x 25	M 45		1.3/4		1.3/4		
		M 48						
51	35,45 x 28	M 52		2		2		





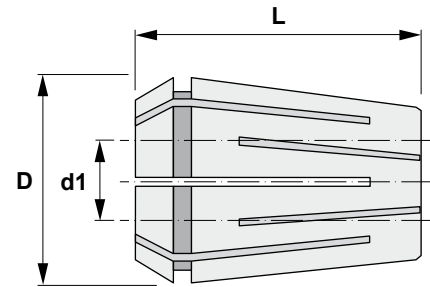

Characteristics:
Collets with double slot DIN 6388 - Form B.
For tools with cylindrical shank
DIN 1835 - A.

Eigenschaften:
Spannzangen mit Doppelnut DIN 6388 -
FORM-B, für Werkzeuge mit
Zylinderschaft DIN 1835-A.



BXX

Reference Bezeichnung		d1	D	L
B1602.0	B16	2,0-1,5	25,50	40
B1602.5	B16	2,5-2,0	25,50	40
B1603.0	B16	3,0-2,5	25,50	40
B1603.5	B16	3,5-3,0	25,50	40
B1604.0	B16	4,0-3,5	25,50	40
B1604.5	B16	4,5-4,0	25,50	40
B1605.0	B16	5,0-4,5	25,50	40
B1605.5	B16	5,5-5,0	25,50	40
B1606.0	B16	6,0-5,5	25,50	40
B1606.5	B16	6,5-6,0	25,50	40
B1607.0	B16	7,0-6,5	25,50	40
B1607.5	B16	7,5-7,0	25,50	40
B1608.0	B16	8,0-7,5	25,50	40
B1608.5	B16	8,5-8,0	25,50	40
B1609.0	B16	9,0-8,5	25,50	40
B1609.5	B16	9,5-9,0	25,50	40
B1610.0	B16	10,0-9,5	25,50	40
B1610.5	B16	10,5-10,0	25,50	40
B1611.0	B16	11,0-10,5	25,50	40
B1611.5	B16	11,5-11,0	25,50	40
B1612.0	B16	12,0-11,5	25,50	40
B1612.5	B16	12,5-12,0	25,50	40
B1613.0	B16	13,0-12,5	25,50	40
B1613.5	B16	13,5-13,0	25,50	40
B1614.0	B16	14,0-13,5	25,50	40
B1614.5	B16	14,5-14,0	25,50	40
B1615.0	B16	15,0-14,5	25,50	40
B1615.5	B16	15,5-15,0	25,50	40
B1616.0	B16	16,0-15,5	25,50	40
B2503.0	B25	3,0-2,5	35,05	52
B2503.5	B25	3,5-3,0	35,05	52
B2504.0	B25	4,0-3,5	35,05	52
B2504.5	B25	4,5-4,0	35,05	52
B2505.0	B25	5,0-4,5	35,05	52
B2505.5	B25	5,5-5,0	35,05	52
B2506.0	B25	6,0-5,5	35,05	52
B2506.5	B25	6,5-6,0	35,05	52
B2507.0	B25	7,0-6,5	35,05	52
B2507.5	B25	7,5-7,0	35,05	52
B2508.0	B25	8,0-7,5	35,05	52

Reference Bezeichnung		d1	D	L
B2508.5	B25	8,5-8,0	35,05	52
B2509.0	B25	9,0-8,5	35,05	52
B2509.5	B25	9,5-9,0	35,05	52
B2510.0	B25	10,0-9,5	35,05	52
B2510.5	B25	10,5-10,0	35,05	52
B2511.0	B25	11,0-10,5	35,05	52
B2511.5	B25	11,5-11,0	35,05	52
B2512.0	B25	12,0-11,5	35,05	52
B2512.5	B25	12,5-12,0	35,05	52
B2513.0	B25	13,0-12,5	35,05	52
B2513.5	B25	13,5-13,0	35,05	52
B2514.0	B25	14,0-13,5	35,05	52
B2514.5	B25	14,5-14,0	35,05	52
B2515.0	B25	15,0-14,5	35,05	52
B2515.5	B25	15,5-15,0	35,05	52
B2516.0	B25	16,0-15,5	35,05	52
B2516.5	B25	16,5-16,0	35,05	52
B2517.0	B25	17,0-16,5	35,05	52
B2517.5	B25	17,5-17,0	35,05	52
B2518.0	B25	18,0-17,5	35,05	52
B2518.5	B25	18,5-18,0	35,05	52
B2519.0	B25	19,0-18,5	35,05	52
B2519.5	B25	19,5-19,0	35,05	52
B2520.0	B25	20,0-19,5	35,05	52
B2520.5	B25	20,5-20,0	35,05	52
B2521.0	B25	21,0-20,5	35,05	52
B2521.5	B25	21,5-21,0	35,05	52
B2522.0	B25	22,0-21,5	35,05	52
B2522.5	B25	22,5-22,0	35,05	52
B2523.0	B25	23,0-22,5	35,05	52
B2523.5	B25	23,5-23,0	35,05	52
B2524.0	B25	24,0-23,5	35,05	52
B2524.5	B25	24,5-24,0	35,05	52
B2525.0	B25	25,0-24,5	35,05	52
B3204.0	B32	4,0-3,5	43,70	60
B3204.5	B32	4,5-4,0	43,70	60
B3205.0	B32	5,0-4,5	43,70	60
B3205.5	B32	5,5-5,0	43,70	60
B3206.0	B32	6,0-5,5	43,70	60
B3206.5	B32	6,5-6,0	43,70	60
B3207.0	B32	7,0-6,5	43,70	60
B3207.5	B32	7,5-7,0	43,70	60
B3208.0	B32	8,0-7,5	43,70	60
B3208.5	B32	8,5-8,0	43,70	60
B3209.0	B32	9,0-8,5	43,70	60
B3209.5	B32	9,5-9,0	43,70	60
B3210.0	B32	10,0-9,5	43,70	60
B3210.5	B32	10,5-10,0	43,70	60
B3211.0	B32	11,0-10,5	43,70	60
B3211.5	B32	11,5-11,0	43,70	60
B3212.0	B32	12,0-11,5	43,70	60
B3212.5	B32	12,5-12,0	43,70	60
B3213.0	B32	13,0-12,5	43,70	60



Reference Bezeichnung		d1	D	L
B3213.5	B32	13,5-13,0	43,70	60
B3214.0	B32	14,0-13,5	43,70	60
B3214.5	B32	14,5-14,0	43,70	60
B3215.0	B32	15,0-14,5	43,70	60
B3215.5	B32	15,5-15,0	43,70	60
B3216.0	B32	16,0-15,5	43,70	60
B3216.5	B32	16,5-16,0	43,70	60
B3217.0	B32	17,0-16,5	43,70	60
B3217.5	B32	17,5-17,0	43,70	60
B3218.0	B32	18,0-17,5	43,70	60
B3218.5	B32	18,5-18,0	43,70	60
B3219.0	B32	19,0-18,5	43,70	60
B3219.5	B32	19,5-19,0	43,70	60
B3220.0	B32	20,0-19,5	43,70	60
B3220.5	B32	20,5-20,0	43,70	60
B3221.0	B32	21,0-20,5	43,70	60
B3221.5	B32	21,5-21,0	43,70	60
B3222.0	B32	22,0-21,5	43,70	60
B3222.5	B32	22,5-22,0	43,70	60
B3223.0	B32	23,0-22,5	43,70	60
B3223.5	B32	23,5-23,0	43,70	60
B3224.0	B32	24,0-23,5	43,70	60
B3224.5	B32	24,5-24,0	43,70	60
B3225.0	B32	25,0-24,5	43,70	60
B3225.5	B32	25,5-25,0	43,70	60
B3226.0	B32	26,0-25,5	43,70	60
B3226.5	B32	26,5-26,0	43,70	60
B3227.0	B32	27,0-26,5	43,70	60
B3227.5	B32	27,5-27,0	43,70	60
B3228.0	B32	28,0-27,5	43,70	60
B3228.5	B32	28,5-28,0	43,70	60
B3229.0	B32	29,0-28,5	43,70	60
B3229.5	B32	29,5-29,0	43,70	60
B3230.0	B32	30,0-29,5	43,70	60
B3230.5	B32	30,5-30,0	43,70	60
B3231.0	B32	31,0-30,5	43,70	60
B3231.5	B32	31,5-31,0	43,70	60
B3232.0	B32	32,0-31,5	43,70	60



DIN 6499 ERXX/X - Runout table for collets DIN 6499 Rundlauftabelle der Spannzangen DIN 6499

Runout table of Mexin collets according to DIN 6499 showing the high precision of normal collets type ER/XX, in comparison with other brands.
Rundlauftabelle der Spannzangen Mexin nach DIN 6499. Die Tabelle zeigt die Hochgenauigkeit der normalen Spannzangen Typ ERXX im Vergleich mit anderen Marken.

THE CONTROL MUST BE MADE WITH A HIGH PRECISION "MASTER" GAUGE.
DIE KONTROLLE MUSS MIT EINER HOCHPRÄZISEN MASTER-MESSUHR GEMACHT WERDEN.

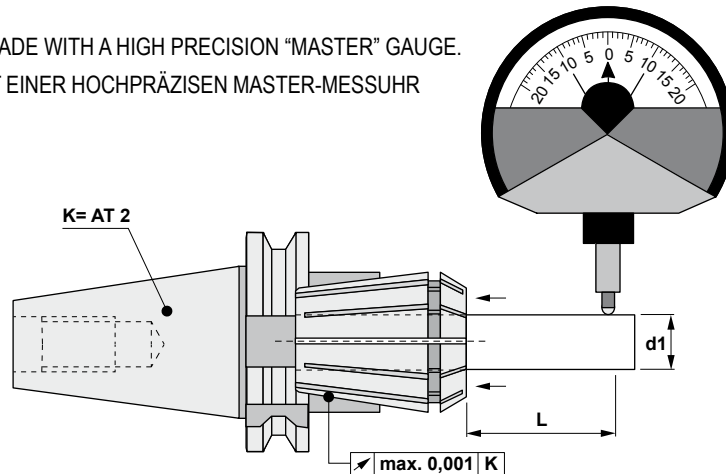

d1 mm	L mm	DIN		mexin	
		CLASS / KLASSE 2 mm	CLASS / KLASSE 1 mm	NORMAL mm	SUPER mm
		452XX ERXX		ERXX	
1,0 - 1,6	6	0,015	0,010	0,010	0,005
>1,6 - 3,0	10	0,015	0,010	0,010	0,005
>3,0 - 7,0	16	0,015	0,010	0,010	0,005
>7,0 - 10,0	25	0,015	0,010	0,010	0,005
>10,0 - 18,0	40	0,020	0,015	0,015	0,005
>18,0 - 26,0	50	0,020	0,015	0,015	0,005
>26,0 - 34,0	60	0,025	0,020	0,020	0,010

RECOMMENDED CLAMPING TORQUE FOR NUTS FOR DIN 6499 ER COLLETS.
EMPFOHLENES ANZUGSMOMENT FÜR SPANNMUTTER FÜR SPANNZANGEN DIN 6499 ER.

	Normal 453 / 456 Max. Torque Nm Max. Anzugsmoment Nm	Bearings / Kugellager 451 Max. Torque Nm Max. Anzugsmoment Nm	Mini 455 Max. Torque Nm Max. Anzugsmoment Nm
			
ER16	35 / 60	50 / 70	25 / 30
ER20	40 / 100	50 / 100	25 / 35
ER25	80 / 120	90 / 130	35 / 40
ER32	100 / 130	130 / 170	
ER40	170 / 200	220 / 220	
ER50	280 / 300	300 / 300	



Characteristics:

Collets with double slot DIN 6499 - Form B (ER).
For tools with cylindrical shank
DIN 1835-A.

Eigenschaften:

Spannzangen mit Doppelnut DIN 6499 - FORM
B (ER) für Werkzeuge mit Zylinderschaft DIN
1835-A.

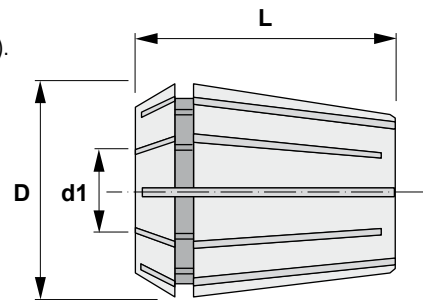

ERXX

Reference Bezeichnung		d1	D	L
ER1601	ER16	1,0-0,5	17	27,5
ER1601.5	ER16	1,5-1,0	17	27,5
ER1602	ER16	2,0-1,5	17	27,5
ER1602.5	ER16	2,5-2,0	17	27,5
ER1603	ER16	3,0-2,5	17	27,5
ER1604	ER16	4,0-3,0	17	27,5
ER1605	ER16	5,0-4,0	17	27,5
ER1606	ER16	6,0-5,0	17	27,5
ER1607	ER16	7,0-6,0	17	27,5
ER1608	ER16	8,0-7,0	17	27,5
ER1609	ER16	9,0-8,0	17	27,5
ER1610	ER16	10,0-9,0	17	27,5
ER2001	ER20	1,0-0,5	21	31,5
ER2001.5	ER20	1,5-1,0	21	31,5
ER2002	ER20	2,0-1,5	21	31,5
ER2002.5	ER20	2,5-2,0	21	31,5
ER2003	ER20	3,0-2,5	21	31,5
ER2004	ER20	4,0-3,0	21	31,5
ER2005	ER20	5,0-4,0	21	31,5
ER2006	ER20	6,0-5,0	21	31,5
ER2007	ER20	7,0-6,0	21	31,5
ER2008	ER20	8,0-7,0	21	31,5
ER2009	ER20	9,0-8,0	21	31,5
ER2010	ER20	10,0-9,0	21	31,5
ER2011	ER20	11,0-10,0	21	31,5
ER2012	ER20	12,0-11,0	21	31,5
ER2013	ER20	13,0-12,0	21	31,5
ER2501	ER25	1,0-0,5	26	34,0
ER2501.5	ER25	1,5-1,0	26	34,0
ER2502	ER25	2,0-1,5	26	34,0
ER2502.5	ER25	2,5-2,0	26	34,0
ER2503	ER25	3,0-2,5	26	34,0
ER2504	ER25	4,0-3,0	26	34,0
ER2505	ER25	5,0-4,0	26	34,0
ER2506	ER25	6,0-5,0	26	34,0
ER2507	ER25	7,0-6,0	26	34,0
ER2508	ER25	8,0-7,0	26	34,0
ER2509	ER25	9,0-8,0	26	34,0
ER2510	ER25	10,0-9,0	26	34,0
ER2511	ER25	11,0-10,0	26	34,0

Reference Bezeichnung		d1	D	L
ER2512	ER25	12,0-11,0	26	34,0
ER2513	ER25	13,0-12,0	26	34,0
ER2514	ER25	14,0-13,0	26	34,0
ER2515	ER25	15,0-14,0	26	34,0
ER2516	ER25	16,0-15,0	26	34,0
ER3202	ER32	2,0-1,5	33	40,0
ER3202.5	ER32	2,5-2,0	33	40,0
ER3203	ER32	3,0-2,5	33	40,0
ER3204	ER32	4,0-3,0	33	40,0
ER3205	ER32	5,0-4,0	33	40,0
ER3206	ER32	6,0-5,0	33	40,0
ER3207	ER32	7,0-6,0	33	40,0
ER3208	ER32	8,0-7,0	33	40,0
ER3209	ER32	9,0-8,0	33	40,0
ER3210	ER32	10,0-9,0	33	40,0
ER3211	ER32	11,0-10,0	33	40,0
ER3212	ER32	12,0-11,0	33	40,0
ER3213	ER32	13,0-12,0	33	40,0
ER3214	ER32	14,0-13,0	33	40,0
ER3215	ER32	15,0-14,0	33	40,0
ER3216	ER32	16,0-15,0	33	40,0
ER3217	ER32	17,0-16,0	33	40,0
ER3218	ER32	18,0-17,0	33	40,0
ER3219	ER32	19,0-18,0	33	40,0
ER3220	ER32	20,0-19,0	33	40,0
ER4003	ER40	3-2	41	46,0
ER4004	ER40	4-3	41	46,0
ER4005	ER40	5-4	41	46,0
ER4006	ER40	6-5	41	46,0
ER4007	ER40	7-6	41	46,0
ER4008	ER40	8-7	41	46,0
ER4009	ER40	9-8	41	46,0
ER4010	ER40	10-9	41	46,0
ER4011	ER40	11-10	41	46,0
ER4012	ER40	12-11	41	46,0
ER4013	ER40	13-12	41	46,0
ER4014	ER40	14-13	41	46,0
ER4015	ER40	15-14	41	46,0
ER4016	ER40	16-15	41	46,0
ER4017	ER40	17-16	41	46,0
ER4018	ER40	18-17	41	46,0
ER4019	ER40	19-18	41	46,0
ER4020	ER40	20-19	41	46,0
ER4021	ER40	21-20	41	46,0
ER4022	ER40	22-21	41	46,0
ER4023	ER40	23-22	41	46,0
ER4024	ER40	24-23	41	46,0
ER4025	ER40	25-24	41	46,0
ER4026	ER40	26-25	41	46,0
ER4027	ER40	27-26	41	46,0
ER4028	ER40	28-27	41	46,0
ER4029	ER40	29-28	41	46,0
ER4030	ER40	30-29	41	46,0



I

Reference Bezeichnung		d1	D	L
ER5006	ER50	6-4	52	60,0
ER5008	ER50	8-6	52	60,0
ER5010	ER50	10-8	52	60,0
ER5012	ER50	12-10	52	60,0
ER5014	ER50	14-12	52	60,0
ER5016	ER50	16-14	52	60,0
ER5018	ER50	18-16	52	60,0
ER5020	ER50	20-18	52	60,0
ER5022	ER50	22-20	52	60,0
ER5024	ER50	24-22	52	60,0
ER5026	ER50	26-24	52	60,0
ER5028	ER50	28-26	52	60,0
ER5030	ER50	30-28	52	60,0
ER5032	ER50	32-30	52	60,0
ER5034	ER50	34-32	52	60,0







Characteristics:

Set of collets DIN 6499 (ER) Form B in a plastic box.
DIN 6499-B

Eigenschaften:

Spannzangensatz DIN 6499 (ER) Form B im Etui.
DIN 6499-B

SET-ER

Reference Bezeichnung		CAP	n° 	Ø
SET-ER16	ER16	1-10	10	1-2-3-4-5-6-7-8-9-10
SET-ER20	ER20	2-13	12	2-3-4-5-6-7-8-9-10-11-12-13
SET-ER25	ER25	2-16	15	2-3-4-5-6-7-8-9-10-11-12-13-14-15-16
SET-ER32	ER32	3-20	18	3-4-5-6-7-8-9-10-11-12-13-14-15-16-17-18-19-20
SET-ER40	ER40	4-26	23	4-5-6-7-8-9-10-11-12-13-14-15-16-17-18-19-20-21-22-23-24-25-26





Characteristics:
Collets DIN 6499 - Form Mexin (ER).
With square locking drive and tension length-adjustment.

Eigenschaften:
Spannzangen DIN 6499 - Form Mexin (ER) mit vierkantigem Antrieb und Zuglängenausgleich.

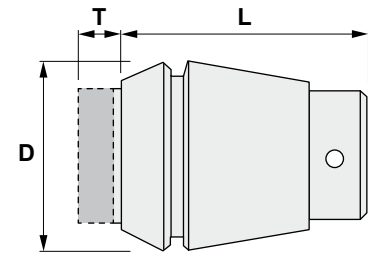

ERBXX

Reference Bezeichnung		DIN d1 x a	D	L	T
ERB1601	ER16	2,5 x 2,1	17	27	7
ERB1602	ER16	2,8 x 2,1	17	27	7
ERB1603	ER16	3,5 x 2,7	17	27	7
ERB1604	ER16	4,0 x 3,0	17	27	7
ERB1605	ER16	4,5 x 3,4	17	27	7
ERB1606	ER16	5,5 x 4,3	17	27	7
ERB1607	ER16	6,0 x 4,9	17	27	7
ERB2001	ER20	2,5 x 2,1	21	31	7
ERB2002	ER20	2,8 x 2,1	21	31	7
ERB2003	ER20	3,5 x 2,7	21	31	7
ERB2004	ER20	4,0 x 3,0	21	31	7
ERB2005	ER20	4,5 x 3,4	21	31	7
ERB2006	ER20	5,5 x 4,3	21	31	7
ERB2007	ER20	6,0 x 4,9	21	31	7
ERB2008	ER20	7,0 x 5,5	21	31	7
ERB2501	ER25	2,5 x 2,1	26	34	8
ERB2502	ER25	2,8 x 2,1	26	34	8
ERB2503	ER25	3,5 x 2,7	26	34	8
ERB2504	ER25	4,0 x 3,0	26	34	8
ERB2505	ER25	4,5 x 3,4	26	34	8
ERB2506	ER25	5,5 x 4,3	26	34	8
ERB2507	ER25	6,0 x 4,9	26	34	8
ERB2508	ER25	7,0 x 5,5	26	34	8
ERB2509	ER25	8,0 x 6,2	26	34	8
ERB2510	ER25	9,0 x 7,0	26	34	8
ERB3205	ER32	4,5 x 3,4	33	43	10
ERB3206	ER32	5,5 x 4,3	33	43	10
ERB3207	ER32	6,0 x 4,9	33	43	10
ERB3208	ER32	7,0 x 5,5	33	43	10
ERB3209	ER32	8,0 x 6,2	33	43	10
ERB3210	ER32	9,0 x 7,0	33	43	10
ERB3211	ER32	10,0 x 8,0	33	43	10
ERB3212	ER32	11,0 x 9,0	33	43	10
ERB3213	ER32	12,0 x 9,0	33	43	10
ERB4007	ER40	6,0 x 4,9	41	54	13
ERB4008	ER40	7,0 x 5,5	41	54	13
ERB4009	ER40	8,0 x 6,2	41	54	13
ERB4010	ER40	9,0 x 7,0	41	54	13
ERB4011	ER40	10,0 x 8,0	41	54	13
ERB4012	ER40	11,0 x 9,0	41	54	13
ERB4013	ER40	12,0 x 9,0	41	54	13
ERB4014	ER40	14,0 x 11,0	41	54	13
ERB4015	ER40	16,0 x 12,0	41	54	13



Characteristics:

Sealed collets DIN 6499 (ER).
For tools with cylindrical shank DIN 1835-A
and coolant channel.

Eigenschaften:

Abgedichtete Spannzangen DIN 6499 (ER)
für Werkzeuge mit Zylinderschaft DIN
1835-A und Innenkühlung.

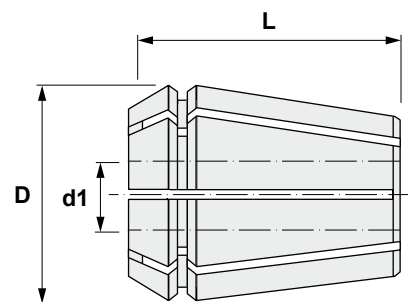

ERCXX

Reference Bezeichnung		D	L	d1
ERC1604	ER16	17	27,5	4
ERC1605	ER16	17	27,5	5
ERC1606	ER16	17	27,5	6
ERC1607	ER16	17	27,5	7
ERC1608	ER16	17	27,5	8
ERC1609	ER16	17	27,5	9
ERC1610	ER16	17	27,5	10
ERC2004	ER20	21	31,5	4
ERC2005	ER20	21	31,5	5
ERC2006	ER20	21	31,5	6
ERC2007	ER20	21	31,5	7
ERC2008	ER20	21	31,5	8
ERC2009	ER20	21	31,5	9
ERC2010	ER20	21	31,5	10
ERC2011	ER20	21	31,5	11
ERC2012	ER20	21	31,5	12
ERC2013	ER20	21	31,5	13
ERC2504	ER25	26	34,0	4
ERC2505	ER25	26	34,0	5
ERC2506	ER25	26	34,0	6
ERC2507	ER25	26	34,0	7
ERC2508	ER25	26	34,0	8
ERC2509	ER25	26	34,0	9
ERC2510	ER25	26	34,0	10
ERC2511	ER25	26	34,0	11
ERC2512	ER25	26	34,0	12
ERC2513	ER25	26	34,0	13
ERC2514	ER25	26	34,0	14
ERC2515	ER25	26	34,0	15
ERC2516	ER25	26	34,0	16
ERC3204	ER32	33	40,0	4
ERC3205	ER32	33	40,0	5
ERC3206	ER32	33	40,0	6
ERC3207	ER32	33	40,0	7
ERC3208	ER32	33	40,0	8
ERC3209	ER32	33	40,0	9
ERC3210	ER32	33	40,0	10
ERC3211	ER32	33	40,0	11
ERC3212	ER32	33	40,0	12
ERC3213	ER32	33	40,0	13



Reference Bezeichnung		D	L	d1
ERC3214	ER32	33	40,0	14
ERC3215	ER32	33	40,0	15
ERC3216	ER32	33	40,0	16
ERC3217	ER32	33	40,0	17
ERC3218	ER32	33	40,0	18
ERC3219	ER32	33	40,0	19
ERC3220	ER32	33	40,0	20
ERC4004	ER40	41	46,0	4
ERC4005	ER40	41	46,0	5
ERC4006	ER40	41	46,0	6
ERC4007	ER40	41	46,0	7
ERC4008	ER40	41	46,0	8
ERC4009	ER40	41	46,0	9
ERC4010	ER40	41	46,0	10
ERC4011	ER40	41	46,0	11
ERC4012	ER40	41	46,0	12
ERC4013	ER40	41	46,0	13
ERC4014	ER40	41	46,0	14
ERC4015	ER40	41	46,0	15
ERC4016	ER40	41	46,0	16
ERC4017	ER40	41	46,0	17
ERC4018	ER40	41	46,0	18
ERC4019	ER40	41	46,0	19
ERC4020	ER40	41	46,0	20
ERC4021	ER40	41	46,0	21
ERC4022	ER40	41	46,0	22
ERC4023	ER40	41	46,0	23
ERC4024	ER40	41	46,0	24
ERC4025	ER40	41	46,0	25
ERC4026	ER40	41	46,0	26
ERC5012	ER50	52	60,0	12
ERC5014	ER50	52	60,0	14
ERC5016	ER50	52	60,0	16
ERC5018	ER50	52	60,0	18
ERC5020	ER50	52	60,0	20
ERC5022	ER50	52	60,0	22
ERC5024	ER50	52	60,0	24
ERC5026	ER50	52	60,0	26
ERC5028	ER50	52	60,0	28
ERC5030	ER50	52	60,0	30
ERC5032	ER50	52	60,0	32
ERC5034	ER50	52	60,0	34





Characteristics:
Collets DIN 6499 - Form Mexin (ER).
With square locking drive.

Eigenschaften:
Spannzangen DIN 6499 - Form Mexin
(ER) mit vierkantigem Antrieb.

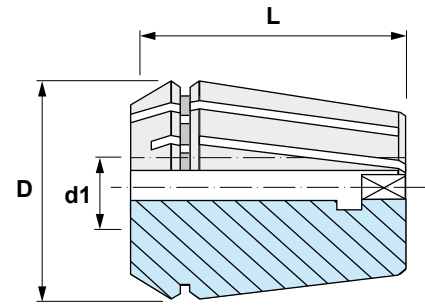

ERTXX

Reference Bezeichnung		d1	D	L
ERT1605	ER16	4,5 x 3,4	17	27,5
ERT1606	ER16	5,5 x 4,3	17	27,5
ERT1607	ER16	6,0 x 4,9	17	27,5
ERT1608	ER16	7,0 x 5,5	17	27,5
ERT2005	ER20	4,5 x 3,4	21	31,5
ERT2006	ER20	5,5 x 4,3	21	31,5
ERT2007	ER20	6,0 x 4,9	21	31,5
ERT2008	ER20	7,0 x 5,5	21	31,5
ERT2009	ER20	8,0 x 6,2	21	31,5
ERT2010	ER20	9,0 x 7,0	21	31,5
ERT2011	ER20	10,0 x 8,0	21	31,5
ERT2505	ER25	4,5 x 3,4	26	34,0
ERT2506	ER25	5,5 x 4,3	26	34,0
ERT2507	ER25	6,0 x 4,9	26	34,0
ERT2508	ER25	7,0 x 5,5	26	34,0
ERT2509	ER25	8,0 x 6,2	26	34,0
ERT2510	ER25	9,0 x 7,0	26	34,0
ERT2511	ER25	10,0 x 8,0	26	34,0
ERT2512	ER25	11,0 x 9,0	26	34,0
ERT2513	ER25	12,0 x 9,0	26	34,0
ERT3205	ER32	4,5 x 3,4	33	40,0
ERT3206	ER32	5,5 x 4,3	33	40,0
ERT3207	ER32	6,0 x 4,9	33	40,0
ERT3208	ER32	7,0 x 5,5	33	40,0
ERT3209	ER32	8,0 x 6,2	33	40,0
ERT3210	ER32	9,0 x 7,0	33	40,0
ERT3211	ER32	10,0 x 8,0	33	40,0
ERT3212	ER32	11,0 x 9,0	33	40,0
ERT3213	ER32	12,0 x 9,0	33	40,0
ERT3214	ER32	14,0 x 11,0	33	40,0
ERT3215	ER32	16,0 x 12,0	33	40,0
ERT4008	ER40	7,0 x 5,5	41	46,0
ERT4009	ER40	8,0 x 6,2	41	46,0
ERT4010	ER40	9,0 x 7,0	41	46,0
ERT4011	ER40	10,0 x 8,0	41	46,0
ERT4012	ER40	11,0 x 9,0	41	46,0
ERT4013	ER40	12,0 x 9,0	41	46,0
ERT4014	ER40	14,0 x 11,0	41	46,0
ERT4015	ER40	16,0 x 12,0	41	46,0
ERT4016	ER40	18,0 x 14,5	41	46,0



Reference Bezeichnung		d1	D	L
ERT4017	ER40	20,0 x 16,0	41	46,0
ERT5013	ER50	12,0 x 9,0	52	60,0
ERT5014	ER50	14,0 x 11,0	52	60,0
ERT5015	ER50	16,0 x 12,0	52	60,0
ERT5016	ER50	18,0 x 14,5	52	60,0
ERT5017	ER50	20,0 x 16,0	52	60,0
ERT5018	ER50	22,0 x 18,0	52	60,0
ERT5019	ER50	25,0 x 20,0	52	60,0
ERT5020	ER50	28,0 x 22,0	52	60,0
ERT5021	ER50	32,0 x 24,0	52	60,0





Characteristics: Eigenschaften:
Wrenches Schlüssel
DIN 6499 DIN 6499

50XX

Reference Bezeichnung	CAP
50008	0 - 8
50010	0-10
50013	0-13
50016	3-16



Characteristics: Eigenschaften:
Wrenches Schlüssel
DIN 6499 DIN 6499

50XX

Reference Bezeichnung	CAP
50116	16
50125	25
50132	32
50140	40



Characteristics: Eigenschaften:
Wrenches Schlüssel
DIN 6499 DIN 6499

50XX

Reference Bezeichnung	ER	CAP
50216	16	10
50220	20	13
50225	25	16
50232	32	20
50240	40	30
50250	50	34



Characteristics: Eigenschaften:
Wrenches Schlüssel
DIN 6499 DIN 6499

50XX

Reference Bezeichnung	ER	CAP
50907	07	-
50908	08	-
50916	16	10
50920	20	13
50925	25	16





Characteristics:
Nut for collet chucks
DIN 6388-D

*** STANDARD**

Eigenschaften:
Spannmutter für Spannzangen
DIN 6388-D

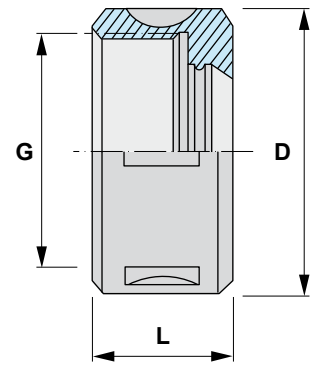

433XX

Reference Bezeichnung	d1 max	D	L	G
43316	16	43	24,0	M 33 x 1,5
43325	25	60	30,0	M 48 x 2,0
43332	32	72	33,5	M 60 x 2,5



Characteristics:
Nut for collet chucks
DIN 6388-D

*** BALL BEARING NUT**

Eigenschaften:
Spannmutter für Spannzangen
DIN 6388-D

*** KUGELLAGER-MUTTER**

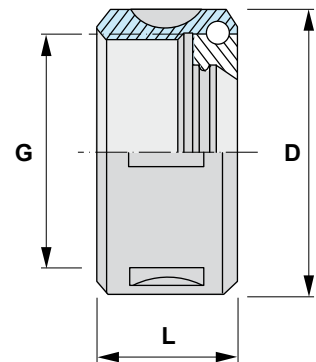

431XX

Reference Bezeichnung	d1 max	D	L	G
43116	16	43	24,0	M 33 x 1,5
43125	25	60	30,0	M 48 x 2,0
43132	32	72	33,5	M 60 x 2,5



Characteristics:
Nut for collet chucks DIN 6499 (ER) D-F

*** STANDARD**

Eigenschaften:
Spannmutter für Spannzangen DIN 6499 (ER) D-F

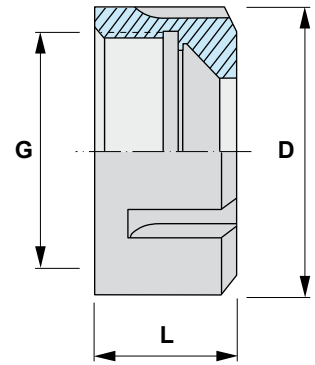

453XX

Reference Bezeichnung		d1 max	D	L	G
45316	ER16	10	32	17,5	M 22 x 1,5
45320	ER20	13	35	19,0	M 25 x 1,5
45325	ER25	16	42	20,0	M 32 x 1,5
45332	ER32	20	50	22,5	M 40 x 1,5
45340	ER40	26	63	25,5	M 50 x 1,5
45350	ER50	34	78	35,5	M 64 x 2,0



Characteristics:
Nut for collet chucks DIN 6499 (ER) D-F

*** BALL BEARING NUT**

Eigenschaften:
Spannmutter für Spannzangen DIN 6499 (ER) D-F

*** KUGELLAGER-MUTTER**

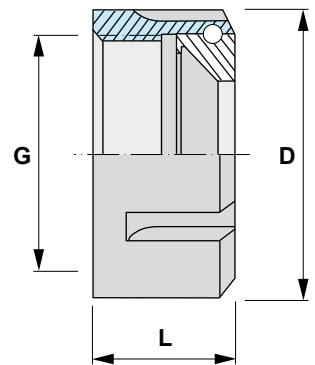

451XX

Reference Bezeichnung		d1 max	D	L	G
45116	ER16	10	29	19,5	M 22 x 1,5
45120	ER20	13	34	21,0	M 25 x 1,5
45125	ER25	16	42	22,7	M 32 x 1,5
45132	ER32	20	50	26,5	M 40 x 1,5
45140	ER40	26	63	29,8	M 50 x 1,5
45150	ER50	34	78	40,0	M 64 x 2,0





Characteristics:
Nut for collet chucks DIN 6499 (ER) D-F

*** MINI**

Eigenschaften:
Spannmutter für Spannzangen DIN 6499 (ER) D-F

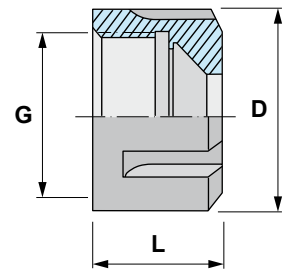

455XX

Reference Bezeichnung		d1 max	D	L	G
45516	ER16	13	22	19	M 19 x 1
45520	ER20	16	28	20	M 24 x 1
45525	ER25	-	35	-	M 30 x 1



Characteristics:
Nut for collet chucks DIN 6499 (ER) D-F

Eigenschaften:
Spannmutter für Spannzangen DIN 6499 (ER) D-F

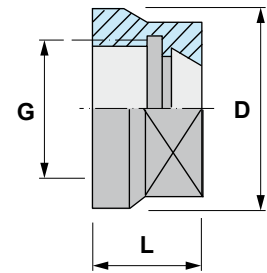

456XX

Reference Bezeichnung		d1 max	D	L	G
45616	ER16	10	28	17,5	M 22 x 1,5
45620	ER20	13	34	19,0	M 25 x 1,5



Characteristics:
Nut for collet chucks DIN 6499 (ER) D-F

*** SPECIAL 457**

Eigenschaften:
Spannmutter für Spannzangen DIN 6499 (ER) D-F

*** SONDER 457**

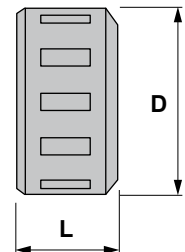

457XX

Reference Bezeichnung		d1 max	D	L	G
45732	ER32	20	54	40	M 45 x 1,5
45740	ER40	30	65	50	M 56 x 2,0



Characteristics: Pull Studs - DIN 69872-A
Eigenschaften: Anzugsbolzen - DIN 69872-A

* Without central hole
* Ohne zentraler Bohrung

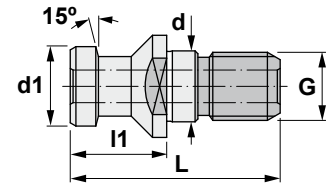

91.. DIN 69872-A

Reference Bezeichnung	K ISO	G	d	d1	L	l1
91103 *	30	M 12	13	13	44	24
91104	40	M 16	17	19	54	26
91105	50	M 24	25	28	74	34



Characteristics: Pull Studs - DIN 69872-B
Eigenschaften: Anzugsbolzen - DIN 69872-B

With half hole
Mit Sachlochbohrung

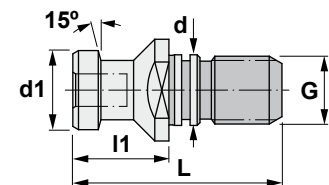

91.. DIN 69872-B

Reference Bezeichnung	K ISO	G	d	d1	L	l1
91154	40	M 16	17	19	54	26
91155	50	M 24	25	28	74	34



Characteristics: Pull Studs - DIN 69872-B
Eigenschaften: Anzugsbolzen - DIN 69872-B

Without central hole
Ohne zentraler Bohrung

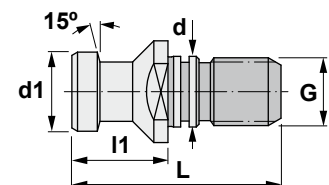

91.. DIN 69872-B

Reference Bezeichnung	K ISO	G	d	d1	L	l1
91164	40	M 16	17	19	54	26
91165	50	M 24	25	28	74	34





Characteristics: Pull Studs - ISO 7388/2-B
Eigenschaften: Anzugsbolzen - ISO 7388/2-B

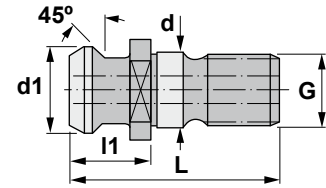

91.. ISO 7388/2-B

Reference Bezeichnung	K ISO	G	d	d1	L	l1
91304	40	M 16	17	18,95	44,5	16,40
91305	50	M 24	25	29,10	65,5	25,55



Characteristics: Pull Studs - ISO 7388/2-B
Eigenschaften: Anzugsbolzen - ISO 7388/2-B

Without central hole
Ohne zentraler Bohrung

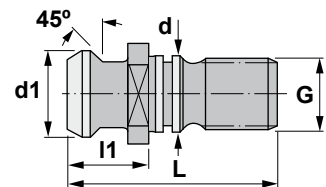

91.. ISO 7388/2-B

Reference Bezeichnung	K ISO	G	d	d1	L	l1
91114	40	M 16	17	18,95	44,5	16,40
91115	50	M 24	25	29,10	65,5	25,55



Characteristics: Pull Studs - ISO 7388/2-A
Eigenschaften: Anzugsbolzen - ISO 7388/2-A

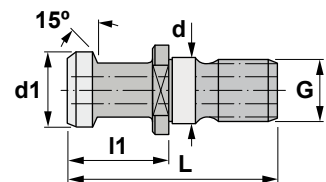

91.. ISO 7388/2-A

Reference Bezeichnung	K ISO	G	d	d1	L	l1
91354	40	M 16	17	19	54	26
91355	50	M 24	25	28	74	34



Characteristics: Pull Studs - ISO 7388/2-A
Eigenschaften: Anzugsbolzen - ISO 7388/2-A

Without central hole
Ohne zentraler Bohrung

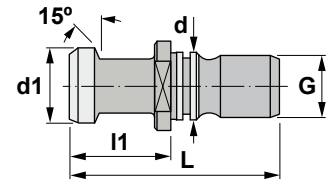

91.. ISO 7388/2-A

Reference Bezeichnung	K ISO	G	d	d1	L	l1
91263	30	M 12	13	12	44	24
91264	40	M 16	17	19	54	26
91265	50	M 24	25	28	74	34



Characteristics: Pull Studs
Eigenschaften: Anzugsbolzen

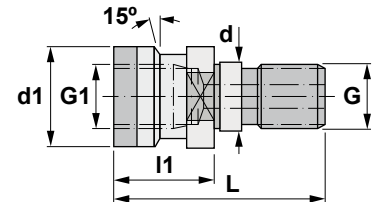

91.. MAHO - OTT / DIN 69871 - BT

Reference Bezeichnung	K ISO	G	G1	d	d1	L	l1	
91004	40	M 16	M 16	17	25,00	53	25	DIN 69871
91014	40	M 16	M 16	17	25,00	56	28	BT
91005	50	M 24	M 24	25	39,60	65	25	DIN 69871 / BT

Accessory to assemble DIN-69872-A (Ref. 91004) and JIS 6339-BT (Ref. 91014) on DIN 2080 machines.
Ersatzteil um die DIN-69872-A (Bez. 91004) und die JIS 6339-BT (Bez. 91014) auf Maschinen DIN 2080 zu montieren.





Characteristics: Pull Studs - JIS 6339 B-BT
Eigenschaften: Anzugsbolzen - JIS 6339 B-BT

* Without central hole
* Ohne zentraler Bohrung

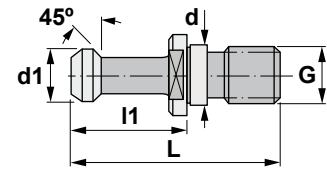

92.. BT - TYPE / TYP I (45°)

Reference Bezeichnung	K ISO	G	d	d1	L	l1
92003 *	30	M 12	12,5	11	43	23
92004 *	40	M 16	17,0	15	60	35
92005 *	50	M 24	25,0	23	85	45
92304	40	M 16	17,0	15	60	35
92305	50	M 24	25,0	23	85	45



Characteristics: Pull Studs - JIS 6339 B-BT
Eigenschaften: Anzugsbolzen - JIS 6339 B-BT

* Without central hole
* Ohne zentraler Bohrung

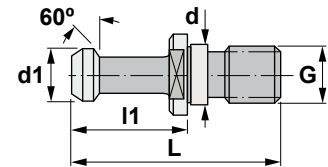

92.. BT - TYPE / TYP II (60°)

Reference Bezeichnung	K ISO	G	d	d1	L	l1
92013 *	30	M 12	12,5	11	43	23
92014 *	40	M 16	17,0	15	60	35
92015 *	50	M 24	25,0	23	85	45
92314	40	M 16	17,0	15	60	35
92315	50	M 24	25,0	23	85	45



Characteristics: Pull Studs - JIS 6339 B-BT
Eigenschaften: Anzugsbolzen - JIS 6339 B-BT

* Without central hole
* Ohne zentraler Bohrung

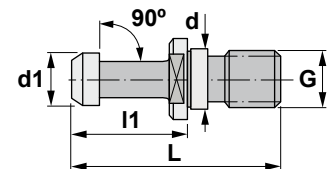

92.. BT - TYPE / TYP III (90°)

Reference Bezeichnung	K ISO	G	d	d1	L	l1
92024 *	40	M 16	17	15	60	35
92025 *	50	M 24	25	23	85	45
92324	40	M 16	17	15	60	35
92325	50	M 24	25	23	85	45



Characteristics: Pull Studs
Eigenschaften: Anzugsbolzen

* Without central hole
* Ohne zentraler Bohrung

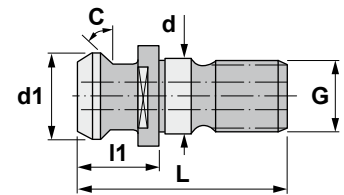

9... SPECIAL / SONDER

Reference Bezeichnung	K ISO	C	G	d	d1	L	l1	Type Typ
9CA40	40	45°	M 16	17	18,18	41,25	16,25	MAZAK
9CA41	40	45°	M 16	17	18,18	44,10	19,10	MAZAK
9CO50 *	50		M 24	-	20,00	76,00	36,00	CORREA
9MT40	40	15°	M 16	17	19,00	54,00	29,00	MATSURA
9OK35 *	35							KITAMURA
9CI40 *	40							CINCINNATI
9ZA50 *	50			23	22,00	90,00	46,00	ZAYER





Characteristics:

Assembly fixture for toolholders.

It can be used with all sizes of DIN 2080, DIN 69871/A, MAS BT, HSK and PSC adaptors.

It can be tightened on a bench or with a clamp.

Useful for assembling and disassembling the tools in any toolholder.

*** Combined stainless steel / blackened**

Eigenschaften:

Montagevorrichtung für Werkzeughalter. Verwendbar mit allen Größen von Aufnahmen DIN 2080, DIN 69871/A, MAS BT, HSK und PSC.

Sie kann auf einer Bank oder mit einem Schraubstock befestigt werden. Nützlich, um die Werkzeuge in jedem Werkzeughalter zu montieren und demontieren.

*** Kombiniert rostfrei / brüniert**

02_70/80

Reference Bezeichnung	DIN 2080	DIN 69871/A	MAS BT	HSK	PSC
02.30.70	30	30	X	50	C5
02.30.80	X	X	30	X	X
02.40.70	40	40	40	63	C6
02.50.70	50	50	X	100	X
02.50.80	X	X	50	X	X



Characteristics:

Assembly fixture for toolholders.

It can be used with all sizes of DIN 2080, DIN 69871/A, MAS BT, HSK and PSC adaptors.

It can be tightened on a bench or with a clamp.

Useful for assembling and disassembling the tools in any toolholder.

*** 100% stainless steel**

Eigenschaften:

Montagevorrichtung für Werkzeughalter. Verwendbar mit allen Größen von Aufnahmen DIN 2080, DIN 69871/A, MAS BT, HSK und PSC.

Sie kann auf einer Bank oder mit einem Schraubstock befestigt werden. Nützlich, um die Werkzeuge in jedem Werkzeughalter zu montieren und demontieren.

*** 100% rostfreier Stahl**

02_71/81

Reference Bezeichnung	DIN 2080	DIN 69871/A	MAS BT	HSK	PSC
02.30.71	30	30	X	50	C5
02.30.81	X	X	30	X	X
02.40.71	40	40	40	63	C6
02.50.71	50	50	X	100	X
02.50.81	X	X	50	X	X



SPARE PARTS ERSATZTEILE

TURNING SPARE PARTS ERSATZTEILE ZUM DREHEN

Screws **J02-05**
Schrauben

Lock pins **J06**
Rohrstifte

Clamps **J06-09**
Pratzen

Shim seats **J10-15**
Unterlegplatten

Seats **J15**
Kassetten

Levers **J16-17**
Kniehebel

Others **J17-18**
Andere

Wrenches **J19**
Schlüssel

MILLING SPARE PARTS ERSATZTEILE ZUM FRÄSEN

Screws **J20-22**
Schrauben

Washers **J22**
Unterlegscheiben

Shim seats **J23**
Unterlegplatten

Wedges and seats **J24**
Keile und Kassetten

Seats and cartridges **J25-27**
Kassetten

Wrenches **J28**
Schlüssel



J

Screws (Allen) / Schrauben (Imbus)

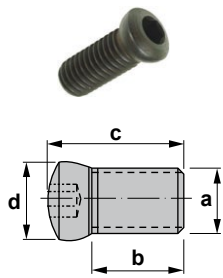

Reference Bezeichnung	a	b	c	d	Wrench Schlüssel	Torque (N.m) Drehmoment (N·m)
1006	M6x1	11,2	17,0	9,0	A4	3.5

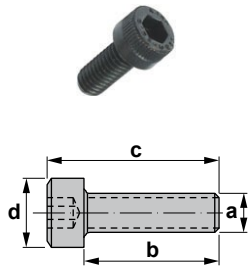

Reference Bezeichnung	a	b	c	d	Wrench Schlüssel	Torque (N.m) Drehmoment (N·m)
1075	M5x0.8	25,0	30,1	8,35	A4	3.5
1076	M6x1	30,0	36,0	10,00	A5	4.0
1078	M8x1.25	40,0	48,1	12,60	A6	-
1093	M3x0.5	8,0	11,2	5,40	A2.5	2.0
1095	M5x0.8	8,2	11,8	8,40	A4	3.5
1096	M6x1	25,0	31,0	10,00	A5	4.0
1296	M6x1	10,0	14,0	9,80	A5	4.0
1392	M2.5	9,6	12,5	4,40	A2	1.4
1393	M3x0.5	4,0	7,0	5,50	A2.5	2.0
1394	M4	6,1	8,6	6,90	A2.5	2.0
1396	M6x1	16,0	21,9	9,75	A5	4.0
1494	M4x0.7	12,0	16,0	7,00	A3	3.0
1495	M5x0.8	16,0	21,2	8,40	A4	3.5
1496	M6x1	12,0	16,0	9,80	A4	3.5
1695	M5x0.8	20,0	23,6	8,30	A4	3.5
1696	M6x1	25,0	29,0	10,00	A4	3.5
1905	M5x0.8	12,0	16,9	8,30	A4	3.5
1906	M6x1	20,0	26,0	10,00	A5	4.0
1916	M6x1	12,0	18,0	10,00	A5	4.0

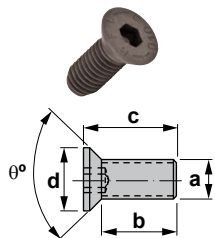

Reference Bezeichnung	a	b	c	d	θ°	Wrench Schlüssel	Torque (N.m) Drehmoment (N·m)
1059	M10x1.5	13,2	18,5	11,5	60	A6	
1192	M8x1.25	13,8	20,0	14,1	70	A5	4.0

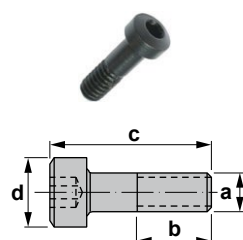

Reference Bezeichnung	a	b	c	d	Wrench Schlüssel	Torque (N.m) Drehmoment (N·m)
1614	W1/4	12	25	10	A4	3.5

Screws (Allen) / Screws (Imbus)

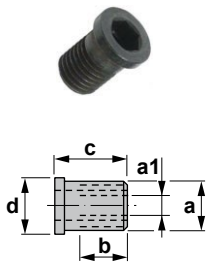

Reference Bezeichnung	a	a1	b	c	d	Wrench Schlüssel	Torque (N.m) Drehmoment (N·m)
1750	M5x0.5	M3.5x0.6	5,0	8,5	6,2	A3.5	-
1760	M6x0.75	M4x0.5	5,5	10,0	7,7	A4	3.5
1764	M5x0.8	M5x0.8	5,8	8,0	6,3	A2	1.4
1765	M6x0.75	M4x0.5	6,0	10,0	7,5	A4	3.5
1766	M6x1	M6x1	6,5	10,0	7,8	A2.5	2.0
1768	M6x1	M6x1	13,3	15,5	10,4	A3	3.0
1770	M6x1	M6x1	11,0	15,0	11,9	A3	3.0

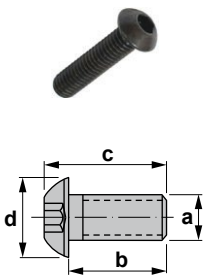

Reference Bezeichnung	a	b	c	d	Wrench Schlüssel	Torque (N.m) Drehmoment (N·m)
1803	M3	8,0	9,4	5,5	A2	1.4
1804	M4x0.7	10,0	12,1	7,5	A2.5	2.0
1806	M6x1	25,0	28,2	10,5	A4	3.5
1808	M8x1.25	30,0	34,3	14,0	A5	4.0
1810	M10x1.5	40,0	45,3	18,0	A6	-
1813	M3	4,5	5,9	5,5	A2	1.4
1814	M4	3,5	5,5	7,5	A2.5	2.0
1815	M5x0.8	12,5	15,0	9,3	A3	3.0
1816	M6x1	20,0	23,2	10,5	A4	3.5

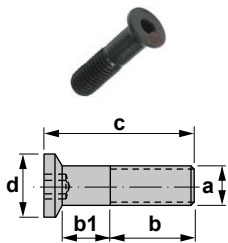

Reference Bezeichnung	a	b	b1	c	d	Wrench Schlüssel	Torque (N.m) Drehmoment (N·m)
1907	M7x0.75	14,0	10,6	27,5	10,7	A4	3.5
1915	M5x0.8	12,1	8,0	23,0	8,7	A2.5	2.0

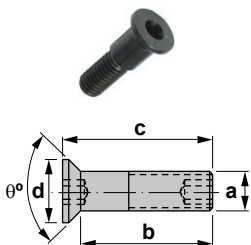

Reference Bezeichnung	a	b	c	d	θ°	Wrench Schlüssel	Torque (N.m) Drehmoment (N·m)
1935	M3.5x0.6	11,5	13	5,6	90	A2	1.4
1950	M5x0.8	16,7	19	7,9	92	A2.5	2.0
1955	M5x0.8	16,9	19	8,9	90	A3	3.0

Screws (Torx) / Schrauben (Torx)

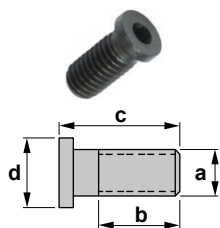

Reference Bezeichnung	a	b	c	d	Wrench Schlüssel	Torque (N.m) Drehmoment (N·m)
1140	M4x0.7	3,2	7,5	5,0	T15	3.0
1150	M5x0.8	10,0	13,5	6,4	T9	1.4
1151	M5x0.8	7,0	10,5	6,4	T9	1.4
1160	M6x1	9,5	13,5	7,8	T20	4.0
1161	M6x1	6,5	10,5	7,9	T20	4.0
1180	M8x1	9,5	13,5	11,0	T25	5.0

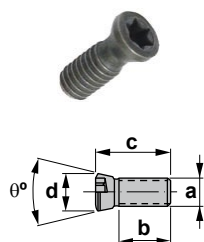

Reference Bezeichnung	a	b	c	d	θ°	Wrench Schlüssel	Torque (N.m) Drehmoment (N·m)
1182	M8x1	9,5	13,5	10,5	60	T25	5.0
1220	M2x0.4	3,7	5,5	3,3	55	T6	0.6
1222	M2.2x0.45	3,5	6,0	3,3	55	T6	0.6
1225	M2.5x0.45	4,0	7,0	3,3	55	T7	0.9
1226	M2.5	6,0	8,3	4,0	94	T8	1.2
1230	M3x0.5	5,6	9,0	4,4	55	T8	1.2
1235	M3.5	6,5	9,5	5,3	55	T15	3.0
1240	M4x0.7	6,2	11,0	5,3	55	T15	3.0
1244	M4x0.7	8,0	12,0	7,0	55	T20	4.0
1250	M5x0.8	6,0	12,0	7,0	55	T20	4.0
1255	M5x0.8	9,0	12,0	7,0	94	T20	4.0
1260	M6x1	11,5	16,0	7,9	55	T25	5.0
1334	M3.5x0.6	7,2	12,0	5,3	55	T15	3.0
1335	M3.5x0.6	10,2	15,0	5,3	55	T20	3.0
1340	M4x0.7	11,2	16,0	5,3	55	T15	3.0
1350	M5x0.8	17,8	22,0	7,0	55	T20	4.0
1360	M6x1	17,0	22,5	7,9	55	T25	5.0
1415	M1.6x0.35	1,5	3,2	2,6	60	T6	0.6
1420	M2x0.4	2,2	4,3	3,3	55	T6	0.6
1422	M2.2x0.45	1,8	4,3	3,3	55	T6	0.6
1425	M2.5x0.45	3,0	5,5	3,3	55	T7	0.9
1430	M3x0.5	2,8	5,8	4,4	55	T8	1.2
1440	M4x0.7	3,2	7,5	5,3	55	T15	3.0
1450	M5x0.8	11,0	17,0	7,0	55	T20	4.0
1535	M3.5	7,5	10,0	5,0	94	T10	2.0
1540	M4x0.5	7,9	14,1	6,8	60	T15	3.0
1622	M2.2x0.45	4,0	6,0	3,4	60	T7	0.9
1625	M2.5x0.45	3,6	6,5	3,8	60	T8	1.2
1630	M3x0.5	5,2	8,3	4,3	60	T9	1.4
1635	M3.5x0.6	5,5	9,0	4,7	60	T10	2.0
1640	M4	7,0	10,5	5,5	60	T15	3.0
SA3	5-40UNC-3A	12,0	15,0	5,5	60	T10	2.0
SA3T	5-40UNC-3A	9,5	12,5	5,5	60	T10	2.0
SA4	8-UNC	11,0	15,0	7,5	60	T20	4.0
SA5	10-32UNF	16,8	22,0	8,2	60	T25	5.0
SN3	5-40UNC-3A	6,5	9,5	5,5	60	T10	2.0
SN4	8-UNC	8,0	12,0	7,5	60	T20	4.0

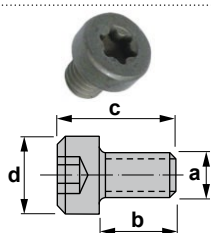

Reference Bezeichnung	a	b	c	d	Wrench Schlüssel	Torque (N.m) Drehmoment (N·m)
SY3	5-40UNC	4,2	6,9	5,4	T10	2.0
SY4	8-32UNC	5,3	9,1	6,8	T20	4.0
SY5	10-32UNF	5,8	9,2	8,4	T25	5.0

Clamp screws / Schrauben für Prätzen

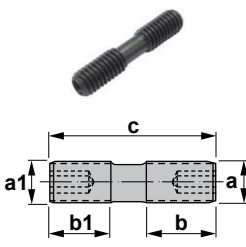

Reference Bezeichnung	a	a1	b	b1	c	Wrench Schlüssel	Torque (N.m) Drehmoment (N-m)
1085	M5x0.8L	M5x0.8R	7,9	7,9	21,3	A2.5	2.0
1086	M6x1L	M6x1R	11,4	11,4	29,4	A3	3.0
1098	M8x1L	M8x1R	12,7	10,4	29,4	A4	3.5
1186	M6x1L	M6x1R	7,1	7,1	20,5	A3	3.0

Screws / Schrauben

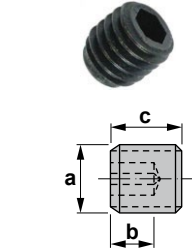

Reference Bezeichnung	a	b	c	Wrench Schlüssel	Torque (N.m) Drehmoment (N-m)
1503	M3x0.5	2	4	A1.5	0.6
1504	M4x0.7	2	4	A2	1.4
1505	M5x0.8R	3	5	A2.5	2.0
1506	M6x1R	4	5	A3	3.0
1508	M8x1.25R	5	8	A4	3.5

Adjustable screws / Verstellbare Schrauben

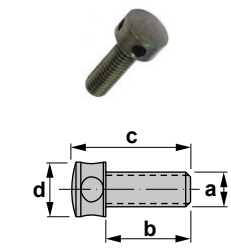

Reference Bezeichnung	a	b	c	d	Wrench Schlüssel	Torque (N.m) Drehmoment (N-m)
1403	M3x0.5	6,5	9,5	4	A4	3.5
1404	M4x0.7	9,0	12,5	7	A2.5	2.0
1405	M5x0.8	10,5	16,5	9	A2	1.4
1406	M6x1	12,0	18,0	11	A2.5	2.0
1408	M8x1.25	15,0	21,0	13	A3	3.0

Lever lock system - Screws / Schrauben für Kniehebel-System

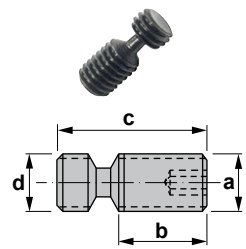

Reference Bezeichnung	a	b	c	d	Wrench Schlüssel	Torque (N.m) Drehmoment (N-m)
1605	M5x0.8	6,1	12,0	5	A2	1.4
1705	M5x0.8	8,1	14,0	5	A2	1.4
1715	M5x0.8	4,3	9,6	5	A2	1.4

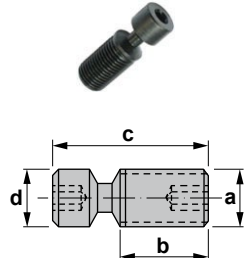

Reference Bezeichnung	a	b	c	d	Wrench Schlüssel	Torque (N.m) Drehmoment (N-m)
1606	M6x1	8,6	16,7	6	A2.5	2.0
1608	M8x1	8,7	20,7	8	A3	3.0
1610	M10x1	13,3	27,2	10	A4	3.5
1612	M12x1	17,3	36,0	12	A5	4.0
1618	M8x1	11,2	22,5	8	A3	3.0
1626	M6x1	8,0	13,4	6	A2.5	2.0
1638	M8x1	10,3	21,1	8	A3	3.0
1648	M8x1	9,1	17,0	8	A3	3.0
1706	M6x1	12,6	20,7	6	A2.5	2.0
1708	M8x1	12,2	23,5	8	A3	3.0
1710	M10x1	17,3	30,4	10	A4	3.5



Lock pins / Rohrstifte

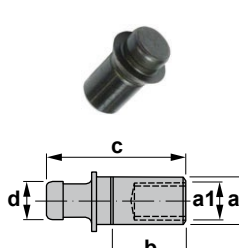

Reference Bezeichnung	a	a1	b	c	d
1642	4,5	M3x0.5	7,6	13,2	3,7
1643	4,5	M3x0.5	3,4	8,5	3,7
1644	4,5	M3x0.5	5,0	10,1	3,7
1647	6,0	M4x0.7	3,1	8,5	5,0
1661	6,0	M4x0.7	5,6	13,5	5,0
1682	8,0	M6x1	9,2	16,5	7,7

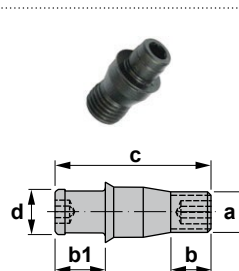

Reference Bezeichnung	a	b	b1	c	d	Wrench Schlüssel	Torque (N.m) Drehmoment (N·m)
1656	1/4" 26FILS	4,0	5,5	17,2	4,9	A2.5	2.0
1657	M6x1	5,0	7,0	18,6	5,0	A2.5	2.0
1665	M5x0.8	2,3	5,0	13,0	3,6	A2	1.4
1666	1/4" 26FILS	2,9	6,9	18,6	5,0	A2.5	2.0
1670	3/8" 24FILS	4,5	7,8	21,9	7,4	A4	3.5
1673	M6	4,8	6,3	22,0	6,3	A3	3.0
1674	M6	4,5	6,3	21,9	7,7	A4	3.5
1675	M5x0.8	3,4	5,0	16,2	3,6	A2	1.4
1686	1/4" 26FILS	3,5	5,5	13,3	5,0	A2.5	2.0

Top clamp (C) system - Clamps / Obere-Klemmung-Pratzen

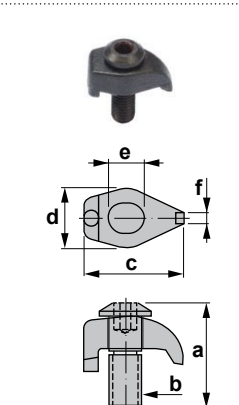

Reference Bezeichnung	a	b	c	d	e	f	Wrench Schlüssel	Torque (N.m) Drehmoment (N·m)
2000	9,5	M3x0.5	9,5	5,4	3,2	2	A1.5	0.6
2304	14,0	M4x0.7	13,2	8,0	5,0	2	A2.5	2.0
2305	18,7	M5x0.8	16,8	10,0	5,5	2	A3	3.0

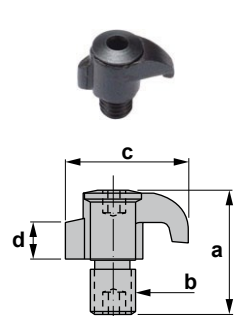

Reference Bezeichnung	a	b	c	d	Wrench Schlüssel	Torque (N.m) Drehmoment (N·m)
2107	14,0	M5x0.8	13,8	4,1	A2.5	2.0
2109	16,3	M6x1	16,2	5,0	A3	3.0
2119	15,3	M6x1	16,5	5,2	A3	3.0
2207	15,8	M5x0.8	13,8	4,1	A2.5	2.0
2209	21,0	M6x1	16,5	5,0	A3	3.0
2211	24,0	M8x1	20,5	7,6	A4	3.5
2307	14,0	M5x0.8	13,8	4,1	A2.5	2.0
2516	15,8	M5x0.8	14,8	7,3	T15	3.0
2522	20,0	M6x1	18,0	9,5	T15	3.0
2527	26,0	M8x1.25	24,5	13,0	T25	5.0

Wedge clamp (M) system - Clamps / M-Klemmung-Pratzen

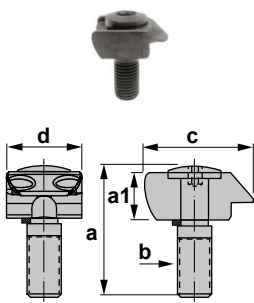
	Reference Bezeichnung	a	a1	b	c	d	Wrench Schlüssel	Torque (N.m) Drehmoment (N·m)
	2006	19,5	6,8	M5x0.5	14,7	11	A2.5	2.0
2011	26,0	8,1	M8x1	22,0	17	A5	4.0	
2014	26,0	8,3	M8x1	21,4	15	A5	4.0	
2015	26,0	8,2	M8x1	22,1	12	A5	4.0	
2024	24,0	9,2	M8x1	22,5	17	A5	4.0	

Wedge clamp (M-K) system - Clamps / M/K-Klemmung-Pratzen

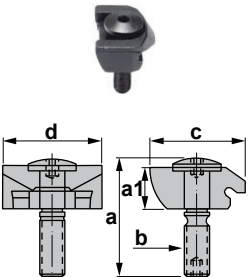
	Reference Bezeichnung	a	a1	b	c	d	Wrench Schlüssel	Torque (N.m) Drehmoment (N·m)
	2017	24	8,0	M5x0.8	15,7	18,6	A2.5	2.0
2018	24	8,4	M5x0.8	15,7	18,6	A2.5	2.0	
2023	24	7,3	M6x1	15,7	24,4	A3	3.0	

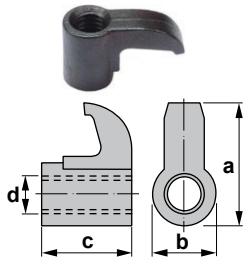
	Reference Bezeichnung	a	b	c	d
	2604	14,8	7,9	11,2	M5x0.8L
2613	18,5	9,5	13,5	M6x1L	
2614	21,7	9,5	13,5	M6x1L	
2616	24,0	9,5	13,5	M6x1L	
2621	22,4	10,9	16,8	M8x1L	

Dimple lock system - Clamps / Dimple-Lock-Pratzen

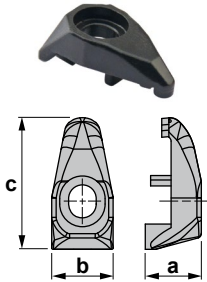
	Reference Bezeichnung	a	b	c
	2308	9,4	10,9	24,8
2312	12,0	14,0	28,8	
2319	13,4	15,9	33,3	
2708	11,3	12,9	24,2	
2712	12,6	13,8	29,6	
2716	14,2	13,8	33,9	
2719	14,2	13,8	35,4	

Threading - Clamps / Gewindedreh-Pratzen

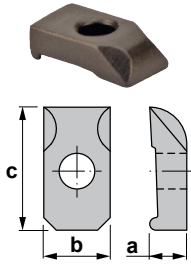
	Reference Bezeichnung	a	b	c	Wrench Schlüssel	Torque (N.m) Drehmoment (N·m)
	2101	5,3	9,5	17,8	T15	0.6



KNUX - Clamps / KNUX-Pratzen

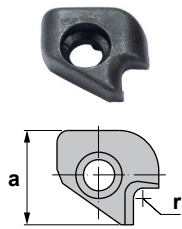

Reference Bezeichnung	a	r
2316	23,5	2,5

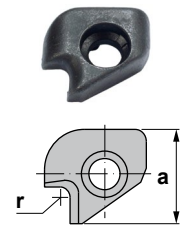

Reference Bezeichnung	a	r
2326	23,5	2,5

Ceramic tools - Clamps / Keramikwerkzeug-Pratzen

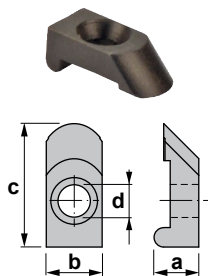

Reference Bezeichnung	a	b	c	d	θ°	Wrench Schlüssel	Torque (N.m) Drehmoment (N·m)
2120	7,0	5,5	18,7	5,1	40	T15	3.0
2121	6,9	8,6	19,0	7,5	45	T20	4.0
2122	8,5	11,8	24,7	8,2	45	T25	5.0

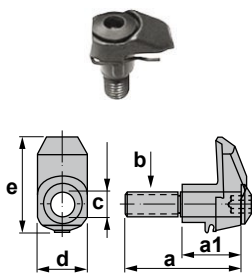

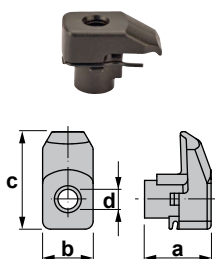

Reference Bezeichnung	a	a1	b	c	d	e	Wrench Schlüssel	Torque (N.m) Drehmoment (N·m)
2413	29,7	16,0	M8x1.25	8,2	12,7	21,9	A4	3.5
2417	29,7	17,6	M8x1.25	8,0	12,7	24,6	A4	3.5

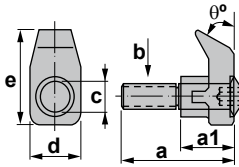

Reference Bezeichnung	a	b	c	d	Wrench Schlüssel	Torque (N.m) Drehmoment (N·m)
2713	8,2	12,7	22,4	5,0	A3	3.0
2717	8,1	12,7	24,6	5,0	A3	3.0

Ceramic tools - Clamps / Keramikwerkzeug-Pratzen

 	Reference Bezeichnung	a	a1	b	c	d	e	θ°	Wrench Schlüssel	Torque (N.m) Drehmoment (N·m)
	2414	29,7	15,1	M8x1.25	8,2	12,7	22,5	20	A4	3.5

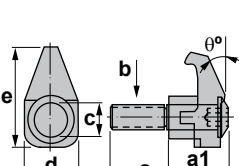
 	Reference Bezeichnung	a	a1	b	c	d	e	θ°	Wrench Schlüssel	Torque (N.m) Drehmoment (N·m)
	2415	29,7	15,7	M8x1.25	8,2	13	25,9	8	A4	3.5
	2428	29,7	15,7	M8x1.25	8,2	13	28,6	7	A4	3.5
	2432	29,7	15,7	M8x1.25	8,2	13	28,6	7	A4	3.5
	2471	29,7	15,7	M8x1.25	8,2	13	25,9	8	A4	3.5

Notch tools - Clamps / "Notch" Werkzeug-Pratzen

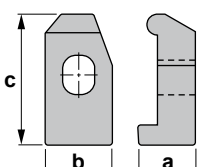
 	Reference Bezeichnung	a	b	c
	TF-146	5,5	9,0	13,7
	TF-72	9,7	11,3	22,0
	TF-74	7,2	9,0	13,7

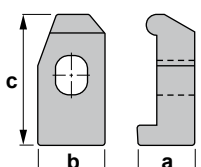
 	Reference Bezeichnung	a	b	c
	TF-147	5,5	9,0	13,7
	TF-73	9,7	11,3	22,0
	TF-75	7,2	9,0	13,7

Shim seat / Unterlegplatten

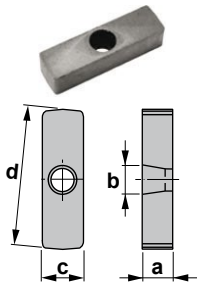

Reference Bezeichnung	a	b	c	d
3521	4,76	4,2	6,3	22,2

Square shim seats / Vierkantige Unterlegplatten

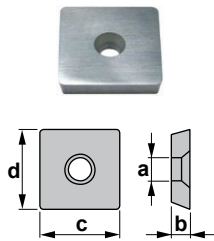

Reference Bezeichnung	a	b	c	d
3109	2,3	3,18	8,14	8,14
3112	2,3	3,18	11,3	11,3
3119	3,3	3,18	17,3	17,3

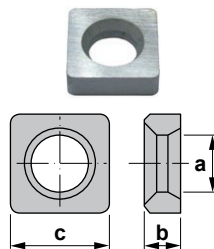

Reference Bezeichnung	a	b	c
3509	4,9	3,18	8,5
3512	6,4	3,18	11,6
3515	7,9	4,76	14,6
3519	9,6	4,76	17,8
3525	12,8	6,35	24,2

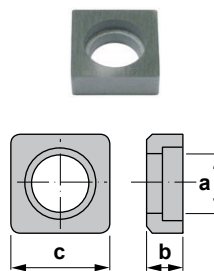

Reference Bezeichnung	a	b	c
3514	6,6	3,96	11,4
ISSN-422	8,0	3,15	12,4
ISSN-432	7,4	4,76	12,4
ISSN-434	7,4	4,76	12,4
ISSN-442	7,4	6,35	12,4
ISSN-454	7,4	7,92	12,4
ISSN-533	9,3	4,76	15,6
ISSN-534	9,6	4,80	15,7
ISSN-633	11,3	4,76	18,8

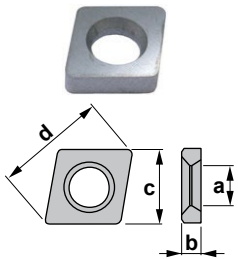

80° Rhombic shim seats / 80° rhombische Unterlegplatten

	Reference Bezeichnung	a	b	c	d
		3609	4,8	3,18	8,5
	3612	6,4	3,18	11,6	17,1
	3616	7,9	4,76	14,6	20,9
	3619	9,6	4,76	17,8	26,0
	3625	12,8	6,35	24,2	36,0

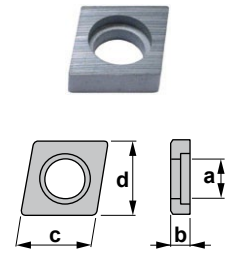
	Reference Bezeichnung	a	b	c	d
		3614	6,5	3,95	11,4
	ICSN-332	6,2	5,00	9,0	9,0
	ICSN-422	7,2	3,00	12,5	12,5
	ICSN-432	7,4	4,76	12,4	12,4
	ICSN-434	7,4	4,76	12,4	12,4
	ICSN-442	7,4	6,35	12,4	12,4
	ICSN-443	7,7	6,40	12,4	12,4
	ICSN-454	7,4	7,94	12,4	12,4
	ICSN-523	9,9	3,18	15,6	15,6
	ICSN-533	9,9	4,76	15,6	15,6
	ICSN-623	11,3	3,18	18,8	18,8
	ICSN-633	11,3	4,76	18,8	18,8

75° Rhombic shim seats / 75° rhombische Unterlegplatten

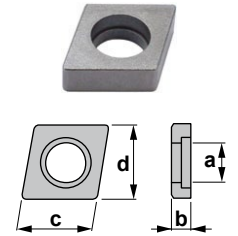
	Reference Bezeichnung	a	b	c	d
		IESN-432	7,4	4,76	12,4

55° Rhombic shim seats / 55° rhombische Unterlegplatten

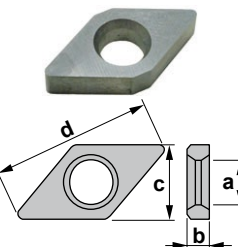
	Reference Bezeichnung	a	b	c	d
		3711	4,9	2,70	8,5
	3715	6,4	3,18	11,6	23,4
	3725	6,5	4,77	11,7	23,4

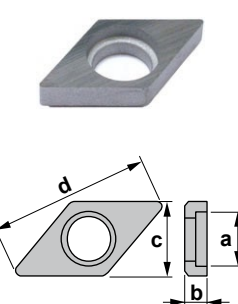
	Reference Bezeichnung	a	b	c	d
		3714	6,6	3,18	8,50
	IDSN-322	6,4	3,18	9,39	18,2
	IDSN-334	6,8	4,76	9,95	17,8
	IDSN-354	6,8	7,92	9,95	17,8
	IDSN-422	8,2	4,76	12,60	25,6
	IDSN-432	8,2	4,76	12,50	25,6
	IDSN-434	8,2	4,76	12,50	23,4



35° Rhombic shim seats / 35° rhombische Unterlegplatten

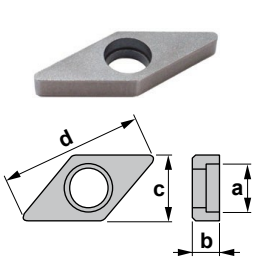

Reference Bezeichnung	a	b	c	d
3718	6,7	3,18	8,4	26,0
3722	8,1	3,97	11,0	27,3
IVSN-322	6,6	3,18	9,4	25,9
IVSN-342	6,6	6,35	9,2	26,9

Round shim seats / Runde Unterlegplatten

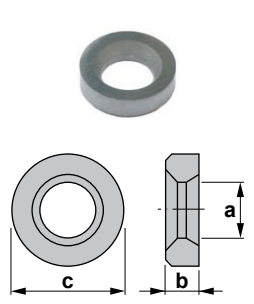

Reference Bezeichnung	a	b	c
3810	4,9	3,18	8,34
3812	4,9	3,18	9,90
3816	6,4	4,76	13,55
3820	8,0	4,76	17,25
3825	9,6	6,35	21,90
3832	12,6	6,35	28,00
3909	4,9	3,18	8,80
3912	6,4	3,18	11,60
3915	8,0	4,76	15,20
3919	9,6	4,76	18,40
3925	12,9	6,35	24,80

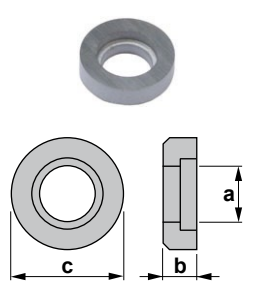

Reference Bezeichnung	a	b	c
3811	5,3	3,18	8,80
3814	5,3	3,18	10,60
IRSN-42	7,4	2,38	12,45
IRSN-43	7,4	4,76	12,45
IRSN-44	7,3	6,40	12,45
IRSN-45	7,4	7,92	12,45
IRSN-53	9,8	4,76	15,60
IRSN-63	11,3	4,76	18,80
IRSN-84	14,5	6,35	25,15

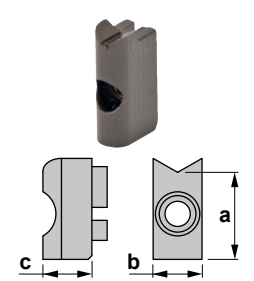

Reference Bezeichnung	a	b	c
3806	13,95	5,0	8,6
3807	15,55	5,0	8,6
3808	17,15	5,0	8,6
3849	13,75	7,7	7,7
3852	15,20	11,1	10,8

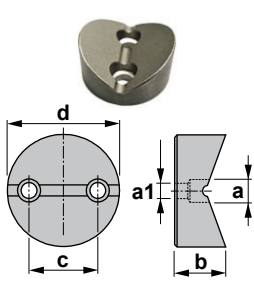

Reference Bezeichnung	a	a1	b	c	d
3817	4,5	3	7,75	7,0	13,55
3819	4,5	3	8,51	8,4	16,55
3835	4,5	3	10,04	13,5	22,00

Triangular shim seats / Dreikantige Unterlegplatten

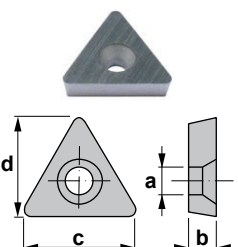
	Reference Bezeichnung	a	b	c	d
		3116	2,3	3,18	13,03
	3122	3,3	3,18	17,19	15,1

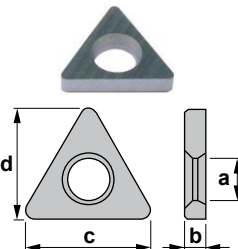
	Reference Bezeichnung	a	b	c	d
		3416	4,9	2,76	13,52
	3422	6,3	3,18	18,92	16,6
	3427	8,0	4,76	24,60	24,6
	3433	9,8	4,76	28,50	27,8

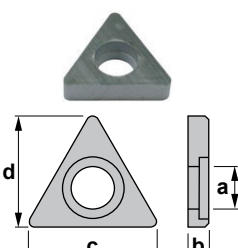
	Reference Bezeichnung	a	b	c	d
		3414	5,30	3,18	13,55
	ITSN-322	5,90	3,18	14,60	12,9
	ITSN-324	5,70	3,30	14,25	12,8
	ITSN-342	5,90	6,35	14,90	13,1
	ITSN-433	7,40	4,76	19,70	17,3
	ITSN-443	7,65	6,35	20,20	17,8

Shim seats for threading / Unterlegplatten für Gewindedrehwerkzeuge

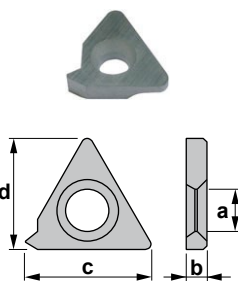
	Reference Bezeichnung	a	b	c	d
		3424+1°	3,95	3,2	12,8
	3424+2°	3,95	3,2	12,8	12,8
	3424+3°	3,95	3,2	12,8	12,8
	3424-1°	3,95	3,2	12,8	12,8
	3424-2°	3,95	3,2	12,8	12,8
	3424-3°	3,95	3,2	12,8	12,8
	YE3	3,95	3,2	12,7	12,4
	YE4	5,30	4,0	17,3	17,3
	YE5	6,30	5,8	23,6	22,3

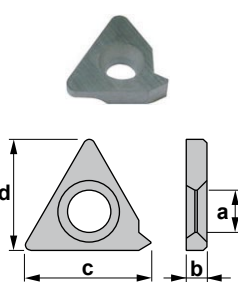
	Reference Bezeichnung	a	b	c	d
		3425+1°	3,95	3,2	12,8
	3425+2°	3,95	3,2	12,8	12,8
	3425+3°	3,95	3,2	12,8	12,8
	3425-1°	3,95	3,2	12,8	12,8
	3425-2°	3,95	3,2	12,8	12,8
	3425-3°	3,95	3,2	12,8	12,8
	YI3	3,95	3,2	12,8	12,8
	YI4	5,30	4,0	17,3	17,3
	YI5	6,30	5,8	23,6	22,3

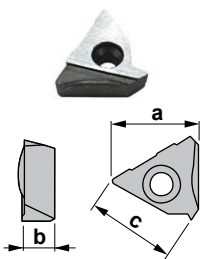

Threading shim seats / Unterlegplatten für Gewindedrehwerkzeuge

	Reference Bezeichnung	a	b	c
	3126R	12,8	4,76	11,2
3132R	16,9	4,76	14,0	

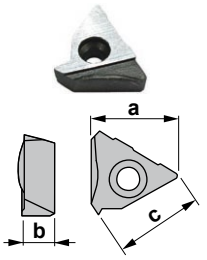
	Reference Bezeichnung	a	b	c
	3132L	16,9	4,76	14,0

Trigon shim seats / Trigon Unterlegplatten

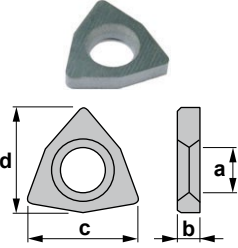
	Reference Bezeichnung	a	b	c	d
	3007	4,9	3,18	11,3	10,8
3008	6,4	3,18	15,8	15,2	

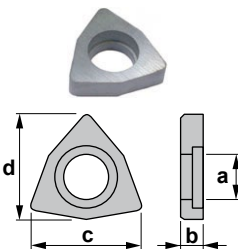
	Reference Bezeichnung	a	b	c	d
	3006	5,1	3,18	11,3	10,8
IWSN-322	5,7	3,18	11,9	11,4	
IWSN-433	7,3	4,76	16,0	15,3	

KNUX - Shim seats / KNUX - Unterlegplatten

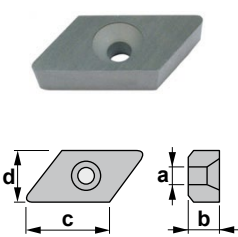
	Reference Bezeichnung	a	b	c	d
	3226	3,3	4,76	14,5	9,25

KNUX - Shim seats / KNUX - Unterlegplatten

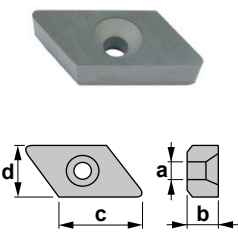
	Reference Bezeichnung	a	b	c	d
	3236	3,3	4,76	14,5	9,25

Seats / Kassetten

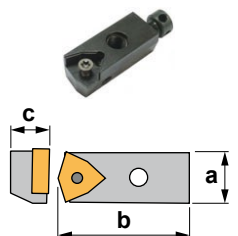
	Reference Bezeichnung	a	b	c
	6806	12,8	32	10,7

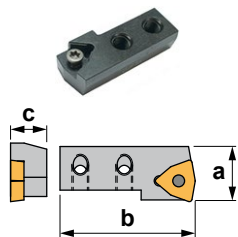
	Reference Bezeichnung	a	b	c
	6816	16,3	40	10,7

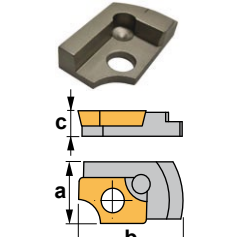
	Reference Bezeichnung	a	b	c
	6925	12,7	22	4,8

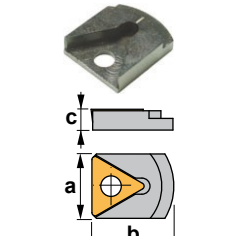
	Reference Bezeichnung	a	b	c
	6926	16	19,5	4,8



Levers / Kniehebel

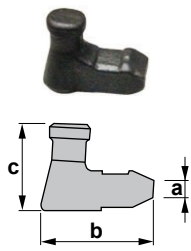

Reference Bezeichnung	a	b	c
8005	2,3	10,1	7,8

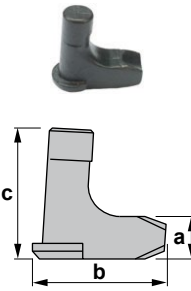

Reference Bezeichnung	a	b	c
8009	3,4	10,2	12,0
8012	4,2	13,5	13,1
8015	5,3	19,2	17,2
8016	5,4	16,5	17,1
8019	8,2	20,6	21,0
8025	8,2	25,7	25,2

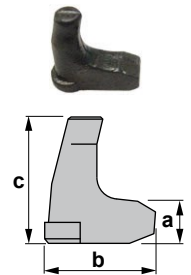

Reference Bezeichnung	a	b	c
8110	4,0	11,0	11,6
8112	4,2	13,0	13,1
8120	6,8	20,4	18,4
8125	7,6	23,7	22,9
8132	9,0	30,2	26,7

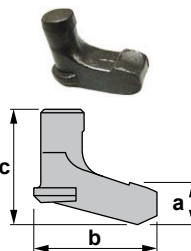

Reference Bezeichnung	a	b	c
8212	4,7	13,4	12,1
8219	7,2	20,5	20,2

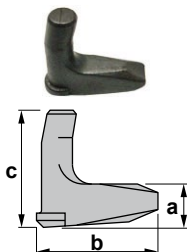

Reference Bezeichnung	a	b	c
8116	6,7	18,6	17,7
8312	4,2	13,5	13,2

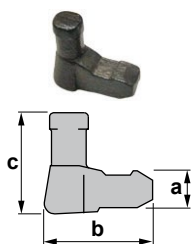

Reference Bezeichnung	a	b	c
8216	3,4	10,1	9,5

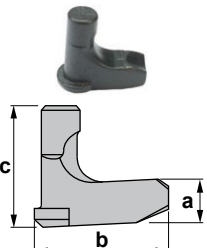
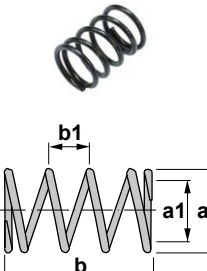
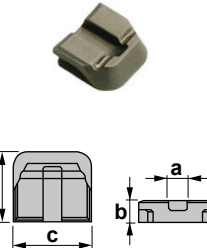
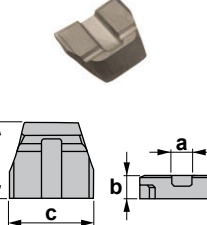
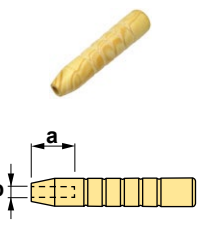
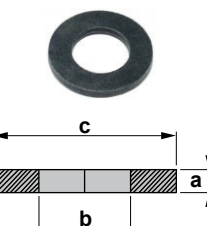

Levers and others / Kniehebel und Andere

	Reference Bezeichnung	a	b	c	
	8415	5,9	16,2	14,7	
	Reference Bezeichnung	a	a1	b	b1
	4294	6,9	5,3	12,5	2,5
	4295	9,5	7,0	16,5	3,5
	Reference Bezeichnung	a	b	c	d
	9414	2,6	2	12,6	11
	Reference Bezeichnung	a	b	c	d
	9416	3	3,5	12,6	11
	Reference Bezeichnung	a	b		
	0009	15	4,0		
	0012	15	5,0		
	0015	15	6,3		
	0019	12	8,5		
	0025	14	12,0		
	Reference Bezeichnung	a	b	c	
	2803	0,5	3,2	6,8	
	2804	0,8	4,3	9,0	
	2806	1,5	6,4	12,0	
	2808	1,6	8,4	16,0	
	2810	2,5	10,5	21,0	

Others / Andere

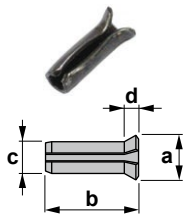

Reference Bezeichnung	a	b	c	d
4002	2,7	10	2,1	1,1
4012	3,6	10	3,0	1,5
4022	4,5	10	4,0	1,5

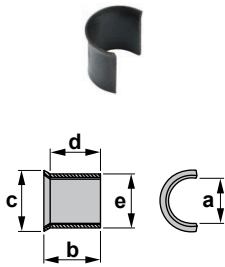

Reference Bezeichnung	a	b	c	d	e
4109	4,4	5,2	5,7	4,6	4,9
4110	4,4	6,8	5,6	6,1	4,9
4112	5,5	5,9	7,0	5,2	6,6
4115	7,0	9,2	9,0	7,7	8,2
4116	5,4	9,2	6,8	8,5	6,5
4119	8,5	11,3	10,5	9,8	9,7
4125	10,0	11,9	15,2	9,7	13,2
4129	8,3	9,2	10,5	8,4	9,8
4133	8,3	9,2	10,4	8,4	9,8
4135	5,5	7,7	7,2	6,8	6,6

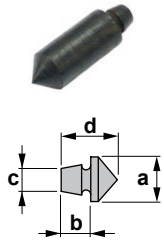

Reference Bezeichnung	a	b	c	d
4201	4,8	3,1	2,5	5,9
4202	4,8	3,1	2,5	8,1
4203	4,8	3,1	2,5	12,5
4204	4,8	3,1	2,5	14,5

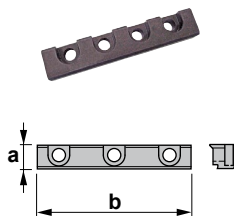

Reference Bezeichnung	a	b
2916	10,0	64
2920	16,2	75
2930	19,3	84
2935	19,3	94
2942	19,3	104
2950	21,0	110



Wrenches (Allen) / Schlüssel (Imbus)

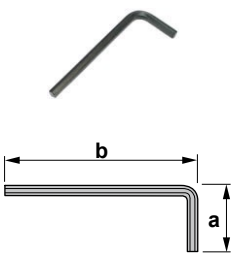

Reference Bezeichnung	a	b	Wrench Schlüssel	Torque (N.m) Drehmoment (N·m)
5002	18,0	51,5	A2	1.4
5003	22,2	64,4	A3	3.0
5004	27,6	72,6	A4	3.5
5005	32,0	83,0	A5	4.0
5006	37,0	96,0	A6	-
5015	14,4	45,5	A1.5	0.6
5025	19,0	57,3	A2.5	2.0

Wrenches (Torx) / Schlüssel (Torx)

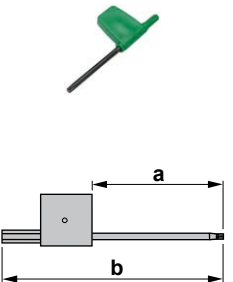

Reference Bezeichnung	a	b	Wrench Schlüssel	Torque (N.m) Drehmoment (N·m)
5506	34,5	62,0	T6	0.6
5507	35,0	63,0	T7	0.9
5508	44,0	72,0	T8	1.2
5509	38,0	74,0	T9	1.4
5510	38,0	74,0	T10	2.0
5515	45,5	82,5	T15	3.0
5516	42,7	86,7	T15 / A3.5	3.0 / -
5517	45,7	95,7	T15 / A4	3.0 / 3.5
5520	45,9	80,0	T20	4.0
5525	53,0	92,0	T25	5.0

Wrenches for blades / Schlüssel (Stechschwerter)

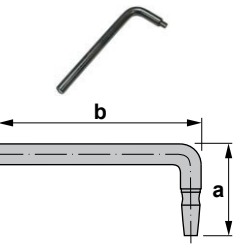

Reference Bezeichnung	a	b
5732	27,5	81

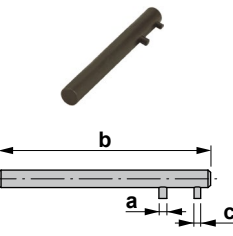

Reference Bezeichnung	a	b	c
5735	3	80	2,5

Screws (Allen) / Schrauben (Imbus)

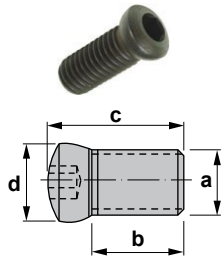

Reference Bezeichnung	a	b	c	d	θ°	Wrench Schlüssel	Torque (N.m) Drehmoment (N·m)
1004	M4x0.7	6,8	10,0	5,6	-	A2	1.4
1005	M5x0.8	8,7	12,0	6,8	-	A2.5	2.0
1006	M6x1	11,2	17,0	9,0	-	A4	3.5
1006L	M6x1L	11,2	17,0	9,0	-	A4	3.5
1008	M8x1.25	16,6	22,0	11,0	-	A5	4.0
1016	M6x1	6,6	12,4	9,0	-	A4	3.5

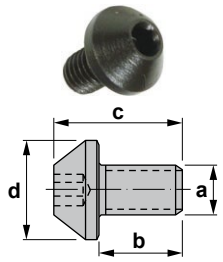

Reference Bezeichnung	a	b	c	d	θ°	Wrench Schlüssel	Torque (N.m) Drehmoment (N·m)
1025	M5x0.8	8,0	12,5	9,8	-	A3	3.0

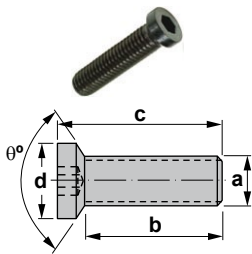

Reference Bezeichnung	a	b	c	d	θ°	Wrench Schlüssel	Torque (N.m) Drehmoment (N·m)
1058	M8x1.25	29,0	35,0	11,0	45	A5	4.0
1175	M5x0.8	9,7	14,7	8,6	88	A4	3.5

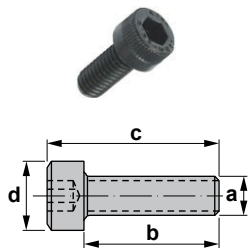

Reference Bezeichnung	a	b	c	d	θ°	Wrench Schlüssel	Torque (N.m) Drehmoment (N·m)
1076	M6x1	30,0	36,0	10,0	-	A5	4.0
1095	M5x0.8	8,2	11,8	8,4	-	A4	3.5
1195	M5x0.8	6,0	10,8	8,3	-	A4	3.5
1296	M6x1	10,0	14,0	9,8	-	A5	4.0
1396	M6x1	16,0	21,9	9,75	-	A5	4.0
912.10	M10x1.5	25,0	35,0	16,0	-	A8	-
912.11	M10	25,0	31,0	16,0	-	A7	-
912.12	M12x1.7	30,0	42,0	18,0	-	A10	-
912.16	M16x2	35,0	51,0	24,0	-	A14	-
912.17	M16x2	35,0	44,0	24,0	-	A12	-
912.20	M20x2.5	39,5	51,0	30,0	-	A14	-
912.52	M12	50,0	62,0	18,0	-	A10	-
912.56	M16x2	47,0	63,0	24,0	-	A14	-



Screws (Torx) / Schrauben (Torx)

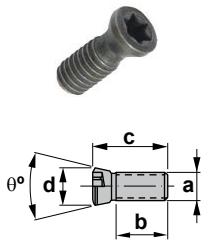

Reference Bezeichnung	a	b	c	d	θ°	Wrench Schlüssel	Torque (N.m) Drehmoment (N-m)
1182	M8x1	9,5	13,5	10,5	60	T25	5.0
1222	M2.2x0.45	3,5	6,0	3,3	55	T6	0.6
1225	M2.5x0.45	4,0	7,0	3,3	55	T7	0.9
1230	M3x0.5	5,6	9,0	4,4	55	T8	1.2
1235	M3.5	6,5	9,5	5,3	55	T15	3.0
1240	M4x0.7	6,2	11,0	5,3	55	T15	3.0
1240-IP	M4x0.7	6,5	10,0	5,3	60	T15-IP	3.5
1244	M4x0.7	8,0	12,0	7,0	55	T20	4.0
1245	M4.5x0.75	7,4	11,4	6,4	55	T15	3.0
1250	M5x0.8	6,0	12,0	7,0	55	T20	4.0
1261	M6x1	8,5	13,0	7,9	55	T25	5.0
1335	M3.5x0.6	10,2	15,0	5,3	55	T15	3.0
1425	M2.5x0.45	3,0	5,5	3,3	55	T7	0.9
1430	M3x0.5	2,8	5,8	4,4	55	T8	1.2
1430-IP	M3x0.5	4,0	6,7	3,9	60	T10-IP	2.5
1435	M3.5	3,1	7,0	5,3	55	T15	3.0
1440	M4x0.7	3,2	7,5	5,3	55	T15	3.0
1440-IP	M4x0.7	4,2	8,0	5,3	60	T15-IP	3.5
1445	M4.5x0.75	5,4	9,0	6,3	55	T15	3.0
1550	M5x0.8	5,9	11,0	6,4	43	T20	4.0
1622	M2.2x0.45	4,0	6,0	3,4	60	T7	0.9
1625	M2.5x0.45	3,6	6,5	3,8	60	T8	1.2
1630	M3x0.5	5,2	8,3	4,3	60	T9	1.4
1635	M3.5x0.6	5,5	9,0	4,7	60	T10	2.0
1640	M4	7,0	10,5	5,5	60	T15	3.0
1840	M4	3,2	7,5	5,0	40	T15	3.0
1845	M4.5x0.75	6,9	9,0	6,5	90	T15	3.0
1846	M4.5x0.75	6,5	11,2	6,5	90	T15	3.0
1847	M4.5x0.75	8,0	11,0	6,7	90	T15	3.0
1908	M8x1	13,0	20,0	10,4	60	T15	3.0
1910	M10x2.5	17,5	25,0	15,0	60	T15	3.0

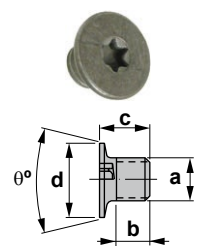

Reference Bezeichnung	a	b	c	d	θ°	Wrench Schlüssel	Torque (N.m) Drehmoment (N-m)
1735	M3.5	1,0	3,0	5,2	90	T7	0.9
1745	M4.5x0.75	3,8	5,2	6,7	100	T15	3.0
1835	M3.5x0.6	2,0	4,0	5,2	90	T7	0.9

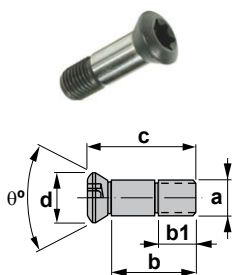

Reference Bezeichnung	a	b	b1	c	d	θ°	Wrench Schlüssel	Torque (N.m) Drehmoment (N-m)
1353	M3x0.35	6,0	2,8	7,9	3,7	40	T8	1.2
1354	M3.5x0.6	7,2	3,7	9,6	4,7	40	T10	2.0
1359	M4x0.5	6,8	3,2	8,8	5,8	62	T15	3.0
1509	M5x0.5	7,9	3,6	9,5	6,7	62	T20	4.0
1519	M5x0.5	10,0	4,5	12,8	7,5	62	T20	4.0
1529	M5x0.5	12,7	4,7	15,5	7,5	62	T20	4.0
1609	M6x0.75	17,6	7,1	20,6	9,5	62	T30	7.0
1619	M4x0.7	10,4	5,6	13,6	5,7	42	T15	3.0
1629	M5x0.8	13,5	6,0	16,8	6,9	40	T20	4.0
1649	M8x1	21,2	8,0	26,4	11,9	60	T30	7.0
1809	M8x0.75	21,5	8,8	26,2	11,9	62	T30	7.0



Screws (Torx) / Schrauben (Torx)

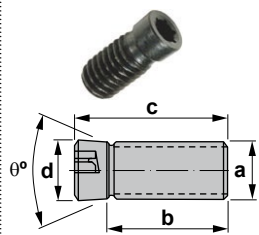

Reference Bezeichnung	a	b	c	d	θ°	Wrench Schlüssel	Torque (N.m) Drehmoment (N-m)
1460	M6x1	8,7	13,6	6,3	120	T20	4.0

Clamp screws / Schrauben für Pratzen

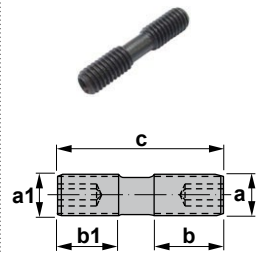

Reference Bezeichnung	a	a1	b	b1	c	Wrench Schlüssel	Torque (N.m) Drehmoment (N-m)
1066	M6x1R	M6x1L	8,0	9,0	21	T15	3.0
1077	M7x0.75R	M7x0.75L	7,5	7,5	18	T20	4.0
1088	M8x1.25R	M8x1.25L	10,0	10,0	24	A4	3.5
1166	M6x1R	M6x1L	4,5	4,5	13	T15	3.0
1188	M8x1R	M8x1L	7,0	7,2	18	A4	3.5
1266	M6x1R	M6x1L	6,0	6,0	16	T15	3.0
1888	M8x1R	M8x1L	9,5	9,5	22	A4	3.5

Set screws / Schrauben

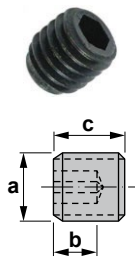

Reference Bezeichnung	a	b	c	Wrench Schlüssel	Torque (N.m) Drehmoment (N-m)
1503	M3x0.5	2,0	4	A1.5	0.6
1504	M4x0.7	2,0	4	A2	1.4
1505	M5x0.8	3,0	5	A2.5	2.0
1506	M6x1	4,0	5	A3	3.0
1508	M8x1.25	5,0	8	A4	3.5
1515	M5x0.8	4,0	8	A4	3.5
1517	M5x0.8	3,5	12	A2.5	2.0
1518	M5x0.8	3,5	16	A2.5	2.0
1534	M4x0.7	3,5	8	A2	1.4

Adjustable screws / Verstellbare Schrauben

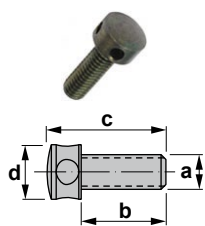

Reference Bezeichnung	a	b	c	d	Wrench Schlüssel	Torque (N.m) Drehmoment (N-m)
1405	M5x0.8	10,5	16,5	9	A2	1.4

Washers / Unterlegscheiben

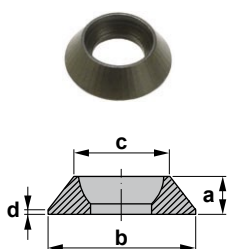

Reference Bezeichnung	a	b	c	d
2009	3,0	9	6,2	0,4
2010	3,2	10	7,2	0,6
2054	3,7	14	7,2	0,6
2063	4,2	14	10,2	0,6
2064	4,2	14	10,2	0,6
2066	4,2	16	10,2	0,6
2088	5,2	18	12,2	1,4

Square shim seats / Vierkantige Unterlegplatten

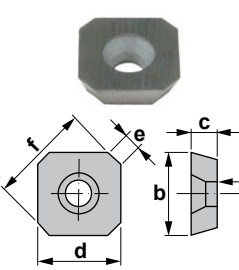
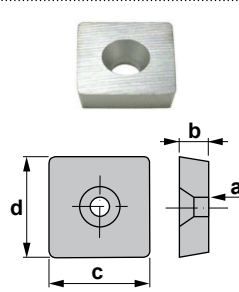
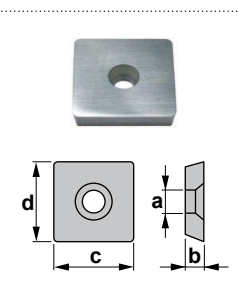
	Reference Bezeichnung	a	b	c	d	e	f
	3010	3,2	10,35	3,18	10,3	2,44	12
	Reference Bezeichnung	a	b	c	d		
	3012	3,3	3,18	11,2	11,2		
	Reference Bezeichnung	a	b	c	d		
	3212	3,3	3,18	12,5	12,5		

Triangular shim seats / Dreieckige Unterlegplatten

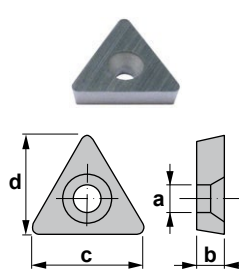
	Reference Bezeichnung	a	b	c	d
	3016	3,3	3,18	13,00	11,5
	3022	4,3	3,18	17,19	15,1

Wedges and seats / Keile und Kassetten

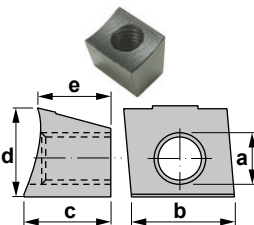
	Reference Bezeichnung	a	b	c	d	e
	6031	M6x1L	13,0	6,0	8,3	4,8
	6032	M6x1L	13,0	6,0	8,5	4,8
	6055	M8x1L	14,6	10,0	13,5	10,0
	6434	M7x0.75L	15,0	10,0	11,8	10,0
	6437	M7x0.75L	13,8	8,5	11,8	8,5

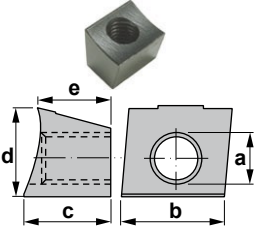
	Reference Bezeichnung	a	b	c	d	e
	6432	M7x0.75L	12,3	8,5	14,0	8,5
	6433	M7x0.75L	15,0	8,5	11,8	8,5
	6488	M7x0.75L	12,0	8,0	12,4	8,0
	6490	M7x0.75L	10,7	8,0	11,9	8,0

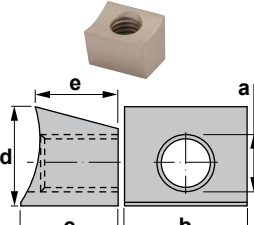
	Reference Bezeichnung	a	b	c	d	e
	6112	M6x1L	10,2	10,0	10,2	8,5
	6113	M8x1L	13,2	10,5	13,0	8,5

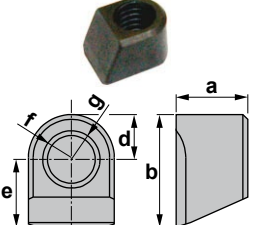
	Reference Bezeichnung	a	b	c	d	e	f	g
	6226	7,5	11,8	9	4,7	7,1	R4,5	M6

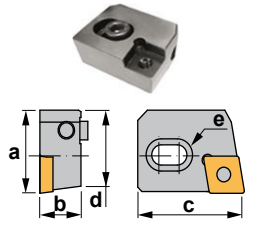
	Reference Bezeichnung	a	b	c	d	e
	6412	27,8	15,3	38,2	25,9	R5.5

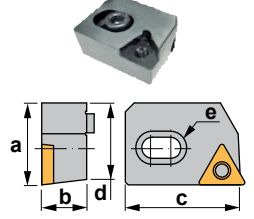
	Reference Bezeichnung	a	b	c	d	e
	6416	27,8	17,5	38,5	25,9	R5.5

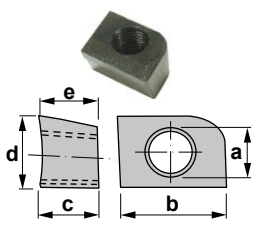
	Reference Bezeichnung	a	b	c	d	e
	6435	M7x0.75L	15,0	8,5	11,8	8,5

Seats and cartridges / Kassetten

	Reference Bezeichnung	a	b	c	d	e
	6436	M7x0.75L	15,5	10,0	11,8	10,0
	6438	M7x0.75L	18,0	8,5	11,8	8,5
	6489	M7x0.75L	21,8	8,0	12,5	8,0
	6491	M7x0.75L	21,0	8,0	12,6	8,0
	Reference Bezeichnung	a	b	c		
	6230	15	40	8,3		
	Reference Bezeichnung	a	b	c		
	6232	15	40	8,3		
	Reference Bezeichnung	a	b	c		
	6255	15	40	8,3		
	Reference Bezeichnung	a	b	c		
	6742	15	40	8,3		
	Reference Bezeichnung	a	b	c		
	6748	15	40	8,3		
	Reference Bezeichnung	a	b	c		
	6845	15	40	8,3		
	6846	15	40	8,3		

Seats and cartridges / Kassetten

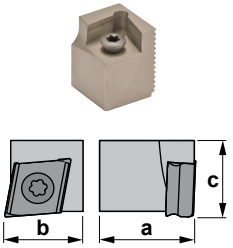
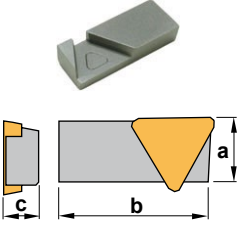
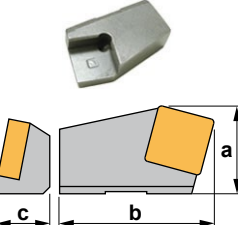
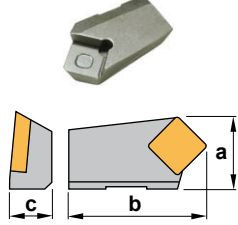
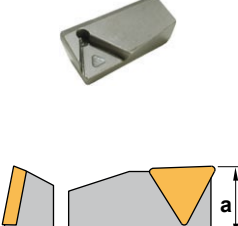
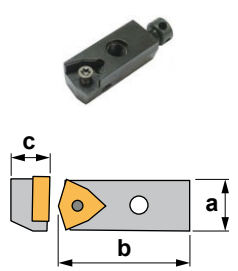
	Reference Bezeichnung	a	b	c
	6938	17,5	14	13,0
	6939	17,5	14	13,0
	6940	19,0	18	16,2
	6941	19,0	18	16,2
	Reference Bezeichnung	a	b	c
	6526	11,5	27	5,93
	Reference Bezeichnung	a	b	c
	6912	18,9	33,2	12
	6914	19,0	32,6	12
	Reference Bezeichnung	a	b	c
	6918	19,2	35	11,2
	6920	20,6	35	11,3
	Reference Bezeichnung	a	b	c
	6927	15,5	33,2	11,8
	6942	18,1	31,2	12,5
	Reference Bezeichnung	a	b	c
	6806	12,8	32	10,7

Seats and cartridges / Kassetten

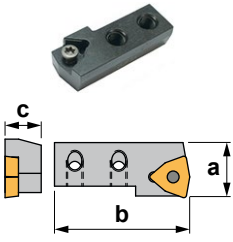
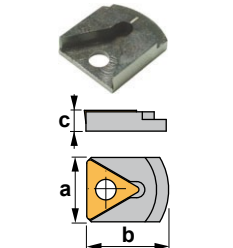
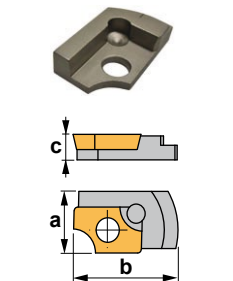
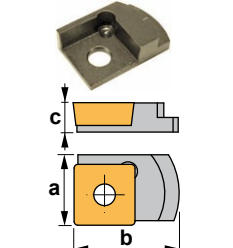
	Reference Bezeichnung	a	b	c
	6816	16,3	40	10,7
	Reference Bezeichnung	a	b	c
	6921	11	12,9	2,9
	6926	16	19,5	4,8
	Reference Bezeichnung	a	b	c
	6925	12,7	22	4,8
	Reference Bezeichnung	a	b	c
	6944	14,3	21,7	5,9



Wrenches (Allen) / Schlüssel (Imbus)

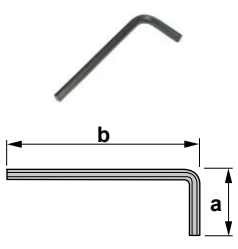

Reference Bezeichnung	a	b	Wrench Schlüssel	Torque (N.m) Drehmoment (N·m)
5002	18,0	51,5	A2	1.4
5003	22,2	64,4	A3	3.0
5004	27,6	72,6	A4	3.5
5005	32,0	83,0	A5	4.0
5006	37,0	96,0	A6	-
5015	14,4	45,5	A1.5	0.6
5025	19,0	57,3	A2.5	2.0

Wrenches (Torx) / Schlüssel (Torx)

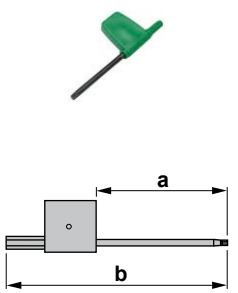

Reference Bezeichnung	a	b	Wrench Schlüssel	Torque (N.m) Drehmoment (N·m)
5506	34,5	62,0	T6	0.6
5507	35,0	63,0	T7	0.9
5508	44,0	72,0	T8	1.2
5509	38,0	74,0	T9	1.4
5510	38,0	74,0	T10	2.0
5510-IP	38,0	74,0	T10-IP	2.5
5515	45,5	82,5	T15	3.0
5515-IP	45,5	82,5	T15-IP	3.5
5520	45,9	80,0	T20	4.0
5525	53,0	92,0	T25	5.0

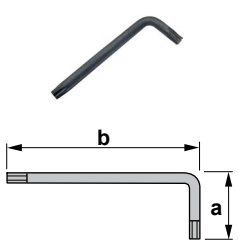

Reference Bezeichnung	a	b	Wrench Schlüssel	Torque (N.m) Drehmoment (N·m)
5530	27,6	77,6	T30	7.0

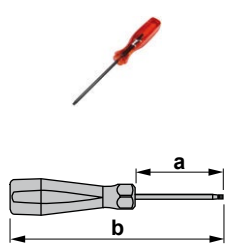

Reference Bezeichnung	a	b	Wrench Schlüssel	Torque (N.m) Drehmoment (N·m)
5607	50,8	129,3	T7	0.9
5608	59,0	136,0	T8	1.2
5610	79,2	177,0	T10	2.0
5615	66,6	99,0	T15	3.0
5620	100,0	207,7	T20	4.0
5625	100,0	208,0	T25	5.0

Wrenches for blades / Schlüssel (Stechschwerter)

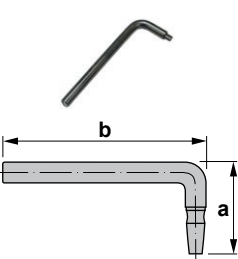

Reference Bezeichnung	a	b
5732	27,5	81

TECHNICAL INFORMATION TECHNISCHE AUSKÜNFTE

Reference list of materials Werkstoffliste	K02-07
Alphanumeric index Alphanumerischer Inhalt	K08-15
General information Allgemeine Auskunft	K16
Safety regulations Sicherheitsvorschriften	K17-18

Reference list of materials (Steels)
Werkstoffliste (Stähle)

ISO	Germany Deutschland		U.S.A	Japan	Spain Spanien	U.K.		Sweden Schweden	France Frankreich	Italy Italien
	W.-nr.	DIN	AISI/SAE	JIS	UNE	BS	EN	SS	AFNOR	UNI
P Unalloyed steel Unlegierter Stahl	1.0038	RSt.37-2	A570.36	STKM 12A;C	-	4360 40 C	-	1311	E 24-2 Ne	-
	1.0038	GS-CK16	1115	-	-	030A04	1A	1325	-	-
	1.0116	St.37-3	A573-81 65	-	F.111	4360 40 B	-	1312	E 24-U	Fe37-3
	1.0401	C15	1015	-	F.112	080M15	-	1350	CC12	C15C16
	1.0402	C22	1020	-	11SMn28	050A20	2C/2D	1450	CC20	C20C21
	1.0715	9SMn28	1213	SUM22	11SMnPb28	230M07	-	1912	S250	CF9SMn28
	1.0718	9SMnPb28	12L13	SUM22L	10SPb20	-	-	1914	S250Pb	CF9SMnPb28
	1.0722	10SPb20	-	-	12SMn35	-	-	-	10PbF2	CF10Pb20
	1.0736	9SMn36	1215	-	12SMnPb36	240M07	1B	-	S300	CF9SMn36
	1.0737	9SMnPb36	12L14	-	C15K	-	-	1926	S300Pb	CF9MnPb36
	1.1141	Ck15	1015	S15C	-	080M15	32C	1370	XC12	C16
	1.1158	Ck25	1025	S25C	-	-	-	-	-	-
	1.8900	StE 380	A572-60	-	-	4360 55 E	-	2145	-	FeE390KG
	-	17 MnV 6	A572-60	-	-	4360 55 E	-	2142	NFA 35-501 E36	-
	1.0501	C35	1035	-	F.113	060A35	-	1550	CC35	C35
	1.0503	C45	1045	-	F.114	080M46	-	1650	CC45	C45
	1.0726	35S20	1140	-	F210G	212M36	8M	1657	35MF4	-
	1.1157	40Mn4	1039	-	-	150M36	15	-	35M5	-
	1.1167	36Mn5	1335	SMn438(H)	36Mn5	-	-	2120	40M5	-
	1.1170	28Mn6	1330	SCMn1	-	150M28	14A	-	20M5	C28Mn
	1.1183	Cf35	1035	S35C	-	060A35	-	1572	XC38TS	C36
	1.1191	Ck45	1045	S45C	C45K	080M46	-	1672	CX42	C45
	1.1213	Cf53	1050	S50C	-	060A52	-	1674	XC48TS	C53
	1.0535	C55	1055	-	-	070M55	-	1655	-	C55
	1.0601	C60	1060	-	-	080A62	43D	-	CC55	C60
	1.1203	Ck55	1055	S55c	C55K	070M55	-	-	XC55	C50
	1.1221	Ck60	1060	S58C	-	080A62	43D	1678	XC60	C60
	1.1274	CK 101	1095	-	F-5117	060A96	-	1870	XC100	-
	1.1545	C105W1	W 1	SK 3	F-5118	BW1A	-	1880	Y105	C36KU
	1.1545	C105W1	W210	SUP4	F.515	BW2	-	2900	Y120	C120KU
P Low alloyed steel Niedriglegierter Stahl	1.0144	St.44-2	A573-81	SM400A;B;C	-	4360 43C	-	1412	E28-3	-
	1.0570	St.52-3	-	SM490A;B;YA;YB	-	4360 50B	-	2132	E36-3	Fe52BFN/Fe52CFN
	1.0841	St.52-3	5120	-	F-431	150 M 19	-	2172	20 MC 5	Fe52
	1.0904	55Si7	9255	-	56Si7	250A53	45	2085	55S7	55Si8
	1.0961	60SiCr7	9262	-	60SiCr8	-	-	-	60SC7	60SiCr8
	1.3505	100Cr	52100	SUJ2	F.131	534A99	31	2258	100C6	100Cr6
	1.5415	15Mo3	ASTM A204Gr.A	-	16Mo3	1501-240	-	2912	15D3	16Mo3KW
	1.5423	16Mo5	4520	-	16Mo5	1503-245-420	-	-	-	16Mo5
	1.5622	14Ni6	ASTM A350LF5	-	15Ni6	-	-	-	16N6	14Ni6
	1.6523	21NiCrMo2	8620	SNCM220(H)	20NiCrMo2	805M20	362	2506	20NCD2	20NiCrMo2
	1.6546	40NiCrMo22	8740	SNCM240	40NiCrMo2	311-Type7	-	-	-	40NiCrMo2(KB)
	1.6587	17CrNiMo6	-	-	14NiCrMo13	820A16	-	-	18NCD6	-
	1.7015	15Cr3	5015	SCr415(H)	-	523M15	-	-	12C3	-
	1.7045	42Cr4	5140	SCr440	42Cr4	-	-	2245	-	-
	1.7176	55Cr3	5155	SUP9(A)	-	527A60	48	-	55C3	-
	1.7262	15CrMo5	-	SCM415(H)	12CrMo4	-	-	2216	12CD4	-
	1.7335	13CrMo4 4	ASTMA182F11;F12	-	14CrMo45	1501-620Gr27	-	-	15CD3.5	14CrMo4 5
	1.7380	10CrMo9 10	ASTMA182F.22	-	TU.H	1501-622Gr31;45	-	2218	12CD9, 10	12CrMo9, 10

Reference list of materials (Steels)
Werkstoffliste (Stähle)

ISO	Germany Deutschland		U.S.A	Japan	Spain Spanien	U.K.		Sweden Schweden	France Frankreich	Italy Italien
	W.-nr.	DIN	AISI/SAE	JIS	UNE	BS	EN	SS	AFNOR	UNI
P Low alloyed steel Niedriglegierter Stahl	1.7715	14MoV6 3	-	-	13MoCrV6	1503-660-440	-	-	-	-
	1.8515	31 CeMo 12	-	-	F-1712	722 M 24	-	2240	-	30CrMo12
	1.8523	39CrMoV13 9	-	-	-	897M39	-	-	30 CD 12	36CrMoV12
	1.7039	34MoCrS4 G	L1	-	-	524A14	40C	2092	-	105WCR 5
	1.5419	20MoCrS4	8620	-	F520.S	605A32	-	2108	-	-
	1.7228	55NiCrMoV6G	-	-	-	823M30	-	2512	-	653M31
	1.7139	16MnCr5	-	-	-	-	33	2127	-	-
	-	31NiCrMo134	-	-	F-1270	830M31	-	2534	-	-
	1.271	50NiCr13	L6	-	F-528	-	-	2550	55NCV6	-
	1.5710	36NiCr6	3135	SNC236	-	640A35	111A	-	35NC6	-
	1.5732	14NiCr10	3415	SNC415(H)	15NiCr11	-	-	-	14NC11	16NiCr11
	1.5752	14NiCr14	3415;3310	SNC815(H)	-	655M13;A12	36A	-	12NC15	-
	1.0904	55Si7	9255	-	-	-	-	2090	55S7	-
	1.6511	36CrNiMo4	9840	-	35NiCrMo4	816M40	110	-	40NCD3	38NiCrMo4(KB)
	1.6582	35CrNiMo6	4340	-	-	817M40	24	2541	35NCD6	35NiCrMo6(KB)
	1.7033	34Cr4	5132	SCr430(H)	35Cr4	530A32	18B	-	32C4	34Cr4(KB)
	1.7035	41Cr4	5140	SCr440(H)	42Cr4	530A40	18	-	42C4	41Cr4
	1.7131	16MnCr5	5115	-	16MnCr5	(527M20)	-	2511	16MC5	16MnCr5
	1.7218	25CrMo4	4130	SCM420;SCM430	55Cr3	1717CDS110	-	2225	25CD4	25CrMo4(KB)
	1.7220	34CrMo4	4137;4135	SCM432;SCCRM3	34CrMo4	708A37	19B	2234	35CD4	35CrMo4
	1.7223	41CrMo4	4140;4142	SCM440	42CrMo4	708M40	19A	2244	42CD4TS	41CrMo4
	1.7225	42CrMo4	4140	SCM440(H)	42CrMo4	708M40	19A	2244	42CD4	42CrMo4
	1.7361	32CrMo12	-	-	F.124.A	722M24	40B	2240	30CD12	32CrMo12
	1.8159	50CrV4	6150	SUP10	51CrV4	735A50	47	2230	50CV4	50CrV4
	1.8509	41CrAlMo7	-	-	41CrAlMo7	905M39	41B	2940	40CAD6,12	41CrAlMo7
	1.2067	100Cr6	L3	-	100Cr6	BL3	-	-	Y100C6	-
	1.2419	105WCr6	-	SKS31,SKS2,SKS3	105WCr5	-	-	2140	105WC13	10WCr6
1.2713	55NiCrMoV6	L6	SKT4	F.520.S	-	-	-	55NCDV7	-	
P High alloyed steel Hochlegierter Stahl	1.5662	X8Ni9	ASTM A353	-	XBNI09	1501-509;510	-	-	-	X10Ni9
	1.5680	12Ni19	2515	-	-	-	-	-	Z18N5	-
	1.6657	14NiCrMo134	-	-	14NiCrMo131	832M13	36C	-	-	15NiCrMo131
	1.2.080	X210Cr12	D3	SKD1	X210Cr12	BD3	-	-	Z200C12	X210Cr13KU
	1.2083	-	-	-	-	-	-	2314	-	X250Cr12KU
	1.2344	X40CrMoV5 1	H13	SKD61	X40CrMoV5	BH13	-	2242	Z40CDV5	X35CrMoV05KU
	1.2363	X100CrMoV5 1	A2	SKD12	X100CrMoV5	BA2	-	2260	Z100CDV5	X40CrMoV511KU
	1.2436	X210CrW12	-	SKD2	X210CrW12	-	-	2312	-	X100CrMoV51KU
	1.2542	45WCrV7	S1	-	45WCrSi8	BS1	-	2710	-	X215CrW12 1KU
	1.2581	X30wCrV9 3	H21	SKD5	X30WCrV9	BH21	-	-	Z30WCV9	45WCrV8KU
	1.2601	X165CrMoV 12	-	-	X160CrMoV12	-	-	2310	-	X28W09KU
	1.4718	X45GrSi93	HW3	SUH1	F322	401S45	52	-	Z45CS9	X160CrMoV12
	1.3343	S6-5-2	D3	SUH3	-	4959BA2	-	2715	Z40CSD10	F322
	1.3343	S6/5/2	M 2	SKH 51	F-5603	BM 2	-	2722	Z 85 WDCV	-
	1.3243	S6/5/2/5	M 35	SKH 55	F-5613	BM 35	-	2723	6-5-2-5	F-5603
	1.3348	S2/9/2	M 7	-	F-5607	-	-	2782	-	F-5607
1.2379	X210Cr12 G	HNV3	-	-	-	-	2736	-	-	
P Steel castings Stahlguss	-	-	-	-	-	-	-	2223	-	-
	1.3401	G-X210Mn12	-	SCMnH/1	X120Mn12	Z120M12	-	-	Z120M12	XG120Mn12
	1.3401	-	-	SEMn H1	F-8251	BW 10	-	2183	2120 M12	Gx120 Mn12

**Reference list of materials (Stainless steels)
Werkstoffliste (Rostfreie Stähle)**

ISO	Germany Deutschland		U.S.A	Japan	Spain Spanien	U.K.		Sweden Schweden	France Frankreich	Italy Italien
	W.-nr.	DIN	AISI/SAE	JIS	UNE	BS	EN	SS	AFNOR	UNI
M Stainless steel (Ferritic / martensitic) Rostfreier Stahl (Ferritisch / Martensitisch)	1.4000	X7Cr13	403	SUS403	F.3110	403S17	-	2301	Z6Cr13	X6Cr13
	1.4001	X7Cr14	-	-	F.8401	-	-	-	-	-
	1.4005	X12CrS13	416	SUS416	F-3411	416 S 21	-	2380	Z11CF13	X12 CrS 13
	1.4016	X8Cr17	430	SUS430	F3113	430S15	960	2320	Z8C17	X8Cr17
	1.4006	X10Cr13	410	SUS410	F.3401	410S21	56A	2302	Z10C14	X12Cr13
	-	X8Cr17	430	SUS430	F.3113	430S17	60	2320	Z8C17	X8Cr17
	1.4034	X46Cr13	-	SUS420J2	F.3405	420S45	56D	2304	Z40CM	X40Cr14
	-	-	-	-	-	-	-	-	Z38C13M	-
	1.4003	-	405	-	-	405S17	-	-	Z8CA12	X6CrAl13
	1.4021	-	420	-	-	420S37	-	2303	Z20C13	X20Cr13
	1.4057	X22CrNi17	431	SUS431	F.3427	431S29	57	2321	Z15CNi6.02	X16CrNi16
	1.4104	X12CrMoS17	430F	SUS430F	F.3117	-	-	2383	Z10CF17	X10CrS17
	1.4113	X6CrMo17	434	SUS434	-	434S17	-	2325	Z8CD17.01	X8CrMo17
	1.4313	X5CrNi13 4	CA6-NM	SCS5	-	425C11	-	2385	Z4CND13.4M	(G)X6CrNi304
	1.4724	X10CrA113	405	SUS405	F.311	403S17	-	-	Z10C13	X10CrA112
	1.4742	X10CrA118	430	SUS430	F.3113	430S15	60	-	Z10CAS18	X8Cr17
	1.4747	X80CrNiSi20	HNV6	SUH4	F.320B	443S65	59	-	Z80CSN20.02	X80CrSiNi20
	1.4762	X10CrA124	446	SUH446	-	-	-	2322	Z10CAS24	X16Cr26
	1.4871	X53CrMnNiN21 9	EV8	SUH35, SUH36	-	349S54	-	-	Z52CMN21.09	X53CrMnNiN219
	1.4521	X1CrMoTi18 2	S44400	-	-	-	-	2326	-	-
1.4922	X20CrMoV12-1	-	-	-	-	-	2317	-	X20CrMoNi 12 01	
1.4542/ 1.4548	-	630	-	-	-	-	-	Z7CNU17-04	-	
M Stainless steel (Austenitic) Rostfreier Stahl (Austenitisch)	1.4306	-	304L	-	-	304S11	-	2352	Z2CrNi18 11	X2CrNi18 11
	1.4350	X5CrNi189	304	SUS304	F.3551	304S31	58E	2332/2333	Z6CN18.09	X5CrNi18 10
	-	-	-	-	F.3541	-	-	-	-	-
	-	-	-	-	F.3504	-	-	-	-	-
	1.4305	X12CrNiS18 8	303	SUS303	F.3508	303S21	58M	2346	Z10CNF 18.09	X10CrNiS 18.09
	1.4301	X5CrNi189	304	SUS304	F.3551	304S15	58E	2332	Z6CN18.09	X5CrNi18 10
	-	-	-	SUS304L	-	304C12	-	2333	Z3CN19.10	-
	1.4306	X2CrNi18 9	304L	SCS19	F.3503	304S12	-	2352	Z2CrNi18 10	X2CrNi18 11
	1.4310	X12CrNi17 7	301	SUS301	F.3517	-	-	2331	Z12CN17.07	X12CrNi17 07
	1.4311	X2CrNiN18 10	304LN	SUS304LN	-	304S62	-	2371	Z2CN18.10	-
	1.4401	X5CrNiMo18 10	316	SUS316	F.3543	316S16	58J	2347	Z6CND17.11	X5CrNiMo17 12
	1.4429	X2CrNiMoN18 13	316LN	SUS316LN	-	-	-	2375	Z2CND17.13	-
	1.4404	-	316L	-	-	316S13	-	2348	Z2CND17-12	X2CrNiMo1712
	1.4435	X2CrNiMo18 12	316L	SCS16	-	316S13	-	2353	Z2CND17.12	X2CrNiMo17 12
	-	-	-	SUS316L	-	-	-	-	-	-
	1.4436	-	316	-	-	316S33	-	2343	Z6CND18-12-03	X8CrNiMo1713
	-	-	-	-	-	-	-	2347	-	-
	1.4438	X2CrNiMo18 16	317L	SUS317L	-	317S12	-	2367	Z2 NCDU25-20	X2CrNiMo18 16
	1.4539	X1NiCrMo	UNS V 0890A	-	-	-	-	2562	Z6CNT18.10	-
	1.4541	X10CrNiTi18 9	321	SUS321	F.3553	321S12	58B	2337	-	X6CrNiTi18 11
-	-	-	-	F.3523	-	-	-	Z6CNNb18.10	-	
1.4550	X10CrNiNb18 9	347	SUS347	F.3552	347S17	58F	2338	-	X6CrNiNb18 11	
-	-	-	-	F.3524	-	-	-	-	-	
1.4571	X10CrNiMoTi18 10	316Ti	-	F.3535	320S17	58J	2350	Z6NDT17.12	X6CrNiMoNb17 13	
1.4583	X10CrNiMoNb 18 12	318	-	-	-	-	-	Z6CNDNb17 13B	-	
1.4828	X15CrNiSi20 12	309	SUH309	-	309S24	-	-	Z15CNS20.12	X6CrNi25 20	

Reference list of materials (Stainless steels)
Werkstoffliste (Rostfreie Stähle)

ISO	Germany Deutschland		U.S.A	Japan	Spain Spanien	U.K.		Sweden Schweden	France Frankreich	Italy Italien
	W.-nr.	DIN	AISI/SAE	JIS	UNE	BS	EN	SS	AFNOR	UNI
M Stainless steel (Austenitic) Rostfreier Stahl (Austenitisch)	1.4845	X12CrNi25 21	310S	SUH310	F.331	310S24	-	2361	Z12CN25 20	-
	1.4406	X10CrNi18.08	308	SCS17	F.8414	301S21	58C	2370	Z1NCUDU25.20	-
	1.4418	X4 CrNiMo16 5	-	-	-	-	-	2387	Z6CND16-04-01	X2CrNiMo1712
	1.4568/ 1.4504	-	17-7PH	-	-	316S111	-	-	Z8CNA17-07	-
	1.4563	-	NO8028	-	-	-	-	2584	Z1NCUDU31-27-03	-
	-	-	S31254	-	-	-	-	2378	Z1CNDU20-18-06AZ	-
M Stainless steel (Austenitic / ferritic (duplex)) Rostfreier Stahl (Austenitisch / Ferritisch (duplex))	1.4417	X2CrNiMoSi19 5	S31500	-	-	-	-	2376	-	-
	-	X8CrNiMo27 5	S32900	-	-	-	-	2324	-	-
	-	X2CrNiN23 4	S322304	-	-	-	-	2327	Z2CN23-04AZ	-
	-	-	-	-	-	-	-	2328	-	-
	-	X2CrNiMoN22 53	S31803	-	-	-	-	2377	Z2CND22-05-03	-

Reference list of materials (Castings)
Werkstoffliste (Stahlguß)

ISO	Germany Deutschland		U.S.A	Japan	Spain Spanien	U.K.		Sweden Schweden	France Frankreich	Italy Italien
	W.-nr.	DIN	AISI/SAE	JIS	UNE	BS	EN	SS	AFNOR	UNI
K Malleable cast iron Temperguß	-	-	-	FCMB310	-	8 290/6	-	0814	MN 32-8	-
	-	GTS-35	32510	FCMW330	-	B 340/12	-	0815	MN 35-10	-
	0.8145	GTS-45	40010	FCMW370	-	P 440/7	-	0852	Mn 450	GMN 45
	0.8155	GTS-55	50005	FCMP490	-	P 510/4	-	0854	MP 50-5	GMN 55
	-	GTS-65	70003	FCMP540	-	P 570/3	-	0858	MP 60-3	-
	0.8165	GTS-65-02	A220-70003	FCMP590	-	P570/3	-	0856	Mn 650-3	GMN 65
	0.8170	GTS-70-02	A220-80002	FCMP690	-	P690/2	-	0862	Mn700-2	GMN 70
K Cast iron Gratguß	-	-	-	-	-	-	-	0100	-	-
	-	GG10	No 20 B	FC100	-	-	-	0110	Ft 10 D	-
	0.6015	GG15	No 25 B	FC150	FG 15	Grade 150	-	0115	Ft 15 D	G 15
	0.6020	GG20	No 30 B	FC200	-	Grade 220	-	0120	Ft 20 D	G 20
	0.6025	GG25	No 35 B	FC250	FG25	Grade 260	-	0125	Ft 25 D	G 25
	-	-	No 40 B	-	-	-	-	-	-	-
	0.6030	GG30	No 45 B	FC300	FG30	Grade 300	-	0130	Ft 30D	G 30
	0.6035	GG35	No 50 B	FC350	FG35	Grade 350	-	0135	Ft 35 D	G 35
	0.6040	GG40	No 55 B	-	-	Grade 400	-	0140	Ft 40 D	-
	0.6660	GGL-NiCr202	A436 Type 2	-	-	L-NiCuCr202	-	0523	L-NC 202	-
K Nodular SG iron Kugelgraphitguß SG	0.7040	GGG 40	60-40-18	FCD400	FGE 38-17	SNG 420/12	-	0717-02	FCS 400-12	GS 370-17
	-	GGG 40.3	-	-	-	SNG 370/17	-	0717-12	FGS 370-17	-
	0.7033	GGG 35.3	-	-	-	-	-	0717-15	-	-
	0.7050	GGG 50	80-55-06	FCD500	FGE 50-7	SNG 500/7	-	0727-02	FGS 500-7	GS 500
	0.7660	GGG-NiCr202	A43D2	-	-	Grade S6	-	0776	S-NC 202	-
	-	GGG 60	-	FCD600	-	SNG 600/3	-	0732-03	FGS 600-3	-
	0.7070	GGG 70	100-70-03	FCD700	FGS 70-2	SNG 700/2	-	0737-01	FGS 700-2	GS 700-2

Reference list of materials (Non ferrous materials)
Werkstoffliste (Nichteisen-Metalle)

ISO	Germany Deutschland		U.S.A	Japan	Spain Spanien	U.K.		Sweden Schweden	France Frankreich	Italy Italien
	W.-nr.	DIN	AISI/SAE	JIS	UNE	BS	EN	SS	AFNOR	UNI
N Non ferrous materials Nichteisen-Metalle	3.2373	G-AISI9MGWA	SC64D	C4BS	-	-	-	4251	A-STG	-
	-	G-ALMG5	GD-AISI12	AC4A	-	LM5	-	4252	A-SU12	-
	-	-	356.1	A5052	-	LM25	-	4244	-	-
	-	GD-AISI12	A413.0	A6061	-	-	-	4247	-	-
	-	GD-AISI8Cu3	A380.1	A7075	-	LM24	-	4250	-	-
	-	G-AISI12(Cu)	A413.1	ADC12	-	LM20	-	4260	-	-
	-	G-AISI12	A413.2	-	-	LM6	-	4261	-	-
	-	G-AISI10Mg(Cu)	A360.2	-	-	LM9	-	4253	-	-



Reference list of materials (Heat resistant super-alloys)
Werkstoffliste (Hitzebeständige Super-Legierungen)

ISO	Germany Deutschland		U.S.A	Japan	Spain Spanien	U.K.		Sweden Schweden	France Frankreich	Italy Italien
	W.-nr.	DIN	AISI/SAE	JIS	UNE	BS	EN	SS	AFNOR	UNI
S Heat resistant super-alloys Hitzebeständige Super-Legierungen	1.4864	X12NiCrSi36 16	330	SUH330	-	-	-	-	Z12NCS35.16	F-3313
	1.4865	G-X40NiCrSi38 18	-	SCH15	-	330C11	-	-	-	XG50NiCr39 19
	2.4603	-	5390A	-	-	-	-	-	NC22FeD	-
	2.4856	NiCr22Mo9Nb	5666	-	-	-	-	-	NC22FeDNB	-
	2.4630	NiCr20Ti	-	-	-	HR5,203-4	-	-	NC20T	-
	LW2.4662	NiFe35Cr14MoTi	5660	-	-	-	-	-	ZSNCDT42	-
	LW2.4670	S-NiCr13A16MoNb	5391	-	-	3146-3	-	-	NC12AD	-
	LW2.4668	NiCr19Fe19NbMo	5383	-	-	HR8	-	-	NC19eNB	-
	2.4375	NiCu30Al	4676	-	-	3072-76	-	-	-	-
	2.4631	NiCr20TiAk	-	-	-	Hr401,601	-	-	NC20TA	-
	2.4973	NiCr19Co11MoTi	AMS 5399	-	-	-	-	-	NC19KDT	-
	LW2.4668	NiCr19Fe19NbMo	AMS 5544	-	-	-	-	-	NC20K14	-
	LW2.4674	NiCo15Cr10MoAlTi	AMS 5397	-	-	-	-	-	-	-
	LW2.4964	CoCr20W15Ni	5537C	-	-	-	-	-	KC20WN	-
	-	CoCr22W14Ni	AMS 5772	-	-	-	-	-	KC22WN	-
S Titanium alloys Titanium-Legierungen	-	TiAl5Sn2.5	AMS R54520	-	-	TA14/17	-	-	T-A5E	-
	-	TiAl6V4	AMS R56400	-	-	TA10-13/TA28	-	-	T-A6V	-
	-	TiAl6V4ELI	AMS R56401	-	-	TA11	-	-	-	-
	-	TiAl4MoSn4Si0.5	-	-	-	-	-	-	-	-

Reference list of materials (Hardened materials)
Werkstoffliste (Gehärtete Materialien)

ISO	Germany Deutschland		U.S.A	Japan	Spain Spanien	U.K.		Sweden Schweden	France Frankreich	Italy Italien
	W.-nr.	DIN	AISI/SAE	JIS	UNE	BS	EN	SS	AFNOR	UNI
H Hardened materials Gehärtete Materialien	1.4108	X100CrMo13	440A	C4BS	-	-	-	-	-	-
	1.4111	X110CrMoV15	610	AC4A	-	-	-	-	-	-
	-	X65CrMo14	0-2	AC4A	-	-	-	-	-	-

Turning inserts
Drehwendeschneidplatten

Reference / Bez.	Page / Seite
ADMT-R	A30
CCGT-AL	A30
CCGT-AP	A31
CCMT	A31
CCMW	A31
CNGP	A32
CNMA	A32
CNMG-CC	A32
CNMG-FC	A32
CNMG-FMC	A32
CNMG-KC	A33
CNMG-MC	A33
CNMG-MFC	A33
CNMG-MHC	A33
CNMG-RC	A33
CNMG-TC	A34
CNMM	A34
DCGT-AL	A35
DCGT-AP	A35
DCMT	A35
DCMW	A35
DNGP	A36
DNMA	A36
DNMG-FC	A36
DNMG-FMC	A36
DNMG-KC	A36
DNMG-MC	A37
DNMG-MFC	A37
DNMG-MHC	A37
DNMG-TC	A37
DNMX	A37
KNUX	A38
RCGT-AL	A38
RCGT-AP	A38
RCMT	A39
RNMG	A39
SCGT-AL	A40
SCMT	A40
SCMT-39	A40
SCMW	A40
SNMG-FMC	A41
SNMG-KC	A41
SNMG-MHC	A41
SNMG-RC	A41
SNMG-TC	A42
SNMM	A42
SPMR	A43
SPUN	A43
TCGT-AL	A44
TCMT	A44
TCMW	A44
TNMA	A45
TNMG-CC	A45
TNMG-FC	A45

Turning inserts
Drehwendeschneidplatten

Reference / Bez.	Page / Seite
TNMG-FMC	A45
TNMG-KC	A45
TNMG-MC	A46
TNMG-MFC	A46
TNMG-MHC	A46
TNMG-TC	A46
TNMX	A46
TPMN	A47
TPMR	A47
TPUN	A47
TPUX	A47
VBMT	A48
VCGT-AL	A48
VCGT-AP	A48
VCMT	A48
VNGP	A49
VNMG	A49
VNMG-TC	A49
WNMA	A50
WNMG-FC	A50
WNMG-FMC	A50
WNMG-KC	A50
WNMG-MC	A50
WNMG-MFC	A51
WNMG-MHC	A51
WNMG-TC	A51

Ceramic inserts
Keramik-Wendepplatten

Reference / Bez.	Page / Seite
CNGA	A54
CNGN	A54
CNGX	A54
DNGA	A54
DNGN	A54
DNGX	A55
GWG	A55
RCGX	A55
RNGN	A55
RPGN	A56
SNGA	A56
SNGN	A56
SNGX	A57
TNGA	A57
TNGN	A57
VNGA	A57
WNGA	A58

CBN/PCD inserts
CBN/PCD Wendeschneidplatten

Reference / Bez.	Page / Seite
CCMW	A59
CNGA	A59
DCMW	A59
DNGA	A59
SNGA	A59
TCMW	A60
TNGA	A60
TPMN	A60

Inserts for parting and grooving
Ab- und Einstechwendepplatten

Reference / Bez.	Page / Seite
GIGP	B06
GIGW	B06
GISG	B06
GIST	B06
LS/RS <small>Microturn</small>	B11-15
MRCN	B08
NG	B09
NR	B10
NT	B10
PTNT	B08
WDMG	B07
WDMP	B07
WDMR	B07
WDMT	B07

Threading inserts
WSP zum Gewindedrehen

Reference / Bez.	Page / Seite
EL-60°/55°	C03
EL-ISO	C05
EL-LG	C10
EL-W	C08
ER-60°/55°	C03
ER-60°/55° TD	C03
ER-ISO	C05
ER-LG	C10
ER-W	C08
NL-60°/55	C04
NL-ISO	C07
NL-W	C10
NR-60°/55°	C04
NR-60°/55° TD	C04
NR-ISO	C06
NR-W	C09
TNMC	C10
TPMC	C10

**Toolholders
Klemmhalter**

Reference / Bez.	Page / Seite
CKJN 93°	A114
CKNN 63°	A115
CSBP 75°	A116
CSDP 45°	A117
CSKP 75°	A118
CSSP 45°	A119
CSTP 60°	A120
CTBP 75°	A121
CTCPN 90°	A122
CTCP 90°	A123
CTDP 45°	A124
CTFP 90°	A125
CTGP 90°	A126
CTTP 60°	A127
DCLN 95°-A	A69
DCLN 95°-N	A68
DDJN 93°-A	A71
DDJN 93°-N	A70
DSSN 45°-A	A73
DSSN 45°-N	A72
DTGN 90°-N	A74
DTJN 93°-A	A75
DVJN 93°-A	A77
DVJN 93°-N	A76
DWLN 95°-A	A79
DWLN 95°-N	A78
MCLN 95°	A80
MCLN-K 95°	A81
MDJN-K 93°	A82
MSSN 45°	A84
MSSN-K 45°	A83
MTEN 60°	A85
MTJN 93°	A86
MTJN-K 93°	A87
MTNN 63°	A88
MVJN-K 93°	A89
MVQN-K 117°30'	A90
MVVN-K 72°30'	A91
MWLN 95°	A92
MWLN-K 95°	A93
PCBN 75°	A94
PCFN 90°	A95
PCKN 75°	A96
PCLN 95°	A97
PCMN 50°	A98
PCSN 45°	A99
PDJN 93°	A100
PDNN 63°	A101
PRDC	A102
PRSC	A103
PRSN	A104
PSBN 75°	A105
PSDN 45°	A106
PSKN 75°	A107

**Toolholders
Klemmhalter**

Reference / Bez.	Page / Seite
PSSN 45°	A108
PTDN 90°	A109
PTFN 90°	A110
PTGN 90°	A111
PTTN 60°	A112
PWLN 95°	A113
SAGD 90°	A129
SCAC 90°	A130-131
SCLC 95°	A132,134
SCLC 95°-A	A133
SDAC 90°	A135
SDHC 107,5°	A136
SDJC 93°	A137,139
SDJC 93°-A	A138
SDNC 62°30'	A140-141
SRDC	A142
SSBC 75°	A143
SSDC 45°	A144
SSSC 45°	A145
STAC 90°	A146
STDC 45°	A147
STFC 90°	A148
STGC 90°	A149
STHE	A128
STJC 93°	A150-151
STTC 60°	A152
STXC 10°-80°	A153
SVAC 90°	A154
SVHC 107°30'	A155
SVJB 93°	A156
SVJC 93°	A157,159
SVJC 93°-A	A158
SVLC 95°	A160
SVVB 72°30'	A161
SVVC 72°30'	A162-163
SVXC 113°	A164
SVZC 100°	A165

**Boring bars
Bohrstangen**

Reference / Bez.	Page / Seite
A-PCLN 95°	A189
A-PDUN 93°	A191
A-PSKN 75°	A194
A-PSSN 45°	A195
A-PTFN 90°	A197
A-PWLN 95°	A199
A-SCLC 95°	A208
A-SDQC 107°30'	A214
A-SDUC 93°	A218
A-SDUC 93°-EX	A222
A-SSSC 45°	A224
A-STFC 90°	A226
A-SVJC 93°	A230

**Boring bars
Bohrstangen**

Reference / Bez.	Page / Seite
A-SVQC 107°30'	A233
A-SVUC 93°	A236
A..X-MTUN 93°-N	A238
A..X-PCLN 95°-N	A239
A..X-PDUN 93°-N	A240
A..X-PWLN 95°-N	A241
A..X-SCLC 95°-N	A242
A..X-SDUC 93°-N	A243
A..X-STFC 90°-N	A244
A..X-SXFN 90°-N	A245
CKUN 93°	A200
CSKP 75°	A201
CTFP 90°	A202
CTUP 93°	A203
DCLN 95°-N	A176
DDUN 93°-N	A177
E-SCLC 95°	A210
E-SDQC 107°30'	A216
E-SDUC 93°	A220
E-STFC 90°	A228
J.. / J..-A..	A237,246
MCLN-K 95°	A178
MDUN-K 93°	A179
MSKN-K 75°	A180
MTFN 90°	A181
MTFN-K 90°	A182
MTUN 93°	A183
MVUN-K 93°	A184
MWLN 95°	A185
MWLN-K 95°	A186
PCKN 75°	A187
PCLN 95°	A188
PDUN 93°	A190
PDUN 93°-EX	A192
PSKN 75°	A193
PTFN 90°	A196
PWLN 95°	A198
SCLC 95°	A207
SCLCN 95°	A212
SDQC 107°30'	A213
SDUC 93°	A217
SDUC 93°-EX	A221
SET SCLC 95°	A209
SET SDQC 107°30'	A215
SET SDUC 93°	A219
SET STFC 90°	A227
SSKC 75°	A223
STFC 90°	A225
STUC 93°	A229
SVQC 107°30'	A232
SVUB 93°	A234
SVUC 93°	A235
00.30	A204
608.00	A206

Cartridges
Kurzklemmhalter

Reference / Bez.	Page / Seite
CSKP 75°	A259
CSSP 45°	A259
CTFP 90°	A260
CTGP 90°	A260
CTSP 45°	A261
CTTP 60°	A261
CTWP 30°	A262
PCFN 90°	A254
PCLN 95°	A254
PSKN 75°	A255
PSRN 75°	A255
PSSN 45°	A256
PTFN 90°	A256
PTGN 90°	A257
PTSN 45°	A257
PTTN 60°	A258
PTWN 30°	A258
SCFC 90°	A263
SCLC 95°	A263
SSKC 75°	A264
SSSC 45°	A264
STFC 90°	A265
STGC 90°	A265
STSC 45°	A266
STTC 60°	A266
STWC 60°	A267

Brazed tools
HM-Gelötete Werkzeuge

Reference / Bez.	Page / Seite
ISO 2 45°	A272
ISO 6 90°	A272
ISO 7 90°	A273
ISO 9 90°	A275
ISO 351 80°	A273
UI 30 60°	A274
UI 40 60°	A275
UI 50 90°	A276

Parting and grooving
Ab- und Einstechdrehen

Reference / Bez.	Page / Seite
CPTS	B48
CRCFN	B49
CZCB	B41
CZCD	B21
CZDP	B20
CZDPN	B48
CZFD	B25
CZFD <small>Modular blades Modulare Stechschwerter</small>	B23-24
CZGB	B47
CZGD	B22
DPTS	B48

Parting and grooving
Ab- und Einstechdrehen

Reference / Bez.	Page / Seite
NE 93°	B54
NNTO 93°	B57
NR 45°	B55
NS 93°	B56
STHE	B18
XLCF	B43
XLCFN	B51
XLCTN	B52
XLCTN-HSS	B53
00.30	B44
608.00	B46

Threading
Gewindedrehen

Reference / Bez.	Page / Seite
CTAN 90°	C12
CTXN 90°	C13
STAN 90°	C14
STCN 90°	C16
STXN 90°	C15
S.. CTXN 90°	C17
S.. STGN 90°	C19
S.. STGP 90°	C20
S.. STXN 90°	C18

Ceramic milling cutters
Fräser für Keramik-WSP

Reference / Bez.	Page / Seite
1242.90 88°	D10
1442.90 75°	D11
5540.90	D12
55 ² 40.06	D13
5542.90	D14

Ceramic tools
Werkzeuge für Keramik-WSP

Reference / Bez.	Page / Seite
CCBN 75°	D16
CCKN 75°	D17
CCLN 95°	D18
CDJN 93°	D19
CELN 97°30'	D20
CRDC	D21
CRDN	D22
CRSN	D23
CSDN 45°	D24
CSKN 75°	D25
CSRN 75°	D26
CSSN 45°	D27
CSXN 85°	D28
CSYN 85°	D29
CTFN 90°	D30

Ceramic tools
Werkzeuge für Keramik-WSP

Reference / Bez.	Page / Seite
CTGN 90°	D31
CVJN 93°	D32
CVVN 62°30'	D33
S.. CCLN 95°	D34
S.. CDQN 107°30'	D35
S.. CDUN 93°	D36
S.. CELN 97°30'	D37
S.. CSKN 75°	D38
S.. CSSN 45°	D39
S.. CSYN 85°	D40

PSC Ceramic
PSC Keramikhalter

Reference / Bez.	Page / Seite
CCKN 75°	D42
CCLN 95°	D43
CCRN 75°	D44
CDHN 107°30'	D45
CDJN 93°	D46
CDNN 63°	D47
CDUN 93°	D48
CRSN	D49
CSDN 45°	D50
CSKN 75°	D51
CSRN 75°	D52
CSSN 45°	D53

PSC Toolholders
PSC Klemmhalter

Reference / Bez.	Page / Seite
DCKN 75°	E06
DCLN 95°	E07
DCMN 50°	E08
DCRN 75°	E09
DDHN 107°30'	E10
DDJN 93°	E11
DDMN 48°	E12
DDNN 63°	E13
DDUN 93°	E14
DRSN	E15
DSDN 45°	E16
DSKN 75°	E17
DSRN 75°	E18
DSSN 45°	E19
DTFN 90°	E20
DTGN 90°	E21
DVJN 93°	E22
DVVN 72°30'	E23
DWLN 95°	E24
MCKN 75°	E25
MCLN 95°	E26
MCRN 75°	E27
MDJN 93°	E28
MDNN 63°	E29
MDUN 93°	E30
MSDN 45°	E31
MSKN 75°	E32
MSRN 75°	E33
MSSN 45°	E34
MTFN 90°	E35
MTGN 90°	E36
MTJN 93°	E37
MVJN 93°	E38
MVVN 72°30'	E39
MWLN 95°	E40
PCLN 95°	E41
PCRN 75°	E42
PDJN 93°	E43
PDUN 93°	E44
PRDC	E45
PRSC	E46
PSDN 45°	E47
PSKN 75°	E48
PSRN 75°	E49
PSSN 45°	E50
SCLC 95°	E51
SDJC 93°	E52
SDNC 62°30'	E53
SRDC	E54
SRSC 45°	E55
SSRC 75°	E56
STGC 90°	E57
STJC 93°	E58
SVHB 107°30'	E59

PSC Toolholders
PSC Klemmhalter

Reference / Bez.	Page / Seite
SVHC 107°30'	E60
SVJB 93°	E61
SJVC 93°	E62
SVMB 50°	E63
SVVB 72°30'	E64
SVVC 72°30'	E65

PSC Adaptor
PSC Adapter

Reference / Bez.	Page / Seite
J..	E66

PSC Boring bars
PSC Bohrstangen

Reference / Bez.	Page / Seite
DCLN 95°	E67
DDUN 93°	E68
DWLN 95°	E69
MTFN 90°	E70
MVUN 93°	E71
MWLN 95°	E72
PCLN 95°	E73
PDUN 93°	E74
PSKN 75°	E75
SCLC 95°	E76
SDUC 93°	E77
SDUC-X 93°	E78
SSKC 75°	E79
STFC 90°	E80
SVQB 107°30'	E81
SVQC 107°30'	E82

PSC Threading
PSC Gewindedrehen

Reference / Bez.	Page / Seite
SE 90°	A83
SI 90°	A84

PSC Parting and grooving
PSC Ab- und Einstechdrehen

Reference / Bez.	Page / Seite
CZCD	E85
CZFD	E86
CZGD	E87
NE 93°	E88
NNT0 93°	E91
NR 45°	E89
NS 93°	E90

PSC Drills
PSC Bohrer

Reference / Bez.	Page / Seite
45..	E92-94

PSC Arbors and adaptors
PSC Aufnahmen

Reference / Bez.	Page / Seite
13.218	E119
16.218	E120
18.160	E100
18.180	E101
18.215	E102
18.218	E121-122
18.296	E103
18.306	E104
18.315	E105
18.400	E106
18.406	E107
18.453	E108
18.455	E109
18.470	E110
18.500	E111
18.510	E112
18.520	E113
18.530	E114
18.540	E115
18.550	E116
18.620	E117
18.700	E124
18.999	E118
23.218	E123
AC	E125
MC	E125

**Milling inserts
Fräswendeschneidplatten**

Reference / Bez.	Page / Seite
ADKT	F10
ADMT	F10
ADMT-R	F10
ADMW	F10
ADMW-C	F10
APHT-AL	F11
APKT	F11
APLT	F11
APMT	F11
APMW	F11
CCGT-AL	F12
CCKT	F12
CCMT	F12
CCMW	F12
ENHQ	F13
FRC	F13
FRCR	F13
HPKW	F14
HPR	F14
LNMM	F14
NNMU	F15
ODMT	F15
ODMW	F15
RDHW	F15
RDMT	F16
RDMW	F16
RPMT	F16
RPMW	F16
RPR	F16
SCGT-AL	F17
SCMT-39	F17
SCMW	F17
SDMT	F17
SEHT	F17
SEHT-AL	F17
SEHW	F17
SEKN	F18
SEKR	F18
SEMT	F18
SNHX	F18
SNKN	F18
SNMX	F19
SNUN	F19
SPKN	F19
SPKR	F19
SPMT	F19
SPMW	F20
SPMX	F20
SPUN	F20
TCGT-AL	F21
TCMT-39	F21
TCMW	F21
TCMX	F21
TPKN	F21

**Milling inserts
Fräswendeschneidplatten**

Reference / Bez.	Page / Seite
TPKR	F21
TPUN	F22
VCGT-AL	F22
VCGT-AP	F22

**Face and chamfering
Plan- und Anfasfräser**

Reference / Bez.	Page / Seite
0440.90 75°	F42
0440.99 75°	F43
0624.07 45°	F50
0630.00 45°	F53
0630.07 45°	F53
0630.30 45°	F54
0634.37 45°	F51
0640.90 45°	F41
0724.07 60°	F50
0735.03 45°	F46
0740.00 45°	F47
0740.07 45°	F47
0740.30 45°	F48
0744.90 45°	F31
0748.90 45°	F38
0748.99 45°	F39
0758.99 45°	F40
1235.01	F55
1235.07	F56
1345.06	F59
1345.07	F58
1430.90 75°	F37
16 $\frac{2}{3}$ 4. $\frac{0}{2}$ 7	F52
1725. $\frac{0}{2}$ 7	F57
1742.93 45°	F26
1742.99 45°	F27
1744. $\frac{0}{2}$ 7	F49
1745.93 15°-75°	F44-45
1748.07 45°	F30
1748.93 45°	F28
1748.99 45°	F29
1845.93 42°	F32
1845.99 42°	F33
1852.93 45°	F36
1855.93 42°	F34
1855.99 42°	F35

**Facing square shoulder cutters
Eckfräser**

Reference / Bez.	Page / Seite
0120.00 90°	F90
0130.00 90°	F91
0130.30 90°	F91
0130.90 90°	F92
0130.99 90°	F93
0140.90 90°	F94
0140.99 90°	F95
0235.03 90°	F84
0235.06 90°	F84
0235.93 90°	F85
0255.93 90°	F86
0255.99 90°	F87
1135.01	F88
1220.02 90°	F73
1220.03 90°	F72
1220.06 90°	F75
1220.07 90°	F74
1220.93 90°	F76
1222.06	F66
1222.37	F66
1222.93	F67
1230.02 90°	F78
1230.06 90°	F79
1230.07 90°	F77
1230.93 90°	F81
1230.99 90°	F82
1232.06	F69
1232.37	F68
1232.93 90°	F70
1232.99 90°	F71
1245.93 90°	F83
22 $\frac{2}{3}$ 0.07 90°	F80
3314.0 $\frac{0}{1}$	F89
3314.06	F89

**Slot cutters
Nutenfräser**

Reference / Bez.	Page / Seite
13 $\frac{1}{4}$ 4.07	F104
13 $\frac{1}{4}$ 4. $\frac{30}{34}$	F105
1520.90	F110
1530.90	F111
1549.90	F112
1942.90	F109
2942.07	F108
2942.90	F107
3942.95	F106
M	F113
MN	F113

**Profile milling
Profilfräsen**

Reference / Bez.	Page / Seite
0344.06	F136
0344.90	F137
16 $\frac{2}{4}$ 9.03	F120
16 $\frac{2}{4}$ 9.06	F121
1639.93	F122
1649.93	F123
55_5	F128
55_5.06	F129
55 $\frac{4}{5}$ 5.93	F130
5549.90	F131
85_0	F139
85_3	F140
85_06	F141
88_0	F142
88_3	F143
88_06	F144

**Porcupine cutters
Igelfräser**

Reference / Bez.	Page / Seite
23 $\frac{2}{3}$ 0.07	F150
2330. $\frac{47}{48}$	F151
2330. $\frac{49}{50}$	F152

**Solid carbide
Vollhartmetall**

Reference / Bez.	Page / Seite
6020	G50
6021	G52
6022	G26
6023	G28-29
6030	G54
6031	G57
6040	G60
6041	G62
6043	G30-31
6054	G17
6064	G20
6143	G32
6164	G23
6230	G10
6240	G13
6243	G32
6320	G64
6321	G66
6322	G36
6323	G38
6324	G40
6325	G41
6342	G34
6343	G34
6440	G15
6510	G44

**Solid carbide
Vollhartmetall**

Reference / Bez.	Page / Seite
6520	G46
6530	G47
6610	G45
6640	G48
7320	G73-75
7323	G81-83
7520	G77-79
7523	G85-87
84	G68
86	G69
87	G70
88	G71
900	G89
901	G89
910	G89
911	G89
920	G90
921	G90
930	G90
931	G90
940	G91
941	G91
950	G91
951	G91
960	G92
961	G92
970	G92
971	G92
98	G93
99	G93

**Drills
Bohrer**

Reference / Bez.	Page / Seite
02 $\frac{1}{3}$ 4.00	H09
42..	H06
42 $\frac{1}{4}$ 4. $\frac{72}{75}$	H07
45..	H05
4744.64	H08
9614.61	H10
9624.61	H11

DIN 2080

Reference / Bez.	Page / Seite
10.160	105
10.165	106
10.180	107
10.210	108
10.215	109
10.216	110
10.220	111
10.225	112
10.290	113
10.295	114
10.296	115
10.300	116
10.302	117
10.353	118
10.453	119
10.457	120
10.470	121
10.610	122
10.620	123
10.630	124

DIN 69871-A

Reference / Bez.	Page / Seite
11.160	132
11.165	138
11.180	139
11.210	140
11.215	142
11.216	144
11.225	145
11.226	146
11.290	147
11.295	148
11.296	149
11.300	151
11.302	153
11.305	155
11.353	161
11.400	162
11.453	164
11.455	166
11.457	167
11.470	169
11.512	170
11.610	171
11.620	173
11.630	174
11.999	175
13.160	133
13.210	141
13.215	143
13.296	150

DIN 69871-A

Reference / Bez.	Page / Seite
13.300	152
13.302	154
13.306	156-57
13.307	158
13.315	159
13.453	165
13.457	168
13.610	172
A11.160	<i>Cylindrical / Zylindrische Form</i> 136
A11.160	<i>Conical / Konische Form</i> 137
A11.160IK	<i>Cylindrical / Zylindrische Form</i> 135
A11.315	160
A11.315IK	160
SET-C20/32	163

HSK DIN 69893-1

Reference / Bez.	Page / Seite
16.160	181
16.180	184
16.210	185
16.215	186
16.296	187
16.300	188-89
16.305	190
16.315	192
16.453	193
16.455	194
16.470	195
16.999	196
A16.160	183
A16.160IK	182
A16.315IK	191

JIS B 6339-BT

Reference / Bez.	Page / Seite
20.160	1104
20.165	1108
20.180	1109
20.210	1110
20.215	1112
20.216	1114
20.225	1115
20.226	1116
20.290	1117
20.295	1118
20.296	1119
20.300	1121
20.302	1123
20.305	1125
20.353	1131
20.400	1132
20.453	1134
20.455	1136
20.457	1137
20.470	1139
20.512	1140
20.610	1141
20.620	1143
20.630	1144
20.999	1145
23.160	1105
23.210	1111
23.215	1113
23.296	1120
23.300	1122
23.302	1124
23.306	1126-127
23.307	1128
23.315	1129
23.453	1135
23.457	1138
23.610	1142
A20.160	<i>Cylindrical / Zylindrische Form</i> 1106
A20.160	<i>Conical / Konische Form</i> 1107
A20.315	1130
SET-C20/32	1133

Boring Heads
Bohrköpfe

Reference / Bez.	Page / Seite
10.700	1164
11.700	1165
16.700	1166
18.700	1167
20.700	1168
60.12/24	1170
60.62/64	1169
6114. ⁰ / ₂ 7	1154
63.12/28	1158
63.36/60	1159
64.12/28	1160
64.36/60	1161
66.20/28	1162
66.36/60	1163
97.15/24	1155
SCLC	1156
SET-97	1171
STFC	1157

Cylindrical shanks
Zylindrische Schäfte

Reference / Bez.	Page / Seite
40.295	1176
40.315	1178
40.315E	1179
40.453	1180
40.455	1181
42.300	1182
42.610	1183
42.620	1184
43.296	1177

Morse shanks
Morse Schäfte

Reference / Bez.	Page / Seite
30.315	1189
36.453	1190
37.215	1191
37.290	1192
37.295	1193
37.296	1194

Accessories
Zubehör

Reference / Bez.	Page / Seite
02_70/80	1228
02_71/81	1228
431XX	1220
433XX	1220
451XX	1221
453XX	1221
455XX	1222
456XX	1222
457XX	1222
50XX	1219
71..30XX	1202
75..70XX	1203
9..	227
91..	1223-225
92..	1226
BXX	1206-208
ERXX	1210-212
ERBXX	1214
ERCXX	1215-216
ERTXX	1217-218
MK	1201
MP	1200
MU	1199
RC	1198
RN	1198
SET-ER	1213

EINES CANELA, S.A.

Conditions of sale

All sales are made in accordance with our standard conditions of sale, current at the time orders are accepted. Specifications and prices subject to change without notice.

Product warranty

Eines Canela will repair or replace any of its products, which in its judgement, are found to be defective in material or workmanship. All claims must be made in writing within thirty days after receipt of product. No claims for labor or damages will be allowed. In no event shall Eines Canela be liable for consequential or special damages of any kind.

Special tool quotation

Orders for special tools must be confirmed in writing before manufacturing can begin. Special items and non-stock standard items cannot be cancelled or returned for exchange or credit.

Delivery terms

Full transportation costs will be charged to the buyer. Specify shipment to be made by other than regular means of transportation.

Claims

Claims for loss in transit must be made against the transportation company. The foregoing shall constitute the sole and exclusive remedies of the customer and are in lieu of all other warranties, expressed, implied or statutory, including but not limited to any implied warranty of merchantability or fitness.

Returns

No merchandise will be accepted for return after 30 days of shipment. All returns must be pre-paid and must be accompanied by our Return Goods Authorization (RGA) number. This number must appear on the outside of the box. Merchandise must be received in good condition or will be refused.

**Conditions, terms, and prices are subject to change without notice.
Any typographical or other error in this catalogue is subject to correction.**

Verkaufsbedingungen

Alle Verkäufe werden in Übereinstimmung mit unseren Standard-Lieferbedingungen gemacht, die gültig waren als die Bestellungen akzeptiert worden sind. Spezifizierungen und Preise können ohne Benachrichtigung geändert werden.

Produktgarantie

Eines Canela wird die Produkte ersetzen oder reparieren, die ihrer Meinung nach, einen Materialdefekt oder ein Herstellungsfehler haben. Alle Ansprüche müssen schriftlich innerhalb von dreißig Tagen nach der Annahme des Produktes erhoben werden. Kein Garantieanspruch leisten wir für Werkstückbeschädigungen. In keinem Fall wird Eines Canela für Folgeschäden jeder Art verantwortlich sein.

Angebote für Sonderwerkzeuge

Die Bestellungen von Sonderwerkzeuge müssen schriftlich bestätigt werden, bevor die Herstellung beginnen kann. Sonderwerkzeuge und nicht auf Lager liegende Standardwerkzeuge können nicht storniert, im Austausch oder zur Gutschrift zurückgegeben werden.

Liefersbedingungen

Alle Transportkosten sind vom Käufer zu bezahlen. Der Käufer muß den Verkäufer informieren, wenn eine Sendung durch ein anderes Transportmittel gemacht werden soll, das nicht das normale ist.

Einsprüche

Ansprüche auf den Verlust während der Sendung müssen gegen die Transport-Gesellschaft erhoben werden. Das Vorstehende ersetzt die alleinigen und exklusiven Einkaufsbedingungen des Kunden und wird anstatt aller anderen Garantien angewendet.

Rückgaben

Keine Waren werden für die Rückgabe 30 Tagen nach dem Versanddatum akzeptiert. Alle Rückgaben müssen frei Haus geschickt werden und mit unserer Rückgabe-Genehmigungsnummer (RGA) begleitet werden. Diese Nummer muss auf der Außenseite des Kartons erscheinen. Waren müssen in gutem Zustand sein, sonst wird die Annahme verweigert.

**Bedingungen, Fristen und Preise sind Änderungen vorbehalten.
Irgendwelcher typografischer oder anderer Fehler in diesem Katalog ist der Korrektur unterworfen.**

EINES CANELA, S.A.

This catalogue contains information and specifications concerning cutting tools sold by Eines Canela. Although some of the cutting tools made from carbides are very tough and resist breakage, most are brittle and special safety precautions are required when using them.

Small fragment and chips may be thrown from a cutting tool when a fracture occurs. Since these fragments or chips are thrown at very high speeds and are very hot, contact with the skin or eyes could cause severe injury. Also, the grinding of these cutting tools will produce fine carbide and cobalt or nickel dust which may be harmful to the lungs. Listed below are some suggestions on how to minimize the potential for injury while using cutting tools.

For more information about the product hazards and safety precautions that must be taken to minimize the possibility of injury while using cutting tools, please call your Eines Canela Sales Engineer.

Eines Canela has no control over use of these cutting tools. The user must determine the suitability of these tools in its particular application.

WARNING: Very hot chip fragments may be thrown from cutting tools at very high speeds. These chips can cause severe burns, cuts or punctures to the skin, or damage to the eyes. The following are some of the safety precautions that must be followed by operators and observers while using cutting tools:

1. Make sure that the insert size and shape are adequate for use to which it is being cut.
2. Chip control is necessary to prevent a continuous chip catching in the workpiece.
3. Chips are very hot and have sharp edges and should not be removed by hand.
4. Turn off the machine whenever chips are removed or when the cutting tools are changed.
5. Do not use air hoses to blow chips away from the machine.
6. To prevent tool breakage use the correct size toolholder.
7. Make sure that the overhang on the toolholder is as short as possible. Too much overhang can result in chatter and tool breakage.
8. To prevent the workpiece from coming loose during use, be sure the workpiece is tight and secure in its holder.
9. Overloading of tungsten carbide cutting tools may cause fractures of these tools.
10. A slug may be ejected at high speeds during drilling.

To protect the operator and observer from possible flying objects which could result in severe injury, the following protective devices should be worn or used while using cutting tools:

1. Wear hard hats.
2. Wear safety glasses with side shields.
3. Wear closed shoes with steel toes.
4. Keep protective enclosure on machine in place during operation.

WARNING: Grinding or finishing carbide produces fine carbide and cobalt or nickel dust. This dust may cause injury to the lungs.

Operators and observers must take the following safety precautions to minimize the possibility of such injury:

1. Use with adequate ventilation.
2. Maintain the dust or mist level below recommended levels.
3. Avoid breathing dust or mist. If not possible, wear appropriate respirators, particularly when grinding tungsten carbide.
4. Minimize prolonged skin contact.
5. Wash hands thoroughly after handling.

WARNING: Use of cutting fluids and work materials create hazards. Be careful at all times.

1. Keep the cutting fluid clean so no particles can be carried back across the workpiece and possibly scratch it.
2. Cutting fluids may catch on fire when exposed to high temperatures generated during cutting.
3. Work materials such as aluminium, magnesium, uranium and titanium are flammable and could catch on fire.
4. Cutting fluids should be treated or replaced to reduce bacterial levels which may cause illness.

- WARNING -

Speeds, Feeds and Grade information within this catalogue are for reference only. If the operator does not feel safe using our speeds, feeds and grades, then the operator should use what is comfortable to him or her. Eines Canela is not responsible for any damage or injury that occurs using the speeds, feeds and grades information within catalogue.

EINES CANELA, S.A.

Dieser Katalog enthält Information und Spezifizierungen bezüglich Schneidwerkzeugen, die durch Eines Canela verkauft sind. Obwohl einige der aus Hartmetall gemachten Schneidwerkzeuge sehr zäh sind und Brechung widerstehen, sind die meisten spröde, und spezielle Sicherheitsvorsichtsmaßnahmen sind erforderlich, wenn man sie verwendet.

Kleine Bruchstücke und Späne können von einem Schneidwerkzeug geworfen werden, wenn ein Bruch vorkommt. Da diese Bruchstücke oder Späne mit sehr hohen Geschwindigkeiten geschleudert werden und sehr heiß sind, können sie ernste Verletzungen verursachen wenn sie mit der Haut oder mit den Augen in Verbindung kommen. Außerdem erzeugt das Schleifen dieser Schneidwerkzeuge feines Karbid- und Kobalt- oder Nickel-Staub, der für die Lungen schädlich sein kann. Unten sind einige Vorschläge verzeichnet, wie man das Potenzial für Verletzungen minimiert, wenn man die Schneidwerkzeuge verwendet.

Für mehr Information über die Produktgefahren und Sicherheitsmaßnahmen, die vorgenommen werden müssen, um die Möglichkeit der Verletzung zu minimieren, wenn Sie Schneidwerkzeugen verwenden, rufen Sie bitte Ihren Eines Canela Verkaufsspezialisten an.

Eines Canela hat keine Kontrolle über den Gebrauch dieser Schneidwerkzeuge. Der Anwender hat die Verantwortung für den sachgemäßen Einsatz dieser Werkzeuge.

WARNUNG: Sehr heiße Span-Bruchstücke können von den Schneidwerkzeugen mit sehr hohen Geschwindigkeiten geworfen werden. Diese Späne können ernste Brandwunden, Schnitte oder Verletzungen der Haut verursachen, oder die Augen beschädigen. Folgend sind einige der Sicherheitsmaßnahmen, die von Maschinenbedienern und Beobachtern gefolgt werden müssen, wenn sie Schneidwerkzeuge verwenden:

1. Stellen Sie sicher, daß die Größe und Form der Wendeschneidplatte für den Gebrauch entsprechend sind, zu dem sie bestellt worden sind.
2. Span-Kontrolle ist notwendig, um zu verhindern, daß die Späne dauernd im Kontakt mit dem Werkzeug kommen.
3. Späne sind sehr heiß und haben scharfe Ränder und sollten nicht mit der Hand berührt werden.
4. Schalten Sie die Maschine ab, immer wenn die Späne entfernt werden, oder wenn die Schneidwerkzeuge gewechselt werden.
5. Verwenden Sie keine Druckluft, um die Späne von der Maschine wegzublasen.
6. Um Werkzeug-Bruch zu verhindern, verwenden Sie die richtigen Größe des Werkzeughalters.
7. Stellen Sie sicher, daß die Auskragung auf dem Werkzeughalter so kurz wie möglich ist. Zu viele Auskragslänge kann Schwingungen und Werkzeug-Bruch verursachen.
8. Um zu vermeiden, daß das Werkstück während der Bearbeitung lose wird, überprüfen Sie die sichere und feste Spannung des Werkstücks.
9. Die Überbelastung von Hartmetall-Schneidwerkzeugen kann Brüche dieser Werkzeuge verursachen.
10. Eine Scheibe kann mit hohen Geschwindigkeiten während des Bohrens geschleudert werden.

Um den Maschinenbediener und Beobachter von möglichen fliegenden Gegenständen zu schützen, die Verletzungen verursachen konnten, sollten die folgenden Schutzgeräte getragen oder verwendet werden, wenn man Schneidwerkzeuge verwendet:

1. Tragen Sie Schutzhelme.
2. Tragen Sie Sicherheitsbrille mit Seitenschildern.
3. Tragen Sie Sicherheitsschuhe.
4. Verwenden Sie Schutzwände zur Abdeckung der Maschine während der Bearbeitung.

WARNUNG: Hartmetall schleifen oder fertigen erzeugt feines Karbid- und Kobalt- oder Nickel-Staub. Dieser Staub kann Verletzungen zu den Lungen verursachen. Maschinenbediener und Beobachter müssen die folgenden Sicherheitsmaßnahmen nehmen, um die Möglichkeit solcher Verletzung zu minimieren:

1. Verwenden Sie geeignete Absaugungen.
2. Senken Sie den Staub oder das Nebel-Niveau unter des empfohlenen Niveaus.
3. Vermeiden Sie, den Staub oder das Nebel zu atmen. Wenn nicht möglich, dann verwenden Sie Atemschutzmasken, besonders wenn Sie Karbid schleifen.
4. Minimieren Sie den Hautkontakt.
5. Waschen Sie sich die Hände gründlich nach dem Berühren.

WARNUNG: Der Gebrauch von Schneidflüssigkeiten und Arbeitsmaterialien schafft Gefahren. Seien Sie zu jeder Zeit sorgfältig im Umgang damit.

1. Halten Sie die Schneidflüssigkeit sauber, sodaß keine Partikeln das Werkstück verkratzen können.
2. Schneidflüssigkeiten können im Brand geraten, wenn sie zu den hohen Temperaturen ausgesetzt werden, die beim Schneiden erzeugt werden.
3. Arbeitsmaterialien wie Aluminium, Magnesium, Uran und Titan sind feuergefährlich und können im Brand geraten.
4. Schneidflüssigkeiten sollten behandelt oder ersetzt werden, um das Bakterienniveau zu reduzieren, das Krankheiten verursachen kann.

- WARNUNG -

Informationen über Geschwindigkeiten, Vorschübe und Sorten innerhalb dieses Katalogs sind nur als Richtwerte zu benutzen. Wenn sich der Maschinenbediener nicht sicher ist, ob diese Geschwindigkeiten, Vorschübe und Sorten richtig sind, dann sollte der Maschinenbediener die Werte entsprechend der Bearbeitung anpassen. Eines Canela ist nicht für Schaden oder Verletzungen verantwortlich, die vorkommen können, wenn man die Informationen über Geschwindigkeiten, Vorschübe und Sorten verwendet, die in diesem Katalog genannt werden.

