



# DRILLS BOHRER

Inserts for drills Wendeschneidplatten für Bohrer	<b>H02</b>
Code system Kodifizierung	<b>H03</b>
Applications index Anwendungen	<b>H04</b>
Drills Bohrer	<b>H05-07</b>
Trepanning drills Kernbohrer	<b>H08</b>
Spot facing and countersink milling cutters Senkfräser und Rückwärtssenker	<b>H09-11</b>
Technical information Technische Auskünfte	<b>H12-13</b>
Cutting data Schnittdaten	<b>H14-17</b>



**H**

## Square inserts / Positive Vierkant-Wendeschneidplatten / Positiv

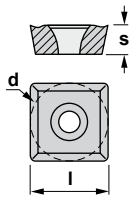

- i** Use classification / Einsatzbereich
- Continuous / Ununterbrochen
  - ◐ Slight interruption / Leicht unterbrochen
  - ⊕ Interruption / Unterbrochen
- i** Availability / Verfügbarkeit
- Standard item / Standard-Artikel
  - Check availability / Verfügbarkeit prüfen

<b>P</b>	Steel Stahl		●	⊕	●	⊕	●	⊕	●	⊕								
<b>M</b>	Stainless Rostfreier Stahl		●		●		●	⊕										
<b>K</b>	Cast iron Guß		●	⊕		⊕			●									
<b>N</b>	Non ferrous materials Nicht-Eisen-Metalle		⊕															⊕
<b>S</b>	Heat-resistant alloys Hitzebeständige Legierungen																	
<b>H</b>	Hard materials Harte Materialien																	

### SPMT



Reference / Bezeichnung	l	s	d	r	KM15	PM25	PM40	TIN21	TIN25	TIN28	TL10	TL20	TL40	ZR10
SPMT 060304	6,35	3,18	6,35	0,4									●	
SPMT 070308	7,94	3,18	7,94	0,8									●	
SPMT 090308	9,52	3,18	9,52	0,8									●	
SPMT 120408	12,70	4,76	12,70	0,8									●	

## 80° Trigon inserts / Positive Trigon-Wendeschneidplatten 80° / Positiv

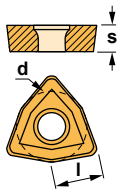

- i** Use classification / Einsatzbereich
- Continuous / Ununterbrochen
  - ◐ Slight interruption / Leicht unterbrochen
  - ⊕ Interruption / Unterbrochen
- i** Availability / Verfügbarkeit
- Standard item / Standard-Artikel
  - Check availability / Verfügbarkeit prüfen

<b>P</b>	Steel Stahl		●	⊕	●	⊕	●	⊕	●	⊕								
<b>M</b>	Stainless Rostfreier Stahl		●		●		●	⊕										
<b>K</b>	Cast iron Guß		●	⊕		⊕			●									
<b>N</b>	Non ferrous materials Nicht-Eisen-Metalle		⊕															⊕
<b>S</b>	Heat-resistant alloys Hitzebeständige Legierungen																	
<b>H</b>	Hard materials Harte Materialien																	

### WCMX



Reference / Bezeichnung	l	s	d	r	KM15	PM25	PM40	TIN21	TIN25	TIN28	TN30	TL20	TL40	ZR10
WCMX 030208	3,46	2,38	5,56	0,8							●		●	
WCMX 040208	3,99	2,38	6,35	0,8							●		●	
WCMX 050308	5,07	3,18	7,94	0,8							●		●	
WCMX 06T308	6,14	3,97	9,52	0,8							●		●	
WCMX 080412	8,14	4,76	12,70	1,2							●		●	



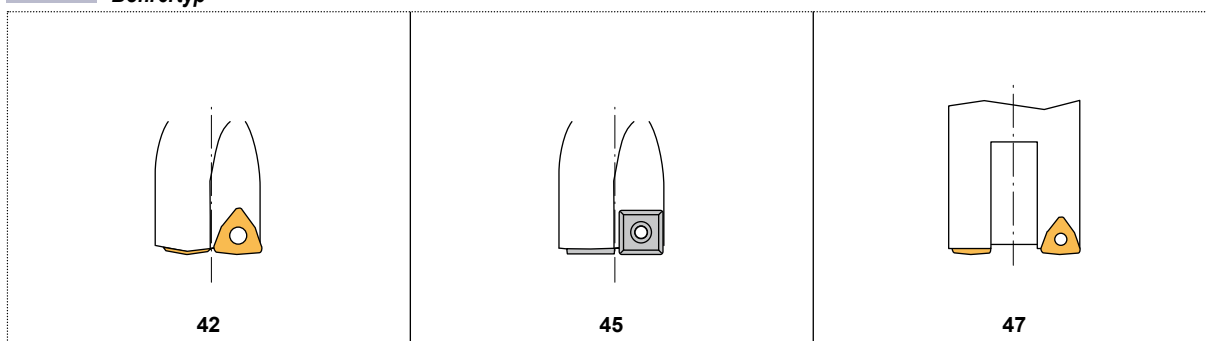

## Code system / Kodifizierung

<b>4</b>	<b>2</b>	<b>3</b>	<b>4</b>	<b>63</b>	<b>027</b>
<b>1</b>		<b>2</b>	<b>3</b>	<b>4</b>	<b>5</b>

### 1 Drill type Bohrertyp

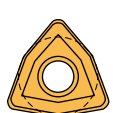

### 2 Insert size Wendeschneidplatte

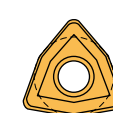
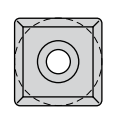
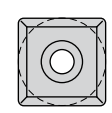
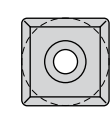
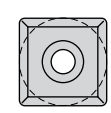
1	2	3	4	5
 WCMX 0302	 WCMX 0402	 WCMX 0503	 WCMX 06T3	 WCMX 0804
 SPMT 0603	 SPMT 0703	 SPMT 0903	 SPMT 1204	

### 3 Clearance angle of insert Wendeschneidplatten-Freiwinkel

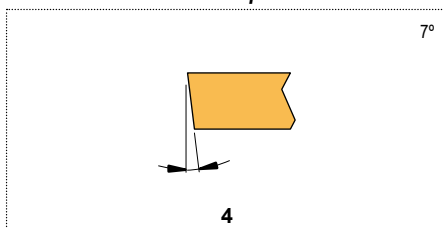

### 4 Shank size Schaftgröße

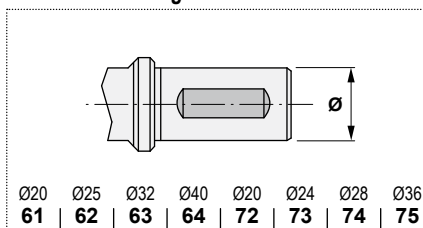

### 5 Diameter, mm. Durchmesser, mm.

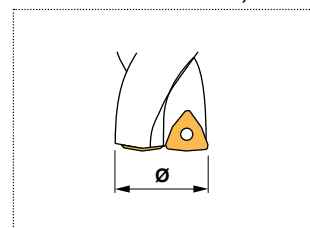

**Drills  
Bohrer**

45..

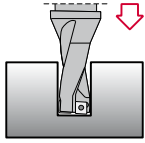

SPMT 0603..  
P / S. H05 SPMT 1204..

42..

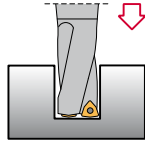

WCMX 0302..  
P / S. H06 WCMX 0804..

42<sup>1</sup><sub>4</sub> 4.72  
75

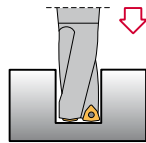

WCMX 0302..  
P / S. H07 WCMX 06T3..

**Trepanning drills  
Kernbohrer**

4744.64

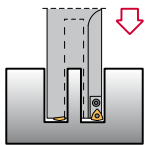

P / S. H08 WCMX 08T3..

**Spot facing and countersink milling cutters  
Senkfräser und Rückwärtssenker**

02<sup>1</sup><sub>3</sub> 4.00

Spot facing milling cutters  
Senkfräser

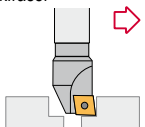

CC.. 0602..  
P / S. H09 CC.. 09T3..

9614.61

Back draft spot facing  
Rückwärtssenker

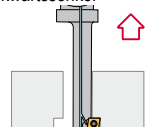

CC.. 0602..  
P / S. H10 CC.. 09T3..

9624.61

Back draft spot countersink  
Rückwärtssenker zum Anfasen

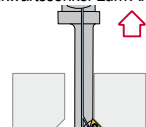

CC.. 0602..  
P / S. H11 TC.. 1102..



**Characteristics:**

Helical flute indexable insert drill that provides faster cutting speeds and efficient chip removal for use on conventional and C.N.C. machines. It works well on steels, alloyed steels, stainless steels and refractories.  
Max. hole depth = 3 x Diameter (D)

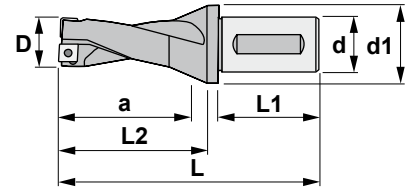

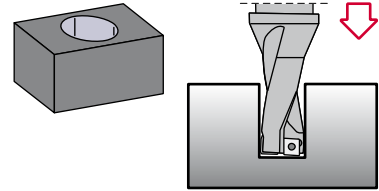

**Eigenschaften:**

Spiralformige Wendeschneidplatten-Bohrer um eine höhere Schnittgeschwindigkeit und einen guten Spanabfluß zu erreichen. Sie werden in konventionellen CNC-Drehmaschinen eingesetzt. Empfohlen für Stahl und auch für legierten, rostfreien und hitzebeständigen Stahl  
Max. Bohrtiefe = 3 x Durchmesser (D)



**45..**

Reference Bezeichnung	D	L	L1	L2	a	d	d1		Nm	Insert size Wendeschneidplatte	
4514.62.015	15	120	55	56	45	25	40	1225 5507	0.9	SPMT 0603..	0,240
4514.62.016	16	121	55	56	48	25	40	1225 5507	0.9	SPMT 0603..	0,250
4514.62.017	17	127	55	54	51	25	40	1225 5507	0.9	SPMT 0603..	0,250
4514.62.017,5	17,5	127	55	56	53	25	40	1225 5507	0.9	SPMT 0603..	0,250
4514.62.018	18	128	55	57	54	25	40	1225 5507	0.9	SPMT 0603..	0,230
4514.62.018,5	18,5	130	55	59	56	25	40	1230 5507	0.9	SPMT 0603..	0,240
4514.62.019	19	131	55	60	57	25	40	1250 5507	0.9	SPMT 0603..	0,240
4514.62.020	20	136	55	64	60	25	40	1225 5507	0.9	SPMT 0603..	0,250
4524.62.022	22	142	55	69	66	25	40	1225 5507	0.9	SPMT 0703..	0,400
4524.62.024	24	150	55	76	72	25	40	1225 5507	0.9	SPMT 0703..	0,450
4524.62.025	25	154	55	79	75	25	40	1225 5507	0.9	SPMT 0703..	0,475
4534.63.026	26	162	55	81	78	32	50	1225 5510	2.0	SPMT 0903..	0,475
4534.63.027	27	165	55	84	81	32	50	1225 5520	4.0	SPMT 0903..	0,500
4534.63.028	28	169	55	87	84	32	50	1230 5510	2.0	SPMT 0903..	0,550
4534.63.029	29	172	55	90	87	32	50	1230 5510	2.0	SPMT 0903..	0,570
4534.63.030	30	177	55	94	90	32	50	1230 5510	2.0	SPMT 0903..	0,600
4534.64.031	31	186	60	97	93	40	60	1230 5510	2.0	SPMT 0903..	0,850
4534.64.032	32	189	60	100	96	40	60	1230 5510	2.0	SPMT 0903..	0,900
4534.64.034	34	196	60	106	102	40	60	1230 5510	2.0	SPMT 0903..	0,975
4544.64.035	35	200	60	109	105	40	60	1230 5510	2.0	SPMT 1204..	1,000
4544.64.038	38	211	60	118	114	40	60	1250 5520	4.0	SPMT 1204..	1,170
4544.64.039	39	214	60	121	117	40	60	1250 5520	4.0	SPMT 1204..	1,200
4544.64.040	40	218	60	124	120	40	60	1250 5520	4.0	SPMT 1204..	1,300
4544.64.042	42	225	65	130	126	40	60	1250 5520	4.0	SPMT 1204..	1,600
4544.64.043	43	229	65	133	129	40	60	1250 5520	4.0	SPMT 1204..	1,750
4544.64.045	45	237	65	140	135	40	60	1250 5520	4.0	SPMT 1204..	1,900



**SPMT**

Square positive insert with 11° clearance.  H02  
Vierkantige positive Wendeschneidplatte mit 11° Freiwinkel.

Reference / Bez.	l	s	d
SPMT 060304	6,35	3,18	6,35
SPMT 070308	7,94	3,18	7,94
SPMT 090308	9,52	3,18	9,52
SPMT 120408	12,70	4,76	12,70

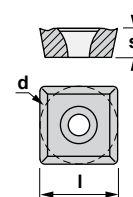

**SPMT**





**Characteristics:**

Helical flute indexable insert drill that provides faster cutting speeds and efficient chip removal for use on conventional and C.N.C. machines. It works well on steels, alloyed steels, stainless steels and refractories.  
Max. hole depth = 3 x Diameter (D)

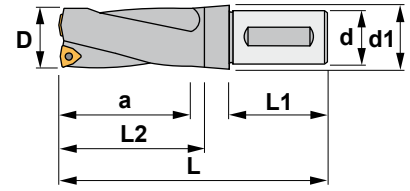

**Eigenschaften:**

Spiralförmige Wendeschneidplatten-Bohrer um eine höhere Schnittgeschwindigkeit und einen guten Spanabfluß zu erreichen. Sie werden in konventionellen CNC-Drehmaschinen eingesetzt. Empfohlen für Stahl und auch für legierten, rostfreien und hitzebeständigen Stahl.  
Max. Bohrtiefe = 3 x Durchmesser (D)

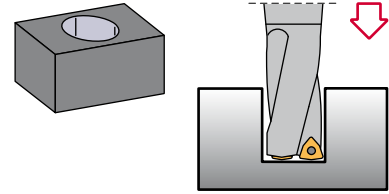

**42..**

Reference Bezeichnung	D	L	L1	L2	a	d	d1	Radial Adj. Radiale Anp. Dmax	Dmax	Nm	Insert size Wendeschneidplatte	kg		
4214.62.017,5	17,5	127	55	56	53	25	40	+1,00	19,5	1622	5507	0.9	WCMX 0302..	0,220
4214.62.018	18	128	55	57	54	25	40	+0,90	19,8	1622	5507	0.9	WCMX 0302..	0,230
4214.62.018,5	18,5	130	55	59	56	25	40	+0,85	20,2	1622	5507	0.9	WCMX 0302..	0,240
4214.62.019	19	131	55	60	57	25	40	+0,80	20,6	1622	5507	0.9	WCMX 0302..	0,240
4214.62.020	20	136	55	64	60	25	40	+0,75	21,5	1622	5507	0.9	WCMX 0302..	0,250
4224.62.022	22	142	55	69	66	25	40	+1,25	24,5	1225	5507	0.9	WCMX 0402..	0,400
4224.62.024	24	150	55	76	72	25	40	+0,75	25,5	1225	5507	0.9	WCMX 0402..	0,450
4224.62.025	25	154	55	79	75	25	40	+0,50	26,0	1225	5507	0.9	WCMX 0402..	0,475
4234.63.026	26	162	60	81	78	32	50	+2,50	31,0	1630	5509	1.4	WCMX 0503..	0,475
4234.63.027	27	165	60	84	81	32	50	+2,20	31,4	1630	5509	1.4	WCMX 0503..	0,500
4234.63.028	28	169	60	87	84	32	50	+2,10	32,2	1630	5509	1.4	WCMX 0503..	0,550
4234.63.029	29	172	60	90	87	32	50	+1,80	32,6	1630	5509	1.4	WCMX 0503..	0,570
4234.63.030	30	177	60	94	90	32	50	+1,80	33,0	1630	5509	1.4	WCMX 0503..	0,600
4244.64.031	31	186	65	97	93	40	60	+3,50	38,0	1635	5510	2.0	WCMX 06T3..	0,850
4244.64.032	32	189	65	100	96	40	60	+3,20	38,4	1635	5510	2.0	WCMX 06T3..	0,900
4244.64.034	34	196	65	106	102	40	60	+2,80	39,6	1635	5510	2.0	WCMX 06T3..	0,975
4244.64.035	35	200	65	109	105	40	60	+2,50	40,0	1635	5510	2.0	WCMX 06T3..	1,000
4244.64.038	38	211	65	118	114	40	60	+1,80	41,0	1635	5510	2.0	WCMX 06T3..	1,170
4244.64.039	39	214	65	121	117	40	60	+1,50	41,6	1635	5510	2.0	WCMX 06T3..	1,200
4244.64.040	40	218	65	124	120	40	60	+1,20	42,0	1635	5510	2.0	WCMX 06T3..	1,300
4254.64.042	42	225	65	130	126	40	60	+4,20	51,0	1640	5515	3.0	WCMX 0804..	1,600
4254.64.043	43	229	65	133	129	40	60	+4,00	51,4	1640	5515	3.0	WCMX 0804..	1,750
4254.64.045	45	237	65	140	135	40	60	+3,60	52,2	1640	5515	3.0	WCMX 0804..	1,900
4254.64.048	48	248	65	149	144	40	60	+2,70	53,4	1640	5515	3.0	WCMX 0804..	2,250
4254.64.049	49	251	65	152	147	40	60	+2,50	54,0	1640	5515	3.0	WCMX 0804..	2,200
4254.64.050	50	255	65	155	150	40	60	+2,20	54,4	1640	5515	3.0	WCMX 0804..	2,400
4254.64.052	52	262	65	161	156	40	60	+1,80	55,6	1640	5515	3.0	WCMX 0804..	2,500
4254.64.054	54	269	65	167	162	40	60	+1,20	56,4	1640	5515	3.0	WCMX 0804..	2,700
4254.64.055	55	274	65	171	165	40	60	+0,80	56,6	1640	5515	3.0	WCMX 0804..	2,850

**WCMX**

80° trigon positive insert with 7° clearance. 80° trigon positive Wendeschneidplatte mit 7° Freiwinkel. H02

Reference / Bez.	l	s	d
WCMX 0302..	3,46	2,38	5,56
WCMX 0402..	3,99	2,38	6,35
WCMX 0503..	5,07	3,18	7,94
WCMX 06T3..	6,14	3,97	9,52
WCMX 0804..	8,14	4,76	12,70

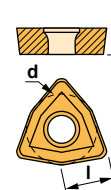

**WCMX**



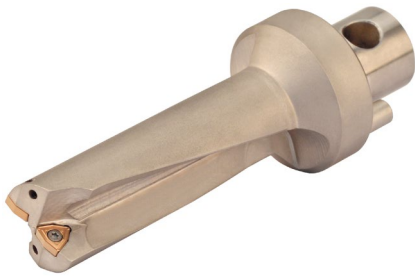

**Characteristics:**

Helical flute indexable insert drill that provides faster cutting speeds and efficient chip removal for use on conventional and C.N.C. machines. It works well on steels, alloyed steels, stainless steels and refractories.  
Max. hole depth = 3 x Diameter (D)

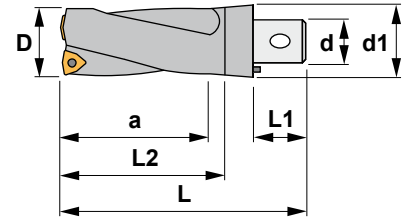

**Eigenschaften:**

Spiralformige Wendschneidplatten-Bohrer um eine höhere Schnittgeschwindigkeit und einen guten Spanabfluß zu erreichen. Sie werden in konventionellen CNC-Drehmaschinen eingesetzt. Empfohlen für Stahl, und auch für legierten, rostfreien und hitzebeständigen Stahl.  
Max. Bohrtiefe = 3 x Durchmesser (D)

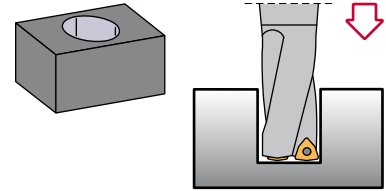

**42<sup>1</sup><sub>4</sub>4.72<sup>72</sup><sub>75</sub>**

Reference Bezeichnung	D	L	L1	L2	a	d	d1	Radial Adj. Radiale Anp. Dmax	Dmax	Nm	Insert size Wendschneidplatte	kg	
4214.72.017,5	17,5	92	20	56	53	20	32	+1,00	19,5	1622 5507	0.9	WCMX 0302..	0,070
4214.72.018	18	93	20	57	54	20	32	+0,90	19,8	1622 5507	0.9	WCMX 0302..	0,080
4214.72.018,5	18,5	95	20	59	56	20	32	+0,85	20,2	1622 5507	0.9	WCMX 0302..	0,080
4214.72.019	19	96	20	60	57	20	32	+0,80	20,6	1622 5507	0.9	WCMX 0302..	0,090
4214.72.020	20	101	20	64	60	20	32	+0,75	21,5	1622 5507	0.9	WCMX 0302..	0,110
4224.73.022	22	112	25	69	66	24	40	+1,25	24,5	1225 5507	0.9	WCMX 0402..	0,320
4224.73.024	24	120	25	76	72	24	40	+0,75	26,5	1225 5507	0.9	WCMX 0402..	0,370
4224.73.025	25	124	25	79	75	24	40	+0,50	26,0	1225 5507	0.9	WCMX 0402..	0,400
4234.74.026	26	132	30	81	78	28	40	+2,50	31,0	1630 5509	1.4	WCMX 0503..	0,375
4234.74.027	27	135	30	84	81	28	40	+2,20	31,4	1630 5509	1.4	WCMX 0503..	0,400
4234.74.028	28	139	30	87	84	28	40	+2,10	32,2	1630 5509	1.4	WCMX 0503..	0,450
4234.74.029	29	142	30	90	87	28	40	+1,80	32,6	1630 5509	1.4	WCMX 0503..	0,470
4234.74.030	30	147	30	94	90	28	40	+1,80	33,0	1630 5509	1.4	WCMX 0503..	0,500
4244.75.031	31	161	40	97	93	36	50	+3,50	38,0	1635 5510	2.0	WCMX 06T3..	0,600
4244.75.032	32	164	40	100	96	36	50	+3,20	38,4	1635 5510	2.0	WCMX 06T3..	0,750
4244.75.034	34	171	40	106	102	36	50	+2,80	39,6	1635 5510	2.0	WCMX 06T3..	0,800
4244.75.035	35	175	40	109	105	36	50	+2,50	40,0	1635 5510	2.0	WCMX 06T3..	0,850
4244.75.038	38	186	40	118	114	36	50	+1,80	41,0	1635 5510	2.0	WCMX 06T3..	1,000
4244.75.039	39	189	40	121	117	36	50	+1,50	41,6	1635 5510	2.0	WCMX 06T3..	1,050
4244.75.040	40	193	40	124	120	36	50	+1,20	42,0	1635 5510	2.0	WCMX 06T3..	1,150

**WCMX**

80° trigon positive insert with 7° clearance. 80° trigon positive Wendschneidplatte mit 7° Freiwinkel. **H02**

Reference / Bez.	l	s	d
WCMX 0302..	3,46	2,38	5,56
WCMX 0402..	3,99	2,38	6,35
WCMX 0503..	5,07	3,18	7,94
WCMX 06T3..	6,14	3,97	9,52

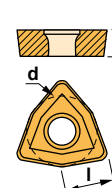





**Characteristics:**

Straight flute indexable insert trepanning drill that provides faster cutting speeds and efficient chip removal for use on conventional and C.N.C. machines. It works well on steels, alloyed steels, stainless steels and refractories. Max. hole depth = 2.5 x Diameter (D)

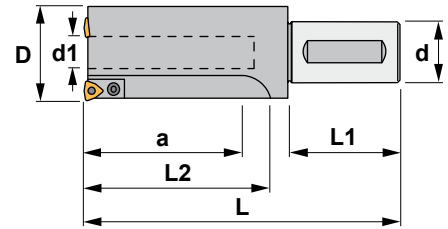

**Eigenschaften:**

Gerader Wendeschneidplatten-Kernbohrer um eine höhere Schnittgeschwindigkeit und einen guten Spanabfluß zu erreichen. Sie werden in konventionellen CNC-Drehmaschinen eingesetzt. Empfohlen für Stahl, und auch für legierten, rostfreien und hitzebeständigen Stahl. Max. Bohrtiefe = 2.5 x Durchmesser (D)

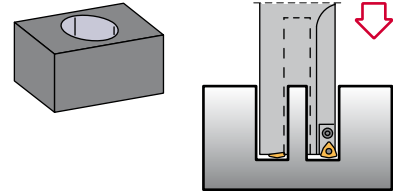

## 4744.64

Reference Bezeichnung	D	L	L1	L2	a	d	d1	Insert size Wendeschneidplatte	KG
4744.64.060	60	260	65	160	150	40	24	WCMX 06T3..	3,100
4744.64.065	65	275	65	175	165	40	29	WCMX 06T3..	3,700
4744.64.070	70	285	65	185	175	40	34	WCMX 06T3..	4,250
4744.64.075	75	300	65	200	190	40	39	WCMX 06T3..	5,100
4744.64.080	80	310	65	210	200	40	44	WCMX 06T3..	5,800
4744.64.085	85	325	65	225	215	40	49	WCMX 06T3..	6,500
4744.64.090	90	335	65	235	225	40	54	WCMX 06T3..	7,250
4744.64.095	95	350	65	250	240	40	59	WCMX 06T3..	8,200
4744.64.100	100	360	65	260	250	40	64	WCMX 06T3..	9,050

Reference Bezeichnung										Nm
4744.64.060	1396	5510	1405	1635	1503	5002	5005	6806	6816	2.0
4744.64.065	1396	5510	1405	1635	1503	5002	5005	6806	6816	2.0
4744.64.070	1396	5510	1405	1635	1503	5002	5005	6806	6816	2.0
4744.64.075	1396	5510	1405	1635	1503	5002	5005	6806	6816	2.0
4744.64.080	1396	5510	1405	1635	1503	5002	5005	6806	6816	2.0
4744.64.085	1396	5510	1405	1635	1503	5002	5005	6806	6816	2.0
4744.64.090	1396	5510	1405	1635	1503	5002	5005	6806	6816	2.0
4744.64.095	1396	5510	1405	1635	1503	5002	5005	6806	6816	2.0
4744.64.100	1396	5510	1405	1635	1503	5002	5005	6806	6816	2.0

### WCMX

80° trigon positive insert with 7° clearance.  
80° trigon positive Wendeschneidplatte mit 7° Freiwinkel. H02

Reference / Bez.	l	s	d
WCMX 06T3..	6,14	3,97	9,52

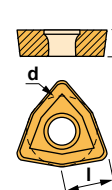

### WCMX







**Characteristics:**  
 Spot facing milling cutter for  
 flat screw heads.  
 For counterboring operations.

**Eigenschaften:**  
 Fräser zum Planenken für flache  
 Schraubenköpfe.  
 Zum Planenken.

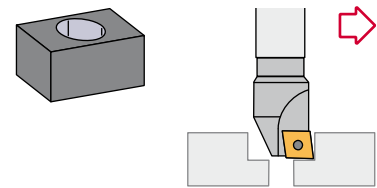
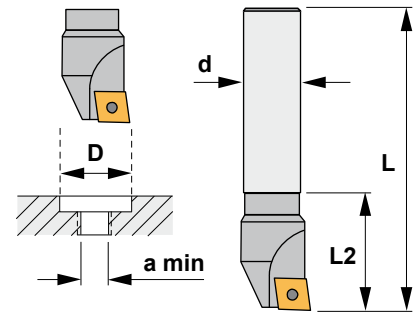

## 02<sup>1</sup><sub>3</sub>4.00

Reference Bezeichnung		D	d	a min	L	L2		Nm	Insert size Wendeschneidplatte	
0214.00.010	1	10	12	4	85	15	1425 5507	0.9	CC.. 0602..	0,100
0214.00.011	1	11	12	4	85	15	1425 5507	0.9	CC.. 0602..	0,100
0214.00.012	1	12	12	4	85	15	1425 5507	0.9	CC.. 0602..	0,100
0214.00.013	1	13	12	5	85	15	1425 5507	0.9	CC.. 0602..	0,100
0214.00.014	1	14	12	5	85	19	1425 5507	0.9	CC.. 0602..	0,100
0214.00.015	1	15	12	5	85	19	1425 5507	0.9	CC.. 0602..	0,100
0214.00.016	1	16	12	5	85	19	1425 5507	0.9	CC.. 0602..	0,100
0234.00.017	1	17	16	5	95	30	1440 5515	3.0	CC.. 09T3..	0,125
0234.00.018	1	18	16	5	95	30	1440 5515	3.0	CC.. 09T3..	0,125
0234.00.019	1	19	16	5	95	32	1440 5515	3.0	CC.. 09T3..	0,125
0234.00.020	1	20	16	5	95	32	1440 5515	3.0	CC.. 09T3..	0,125
0234.00.022	1	22	16	6	95	32	1440 5515	3.0	CC.. 09T3..	0,150
0234.00.025	1	25	16	8	95	32	1440 5515	3.0	CC.. 09T3..	0,150
0234.00.026	1	26	16	8	95	32	1440 5515	3.0	CC.. 09T3..	0,150
0234.00.028	1	28	16	10	95	32	1440 5515	3.0	CC.. 09T3..	0,150
0234.00.030	1	30	16	10	95	32	1440 5515	3.0	CC.. 09T3..	0,150
0234.00.032	1	32	16	12	95	32	1440 5515	3.0	CC.. 09T3..	0,150
0234.00.033	1	33	16	12	95	32	1440 5515	3.0	CC.. 09T3..	0,150

**CC..** 80° rhombic positive inserts with 7° clearance. F12  
 80° rhombische positive Wendeschneidplatten mit 7° Freiwinkel.

Reference / Bez.	l	s	d
CC.. 0602..	6,45	2,38	6,35
CC.. 09T3..	9,65	3,97	9,52

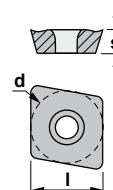

**CCGT-AL**



**CCKT**



**CCMW**





**Characteristics:**  
Back draft spot facing milling cutter  
with internal coolant for flat screw  
heads.  
For counterboring operations.

**Eigenschaften:**  
Rückwärts-Plansenker  
mit Innenkühlung für  
flache Schraubenköpfe.  
Zum Plansenken.

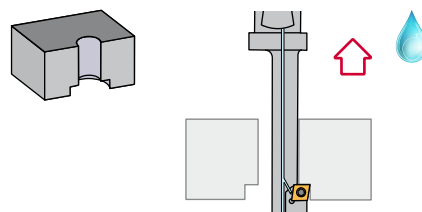
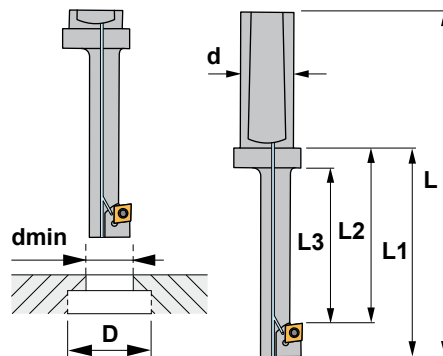

## 9614.61

Reference Bezeichnung		D	dmin	d	L	L1	L2	L3	D1	Insert size Wendeschneidplatte	
9614.61.018	1	18	10,5	20	112	62	47	40	25	CC.. 0602..	0,280
9614.61.020	1	20	13,0	20	113	63	52	45	25	CC.. 0602..	0,300
9614.61.024	1	24	15,0	20	118	68	57	50	25	CC.. 0602..	0,320
9614.61.026	1	26	17,0	20	128	78	67	60	25	CC.. 0602..	0,380
9614.61.030	1	30	19,0	20	138	88	77	70	25	CC.. 0602..	0,400
9614.61.033	1	33	21,0	20	152	102	82	75	25	CC.. 09T3..	0,430

Reference Bezeichnung			Nm
9614.61.018	1425	5507	0.9
9614.61.020	1425	5507	0.9
9614.61.024	1425	5507	0.9
9614.61.026	1225	5507	0.9
9614.61.030	1225	5507	0.9
9614.61.033	1440	5515	3.0

**CC..** 80° rhombic positive inserts with 7° clearance. F12  
80° rhombische positive Wendeschneidplatten mit 7° Freiwinkel.

Reference / Bez.	l	s	d
CC.. 0602..	6,45	2,38	6,35
CC.. 09T3..	9,65	3,97	9,52

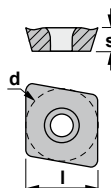

**CCGT-AL**



**CCKT**



**CCMW**





**Characteristics:**  
Back draft countersink milling cutter with internal coolant.  
Recommended for small conventional milling machines and machining centers.

**Eigenschaften:**  
Rückwärts-Senker mit Innenkühlung für flache Schraubenköpfe.  
Für konventionelle Fräsmaschinen und Bearbeitungszentren geeignet.

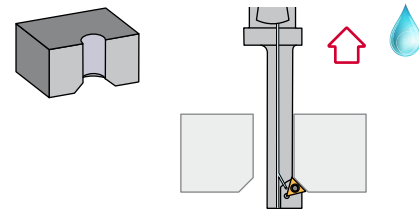
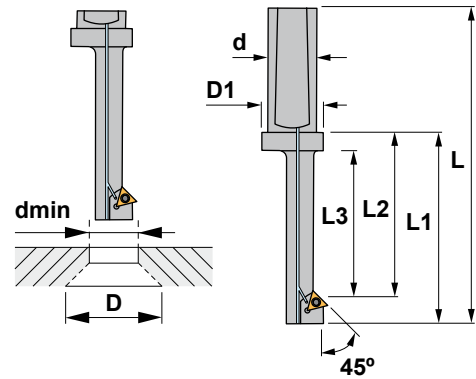

## 9624.61

Reference Bezeichnung		D	dmin	d	L	L1	L2	L3	D1	Insert size Wendeschneidplatte	
9624.61.015	1	15	10	20	105	55	42	35	25	CC.. 0602..	0,280
9624.61.020	1	20	14	20	110	60	47	40	25	CC.. 0602..	0,300
9624.61.023	1	23	17	20	120	70	57	50	25	TC.. 1102..	0,320
9624.61.027	1	27	21	20	140	90	77	70	25	TC.. 1102..	0,380
9624.61.031	1	31	24	20	150	100	87	80	25	TC.. 1102..	0,400

Reference Bezeichnung			Nm
9624.61.015	1425	5507	0.9
9624.61.020	1425	5507	0.9
9624.61.023	1225	5507	0.9
9624.61.027	1225	5507	0.9
9624.61.031	1225	5507	0.9

**CC..** 80° rhombic positive inserts with 7° clearance. F12  
80° rhombische positive Wendeschneidplatten mit 7° Freiwinkel.

Reference / Bez.	l	s	d
CC.. 0602..	6,45	2,38	6,35

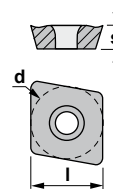

CCGT-AL



CCKT



CCMW



**TC..** Triangular positive inserts with 7° clearance. F21  
Dreikantige positive Wendeschneidplatten mit 7° Freiwinkel.

Reference / Bez.	l	s	d
TC.. 1102..	6,45	2,38	6,35

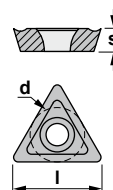

TCGT-AL



TCMT-39



TCMW



## Drills - Recommendations for the assembly

### Drills for indexable inserts

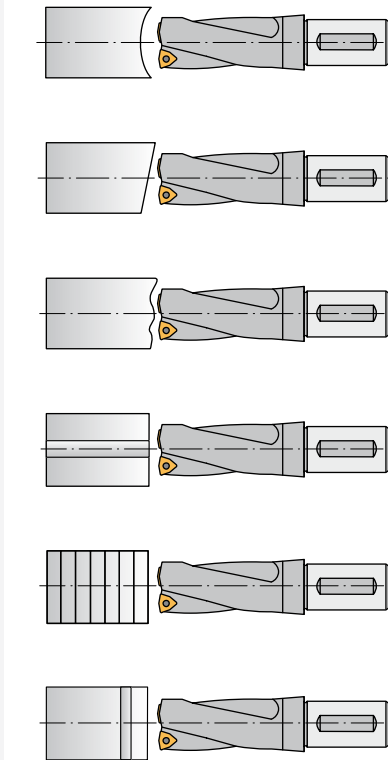

A concave surface is not normally recommended because there is the possibility that the tool turns away from the center. Feed should be reduced to 1/3 of the recommended.

The surface of the tool to be drilled on should be preferably even. If the angles exceed  $2^\circ$ , feed should be reduced to 1/3 of the recommended.

If the starting surface is an uneven surface of the component, feed should be reduced so that the chip of the cutting edges can be avoided. The same can also happen at the way out from the tool.

When working with a hole made beforehand, this should not be bigger than 1/4 of the final size, because the tool could turn away.

There is the possibility to drill sets of more than one piece.

When the tool has a crossed hole, which is 1/4 bigger than the diameter of the drill, feed should be reduced when going through it.

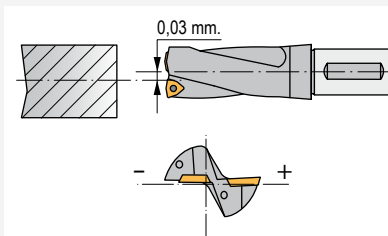

### Fixed drills

The axis of the tool should not be deviated from the center of the piece more than 0,03 mm. so that the pointed tolerances are acquired.

The tool should be assembled in a way that the face of the central insert goes parallel to the cross movement axis of the machine.

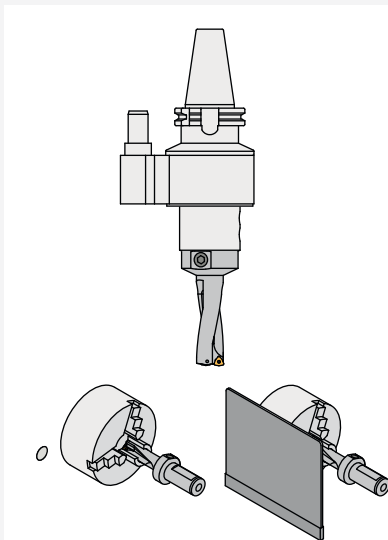

### Drilling with drill-holders with housing for cutting fluid supply

When a drillholder with a housing supplier of cutting fluid is used, it has to have a fixed top so as to avoid that the housing turns around.

If the cutting fluid has some dirty rests, this could lock the rotary housing and, consequently, the supplier tube would roll up around it, which could cause a serious accident.

If the drillholder has not been used for a long time, check if it turns round in the housing before the spindle starts working.

### Drilling of through-holes

When through-holes are drilled, a disk is produced after the drill has finished the hole. This disk is often thrown away at high speed and can cause injuries and accidents.

In order to avoid this accident, a suitable safety system has to be placed around the dish.

## Bohrer – Einsatzempfehlungen

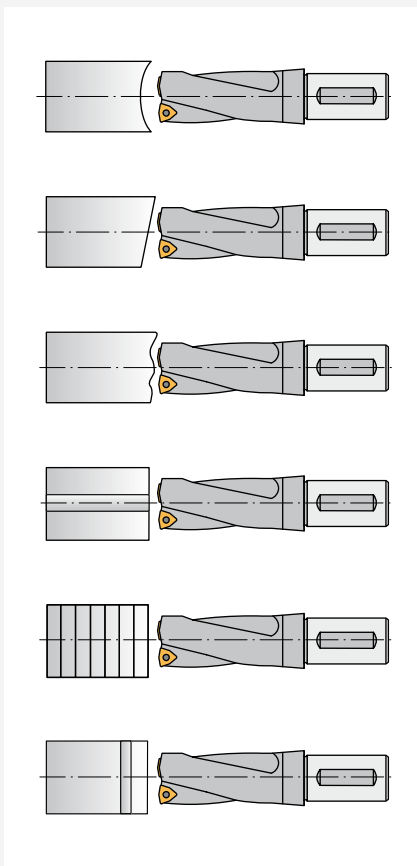

### Bohrer für Wendeschneidplatten

Eine konkave Oberfläche ist normalerweise nicht empfohlen, weil die Möglichkeit besteht, daß der Bohrer von der Mitte abgelenkt wird. Der Vorschub sollte auf 1/3 des empfohlenen Wertes vermindert werden.

Die Anbohrfläche sollte wenn möglich eben sein. Wenn die Winkel mehr als 2° betragen, sollte man den Vorschub beim Anbohren auf 1/3 des empfohlenen Wertes vermindern.

Wenn man ab einer ungleichmäßigen Oberfläche beginnt, muss der Vorschub beim Anbohren reduziert werden, so daß ein Ausbröckeln der Schneidkante verhindert werden kann. Das gleiche kann auch beim Durchbohren passieren.

Wenn man in einem Werkstück bohrt, das schon angebohrt ist, darf diese vorgebohrte Bohrung nicht größer als 1/4 des gewünschten Enddurchmessers haben, da der Bohrer sonst von der Mitte abgelenkt wird.

Es ist möglich, mehrere übereinander liegende Werkstücke zu bohren.

Wenn das Werkstück eine Querbohrung von mehr als 1/4 des Bohrerdurchmessers hat, muß der Vorschub vermindert werden, wenn man durch diese Bohrung bohrt.

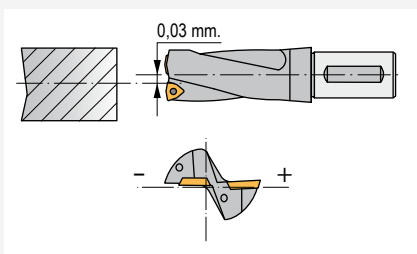

### Nichtrotierende Bohrer

Die Werkzeugachse darf nicht mehr als 0,03 mm von der Mitte des Werkstücks abgelenkt sein, damit man die angegebenen Toleranzen erreichen kann.

Der Bohrer muß so positioniert werden, daß die Schneidkante der Mittelplatte parallel zur X-Achse der Maschine ist.

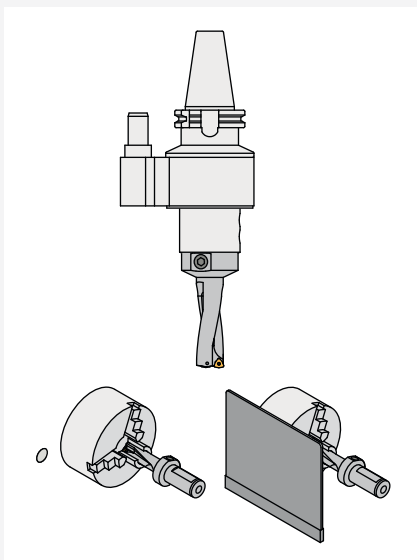

### Bohren mit Halter mit Kühlmittelgehäuse

Wenn man einen Halter mit Kühlmittelgehäuse verwendet, muß eine Arretierung vorhanden sein, die das Rotieren des Gehäuses verhindert.

Falls das Kühlmittel durch Spanpartikel verschmutzt ist, könnte das Gehäuse blockieren und in diesem Fall würde das Gehäuse die Zuleitung mit sich ziehen, und ein ernsthafter Unfall könnte die Folge sein.

Wenn ein Halter mit Kühlmittelgehäuse längere Zeit nicht verwendet worden ist, muß vor Inbetriebnahme der Maschine geprüft werden, ob sich der Halter im Gehäuse leicht drehen läßt.

### Bohren von Durchgangsbohrungen

Wenn man Durchgangsbohrungen bohrt, entsteht beim Austritt des Bohrers aus dem Werkstück eine Scheibe, die oft mit hoher Geschwindigkeit aus dem Spannfutter geschleudert wird und Schaden und Verletzungen verursachen kann.

Um dies zu verhindern, muß eine Schutzabdeckung um das Spannfutter vorhanden sein.



Material	HB	Condition	D mm.	Feed mm./Rev.	Cutting speed mm./min.
Unalloyed steel <b>P</b>	90-200	Non-hardened 0,05-0,25%C	17,5-25,4 26,0-30,0 31,0-41,3 42,0-80,0	0,04-0,08 0,06-0,10 0,08-0,12 0,08-0,12	100-250
Unalloyed steel	125-225 150-225 180-225	Non-hardened 0,25-0,55%C Non-hardened 0,55-0,80%C High carbon & carbon tool steel	17,5-25,4 26,0-30,0 31,0-41,3 42,0-80,0	0,04-0,12 0,09-0,19 0,11-0,20 0,14-0,25	100-250
Low alloyed steel	150-260	Non-hardened	17,5-25,4 26,0-30,0 31,0-41,3 42,0-80,0	0,08-0,12 0,09-0,16 0,11-0,20 0,14-0,22	90-250
Low alloyed steel	220-400	Hardened	17,5-25,4 26,0-30,0 31,0-41,3 42,0-80,0	0,06-0,10 0,08-0,15 0,08-0,15 0,11-0,20	80-220
High alloyed steel	150-250 150-250	Annealed Annealed HSS	17,5-25,4 26,0-30,0 31,0-41,3 42,0-80,0	0,08-0,12 0,09-0,18 0,11-0,22 0,14-0,25	100-220
High alloyed steel	250-350 250-400	Hardened tool steel Hardened steel	17,5-25,4 26,0-30,0 31,0-41,3 42,0-80,0	0,08-0,12 0,09-0,15 0,11-0,17 0,12-0,20	90-200
Stainless steel	150-270	Ferritic, Martensitic 13-25%Cr	17,5-25,4 26,0-30,0 31,0-41,3 42,0-80,0	0,04-0,12 0,10-0,16 0,11-0,18 0,11-0,18	90-190
Steel castings	150-270	Unalloyed	17,5-25,4 26,0-30,0 31,0-41,3 42,0-80,0	0,05-0,08 0,06-0,10 0,09-0,15 0,11-0,18	100-230
Steel castings	90-225	Low alloyed (alloying elements < 5%)	17,5-25,4 26,0-30,0 31,0-41,3 42,0-80,0	0,08-0,12 0,09-0,15 0,12-0,20 0,14-0,22	90-200
Stainless steel <b>M</b>	150-250	Austenitic Ni > 8%, 18-25% Cr	17,5-25,4 26,0-30,0 31,0-41,3 42,0-80,0	0,04-0,12 0,10-0,16 0,11-0,18 0,11-0,18	70-150
Malleable cast iron <b>K</b>	110-145	Ferritic (short chipping)	17,5-25,4 26,0-30,0 31,0-41,3 42,0-80,0	0,11-0,18 0,14-0,22 0,17-0,27 0,18-0,30	90-200
Malleable cast iron	150-270	Pearlitic (long chipping)	17,5-25,4 26,0-30,0 31,0-41,3 42,0-80,0	0,09-0,15 0,11-0,19 0,12-0,20 0,14-0,22	80-180
Grey cast iron	150-220	Low tensile strength	17,5-25,4 26,0-30,0 31,0-41,3 42,0-80,0	0,09-0,15 0,14-0,22 0,15-0,25 0,18-0,30	80-180
Grey cast iron	200-330	High tensile strength	17,5-25,4 26,0-30,0 31,0-41,3 42,0-80,0	0,09-0,15 0,12-0,20 0,14-0,22 0,15-0,25	70-150
Nodular cast iron	125-230	Ferritic	17,5-25,4 26,0-30,0 31,0-41,3 42,0-80,0	0,09-0,15 0,14-0,22 0,15-0,25 0,17-0,28	80-180
Nodular cast iron	200-300	Pearlitic	17,5-25,4 26,0-30,0 31,0-41,3 42,0-80,0	0,09-0,15 0,12-0,20 0,14-0,22 0,15-0,30	70-150
Aluminium alloys	75-150 40-100 70-125	Wrought, solution treated & aged Cast Cast, solution treated & aged	17,5-25,4 26,0-30,0 31,0-41,3 42,0-80,0	0,08-0,12 0,11-0,17 0,17-0,27 0,17-0,27	150-375
Copper and copper alloys	50-160	Free cutting alloys (pb>1%) Brass and leaded bronzes (pb<1%)	17,5-25,4 26,0-30,0 31,0-41,3 42,0-80,0	0,09-0,15 0,09-0,15 0,15-0,25 0,15-0,25	80-160



Materialien	HB	Beschaffenheit	D mm.	Vorschub mm./Rev.	Schnittgeschwindigkeit mm./min.
Unlegierter Stahl <b>P</b>	90-200	Nicht vergütet 0,05-0,25%C	17,5-25,4	0,04-0,08	100-250
			26,0-30,0	0,06-0,10	
			31,0-41,3	0,08-0,12	
			42,0-80,0	0,08-0,12	
Unlegierter Stahl	125-225 150-225 180-225	Nicht vergütet 0,25-0,55%C Nicht vergütet 0,55-0,80%C Stahl mit hohem Kohlenstoff-Inhalt und Kohlenstoff-Werkzeugstahl	17,5-25,4	0,04-0,12	100-250
			26,0-30,0	0,09-0,19	
			31,0-41,3	0,11-0,20	
			42,0-80,0	0,14-0,25	
Niedrig legierter Stahl	150-260	Nicht vergütet	17,5-25,4	0,08-0,12	90-250
			26,0-30,0	0,09-0,16	
			31,0-41,3	0,11-0,20	
			42,0-80,0	0,14-0,22	
Niedriglegierter Stahl	220-400	Vergütet	17,5-25,4	0,06-0,10	80-220
			26,0-30,0	0,08-0,15	
			31,0-41,3	0,08-0,15	
			42,0-80,0	0,11-0,20	
Hochlegierter Stahl	150-250 150-250	Geglüht Geglühteter HSS	17,5-25,4	0,08-0,12	100-220
			26,0-30,0	0,09-0,18	
			31,0-41,3	0,11-0,22	
			42,0-80,0	0,14-0,25	
Hochlegierter Stahl	250-350 250-400	Vergüteter Werkzeugstahl Vergüteter Stahl	17,5-25,4	0,08-0,12	90-200
			26,0-30,0	0,09-0,15	
			31,0-41,3	0,11-0,17	
			42,0-80,0	0,12-0,20	
Rostfreier Stahl	150-270	Ferritisch, Martensitisch 13-25%Cr	17,5-25,4	0,04-0,12	90-190
			26,0-30,0	0,10-0,16	
			31,0-41,3	0,11-0,18	
			42,0-80,0	0,11-0,18	
Stahlguß	150-270	Unlegiert	17,5-25,4	0,05-0,08	100-230
			26,0-30,0	0,06-0,10	
			31,0-41,3	0,09-0,15	
			42,0-80,0	0,11-0,18	
Stahlguß	90-225	Niedrig legiert (Legierungsanteile < 5%)	17,5-25,4	0,08-0,12	90-200
			26,0-30,0	0,09-0,15	
			31,0-41,3	0,12-0,20	
			42,0-80,0	0,14-0,22	
Rostfreier Stahl <b>M</b>	150-250	Austenitisch Ni > 8%, 18-25% Cr	17,5-25,4	0,04-0,12	70-150
			26,0-30,0	0,10-0,16	
			31,0-41,3	0,11-0,18	
			42,0-80,0	0,11-0,18	
Temperguß <b>K</b>	110-145	Ferritisch (kurzspanend)	17,5-25,4	0,11-0,18	90-200
			26,0-30,0	0,14-0,22	
			31,0-41,3	0,17-0,27	
			42,0-80,0	0,18-0,30	
Temperguß	150-270	Perlitisch (langspanend)	17,5-25,4	0,09-0,15	80-180
			26,0-30,0	0,11-0,19	
			31,0-41,3	0,12-0,20	
			42,0-80,0	0,14-0,22	
Grauguß	150-220	Niedrige Zugfestigkeit	17,5-25,4	0,09-0,15	80-180
			26,0-30,0	0,14-0,22	
			31,0-41,3	0,15-0,25	
			42,0-80,0	0,18-0,30	
Grauguß	200-330	Hohe Zugfestigkeit	17,5-25,4	0,09-0,15	70-150
			26,0-30,0	0,12-0,20	
			31,0-41,3	0,14-0,22	
			42,0-80,0	0,15-0,25	
Kugelgraphiteguß	125-230	Ferritisch	17,5-25,4	0,09-0,15	80-180
			26,0-30,0	0,14-0,22	
			31,0-41,3	0,15-0,25	
			42,0-80,0	0,17-0,28	
Kugelgraphiteguß	200-300	Perlitisch	17,5-25,4	0,09-0,15	70-150
			26,0-30,0	0,12-0,20	
			31,0-41,3	0,14-0,22	
			42,0-80,0	0,15-0,30	
Aluminium-Legierungen	75-150 40-100 70-125	Geschmiedet, lösungsbehandelt und gealtert Gegossen Geschmiedet, lösungsbehandelt und gealtert	17,5-25,4	0,08-0,12	150-375
			26,0-30,0	0,11-0,17	
			31,0-41,3	0,17-0,27	
			42,0-80,0	0,17-0,27	
Kupfer und Kupferlegierungen	50-160	Automatenstähle (pb>1%) Messing und bleilegierte Bronzen (pb<1%)	17,5-25,4	0,09-0,15	80-160
			26,0-30,0	0,09-0,15	
			31,0-41,3	0,15-0,25	
			42,0-80,0	0,15-0,25	





Material	P	HB	Condition	D mm.	Feed mm./Rev.	Cutting speed m/min
Unalloyed steel		90-200 125-225 150-225 180-225	Non-hardened 0,05-0,25%C Non-hardened 0,25-0,55%C Non-hardened 0,55-0,80%C High carbon & carbon tool steel	60-100	0,08-0,12 0,11-0,18 0,11-0,18 0,11-0,18	150-250 100-250 100-250 100-250
Low alloyed steel		150-260 220-400	Non-hardened Hardened	60-100	0,11-0,18 0,08-0,12	100-250 100-220
High alloyed steel		150-250 150-250 250-350 250-400	Annealed Annealed HSS Hardened tool steel Hardened steel	60-100	0,11-0,19 0,11-0,19 0,11-0,18 0,11-0,17	100-220 100-220 100-200 100-200
Stainless steel		150-270	Ferritic, martensitic 13-25%Cr	60-100	0,11-0,17	100-200
Steel castings		90-225 150-250	Unalloyed Low alloyed (< 5%)	60-100	0,12-0,20 0,11-0,17	100-200 100-150
Material	M	HB	Condition	D mm.	Feed mm./Rev.	Cutting speed m/min
Stainless steel		150-270	Austenitic Ni > 8%, 18-25% Cr	60-100	0,09-0,15	100-230
Material	K	HB	Condition	D mm.	Feed mm./Rev.	Cutting speed m/min
Malleable cast iron		110-145 150-270	Ferritic (short chipping) Pearlitic (long chipping)	60-100 60-100	0,17-0,27 0,12-0,20	100-200 90-180
Grey cast iron		150-220 200-300	Low tensile strength High tensile strength	60-100 60-100	0,15-0,25 0,14-0,22	90-180 90-150
Nodular cast iron		125-230 200-300	Ferritic Pearlitic	60-100 60-100	0,15-0,25 0,14-0,22	100-180 90-150
Aluminium alloys		75-150 40-100 70-125	Wrought, solution treated & aged Cast Cast, solution treated & aged	60-100 60-100 60-100	0,17-0,27 0,17-0,27 0,17-0,27	150-375 150-375 150-375
Copper and copper alloys		50-160	Free cutting alloys (pb>1%) Brass and leaded bronzes (pb<1%)	60-100	0,15-0,25	100-160



Materialien	P	HB	Beschaffenheit	D mm.	Vorschub mm./Rev.	Schnittgeschwindigkeit m/min
Unlegierter Stahl		90-200 125-225 150-225 180-225	Nicht vergütet 0,05-0,25%C Nicht vergütet 0,25-0,55%C Nicht vergütet 0,55-0,80%C Stahl mit hohem Kohlenstoff-Inhalt und Kohlenstoff-Werkzeugstahl	60-100	0,08-0,12 0,11-0,18 0,11-0,18 0,11-0,18	150-250 100-250 100-250 100-250
Niedrig legierter Stahl		150-260 220-400	Nicht vergütet Vergütet	60-100	0,11-0,18 0,08-0,12	100-250 100-220
Hochlegierter Stahl		150-250 150-250 250-350 250-400	Geglüht Geglühteter HSS Vergüteter Werkzeugstahl Vergüteter Stahl	60-100	0,11-0,19 0,11-0,19 0,11-0,18 0,11-0,17	100-220 100-220 100-200 100-200
Rostfreier Stahl		150-270	Ferritisch, Martensitisch 13-25%Cr	60-100	0,11-0,17	100-200
Stahlguß		90-225 150-250	Unlegiert Niedrig legiert (< 5%)	60-100	0,12-0,20 0,11-0,17	100-200 100-150
Materialien	M	HB	Beschaffenheit	D mm.	Vorschub mm./Rev.	Schnittgeschwindigkeit m/min
Rostfreier Stahl		150-270	Austenitisch Ni > 8%, 18-25% Cr	60-100	0,09-0,15	100-230
Materialien	K	HB	Beschaffenheit	D mm.	Vorschub mm./Rev.	Schnittgeschwindigkeit m/min
Temperguß		110-145 150-270	Ferritisch (kurzspanend) Perlitisch (langspanend)	60-100 60-100	0,17-0,27 0,12-0,20	100-200 90-180
Grauguß		150-220 200-300	Niedrige Zugfestigkeit Hohe Zugfestigkeit	60-100 60-100	0,15-0,25 0,14-0,22	90-180 90-150
Kugelgraphiteguß		125-230 200-300	Ferritisch Perlitisch	60-100 60-100	0,15-0,25 0,14-0,22	100-180 90-150
Aluminium-Legierungen		75-150 40-100 70-125	Geschmiedet, lösungsbehandelt und gealtert Gegossen Geschmiedet, lösungsbehandelt und gealtert	60-100 60-100 60-100	0,17-0,27 0,17-0,27 0,17-0,27	150-375 150-375 150-375
Kupfer und Kupferlegierungen		50-160	Automatenstähle (pb>1%) Messing und bleilegierte Bronzen (pb<1%)	60-100	0,15-0,25	100-160



**ISO Tolerances for Shafts (ISO 286-2)  
ISO Toleranzen für Aufnahmen (ISO 286-2)**

Nominal Shaft Sizes (mm) / Nenn-Abmessungen der Aufnahmen (mm)

bigger than größer als	3	6	10	18	30	40	50	65	80	100	120	140	160	180	200	225	250	280	315	355
until bis	6	10	18	30	40	50	65	80	100	120	140	160	180	200	225	250	280	315	355	400
Micrometres / Mikrometer																				
a12	-270 -390	-280 -430	-290 -470	-300 -510	-310 -560	-320 -570	-340 -640	-360 -660	-380 -730	-410 -760	-460 -860	-520 -920	-580 -980	-660 -1120	-740 -1200	-820 -1280	-920 -1440	-1050 -1570	-1200 -1770	-1350 -1920
d6	-30 -38	-40 -49	-50 -61	-65 -78	-80 -96	-100 -119	-120 -142	-145 -170	-170 -199	-190 -222	-210 -246									
e6	-20 -28	-25 -34	-32 -43	-40 -53	-50 -66	-60 -79	-72 -94	-85 -110	-100 -129	-110 -142	-125 -161									
e13	-20 -200	-25 -245	-32 -302	-40 -370	-50 -440	-60 -520	-72 -612	-85 -715	-100 -820	-110 -920	-125 -1015									
f5	-10 -15	-13 -19	-16 -24	-20 -29	-25 -36	-30 -43	-36 -51	-43 -61	-50 -70	-56 -79	-62 -87									
f6	-10 -18	-13 -22	-16 -27	-20 -33	-25 -41	-30 -49	-36 -58	-43 -68	-50 -79	-56 -88	-62 -98									
f7	-10 -22	-13 -23	-16 -34	-20 -41	-25 -50	-30 -60	-36 -71	-43 -83	-50 -96	-56 -108	-62 -119									
g5	-4 -9	-5 -11	-6 -14	-7 -16	-9 -20	-10 -23	-12 -27	-14 -32	-15 -35	-17 -40	-18 -43									
g6	-4 -12	-5 -14	-6 -17	-7 -20	-9 -25	-10 -29	-12 -34	-14 -39	-15 -44	-17 -49	-18 -54									
g7	-4 -16	-5 -20	-6 -24	-7 -28	-9 -34	-10 -40	-12 -47	-14 -54	-15 -61	-17 -69	-18 -75									
h4	-0 -4	-0 -4	-0 -5	-0 -6	-0 -7	-0 -8	-0 -10	-0 -12	-0 -14	-0 -16	-0 -18									
h5	-0 -5	-0 -6	-0 -8	-0 -9	-0 -11	-0 -13	-0 -15	-0 -18	-0 -20	-0 -23	-0 -25									
h6	-0 -8	-0 -9	-0 -11	-0 -13	-0 -16	-0 -19	-0 -22	-0 -25	-0 -29	-0 -32	-0 -36									
h7	-0 -12	-0 -15	-0 -18	-0 -21	-0 -25	-0 -30	-0 -35	-0 -40	-0 -46	-0 -52	-0 -57									
h8	-0 -18	-0 -22	-0 -27	-0 -33	-0 -39	-0 -46	-0 -54	-0 -63	-0 -72	-0 -81	-0 -89									
h9	-0 -30	-0 -36	-0 -43	-0 -52	-0 -62	-0 -74	-0 -87	-0 -100	-0 -115	-0 -130	-0 -140									
h10	-0 -48	-0 -58	-0 -70	-0 -84	-0 -100	-0 -120	-0 -140	-0 -160	-0 -185	-0 -210	-0 -230									
h11	-0 -75	-0 -90	-0 -110	-0 -130	-0 -160	-0 -190	-0 -220	-0 -250	-0 -290	-0 -320	-0 -360									
h12	-0 -120	-0 -150	-0 -180	-0 -210	-0 -250	-0 -300	-0 -350	-0 -400	-0 -460	-0 -520	-0 -570									
j5	+3 -2	+4 -2	+5 -3	+5 -4	+6 -5	+6 -7	+6 -9	+7 -11	+7 -13	+7 -16	+7 -18									
j6	+6 -2	+7 -2	+8 -3	+9 -4	+11 -5	+12 -7	+13 -9	+14 -11	+16 -13	+16 -16	+18 -18									
j7	+8 -4	+10 -5	+12 -6	+13 -8	+15 -10	+18 -12	+20 -15	+22 -18	+25 -21	+26 -26	+29 -28									
js5	+2.5 -2.5	+3 -3	+4 -4	+4.5 -4.5	+5.5 -5.5	+6.5 -6.5	+7.5 -7.5	+9 -9	+10 -10	+11.5 -11.5	+12.5 -12.5									
js6	+4 -4	+4.5 -4.5	+5.5 -5.5	+6.5 -6.5	+8 -8	+9.5 -9.5	+11 -11	+12.5 -12.5	+14.5 -14.5	+16 -16	+18 -18									
js7	+6 -6	+7.5 -7.5	+9 -9	+10.5 -10.5	+12.5 -12.5	+15 -15	+17.5 -17.5	+20 -20	+23 -23	+26 -26	+28.5 -28.5									
k5	+6 +1	+7 +1	+9 +1	+11 +2	+13 +2	+15 +2	+18 +3	+21 +3	+24 +4	+27 +4	+29 +4									
k6	+9 +1	+10 +1	+12 +1	+15 +2	+18 +2	+21 +2	+25 +3	+28 +3	+33 +4	+36 +4	+40 +4									
k7	+13 +1	+16 +1	+19 +1	+23 +2	+27 +2	+32 +2	+38 +3	+43 +3	+50 +4	+56 +4	+61 +4									
m5	+9 +4	+12 +6	+15 +7	+17 +8	+20 +9	+24 +11	+28 +13	+33 +15	+37 +17	+43 +20	+46 +21									
m6	+12 +4	+15 +6	+18 +7	+21 +8	+25 +9	+30 +11	+35 +13	+40 +15	+46 +17	+52 +20	+57 +21									
m7	+16 +4	+21 +6	+25 +7	+29 +8	+34 +9	+41 +11	+48 +13	+55 +15	+63 +17	+72 +20	+78 +21									
n5	+13 +8	+16 +10	+20 +12	+24 +15	+28 +17	+33 +20	+38 +23	+45 +27	+51 +31	+57 +34	+62 +37									
n6	+16 +8	+19 +10	+23 +12	+28 +15	+33 +17	+39 +20	+45 +23	+52 +27	+60 +31	+66 +34	+73 +37									
n7	+20 +8	+25 +10	+30 +12	+36 +15	+42 +17	+50 +20	+58 +23	+67 +27	+77 +31	+86 +34	+94 +37									
p5	+17 +12	+21 +15	+26 +18	+31 +22	+37 +26	+45 +32	+52 +37	+61 +43	+70 +50	+79 +56	+87 +62									
p6	+20 +12	+24 +15	+29 +18	+35 +22	+42 +26	+51 +32	+59 +37	+68 +43	+79 +50	+88 +56	+98 +62									
r6	+23 +15	+28 +19	+34 +23	+41 +28	+50 +34	+60 +41	+62 +43	+73 +51	+76 +54	+88 +63	+90 +65	+93 +68	+106 +77	+109 +80	+113 +84	+126 +94	+130 +98	+144 +108	+150 +114	