

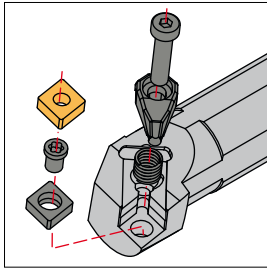

BORING BARS BOHRSTANGEN

Clamping systems Klemmsysteme	A170
Code system (ISO) Kodifizierung (ISO)	A171
Applications index Anwendungen	A172-174
Dimple lock boring bars Bohrstangen mit Dimple Lock-Klemmung	A176-177
Wedge clamp boring bars / Double lock boring bars Bohrstangen mit Prätzen-Klemmung / Bohrstangen mit Doppel-Klemmung	A178-186
Lever lock boring bars Bohrstangen mit Kniehebel-Klemmung	A187-199
Top clamp boring bars Bohrstangen mit oberer Klemmung	A200-203
Center screw boring bars Bohrstangen mit Zentralschrauben-Klemmung	A204-236
Anti-vibration tools Schwingungsgedämpfte Bohrstangen	A237-246
Cutting data Schnittdaten	A247-248

**(D) Dimple lock**

The "D" clamping system avoids insert movement during high feed or heavily interrupted machining, due to its accurate indexing that holds the insert securely clamped.
Das "D"-Klemmsystem vermeidet die Bewegung der Wendschneidplatte bei hohem Vorschub oder bei stark unterbrochener Bearbeitung dank der genauen Positionierung, die die Wendschneidplatte sicher befestigt.

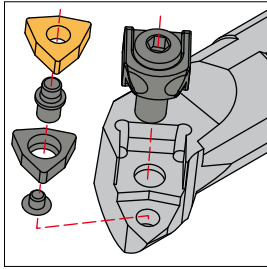
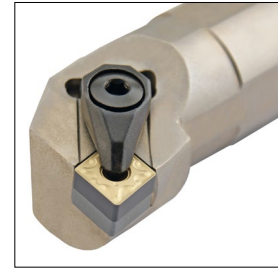
**(M) Wedge clamp
(M) Prätzen-Klemmung**

Negative inserts require good clamping force for heavy duty work, for this purpose we have designed our "M" system, one of the strongest and safest available.

Die negativen Wendeplatten für sehr schwere Zerspanungsarbeiten benötigen eine gute Klemmung, dafür bieten wir unser "M" Klemmsystem, das eines der stärksten und sichersten ist.

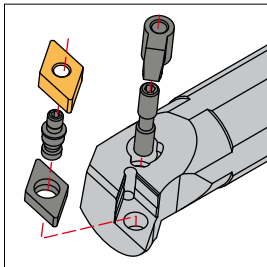
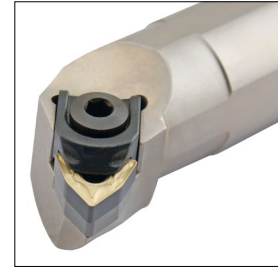
**(M-K) Double lock
(M-K) Doppel-Klemmung**

The double lock system offers good rigidity in negative inserts clamping. It is the first choice for center hole negative ceramic and cermet inserts.

Das doppelte Klemmsystem bietet eine gute Unbeweglichkeit bei der Klemmung von negativen Wendschneidplatten. Es ist die erste Wahl für negative Keramik-Wendschneidplatten mit zentralem Loch und auch für Cermet-Wendschneidplatten.

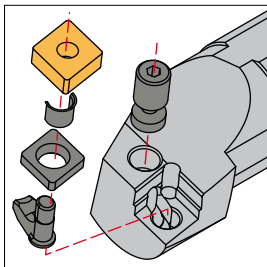
**(P) Lever lock
(P) Kniehebel-Klemmung**

The classic lever lock system allows a wide range of applications. It is the first choice for general purpose turning toolholders.

Das klassische Hebel-System erlaubt eine breite Reihe von Anwendungen. Es ist die erste Wahl für allgemeine Drehoperationen

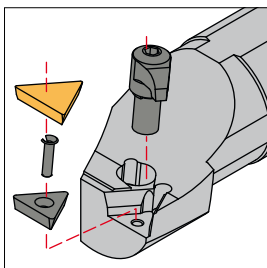
**(C) Top clamp
(C) Obere Klemmung**

The classic positive insert clamping system is designed to hold flat positive inserts, both with additional or sintered chipbreaker.

Dieses klassische Klemmsystem von positiven Wendeplatten erlaubt die Verwendung von allen Wendeplatten dieses Typs, in üblicher Sinterausführung sowohl als auch mit Spanbrecher.

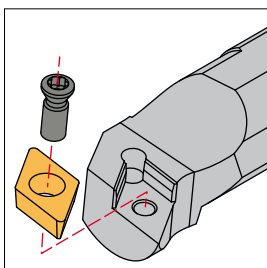
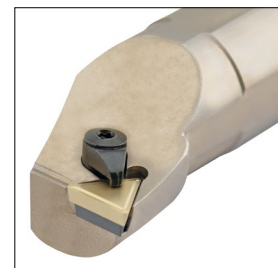
**(S) Center screw
(S) Zentralschrauben-Klemmung**

Since the advent of the TORX screw it has been possible to hold with complete safety positive inserts with center hole. Our range covers all the screw fixing permutations.

Seit der Einführung der Torx-Schraube ist es möglich, die positiven Wendschneidplatten mit zentralem Loch zu klemmen. Unser Programm bietet alle Klemmmöglichkeiten mit Schraube.



Code system / Kodifizierung (ISO)

S	25	T	S	D	U	C	R	11	-EX
1	2	3	4	5	6	7	8	9	10

1 Type of bar Schaft-Ausführung

A	Steel shank with internal coolant. Bohrstange aus Stahl mit Kühlmittelzufuhr.	
E	Anti-vibration shank (carbide) with internal coolant. Schwingungsgedämpfte Bohrstange (Hartmetall) mit Kühlmittelzufuhr.	
S	Steel shank Bohrstange aus Stahl	

2

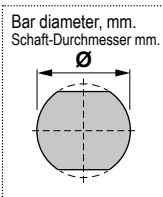

3

Bar length, mm Werkzeuglänge, mm

	H 100	T 300
	J 110	U 350
	K 125	V 400
	L 140	W 450
	M 150	Y 600
	Q 180	X Special Sonder
	R 200	
	S 250	

4 Clamping method of insert Klemmsystem

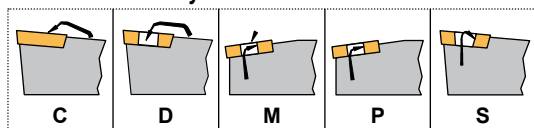

5 Insert shape Wendeschneidplatten-Form

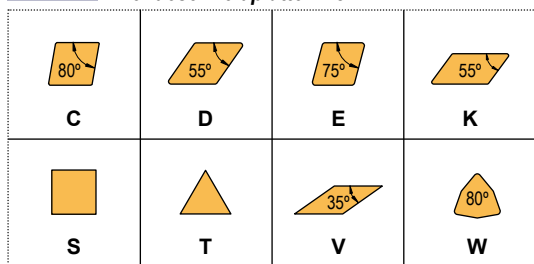

6 Holder style Einstellwinkel

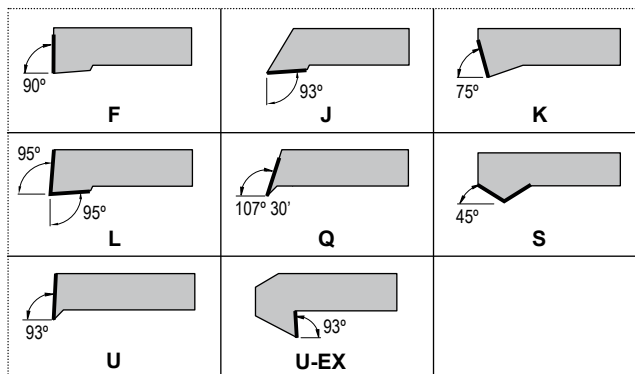

7 Clearance angle of insert Wendeschneidplatten-Freiwinkel

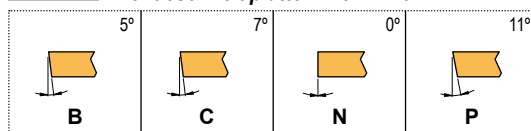

8 Hand Bearbeitungsrichtung

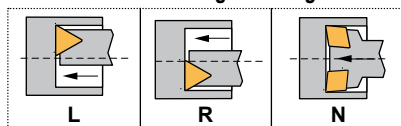

9 Cutting edge length, mm Schneidkantenlänge, mm.

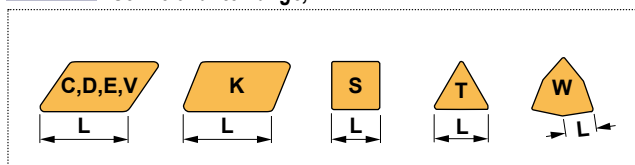

10

Manufacturer's option.
Herstellervahl.

NEGATIVE BORING BARS / NEGATIVE BOHRSTANGEN

■ Dimple lock boring bars Bohrstangen mit Dimple Lock-Klemmung

DCLN 95°-N

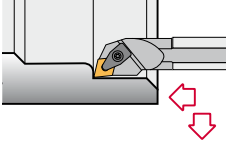

Page
Seite A176 CN.. 1204..

DDUN 93°-N

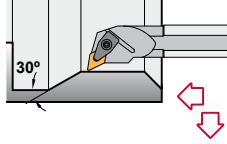

Page
Seite A177 DN.. 1506..

■ Wedge clamp / Double lock boring bars Bohrstangen mit Prätzen- und Doppel-Klemmung

MCLN-K 95°

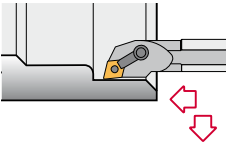

Page
Seite A178 CN.. 1204..

MDUN-K 93°

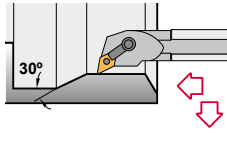

Page
Seite A179 DN.. 1506..

MSKN-K 75°

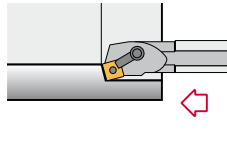

Page
Seite A180 SNM.. 1204..

MTFN 90°

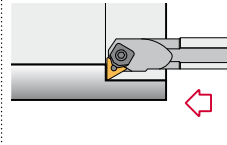

Page
Seite A181 TNM.. 1604..
TNM.. 2204..

MTFN-K 90°

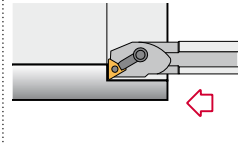

Page
Seite A182 TNM.. 1604..
TNM.. 2204..

MTUN 93°

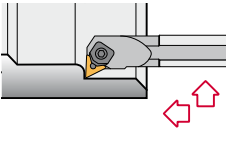

Page
Seite A183 TNM.. 1604..
TNM.. 2204..

MVUN-K 93°

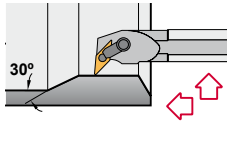

Page
Seite A184 VN.. 1604..

MWLN 95°

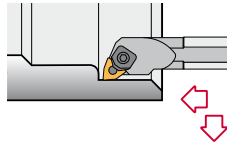

Page
Seite A185 WNM.. 0604..
WNM.. 0804..

MWLN-K 95°

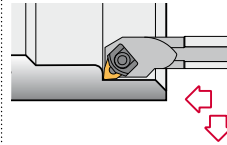

Page
Seite A186 WNMG 0804..

■ Lever lock boring bars Bohrstangen mit Kniehebel-Klemmung

PCKN 75°

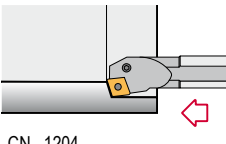

CN.. 1204..
CN.. 1606..
CN.. 1906.. Page
Seite A187

PCLN 95°

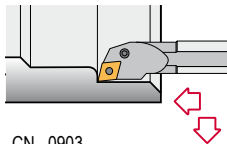

CN.. 0903..
.. Page
CN.. 1906.. Seite A188

A-PCLN 95°

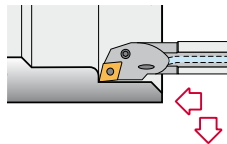

Page
Seite A189 CN.. 0903..
CN.. 1204..

PDUN 93°

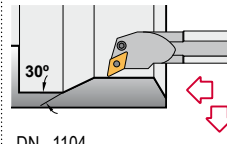

DN.. 1104..
DN.. 1504..
DN.. 1506.. Page
Seite A190

A-PDUN 93°

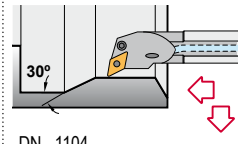

DN.. 1104..
DN.. 1504..
DN.. 1506.. Page
Seite A191

PDUN 93°-EX

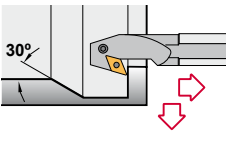

Page
Seite A192 DN.. 1504..
DN.. 1506..

PSKN 75°

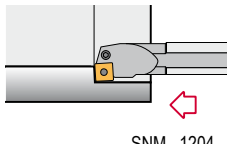

Page
Seite A193 SNM.. 1204..
SNM.. 1506..
SNM.. 1906..

A-PSKN 75°

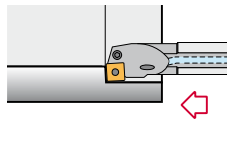

Page
Seite A194 SNM.. 1204..

A-PSSN 45°

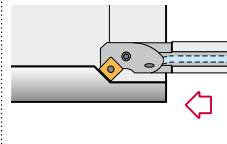

Page
Seite A195 SNM.. 1204..

PTFN 90°

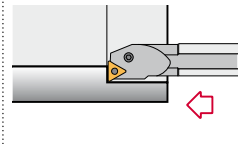

Page
Seite A196 TNM.. 1604..
TNM.. 2204..

Lever lock boring bars Bohrstangen mit Kniehebel-Klemmung

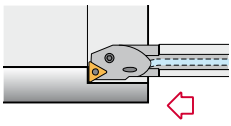
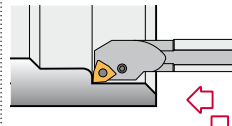
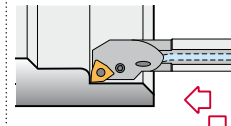

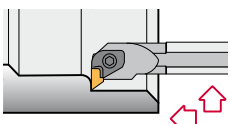
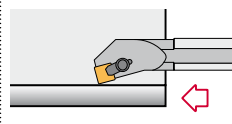
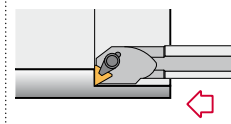
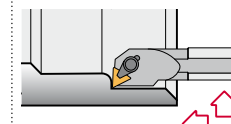

<p>A-PTFN 90°</p>  <p>Page Seite A197 TNM.. 1604.. TNM.. 2204..</p>	<p>PWLN 95°</p>  <p>Page Seite A198 WNM.. 0604.. WNM.. 0804..</p>	<p>A-PWLN 95°</p>  <p>Page Seite A199 WNM.. 0604.. WNM.. 0804..</p>		
---	---	---	--	--

POSITIVE BORING BARS / POSITIVE BOHRSTANGEN

Top clamp boring bars Bohrstangen mit oberer Klemmung

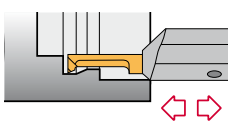
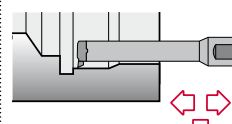
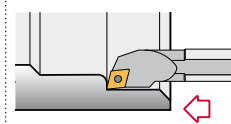
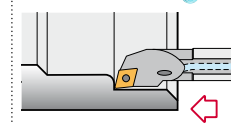
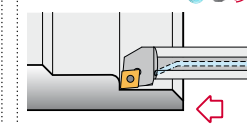
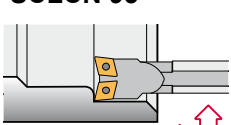
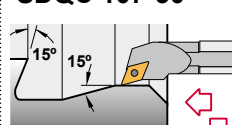
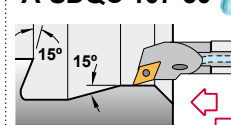
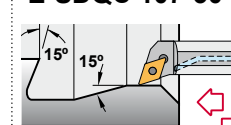
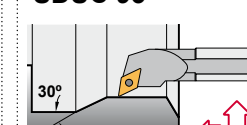
<p>CKUN 93°</p>  <p>Page Seite A200 KNUX 1604..</p>	<p>CSKP 75°</p>  <p>Page Seite A201 SP.. 0903.. SP.. 1203.. SP.. 1904..</p>	<p>CTFP 90°</p>  <p>Page Seite A202 TP.. 0902.. TP.. 2204..</p>	<p>CTUP 93°</p>  <p>Page Seite A203 TP.. 0902.. TP.. 2204..</p>	
--	--	--	---	--

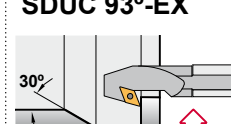
Center screw boring bars Bohrstangen mit Zentralschrauben-Klemmung

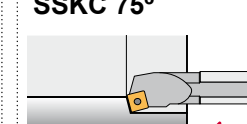

<p>00.30</p>  <p>Page Seite A204 CTI 04.. CTI 06..</p>	<p>608.00</p>  <p>Page Seite A206 R/LS 08.. R/LS 16..</p>	<p>SCLC 95°</p>  <p>Page Seite A207 CC.. 0602.. CC.. 09T3.. CC.. 1204..</p>	<p>A-SCLC 95°</p>  <p>Page Seite A208 CC.. 0602.. CC.. 09T3.. CC.. 1204..</p>	<p>E-SCLC 95°</p>  <p>Page Seite A210 CC.. 0301.. CC.. 09T3..</p>
<p>SCLCN 95°</p>  <p>Page Seite A212 CC.. 0602.. CC.. 09T3.. CC.. 1204..</p>	<p>SDQC 107°30'</p>  <p>Page Seite A213 DC.. 0702.. DC.. 11T3..</p>	<p>A-SDQC 107°30'</p>  <p>Page Seite A214 DC.. 0702.. DC.. 11T3..</p>	<p>E-SDQC 107°30'</p>  <p>Page Seite A216 DC.. 0702.. DC.. 11T3..</p>	<p>SDUC 93°</p>  <p>Page Seite A217 DC.. 0702.. DC.. 11T3..</p>
<p>A-SDUC 93°</p>  <p>Page Seite A218 DC.. 0702.. DC.. 11T3..</p>	<p>E-SDUC 93°</p>  <p>Page Seite A220 DC.. 0702.. DC.. 11T3..</p>	<p>SDUC 93°-EX</p>  <p>Page Seite A221 DC.. 0702.. DC.. 11T3..</p>	<p>A-SDUC 93°-EX</p>  <p>Page Seite A222 DC.. 0702.. DC.. 11T3..</p>	<p>SSKC 75°</p>  <p>Page Seite A223 SC.. 09T3.. SC.. 1204..</p>

POSITIVE BORING BARS / POSITIVE BOHRSTANGEN

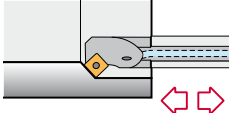
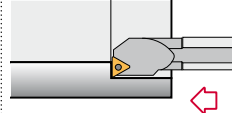
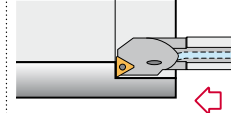
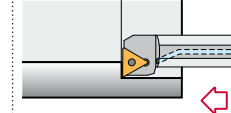
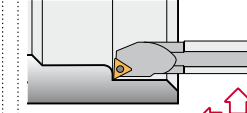
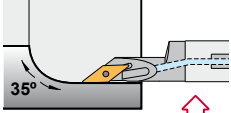
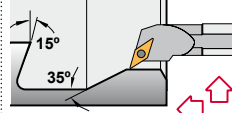
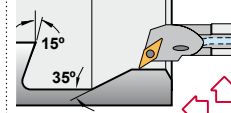
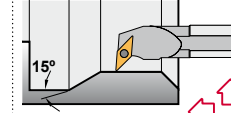
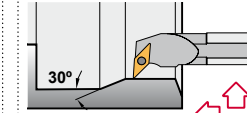
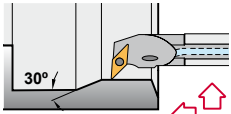
**Center screw boring bars
Bohrstangen mit Zentralschrauben-Klemmung**

<p>A-SSSC 45°</p>  <p>Page Seite A224 SC.. 09T3..</p>	<p>STFC 90°</p>  <p>TC.. 0902.. Page Seite A225 TC.. 1102.. TC.. 16T3..</p>	<p>A-STFC 90°</p>  <p>TC.. 0902.. Page Seite A226 TC.. 1102.. TC.. 16T3..</p>	<p>E-STFC 90°</p>  <p>Page Seite A228 TC.. 1102..</p>	<p>STUC 93°</p>  <p>Page Seite A229 TC.. 1102.. TC.. 16T3..</p>
<p>A-SVJC 93°</p>  <p>VC.. 1103.. Page Seite A230 VC.. 1604..</p>	<p>SVQC 107°30'</p>  <p>VC.. 1103.. Page Seite A232 VC.. 1303.. VC.. 1604..</p>	<p>A-SVQC 107°30'</p>  <p>Page Seite A233 VC.. 1103.. VC.. 1604..</p>	<p>SVUB 93°</p>  <p>Page Seite A234 VBMT 1604..</p>	<p>SVUC 93°</p>  <p>Page Seite A235 VC.. 1103.. VC.. 1604..</p>
<p>A-SVUC 93°</p>  <p>Page Seite A236 VC.. 1103.. VC.. 1604..</p>				

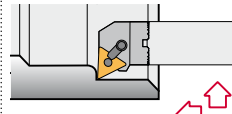
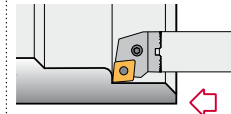
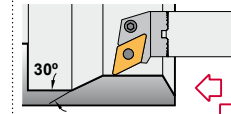
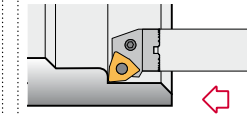
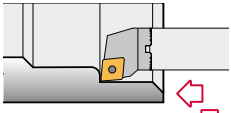
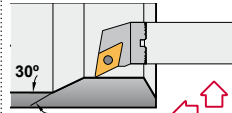
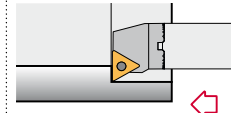
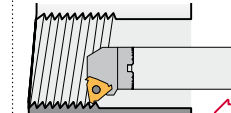
**Anti-vibration tools
Schwingungsgedämpfte Bohrstangen**

<p>J..</p>  <p>Page Seite A237</p>	<p>MTUN 93°</p>  <p>Page Seite A238 TNM.. 1604.. TNM.. 2204..</p>	<p>PCLN 95°</p>  <p>Page Seite A239 CN.. 1204.. CN.. 1606..</p>	<p>PDUN 93°</p>  <p>Page Seite A240 DN.. 1504.. DN.. 1506..</p>	<p>PWLN 95°</p>  <p>Page Seite A241 WNM.. 0804..</p>
<p>SCLC 95°</p>  <p>Page Seite A242 CC.. 09T3.. CC.. 1204..</p>	<p>SDUC 93°</p>  <p>Page Seite A243 DC.. 11T3..</p>	<p>STFC 90°</p>  <p>Page Seite A244 TC.. 16T3..</p>	<p>SXFN 90°</p>  <p>Page Seite A245 16 NR/L.. 22 NR/L..</p>	<p>J..-A..</p>  <p>Page Seite A246</p>



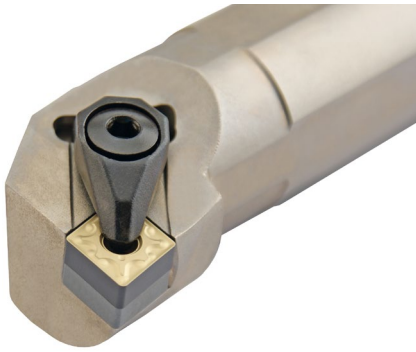

Characteristics:

Boring bar for internal turning applications equipped with rhombic negative inserts (angle 80°).

For low powered machines and small pieces choose boring bars Ref. SCLC (Page: A207).

Axial -5°
Radial -13.5°

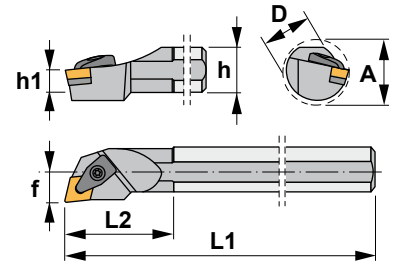

Eigenschaften:

Bohrstange zum Innendrehen mit rhombischen negativen Wendeschneidplatten (80° Winkel).

Für Niederleistungsmaschinen und kleine Werkstücke, wählen Sie Bohrstanen Bez. SCLC (Seite: A207).

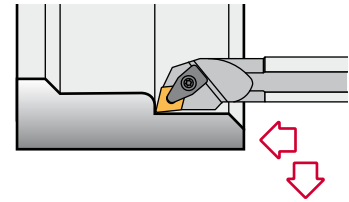

DCLN 95°-N

Reference Bezeichnung	D	h	h1	L1	L2	f	A	Insert size Wendeschneidplatte	Kg
S25T DCLN R/L 12-N	25	23	11,5	300	40	17	31	CN.. 1204..	0,700
S32U DCLN R/L 12-N	32	30	15,0	350	45	22	39	CN.. 1204..	2,050
S40V DCLN R/L 12-N	40	37	18,5	400	50	27	48	CN.. 1204..	3,750

Reference Bezeichnung							Nm
S25T DCLN R/L 12-N	ICSN-422	1766	2712	1696	4295	5004	3.5
S32U DCLN R/L 12-N	ICSN-422	1766	2712	1696	4295	5004	3.5
S40V DCLN R/L 12-N	ICSN-422	1766	2712	1696	4295	5004	3.5

CN..

80° rhombic negative inserts. A32-34
80° rhombische negative WSP.

Reference / Bez.	l	s	d
CN.. 1204..	12,90	4,76	12,70

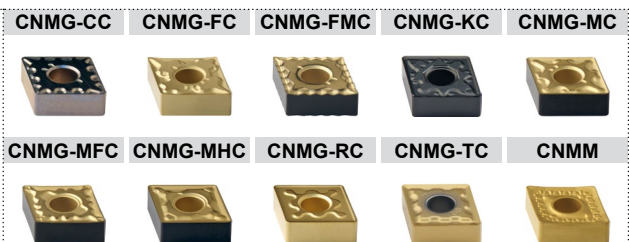
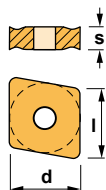

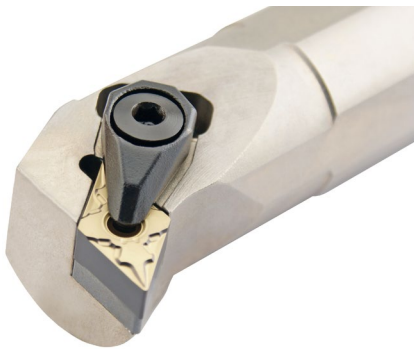

Characteristics:

Boring bar for internal turning and profiling applications equipped with rhombic negative inserts (angle 55°).

For low powered machines and small pieces choose boring bars Ref. SDUC (Page: A217).

Axial -6°
Radial -14°

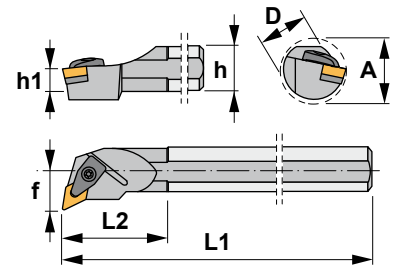

Eigenschaften:

Bohrstange zum Innen- und Profildrehen mit rhombischen negativen Wendeschneidplatten (55° Winkel).

Für Niederleistungsmaschinen und kleine Werkstücke, wählen Sie Bohrstanen SDUC (Seite: A217).

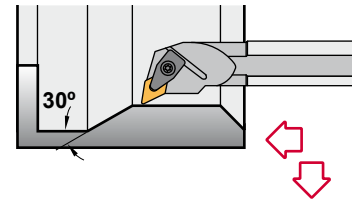

DDUN 93°-N

Reference Bezeichnung	D	h	h1	L1	L2	f	A	Insert size Wendeschneidplatte	Kg
S32U DDUN R/L 15-N	32	30	15,0	350	45	22	39	DN.. 1506..	2,050
S40V DDUN R/L 15-N	40	37	18,5	400	50	27	48	DN.. 1506..	3,750

Reference Bezeichnung							Nm
S32U DDUN R/L 15-N	IDSN-432	1766	2712	1696	4295	5004	3.5
S40V DDUN R/L 15-N	IDSN-432	1766	2712	1696	4295	5004	3.5

DN..	55° rhombic negative inserts. A36-37		
	55° rhombische negative Wendeschneidplatten.		
	Reference / Bez.	l	s
DN.. 1506..	15,50	6,35	12,70

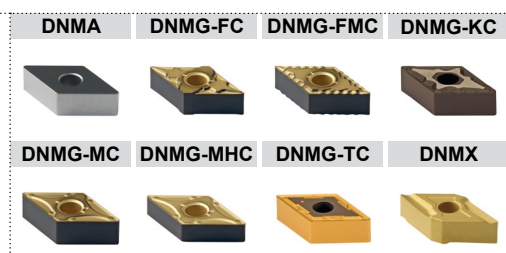
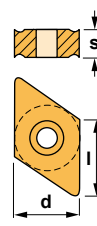



Characteristics:

Multipurpose boring bar equipped with rhombic negative double-sided insert (angle 80°).
For low powered machines and small pieces choose boring bars Ref. SCLC (Page: A207).

Axial -5°
Radial -13.5°

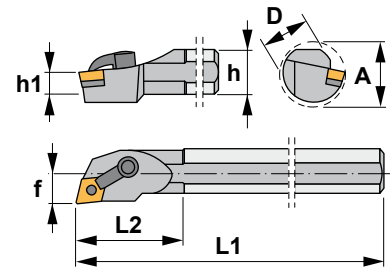

Eigenschaften:

Multifunktions-Bohrstange mit doppelseitigen rhombischen negativen Wendeschneidplatten (80° Winkel).
Für Niederleistungsmaschinen und kleine Werkstücke, wählen Sie Bohrstangen SCLC (Seite: A207).

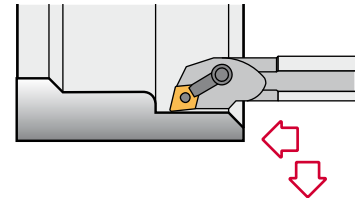

MCLN-K 95°

Reference Bezeichnung	D	h	h1	L1	L2	f	A	Insert size Wendeschneidplatte	Kg
S25T MCLN R/L 12-K	25	23	11,5	300	40	17	31	CN.. 1204..	0,700
S32U MCLN R/L 12-K	32	30	15,0	350	45	22	39	CN.. 1204..	2,050
S40V MCLN R/L 12-K	40	37	18,5	400	50	27	48	CN.. 1204..	3,750

Reference Bezeichnung								Nm
S25T MCLN R/L 12-K	2613	1186	5003	-	1686	5025		3.0
S32U MCLN R/L 12-K	2613	1086	5003	ICSN-432	1656	5025		3.0
S40V MCLN R/L 12-K	2613	1086	5003	ICSN-432	1656	5025		3.0

CN..

80° rhombic negative inserts. A32-34
80° rhombische negative WSP.

Reference / Bez.	l	s	d
CN.. 1204..	12,90	4,76	12,70

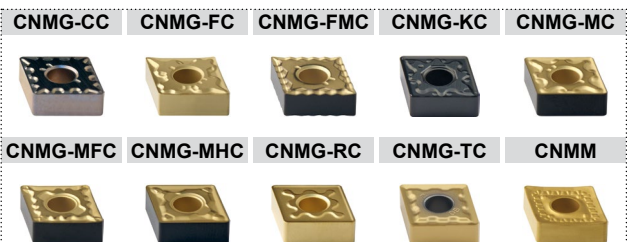
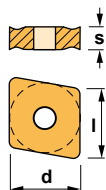



Characteristics:

Internal turning and profiling boring bar equipped with rhombic negative double-sided insert (angle 55°).

For low powered machines and small pieces choose boring bars Ref. SDUC (Page: A217).

Axial -6°
Radial -12°

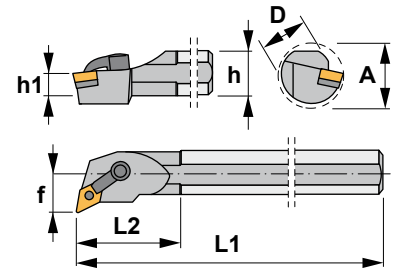

Eigenschaften:

Bohrstange zum Innen- und Profildrehen mit doppelseitigen rhombischen negativen Wendeschneidplatten (55° Winkel).

Für Niederleistungsmaschinen und kleine Werkstücke, wählen Sie Bohrstanen SDUC (Seite: A217).

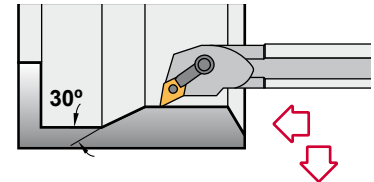

MDUN-K 93°

Reference Bezeichnung	D	h	h1	L1	L2	f	A	Insert size Wendeschneidplatte	KG
S25T MDUN R/L 15-K	25	23	11,5	300	40	17	31	DN.. 1506..	0,700
S32U MDUN R/L 15-K	32	30	15,0	350	45	22	39	DN.. 1506..	2,050
S40V MDUN R/L 15-K	40	37	18,5	400	50	27	48	DN.. 1506..	3,750

Reference Bezeichnung							Nm
S25T MDUN R/L 15-K	2614	1186	5003	-	1686	5025	3.0
S32U MDUN R/L 15-K	2614	1086	5003	IDSN-432	1666	5025	3.0
S40V MDUN R/L 15-K	2614	1086	5003	IDSN-432	1666	5025	3.0

DN.. 55° rhombic negative inserts. A36-37
55° rhombische negative Wendeschneidplatten.

Reference / Bez.	l	s	d
DN.. 1506..	15,50	6,35	12,70

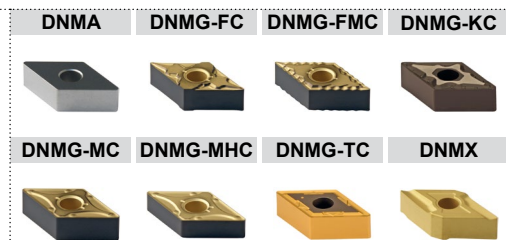
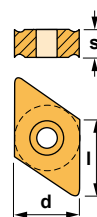



Characteristics:

Boring bar for internal turning applications equipped with square negative inserts. For low powered machines and small pieces choose boring bars Ref. CSKP (Page: A201) or SSKC (Page: A223).

Axial -3.25°
Radial -11°

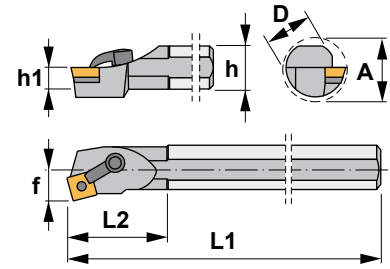

Eigenschaften:

Bohrstange zum Innendrehen mit vierkantigen negativen Wendschneidplatten. Für Niederleistungsmaschinen und kleine Werkstücke, wählen Sie Bohrstangen CSKP (Seite: A201) oder SSKC (Seite: A223).

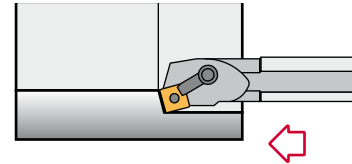

MSKN-K 75°

Reference Bezeichnung	D	h	h1	L1	L2	f	A	Insert size Wendschneidplatte	KG
S32U MSKN R/L 12-K	32	33	15,0	350	45	22	39	SNM.. 1204..	2,050
S40V MSKN R/L 12-K	40	37	18,5	400	50	27	48	SNM.. 1204..	3,750

Reference Bezeichnung							Nm
S32U MSKN R/L 12-K	2613	1086	5003	ISSN-432	1656	5025	3.0
S40V MSKN R/L 12-K	2613	1086	5003	ISSN-432	1656	5025	3.0

SNM..

Square negative inserts. A41-42
Vierkantige negative Wendschneidplatten.

Reference / Bez.	l	s	d
SNM.. 1204..	12,70	4,76	12,70

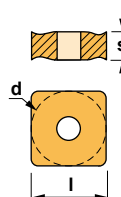

SNMG-FMC



SNMG-KC



SNMG-MHC



SNMG-RC



SNMG-TC



SNMM





Characteristics:

Internal turning and profiling boring bar equipped with triangular negative double-sided insert.

For low powered machines and small pieces choose boring bars Ref. CTFP (Page: A202) or STFC (page: A225).

Axial -6°
Radial -12°

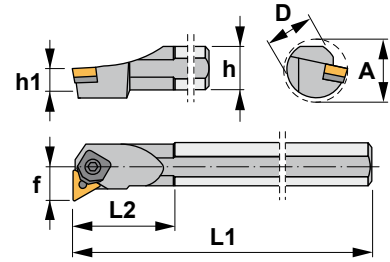

Eigenschaften:

Bohrstange zum Innen- und Profildrehen mit doppelseitigen dreikantigen negativen Wendeschneidplatten.

Für Niederleistungsmaschinen und kleine Werkstücke, wählen Sie Bohrstanen CTFP (Seite: A202) oder STFC (Seite: A225).

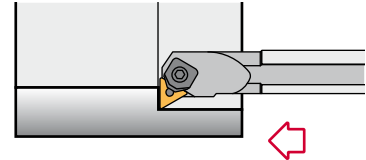

MTFN 90°

Reference Bezeichnung	D	h	h1	L1	L2	f	A	Insert size Wendeschneidplatte	Kg
S25T MTFN R/L 16	25	23	11,5	300	40	17	34	TNM.. 1604..	0,700
S32U MTFN R/L 16	32	30	15,0	350	45	22	39	TNM.. 1604..	2,050
S40V MTFN R/L 16	40	37	18,5	400	50	27	48	TNM.. 1604..	3,750
S50W MTFN R/L 16	50	47	23,5	450	60	35	61	TNM.. 1604..	6,500
S60Y MTFN R/L 16	60	57	28,5	600	75	43	80	TNM.. 1604..	12,600
S40V MTFN R/L 22	40	37	18,5	400	50	27	48	TNM.. 2204..	3,750
S50W MTFN R/L 22	50	47	23,5	450	60	35	61	TNM.. 2204..	6,500
S60Y MTFN R/L 22	60	57	28,5	600	75	43	80	TNM.. 2204..	12,600

Reference Bezeichnung						Nm
S25T MTFN R/L 16	2014	5005	3414	1644	1813	4.0
S32U MTFN R/L 16	2014	5005	3414	1644	1393	4.0
S40V MTFN R/L 16	2014	5005	3414	1644	1393	4.0
S50W MTFN R/L 16	2014	5005	3414	1644	1393	4.0
S60Y MTFN R/L 16	2014	5005	3414	1644	1393	4.0
S40V MTFN R/L 22	2024	5005	ITSN-433	1661	1394	4.0
S50W MTFN R/L 22	2024	5005	ITSN-433	1661	1394	4.0
S60Y MTFN R/L 22	2024	5005	ITSN-433	1661	1394	4.0

TNM..	Triangular negative inserts. A45-46 Dreikantige negative WSP.				TNMA	TNMG-CC	TNMG-FC	TNMG-FMC	TNMG-KC
	Reference / Bez.	l	s		d				
	TNM.. 1604..	16,50	4,76	9,52					
	TNM.. 2204..	22,00	4,76	12,70					

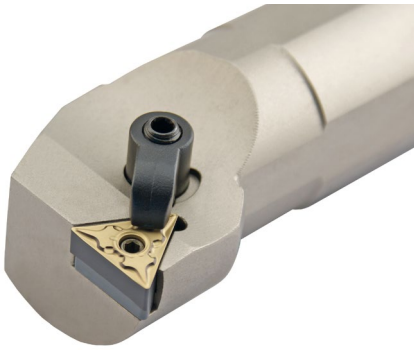

Characteristics:

Internal turning and profiling boring bar equipped with triangular negative double-sided insert.

For low powered machines and small pieces choose boring bars Ref. CTFP (Page: A202) or STFC (Page: A225).

Axial -6°
Radial -11°

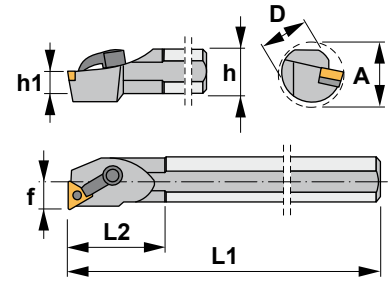

Eigenschaften:

Bohrstange zum Innen- und Profildrehen mit doppelseitigen dreikantigen negativen Wendeschneidplatten.

Für Niederleistungsmaschinen und kleine Werkstücke, wählen Sie Bohrstanen CTFP (Seite: A202) oder STFC (Seite: A225).

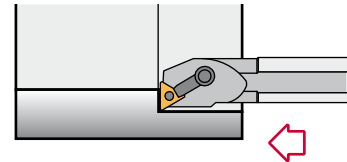

MTFN-K 90°

Reference Bezeichnung	D	h	h1	L1	L2	f	A	Insert size Wendeschneidplatte	KG
S25T MTFN R/L 16-K	25	23	11,5	300	40	17	31	TNM.. 1604..	0,700
S32U MTFN R/L 16-K	32	30	15,0	350	45	22	39	TNM.. 1604..	2,050
S40V MTFN R/L 16-K	40	37	18,5	400	50	27	48	TNM.. 1604..	3,750

Reference Bezeichnung							Nm ¹	Nm ²
S25T MTFN R/L 16-K	2613	1086	5003	ITSN-322	1665	5002	3.0	1.4
S32U MTFN R/L 16-K	2613	1086	5003	ITSN-322	1665	5002	3.0	1.4
S40V MTFN R/L 16-K	2613	1086	5003	ITSN-322	1665	5002	3.0	1.4

TNM..

Triangular negative inserts.
Dreikantige negative WSP. A45-46

Reference / Bez.	l	s	d
TNM.. 1604..	16,50	4,76	9,52
TNM.. 2204..	22,00	4,76	12,70

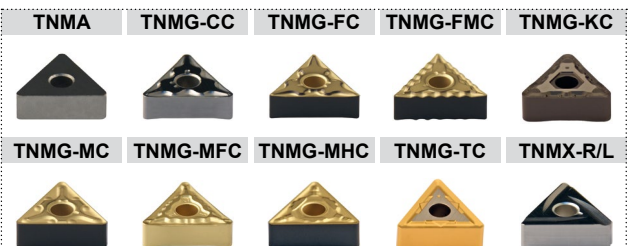
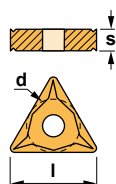

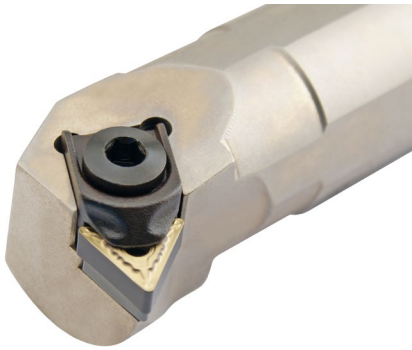

Characteristics:

Internal turning and profiling boring bar equipped with triangular negative double-sided insert.

For low powered machines and small pieces choose boring bars Ref. CTUP (Page: A203) or STUC (Page: A229).

Axial -6°
Radial -11°

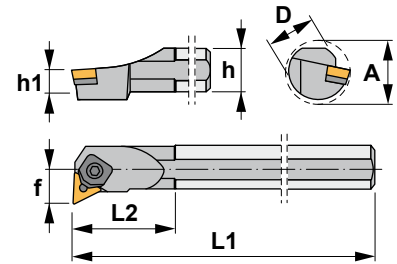

Eigenschaften:

Bohrstange zum Innen- und Profildrehen mit doppelseitigen dreikantigen negativen Wendeschneidplatten.

Für Niederleistungsmaschinen und kleine Werkstücke, wählen Sie Bohrstan- gen CTUP (Seite: A203) oder STUC (Seite: A229).

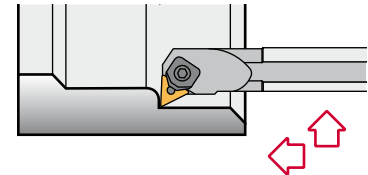

MTUN 93°

Reference Bezeichnung	D	h	h1	L1	L2	f	A	Insert size Wendeschneidplatte	Kg
S25T MTUN R/L 16	25	23	11,5	300	40	17	34	TNM.. 1604..	0,700
S32U MTUN R/L 16	32	30	15,0	350	45	22	39	TNM.. 1604..	2,050
S40V MTUN R/L 16	40	37	18,5	400	50	27	48	TNM.. 1604..	3,750
S50W MTUN R/L 16	50	47	23,5	450	60	35	61	TNM.. 1604..	6,500
S40V MTUN R/L 22	40	37	18,5	400	50	27	48	TNM.. 2204..	3,750
S50W MTUN R/L 22	50	47	23,5	450	60	35	61	TNM.. 2204..	6,500

Reference Bezeichnung						Nm
S25T MTUN R/L 16	2014	5005	3414	1644	1813	4.0
S32U MTUN R/L 16	2014	5005	3414	1644	1393	4.0
S40V MTUN R/L 16	2014	5005	3414	1644	1393	4.0
S50W MTUN R/L 16	2014	5005	3414	1644	1393	4.0
S40V MTUN R/L 22	2024	5005	ITSN-433	1661	1394	4.0
S50W MTUN R/L 22	2024	5005	ITSN-433	1661	1394	4.0

TNM.. Triangular negative inserts. Dreikantige negative WSP. A45-46	Reference / Bez.				<table border="1"> <tr> <td>TNMA</td> <td>TNMG-CC</td> <td>TNMG-FC</td> <td>TNMG-FMC</td> <td>TNMG-KC</td> </tr> <tr> <td></td> <td></td> <td></td> <td></td> <td></td> </tr> <tr> <td>TNMG-MC</td> <td>TNMG-MFC</td> <td>TNMG-MHC</td> <td>TNMG-TC</td> <td>TNMX-R/L</td> </tr> <tr> <td></td> <td></td> <td></td> <td></td> <td></td> </tr> </table>	TNMA	TNMG-CC	TNMG-FC	TNMG-FMC	TNMG-KC						TNMG-MC	TNMG-MFC	TNMG-MHC	TNMG-TC	TNMX-R/L					
	TNMA	TNMG-CC	TNMG-FC			TNMG-FMC	TNMG-KC																		
TNMG-MC	TNMG-MFC	TNMG-MHC	TNMG-TC	TNMX-R/L																					
l	s	d																							
TNM.. 1604..	16,50	4,76	9,52																						
TNM.. 2204..	22,00	4,76	12,70																						

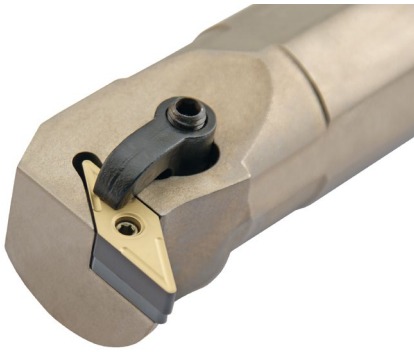

Characteristics:

Internal turning and profiling boring bar equipped with rhombic negative double-sided insert (angle 35°).

For low powered machines and small pieces choose boring bars Ref. SVUC (Page: A235).

Axial -5°
Radial -15°

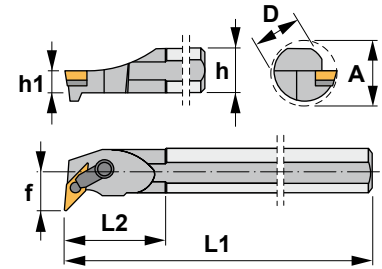

Eigenschaften:

Bohrstange zum Innen- und Profildrehen mit doppelseitigen rhombischen negativen Wendeschneidplatten (35° Winkel).

Für Niederleistungsmaschinen und kleine Werkstücke, wählen Sie Bohrstanen SVUC (Seite: A235).

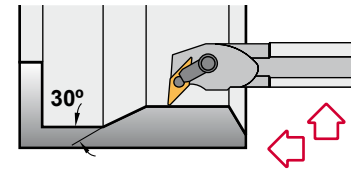

MVUN-K 93°

Reference Bezeichnung	D	h	h1	L1	L2	f	A	Insert size Wendeschneidplatte	KG
S25T MVUN R/L 16-K	25	23	11,5	300	40	17	31	VN.. 1604..	0,700
S32U MVUN R/L 16-K	32	30	15,0	350	45	22	39	VN.. 1604..	2,050
S40V MVUN R/L 16-K	40	37	18,5	400	50	27	48	VN.. 1604..	3,750

Reference Bezeichnung							Nm ¹	Nm ²
S25T MVUN R/L 16-K	2614	1186	5003	IVSN-322	1665	5002	3.0	1.4
S32U MVUN R/L 16-K	2614	1086	5003	IVSN-322	1665	5002	3.0	1.4
S40V MVUN R/L 16-K	2614	1086	5003	IVSN-322	1665	5002	3.0	1.4

VN..

35° rhombic negative inserts. A49
35° rhombische negative Wendeschneidplatten.

Reference / Bez.	l	s	d
VN.. 1604..	16,50	4,76	9,52

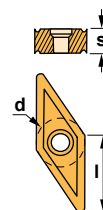

VNGP



VNMG



VNMG-TC



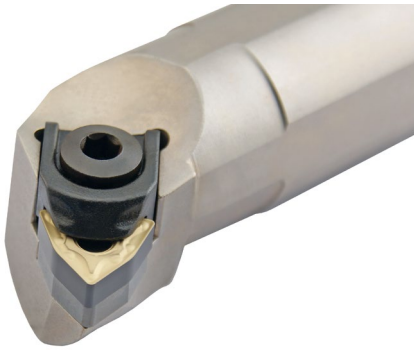

Characteristics:

Multipurpose boring bar equipped with trigon negative double-sided insert (angle 80°).

Not suitable for cermet, ceramic or K10, P10 grade inserts.

Axial -5°
Radial -11.5°

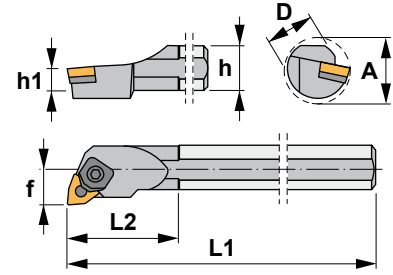

Eigenschaften:

Multifunktions-Bohrstange mit doppelseitigen negativen Trigon Wendeschneidplatten (80° Winkel).

Nicht geeignet für Cermet, Keramik oder K10 und P10 Wendeschneidplatten.

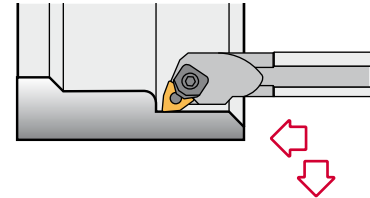

MWLN 95°

Reference Bezeichnung	D	h	h1	L1	L2	f	A	Insert size Wendeschneidplatte	kg
S20S MWLN R/L 06	20	18	9,0	250	35	13	27	WNM.. 0604..	0,550
S25T MWLN R/L 06	25	23	11,5	300	40	17	31	WNM.. 0604..	0,700
S32U MWLN R/L 06	32	30	15,0	350	45	22	39	WNM.. 0604..	2,050
S25T MWLN R/L 08	25	23	11,5	300	40	17	31	WNM.. 0804..	0,700
S32U MWLN R/L 08	32	30	15,0	350	45	22	39	WNM.. 0804..	2,050
S40V MWLN R/L 08	40	37	18,5	400	50	27	48	WNM.. 0804..	3,750
S50W MWLN R/L 08	50	47	23,5	450	60	35	61	WNM.. 0804..	6,500
S60Y MWLN R/L 08	60	57	28,5	600	75	43	80	WNM.. 0804..	12,600

Reference Bezeichnung						Nm
S20S MWLN R/L 06	2006	5025	-	1643	1813	2.0
S25T MWLN R/L 06	2006	5025	3006	1644	1813	2.0
S32U MWLN R/L 06	2006	5025	3006	1644	1813	2.0
S25T MWLN R/L 08	2011	5005	-	1647	1814	4.0
S32U MWLN R/L 08	2011	5005	IWSN-433	1661	1814	4.0
S40V MWLN R/L 08	2011	5005	IWSN-433	1661	1814	4.0
S50W MWLN R/L 08	2011	5005	IWSN-433	1661	1814	4.0
S60Y MWLN R/L 08	2011	5005	IWSN-433	1661	1814	4.0

WNMG 80° trigon negative inserts. A50-51
80° trigon negative Wendeschneidplatten.

Reference / Bez.	l	s	d
WNMG 0604..	6,45	4,76	9,52
WNMG 0804..	8,14	4,76	12,70

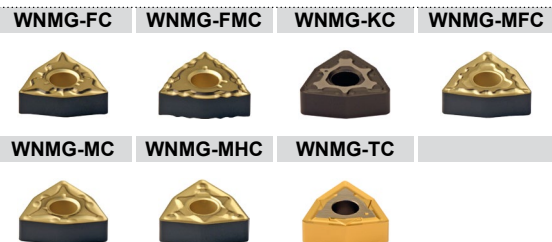
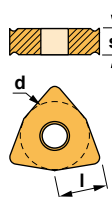



Characteristics:

Multipurpose boring bar equipped with trigon negative double-sided insert (angle 80°). Especially recommended for cermet, ceramic or K10, P10 grade inserts.

Axial -5°
Radial -11.5°

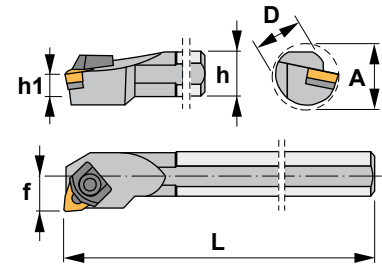

Eigenschaften:

Multifunktions-Bohrstange mit doppelseitigen negativen Trigon Wendeschneidplatten (80° Winkel).

Besonders geeignet für Cermet, Keramik oder K10 und P10 Wendeschneidplatten.

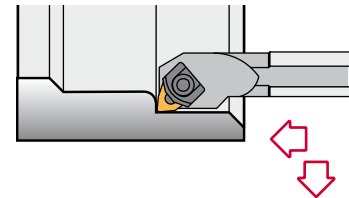

MWLN-K 95°

Reference Bezeichnung	D	h	h1	L1	L2	f	A	Insert size Wendeschneidplatte	kg
S25T MWLN R/L 08-K	25	23	11,5	300	40	17	31	WNMG 0804..	0,700
S32U MWLN R/L 08-K	32	30	15,0	350	45	22	39	WNMG 0804..	2,050
S40V MWLN R/L 08-K	40	37	18,5	400	50	27	48	WNMG 0804..	3,750
S50W MWLN R/L 08-K	50	47	23,5	450	60	35	61	WNMG 0804..	6,500

Reference Bezeichnung						Nm
S25T MWLN R/L 08-K	2018	-	1647	5025	1814	2.0
S32U MWLN R/L 08-K	2018	IWSN-433	1661	5025	1814	2.0
S40V MWLN R/L 08-K	2018	IWSN-433	1661	5025	1814	2.0
S50W MWLN R/L 08-K	2018	IWSN-433	1661	5025	1814	2.0

WNMG 80° trigon negative inserts. A50-51
80° trigon negative Wendeschneidplatten.

Reference / Bez.	l	s	d
WNMG 0804..	8,14	4,76	12,70

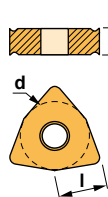



Characteristics:

Boring bar for internal turning applications equipped with rhombic negative inserts (angle 80°).

For general applications, roughing, semi-finishing and finishing.

Axial -3°
Radial -11.5°

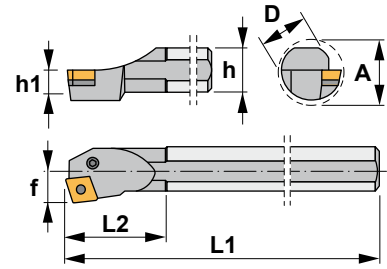

Eigenschaften:

Bohrstange zum Innendreien mit rhombischen negativen Wendschneidplatten (80° Winkel).

Für allgemeine Anwendungen, Schruppen, Vorschlichten und Schlichten.

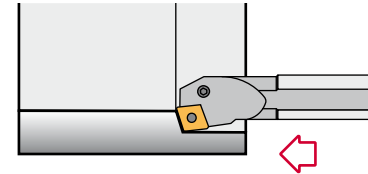

PCKN 75°

Reference Bezeichnung	D	h	h1	L1	L2	f	A	Insert size Wendschneidplatte	kg
S25T PCKN R/L 12	25	23	11,5	300	40	17	31	CN.. 1204..	0,700
S32U PCKN R/L 12	32	30	15,0	350	45	22	39	CN.. 1204..	2,050
S40V PCKN R/L 12	40	37	18,5	400	50	27	48	CN.. 1204..	3,750
S50W PCKN R/L 12	50	47	23,5	450	60	35	61	CN.. 1204..	6,500
S60Y PCKN R/L 12	60	57	28,5	600	75	43	80	CN.. 1204..	12,600
S40V PCKN R/L 16	40	37	18,5	400	50	27	48	CN.. 1606..	3,750
S50W PCKN R/L 16	50	47	23,5	450	60	35	61	CN.. 1606..	6,500
S60Y PCKN R/L 16	60	57	28,5	600	75	43	80	CN.. 1606..	12,600
S50W PCKN R/L 19	50	47	23,5	450	60	35	61	CN.. 1906..	6,500
S60Y PCKN R/L 19	60	57	28,5	600	75	43	80	CN.. 1906..	12,600

Reference Bezeichnung							Nm
S25T PCKN R/L 12	8212	1626	5025	-	-	-	2.0
S32U PCKN R/L 12	8312	1648	5003	3612	4112	0012	3.0
S40V PCKN R/L 12	8012	1608	5003	3612	4112	0012	3.0
S50W PCKN R/L 12	8012	1608	5003	3612	4112	0012	3.0
S60Y PCKN R/L 12	8012	1608	5003	3612	4112	0012	3.0
S40V PCKN R/L 16	8016	1618	5003	3616	4115	0015	3.0
S50W PCKN R/L 16	8016	1618	5003	3616	4115	0015	3.0
S60Y PCKN R/L 16	8016	1618	5003	3616	4115	0015	3.0
S50W PCKN R/L 19	8219	1610	5004	3619	4119	0019	3.5
S60Y PCKN R/L 19	8219	1610	5004	3619	4119	0019	3.5

CN..

80° rhombic negative inserts.
80° rhombische negative WSP. A32-34

Reference / Bez.	l	s	d
CN.. 1204..	12,90	4,76	12,70
CN.. 1606..	16,10	6,35	15,88
CN.. 1906..	19,30	6,35	19,05

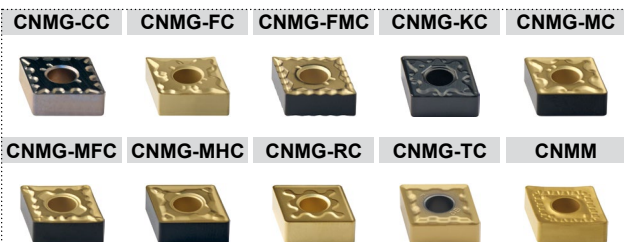
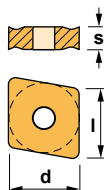



Characteristics:

Boring bar for internal turning applications equipped with rhombic negative inserts (angle 80°).

For low powered machines and small pieces choose boring bars Ref. SCLC (Page: A207).

Axial -5°
Radial -13.5°

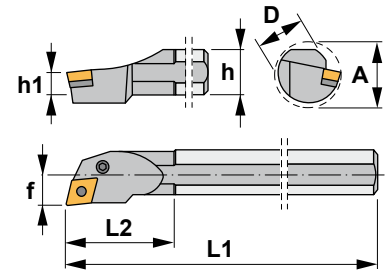

Eigenschaften:

Bohrstange zum Innendrehen mit rhombischen negativen Wendeschneidplatten (80° Winkel).

Für Niederleistungsmaschinen und kleine Werkstücke, wählen Sie Bohrstanngen SCLC (Seite: A207).

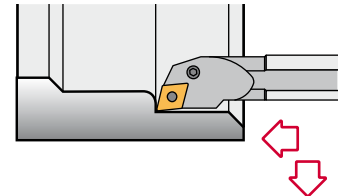

PCLN 95°

Reference Bezeichnung	D	h	h1	L1	L2	f	A	Insert size Wendeschneidplatte	Kg
S16R PCLN R/L 09	16	15	7,5	200	30	11	20	CN.. 0903..	0,300
S20S PCLN R/L 09	20	18	9,0	250	35	13	25	CN.. 0903..	0,550
S25T PCLN R/L 09	25	23	11,5	300	40	17	32	CN.. 0903..	0,700
S25T PCLN R/L 12	25	23	11,5	300	40	17	31	CN.. 1204..	0,700
S32U PCLN R/L 12	32	30	15,0	350	45	22	39	CN.. 1204..	2,050
S40V PCLN R/L 12	40	37	18,5	400	50	27	48	CN.. 1204..	3,750
S50W PCLN R/L 12	50	47	23,5	450	60	35	61	CN.. 1204..	6,500
S60Y PCLN R/L 12	60	57	28,5	600	75	43	80	CN.. 1204..	12,600
S40V PCLN R/L 16	40	37	18,5	400	50	27	48	CN.. 1606..	3,750
S50W PCLN R/L 16	50	47	23,5	450	60	35	61	CN.. 1606..	6,500
S60Y PCLN R/L 16	60	57	28,5	600	75	43	80	CN.. 1606..	12,600
S50W PCLN R/L 19	50	47	23,5	450	60	35	61	CN.. 1906..	6,500
S60Y PCLN R/L 19	60	57	28,5	600	75	43	80	CN.. 1906..	12,600

Reference Bezeichnung							Nm
S16R PCLN R/L 09	8005	1605	5002	-	-	-	1.4
S20S PCLN R/L 09	8005	1605	5002	-	-	-	1.4
S25T PCLN R/L 09	8009	1626	5025	3609	4109	0009	2.0
S25T PCLN R/L 12	8212	1626	5025	-	-	-	2.0
S32U PCLN R/L 12	8312	1648	5003	3612	4112	0012	3.0
S40V PCLN R/L 12	8012	1608	5003	3612	4112	0012	3.0
S50W PCLN R/L 12	8012	1608	5003	3612	4112	0012	3.0
S60Y PCLN R/L 12	8012	1608	5003	3612	4112	0012	3.0
S40V PCLN R/L 16	8016	1618	5003	3616	4115	0015	3.0
S50W PCLN R/L 16	8016	1618	5003	3616	4115	0015	3.0
S60Y PCLN R/L 16	8016	1618	5003	3616	4115	0015	3.0
S50W PCLN R/L 19	8219	1610	5004	3619	4129	0019	3.5
S60Y PCLN R/L 19	8219	1610	5004	3619	4129	0019	3.5

CN..

80° rhombic negative inserts.
80° rhombische negative WSP. A32-34

Reference / Bez.	l	s	d
CN.. 0903..	9,65	3,18	9,52
CN.. 1204..	12,90	4,76	12,70
CN.. 1606..	16,10	6,35	15,88
CN.. 1906..	19,30	6,35	19,05

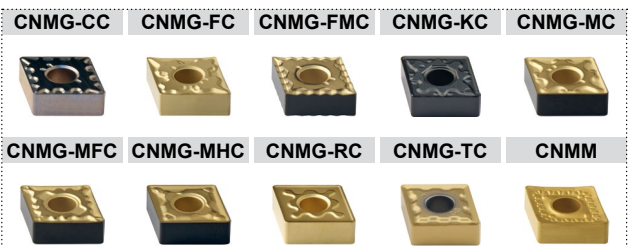
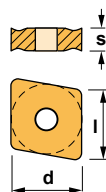



Characteristics:

Boring bar for internal turning applications equipped with rhombic negative inserts (angle 80°).

For low powered machines and small pieces choose boring bars Ref. A-SCLC (Page: A208).

Axial -5°
Radial -13.5°

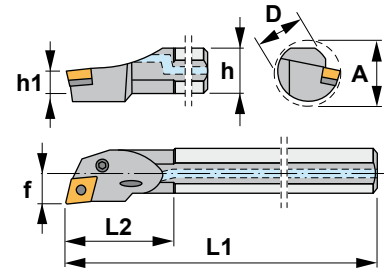

Eigenschaften:

Bohrstange zum Innendreien mit rhombischen negativen Wendeschneidplatten (80° Winkel).

Für Niederleistungsmaschinen und kleine Werkstücke, wählen Sie Bohrstanen A-SCLC (Seite: A208).

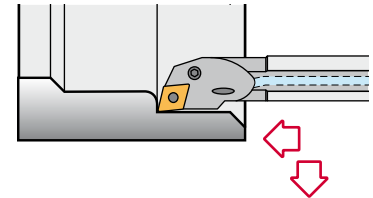

A-PCLN 95°

Reference Bezeichnung	D	h	h1	L1	L2	f	A	Insert size Wendeschneidplatte	kg
A16M PCLN R/L 09	16	15	7,5	150	30	11	20	CN.. 0903..	0,200
A20Q PCLN R/L 09	20	18	9,0	180	35	13	25	CN.. 0903..	0,400
A25R PCLN R/L 12	25	23	11,5	200	40	17	31	CN.. 1204..	0,700
A32S PCLN R/L 12	32	30	15,0	250	45	22	39	CN.. 1204..	1,400
A40T PCLN R/L 12	40	37	18,5	300	50	27	48	CN.. 1204..	2,650

Reference Bezeichnung							Nm
A16M PCLN R/L 09	8005	1605	5002	-	-	-	1.4
A20Q PCLN R/L 09	8005	1605	5002	-	-	-	1.4
A25R PCLN R/L 12	8212	1626	5025	-	-	-	2.0
A32S PCLN R/L 12	8312	1648	5003	3612	4112	0012	3.0
A40T PCLN R/L 12	8012	1608	5003	3612	4112	0012	3.0

CN..				80° rhombic negative inserts. A32-34 80° rhombische negative WSP.					
Reference / Bez.	l	s	d		CNMG-CC	CNMG-FC	CNMG-FMC	CNMG-KC	CNMG-MC
CN.. 0903..	9,65	3,18	9,52						
CN.. 1204..	12,90	4,76	12,70						



Characteristics:

Boring bar for internal turning and profiling applications equipped with rhombic negative inserts (angle 55°).

For low powered machines and small pieces choose boring bars Ref. SDUC (Page: A217).

Axial -6°
Radial -14°

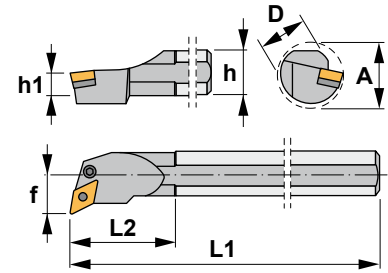

Eigenschaften:

Bohrstange zum Innen- und Profildrehen mit rhombischen negativen Wendeschneidplatten (55° Winkel).

Für Niederleistungsmaschinen und kleine Werkstücke, wählen Sie Bohrstanen SDUC (Seite: A217).

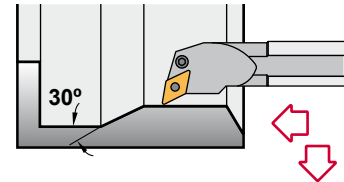

PDUN 93°

Reference Bezeichnung	D	h	h1	L1	L2	f	A	Insert size Wendeschneidplatte	KG
S20S PDUN R/L 11	20	18	9,0	250	35	13	20	DN.. 1104..	0,550
S25T PDUN R/L 11	25	23	11,5	300	40	17	31	DN.. 1104..	0,700
S32U PDUN R/L 11	32	30	15,0	350	45	22	39	DN.. 1104..	2,050
S32U PDUN R/L 15	32	30	15,0	350	45	22	39	DN.. 1506..	2,050
S40V PDUN R/L 15	40	37	18,5	400	50	27	48	DN.. 1506..	3,750
S50W PDUN R/L 15	50	47	23,5	450	60	35	61	DN.. 1506..	6,500
S60Y PDUN R/L 15	60	57	28,5	600	75	43	80	DN.. 1506..	12,600

Reference Bezeichnung									Nm
S20S PDUN R/L 11	8216	1605	5002	-	-	-	-	-	1.4
S25T PDUN R/L 11	8009	1606	5025	3711	4109	0009	-	-	2.0
S32U PDUN R/L 11	8009	1606	5025	3711	4109	0009	-	-	2.0
S32U PDUN R/L 15	8415	1648	5003	3715	4112	0012	3725	4135	3.0
S40V PDUN R/L 15	8415	1638	5003	3715	4112	0012	3725	4135	3.0
S50W PDUN R/L 15	8415	1638	5003	3715	4112	0012	3725	4135	3.0
S60Y PDUN R/L 15	8415	1638	5003	3715	4112	0012	3725	4135	3.0

For DNM.. 1504.. inserts
Für Wendeschneidplatten DNM.. 1504..

DN.. 55° rhombic negative inserts. A36-37
55° rhombische negative Wendeschneidplatten.

Reference / Bez.	l	s	d
DN.. 1104..	11,60	4,76	9,52
DN.. 1504..	15,50	4,76	12,70
DN.. 1506..	15,50	6,35	12,70

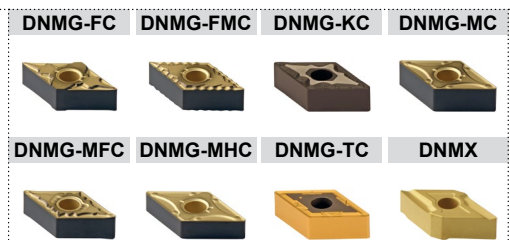
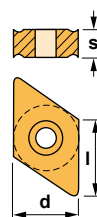



Characteristics:

Boring bar for internal turning and profiling applications equipped with rhombic negative inserts (angle 55°).

For low powered machines and small pieces choose boring bars Ref. A-SDUC (Page: A218).

Axial -6°
Radial -14°

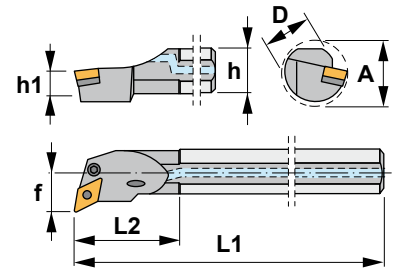

Eigenschaften:

Bohrstange zum Innen- und Profildrehen mit rhombischen negativen Wendeschneidplatten (55° Winkel).

Für Niederleistungsmaschinen und kleine Werkstücke, wählen Sie Bohrstanen A-SDUC (Seite: A218).

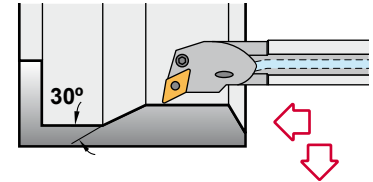

A-PDUN 93°

Reference Bezeichnung	D	h	h1	L1	L2	f	A	Insert size Wendeschneidplatte	Kg
A25R PDUN R/L 11	25	23	11,5	200	40	17	31	DN.. 1104..	0,700
A32S PDUN R/L 15	32	30	15,0	250	45	22	39	DN.. 1506..	1,400
A40T PDUN R/L 15	40	37	18,5	300	50	27	48	DN.. 1506..	2,650

Reference Bezeichnung									Nm
A25R PDUN R/L 11	8009	1606	5025	3711	4109	0009	-	-	2.0
A32S PDUN R/L 15	8415	1648	5003	3715	4112	0012	3725	4135	3.0
A40T PDUN R/L 15	8415	1638	5003	3715	4112	0012	3725	4135	3.0

For DNM.. 1504.. inserts
Für Wendeschneidplatten DNM.. 1504..

Reference / Bez.	55° rhombic negative inserts. 55° rhombische negative Wendeschneidplatten. A36-37		
	l	s	d
DN.. 1104..	11,60	4,76	9,52
DN.. 1504..	15,50	4,76	12,70
DN.. 1506..	15,50	6,35	12,70

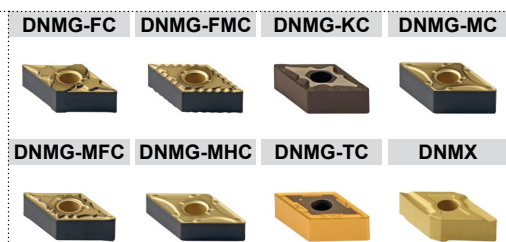
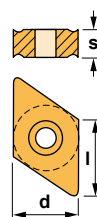



Characteristics:

Backwards boring bar for internal turning and profiling applications equipped with rhombic negative inserts (angle 55°).

For low powered machines and small pieces choose boring bars Ref. SDUC-EX (Page: A221).

Axial -6°
Radial -14°

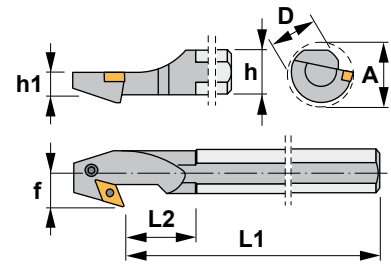

Eigenschaften:

Rückwärts-Bohrstange zum Innen- und Profildrehen mit rhombischen negativen Wendeschneidplatten (55° Winkel).

Für Niederleistungsmaschinen und kleine Werkstücke, wählen Sie Bohrstan- gen SDUC-EX (Seite: A221).

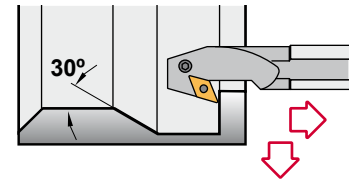

PDUN 93°-EX

Reference Bezeichnung	D	h	h1	L1	L2	f	A	Insert size Wendeschneidplatte	KG
S32U PDUN R/L 15-EX	32	30	15,0	350	50	22	39	DN.. 1506..	2,050
S40V PDUN R/L 15-EX	40	37	18,5	400	60	27	48	DN.. 1506..	3,750
S50W PDUN R/L 15-EX	50	47	23,5	450	65	35	61	DN.. 1506..	6,500

Reference Bezeichnung									Nm
S32U PDUN R/L 15-EX	8415	1648	5003	-	-	-	-	-	3.0
S40V PDUN R/L 15-EX	8415	1638	5003	3715	4112	0012	3725	4135	3.0
S50W PDUN R/L 15-EX	8415	1638	5003	3715	4112	0012	3725	4135	3.0

For DNM.. 1504.. inserts
Für Wendeschneidplatten DNM.. 1504..

DN.. 55° rhombic negative inserts. A36-37
55° rhombische negative Wendeschneidplatten.

Reference / Bez.	l	s	d
DN.. 1504..	15,50	4,76	12,70
DN.. 1506..	15,50	6,35	12,70

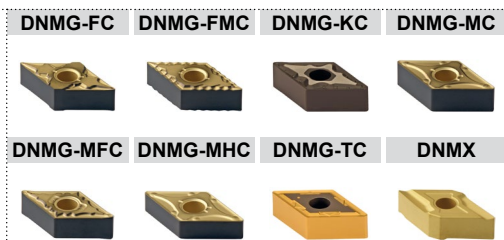
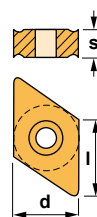



Characteristics:

Boring bar for internal turning applications equipped with square negative inserts. For low powered machines and small pieces choose boring bars Ref. CSKP (Page: A201) or SSKC (Page: A223).

Axial -3°
Radial -11°

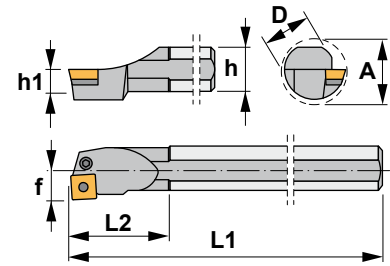

Eigenschaften:

Bohrstange zum Innendreien mit vierkantigen negativen Wendeschneidplatten. Für Niederleistungsmaschinen und kleine Werkstücke, wählen Sie Bohrstanen CSKP (Seite: A201) oder SSKC (Seite: A223).

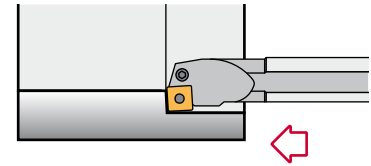

PSKN 75°

Reference Bezeichnung	D	h	h1	L1	L2	f	A	Insert size Wendeschneidplatte	kg
S25T PSKN R/L 12	25	23	11,5	300	40	17	31	SNM.. 1204..	0,700
S32U PSKN R/L 12	32	30	15,0	350	45	22	39	SNM.. 1204..	2,050
S40V PSKN R/L 12	40	37	18,5	400	50	27	48	SNM.. 1204..	3,750
S40V PSKN R/L 15	40	37	18,5	400	50	27	48	SNM.. 1506..	3,750
S50W PSKN R/L 15	50	47	23,5	450	60	35	61	SNM.. 1506..	6,500
S50W PSKN R/L 19	50	47	23,5	450	60	35	61	SNM.. 1906..	6,500
S60Y PSKN R/L 19	60	57	28,5	600	75	43	80	SNM.. 1906..	12,600

Reference Bezeichnung							Nm
S25T PSKN R/L 12	8212	1626	5025	-	-	-	2.0
S32U PSKN R/L 12	8312	1648	5003	3512	4112	0012	3.0
S40V PSKN R/L 12	8012	1608	5003	3512	4112	0012	3.0
S40V PSKN R/L 15	8012	1608	5003	3512	4112	0012	3.0
S50W PSKN R/L 15	8016	1618	5003	3515	4115	0015	3.0
S50W PSKN R/L 19	8219	1710	5004	3519	4129	0019	3.5
S60Y PSKN R/L 19	8219	1710	5004	3519	4129	0019	3.5

SNM..

Square negative inserts. A41-42
Vierkantige negative Wendeschneidplatten.

Reference / Bez.	l	s	d
SNM.. 1204..	12,70	4,76	12,70
SNM.. 1506..	15,88	6,35	15,88
SNM.. 1906..	19,05	6,35	19,05

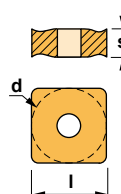

SNMG-FMC



SNMG-KC



SNMG-MHC



SNMG-RC



SNMG-TC



SNMM





Characteristics:

Boring bar for internal turning applications equipped with square negative inserts. For low powered machines and small pieces choose boring bars Ref. CSKP (Page: A201) or SSKC (Page: A223).

Axial -3°
Radial -11°

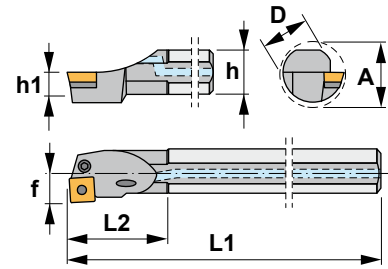

Eigenschaften:

Bohrstange zum Innendrehen mit vierkantigen negativen Wendschneidplatten.

Für Niederleistungsmaschinen und kleine Werkstücke, wählen Sie Bohrstangen CSKP (Seite: A201) oder SSKC (Seite: A223).

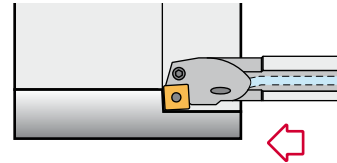

A-PSKN 75°

Reference Bezeichnung	D	h	h1	L1	L2	f	A	Insert size Wendschneidplatte	
A25R PSKN R/L 12	25	23	11,5	200	40	17	31	SNM.. 1204..	0,700
A32S PSKN R/L 12	32	30	15,0	250	45	22	39	SNM.. 1204..	1,400
A40T PSKN R/L 12	40	37	18,5	300	50	27	48	SNM.. 1204..	2,650

Reference Bezeichnung							Nm
A25R PSKN R/L 12	8212	1626	5025	-	-	-	2.0
A32S PSKN R/L 12	8312	1648	5003	3512	4112	0012	3.0
A40T PSKN R/L 12	8012	1608	5003	3512	4112	0012	3.0

SNM.. Square negative inserts. Vierkantige negative Wendschneidplatten. A41-42				SNMG-FMC	SNMG-KC	SNMG-MHC	
	Reference / Bez.	l	s	d			
	SNM.. 1204..	12,70	4,76	12,70		SNMG-TC	SNMM



Characteristics:

Boring bar for internal turning applications equipped with square negative inserts. For low powered machines and small pieces choose boring bars Ref. A-SSSC (Page: A224).

Axial -3°
Radial -11°

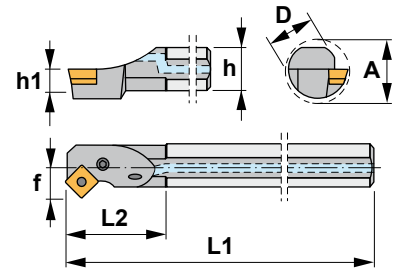

Eigenschaften:

Bohrstange zum Innendrehen mit vierkantigen negativen Wendschneidplatten. Für Niederleistungsmaschinen und kleine Werkstücke, wählen Sie Bohrstanen A-SSSC (Seite: A224).

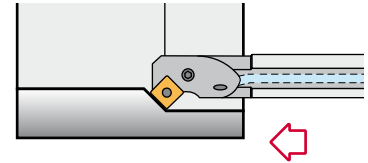

A-PSSN 45°

Reference Bezeichnung	D	h	h1	L1	L2	f	A	Insert size Wendschneidplatte	
A25R PSSN R/L 12	25	23	11,5	200	40	17	31	SNM.. 1204..	0,700
A32S PSSN R/L 12	32	30	15,0	250	45	22	39	SNM.. 1204..	2,050

Reference Bezeichnung							Nm
A25R PSSN R/L 12	8212	1626	5025	-	-	-	2.0
A32S PSSN R/L 12	8312	1648	5003	3512	4112	0012	3.0

SNM.. <small>Square negative inserts. Vierkantige negative Wendschneidplatten. A41-42</small>						
Reference / Bez.	l	s	d	SNMG-FMC	SNMG-KC	SNMG-MHC
SNM.. 1204..	12,70	4,76	12,70			
				SNMG-RC	SNMG-TC	SNMM



Characteristics:

Boring bar for internal turning applications equipped with triangular negative inserts. For low powered machines and small pieces choose boring bars Ref. CTFP (Page: A202) or STFC (Page: A225).

Axial -6°
Radial -11°

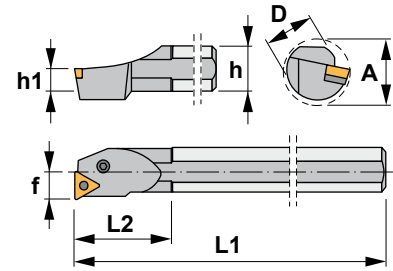

Eigenschaften:

Bohrstange zum Innendrehen mit dreikantigen negativen Wendeschneidplatten.

Für Niederleistungsmaschinen und kleine Werkstücke, wählen Sie Bohrstangen CTFP (Seite: A202) oder STFC (Seite: A225).

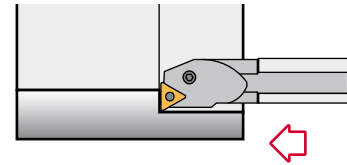

PTFN 90°

Reference Bezeichnung	D	h	h1	L1	L2	f	A	Insert size Wendeschneidplatte	Kg
S25T PTFN R/L 16	25	23	11,5	300	40	17	31	TNM.. 1604..	0,700
S32U PTFN R/L 16	32	30	15,0	350	45	22	39	TNM.. 1604..	2,050
S40V PTFN R/L 16	40	37	18,5	400	50	27	48	TNM.. 1604..	3,750
S50W PTFN R/L 16	50	47	23,5	450	60	35	61	TNM.. 1604..	6,500
S40V PTFN R/L 22	40	37	18,5	400	50	27	48	TNM.. 2204..	3,750
S50W PTFN R/L 22	50	47	23,5	450	60	35	61	TNM.. 2204..	6,500

Reference Bezeichnung							Nm
S25T PTFN R/L 16	8216	1605	5002	-	-	-	1.4
S32U PTFN R/L 16	8009	1606	5025	3416	4109	0009	2.0
S40V PTFN R/L 16	8009	1606	5025	3416	4109	0009	2.0
S50W PTFN R/L 16	8009	1606	5025	3416	4109	0009	2.0
S40V PTFN R/L 22	8012	1608	5003	3422	4112	0012	3.0
S50W PTFN R/L 22	8012	1608	5003	3422	4112	0012	3.0

TNM..

Triangular negative inserts.
Dreikantige negative WSP. A45-46

Reference / Bez.	l	s	d
TNM.. 1604..	16,50	4,76	9,52
TNM.. 2204..	22,00	4,76	12,70

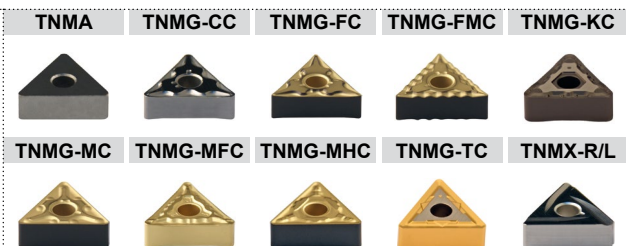
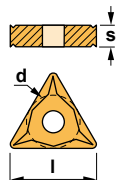



Characteristics:

Boring bar for internal turning applications equipped with triangular negative inserts. For low powered machines and small pieces choose boring bars Ref. CTFP (Page: A202) or A-STFC (Page: A226).

Axial -6°
Radial -11°

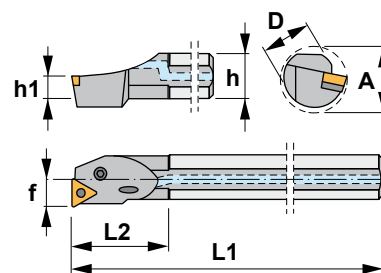

Eigenschaften:

Bohrstange zum Innendrehen mit dreikantigen negativen Wendeschneidplatten.

Für Niederleistungsmaschinen und kleine Werkstücke, wählen Sie Bohrstangen CTFP (Seite: A202) oder A-STFC (Seite: A226).

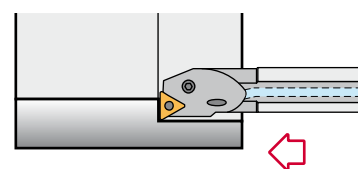

A-PTFN 90°

Reference Bezeichnung	D	h	h1	L1	L2	f	A	Insert size Wendeschneidplatte	
A25R PTFN R/L 16	25	23	11,5	200	40	17	31	TNM.. 1604..	0,700
A32S PTFN R/L 16	32	30	15,0	250	45	22	39	TNM.. 1604..	1,400
A40T PTFN R/L 22	40	37	18,5	300	50	27	48	TNM.. 2204..	2,650

Reference Bezeichnung							Nm
A25R PTFN R/L 16	8216	1605	5002	-	-	-	1.4
A32S PTFN R/L 16	8009	1606	5025	3416	4109	0009	2.0
A40T PTFN R/L 22	8012	1608	5003	3422	4112	0012	3.0

TNM..			
Triangular negative inserts. A45-46 Dreikantige negative WSP.			
Reference / Bez.	l	s	d
TNM.. 1604..	16,50	4,76	9,52
TNM.. 2204..	22,00	4,76	12,70

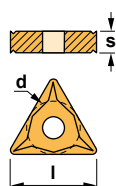



Characteristics:

Boring bar for internal turning applications equipped with trigon negative inserts (angle 80°).

For general applications, roughing, semi-finishing and finishing.

Axial -6°
Radial -13.5°

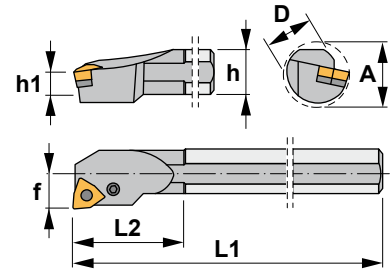

Eigenschaften:

Bohrstangen zum Innendrehen mit negativen Trigon Wendeschneidplatten (80° Winkel). Für allgemeine Anwendungen, Schruppen, Vorschlichten und Schlichten.

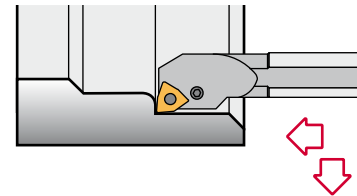

PWLN 95°

Reference Bezeichnung	D	h	h1	L1	L2	f	A	Insert size Wendeschneidplatte	Kg
S16R PWLN R/L 06	16	15	7,5	200	30	11	20	WNM.. 0604..	0,300
S20S PWLN R/L 06	20	18	9,0	250	35	13	27	WNM.. 0604..	0,550
S25T PWLN R/L 06	25	23	11,5	300	40	17	31	WNM.. 0604..	0,700
S25T PWLN R/L 08	25	23	11,5	300	40	17	31	WNM.. 0804..	0,700
S32U PWLN R/L 08	32	30	15,0	350	45	22	39	WNM.. 0804..	2,050
S40V PWLN R/L 08	40	37	18,5	400	50	27	48	WNM.. 0804..	3,750

Reference Bezeichnung							Nm
S16R PWLN R/L 06	8216	1605	5002	-	-	-	1.4
S20S PWLN R/L 06	8216	1605	5002	-	-	-	1.4
S25T PWLN R/L 06	8009	1606	5025	3007	4109	0009	2.0
S25T PWLN R/L 08	8212	1626	5025	-	-	-	2.0
S32U PWLN R/L 08	8012	1608	5003	3008	4112	0012	3.0
S40V PWLN R/L 08	8012	1608	5003	3008	4112	0012	3.0

WNMG 80° trigon negative inserts. A50-51
80° trigon negative Wendeschneidplatten.

Reference / Bez.	l	s	d
WNMG 0604..	6,45	4,76	9,52
WNMG 0804..	8,14	4,76	12,70

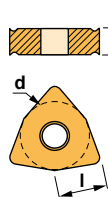



Characteristics:

Boring bar for internal turning applications equipped with trigon negative inserts (angle 80°).

For general applications, roughing, semi-finishing and finishing.

Axial -6°
Radial -13.5°

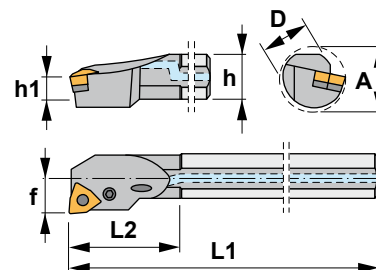

Eigenschaften:

Bohrstangen zum Innendrehen mit negativen Trigon Wendeschneidplatten (80° Winkel). Für allgemeine Anwendungen, Schruppen, Vorschlichten und Schlichten.

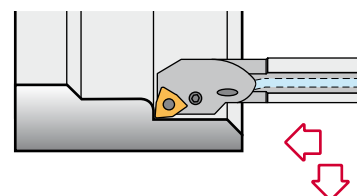

A-PWLN 95°

Reference Bezeichnung	D	h	h1	L1	L2	f	A	Insert size Wendeschneidplatte	Kg
A16M PWLN R/L 06	16	15	7,5	150	30	11	20	WNM.. 0604..	0,200
A20Q PWLN R/L 06	20	18	9,0	180	35	13	27	WNM.. 0604..	0,400
A25R PWLN R/L 06	25	23	11,5	200	40	17	31	WNM.. 0604..	0,700
A32S PWLN R/L 06	32	30	15,0	250	45	22	39	WNM.. 0604..	1,400
A25R PWLN R/L 08	25	23	11,5	200	40	17	31	WNM.. 0804..	0,700
A32S PWLN R/L 08	32	30	15,0	250	45	22	39	WNM.. 0804..	1,400
A40T PWLN R/L 08	40	37	18,5	300	50	27	48	WNM.. 0804..	2,650

Reference Bezeichnung							Nm
A16M PWLN R/L 06	8216	1605	5002	-	-	-	1.4
A20Q PWLN R/L 06	8216	1605	5002	-	-	-	1.4
A25R PWLN R/L 06	8009	1606	5025	3007	4109	0009	2.0
A32S PWLN R/L 06	8009	1606	5025	3007	4109	0009	2.0
A25R PWLN R/L 08	8212	1626	5025	-	-	-	2.0
A32S PWLN R/L 08	8012	1608	5003	3008	4112	0012	3.0
A40T PWLN R/L 08	8012	1608	5003	3008	4112	0012	3.0

WNMG

80° trigon negative inserts. A50-51
80° trigon negative Wendeschneidplatten.

Reference / Bez.	l	s	d
WNMG 0604..	6,45	4,76	9,52
WNMG 0804..	8,14	4,76	12,70

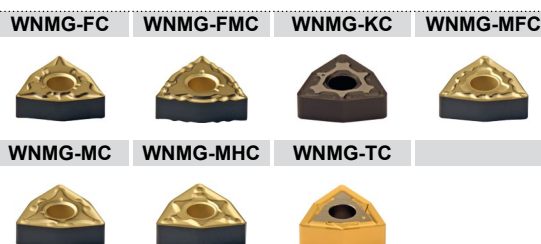
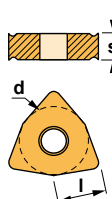



Characteristics:

Boring bar for internal turning and profiling operations equipped with KNUX negative insert.

For semi-finishing and finishing operations.

Axial -6°
Radial -10°

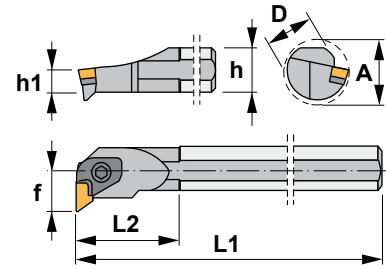

Eigenschaften:

Bohrstange zum Innen- und Profildrehen mit negativen KNUX Wendeschneidplatten.
Zum Vorschlichten und Schlichten.

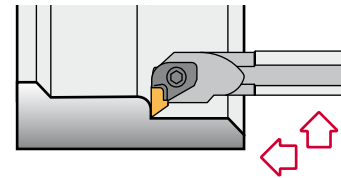

CKUN 93°

Reference Bezeichnung	D	h	h1	L1	L2	f	A	Insert size Wendeschneidplatte	Kg
S25T CKUN R/L 16	25	23	11,5	300	40	20,5	37	KNUX 1604..	0,700
S32U CKUN R/L 16	32	30	15,0	350	45	22,0	39	KNUX 1604..	2,050
S40V CKUN R/L 16	40	37	18,5	400	50	27,0	48	KNUX 1604..	3,750
S50W CKUN R/L 16	50	47	23,5	450	60	35,0	61	KNUX 1604..	6,500

Reference Bezeichnung								Nm
S25T CKUN L 16	2316	1614	5004	4295	4201	-	-	3.5
S32U CKUN L 16	2316	1614	5004	4295	4202	3226	4012	3.5
S40V CKUN L 16	2316	1614	5004	4295	4204	3226	4012	3.5
S50W CKUN L 16	2316	1614	5004	4295	4204	3226	4012	3.5
S25T CKUN R 16	2326	1614	5004	4295	4201	-	-	3.5
S32U CKUN R 16	2326	1614	5004	4295	4202	3236	4012	3.5
S40V CKUN R 16	2326	1614	5004	4295	4204	3236	4012	3.5
S50W CKUN R 16	2326	1614	5004	4295	4204	3236	4012	3.5

KNUX

KNUX negative insert.
KNUX negative Wendeschneidplatte. A38

Reference / Bezeichnung	l	s	d
KNUX 1604..	16,00	4,76	9,52

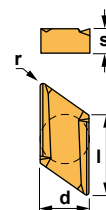

KNUX





Characteristics:

Boring bar for internal turning applications equipped with square positive inserts.
For interrupted cut choose boring bars Ref. PSKN (Page: A193).

Axial 6.5°
Radial -1.25°

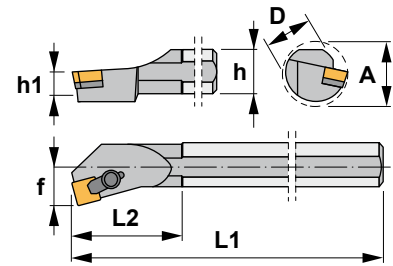

Eigenschaften:

Bohrstange zum Innendreien mit vierkantigen positiven Wendeschneidplatten.
Für unterbrochenen Schnitt wählen Sie Bohrstanen PSKN (Seite: A193).

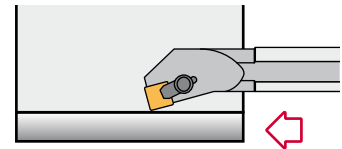

CSKP 75°

Reference Bezeichnung	D	h	h1	L1	L2	f	A	Insert size Wendeschneidplatte	kg
S16R CSKP R/L 09	16	15	7,5	200	30	11	20	SP.. 0903..	0,300
S20S CSKP R/L 09	20	18	9,0	250	35	13	24	SP.. 0903..	0,550
S25T CSKP R/L 12	25	23	11,5	300	40	17	31	SP.. 1203..	1,050
S32U CSKP R/L 12	32	30	15,0	350	45	22	39	SP.. 1203..	2,050
S40V CSKP R/L 12	40	37	18,5	400	50	27	48	SP.. 1203..	3,750
S50W CSKP R/L 12	50	47	23,5	450	60	35	61	SP.. 1203..	6,500
S50W CSKP R/L 19	50	47	23,5	450	60	35	61	SP.. 1904..	6,500

Reference Bezeichnung					Nm
S16R CSKP R/L 09	2107	5025	-	-	2.0
S20S CSKP R/L 09	2107	5025	-	-	2.0
S25T CSKP R/L 12	2109	5003	-	-	3.0
S32U CSKP R/L 12	2209	5003	3112	4002	3.0
S40V CSKP R/L 12	2209	5003	3112	4002	3.0
S50W CSKP R/L 12	2209	5003	3112	4002	3.0
S50W CSKP R/L 19	2211	5004	3119	4012	3.5

SP..

Square positive inserts with 11° clearance. A43
Vierkantige positive Wendeschneidplatten mit 11° Freiwinkel.

Reference / Bezeichnung	l	s	d
SP.. 0903..	9,52	3,18	9,52
SP.. 1203..	12,70	3,18	12,70
SP.. 1904..	19,05	4,76	19,05

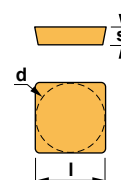

SPMR



SPUN



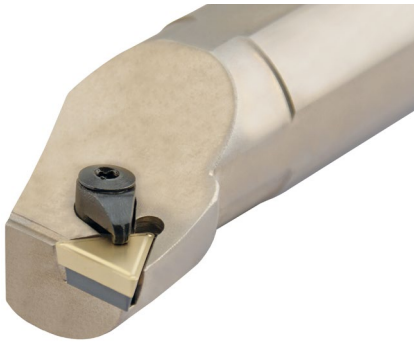

Characteristics:

Boring bar for internal turning applications equipped with triangular positive inserts. For interrupted cut choose boring bars Ref. MTFN (Page: A181) or PTFN (Page: A196).

Axial 6°
Radial 0°

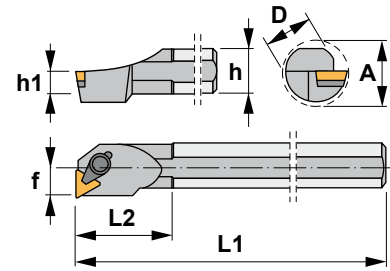

Eigenschaften:

Bohrstange zum Innendrehen mit dreieckigen positiven Wendeschneidplatten. Für unterbrochenen Schnitt wählen Sie Bohrstanen MTFN (Seite: A181) oder PTFN (Seite: A196).

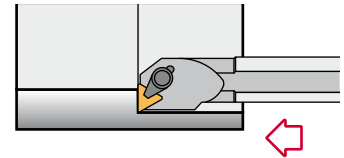

CTFP 90°

Reference Bezeichnung	D	h	h1	L1	L2	f	A	Insert size Wendeschneidplatte	
S10M CTFP R/L 09	10	9	4,5	150	22	7	13	TP.. 0902..	0,060
S12M CTFP R/L 09	12	11	5,5	150	25	9	16	TP.. 0902..	0,150
S12M CTFP R/L 11	12	11	5,5	150	25	9	16	TP.. 1103..	0,150
S16R CTFP R/L 11	16	15	7,5	200	30	11	20	TP.. 1103..	0,300
S20S CTFP R/L 11	20	18	9,0	250	35	13	24	TP.. 1103..	0,550
S16R CTFP R/L 16	16	15	7,5	200	30	11	20	TP.. 1603..	0,300
S20S CTFP R/L 16	20	18	9,0	250	35	13	24	TP.. 1603..	0,550
S25T CTFP R/L 16	25	23	11,5	300	40	17	31	TP.. 1603..	0,700
S32U CTFP R/L 16	32	30	15,0	350	45	22	39	TP.. 1603..	2,050
S40V CTFP R/L 16	40	37	18,5	400	50	27	48	TP.. 1603..	3,750
S50W CTFP R/L 16	50	47	23,5	450	60	35	61	TP.. 1603..	6,500
S40V CTFP R/L 22	40	37	18,5	400	50	27	48	TP.. 2204..	3,750
S50W CTFP R/L 22	50	47	23,5	450	60	35	61	TP.. 2204..	6,500

Reference Bezeichnung						Nm
S10M CTFP R/L 09	2000	5015	-	-	-	0.6
S12M CTFP R/L 09	2000	5015	-	-	-	0.6
S12M CTFP R/L 11	2304	5025	-	-	-	2.0
S16R CTFP R/L 11	2107	5025	-	-	-	2.0
S20S CTFP R/L 11	2107	5025	-	-	-	2.0
S16R CTFP R/L 16	2119	5003	-	-	-	3.0
S20S CTFP R/L 16	2119	5003	-	-	-	3.0
S25T CTFP R/L 16	2109	5003	-	-	-	3.0
S32U CTFP R/L 16	2209	5003	3116	4002	-	3.0
S40V CTFP R/L 16	2209	5003	3116	4002	-	3.0
S50W CTFP R/L 16	2209	5003	3116	4002	-	3.0
S40V CTFP R/L 22	2211	5004	3122	4012	-	3.5
S50W CTFP R/L 22	2211	5004	3122	4012	-	3.5

TP.. Triangular positive inserts with 11° clearance. A47
Dreieckige positive Wendeschneidplatten mit 11° Freiwinkel.

Reference / Bez.	l	s	d
TP.. 0902..	9,62	2,38	5,55
TP.. 1103..	11,00	3,18	6,35
TP.. 1603..	16,50	3,18	9,52
TP.. 2204..	22,00	4,76	12,70

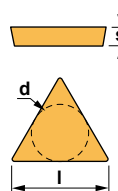

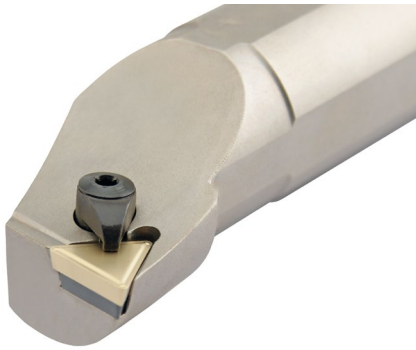

Characteristics:

Boring bar for internal turning applications equipped with triangular positive inserts. For interrupted cut choose boring bars Ref. MTUN (Page: A183).

Axial 0°
Radial -6°

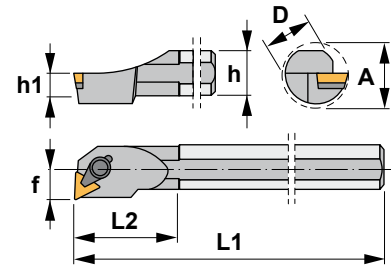

Eigenschaften:

Bohrstange zum Innendreien mit dreikantigen positiven Wendschneidplatten. Für unterbrochenen Schnitt wählen Sie Bohrstanen MTUN (Seite: A183).

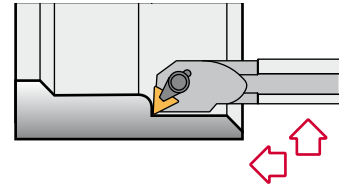

CTUP 93°

Reference Bezeichnung	D	h	h1	L1	L2	f	A	Insert size Wendschneidplatte	⚖️ Kg
S10M CTUP R/L 09	10	9	4,5	150	22	7	13	TP.. 0902..	0,060
S12M CTUP R/L 09	12	11	5,5	150	25	9	16	TP.. 0902..	0,150
S12M CTUP R/L 11	12	11	5,5	150	25	9	16	TP.. 1103..	0,150
S16R CTUP R/L 11	16	15	7,5	200	30	11	20	TP.. 1103..	0,300
S20S CTUP R/L 11	20	18	9,0	250	35	13	24	TP.. 1103..	0,550
S16R CTUP R/L 16	16	15	7,5	200	30	11	20	TP.. 1603..	0,300
S20S CTUP R/L 16	20	18	9,0	250	35	13	24	TP.. 1603..	0,550
S25T CTUP R/L 16	25	23	11,5	300	40	17	31	TP.. 1603..	0,700
S32U CTUP R/L 16	32	30	15,0	350	45	22	39	TP.. 1603..	2,050
S40V CTUP R/L 16	40	37	18,5	400	50	27	48	TP.. 1603..	3,750
S50W CTUP R/L 16	50	47	23,5	450	60	35	61	TP.. 1603..	6,500
S40V CTUP R/L 22	40	37	18,5	400	50	27	48	TP.. 2204..	3,750
S50W CTUP R/L 22	50	47	23,5	450	60	35	61	TP.. 2204..	6,500

Reference Bezeichnung					Nm
S10M CTUP R/L 09	2000	5015	-	-	0.6
S12M CTUP R/L 09	2000	5015	-	-	0.6
S12M CTUP R/L 11	2304	5025	-	-	2.0
S16R CTUP R/L 11	2107	5025	-	-	2.0
S20S CTUP R/L 11	2107	5025	-	-	2.0
S16R CTUP R/L 16	2119	5003	-	-	3.0
S20S CTUP R/L 16	2119	5003	-	-	3.0
S25T CTUP R/L 16	2109	5003	-	-	3.0
S32U CTUP R/L 16	2209	5003	3116	4002	3.0
S40V CTUP R/L 16	2209	5003	3116	4002	3.0
S50W CTUP R/L 16	2209	5003	3116	4002	3.0
S40V CTUP R/L 22	2211	5004	3122	4012	3.5
S50W CTUP R/L 22	2211	5004	3122	4012	3.5

TP.. Triangular positive inserts with 11° clearance. Dreikantige positive Wendschneidplatten mit 11° Freiwinkel. A47

Reference / Bez.	l	s	d
TP.. 0902..	9,62	2,38	5,55
TP.. 1103..	11,00	3,18	6,35
TP.. 1603..	16,50	3,18	9,52
TP.. 2204..	22,00	4,76	12,70

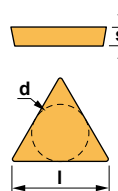

TPMN	TPMR	TPUN
TPUX-R	TPUX-L	



Characteristics:
Multipurpose boring bar for grooving,
threading and turning.
For smaller diameters from 4,2 mm.

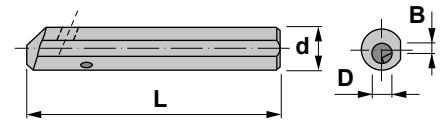

Eigenschaften:
Multifunktions-Bohrstange zum Stechen,
Gewindedrehen und Drehen.
Für kleinere Durchmesser ab 4,2 mm.

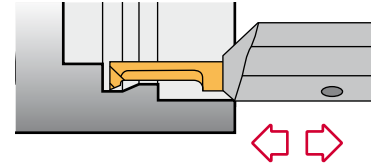

00.30

Reference Bezeichnung	L	d	B	D	Tool size Werkzeug	
00.30.12.04	100	12	2,35	2,5 / 4,2	CTI 04..	0,070
00.30.16.06	120	16	2,80	8,2	CTI 06..	0,150

Reference Bezeichnung			Nm
00.30.12.04	1505	5025	2.0
00.30.16.06	1506	5003	3.0



Characteristics:
Turning tool.
Eigenschaften:
Drehwerkzeuge.

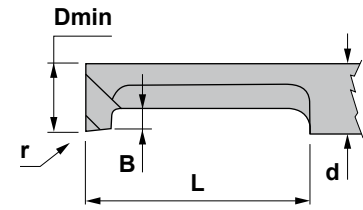

AR

Reference Bezeichnung	L	d	B	Dmin	r
CTI 0402 AR	15	4	0,8	4,2	0,2
CTI 0602 AR	20	6	1,8	6,2	0,2

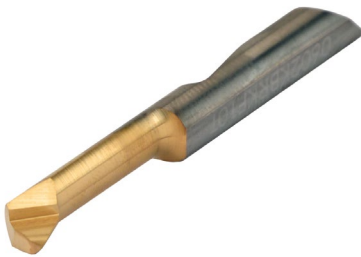

Characteristics:
Copying tool.
Eigenschaften:
Kopierwerkzeuge.

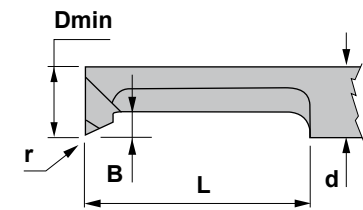

BR

Reference Bezeichnung	L	d	B	Dmin	r
CTI 0402 BR	15	4	0,8	4,2	0,2
CTI 0602 BR	20	6	1,8	6,2	0,2



Characteristics:
Threading tool.
Eigenschaften:
Gewindewerkzeuge.

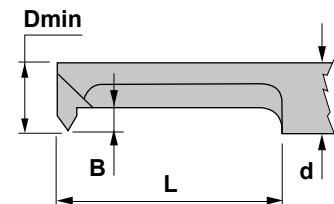

CR

Reference Bezeichnung	L	d	B	Dmin
CTI 0400 CR	15	4	0,8	M5
CTI 0600 CR	20	6	1,8	M8



Characteristics:
Grooving tool.
Eigenschaften:
Stechwerkzeuge.

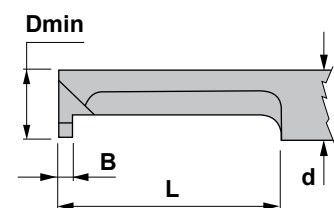

DR

Reference Bezeichnung	L	d	B	Dmin
CTI 0410 DR	15	4	1,0	4,2
CTI 0615 DR	20	6	1,8	6,2



Characteristics: Multipurpose boring bar for grooving, threading and turning.
For smaller diameters from 8 mm.

Eigenschaften: Multifunktions-Bohrstange zum Stechen, Gewindedrehen und Drehen.
Für kleinere Durchmesser ab 8 mm.

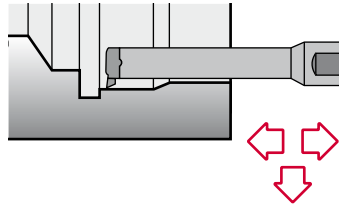
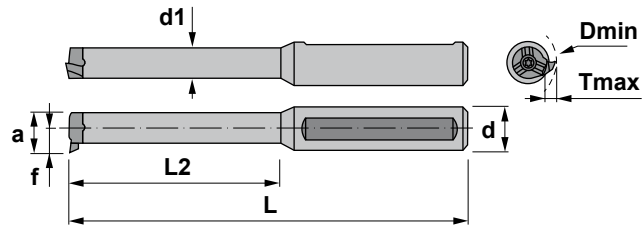

608.00

Reference Bezeichnung	Dmin	d	d1	L	L2	a	f	Tmax	Insert size Wendeschneidplatte	
608.0012.2 HM	8	12	6	90	30	7,8	4,8	1,0	R/LS08	0,090
611.0012.2 HM	11	12	8	110	42	10,7	6,7	2,3	R/LS11	0,090
614.0012.2 HM	14	12	11	110	45	13,8	9,0	4,0	R/LS14	0,130
616.0012.2 HM	16	12	11	130	56	15,7	10,2	4,3	R/LS16	0,265

Reference Bezeichnung			Nm
608.0012.2 HM	1226	5508	1.2
611.0012.2 HM	1535	5510	2.0
614.0012.2 HM	1244	5515	3.0
616.0012.2 HM	1255	5520	4.0

R/LS..

B11-15

Reference / Bez.	d
R/LS.. 08..	6,0
R/LS.. 11..	8,0
R/LS.. 14..	9,0
R/LS.. 16..	11,0

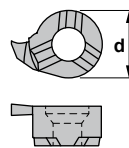

R/LS

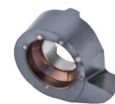

Insert for turning
WSP zum Drehen

R/LS

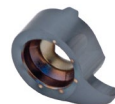

Insert for grooving with radius
WSP zum Vollradius-Stecken

R/LS

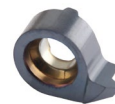

Insert for threading
WSP zum Gewindedrehen

R/LS

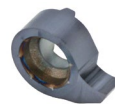

Insert for grooving
WSP zum Stecken



Characteristics:
Multipurpose boring bar equipped with rhombic positive insert (angle 80°).
For boring bars with negative inserts see Ref. MCLN-K (Page: A178) or PCLN (Page: A188).

Axial 0°
Radial -6°

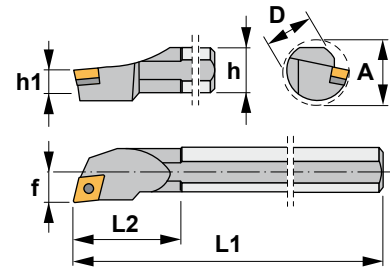

Eigenschaften:
Multifunktions-Bohrstange mit rhombischen positiven Wendeschneidplatten (80° Winkel).
Für Bohrstanen mit negativen Wendeschneidplatten siehe MCLN-K (Seite: A178) oder PCLN (Seite: A188).

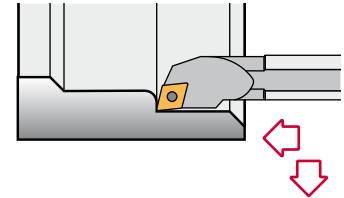

SCLC 95°

Reference Bezeichnung	D	h	h1	L1	L2	f	A	Insert size Wendeschneidplatte	Kg
S08K SCLC R/L 06	8	7	3,5	125	16	5	11	CC.. 0602..	0,040
S10M SCLC R/L 06	10	9	4,5	150	22	7	13	CC.. 0602..	0,060
S12M SCLC R/L 06	12	11	5,5	150	25	9	16	CC.. 0602..	0,150
S12M SCLC R/L 09	12	11	5,5	150	25	9	16	CC.. 09T3..	0,150
S12Q SCLC R/L 09	12	11	5,5	180	25	9	16	CC.. 09T3..	0,150
S16R SCLC R/L 09	16	15	7,5	200	30	11	20	CC.. 09T3..	0,300
S20S SCLC R/L 09	20	18	9,0	250	35	13	24	CC.. 09T3..	0,550
S25T SCLC R/L 09	25	23	11,5	300	40	17	31	CC.. 09T3..	0,550
S20S SCLC R/L 12	20	18	9,0	250	35	13	24	CC.. 1204..	0,550
S25T SCLC R/L 12	25	23	11,5	300	40	17	31	CC.. 1204..	0,700
S32U SCLC R/L 12	32	30	15,0	350	45	22	39	CC.. 1204..	2,050
S40V SCLC R/L 12	40	37	18,5	400	50	27	48	CC.. 1204..	3,750
S50W SCLC R/L 12	50	47	23,5	450	60	35	61	CC.. 1204..	6,500

Reference Bezeichnung					Nm
S08K SCLC R/L 06	1425	5507	-	-	0.9
S10M SCLC R/L 06	1425	5507	-	-	0.9
S12M SCLC R/L 06	1425	5507	-	-	0.9
S12M SCLC R/L 09	1440	5515	-	-	3.0
S12Q SCLC R/L 09	1440	5515	-	-	3.0
S16R SCLC R/L 09	1440	5515	-	-	3.0
S20S SCLC R/L 09	1440	5515	-	-	3.0
S25T SCLC R/L 09	1240	5515	-	-	3.0
S20S SCLC R/L 12	1250	5520	-	-	4.0
S25T SCLC R/L 12	1250	5520	-	-	4.0
S32U SCLC R/L 12	1540	5517	3614	1760	3.0
S40V SCLC R/L 12	1540	5517	3614	1760	3.0
S50W SCLC R/L 12	1540	5517	3614	1760	3.0

CC.. 80° rhombic positive inserts with 7° clearance. A30-31
80° rhombische positive Wendeschneidplatten mit 7° Freiwinkel.

Reference / Bez.	l	s	d
CC.. 0602..	6,45	2,38	6,35
CC.. 09T3..	9,65	3,97	9,52
CC.. 1204..	12,90	4,76	12,70

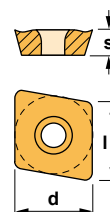

CCGT-AL **CCGT-AP**

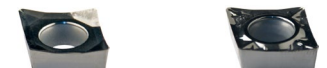

CCMT **CCMW**





Characteristics:

Multipurpose boring bar equipped with rhombic positive insert (angle 80°).

For boring bars with negative inserts see Ref. MCLN-K (Page: A178) or A-PCLN (Page: A189).

Axial 0°
Radial -6°

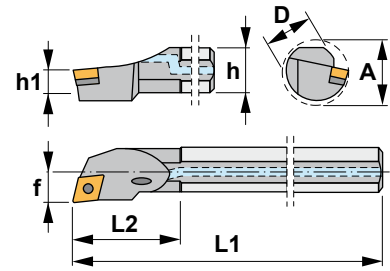

Eigenschaften:

Multifunktions-Bohrstange mit rhombischen positiven Wendeschneidplatten (80° Winkel).

Für Bohrstanen mit negativen Wendeschneidplatten siehe MCLN-K (Seite: A178) oder A-PCLN (Seite: A189).

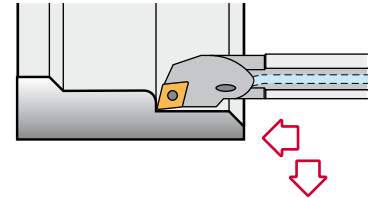

A-SCLC 95°

Reference Bezeichnung	D	h	h1	L1	L2	f	A	Insert size Wendeschneidplatte	
A08F SCLC R/L 06	8	7	3,5	80	20	5	11	CC.. 0602..	0,030
A10H SCLC R/L 06	10	9	4,5	100	20	7	13	CC.. 0602..	0,040
A12K SCLC R/L 06	12	11	5,5	125	25	9	16	CC.. 0602..	0,100
A16M SCLC R/L 09	16	15	7,5	150	30	11	20	CC.. 09T3..	0,200
A20Q SCLC R/L 09	20	18	9,0	180	35	13	24	CC.. 09T3..	0,400
A25R SCLC R/L 09	25	23	11,5	200	40	17	31	CC.. 09T3..	0,700
A32S SCLC R/L 12	32	30	15,0	250	45	22	39	CC.. 1204..	1,400
A40T SCLC R/L 12	40	37	18,5	300	50	27	48	CC.. 1204..	2,650

Reference Bezeichnung					Nm
A08F SCLC R/L 06	1425	5507	-	-	0.9
A10H SCLC R/L 06	1425	5507	-	-	0.9
A12K SCLC R/L 06	1425	5507	-	-	0.9
A16M SCLC R/L 09	1440	5515	-	-	3.0
A20Q SCLC R/L 09	1440	5515	-	-	3.0
A25R SCLC R/L 09	1440	5515	-	-	3.0
A32S SCLC R/L 12	1540	5517	3614	1760	3.0
A40T SCLC R/L 12	1540	5517	3614	1760	3.0

CC.. 80° rhombic positive inserts with 7° clearance. A30-31
80° rhombische positive Wendeschneidplatten mit 7° Freiwinkel.

Reference / Bez.	l	s	d
CC.. 0602..	6,45	2,38	6,35
CC.. 09T3..	9,65	3,97	9,52
CC.. 1204..	12,90	4,76	12,70

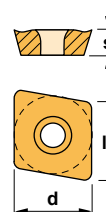

CCGT-AL



CCGT-AP



CCMT



CCMW





Characteristics:

Set of multipurpose boring bars equipped with rhombic positive insert (angle 80°). For boring bars with negative inserts see Ref. A-PCLN (Page: A189).

Axial 0°
Radial -6°

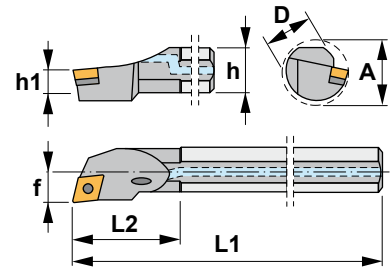

Eigenschaften: Multifunktions-Bohrstangen-Satz mit rhombischen positiven Wendeschneidplatten (80° Winkel). Für Bohrstangen mit negativen Wendeschneidplatten siehe A-PCLN (Seite: A189).

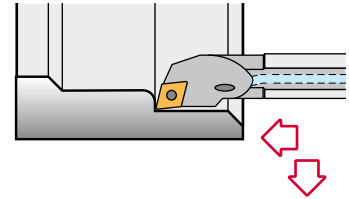

SET SCLC 95°

Reference Bezeichnung	D	d	L1	L2	f	A	h	Insert size Wendeschneidplatte	Kg
A0608H SCLC R/L 06	8	6	100	25	4	10	7	CC.. 0602..	0,400
A0810J SCLC R/L 06	10	8	110	32	6	12	9	CC.. 0602..	
A1012K SCLC R/L 06	12	10	125	38	7	14	11	CC.. 0602..	
A1216M SCLC R/L 06	16	12	150	50	9	18	15	CC.. 0602..	

Reference Bezeichnung			Nm
A0608H SCLC R/L 06	1425	5507	0.9
A0810J SCLC R/L 06	1425	5507	0.9
A1012K SCLC R/L 06	1225	5507	0.9
A1216M SCLC R/L 06	1225	5507	0.9

CC.. 80° rhombic positive inserts with 7° clearance. A30-31
80° rhombische positive Wendeschneidplatten mit 7° Freiwinkel.

Reference / Bez.	l	s	d
CC.. 0602..	6,45	2,38	6,35

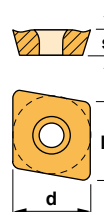

CCGT-AL **CCGT-AP**



CCMT

CCMW





Characteristics:

Carbide boring bar equipped with rhombic positive insert (angle 80°). Range starting at Ø4 mm and minimum bore diameter of 5 mm.

Axial 0°
Radial -6°

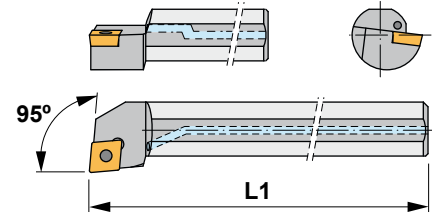

Eigenschaften:

Hartmetall-Bohrstange mit rhombischen positiven Wendeschneidplatten (80° Winkel).

Das Sortiment fängt ab Ø4 mm an, für eine 5 mm Mindestbohrung.

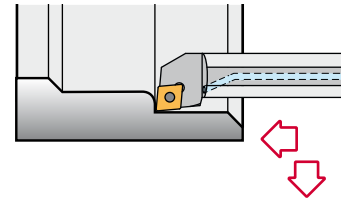

E-SCLC 95°



Reference Bezeichnung	L1 Total length (mm) L1 Gesamtlänge (mm)	Ø min. (mm)	Insert size Wendeschneidplatte	
E04G SCLCR 0305	90	5	CC.. 0301..	0,035
E05H SCLCR 0306	100	6	CC.. 0301..	0,040
E06J SCLCR 0307	110	7	CC.. 0301..	0,050
E07K SCLCR 0408	125	8	CC.. 0401..	0,070
E08K SCLCL 06	125	11	CC.. 0602..	0,085
E08K SCLCR 06	125	11	CC.. 0602..	0,085
E10M SCLCL 06	150	14	CC.. 0602..	0,160
E10M SCLCR 06	150	14	CC.. 0602..	0,160
E12Q SCLCL 06	180	17	CC.. 0602..	0,270
E12Q SCLCR 06	180	17	CC.. 0602..	0,270
E16R SCLCL 09	200	21	CC.. 09T3..	0,520
E16R SCLCR 09	200	21	CC.. 09T3..	0,520
E20S SCLCL 09	250	25	CC.. 09T3..	0,990
E20S SCLCR 09	250	25	CC.. 09T3..	0,990

Reference Bezeichnung			Nm
E04G SCLCR 0305	1415	5506	0.6
E05H SCLCR 0306	1415	5506	0.6
E06J SCLCR 0307	1415	5506	0.6
E07K SCLCR 0408	1420	5506	0.6
E08K SCLCL 06	1425	5507	0.9
E08K SCLCR 06	1425	5507	0.9
E10M SCLCL 06	1425	5507	0.9
E10M SCLCR 06	1425	5507	0.9
E12Q SCLCL 06	1425	5507	0.9
E12Q SCLCR 06	1425	5507	0.9
E16R SCLCL 09	1440	5515	3.0
E16R SCLCR 09	1440	5515	3.0
E20S SCLCL 09	1440	5515	3.0
E20S SCLCR 09	1440	5515	3.0

CC.. 80° rhombic positive inserts with 7° clearance. A30-31
80° rhombische positive WSP mit 7° Freiwinkel.

Reference / Bez.	l	s	d
CC.. 0301..	3,60	1,39	3,50
CC.. 0401..	4,40	1,79	4,30
CC.. 0602..	6,45	2,38	6,35
CC.. 09T3..	9,65	3,97	9,52

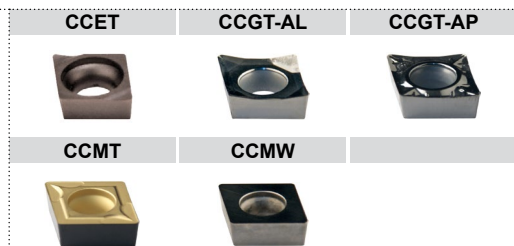
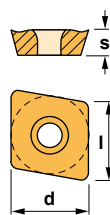



E-SCLC 95°

Features

- Better rigidity than steel bars.
- Excellent cutting performance in a wide range of boring sizes even at vibration cutting condition.
- Longer tool life and excellent surface finish.
- Range starting at \varnothing 4 mm. and minimum bore diameter of 5 mm.

Besonderheiten

- Bessere Festigkeit als die Stahl-Bohrstangen.
- Hervorragende Schnittleistung in einer breiten Palette von Bohrdurchmessern, auch bei schwingenden Schnittbedingungen.
- Längere Standzeiten und ausgezeichnete Oberflächengüte.
- Die Auswahl beginnt mit \varnothing 4 mm und minimum Bohrdurchmesser 5 mm.

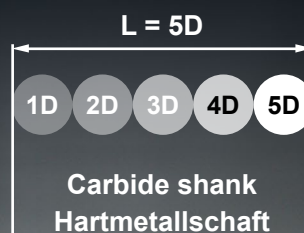
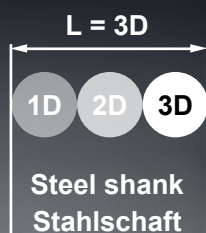

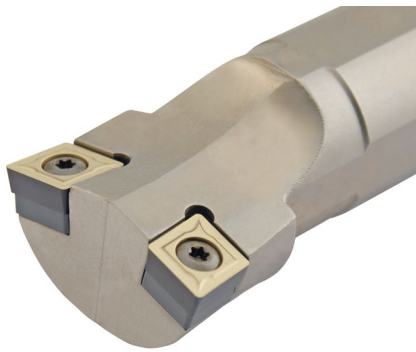

Characteristics:

Multipurpose internal and external boring bar equipped with rhombic positive insert (angle 80°).

For general applications, roughing, semi-finishing and finishing.

Axial 0°
Radial -9°

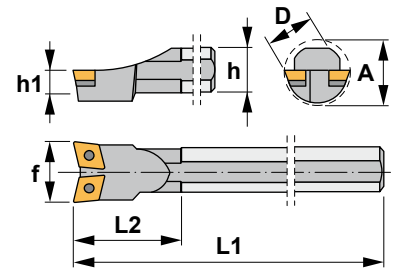

Eigenschaften:



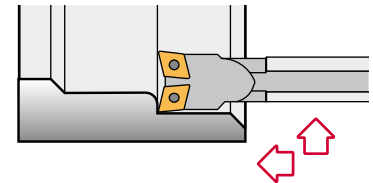

Multifunktions-Bohrstange zum Innen- und Außendreihen mit rhombischen positiven Wendeschneidplatten (80° Winkel).

Für allgemeine Anwendungen, Schruppen, Vorschlichten und Schlichten.



SCLCN 95°

Reference Bezeichnung	D	h	h1	L1	L2	f	A	Insert size Wendeschneidplatte	Ⓚg
S12M SCLC N 06	12	11	5,5	150	25	18	20	CC.. 0602..	0,150
S16R SCLC N 06	16	15	7,5	200	30	22	25	CC.. 0602..	0,300
S20S SCLC N 06	20	18	9,0	250	35	26	30	CC.. 0602..	0,550
S25T SCLC N 09	25	23	11,5	300	40	34	40	CC.. 09T3..	0,700
S32U SCLC N 12	32	30	15,0	350	45	44	50	CC.. 1204..	2,050
S40V SCLC N 12	40	37	18,5	400	50	54	60	CC.. 1204..	3,750
S50W SCLC N 12	50	47	23,5	450	60	62	68	CC.. 1204..	6,500

Reference Bezeichnung					Nm
S12M SCLC N 06	1425	5507	-	-	0.9
S16R SCLC N 06	1225	5507	-	-	0.9
S20S SCLC N 06	1225	5507	-	-	0.9
S25T SCLC N 09	1440	5515	-	-	3.0
S32U SCLC N 12	1540	5517	3614	1760	3.0
S40V SCLC N 12	1540	5517	3614	1760	3.0
S50W SCLC N 12	1540	5517	3614	1760	3.0

CC.. 80° rhombic positive inserts with 7° clearance.  A30-31
80° rhombische positive Wendeschneidplatten mit 7° Freiwinkel.

Reference / Bez.	l	s	d
CC.. 0602..	6,45	2,38	6,35
CC.. 09T3..	9,65	3,97	9,52
CC.. 1204..	12,90	4,76	12,70

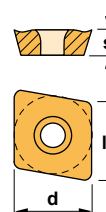

CCGT-AL **CCGT-AP**



CCMT

CCMW





Characteristics:

Multipurpose profiling boring bar equipped with rhombic positive insert (angle 55°). For general applications, roughing, semi-finishing and finishing.

Axial 0°
Radial -6°

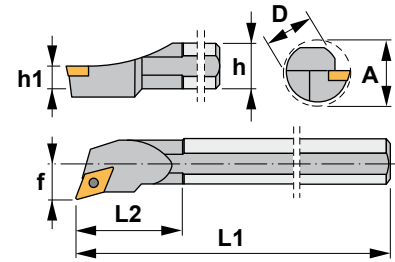

Eigenschaften:

Multifunktions-Bohrstange zum Profildrehen mit rhombischen positiven Wendeschneidplatten (55° Winkel).

Für allgemeine Anwendungen, Schruppen, Vorschlichten und Schlichten.

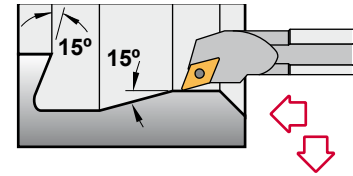

SDQC 107°30'

Reference Bezeichnung	D	h	h1	L1	L2	f	A	Insert size Wendeschneidplatte	kg
S10M SDQC R/L 07	10	9	4,5	150	22	7	13	DC.. 0702..	0,060
S12M SDQC R/L 07	12	11	5,5	150	25	9	16	DC.. 0702..	0,150
S16R SDQC R/L 07	16	15	7,5	200	30	11	20	DC.. 0702..	0,300
S20S SDQC R/L 07	20	18	9,0	250	35	13	24	DC.. 0702..	0,550
S20S SDQC R/L 11	20	18	9,0	250	35	13	24	DC.. 11T3..	0,550
S25T SDQC R/L 11	25	23	11,5	300	40	17	31	DC.. 11T3..	0,700
S32U SDQC R/L 11	32	30	15,0	350	45	22	39	DC.. 11T3..	2,050
S40V SDQC R/L 11	40	37	18,5	400	50	27	48	DC.. 11T3..	3,750

Reference Bezeichnung					Nm
S10M SDQC R/L 07	1425	5507	-	-	0.9
S12M SDQC R/L 07	1225	5507	-	-	0.9
S16R SDQC R/L 07	1225	5507	-	-	0.9
S20S SDQC R/L 07	1225	5507	-	-	0.9
S20S SDQC R/L 11	1240	5515	-	-	3.0
S25T SDQC R/L 11	1240	5515	-	-	3.0
S32U SDQC R/L 11	1335	5516	3714	1750	3.0
S40V SDQC R/L 11	1335	5516	3714	1750	3.0

DC.. 55° rhombic positive inserts with 7° clearance. A35
55° rhombische positive Wendeschneidplatten mit 7° Freiwinkel.

Reference / Bez.	l	s	d
DC.. 0702..	7,75	2,38	6,35
DC.. 11T3..	11,60	3,97	9,52

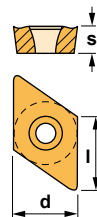

DCGT-AL



DCGT-AP



DCMT



DCMW

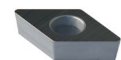



Characteristics:

Multipurpose profiling boring bar equipped with rhombic positive insert (angle 55°). For general applications, roughing, semi-finishing and finishing.

Axial 0°
Radial -6°

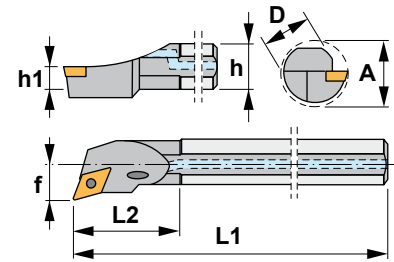

Eigenschaften:

Multifunktions-Bohrstange zum Profildrehen mit rhombischen positiven Wendeschneidplatten (55° Winkel).

Für allgemeine Anwendungen, Schruppen, Vorschlichten und Schlichten.

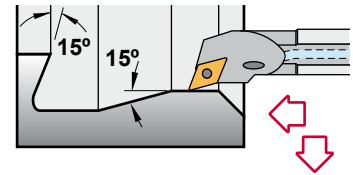

A-SDQC 107°30'

Reference Bezeichnung	D	h	h1	L1	L2	f	A	Insert size Wendeschneidplatte	Kg
A12K SDQC R/L 07	12	11	5,5	125	25	9	16	DC.. 0702..	0,100
A16M SDQC R/L 07	16	15	7,5	150	30	11	20	DC.. 0702..	0,200
A20Q SDQC R/L 11	20	18	9,0	180	35	13	24	DC.. 11T3..	0,400
A25R SDQC R/L 11	25	23	11,5	200	40	17	31	DC.. 11T3..	0,700
A32S SDQC R/L 11	32	30	15,0	250	45	22	39	DC.. 11T3..	1,400
A40T SDQC R/L 11	40	37	18,5	300	50	27	48	DC.. 11T3..	2,650

Reference Bezeichnung					Nm
A12K SDQC R/L 07	1225	5507	-	-	0.9
A16M SDQC R/L 07	1225	5507	-	-	0.9
A20Q SDQC R/L 11	1240	5515	-	-	3.0
A25R SDQC R/L 11	1240	5515	-	-	3.0
A32S SDQC R/L 11	1335	5516	3714	1750	3.0
A40T SDQC R/L 11	1335	5516	3714	1750	3.0

DC.. 55° rhombic positive inserts with 7° clearance. A35
55° rhombische positive Wendeschneidplatten mit 7° Freiwinkel.

Reference / Bez.	l	s	d
DC.. 0702..	7,75	2,38	6,35
DC.. 11T3..	11,60	3,97	9,52

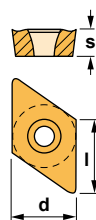

DCGT-AL **DCGT-AP**



DCMT

DCMW

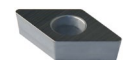



Characteristics:

Set of multipurpose profiling boring bars equipped with rhombic positive insert (angle 55°).

For general applications, roughing, semi-finishing and finishing.

Axial 0°
Radial -6°

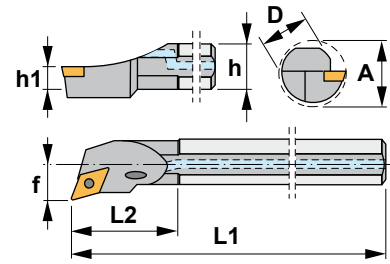

Eigenschaften:

Multifunktions-Bohrstangen-Satz zum Profildrehen mit rhombischen positiven Wendeschneidplatten (55° Winkel).

Für allgemeine Anwendungen, Schruppen, Vorschlichten und Schlichten.

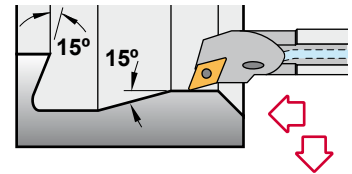

SET SDQC 107°30'

Reference Bezeichnung	D	d	L1	L2	f	A	h	Insert size Wendeschneidplatte	Kg
A0810J SDQC R/L 07	10	8	110	32	7	12,5	9	DC.. 0702..	0,350
A1012K SDQC R/L 07	12	10	125	38	9	15,5	11	DC.. 0702..	
A1216M SDQC R/L 07	16	12	150	50	11	19,5	15	DC.. 0702..	

Reference Bezeichnung			Nm	
A0810J SDQC R/L 07		1225	5507	0.9
A1012K SDQC R/L 07		1225	5507	0.9
A1216M SDQC R/L 07		1225	5507	0.9

DC.. 55° rhombic positive inserts with 7° clearance. A35
55° rhombische positive Wendeschneidplatten mit 7° Freiwinkel.

Reference / Bez.	l	s	d
DC.. 0702..	7,75	2,38	6,35

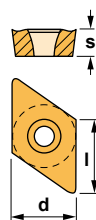

DCGT-AL



DCGT-AP



DCMT



DCMW

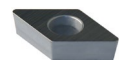



Characteristics:

Carbide boring bar equipped with rhombic positive insert (angle 55°). Range starting at Ø10 mm and minimum bore diameter of 14 mm.

Axial 0°
Radial -6°

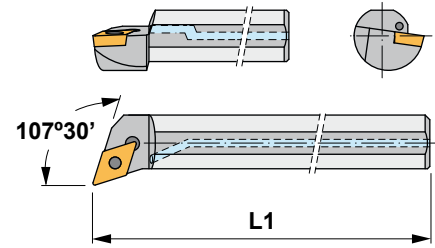

Eigenschaften:

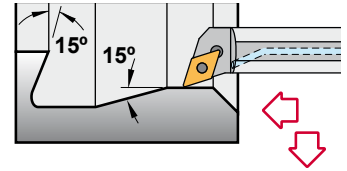

Hartmetall-Bohrstange mit rhombischen positiven Wendeschneidplatten (55° Winkel).

Das Sortiment fängt ab Ø10 mm an, für eine 14 mm Mindestbohrung.



E-SDQC 107°30'  

Reference Bezeichnung	L1 Total length (mm) L1 Gesamtlänge (mm)	Ø min. (mm)	Insert size Wendeschneidplatte	
E10M SDQCL 07	150	14	DC.. 0702..	0,165
E10M SDQCR 07	150	14	DC.. 0702..	0,165
E12Q SDQCL 07	180	17	DC.. 0702..	0,270
E12Q SDQCR 07	180	17	DC.. 0702..	0,270
E16R SDQCL 07	200	21	DC.. 0702..	0,520
E16R SDQCR 07	200	21	DC.. 0702..	0,520
E20S SDQCR 07	250	25	DC.. 0702..	0,800
E25T SDQCR 11	300	25	DC.. 11T3..	1,000

Reference Bezeichnung			Nm
E10M SDQCL 07	1425	5507	0.9
E10M SDQCR 07	1425	5507	0.9
E12Q SDQCL 07	1225	5507	0.9
E12Q SDQCR 07	1225	5507	0.9
E16R SDQCL 07	1225	5507	0.9
E16R SDQCR 07	1225	5507	0.9
E20S SDQCR 07	1225	5507	0.9
E25T SDQCR 11	1240	5515	3.0

DC.. 55° rhombic positive inserts with 7° clearance.  A35
55° rhombische positive Wendeschneidplatten mit 7° Freiwinkel.

Reference / Bez.	l	s	d
DC.. 0702..	7,75	2,38	6,35
DC.. 11T3..	11,60	3,97	9,52

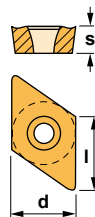

DCGT-AL



DCGT-AP



DCMT



DCMW

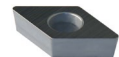



Characteristics:

Multipurpose profiling boring bar equipped with rhombic positive insert (angle 55°). For boring bars with negative inserts see Ref. MDUN-K (Page: A179) or PDUN (Page: A190).

Axial 0°
Radial -6°

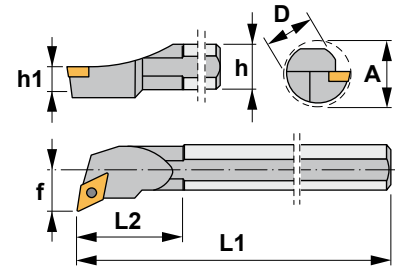

Eigenschaften:

Multifunktions-Bohrstange zum Profildrehen mit rhombischen positiven Wendeschneidplatten (55° Winkel). Für Bohrstanen mit negativen Wendeschneidplatten siehe MDUN-K (Seite: A179) oder PDUN (Seite: A190).

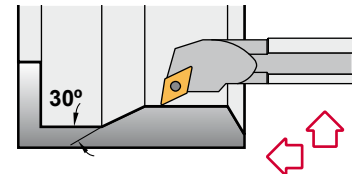

SDUC 93°

Reference Bezeichnung	D	h	h1	L1	L2	f	A	Insert size Wendeschneidplatte	kg
S10M SDUC R/L 07	10	9	4,5	150	22	7	13	DC.. 0702..	0,060
S12M SDUC R/L 07	12	11	5,5	150	25	9	16	DC.. 0702..	0,150
S12Q SDUC R/L 07	12	11	5,5	180	25	9	16	DC.. 0702..	0,150
S16R SDUC R/L 07	16	15	7,5	200	30	11	20	DC.. 0702..	0,300
S20S SDUC R/L 07	20	18	9,0	250	35	13	24	DC.. 0702..	0,550
S20S SDUC R/L 11	20	18	9,0	250	35	13	24	DC.. 11T3..	0,550
S25T SDUC R/L 11	25	23	11,5	300	40	17	31	DC.. 11T3..	0,700
S32U SDUC R/L 11	32	30	15,0	350	45	22	39	DC.. 11T3..	2,050
S40V SDUC R/L 11	40	37	18,5	400	50	27	48	DC.. 11T3..	3,750

Reference Bezeichnung					Nm
S10M SDUC R/L 07	1425	5507	-	-	0.9
S12M SDUC R/L 07	1225	5507	-	-	0.9
S12Q SDUC R/L 07	1225	5507	-	-	0.9
S16R SDUC R/L 07	1225	5507	-	-	0.9
S20S SDUC R/L 07	1225	5507	-	-	0.9
S20S SDUC R/L 11	1240	5515	-	-	3.0
S25T SDUC R/L 11	1240	5515	-	-	3.0
S32U SDUC R/L 11	1335	5516	3714	1750	3.0
S40V SDUC R/L 11	1335	5516	3714	1750	3.0

DC.. 55° rhombic positive inserts with 7° clearance. A35
55° rhombische positive Wendeschneidplatten mit 7° Freiwinkel.

Reference / Bez.	l	s	d
DC.. 0702..	7,75	2,38	6,35
DC.. 11T3..	11,60	3,97	9,52

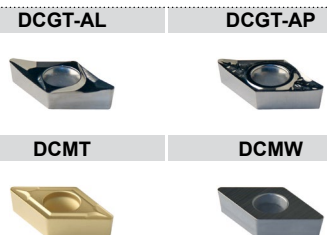
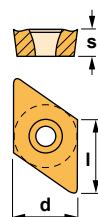



Characteristics:

Multipurpose profiling boring bar equipped with rhombic positive insert (angle 55°). For boring bars with negative inserts see Ref. MDUN-K (Page: A179) or A-PDUN (Page: A191).

Axial 0°
Radial -6°

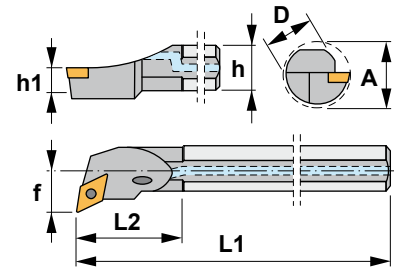

Eigenschaften:

Multifunktions-Bohrstange zum Profildrehen mit rhombischen positiven Wendeschneidplatten (55° Winkel). Für Bohrstanen mit negativen Wendeschneidplatten siehe MDUN-K (Seite: A179) oder A-PDUN (Seite: A191).

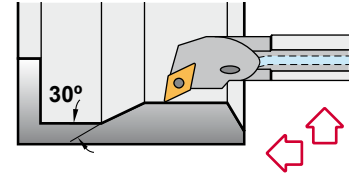

A-SDUC 93°

Reference Bezeichnung	D	h	h1	L1	L2	f	A	Insert size Wendeschneidplatte	kg
A12K SDUC R/L 07	12	11	5,5	125	25	9	16	DC.. 0702..	0,100
A16M SDUC R/L 07	16	15	7,5	150	30	11	20	DC.. 0702..	0,200
A20Q SDUC R/L 11	20	18	9,0	180	35	13	24	DC.. 11T3..	0,400
A25R SDUC R/L 11	25	23	11,5	200	40	17	31	DC.. 11T3..	0,700
A32S SDUC R/L 11	32	30	15,0	250	45	22	39	DC.. 11T3..	1,400
A40T SDUC R/L 11	40	37	18,5	300	50	27	48	DC.. 11T3..	2,650

Reference Bezeichnung					Nm
A12K SDUC R/L 07	1225	5507	-	-	0.9
A16M SDUC R/L 07	1225	5507	-	-	0.9
A20Q SDUC R/L 11	1440	5515	-	-	3.0
A25R SDUC R/L 11	1240	5515	-	-	3.0
A32S SDUC R/L 11	1335	5516	3714	1750	3.0
A40T SDUC R/L 11	1335	5516	3714	1750	3.0

DC.. 55° rhombic positive inserts with 7° clearance. A35
55° rhombische positive Wendeschneidplatten mit 7° Freiwinkel.

Reference / Bez.	l	s	d
DC.. 0702..	7,75	2,38	6,35
DC.. 11T3..	11,60	3,97	9,52

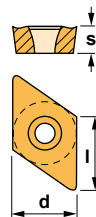

DCGT-AL



DCGT-AP



DCMT



DCMW

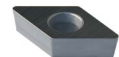



Characteristics:

Set of multipurpose profiling boring bars equipped with rhombic positive insert (angle 55°).

For boring bars with negative inserts see Ref. A-PDUN (Page: A191).

Axial 0°
Radial -6°

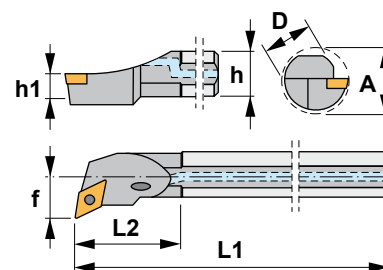

Eigenschaften:

Multifunktions-Bohrstangen-Satz zum Profildrehen mit rhombischen positiven Wendeschneidplatten (55° Winkel).

Für Bohrstangen mit negativen Wendeschneidplatten siehe A-PDUN (Seite: A191).

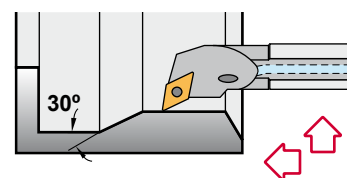

SET SDUC 93°

Reference Bezeichnung	D	d	L1	L2	f	A	h	Insert size Wendeschneidplatte	Kg
A0810J SDUC R/L 07	10	8	110	32	7	12,5	9	DC.. 0702..	0,350
A1012K SDUC R/L 07	12	10	125	38	9	15,5	11	DC.. 0702..	
A1216M SDUC R/L 07	16	12	150	50	11	19,5	15	DC.. 0702..	

Reference Bezeichnung			Nm
A0810J SDUC R/L 07	1225	5507	0.9
A1012K SDUC R/L 07	1225	5507	0.9
A1216M SDUC R/L 07	1225	5507	0.9

DC.. 55° rhombic positive inserts with 7° clearance. A35
55° rhombische positive Wendeschneidplatten mit 7° Freiwinkel.

Reference / Bez.	l	s	d
DC.. 0702..	7,75	2,38	6,35

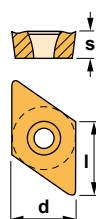

DCGT-AL



DCGT-AP



DCMT



DCMW

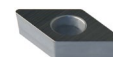

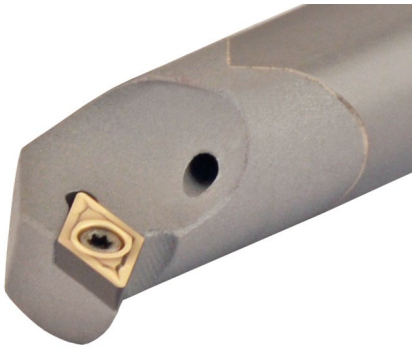

Characteristics:

Carbide boring bar equipped with rhombic positive insert (angle 55°).
Range starting at Ø10 mm and minimum bore diameter of 14 mm.

Axial 0°
Radial -6°

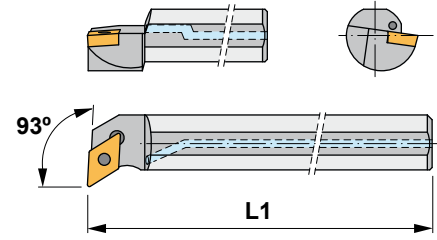

Eigenschaften:

Hartmetall-Bohrstange mit rhombischen positiven Wendeschneidplatten (55° Winkel).

Das Sortiment fängt ab Ø10 mm an, für eine 14 mm Mindestbohrung.

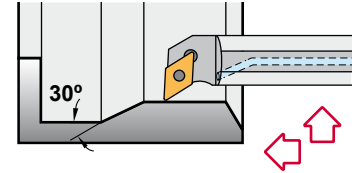

E-SDUC 93°



Reference Bezeichnung	L1 Total length (mm) L1 Gesamtlänge (mm)	Ø min. (mm)	Insert size Wendeschneidplatte	kg
E10M SDUCL 07	150	14	DC.. 0702..	0,165
E10M SDUCR 07	150	14	DC.. 0702..	0,165
E12Q SDUCL 07	180	17	DC.. 0702..	0,265
E12Q SDUCR 07	180	17	DC.. 0702..	0,265
E16R SDUCL 07	200	21	DC.. 0702..	0,525
E16R SDUCR 07	200	21	DC.. 0702..	0,525
E20S SDUCL 11	250	25	DC.. 11T3..	1,000
E20S SDUCR 11	250	25	DC.. 11T3..	1,000
E25T SDUCR 11	300	32	DC.. 11T3..	1,250

Reference Bezeichnung			Nm
E10M SDUCL 07	1425	5507	0.9
E10M SDUCR 07	1425	5507	0.9
E12Q SDUCL 07	1225	5507	0.9
E12Q SDUCR 07	1225	5507	0.9
E16R SDUCL 07	1225	5507	0.9
E16R SDUCR 07	1225	5507	0.9
E20S SDUCL 11	1240	5515	3.0
E20S SDUCR 11	1240	5515	3.0
E25T SDUCR 11	1240	5515	3.0

DC.. 55° rhombic positive inserts with 7° clearance. A35
55° rhombische positive Wendeschneidplatten mit 7° Freiwinkel.

Reference / Bez.	l	s	d
DC.. 0702..	7,75	2,38	6,35
DC.. 11T3..	11,60	3,97	9,52

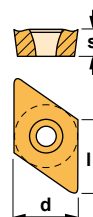

DCGT-AL



DCGT-AP



DCMT



DCMW

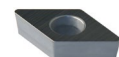

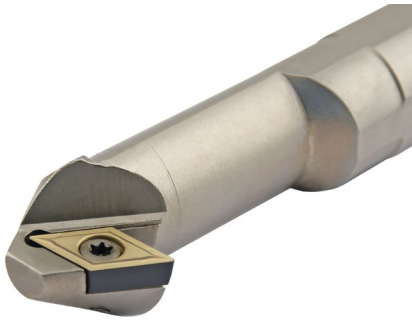

Characteristics:

Backwards multipurpose profiling boring bar equipped with rhombic positive insert (angle 55°).

For boring bars with negative inserts see Ref. PDUN-EX (Page: A192).

Axial 0°
Radial -6°

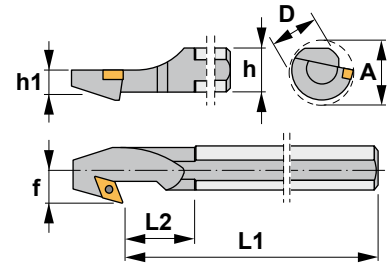

Eigenschaften:

Rückwärts-Multifunktions-Bohrstange zum Profildrehen mit rhombischen positiven Wendeschneidplatten (55° Winkel).

Für Bohrstanen mit negativen Wendeschneidplatten siehe PDUN-EX (Seite: A192).

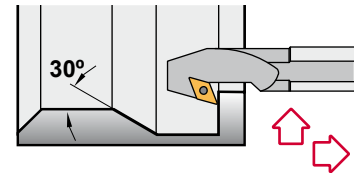

SDUC 93°-EX

Reference Bezeichnung	D	h	h1	L1	L2	f	A	Insert size Wendeschneidplatte	kg
S12MSDUC R/L 07-EX	12	11	5,5	150	25	9	16	DC.. 0702..	0,150
S16R SDUC R/L 07-EX	16	15	7,5	200	30	11	20	DC.. 0702..	0,300
S20S SDUC R/L 07-EX	20	18	9,0	250	35	13	24	DC.. 0702..	0,550
S20S SDUC R/L 11-EX	20	18	9,0	250	35	13	24	DC.. 11T3..	0,550
S25T SDUC R/L 11-EX	25	23	11,5	300	40	17	31	DC.. 11T3..	0,700
S32U SDUC R/L 11-EX	32	30	15,0	350	50	22	39	DC.. 11T3..	2,050
S40V SDUC R/L 11-EX	40	37	18,5	400	60	27	48	DC.. 11T3..	3,750

Reference Bezeichnung					Nm
S12MSDUC R/L 07-EX	1225	5507	-	-	0.9
S16R SDUC R/L 07-EX	1225	5507	-	-	0.9
S20S SDUC R/L 07-EX	1225	5507	-	-	0.9
S20S SDUC R/L 11-EX	1240	5515	-	-	3.0
S25T SDUC R/L 11-EX	1240	5515	-	-	3.0
S32U SDUC R/L 11-EX	1335	5516	3714	1750	3.0
S40V SDUC R/L 11-EX	1335	5516	3714	1750	3.0

DC.. 55° rhombic positive inserts with 7° clearance. A35
55° rhombische positive Wendeschneidplatten mit 7° Freiwinkel.

Reference / Bez.	l	s	d
DC.. 0702..	7,75	2,38	6,35
DC.. 11T3..	11,60	3,97	9,52

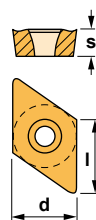

DCGT-AL



DCGT-AP



DCMT



DCMW

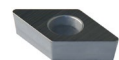



Characteristics:

Backwards multipurpose profiling boring bar equipped with rhombic positive insert (angle 55°).

For boring bars with negative inserts see Ref. PDUN-EX (Page: A192).

Axial 0°
Radial -6°

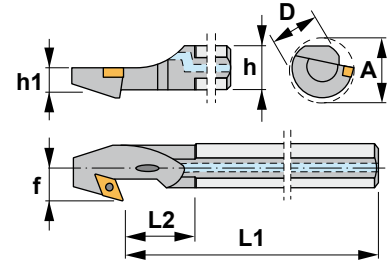

Eigenschaften:

Rückwärts-Multifunktions-Bohrstange zum Profildrehen mit rhombischen positiven Wendeschneidplatten (55° Winkel).

Für Bohrstanen mit negativen Wendeschneidplatten siehe PDUN-EX (Seite: A192).

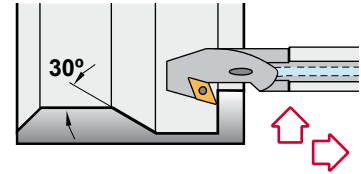

A-SDUC 93°-EX



Reference Bezeichnung	D	h	h1	L1	L2	f	A	Insert size Wendeschneidplatte	Kg
A12K SDUC R/L 07-EX	12	11	5,5	125	25	9	16	DC.. 0702..	0,100
A16M SDUC R/L 07-EX	16	15	7,5	150	30	11	20	DC.. 0702..	0,200
A20Q SDUC R/L 11-EX	20	18	9,0	180	35	13	24	DC.. 11T3..	0,400
A25R SDUC R/L 11-EX	25	23	11,5	200	40	17	31	DC.. 11T3..	0,700

Reference Bezeichnung			Nm
A12K SDUC R/L 07-EX	1225	5507	0.9
A16M SDUC R/L 07-EX	1225	5507	0.9
A20Q SDUC R/L 11-EX	1240	5515	3.0
A25R SDUC R/L 11-EX	1240	5515	3.0

DC.. 55° rhombic positive inserts with 7° clearance. A35
55° rhombische positive Wendeschneidplatten mit 7° Freiwinkel.

Reference / Bez.	l	s	d
DC.. 0702..	7,75	2,38	6,35
DC.. 11T3..	11,60	3,97	9,52

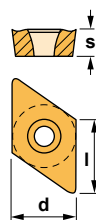

DCGT-AL



DCGT-AP



DCMT



DCMW

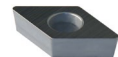



Characteristics:

Multipurpose boring bar equipped with square positive insert.

For boring bars with negative inserts see Ref. MSKN-K (Page: A180) or PSKN (Page: A193).

Axial 0°
Radial -8°

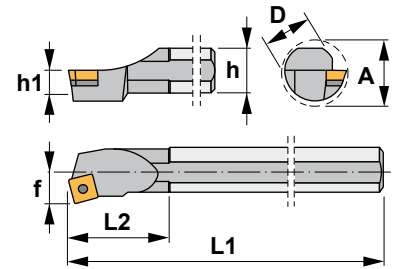

Eigenschaften:

Multifunktions-Bohrstange mit vierkantigen positiven Wendeschneidplatten.

Für Bohrstanen mit negativen Wendeschneidplatten siehe MSKN-K (Seite: A180) oder PSKN (Seite: A193).

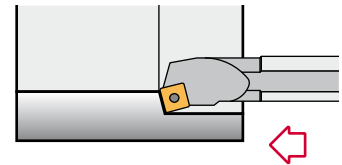

SSKC 75°

Reference Bezeichnung	D	h	h1	L1	L2	f	A	Insert size Wendeschneidplatte	Kg
S16R SSKC R/L 09	16	15	7,5	200	30	11	20	SC.. 09T3..	0,300
S20S SSKC R/L 09	20	18	9,0	250	35	13	24	SC.. 09T3..	0,550
S25T SSKC R/L 09	25	23	11,5	300	40	17	31	SC.. 09T3..	0,700
S32U SSKC R/L 12	32	30	15,0	350	45	22	39	SC.. 1204..	2,050
S40V SSKC R/L 12	40	37	18,5	400	50	27	48	SC.. 1204..	3,750
S50W SSKC R/L 12	50	47	23,5	450	60	35	61	SC.. 1204..	6,500

Reference Bezeichnung					Nm
S16R SSKC R/L 09	1440	5515	-	-	3.0
S20S SSKC R/L 09	1240	5515	-	-	3.0
S25T SSKC R/L 09	1240	5515	-	-	3.0
S32U SSKC R/L 12	1540	5517	3514	1760	3.0
S40V SSKC R/L 12	1540	5517	3514	1760	3.0
S50W SSKC R/L 12	1540	5517	3514	1760	3.0

SC..

Square positive inserts with 7° clearance. A40
Vierkantige positive Wendeschneidplatten mit 7° Freiwinkel.

Reference / Bez.	l	s	d
SC.. 09T3..	9,52	3,97	9,52
SC.. 1204..	12,70	4,76	12,70

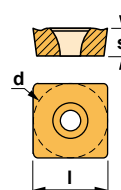

SCGT-AL



SCMT



SCMT-39



SCMW





Characteristics:

Multipurpose boring bar equipped with square positive insert.
For boring bars with negative inserts see Ref. A-PSSN (Page: A195).

Axial 0°
Radial -8°

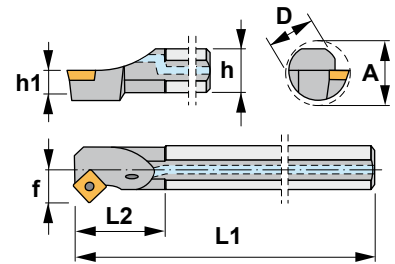

Eigenschaften:

Multifunktions-Bohrstange mit vierkantigen positiven Wendeschneidplatten.
Für Bohrstanen mit negativen Wendeschneidplatten siehe A-PSSN (Seite: A195).

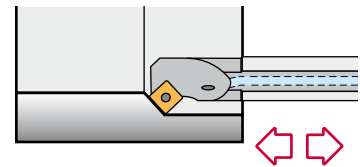

A-SSSC 45°

Reference Bezeichnung	D	h	h1	L1	L2	f	A	Insert size Wendeschneidplatte	kg
A16M SSSC R/L 09	16	15	7,5	150	30	11	20	SC.. 09T3..	0,300
A20Q SSSC R/L 09	20	18	9,0	180	35	13	24	SC.. 09T3..	0,550
A25R SSSC R/L 09	25	23	11,5	200	40	17	31	SC.. 09T3..	0,700

Reference Bezeichnung			Nm
A16M SSSC R/L 09	1440	5515	3.0
A20Q SSSC R/L 09	1440	5515	3.0
A25R SSSC R/L 09	1240	5515	3.0

SC.. Square positive inserts with 7° clearance. A40
Vierkantige positive Wendeschneidplatten mit 7° Freiwinkel.

Reference / Bez.	l	s	d
SC.. 09T3..	9,52	3,97	9,52

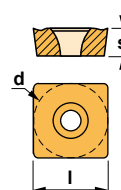

SCGT-AL



SCMT



SCMT-39



SCMW





Characteristics:

Multipurpose boring bar equipped with triangular positive insert.

For boring bars with negative inserts see Ref. MTFN (Page: A181), MTFN-K (Page: A182) or PTFN (Page: A196).

Axial 0°
Radial -6°

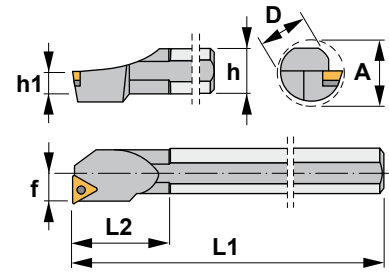

Eigenschaften:

Multifunktions-Bohrstange mit dreikantigen positiven Wendeschneidplatten.

Für Bohrstanen mit negativen Wendeschneidplatten siehe MTFN (Seite: A181), MTFN-K (Seite: A182) oder PTFN (Seite: A196).

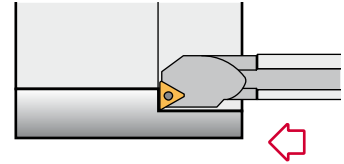

STFC 90°

Reference Bezeichnung	D	h	h1	L1	L2	f	A	Insert size Wendeschneidplatte	kg
S10M STFC R/L 09	10	9	4,5	150	22	7	13	TC.. 0902..	0,060
S12M STFC R/L 09	12	11	5,5	150	25	9	16	TC.. 0902..	0,150
S12M STFC R/L 11	12	11	5,5	150	25	9	16	TC.. 1102..	0,150
S12Q STFC R/L 11	12	11	5,5	180	25	9	16	TC.. 1102..	0,050
S16R STFC R/L 11	16	15	7,5	200	30	11	20	TC.. 1102..	0,300
S20S STFC R/L 11	20	18	9,0	250	35	13	24	TC.. 1102..	0,550
S20S STFC R/L 16	20	18	9,0	250	35	13	24	TC.. 16T3..	0,550
S25T STFC R/L 16	25	23	11,5	300	40	17	31	TC.. 16T3..	0,700
S32U STFC R/L 16	32	30	15,0	350	45	22	39	TC.. 16T3..	2,050
S40V STFC R/L 16	40	37	18,5	400	50	27	48	TC.. 16T3..	3,750

Reference Bezeichnung					Nm
S10M STFC R/L 09	1222	5506	-	-	0.6
S12M STFC R/L 09	1222	5506	-	-	0.6
S12M STFC R/L 11	1225	5507	-	-	0.9
S12Q STFC R/L 11	1225	5507	-	-	0.9
S16R STFC R/L 11	1225	5507	-	-	0.9
S20S STFC R/L 11	1225	5507	-	-	0.9
S20S STFC R/L 16	1240	5515	-	-	3.0
S25T STFC R/L 16	1240	5515	-	-	3.0
S32U STFC R/L 16	1335	5516	3414	1750	3.0
S40V STFC R/L 16	1335	5516	3414	1750	3.0

TC.. Triangular positive inserts with 7° clearance. A44
Dreikantige positive Wendeschneidplatten mit 7° Freiwinkel.

Reference / Bez.	l	s	d
TC.. 0902..	9,62	2,38	5,55
TC.. 1102..	11,00	2,38	6,35
TC.. 16T3..	16,50	3,97	9,52

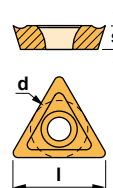

TCGT-AL



TCMT



TCMW

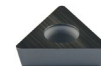



Characteristics:

Multipurpose boring bar equipped with triangular positive insert.

For boring bars with negative inserts see Ref. MTFN (Page: A181), MTFN-K (Page: A182) or A-PTFN (Page: A197).

Axial 0°
Radial -6°

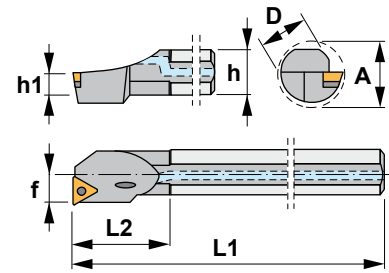

Eigenschaften:

Multifunktions-Bohrstange mit dreikantigen positiven Wendeschneidplatten.

Für Bohrstanen mit negativen Wendeschneidplatten siehe MTFN (Seite: A181), MTFN-K (Seite: A182) oder A-PTFN (Seite: A197).

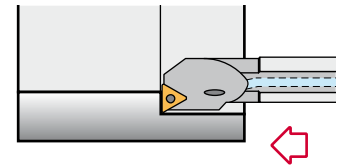

A-STFC 90°

Reference Bezeichnung	D	h	h1	L1	L2	f	A	Insert size Wendeschneidplatte	kg
A10H STFC R/L 09	10	9	4,5	100	20	7	13	TC.. 0902..	0,040
A12K STFC R/L 11	12	11	5,5	125	25	9	16	TC.. 1102..	0,100
A16M STFC R/L 11	16	15	7,5	150	30	11	20	TC.. 1102..	0,200
A20Q STFC R/L 11	20	18	9,0	180	35	13	24	TC.. 1102..	0,400
A25R STFC R/L 16	25	23	11,5	200	40	17	31	TC.. 16T3..	0,700
A32S STFC R/L 16	32	30	15,0	250	45	22	39	TC.. 16T3..	1,400
A40T STFC R/L 16	40	37	18,5	300	50	27	48	TC.. 16T3..	2,650

Reference Bezeichnung					Nm
A10H STFC R/L 09	1222	5506	-	-	0.6
A12K STFC R/L 11	1225	5507	-	-	0.9
A16M STFC R/L 11	1225	5507	-	-	0.9
A20Q STFC R/L 11	1225	5507	-	-	0.9
A25R STFC R/L 16	1240	5515	-	-	3.0
A32S STFC R/L 16	1335	5516	3414	1750	3.0
A40T STFC R/L 16	1335	5516	3414	1750	3.0

TC.. Triangular positive inserts with 7° clearance. A44
Dreikantige positive Wendeschneidplatten mit 7° Freiwinkel.

Reference / Bez.	l	s	d
TC.. 0902..	9,62	2,38	5,55
TC.. 1102..	11,00	2,38	6,35
TC.. 16T3..	16,50	3,97	9,52

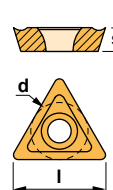

TCGT-AL



TCMT



TCMW

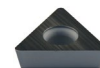



Characteristics:

Set of multipurpose boring bars equipped with triangular positive insert.

For boring bars with negative inserts see Ref. A-PTFN (Page: A197).

Axial 0°
Radial -6°

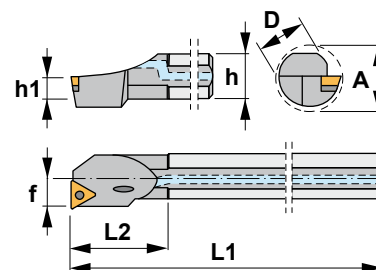

Eigenschaften:

Multifunktions-Bohrstangen-Satz mit dreikantigen positiven Wendeschneidplatten. Für Bohrstangen mit negativen Wendeschneidplatten siehe A-PTFN (Seite: A197).

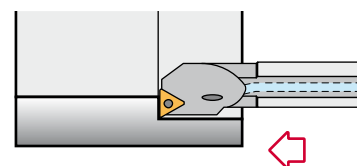

SET STFC 90°

Reference Bezeichnung	D	d	L1	L2	f	A	h	Insert size Wendeschneidplatte	
A0810J STFC R/L 11	10	8	110	32	7	12,5	9	TC.. 1102..	0,350
A1012K STFC R/L 11	12	10	125	38	9	15,5	11	TC.. 1102..	
A1216M STFC R/L 11	16	12	150	50	11	19,5	15	TC.. 1102..	

Reference Bezeichnung			Nm	
A0810J STFC R/L 11		1425	5507	0.9
A1012K STFC R/L 11		1225	5507	0.9
A1216M STFC R/L 11		1225	5507	0.9

TC.. Triangular positive inserts with 7° clearance. A44
Dreikantige positive Wendeschneidplatten mit 7° Freiwinkel.

Reference / Bez.	l	s	d
TC.. 1102..	11,00	2,38	6,35

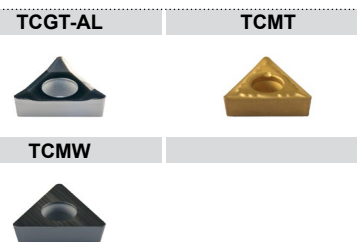
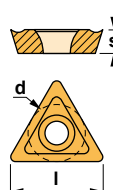

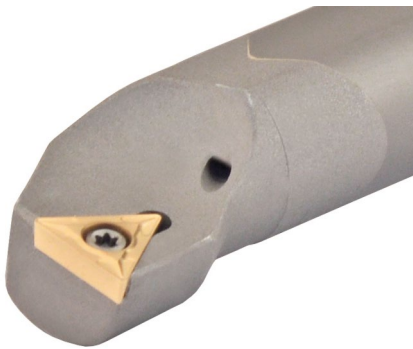

Characteristics:

Carbide boring bar equipped with triangular positive insert.
Range starting at Ø12 mm and minimum bore diameter of 17 mm.

Axial 0°
Radial -6°

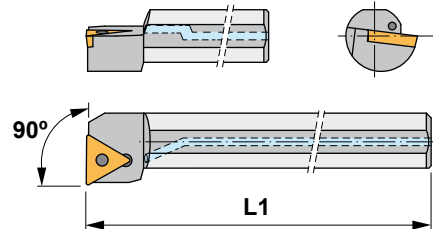

Eigenschaften:

Hartmetall-Bohrstange mit dreikantigen positiven Wendeschneidplatten.
Das Sortiment fängt ab Ø12 mm an, für eine 17 mm Mindestbohrung.

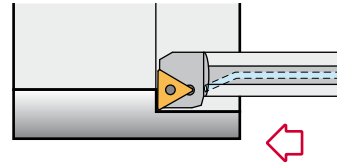

E-STFC 90°



Reference Bezeichnung	L1 Total length (mm) L1 Gesamtlänge (mm)	Ø min. (mm)	Insert size Wendeschneidplatte	
E12Q STFCL 11	180	17	TC.. 1102..	0,270
E12Q STFCR 11	180	17	TC.. 1102..	0,270
E16R STFCL 11	200	21	TC.. 1102..	0,510
E16R STFCR 11	200	21	TC.. 1102..	0,510
E20S STFCL 11	250	25	TC.. 1102..	1,000
E20S STFCR 11	250	25	TC.. 1102..	1,000

Reference Bezeichnung			Nm
E12Q STFCL 11	1225	5507	0.9
E12Q STFCR 11	1225	5507	0.9
E16R STFCL 11	1225	5507	0.9
E16R STFCR 11	1225	5507	0.9
E20S STFCL 11	1225	5507	0.9
E20S STFCR 11	1225	5507	0.9

TC.. Triangular positive inserts with 7° clearance. A44
Dreikantige positive Wendeschneidplatten mit 7° Freiwinkel.

Reference / Bez.	l	s	d
TC.. 1102..	11,00	2,38	6,35

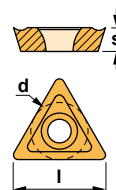

TCGT-AL



TCMT



TCMW





Characteristics:

Multipurpose boring bar equipped with triangular positive insert.
For boring bars with negative inserts see Ref. MTUN (Page: A183).

Axial 0°
Radial -4°

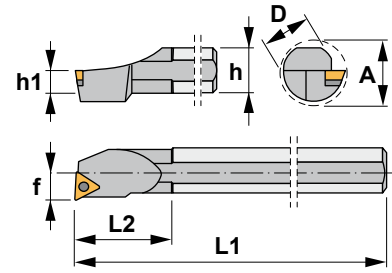

Eigenschaften:

Multifunktions-Bohrstange mit dreikantigen positiven Wendeschneidplatten.
Für Bohrstanen mit negativen Wendeschneidplatten siehe MTUN (Seite: A183).

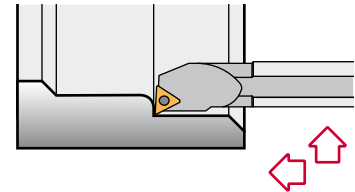

STUC 93°

Reference Bezeichnung	D	h	h1	L1	L2	f	A	Insert size Wendeschneidplatte	Kg
S12M STUC R/L 11	12	11	5,5	150	25	9	16	TC.. 1102..	0,150
S16R STUC R/L 16	16	15	7,5	200	30	11	20	TC.. 16T3..	0,300
S20S STUC R/L 16	20	18	9,0	250	35	13	24	TC.. 16T3..	0,550
S25T STUC R/L 16	25	23	11,5	300	40	17	31	TC.. 16T3..	0,700
S32U STUC R/L 16	32	30	15,0	350	45	22	39	TC.. 16T3..	2,050

Reference Bezeichnung					Nm
S12M STUC R/L 11	1225	5507	-	-	0.9
S16R STUC R/L 16	1240	5515	-	-	3.0
S20S STUC R/L 16	1240	5515	-	-	3.0
S25T STUC R/L 16	1240	5515	-	-	3.0
S32U STUC R/L 16	1335	5516	3414	1750	3.0

TC.. <small>Triangular positive inserts with 7° clearance. Dreikantige positive Wendeschneidplatten mit 7° Freiwinkel. A44</small>					
Reference / Bez.	l	s	d		
TC.. 1102..	11,00	2,38	6,35		
TC.. 16T3..	16,50	3,97	9,52		

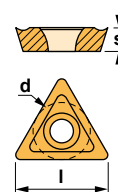



Characteristics:

Multipurpose profiling boring bar equipped with rhombic positive insert (angle 35°). For general applications, roughing, semi-finishing and finishing.

Axial 0°
Radial -6°

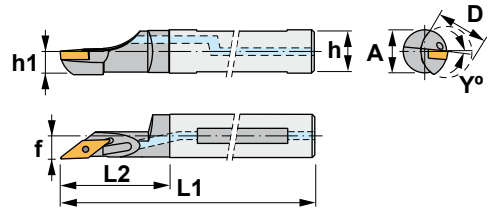

Eigenschaften:

Multifunktions-Bohrstange zum Profildrehen mit rhombischen positiven Wendeschneidplatten (35° Winkel).

Für allgemeine Anwendungen, Schruppen, Vorschlichten und Schlichten.

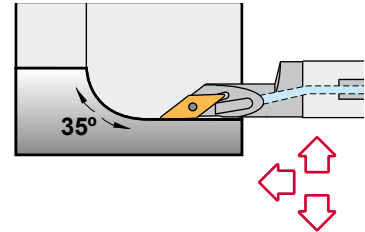

A-SVJC 93°

Reference Bezeichnung	D	h	h1	L1	L2	f	A	Y°	Insert size Wendeschneidplatte	kg
A16M SVJC R/L 11	16	15	7,5	150	30	2	22	22	VC.. 1103..	0,190
A20Q SVJC R/L 11	20	18	9,0	180	35	2	25	25	VC.. 1103..	0,350
A25R SVJC R/L 16	25	23	11,5	200	40	2	28	28	VC.. 1604..	0,590

Reference Bezeichnung			Nm
A16M SVJC R/L 11	1225	5507	0.9
A20Q SVJC R/L 11	1225	5507	0.9
A25R SVJC R/L 16	1240	5515	3.0

VC..

35° rhombic positive inserts with 7° clearance. A48
Rhombische positive WSP (35° Winkel) mit Freiwinkel 7°.

Reference / Bez.	l	s	d
VC.. 1103..	11,00	3,18	6,35
VC.. 1604..	16,50	4,76	9,52

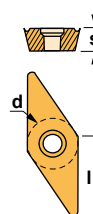

VC GT-AL



VC GT-AP



VC MT





Application of A-SVJC 93° Anwendung von A-SVJC 93°

Application range / Anwendungsbereich

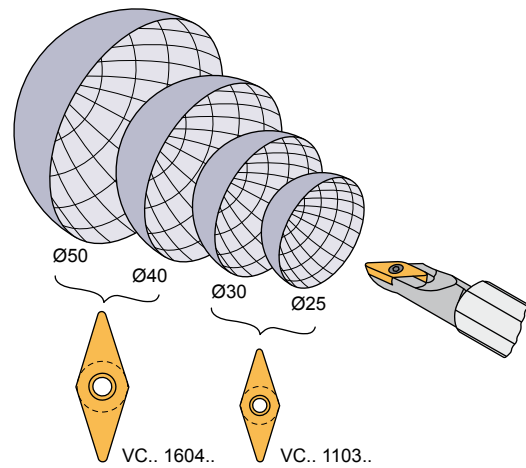
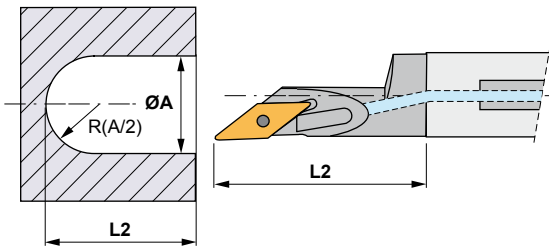

Machining method / Bearbeitungsmethode

Case with no existing hole / Ohne vorgebohrte Bohrung

Spherical machining Kugelförmige Bearbeitung

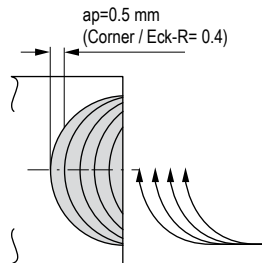

Internal facing Innen-Plandrehen

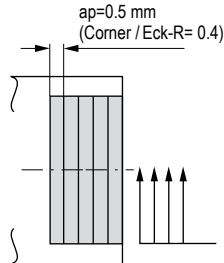

*Note: Feed rate shall be under 0.05 mm/rev at internal facing.
*Bemerkung: Vorschub muß bei Innen-Plandrehen unter 0.05 mm/U sein.

Finishing / Schlichten

Spherical machining Kugelförmige Bearbeitung

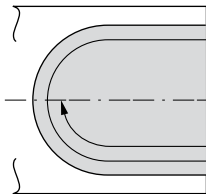

Internal facing Innen-Plandrehen

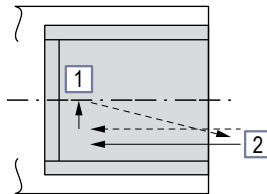

*Machining process / *Bearbeitungsvorgang
1 Finish the internal face first / Zuerst Bohrungsgrund schlichten.
2 Next, finish the internal diameter / Anschließend Bohrungsdurchmesser schlichten.

Case with drilled hole / Mit vorgebohrte Bohrung

Drilled hole / Vorgebohrte Bohrung

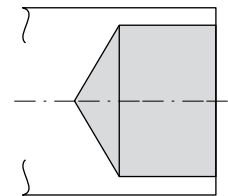

Spherical machining / Kugelförmige Bearbeitung

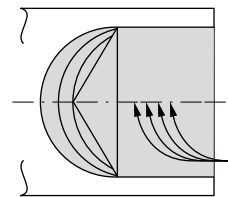

Internal facing / Innen-Plandrehen

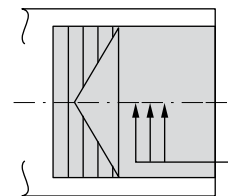

*Note: Feed rate shall be under 0.05 mm/rev at internal facing.
*Bemerkung: Vorschub muß bei Innen-Plandrehen unter 0.05 mm/U sein.

Caution / Vorsicht

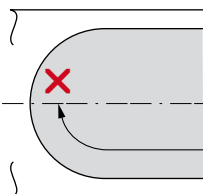

When machining past the center of the workpiece, insert breakage may occur.
Bei Bearbeitung über die Mitte des Werkstücks hinaus kann die Wendschneidplatte brechen.

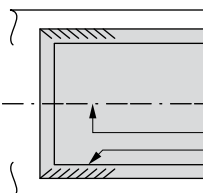

Machining of this kind is possible, but the oblique part may be scratched by chips.
Eine solche Bearbeitung ist zwar möglich, jedoch kann Spanschlag die Oberfläche aufrauen.

Poor finish
Schlechte Oberfläche

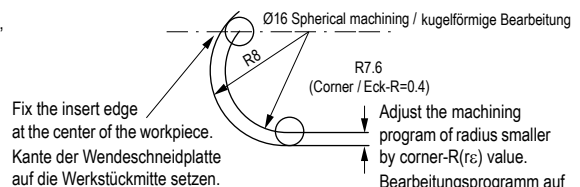

For internal profiling, a_p should be less than the value of corner- $R(r_c)$.
Zum Innenprofilieren sollte a_p kleiner sein als der Eckradius(r_c).





Characteristics:

Multipurpose profiling boring bar equipped with rhombic positive insert (angle 35°).

For general applications, roughing, semi-finishing and finishing.

Axial 0°
Radial -6°

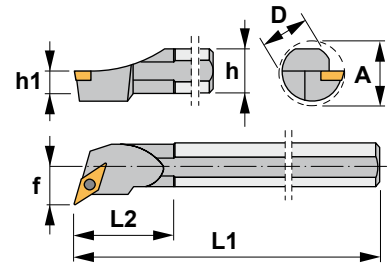

Eigenschaften:

Multifunktions-Bohrstange zum Profildrehen mit rhombischen positiven Wendeschneidplatten (35° Winkel).

Für allgemeine Anwendungen, Schruppen, Vorschlichten und Schlichten.

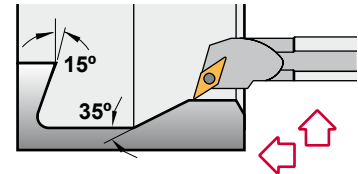

SVQC 107°30'

Reference Bezeichnung	D	h	h1	L1	L2	f	A	Insert size Wendeschneidplatte	kg
S16R SVQC R/L 11	16	15	7,5	200	30	11	20	VC.. 1103..	0,300
S20S SVQC R/L 11	20	18	9,0	250	35	13	24	VC.. 1103..	0,550
S16R SVQC R/L 13	16	15	7,5	200	30	13	22	VC.. 1303..	0,300
S20S SVQC R/L 13	20	18	9,0	250	35	13	24	VC.. 1303..	0,550
S25T SVQC R/L 16	25	23	11,5	300	40	17	31	VC.. 1604..	0,700

Reference Bezeichnung					Nm
S16R SVQC R/L 11	1225	5507	-	-	0.9
S20S SVQC R/L 11	1225	5507	-	-	0.9
S16R SVQC R/L 13	1230	5508	-	-	1.2
S20S SVQC R/L 13	1230	5508	-	-	1.2
S25T SVQC R/L 16	1335	5516	3718	1750	3.0

VC..

35° rhombic positive inserts with 7° clearance. A48
Rhombische positive WSP (35° Winkel) mit Freiwinkel 7°.

Reference / Bez.	l	s	d
VC.. 1103..	11,00	3,18	6,35
VC.. 1303..	13,00	3,18	7,94
VC.. 1604..	16,50	4,76	9,52

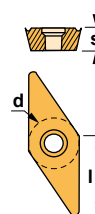

VCGT-AL



VCGT-AP



VCMT





Characteristics:
Multipurpose profiling boring bar equipped with rhombic positive insert (angle 35°).
For general applications, roughing, semi-finishing and finishing.

Axial 0°
Radial -6°

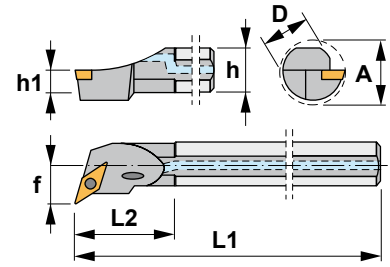

Eigenschaften:
Multifunktions-Bohrstange zum Profildrehen mit rhombischen positiven Wendeschneidplatten (35° Winkel).
Für allgemeine Anwendungen, Schruppen, Vorschlichten und Schlichten.

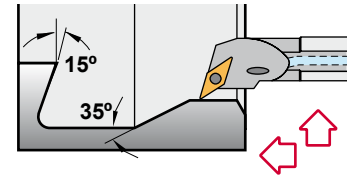

A-SVQC 107°30'

Reference Bezeichnung	D	h	h1	L1	L2	f	A	Insert size Wendeschneidplatte	
A16M SVQC R/L 11	16	15	7,5	150	30	11	20	VC.. 1103..	0,200
A20Q SVQC R/L 11	20	18	9,0	180	35	13	24	VC.. 1103..	0,400
A25R SVQC R/L 16	25	23	11,5	200	40	17	31	VC.. 1604..	0,700
A32S SVQC R/L 16	32	30	15,0	250	45	22	39	VC.. 1604..	1,400
A40T SVQC R/L 16	40	37	18,5	300	50	27	48	VC.. 1604..	2,650

Reference Bezeichnung					Nm
A16M SVQC R/L 11	1225	5507	-	-	0.9
A20Q SVQC R/L 11	1225	5507	-	-	0.9
A25R SVQC R/L 16	1335	5516	3718	1750	3.0
A32S SVQC R/L 16	1335	5516	3718	1750	3.0
A40T SVQC R/L 16	1335	5516	3718	1750	3.0

VC.. 35° rhombic positive inserts with 7° clearance. Rhombische positive WSP (35° Winkel) mit Freiwinkel 7°. A48

Reference / Bez.	l	s	d
VC.. 1103..	11,00	3,18	6,35
VC.. 1604..	16,50	4,76	9,52

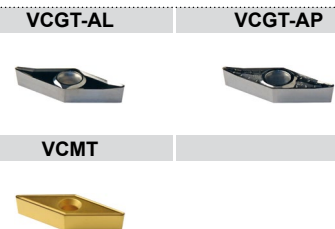
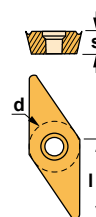

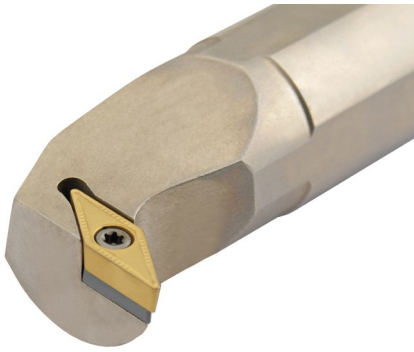

Characteristics:

Multipurpose profiling boring bar equipped with rhombic positive insert (angle 35°). For boring bars with negative inserts see Ref. MVUN-K (Page: A184).

Axial 0°
Radial -5°

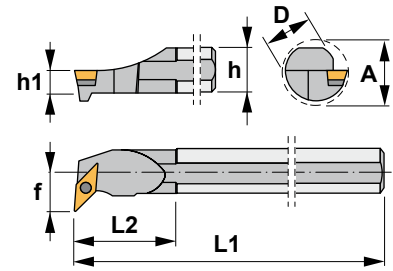

Eigenschaften:

Multifunktions-Bohrstange zum Profildrehen mit rhombischen positiven Wendeschneidplatten (35° Winkel). Für Bohrstan- gen mit negativen Wendeschneidplatten siehe MVUN-K (Seite: A184).

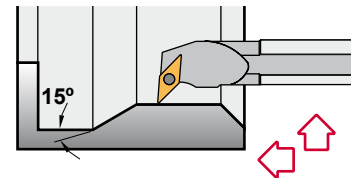

SVUB 93°

Reference Bezeichnung	D	h	h1	L1	L2	f	A	Insert size Wendeschneidplatte	kg
S25T SVUB R/L 16	25	23	11,5	300	40	17	31	VBMT 1604..	0,700
S32U SVUB R/L 16	32	30	15,0	350	45	22	39	VBMT 1604..	2,050
S40V SVUB R/L 16	40	37	18,5	400	50	27	48	VBMT 1604..	3,750

Reference Bezeichnung					Nm
S25T SVUB R/L 16	1335	5516	3718	1750	3.0
S32U SVUB R/L 16	1335	5516	3718	1750	3.0
S40V SVUB R/L 16	1335	5516	3718	1750	3.0

VBMT

35° rhombic positive insert with 5° clearance. A48
35° rhombische positive Wendeschneidplatte mit 5° Freiwinkel.

Reference / Bez.

VBMT 1604..

l

16,50

s

4,76

d

9,52

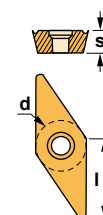

VBMT





Characteristics:

Multipurpose profiling boring bar equipped with rhombic positive insert (angle 35°). For boring bars with negative inserts see Ref. MVUN-K (Page: A184).

Axial 0°
Radial -5°

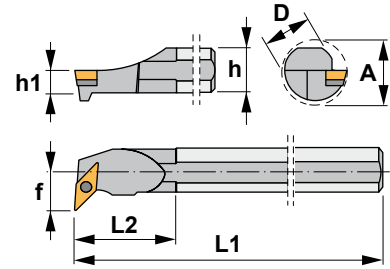

Eigenschaften:

Multifunktions-Bohrstange zum Profildrehen mit rhombischen positiven Wendeschneidplatten (35° Winkel). Für Bohrstan- gen mit negativen Wendeschneidplatten siehe MVUN-K (Seite: A184).

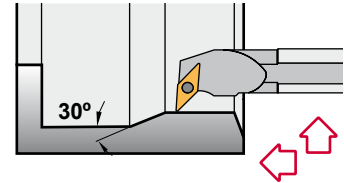

SVUC 93°

Reference Bezeichnung	D	h	h1	L1	L2	f	A	Insert size Wendeschneidplatte	kg
S16R SVUC R/L 11	16	15	7,5	200	30	11	20	VC.. 1103..	0,300
S20S SVUC R/L 11	20	18	9,0	250	35	13	24	VC.. 1103..	0,550
S25T SVUC R/L 16	25	23	11,5	300	40	17	31	VC.. 1604..	0,700
S32U SVUC R/L 16	32	30	15,0	350	45	22	39	VC.. 1604..	2,050
S40V SVUC R/L 16	40	37	18,5	400	50	27	48	VC.. 1604..	3,750

Reference Bezeichnung					Nm
S16R SVUC R/L 11	1225	5507	-	-	0.9
S20S SVUC R/L 11	1225	5507	-	-	0.9
S25T SVUC R/L 16	1335	5516	3718	1750	3.0
S32U SVUC R/L 16	1335	5516	3718	1750	3.0
S40V SVUC R/L 16	1335	5516	3718	1750	3.0

VC..

35° rhombic positive inserts with 7° clearance. A48
Rhombische positive WSP (35° Winkel) mit Freiwinkel 7°.

Reference / Bez.	l	s	d
VC.. 1103..	11,00	3,18	6,35
VC.. 1604..	16,50	4,76	9,52

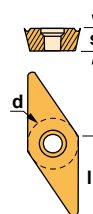

VCGT-AL



VCGT-AP



VCMT





Characteristics:

Multipurpose profiling boring bar equipped with rhombic positive insert (angle 35°). For boring bars with negative inserts see Ref. MVUN-K (Page: A184).

Axial 0°
Radial -5°

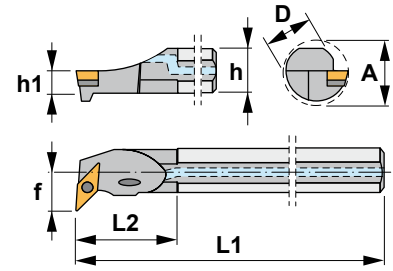

Eigenschaften:

Multifunktions-Bohrstange zum Profildrehen mit rhombischen positiven Wendeschneidplatten (35° Winkel). Für Bohrstanen mit negativen Wendeschneidplatten siehe MVUN-K (Seite: A184).

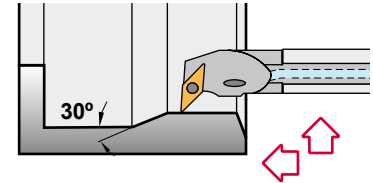

A-SVUC 93°

Reference Bezeichnung	D	h	h1	L1	L2	f	A	Insert size Wendeschneidplatte	kg
A16M SVUC R/L 11	16	15	7,5	150	30	11	20	VC.. 1103..	0,200
A20Q SVUC R/L 11	20	18	9,0	180	35	13	24	VC.. 1103..	0,400
A25R SVUC R/L 16	25	23	11,5	200	40	17	31	VC.. 1604..	0,700
A32S SVUC R/L 16	32	30	15,0	250	45	22	39	VC.. 1604..	1,400
A40T SVUC R/L 16	40	37	18,5	300	50	27	48	VC.. 1604..	2,650

Reference Bezeichnung					Nm
A16M SVUC R/L 11	1225	5507	-	-	0.9
A20Q SVUC R/L 11	1225	5507	-	-	0.9
A25R SVUC R/L 16	1335	5516	3718	1750	3.0
A32S SVUC R/L 16	1335	5516	3718	1750	3.0
A40T SVUC R/L 16	1335	5516	3718	1750	3.0

VC..

35° rhombic positive inserts with 7° clearance. A48
Rhombische positive WSP (35° Winkel) mit Freiwinkel 7°.

Reference / Bez.	l	s	d
VC.. 1103..	11,00	3,18	6,35
VC.. 1604..	16,50	4,76	9,52

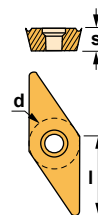

VCGT-AL



VCGT-AP



VCMT





Characteristics:
Anti-vibration shank with internal coolant.
Max. cutting depth: 7 x Diameter

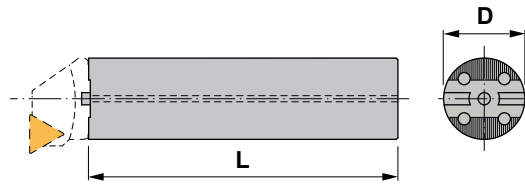

Eigenschaften:
Schwingungsgedämpfter Schaft mit Innenkühlung.
Maximale Schnitttiefe: 7 x Durchmesser



Reference Bezeichnung		D	L	Thread Gewinde	
J25/300	25	25	300	1/4 GAS	1,200
J32/350	32	32	350	3/8 GAS	2,200
J40/400	40	40	400	1/2 GAS	4,000
J50/550	50	50	550	1/2 GAS	8,500
J60/650	60	60	650	3/4 GAS	14,400
J80/1000	60	80	1000	3/4 GAS	39,500
J100/1200	60	100	1200	3/4 GAS	74,000

Reference Bezeichnung			Nm
J25/300	1924	5025	2.0
J32/350	1925	5003	3.0
J40/400	1926	5004	3.5
J50/550	1928	5005	4.0
J60/650	1928	5005	4.0
J80/1000	1928	5005	4.0
J100/1200	1928	5005	4.0

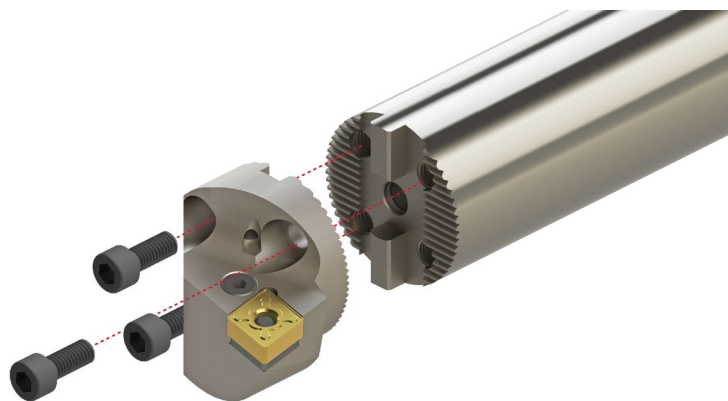

MTUN 93°-N 	PCLN 95°-N 	PDUN 93°-N 	PWLN 95°-N
SCLC 95°-N 	SDUC 93°-N 	STFC 90°-N 	SXFN 90°-N

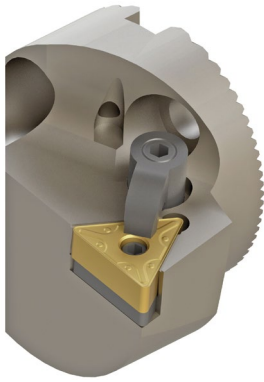

Characteristics:

Internal turning and profiling boring head equipped with triangular negative double-sided insert.

For general applications, roughing, semi-finishing and finishing.

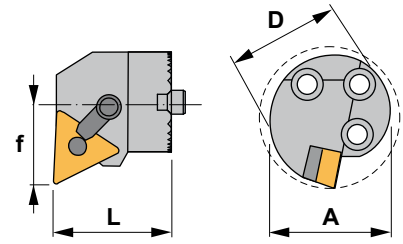

Eigenschaften:

Bohrkopf zum Innen- und Profildrehen mit doppelseitigen dreikantigen negativen Wendeschneidplatten.

Für allgemeine Anwendungen, Schruppen, Vorschlichten und Schlichten.

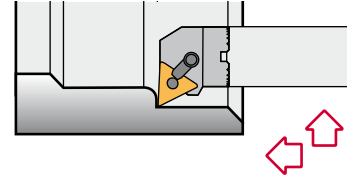

MTUN 93°-N

Reference Bezeichnung	D	L	f	A	Insert size Wendeschneidplatte	
A32X MTUN R/L 16-N	32	30	22	40	TNM.. 1604..	0,150
A40X MTUN R/L 16-N	40	30	27	50	TNM.. 1604..	0,300
A50X MTUN R/L 16-N	50	30	35	63	TNM.. 1604..	0,650
A50X MTUN R/L 22-N	50	40	35	63	TNM.. 2204..	0,650
A60X MTUN R/L 22-N	60	40	43	80	TNM.. 2204..	0,850

Reference Bezeichnung								Nm ¹	Nm ²	
A32X MTUN R/L 16-N	2613	-	5003	ITSN-322	1086	1665	-	5002	3.0	1.4
A40X MTUN R/L 16-N	2613	-	5003	ITSN-322	1086	1665	-	5002	3.0	1.4
A50X MTUN R/L 16-N	2613	-	5003	ITSN-322	1086	1665	-	5002	3.0	1.4
A50X MTUN R/L 22-N	-	2024	5005	ITSN-433	1394	-	1661	-	4.0	-
A60X MTUN R/L 22-N	-	2024	5005	ITSN-433	1394	-	1661	-	4.0	-

TNM..

Triangular negative inserts.
Dreikantige negative WSP.  A45-46

Reference / Bez.	l	s	d
TNM.. 1604..	16,50	4,76	9,52
TNM.. 2204..	22,00	4,76	12,70

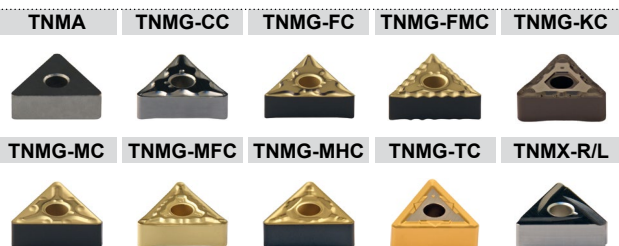
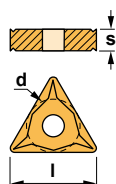

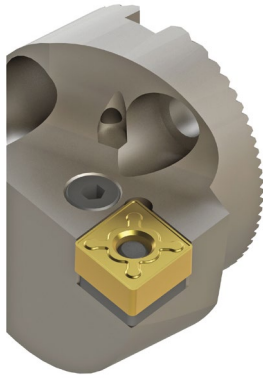

Characteristics:

Boring head for internal turning applications equipped with rhombic negative inserts (angle 80°). For low powered machines and small pieces choose boring bars Ref. A-SCLC (Page: A208).

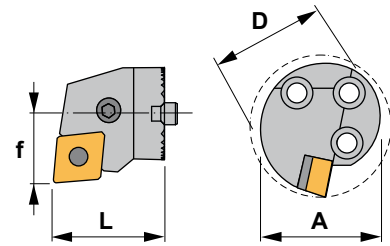

Eigenschaften:

Bohrkopf zum Innendrehen mit rhombischen negativen Wendeschneidplatten (80° Winkel).

Für Niederleistungsmaschinen und kleine Werkstücke, wählen Sie Bohrstan­gen A-SCLC (Seite: A208).

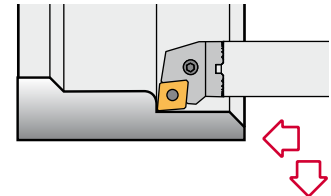

PCLN 95°-N

Reference Bezeichnung	D	L	f	A	Insert size Wendeschneidplatte	
A25X PCLN R/L 12-N	25	25	17	32	CN.. 1204..	0,050
A32X PCLN R/L 12-N	32	30	22	40	CN.. 1204..	0,150
A40X PCLN R/L 12-N	40	30	27	50	CN.. 1204..	0,300
A50X PCLN R/L 12-N	50	30	35	63	CN.. 1204..	0,600
A50X PCLN R/L 16-N	50	40	35	63	CN.. 1606..	0,600
A60X PCLN R/L 16-N	60	40	43	80	CN.. 1606..	0,800

Reference Bezeichnung							Nm
A25X PCLN R/L 12-N	8212	1626	5025	-	-	-	2.0
A32X PCLN R/L 12-N	8312	1648	5003	3612	4112	0012	3.0
A40X PCLN R/L 12-N	8012	1608	5003	3612	4112	0012	3.0
A50X PCLN R/L 12-N	8012	1608	5003	3612	4112	0012	3.0
A50X PCLN R/L 16-N	8016	1618	5003	3616	4115	0015	3.0
A60X PCLN R/L 16-N	8016	1618	5003	3616	4115	0015	3.0

CN..

80° rhombic negative inserts. A32-34
80° rhombische negative WSP.

Reference / Bez.	l	s	d
CN.. 1204..	12,90	4,76	12,70
CN.. 1606..	16,10	6,35	15,88

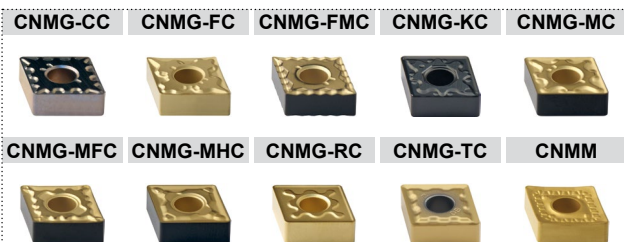
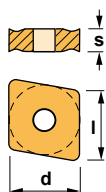



Characteristics:

Boring head for internal turning and profiling applications equipped with rhombic negative inserts (angle 55°). For low powered machines and small pieces choose boring bars Ref. A-SDUC (Page: A218).

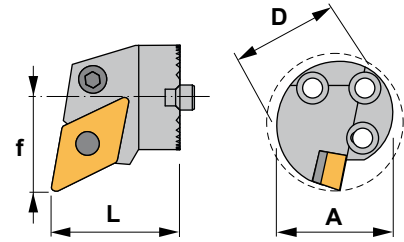

Eigenschaften:

Bohrkopf zum Innen- und Profildrehen mit rhombischen negativen Wendeschneidplatten (55° Winkel).

Für Niederleistungsmaschinen und kleine Werkstücke, wählen Sie Bohrstanen A-SDUC (Seite: A218).

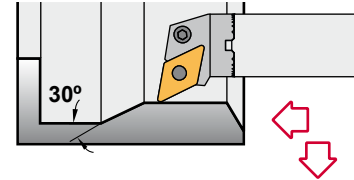

PDUN 93°-N

Reference Bezeichnung	D	L	f	A	Insert size Wendeschneidplatte	KG
A32X PDUN R/L 15-N	32	30	22	40	DN.. 1506..	0,150
A40X PDUN R/L 15-N	40	30	27	50	DN.. 1506..	0,300
A50X PDUN R/L 15-N	50	40	35	63	DN.. 1506..	0,600
A60X PDUN R/L 15-N	60	40	43	80	DN.. 1506..	0,800

Reference Bezeichnung								Nm
A32X PDUN R/L 15-N	8415	1648	5003	3715	4112	0012	3725 4135	3.0
A40X PDUN R/L 15-N	8415	1638	5003	3715	4112	0012	3725 4135	3.0
A50X PDUN R/L 15-N	8415	1638	5003	3715	4112	0012	3725 4135	3.0
A60X PDUN R/L 15-N	8415	1638	5003	3715	4112	0012	3725 4135	3.0

For DNM.. 1504.. inserts
Für Wendeschneidplatten DNM.. 1504..

DN.. 55° rhombic negative inserts. A36-37
55° rhombische negative Wendeschneidplatten.

Reference / Bez.	l	s	d
DN.. 1504..	15,50	4,76	12,70
DN.. 1506..	15,50	6,35	12,70

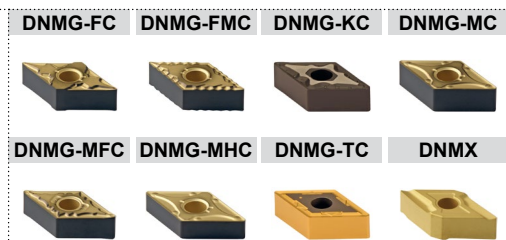
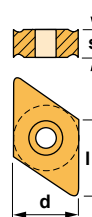



Characteristics:

Boring head for internal turning applications equipped with trigon negative inserts (angle 80°). For general applications, roughing, semi-finishing and finishing.

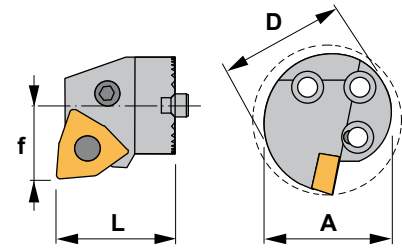

Eigenschaften:

Bohrkopf zum Innendrehen mit negativen Trigon Wendeschneidplatten (80° Winkel). Für allgemeine Anwendungen, Schrappen, Vorschlichten und Schlichten.

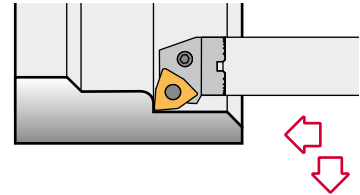

PWLN 95°-N

Reference Bezeichnung	D	L	f	A	Insert size Wendeschneidplatte	kg
A32X PWLN R/L 08-N	32	30	22	40	WNM.. 0804..	0,150
A40X PWLN R/L 08-N	40	30	27	50	WNM.. 0804..	0,300
A50X PWLN R/L 08-N	50	40	35	63	WNM.. 0804..	0,600
A60X PWLN R/L 08-N	60	40	43	80	WNM.. 0804..	0,800

Reference Bezeichnung							Nm
A32X PWLN R/L 08-N	8312	1648	5003	3008	4112	0012	3.0
A40X PWLN R/L 08-N	8012	1608	5003	3008	4112	0012	3.0
A50X PWLN R/L 08-N	8012	1608	5003	3008	4112	0012	3.0
A60X PWLN R/L 08-N	8012	1608	5003	3008	4112	0012	3.0

WNMG 80° trigon negative inserts. 80° trigon negative Wendeschneidplatten. A50-51

Reference / Bez.	l	s	d
WNMG 0804..	8,14	4,76	12,70

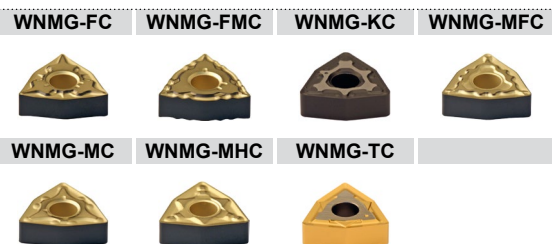
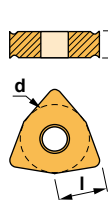

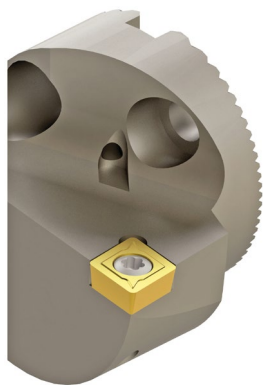

Characteristics:

Multipurpose boring head equipped with rhombic positive insert (angle 80°).

For boring bars with negative inserts see Ref. A-PCLN (Page: A189).

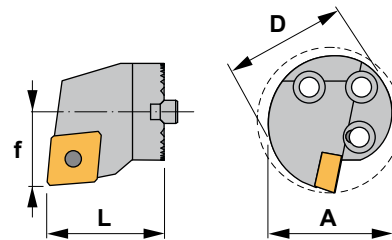

Eigenschaften:

Multifunktions-Bohrkopf mit rhombischen positiven Wendeschneidplatten (80° Winkel).

Für Bohrstangen mit negativen Wendeschneidplatten, siehe A-PCLN (Seite: A189).

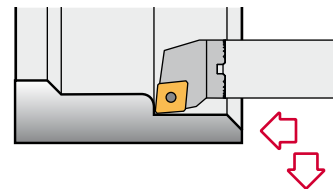

SCLC 95°-N

Reference Bezeichnung	D	L	f	A	Insert size Wendeschneidplatte	
A25X SCLC R/L 09-N	25	25	17	32	CC.. 09T3..	0,070
A32X SCLC R/L 12-N	32	30	22	40	CC.. 1204..	0,150
A40X SCLC R/L 12-N	40	30	27	50	CC.. 1204..	0,250
A50X SCLC R/L 12-N	50	40	35	63	CC.. 1204..	0,650
A60X SCLC R/L 12-N	60	40	43	80	CC.. 1204..	0,850

Reference Bezeichnung					Nm
A25X SCLC R/L 09-N	1440	5515	-	-	3.0
A32X SCLC R/L 12-N	1540	5517	3614	1760	3.0
A40X SCLC R/L 12-N	1540	5517	3614	1760	3.0
A50X SCLC R/L 12-N	1540	5517	3614	1760	3.0
A60X SCLC R/L 12-N	1540	5517	3614	1760	3.0

CC.. 80° rhombic positive inserts with 7° clearance. A30-31
80° rhombische positive Wendeschneidplatten mit 7° Freiwinkel.

Reference / Bez.	l	s	d
CC.. 09T3..	9,65	3,97	9,52
CC.. 1204..	12,90	4,76	12,70

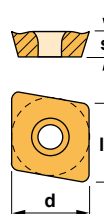

CCGT-AL **CCGT-AP**



CCMT

CCMW





Characteristics:

Multipurpose profiling boring head equipped with rhombic positive insert (angle 55°).

For boring bars with negative inserts see Ref. A-PDUN (Page: A191).

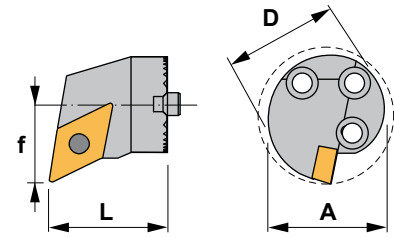

Eigenschaften:

Multifunktions-Bohrkopf zum Profildrehen mit rhombischen positiven Wendeschneidplatten (55° Winkel).

Für Bohrstangen mit negativen Wendeschneidplatten siehe A-PDUN (Seite: A191).

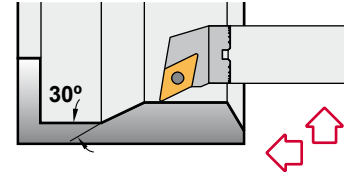

SDUC 93°-N

Reference Bezeichnung	D	L	f	A	Insert size Wendeschneidplatte	
A25X SDUC R/L 11-N	25	25	17	32	DC.. 11T3..	0,070
A32X SDUC R/L 11-N	32	30	22	40	DC.. 11T3..	0,150
A40X SDUC R/L 11-N	40	30	27	50	DC.. 11T3..	0,250
A50X SDUC R/L 11-N	50	40	35	63	DC.. 11T3..	0,650
A60X SDUC R/L 11-N	60	40	43	80	DC.. 11T3..	0,850

Reference Bezeichnung					Nm
A25X SDUC R/L 11-N	1240	5515	-	-	3.0
A32X SDUC R/L 11-N	1335	5516	3714	1750	3.0
A40X SDUC R/L 11-N	1335	5516	3714	1750	3.0
A50X SDUC R/L 11-N	1335	5516	3714	1750	3.0
A60X SDUC R/L 11-N	1335	5516	3714	1750	3.0

DC.. 55° rhombic positive inserts with 7° clearance. A35
55° rhombische positive Wendeschneidplatten mit 7° Freiwinkel.

Reference / Bez.	l	s	d
DC.. 11T3..	11,60	3,97	9,52

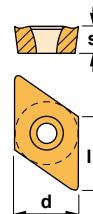

DCGT-AL 	DCGT-AP
DCMT 	DCMW



Characteristics:
Multipurpose boring head equipped with triangular positive insert.
For general applications, roughing, semi-finishing and finishing.

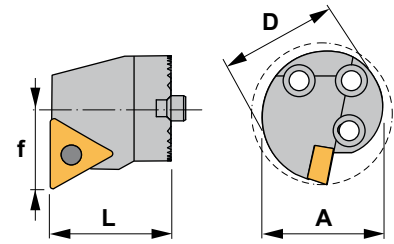

Eigenschaften:
Multifunktions-Bohrkopf mit dreikantigen positiven Wendeschneidplatten.
Für allgemeine Anwendungen, Schruppen, Vorschlichten und Schlichten.

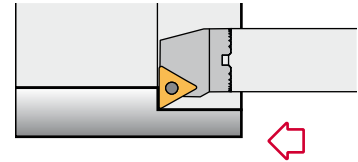

STFC 90°-N



Reference Bezeichnung	D	L	f	A	Insert size Wendeschneidplatte	Kg
A25X STFC R/L 16-N	25	25	17	32	TC.. 16T3..	0,070
A32X STFC R/L 16-N	32	30	22	40	TC.. 16T3..	0,150
A40X STFC R/L 16-N	40	30	27	50	TC.. 16T3..	0,250
A50X STFC R/L 16-N	50	40	35	63	TC.. 16T3..	0,650
A60X STFC R/L 16-N	60	40	43	80	TC.. 16T3..	0,850

Reference Bezeichnung					Nm
A25X STFC R/L 16-N	1240	5515	-	-	3.0
A32X STFC R/L 16-N	1335	5516	3414	1750	3.0
A40X STFC R/L 16-N	1335	5516	3414	1750	3.0
A50X STFC R/L 16-N	1335	5516	3414	1750	3.0
A60X STFC R/L 16-N	1335	5516	3414	1750	3.0

TC.. Triangular positive inserts with 7° clearance. A44
Dreikantige positive Wendeschneidplatten mit 7° Freiwinkel.

Reference / Bez.	l	s	d
TC.. 16T3..	16,50	3,97	9,52

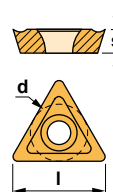

TCGT-AL



TCMT



TCMW

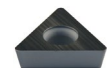

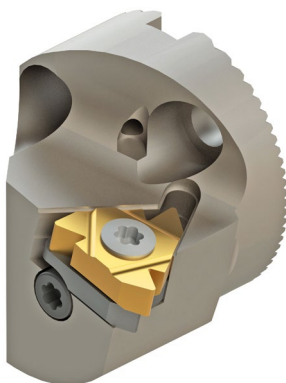

Characteristics:
Boring head for internal threading equipped with triangular negative insert.

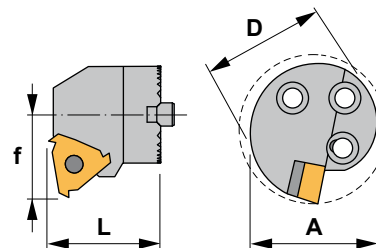

Eigenschaften:
Multifunktions-Bohrkopf zum Gewindedrehen mit dreikantigen negativen Wendschneidplatten.

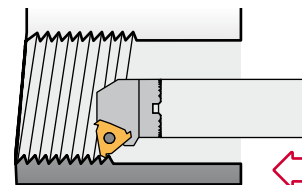

SXFN 90°-N

Reference Bezeichnung	D	L	f	A	Insert size Wendschneidplatte	Kg
A25X SXFN R/L 16-N	25	25	16,30	32	16 NR/L..	0,070
A32X SXFN R/L 16-N	32	30	19,60	40	16 NR/L..	0,150
A32X SXFN R/L 22-N	32	32	21,50	40	22 NR/L..	0,150
A40X SXFN R/L 22-N	40	32	25,80	50	22 NR/L..	0,250
A50X SXFN R/L 22-N	50	40	31,40	63	22 NR/L..	0,650
A60X SXFN R/L 22-N	60	40	36,40	80	22 NR/L..	0,850

Reference Bezeichnung						Nm
A25X SXFN R/L 16-N	SA3	5510	YE3	YI3	SY3	2.0
A32X SXFN R/L 16-N	SA3	5510	YE3	YI3	SY3	2.0
A32X SXFN R/L 22-N	SA4	5520	YE4	YI4	SY4	4.0
A40X SXFN R/L 22-N	SA4	5520	YE4	YI4	SY4	4.0
A50X SXFN R/L 22-N	SA4	5520	YE4	YI4	SY4	4.0
A60X SXFN R/L 22-N	SA4	5520	YE4	YI4	SY4	4.0

N R/L

Triangular negative inserts for internal threading.
Dreikantige negative WSP zum Innen-Gewindedrehen. C04, C06-07, C09-10

Reference / Bez.	l	d
16 NR/L..	16,00	9,52
22 NR/L..	22,00	12,70

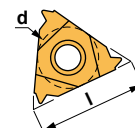

N R/L



N R/L TD





Characteristics:

Adaptor for anti-vibration shank with internal coolant.

To adapt the new boring heads to the old model of anti-vibration shanks.

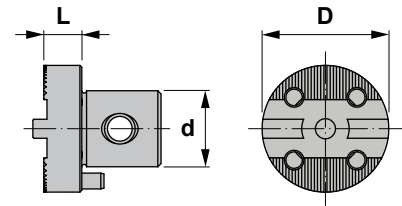



Eigenschaften:

Adapter für schwingungsgedämpfte Schäfte mit Innenkühlung.

Um die neue Bohrköpfe an das alte Modell der schwingungsgedämpften Schäfte zu montieren.

J..-A..  

Reference Bezeichnung	D	L	d	
J25-A25	25	10	15	0,060
J32-A32	32	10	20	0,100
J40-A40	40	12	24	0,180
J50-A50	54	16	28	0,350
J60-A60	60	16	28	0,460

Reference Bezeichnung			Nm
J25-A25	1924	5025	2.0
J32-A32	1925	5003	3.0
J40-A40	1926	5004	3.5
J50-A50	1928	5005	4.0
J60-A60	1928	5005	4.0

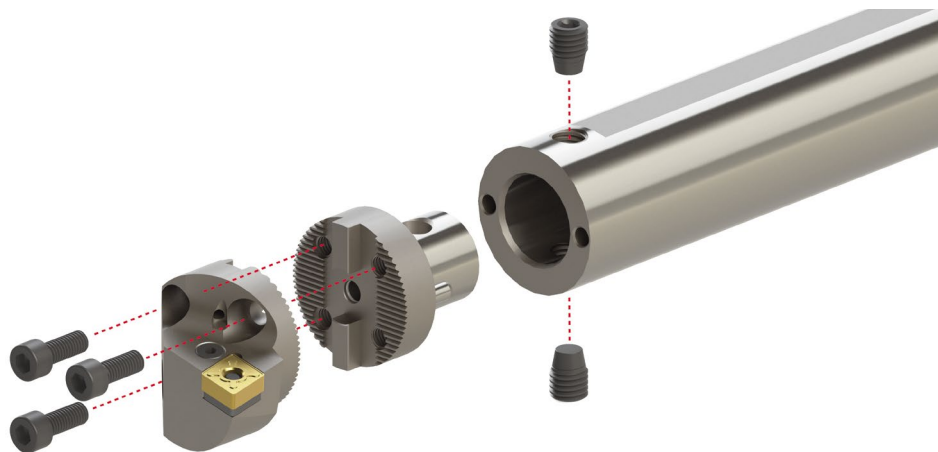

MTUN 93°-N 	PCLN 95°-N 	PDUN 93°-N 	PWLN 95°-N 
SCLC 95°-N 	SDUC 93°-N 	STFC 90°-N 	SXFN 90°-N 



Nominal cutting speed and feed values for boring bars

Material	P	HB	Condition	Cutting speed m/min.					Specific cutting force Kc 0,4	
				PM25	PM40	NC25	TN15	TN20		TN30
				0.3-0.6-1.2		0.1-0.3	0.1-0.4-0.8	0.1-0.4-0.8		0.2-0.5-1.2
Unalloyed steel	125	C=0.15%		150 115 80		350 280	480 345 250	440 300 205	330 230 110	1900
	150	C=0.35%		145 105 70		270 230	440 315 230	400 275 190	300 210 150	2100
	200	C=0.60%		115 90 65		240 190	385 275 200	350 240 165	260 185 130	2250
Low alloyed steel	180	Annealed		90 70 45		300 260	380 265 195	320 220 170	200 140 100	2100
	275	Hardened		65 45 30		220 140	260 180 130	215 150 115	140 100 70	2600
	300	Hardened		60 40 25		230 180	240 165 120	200 135 105	125 90 60	2700
	350	Hardened		50 35 20		220 140	210 145 105	170 120 90	110 75 55	2850
High alloyed steel	200	Annealed		80 60 45		200 160	350 230 170	280 185 135	175 115 80	2600
	325	Hardened		40 25 20		200 160	170 110	120 80 60	85 55 40	3900
Stainless steel	200	Martensitic / ferritic		110 95 75		270 130	295 240 190	275 210 165	225 180 145	2300
Steel castings	180	Unalloyed		60 50 35		300 260	260 185 145	230 160 120	135 105 75	2000
	200	Low alloyed		50 45 30		230 180	230 160 120	190 125 85	120 90 60	2500
	225	High alloyed		40 30 20		220 140	190 130 95	170 115 80	95 70 55	2700

Material	M	HB	Condition	Cutting speed m/min.						Specific cutting force Kc 0,4		
				PM25	NC25	TN15	TN20	TN30	TN35		TS15	TS20
				0.1-0.3	0.1-0.3	0.1-0.4-0.8		0.2-0.4-0.6	0.2-0.4-0.6		0.1-0.3	
Stainless steel annealed	180	Austenitic Ni > 8%, Cr 12-25% austenitic/ferritic, austenitic/ferritic, low S		240 200	180 150 120			190 160 130	190 160 130	240 200	120 180	2450
				160 130	180 150 120			190 160 100	190 160 130	160 130	130 220	
				160 130	180 150 120			140 110	160 130 100	160 130	120 180	

Material	K	HB	Condition	Cutting speed m/min.						Specific cutting force Kc 0,4
				KM15	NC25	TN15	TN20	TK15	ZR10	
				0.2-0.5-1.0	0.2-0.5	0.2-0.5-1.0		0.2-0.5-1.0	0.2-0.5-1.0	
Hardened steel	350	Hardened steel		27 16 10		175 145 100		180 150 110		4500
	250	Manganese steel 12%		65 40 16		120 85 50		120 90 60		3600
Malleable cast iron	130	Ferritic		105 75 45		225 150 90		250 180 100		1100
	230	Pearlitic		80 60 30		155 95 55		160 100 60		1100
Cast iron	180	Low tensile strength		135 95 60	300 200	165 110 70		180 120 80		1100
	260	High tensile strength		95 65 40	250 180	120 90 55		140 105 60		1500
Nodular SG iron	160	Ferritic		115 80 45	250 180			220 180 100		1100
	250	Pearlitic		80 50 30	180 120			150 100 50		1800
Chilled cast iron	400			17 11				17 11		3000

Material	N	HB	Condition	Cutting speed m/min.						Specific cutting force Kc 0,4
				KM15	TK15	NC25	TN15	TN20	ZR10	
				0.2-0.5-1.0	0.2-0.5-1.0	0.2-0.5	0.2-0.5-1.0		0.2-0.5-1.0	
Aluminium alloys	60	Non heat treatable		1750 1280 800					1750 1280 800	500
	100	Heat treatable		510 370 250					510 370 250	800
Aluminium alloys (cast)	75	Non heat treatable		460 285 175					460 285 175	750
	90	Heat treatable		300 180 110					300 180 110	900
Bronze-brass alloys	110	Lead alloys, Pb>1%		610 430 295					610 430 295	700
	90	Brass and bronze		310 250 195					310 250 195	750
	100	Inc. electrolytic copper		225 160 115					225 160 115	1750
Other materials		Hard plastics		380 240					380 240	
		Fibre		190 120					190 120	
		Hard rubber		225 160					225 160	

Material	S	HB	Condition	Cutting speed m/min.						Specific cutting force Kc 0,4
				KM15	NC25	TN15	TS15	TS20	ZR10	
				0.2-0.5-1.0	0.2-0.5	0.2-0.5-1.0			0.2-0.5-1.0	
Heat-resistant alloys		Fe-base						80 120		
		Nickel or cobalt base						60 100		
		Nickel or cobalt base						35 90		
		Nickel or cobalt base						30 50		
Titanium alloys		Titanium					70 120			

Nennschnittgeschwindigkeit und Vorschub-Werte für Bohrstangen

Materialien	P	HB	Beschaffenheit	Schnittgeschwindigkeit m/min.						Spezifische Schnittkraft Kc 0,4
				PM25	PM40	NC25	TN15	TN20	TN30	
				0.3-0.6-1.2		0.1-0.3	0.1-0.4-0.8	0.1-0.4-0.8	0.2-0.5-1.2	
Unlegierter Stahl	125 150 200	C=0.15% C=0.35% C=0.60%	150 115 80 145 105 70 115 90 65		350 280 270 230 240 190	480 345 250 440 315 230 385 275 200	440 300 205 400 275 190 350 240 165	330 230 110 300 210 150 260 185 130	1900 2100 2250	
Niedriglegierter Stahl	180 275 300 350	Geglüht Vergütet Vergütet Vergütet	90 70 45 65 45 30 60 40 25 50 35 20		300 260 220 140 230 180 220 140	380 265 195 260 180 130 240 165 120 210 145 105	320 220 170 215 150 115 200 135 105 170 120 90	200 140 100 140 100 70 125 90 60 110 75 55	2100 2600 2700 2850	
Hochlegierter Stahl	200 325	Geglüht Vergütet	80 60 45 40 25 20		200 160 200 160	350 230 170 170 110	280 185 135 120 80 60	175 115 80 85 55 40	2600 3900	
Rostfreier Stahl	200	Martensitisch/ Ferritisch	110 95 75		270 130	295 240 190	275 210 165	225 180 145	2300	
Stahlguß	180 200 225	Unlegiert Niedriglegiert Hochlegiert	60 50 35 50 45 30 40 30 20		300 260 230 180 220 140	260 185 145 230 160 120 190 130 95	230 160 120 190 125 85 170 115 80	135 105 75 120 90 60 95 70 55	2000 2500 2700	

Materialien	M	HB	Beschaffenheit	Schnittgeschwindigkeit m/min.						Spezifische Schnittkraft Kc 0,4		
				PM25	NC25	TN15	TN20	TN30	TN35		TS15	TS20
				0.1-0.3	0.1-0.3	0.1-0.4-0.8		0.2-0.4-0.6	0.2-0.4-0.6		0.1-0.3	
Rostfreier Stahl, geglüht	180	Austenitisch Ni > 8%, Cr 12-25% Austenitisch/ Ferritisch, Austenitisch/ Ferritisch, niedriger S-Anteil	240 200 160 130 160 130	180 150 120 180 150 120 180 150 120		190 160 130 190 160 130 140 110	190 160 130 190 160 130 160 130 100	240 200 160 130 160 130	120 180 130 220 120 180	2450		

Materialien	K	HB	Beschaffenheit	Schnittgeschwindigkeit m/min.						Spezifische Schnittkraft Kc 0,4
				KM15	NC25	TN15	TN20	TK15	ZR10	
				0.2-0.5-1.0	0.2-0.5	0.2-0.5-1.0		0.2-0.5-1.0	0.2-0.5-1.0	
Gehärteter Stahl	350 250	Vergüteter Stahl Mangan-Stahl 12%	27 16 10 65 40 16		175 145 100 120 85 50		180 150 110 120 90 60		4500 3600	
Temperguß	130 230	Ferritisch Perlitisch	105 75 45 80 60 30		225 150 90 155 95 55		250 180 100 160 100 60		1100 1100	
Guß	180 260	Niedrige Zugfestigkeit Hohe Zugfestigkeit	135 95 60 95 65 40	300 200 250 180	165 110 70 120 90 55		180 120 80 140 105 60		1100 1500	
SG-Kugelgraphitguß	160 250	Ferritisch Perlitisch	115 80 45 80 50 30	250 180 180 120			220 180 100 150 100 50		1100 1800	
Kaltverfestigender Guß	400		17 11				17 11		3000	

Materialien	N	HB	Beschaffenheit	Schnittgeschwindigkeit m/min.						Spezifische Schnittkraft Kc 0,4
				KM15	TK15	NC25	TN15	TN20	ZR10	
				0.2-0.5-1.0	0.2-0.5-1.0	0.2-0.5	0.2-0.5-1.0		0.2-0.5-1.0	
Aluminium-Legierungen	60 100	Nicht wärmebehandelbar Wärmebehandelbar	1750 1280 800 510 370 250					1750 1280 800 510 370 250	500 800	
Gegossene Aluminium-Legierungen	75 90	Nicht wärmebehandelbar Wärmebehandelbar	460 285 175 300 180 110					460 285 175 300 180 110	750 900	
Bronze- und Messinglegierungen	110 90 100	Bleilegierungen, Pb>1% Messing, Bronze Elektrolytkupfer	610 430 295 310 250 195 225 160 115					610 430 295 310 250 195 225 160 115	700 750 1750	
Andere Materialien		Hartkunststoff Faser Hartgummi	380 240 190 120 225 160					380 240 190 120 225 160		

Materialien	S	HB	Beschaffenheit	Schnittgeschwindigkeit m/min.						Spezifische Schnittkraft Kc 0,4
				KM15	NC25	TN15	TS15	TS20	ZR10	
				0.2-0.5-1.0	0.2-0.5	0.2-0.5-1.0			0.2-0.5-1.0	
Wärmefeste Legierungen			Fe-Basis Nickel- und Kobalthaltig Nickel- und Kobalthaltig Nickel- und Kobalthaltig					80 120 60 100 35 90 30 50		
Titan-Legierungen			Titan					70 120		