



Tools & 2024 equipment



Inhoudstabel - index

Inhoudstabel - index	2
Voorwoord / Préface	4
Symbolen - symboles	6
Gereedschapskoffers	8
coffrets d'outils	8
Notebook	14
Gereedschapswagens / servantes	24
Practical Series	26
Toebehoren - accessoires 10217-10218	28
Gereedschapswagen-servante Jumbo	30
Toebehoren - accessoires 10318	31
Toebehoren - accessoires	32
Service cart - station service	33
Werkbanken - etablis	34
Ladenkasten - Armoires de rangements	36
Indelingen - compartiment	37
Gevulde gereedschapswagen - servante d'atelier	38
Gevulde gereedschapswagen Maxi tower - servante d'atelier	43
Gevulde gereedschapswagen jumbo - servante d'atelier jumbo	44
Gevulde gereedschapswagen foam - servante d'atelier système mousse	45
Gevulde gereedschapswagen foam JUMBO - servante d'atelier	48
TC TRAYS	52
TC module systeem	55
TC TRAYS	55
TC module	55
Large module	55
TC TRAYS 1/4"	56
TC TRAYS 3/8"	57
TC TRAYS	58
TC TRAYS 1/2"	59
Slagdoppen - douilles à choc	61
TC Trays tangen - pinces	62
TC Trays sleutels - clés	63
TC Trays	66
TC Trays Large	68
fOAMS	72
mOUSSES	72
Foam system -mousse	74
Foam - mousse 10225-10217-10218-10517	75
Foam - mousse 10323 - 10318 Jumbo	87
Doppensets / Jeu de douilles	102
1/4"	104
Onderdelen - Accessoires 1/4"	112
Ratels - Cliquets 1/4"	114
Onderdelen - Accessoires 1/4"	115
Doppensets - Jeu de douilles 3/8"	116
Doppensets inch maten - Jeu de douilles 3/8" en pouce	120
Doppen 3/8" - douilles 3/8"	122
Toebehoren - Accessoires 3/8"	124
Ratels - cliquets 3/8"	125
Doppensets - Jeu de douilles 1/2"	126
Doppensets inch maten - Jeu de douilles 1/2"en pouce	131
Doppensets - Jeu de douilles 1/2"	132
Doppensets inbus - Jeu de douilles hex 1/2"	133
Doppensets torx - Jeu de douilles 1/2"	134
Doppensets - Jeu de douilles 1/2"	136
Doppensets XZN- Jeu de douilles 1/2" XZN	137
Doppen 1/2" - Douilles 1/2"	138
Doppen inch 1/2" - Douilles inch 1/2"	139
Doppen 1/2" - Douilles 1/2"	140
Onderdelen - Accessoires 1/2"	144
Ratels - cliquets 1/2"	146
Doppensets - Jeu de douilles 3/4"	147
Onderdelen - Accessoires 3/4"	148
Doppenset 1" - Jeu de douilles 1"	150
Onderdelen - Accessoires 1"	151
SlagDoppensets	152
douilles à choc	152
Slagdoppensets - Jeu de douilles à choc 1/2"	154
Slagdoppen - Douilles à choc 1/2"	156
Slagdoppensets - Jeu de douilles à choc 1/2"	157
Slagdoppen - Douilles à choc 1/2"	159
Adapters - Adaptateurs	160
Slagdoppensets - Jeu de douilles à choc 3/4"	161
Slagdoppen - Douilles à choc 3/4"	162
Slagdoppensets - Jeu de douilles à choc 3/4"	163
Slagdoppen - Douilles à choc 3/4"	164
Slagdoppen - Douilles à choc 1"	165
Slaggereedschap - Accessoires à choc	167
Gereedschapskoffer - Coffre d'outils	168

Sleutels / Clés	170
Steekringsleutels - Clés mixtes mm	172
Steekringsleutelsets - Jeu de clés mixtes	173
Steekringsleutels inch - clés mixtes en pouces	175
Steekringsleutels met ratel- Clés mixtes à cliquet	176
Steeksleutels - clés à fourches	178
Gebogen ringsleutels - clés polygonales	179
Ringsleutels - clés polygonales	180
Montagesleutels	182
Pijpsleutels - Clés à pipe	183
Open ringsleutelsets - Clés à tuyauter	184
Kniesleutels - clés à douilles articulée	185
Dopsleutels - douilles sur manches	186
Verstelbare sleutels - Clés à molette	188
Slagsleutels - clés à frapper	189
Momentsleutels - Clés dynamométrique	190
Haakse sleutels - Clés mâles	191
Inbussleutels - Jeu de clés mâles	193
Haakse torx sleutels - Clés mâles torx	195
Inbussleutels op handvat - Clés mâles	197
Torx - resistorx	199
Schroevendraaiers / Jeu de tournevis	202
Bitsen - Embouts 5/16"	211
Bitsets 1/4" - Jeu d'embouts	214
Bitsen - Embouts 1/4"	216
Bitsets 10 mm - jeu d'embouts	218
Bitsen - Embouts 10 mm	220
Tangen / Pincen	222
Tangen 1000 V - Pincen 1000v	225
Borgveertangen - Pincen circlips	226
Tangen - Pincen	227
Hamers / Marteaux	232
Beitels-doorslag - Burins	235
Hamer-beitels - Chasse goupilles	237
Hamers - marteaux	238
Snijgereedschap	240
Couper Mesurer	240
Tap- en kussenset - Tarrauds & filières	242
Snij-meetgereedschap - Couper-mesurer	244
Pijptangen - Clés serre-tube	249
Garage Equipment	250
Opritten - rampes	257
Vervangen filters - Huile	258
Olie - Huile	262
Ontsteking brandstof - allumage carburant	266
Blokkeergereedschap - outils de calage	269
Blokkeergereedschap - outils de calage BMW	271
Blokkeergereedschap - outils de calage	273
Blokkeergereedschap - outils de calage BMW	275
Diesel verstuivers - injecteurs diesel	277
Motor - moteur	279
Remmen - freins	285
Wielen - roues	291
Aandrijving - suspension & transmission	295
Trekkers - extracteurs	297
Carrosserie	303
Koevoeten	306
Magneten	307
Electriciteit / électricité	310
1000v	312
Tangen 1000v - Pincen	315
Tangen - Pincen	316
Electriciteit / Électricité	317
Led lampen - Lampes à LED	319
Boosters 12v / 12-24v	321
Pneumatic tools / Outillage pneumatique	322
Verfspuiten - Pistolets de peinture	324
Pneumatic tools	326
Handschoenen - gants	328
Bankschroeven - Etaux	329
Diversen / Divers	330
Kledij - vêtements	332
Display	333
Catalogi	337
Index	338

Garantie voorwaarden

Op alle gereedschappen is er 1 jaar garantie (of meer indien duidelijk vermeld) tegen fabricatie fouten. Op FORCE gereedschap **onbepaalde** garantie. Garanties die slijtage vertonen of ondeskundig gebruikt werden vallen **NIET** onder garantie.

Producten kunnen alleen geclaimd worden voor garantie bij het bedrijf waar u het artikel heeft gekocht.

Wanneer een product niet naar behoren werkt, neem dan contact op met Zasco. Download het retour- en garantieformulier en geef een zo breed mogelijke klachtschrijving en voeg dit samen met een aankoopfactuur toe aan de zending. Garantieaanvragen zonder klachtschrijving worden niet in behandeling genomen. Verstuur het formulier mee met het pakket. Vermeld duidelijk de afzender. De verzendkosten zijn voor rekening van de klant. Niet geaccepteerde garantieaanvragen ontheffen de koper niet van zijn betalingsverplichtingen.

Wij adviseren om het verzendbewijs van uw retourzending goed te bewaren: voor het terugsturen van goederen bent u zelf aansprakelijk.

Zasco verwierpt zich van het recht op garantie indien:

- Er veranderingen aan het product zijn aangebracht, waaronder reparaties zonder toestemming van de fabrikant
- foutief gebruik van het product
- roest, verbrand, omgevormd, geslepen, gelast
- opzet, onachtzaamheid of nalatigheid
- onvoldoende of gebrekkig onderhoud
- overbelasting
- Slijtage als normaal wordt beschouwd voor het betreffende product
- De houdbaarheidsdatum van het product verlopen is
- Niet kan worden aangetoond dat het product is gekocht bij Zasco

De beslissing van Zasco betreffende garantieclaims is bindend. Zasco is niet aansprakelijk voor vervolgschade welke optreedt door defecten van gereedschap of door verkeerd gebruik daarvan. Wanneer een garantieaanvraag wordt goedgekeurd, zal het product worden gerepareerd of ontvangt u een vervangend product indien het product niet te repareren is. De garantieaanvraag verplicht Zasco niet tot het crediteren van producten.

Garantietermijnen: De garantietermijn gaat in vanaf het moment dat de koper het product fysiek in bezit heeft.

Garanties

Il y a un an de garantie sur tous les outils. **Les outils FORCE sont garantis à vie.** Retours des demandes de garanties : les demandes de garanties doivent nous parvenir ou par le représentant ou par notre propre transport. Veuillez noter que nous refuserons tous les demandes de garanties contre remboursements d'un autre transporteur. Les produits ne peuvent être réclamés que sous garantie auprès de l'entreprise où vous avez acheté l'article. Si un produit ne fonctionne pas correctement, veuillez contacter Zasco. Téléchargez le formulaire de retour et de garantie et fournissez la description de plainte la plus large possible et ajoutez-la à l'expédition avec une facture d'achat. Les demandes de garantie sans description de plainte ne seront pas traitées. Envoyez le formulaire avec le paquet. Indiquez clairement l'expéditeur. Les frais d'expédition se font aux frais du client. Les demandes de garantie non acceptées ne soulagent pas l'acheteur de ses obligations de paiement. Nous vous conseillons de bien conserver le reçu d'expédition de votre envoi de retour : vous êtes responsable du retour des marchandises vous-même. Zasco décline le droit à la garantie si :

- Des modifications ont été apportées au produit, y compris des réparations sans l'autorisation du fabricant
- utilisation inappropriée du produit
- rouille, brûlage, transformation, ... affûté, soudé
- intention ou négligence
- entretien insuffisant ou défectueux
- surcharge
- L'usure est considérée comme normale pour le produit en question
- La date d'expiration du produit est expirée
- Il n'est pas impossible de démontrer que le produit a été acheté chez Zasco

La décision de Zasco sur les réclamations de garantie est exécutoire.

Zasco n'est pas responsable des dommages consécutifs causés par les défaillances d'outils ou leur utilisation abusive. Si une demande de garantie est approuvée, le produit sera réparé ou vous recevrez un produit de remplacement si le produit ne peut pas être réparé. La demande de garantie n'oblige pas Zasco à créditer des produits.

Périodes de garantie :

Force handgereedschap:

Kracht doppen, momentsleutels, slag gereedschap en verspanend gereedschap vallen niet onder garantie.

Luchtgereedschap: 24 maanden garantie

De garantie is geldig op productiefouten en defecten in het materiaal. Accessoires voor luchtgereedschap, zoals zaagblaadjes, vallen buiten garantie.

Force gereedschapswagens: 24 maanden garantie

De garantietermijn is van toepassing op de gereedschapswagen zonder inhoud. De inhoud valt onder de garantievoorwaarden van Force handgereedschap. Zasco behoudt het recht de garantie te verwerpen wanneer niet wordt voldaan aan bovenstaande voorwaarden

Algemene voorwaarden

PRIJZZETTING: Al onze prijzen in deze catalogus zijn bruto exclusief BTW. **Aangezien de prijzen vermeld in deze tarief onderhevig zijn aan schommelingen in kost van materiaal en andere, kunnen er steeds prijswijzigingen doorgevoerd worden. Gelieve ons vooraf te raadplegen.** De producten kunnen zonder voorafgaande mededeling aangepast of gewijzigd worden. De afbeeldingen zijn louter indicatief, de producten en kleuren kunnen afwijken van de in de catalogus vermelde afbeeldingen.

VERKOOPSVORWAARDEN: Alleen geldig voor leveringen binnen België.

TERUGNAMES: geleverde goederen worden slechts teruggenomen mits uitdrukkelijk akkoord door onze commerciële dienst én mits de goederen zich onbeschadigd en in de originele verpakking bevinden. Bij terugname van goederen wordt er steeds 10% afgetrokken op de aankoopprijs.

BETALINGSCONDIÏES: Onze facturen zijn betaalbaar contant , of op 30 dagen netto. De goederen blijven eigendom van Zasco tot alle betalingen volledig voldaan zijn aan Zasco.

LEVERINGSVOORWAARDEN: Behoudens onvoorziene omstandigheden worden de bestellingen verzendingsklaar gemaakt binnen de drie werkdagen na ontvangst. Of deze worden door onze chauffeur geleverd (mits een administratiekost van 10€ bij bestellingen/facturen onder de 100€)

Franco levering in België vanaf 500€ netto.

Bestellingen die per koerierdienst moeten worden verstuurd met een nettowaarde lager dan 500€ worden aangerekend volgens, de op dat moment geldende, vervoerstarieven van de transporteur.

La période de garantie commence à partir du moment où l'acheteur est physiquement propriétaire du produit.

Outils manuels de force

Les douilles à choc, les clés dynamométriques, les outils d'impact et les outils d'usinage ne sont pas couverts par la garantie.

Outils à air : garantie de 24 mois

La garantie est valide pour les défauts de fabrication et les défauts du matériau. Les accessoires pour outils à air, comme les lames de scie, ne sont pas couverts par la garantie.

Servantes à outils de force : garantie de 24 mois

La période de garantie s'applique au servantes sans contenu.

Le contenu est couvert par les conditions de garantie des outils à main Force.

Zasco se réserve le droit de rejeter la garantie si les conditions ci-dessus ne sont pas remplies.

Conditions de vente

REMISES ET PRIX: Tous les prix de ce catalogue s'entendent brut et hors TVA.

Etant donné que les prix repris dans le tarif dépendent des fluctuations du cours de US dollar, ils sont constamment susceptible d'être modifiés. Veuillez nous consulter à l'avance. Ses remises sont à convenir au cas par cas.

REPRISES: les marchandises livrées ne seront repris qu'après accord formel de la société et si les marchandises sont intact et dans l'emballage originale. Nous déduisons toujours 10 % pour les retours.

CONDITIONS DE PAIEMENT: Nos factures sont payables ou comptant ou à 30 jours net. La marchandise reste la propriété de Zasco en attendant le paiement.

CONDITIONS DE LIVRAISON: Après réception, les commandes sont prêtes pour enlèvement dans un délai de 3 jours, sans imprévu.

Les livraisons sont franco à partir de 500€ nette.

Pour les livraisons par notre représentant, d'une valeur nette inférieure à 100€ il y aura un frais de port de 10€

Les commandes à expédier par transporteur (p.e Fedex) , d'une valeur nette inférieure à 500€, seront facturées selon les tarifs du transporteur en ce moment.

Symbolen - symboles



6 kant - 6 pans



12 kant - 12 pans



Torx inwendig



XZN dop inwendig



plat



philips



pozidrive



hexagonales



hexagonales met kogelkop



Torx



Resistorx



XZN (12 tanden)



Ribe



inch



GEREEDSCHAPSKOFFERS

COFFRETS D'OUTILS





Gereedschapskoffers - coffrets d'outils

10



Gereedschapskoffers gevuld - coffrets d'outils remplie

15

FOR 50230

Gereedschapstas in stof (leeg)

- met metalen draaghandvat en schouderband

Caisse d'outils textile (vide)

- sangle pour transporter un niveau

Afm /dim	L 53.5cm	B 25.8cm	H 22.5cm
-----------------	----------	----------	----------



FOR 50234

Gereedschapskoffer ABS op wielen

- afsluitbaar met sleutel

Valise avec trolley

- fermeture avec clés
- chariot démontable

Totale Afm/dim	L 45cm	B 33cm	H 15cm
gewicht/poids	3.3kg		



FOR 50223S

Gereedschapskoffer metaal 3 laden

- zijdelingse handgrepen + handvat bovenaan
- 2 sluitingen
- 3 kogelgelagerde laden 100% uitschuifbaar

Coffret d'outils 3 tiroirs

- 3 tiroirs sur roulements à billes
- 2 poignées latérales en acier

Totale Afm/dim	L 55.5cm	B 24cm	H 28cm
gewicht/poids	12.5kg		
Hoogte laden			H 4.5cm

B/L cm	D/P cm	H/H cm
53,5	25,8	22,5



FOR 10523

- Gereedschapskoffer metaal 3 laden Glanslak
- zijdelingse handgrepen + handvat bovenaan
- 2 sluitingen
- 3 kogelgelagerde laden 100% uitschuifbaar
- Coffret d'outils 3 tiroirs
- 3 tiroirs sur roulements à billes
- 2 poignées latéraux en acier



Totale Afm/dim	L 53cm	B 22cm	H 28.5cm
gewicht/poids	10.6kg		
Hoogte laden			H 4cm



FOR 10526

- Gereedschapskoffer metaal 6 laden Glanslak
- zijdelingse handgrepen
- centrale vergrendeling met 2 sleutels
- 6 kogelgelagerde laden
- Coffret d'outils 3 tiroirs
- 6 tiroirs sur roulements à billes
- à verrouillage centralisée
- 2 poignées latéraux en acier

Totale Afm/dim	L 66.6cm	B 30.7cm	H 37.9cm
gewicht/poids	22kg		
Hoogte laden	3 x 5cm	1 x 7.5cm	

FOR 50223C 
FOR 50223R **Gereedschapskoffer 3 laden**

- 3 laden (12 TC modules 4 per lade)
- kogelgelagerd & centrale vergrendeling met 2 sleutels
- laden 100% uitschuifbaar
- anti blokkeersysteem 1 lade tegelijk open
- zijdelings dubbele handgrepen
- stapelbaar op gereedschapswagen 10217 & 10218
- alle laden voorzien van rubbermatten
- werkblad met dikke rubbermat

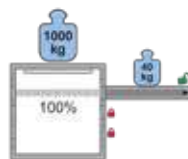

Coffre de servante d'atelier 3 tiroirs

- 3 tiroirs sur roulements à billes
- ouverture 100% des tiroirs
- à verrouillage centralisée
- système de blocage de tiroirs
- plan de travail en caoutchouc
- 2 poignée latéraux en acier

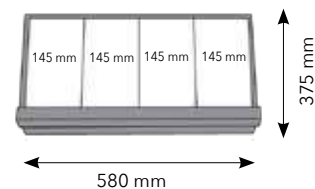

Afm/dim	L 70cm	B 47cm	H 34cm
Binnen maten laden/tiroirs	L 58cm	B 37.5cm	H 6cm
gewicht/poids	27.4kg		



FOR 10225C 
FOR 10225R 

Gereedschapskoffer 5 laden

- 5 laden (20 TC modules - 4 per lade)
- kogelgelagerd & centrale vergrendeling met 2 sleutels
- laden 100% uitschuifbaar
- anti blokkeersysteem 1 lade tegelijk open
- stapelbaar op gereedschapswagen 10217 & 10218
- zijdelingse handvaten
- alle laden voorzien van rubbermatten
- werkblad met rubbermat



Coffre de servante d'atelier 5 tiroirs

- glissières à roulements à billes
- verouillage à clé
- ouverture 100% des tiroirs
- système de blocage de tiroirs
- plan de travail en caoutchouc
- 2 poignée latéraux en acier

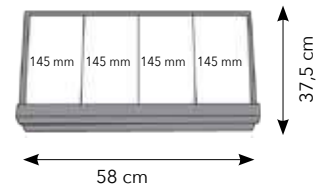

Afm/dim	L 69cm	B 46cm	H 49cm
Binnenmaten laden/tiroirs	L 58cm	B 37.5cm	H 6cm
gewicht/poids	38.7kg		



FOR 10323C 
FOR 10323R 

Gereedschapskoffer 3 laden voor Jumbo

- 3 laden (18 TC modules - 6 per lade)
- kogelgelagerd & centrale vergrendeling met 2 sleutels
- laden 100% uitschuifbaar
- anti blokkeersysteem 1 lade tegelijk open
- stapelbaar op gereedschapswagen 10318
- zijdelingse handvaten
- alle laden voorzien van rubbermatten
- werkblad met rubbermat

Coffre de servante d'atelier 3 tiroirs pour Jumbo

- glissières à roulements à billes
- fermeture centralisée avec 2 clés pliable
- système de blocage de tiroirs
- ouverture 100% des tiroirs
- plan de travail en caoutchouc
- 2 poignée latéraux en acier

JUMBO



Afm/dim	L 95cm	B 50cm	H 36cm
Binnenmaten laden/tiroirs	L 75cm	B 43.5cm	H 6cm
gewicht/poids	37.8kg		

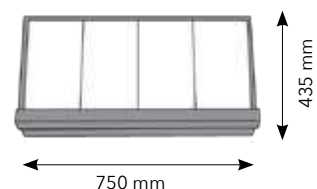

FOR 50235

Gereedschapskoffer metaal met 5 vakken

- groot opbergvolume
- afsluitbaar met hangslot
- electrostatisch gepoedercoated

Coffret d'outils à 5 compartiments

- fermeture par cadenas (non fourni)
- 5 compartiments

22.5cm



Afm/dim	L 53.5cm	B 28.5cm	H 22.5cm
gewicht/poids	8.2kg		

FOR TBC129

Gereedschapskoffer met 5 vakken

- groot opbergvolume
- afsluitbaar met hangslot

Coffret d'outils à 5 compartiments

- fermeture par cadenas (non fourni)
- 5 compartiments



Totale Afm/dim	L 55.5cm	B 20cm	H 20.9cm
gewicht/poids	3.8kg		

FOR 50352

Gereedschapswand 2 laden

- 2 laden
- centrale vergrendeling met 2 sleutels
- geleverd met 15 haken

Armoire à outils 2 tiroirs

- 2 tiroirs
- verouillage à clé



Afm/dim	L 65.50cm	B 28cm	H 81cm
gewicht/poids	34 kg		



Notebook

FOR 50231-33

Notebook bag 34 delig

Trousse de bord composition de 34 outils

Afm/dim	L 38.5cm	B 24cm	H 5cm
gewicht/poids	4kg		

611B160	universele tang, pince universelle 160 mm
612B160	kniptang, pince coupante 160 mm
613B250	waterpomptang, pince multiprise 250 mm
616B16	hamer, marteau 635gr
649200	verstelbare moersleutel, clé à molette 200 mm
7111	schroevendraaier, tournevis PH1 80 mm L
7112	schroevendraaier, tournevis PH2 100 mm L
71304	schroevendraaier, tournevis plat 4 mm 100 mm L
713055	schroevendraaier, tournevis plat 5.5 mm 125 mm L
713065	schroevendraaier, tournevis plat 6.5 mm 150 mm L
755 08...19	steekringsleutels, clés mixtes 8-10-11-12-13-14-17-19 mm
5072F	inbusset, jeu de clés allen 2.5-3-4-5-6-8-10 mm
5083F	torx set T9-T10-T15-T20-T25-T27-T30-T40
9U3001	staalborstel, brosse en acier



FOR 50235-88

Gereedschapskoffer gevuld 1000v

- gereedschap 88 delig
- metalen koffer

Coffret d'outils avec 88 pcs d'outils 1000v

- coffret en metal peinture en poudre
- coffret d'électricien et maintenance générale

Afm/dim	L 53,5cm	B 25,8cm	H 22,5cm
gewicht/poids	18.2kg		



FOR C5153

Steekringsleutels 15 stuks, clés mixtes 15 pcs

8-10-11-12-13-14-15-16-17-18-19-21-22-23-24 mm



FOR C4482

525.....	1/4" douilles 6p 4-4.5-5-5.5-6-7-8-9-10-11-12 mm
545...	1/2" doppen 10-11-12-13-14-15-16-17-18-19-21-22-24
8044050-8044150	verlengstuk, rallonges 50 mm & 150 mm
80521/80541	kniegewricht, cardan 1/4" + 1/2"
81225	magneet, aimant
81022	bit houder 1/4" x 1/4"
802223	ratel, cliquet 1/4"
8032115	wringstaaf, manche en T 1/4"
8143	schroevendraaier handvat, manche
80242	ratel, cliquet 1/2"
8034250	wringstaaf, manche en T 1/2"
21111	bitset 11 delig, boîte de 11 embouts



FOR C50412

6903180	kombinatietang, pince universelle 1000v 180 mm
6904160	bektang, pince à becs long 1000v 160 mm
6905160	kniptang, pince coupante 1000v 160 mm
6912160	striptang, pince à dénuder



FOR C20913

711N1	PH1 (80 mm L)
711N2	PH2 (100 mm L)
713N025	2.5 (75 mm L)
713N04	4 (100 mm L)
713N055	5.5 (125 mm L)
713N065	6.5 (150 mm L)
88403	voltage tester 80-250v AC
5096P8	meter 5m, mètre à ruban 5m
68601	led lampje, lumière



FOR C51220

616300	hamer, marteau 300 gr
616A400	nylon hamer, marteau nylon 400 gr
6907250	waterpomptang, pince multiprise 1000v 250 mm
614250	vise grip tang, pince grip 250 mm
649200C	moersleutel, clé à molette 200 mm
66302	mini hakzaag, scie mini
5055P3	zaagblad, lame
6982	schaar, ciseau de technicien 145 mm
5055P4	cuttermes, cutter à lame
60212150	beitel, burin 12 (150 mm L)
60219180	beitel, burin 19 (180 mm L)



FOR 50235-101

Gereedschapskoffer 5 delig gevuld met gereedschap 101 delig Caisse d'outils 101 pcs

- coffret metal peinture en poudre à 5 étages

Afm/dim	L 53,5 cm	B 25,8 cm	H 22,5 cm
gewicht/poids	18.23 kg		



FOR C5153

Steekringsleutels 15 stuks, clés mixtes 15 pcs

8-10-11-12-13-14-15-16-17-18-19-21-22-23-24 mm



FOR C5142

613B250	waterpomptang, pince multiprise 250 mm
610B200	lange bektang, pince à becs long 200 mm
611B175	universele tang, pince universelle 175 mm
612B175	kniptang, pince coupante 175 mm
5102	inbusset 1.27 tot 10 mm, clés allen



FOR C21114

7110-7111-7112	PH0-PH1-PH2
7111S-7112S	PH1 - PH2 (25 mm L)
71303 - 71304	3 mm - 4 mm
713055-713065	5.5 mm - 6.5 mm
713055S-713065S	5.5 mm - 6.5 mm (25 mm L)



FOR C4482

1/4" doppen 525.....	douilles 6p 4-4.5-5-5.5-6-7-8-9-10-11-12 mm
1/2" doppen 545...	douilles 10-11-12-13-14-15-16-17-18-19-21-22-24mm
8042050-8042150	1/4" verlengstuk, rallonges 50 mm & 150 mm
8044125-8044250	1/2" verlengstuk, rallonges 125mm & 250mm
80634	adapter 1/2"
80521/80541	kniegewricht, cardan 1/4" + 1/2"
81225	magneet, aimant
81022	bit houder 1/4" x 1/4", porte embout
802223	ratel, cliquet 1/4"
8032115	wringstaaf, manche en T 1/4"
8143	schroevendraaier handvat, manche
80242	ratel, cliquet 1/2"
21111	bitset 11 delig, boîte de 11 embouts



FOR C5136

5055P4	1 cuttermes, cutter à lame
5096P8	meter 5m, mètre à ruban
60215180Q	beitel, burin 15 (180 mm L)
604419Q/6045200Q	puntbeitel, burin pointeau 4 (190 mm L) 5 (200 mm L)
6046210Q	puntbeitel, burin pointeau 6 (210 mm L)
614250	vise grip tang, pince grip 250 mm
616300	hamer 300 gr, marteau
616400	rubber hamer 400 gr, marteau anti retour
649250A	moersleutel 250 mm, clé à molette
66302	mini hakzaag + reservezaagjes /scie



FOR 50235-187

Gereedschapskoffer 5 delig gevuld met gereedschap 187 delig Caisse d'outils 187 pcs en mousse

- coffret metal à 5 étages



Afm/dim	L 53,5 cm	B 25,8 cm	H 22,5 cm
gewicht/poids	21 kg		

525 04....13	1/4" douilles 6p 4-4.5-5-5.5-6-7-8-9-10-11-12-13 mm
52555 08..12	1/4" lange doppen- longues 8-10-12
bits op dop	1/4" PH.0-PH.1-PH.2-PH3-PZ1-PZ2
bits op dop plat	1/4" 4-5.5-6.5-7
inbus	1/4" 3-4-5-6-7-8-10mm
torx	1/4" T8-T10-T15-T20-T25-T27-T30
resistorx	1/4" T8H-T10H-T15H-T20H-T25H-T27H-T30H-T40H
8044050 - 8044100	verlengstuk, rallonges 50 mm & 100 mm
80521 - 80541	kniegewricht, cardan 1/4" + 1/2"
8143	1/4" spinner 150mmL, tournvis porte-embout
8032115	1/4" wringstaaf T 115mmL, manche en T
81022	Bit houder 1/4" x 1/4", porte embout
2331A	veiligheidsbitset 33dlg 1/4"
21013	vijf ster bitset 10dlg 1/4"
5457713...19	1/2" lange doppen, douilles longues 13-17-19mm
80228	ratel, cliquet 1/4"

545 10...32	1/2" 10-11-12-13-14-15-16-17-18-19-20-21-22-23-24-27-30-32
8044125 - 8044250	verlengstuk, rallonges 125 mm & 250 mm
80541	kniegewricht, cardan 1/2"
80634	adapter voor verlengstuk 3/8" x 1/2", adaptateur
807416 - 807420.6	1/2" bougiedop, douilles pour bougies 16mm-20.6mm
80248	1/2" ratel 72tanden, cliquet
34605540....55	1/2" torx doppen T40-T45-T50-T55

Steekringsleutels , clés mixtes	
	6-7-8-9-10-11-12-13-14-15-16-17-18-19mm
	5116LB inbus set 11dlg, 1.5mm-12mm

616300	hamer 300gr, marteau
610B200	lange bektang, pince à becs long 200 mm
611B175	universele tang, pince universelle 175 mm
612B175	kniptang, pince coupante 175 mm
68021	mes, cutter à lame
68601	LED lamp (360° draaibaar)

613B250	waterpomptang, pince multiprise
614250	vise grip 250mm, pince grip 250mm
649250	moersleutel 250mm, clé à molette 250mm
609ABC-609ASO	circlipstangen, pince circlips
616A400	hamer 400gr PU + nylon, marteau
60212150 - 6074185	beitel 150mmL 12 - center punt 185mmL4
50613	set doorslagen 6 dlg - chasse goupilles

7111 - 7113	PH1-PH3
7112M	PH2 hamer schroevendraaier
7111S - 7112S	PH1 - PH2 (25 mm L)
71303 - 71303S - 71304	3 mm - 3.5 mm - 4 mm
713055 - 71308	5.5 mm - 8mm
713065M	6.5 hamer schroevendraaier
713055S - 713065S	5.5 mm - 6.5 mm (25 mm L)

FOR 50230-95

Gereedschapstas met schouderriem gevuld met gereedschap
95 delig

Sac d'outils avec 95 pcs d'outils

Afm/dim	L 53,5 cm	B 25,8 cm	H 22,5 cm
gewicht/poids	10.8 kg		



610B160	lange bektang, pince à becs long 160 mm
612B160	kniptang, pince coupante 160 mm
611B160	universele tang, pince universelle 160 mm
5102	inbussleutelset, clés allen 1.27-10 mm
5055P4	cuttermes, cutter à lame
613200	waterpomptang, pince multiprise 200 mm
614175	vise grip tang, pince grip 175 mm
649200C	verstelbare moersleutel, clé à molette 200 mm
5096P803	meter 3m, mètre à ruban
75508.....24	steekringsleutel, clés mixtes 8 tot 24 mm
6982	schaar, ciseau de technicien
711N1	schroevendraaier, tournevis 1000v PH1
713N04	platte schroevendraaier, tournevis plat 4 mm 1000v
88407	tester, testeur
7111M	hamer schroevendraaier, tournevis à frappe PH1
7112M	hamer schroevendraaier, tournevis à frappe PH2

71308M	hamer schroevendraaier, tournevis à frapper 8 mm
713055M	hamer schroevendraaier, tournevis à frapper 5.5 mm
713065M	hamer schroevendraaier, tournevis à frapper 6.5 mm
71303	schroevendraaier, tournevis 3 mm
71304	schroevendraaier, tournevis 4 mm
7110	schroevendraaier, tournevis PH0
617F	3 in 1 magneet met spiegel, aimant avec miroir
2421F	doppenset, jeu de douilles 1/4" 42 delig
616A400	hamer, marteau 400 gr
616F032	bank hamer, marteau tête rivoir
6044190	doorslag, chasse goupilles 4 mm (190 mm L)
6074185	center punt, pointeau 4 (185 mm L)
60212150	beitel, burin 150 mm L
603150	kapbeitel, bedane 150 mm L
6063185	puntslag, burin pointeau 3 185 mm L
66301	hakzaag, scie

FOR 50234-107

Gereedschapskoffer ABS op wielen gevuld met gereedschap 107 delig
Valise porte-outils, poignée télescopique et chariot démontable avec 107 outils

Afm/dim	L 45 cm	B 33 cm	H 15 cm
gewicht/poids	12.9 kg		

6905160	kniptang, pince coupante 1000v 160 mm
6903160	kombinatietang, pince universelle 1000v 160 mm
6904160	lange bektang, pince à becs long 1000v 160 mm
6907250	waterpomptang, pince multiprise 1000v 250 mm
6912160	striptang, pince à dénuder 1000v
649250A	regelbare moersleutel, clé à molette 1000v 250 mm

614250	griptang, pince grip
5055P4	cuttermes, cutter à lame
5115	11 delig steekringsleutelset, clés mixtes 8-22 mm
5054	5 delig beitelset, jeu de burins
5102LB	10 delig inbussleutelset, jeu de clés mâle 1.27 tot 10 mm

711N1	PH1 1000v
711N2	PH2 1000v
713N03	3 mm 1000v
713N04	4 mm 1000v
713N055	5.5 mm 1000v
713N065	6.5 mm 1000v
7112AS	PH1 (25 mm)
713065AS	6.5 mm (25 mm)
7111	PH1
7112	PH2
7113	PH3
2125P1	tester, testeur

2421BF	doppenset, jeu de douilles 1/4" 42 delig
616300	hamer, marteau 300 gr
616400	rubber hamer, marteau anti retour
66302	mini hakzaag, scie
5096P8	meter 5m, mètre à ruban
2125P1	circuit tester, détecteur de tension
4106	1/2" doppelset op rail, jeu de douilles 10 tot 24 mm
80242	ratel, cliquet 1/2"
68604	dynamo lamp
5096P2	center punt, pointeau



FOR 50223S103

Gereedschapskoffer 3 laden gevuld met gereedschap 103 delig 12kant

- metalen koffer

Coffret d'outils 3 tiroirs 103 pcs 12 pans

- coffret métal

Afm/dim	L 55,5 cm	B 24 cm	H 28 cm
gewicht/poids	21.4 kg		

FOR F4721

1/4"-1/2" doppenassortiment 72 delig + bits, ass. douilles 72 pcs	
12k doppen 12 pans	1/4" 4-4.5-5-5.5-6-7-8-9-10-11-12-13 mm
lange doppen	1/4" 8-10-13 mm - 1/2" 17-19-21 mm
549 14...32 12 pans	1/2" 14-15-16-17-18-19-20-21-22-24-27-30-32 mm
80521 - 80541	kniegewricht, cardan universelle 1/4" - 1/2"
802215 - 80243	1/4" ratel, cliquet 1/2" ratel
8032115	1/4" wringstaaf, manche en T
8042050	1/4" verlengstuk, rallonge 50 mm
8044075 - 8044250	1/2" verlengstuk, rallonges 75 mm & 250 mm
81022	bit houder, porte embouts
81022M	magneet bit houder, porte embouts magnétique
8143	steekhecht, manche tournevis
8044125W	1/2" verlengstuk, rallonge 125 mm
80634	adapter voor verlengstuk, adaptateur pour rallonge



FOR F20914

Schroevendraaierset 9 delig, module de 9 tournevis	
7111	PH1
7112	PH2
7113	PH3
7112S	PH 2 (25 mm L)
71304	4 mm
713055	5.5 mm
713065	6.5 mm
71308	8 mm
713065S	6.5 mm (25 mm L)



FOR F51210FV

Flexibele ratelsleutelset 12 delig, module de 12 clés mixtes à cliquet flex	
757 08....19	8-9-10-11-12-13-14-15-16-17-18-19 mm



FOR F51012

Kombinatieset 10 delig, modules de combinaison 10 pcs	
60212150/603150	beitel, burin 12 mm (150 mm L) - kapbeitel 150 mm
6074185	center punt, pointeau 4 (185 mm L)
6043150	doorslag, chasse goupil. 3 mm(150 mm L)
6044190	4 mm (190 mm L)
613B250	waterpomptang, pince multiprise 250 mm
610B200	lange bektang, pince à becs long 200 mm
611B175	kombinatietang, pince universelles 175 mm
612B175	kniptang, pince coupante 175 mm
616200	hamer, marteau 200 gr



FOR 50223S116-5

Gereedschapskoffer 3 laden gevuld met gereedschap 116 delig 6kant

- metalen koffer

Coffret d'outils 3 tiroirs 116 pcs 6 pans

- coffret metal

Afm/dim	L 55,5 cm	B 24 cm	H 28 cm
gewicht/poids	21.4 kg		

FOR F4721 5

1/4"-1/2" doppenassortiment 72 delig + bits, ass. douilles 72 pcs	
525 04...13	1/4" 4-4.5-5-5.5-6-7-8-9-10-11-12-13 mm
lange doppen	1/4" 8-10-13 mm - 1/2" 17-19-21 mm
545 14...32	1/2" 14-15-16-17-18-19-20-21-22-24-27-30-32 mm
80521 - 80541	kniegewricht, cardan universeel 1/4" - 1/2"
802215 - 80243	1/4" ratel, cliquet 1/2" ratel
8032115	1/4" wringstaaf, manche en T
8042050	1/4" verlengstuk, rallonge 50 mm
8044075 - 8044250	1/2" verlengstuk, rallonges 75 mm & 250 mm
81022	bit houder, porte embouts
81022M	magneet bit houder, porte embouts magnétique
8143	steekhecht, manche tournevis
8044125W	1/2" verlengstuk, rallonge 125 mm
80634	adapter voor verlengstuk, adaptateur pour rallonge

FOR F20914

Schroevendraaierset 9 delig, module de 9 tournevis	
7111	PH1
7112	PH2
7113	PH3
7112S	PH 2 (25 mm L)
71304	4 mm
713055	5.5 mm
713065	6.5 mm
71308	8 mm
713065S	6.5 mm (25 mm L)



FOR F5252

Steekringsleutels + inbussleutels 25 delig, module 25 clés mixtes	
755 06...24	6-7-8-9-10-11-12-13-14-15-16-17-18-19-22-24 mm
5093LB	1.5-2-2.5-3-4-5-6-8-10 mm clés mâles

FOR F51012

Kombinatieset 10 delig, module de combinaison 10 pcs	
60212150 - 603150	beitel, burin 12 mm (150 mm L) - kapbeitel 150 mm
6074185	center punt, pointeau 4 (185 mm L)
6043150	doorslag, chasse goupil. 3 mm(150 mm L)
6044190	chasse goupil 4 mm (190 mm L)
613B250	waterpomptang, pince multiprise 250 mm
610B200	lange bektang, pince à becs long 200 mm
611B175	kombinatietang, pince universelles 175 mm
612B175	knijptang, pince coupante 175 mm
616200	hamer, marteau 200 gr



FOR 10225C247 
 FOR 10225R247 



**Gereedschapskoffer 5 laden
 gevuld met gereedschap 247 delig**

- 4 laden gevuld, 14 modules
- Coffret d'outils 5 tiroirs 247 pcs**
- 4 tiroirs avec outils, 14 modules

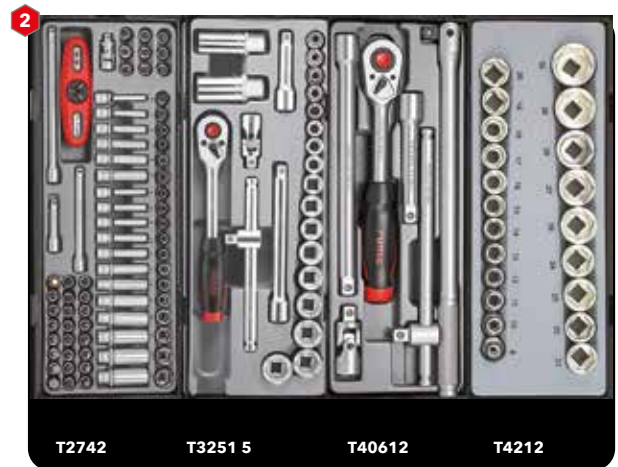
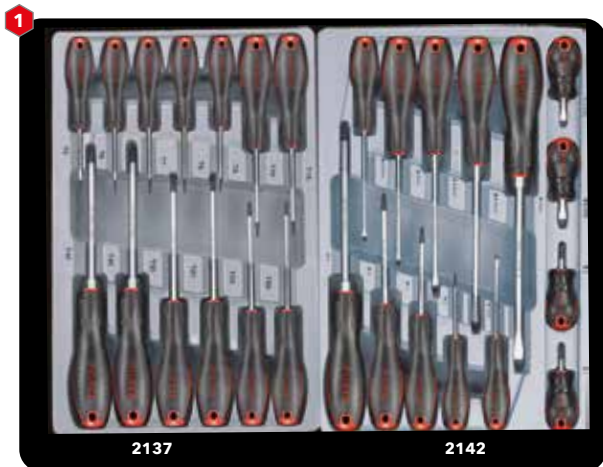

Afm/dim	L 69 cm	B 46 cm	H 49 cm
gewicht/poids	65.2 kg		



FOR 10225C181 
 FOR 10225R181 



**Gereedschapskoffer 5 laden
 gevuld met gereedschap 181 delig**

- 4 laden gevuld, 4 foams

Coffret d'outils 5 tiroirs 181 pcs

- 4 tiroirs avec outils, 4 mousse



Afm/dim	L 69 cm	B 46 cm	H 49 cm
gewicht/poids	65.2 kg		



FOR F2262 Schroevendraaierset 26 dlg - 26 tournevis



FOR F51217 tangenset 12 delig - jeu de pinces



FOR F41083 Assortiment 108 delig

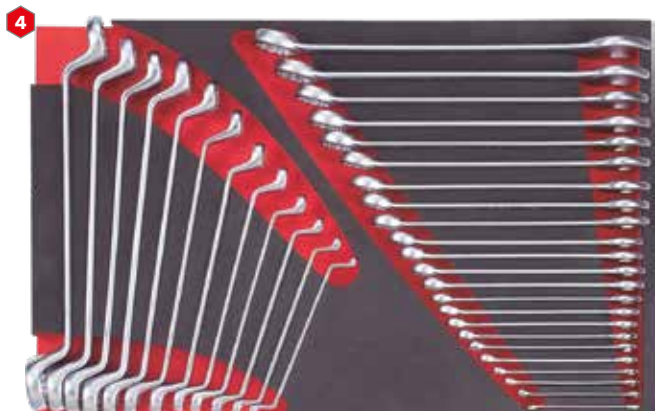

FOR F5351 Sleutelset 35 delig - jeu de clés

GEREEDSCHAPSWAGENS

SERVANTES



	Gereedschapswagens - servantes	26
	Accessoires gereedschapswagens -accessoires servantes	28
	Werkbank - établi	34
	Ladenkasten - armoires	36
	Gereedschapswagens gevuld met TC modules servantes avec outils	38
	Gereedschapswagens gevuld met foam modules servantes avec mousse	45





Practical Series

**Professionele gereedschapswagens van hoge kwaliteit**

- laden 100% uitschuifbaar
- kogelgelagerde geleiders
- ABS topblad met 2 ingebouwde handgrepen
- zijbakje voor spuitbussen
- stootranden op de 4 hoeken
- grote wieldiameter (130 mm) makkelijk verplaatsbaar
- 2 vaste wielen & 2 zwenkwielen met rem
- beveiliging tegen gelijktijdig openen van meerdere laden
- centrale vergrendeling met 2 plooibare sleutels
- rubber bescherming op alle ladenbodems
- draagkracht per lade 40kg, totale statische belasting van 600kg

Servantes Professionnelle

- système d'ouverture positionnée sur toute la longueur du tiroirs
- tiroirs s'ouvre 100%
- sur roulements à billes
- plan de travail en ABS avec 2 poignée intégrée
- support flacons
- pare chocs sur les 4 angles de la servante
- 4 roues extra larges (130 mm)
- verrouillage centrale avec 2 clés, serrure à clé articulée
- tiroirs avec système de blocage
- fonds des tiroirs protégés par un tapis en caoutchouc
- 4 modules par tiroir

FOR 10217R 
 FOR 10217C 
 FOR 10217A 
 FOR 10217B 



Gereedschapswagen 7 laden



- Afmeting laden : 58 cm x 37,5 cm
- 5 laden - 60 mm hoog
- 2 laden - 120 mm hoog
- 4 wielen 130 mm : 2 vaste en 2 zwenkwielen waarvan 2 met rem
- kleuren : rood, zwart, blauw, oranje
- geleverd met 1 spuitbushouder

Servante 7 tiroirs

- dimensions tiroirs : 58 cm x 37,5 cm
- tiroirs 6x60 mm + 2x120 mm
- 4 roues 130 mm : 2 pivotantes 2 avec freins
- couleurs : rouge, noir, bleu, orange
- 1 support flaçons

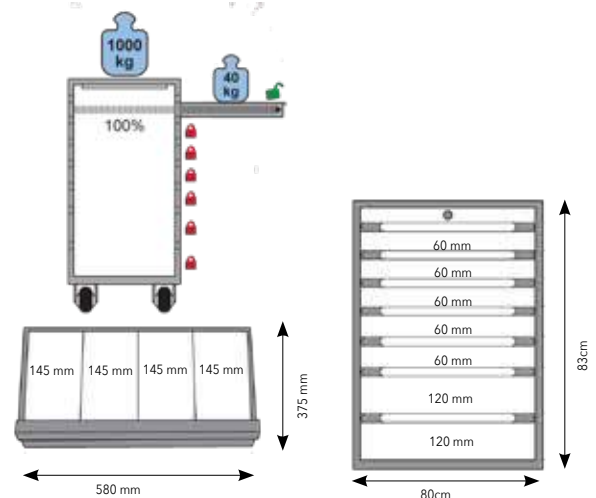
Afm/dim	L 80 cm	B 50 cm	H 103 cm
gewicht/poids	68.3 kg		totale hoogte hauteur totale



FOR 10218R 
 FOR 10218C 
 FOR 10218B 



Gereedschapswagen 8 laden

- Afmeting laden : 58 cm x 37,5 cm
- 7 laden - 60 mm hoog
- 1 lade - 120 mm hoog
- wielen 130 mm : 2 vaste en 2 zwenkwielen waarvan 2 met rem
- kleuren : rood, zwart, blauw
- geleverd met 1 spuitbushouder
- abs bovenblad

Servante 8 tiroirs

- dimensions tiroirs : 58 cm x 37,5 cm
- tiroirs 7x60 mm + 1x120 mm
- roues 130 mm : 2 pivotantes 2 avec freins
- couleurs : rouge, noir, blue
- 1 support flaçons

Afm/dim	L 80 cm	B 50 cm	H 103 cm
gewicht/poids	70 kg		totale hoogte hauteur totale

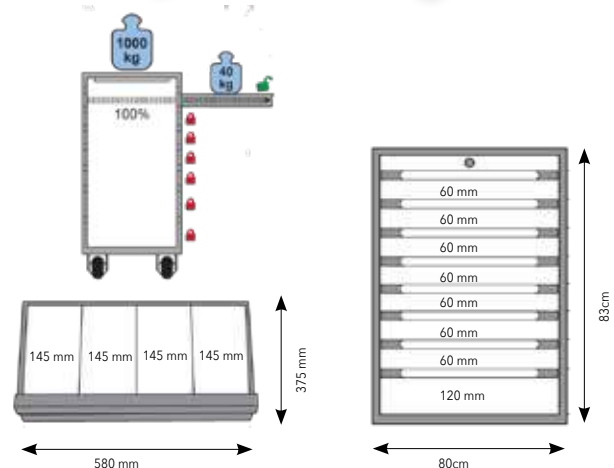

Toebehoren - accessoires 10217-10218

FOR 102104R/102104C

Zijtafel voor gereedschapswagen 10217-10218-10318
Table pour reception d'ordinateur portable



FOR 102105R/102105C

Papierrolhouder 10217-10218-10318
Porte papier



FOR 102102R/102102C

Flessenhouder aan de zijkant te bevestigen
Porte flacons latéral



FOR 102101R/102101C

Zijkast afsluitbaar met slot & 2 sleutels
Coffret latéral avec serrure



FOR 102106R/102106

Zijbakje voor spuitbussen
Support flacons (L43 x B9 x H12 cm)



FOR 102106B/102106A

Zijbakje voor spuitbussen
Support flacons (L43 x B9 x H12 cm)



102106B

102106A

FOR 102103

ABS bovenblad 10217-10218

- 2 ingebouwde handgrepen - 4 sorteerbakjes

Plan de travail ABS avec 2 poignée intégrée



FOR 102170CB

Wiel zwenkbaar met rem dia 125 mm
Roue avec frein pivotante

**FOR 102170C**

Wiel zonder rem dia 125 mm
Roue sans frein

**FOR 102170BBS E**

Ladegeleiders zie pag.
Jeu de glissières à billes (voir pag)

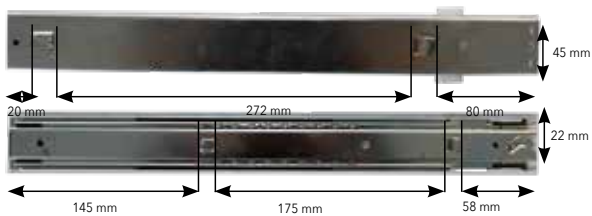
**FOR 102170LK**

Slot 2 sleutels (10225-10217-10218-10318)
Serrure + 2 clés (10225-10217-10218-10318)

**FOR 102170DS**

Lade small (L58cmxB38cmxH6cm)
Tiroir small

**FOR 102170DL**

Lade Large (L58cmxB38cmxH12cm)
Tiroir large

**FOR 10217 SL**

Sleutel (10225-10217-10218-10318)
clé (10225-10217-10218-10318)

- + nummer op slot vermelden
- + mentionner numéro de la clé



Gereedschapswagen-servante Jumbo

FOR 10318C 

FOR 10318R 

FOR 10318B 

Jumbo Gereedschapswagen 8 laden

- Afm/dim. laden : 75 cm x 43,5 cm
- 7 laden H 6cm 1 lade H 12cm
- wielen 130 mm : 2 vaste en 2 zwenkwielen waarvan 2 met rem
- kleur : zwart/rood/blauw
- bovenblad
- geleverd met 2 spuitbushouders regelbaar + zijhandvat
- 4 stootranden

Servante Jumbo 8 tiroirs

- tiroirs : 75 cm x 43,5 cm
- 7 tiroirs H 6cm 1 tiroir H12 cm
- roues 130 mm : 2 pivotantes 2 avec freins
- couleur : noir-rouge-blue
- 2 supports façons + poignée

Afm/dim	L 95 cm	B 50 cm	H 100 cm
gewicht/poids	97.7 kg		totale hoogte

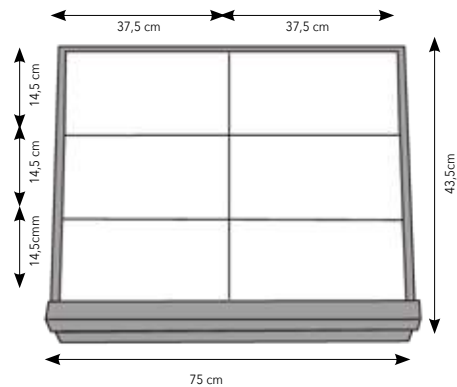

JUMBO

Toebehoren - accessoires 10318

FOR 103106

Zijbakje voor spuitbussen 10318 jumbo zwart
Support flacons 10318 Jumbo noir
(L47 x B9 x H12 Cm)



FOR 103106R

Zijbakje voor spuitbussen 10318 jumbo rood
Support flacons 10318 Jumbo rouge



FOR 103180CB

Wiel zwenkbaar met rem
Roue avec frein pivotante



FOR 103180C

Vast wiel zonder rem
Roue sans frein fixe



FOR 10318BBS

Ladegeleiders per paar (zie pag. 322)
Jeu de glissières à billes (voir pag 322)



FOR 102170LK

Slot 2 sleutels (10225-10217-10218-10318)
Serrure + 2 clés (10225-10217-10218-10318)



FOR 103180DS

Lade small (L75cmxB44cmxH6cm)
Tiroir small



FOR 103180DL

Lade Large (L75cmxB44cmxH12 mm)
Tiroir large



Toebehoren - accessoires

FOR 10210H1

Doppenhouder in metaal
Support pour douilles en metal



FOR 10210H2

Houder voor schroevendraaiers
Support pour tournevis



FOR 10210H3

Houder voor sleutels
Support pour clés



FOR 10210H4

Houder voor T sleutels
Support pour clés en T



FOR 82023S

Enkele haak 75 mm L
Crochet simple 75 mm L



FOR 82023D

Dubbele haak 75 mm L
Crochet double 75 mm L



FOR 82026S

Enkele haak 150 mm L
Crochet simple 150 mm L



FOR 82026U

Dubbele haak 150 mm L
Crochet double 150 mm L





FOR 10517

Gereedschapswagen 7 laden

- Afmeting laden : 580 mm x 375 mm
- 5 laden - 60 mm hoog
- 2 laden - 120 mm hoog
- 4 gelagerde wielen 130 mm : 2 vaste en 2 zwenkwielen waarvan 2 met rem
- met handvat
- electrostatisch gepoedercoat

Servante 7 tiroirs

- dimensions tiroirs : 580 mm x 375 mm
- tiroirs 5x60 mm + 2x120 mm
- 4 roues 130 mm : 2 pivotantes 2 avec freins
- poignée en metal
- peinture en poudre epoxy

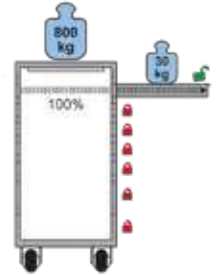

Afm/dim	L 69 cm	B 46.5 cm	H 98 cm
gewicht/poids	54 kg		totale hoogte

FOR 10517-180

180-delige Gevulde gereedschapswagen 7 laden

- 4 laden gevuld

Servante d'atelier 7 tiroirs avec outils 180 pcs



FOR F2412

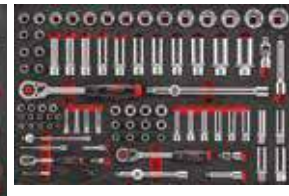

FOR F4882

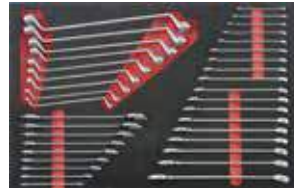

FOR F5363



FOR F5155

Service cart - station service

FOR 50212

Service wagen 2 laden

- Afmeting lades : 58 cm x 37,5 cm
- indeling van de laden hoogte 2x60 mm
- werkblad : 49 cm x 76 cm
- 4 wielen 100 mm : 2 vaste en 2 zwenkwielen waarvan 2 met rem
- handvat
- spuitbushouder
- afvalbakje
- gewicht 27.5kg

Service station 2 tiroirs

- dimensions tiroirs : 58 cm x 37,5 cm
- dimensions tiroirs hauteur 2x60 mm
- plateau : 49 cm x 76 cm
- 4 roues 100 mm : 2 pivotantes, 2 fixes
- poignée
- support flacons
- bac à déchets
- poids 27.5kg

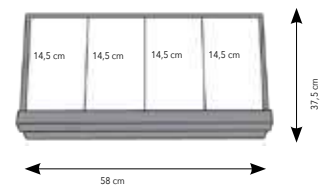

Werkbanken - etablis

FOR 50253

Werkbank met gereedschapswand en koffer

- Ladenkoffer 3 laden (FOR 50223)
- indeling van de laden : op kogellagers
- veiligheidsslot met 2 sleutels
- bodem van de laden met rubbermatten
- geleverd met 10 dubbele haken
- 10 enkele haken

Etabli avec coffret et panneau

- coffret 3 tiroirs
- verrouillage centrale à clé
- livré avec 20 crochets
- capacité 1000kg



FOR 50254

Werkbank met gereedschapswand en koffer

- gereedschapswand met mogelijkheid voor muurbevestiging, roldeur met veiligheidsslot
- Ladenkoffer 3 laden (50223)
- indeling van de laden : op kogellagers
- veiligheidsslot met 2 sleutels
- bodem van de laden met rubbermatten
- geleverd met 10 dubbele haken
- 10 enkele haken
- werkblad van multiplex hout met plastic laminaat
- laadcapaciteit 1000kg

Etabli complètement en métal avec coffret et porte-outils

- paroi porte outils
- coffret 3 tiroirs (50223)
- verrouillage à clé du volet
- livré avec 20 crochets
- plan de travail
- capacité 1000kg



FOR 5001

Werkbank

- geleverd zonder koffer

Etabli

- sans coffret



FOR 5003

Gereedschapswand

- gereedschapswand met mogelijkheid voor muurbevestiging, roldeur met veiligheidsslot met 2 sleutels
- geleverd met 10 dubbele haken
- 10 enkele haken
- 156cmL x 60.5cmB x 20cmD

Armoire

- paroi porte outils
- verrouillage à clé de volet
- livré avec 20 crochets



Ladenkasten - Armoires de rangements

Ladenkasten plaatstaal - Armoires de rangements

- centrale vergrendeling met 2 sleutels -fermeture centrale
- 100 kg per lade belastbaar/100 kg par tiroir
- 100% uitschuifbaar, tiroirs s'ouvre 100%
- kleur-couleur : grijs-gris (RAL7035)
- alu handgrepen - manches alu

TC XC90 5SG

- Ladenkast 5 laden
- Armoire 5 tiroirs

Afm/dim	B 72.3 cm	D 65.3 cm	H 100 cm
3 laden/tiroirs			H 20 cm
2 laden/tiroirs			H 15 cm
gewicht/poids	100 kg		



TC XC90 6SG

- Ladenkast 6 laden
- Armoire 6 tiroirs

Afm/dim	B 72.3 cm	D 65.3 cm	H 100 cm
3 laden/tiroirs			H 10 cm
2 laden/tiroirs			H 15 cm
1 lade/tiroir			H 20 cm
gewicht/poids	108 kg		

TC XC90 8SG

- Ladenkast 8 laden
- Armoire 8 tiroirs

Afm/dim	B 72.3 cm	D 65.3 cm	H 100 cm
2 laden/tiroirs			H 7.5 cm
4 laden/tiroirs			H 10 cm
1 lade/tiroir			H 15 cm
1 lade/tiroir			H 20 cm
gewicht/poids	118.10 kg		

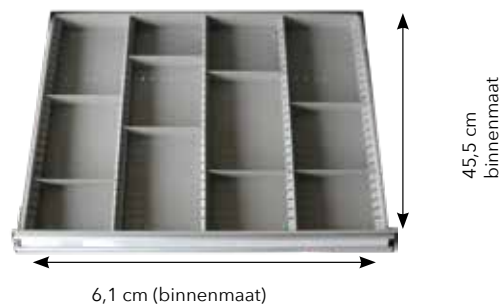

TC XC90 10SG

- Ladenkast 10 laden
- Armoire 10 tiroirs

Afm/dim	B 72.3 cm	D 65.3 cm	H 100 cm
4 laden/tiroirs			H 7.5cm
6 laden/tiroirs			H 10 cm
gewicht/poids	128.20 kg		



TC XCDKC

- Bovenblad frame
- Plan de travail

Indelingen - compartiment

PVC indelingen voor ladenkasten Bacs de rangement

Art. nr.	Afm/dim. mm	
TC XC SH11	150 x 150 x 28	roulementen
TC XC SH12	150 x 150 x 28	roulementen
TC XC SH13	150 x 150 x 28	met tusenschotjes
TC XC SH21	750 x 750 x 46	bakje, bacs
TC XC SH22	150 x 75 x 46	bakje, bacs
TC XC SH23	150 x 150 x 46	bakje, bacs



Universele lade indeling van alle kasten Présentation des tiroirs

Lade 1

- SH11 6 stuks
- SH12 3 stuks
- SH13 3 stuks

Tiroir 1

- SH11 6 pièces
- SH12 3 pièces
- SH13 3 pièces



Lade 2

- SH21 16 stuks
- SH22 8 stuks
- SH23 4 stuks

Tiroir 2

- SH21 16 pièces
- SH22 8 pièces
- SH23 4 pièces



Andere lades

- metalen indelingen



Autres tiroirs

- rangements en métal

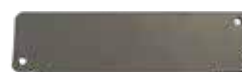
Art. nr.	Afm/dim. mm		
TC XC75	450Lx46H	3st	75 mmH
TC XC75PL	154Lx43H	8st	75 mmH
TC XC100	450Lx71hH	3st	100 mmH
TC XC100PL	154Lx65H	8st	100 mmH
TC XC 150	450Lx121H	3st	150 mmH
TC XC 150PL	154lx115H	8st	150 mmH
TC XC 200	450Lx171H	3st	200 mmH
TC XC200PL	154Lx165H	8st	200 mmH



Gevulde gereedschapswagen - servante d'atelier

FOR 10217C219 
 FOR 10217R219 

219-delige Gevulde gereedschapswagen 7 laden

- 3 laden gevuld 12 modules
- gewicht : 87.3kg

Servante d'atelier 7 tiroirs avec outils 219 pcs

- 12 modules pour 3 tiroirs
- poids : 87.3 kg



FOR 10217R219



FOR 10217C219

FOR VUL 219



Assortiment gereedschap 219 delig

- 3 laden 12 modules

Assortiment d'outils 219 pcs

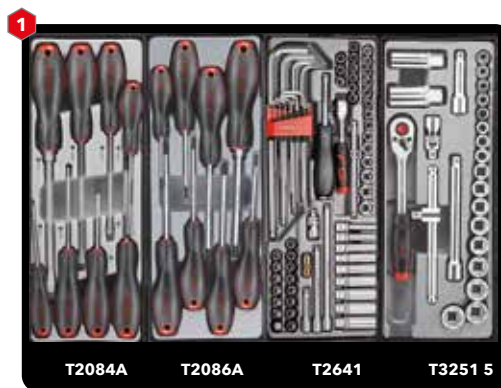
- 12 modules pour 3 tiroirs



FOR 10217C245 
 FOR 10217R245 

245-delige Gevulde gereedschapswagen 7 laden

- 4 laden gevuld 15 modules
- gewicht :100kg

Servante d'atelier 7 tiroirs avec 245 pcs d'outils

- 15 modules pour 4 tiroirs
- poids - 100kg



FOR VUL 245

Assortiment gereedschap 245 delig

- 4 laden - 15 modules

Assortiment d'outils 245 pcs

- 15 modules pour 4 tiroirs

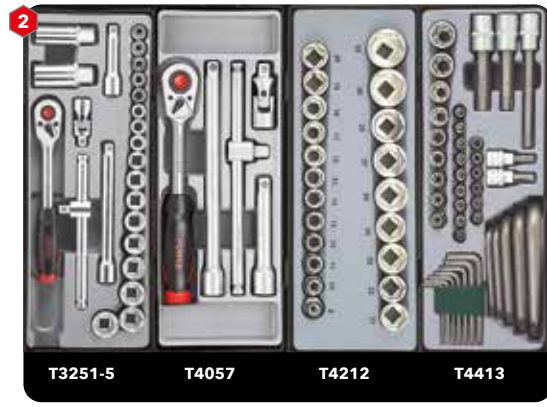
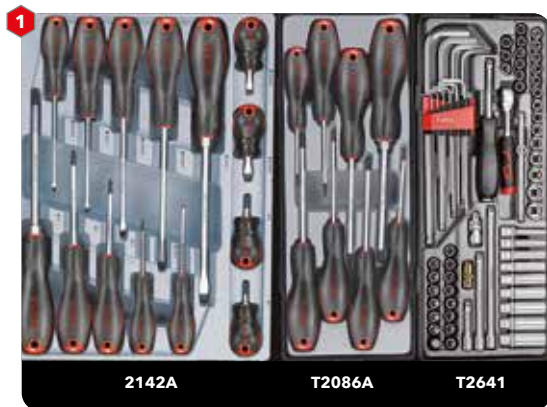

- FOR 10217C286 ■
- FOR 10217R286 ■
- FOR 10217A286 ■
- FOR 10217B286 ■

286-delige Gereedschapswagen 7 laden

- 6 laden gevuld 22 modules
- gewicht :105kg

Servante mobile d'atelier 7 tiroirs avec 286 pcs d'outils

- 22 modules pour 6 tiroirs poids : 105 kg

FOR VUL 286





Assortiment gereedschap 286 delig

- 6 laden - 22 modules

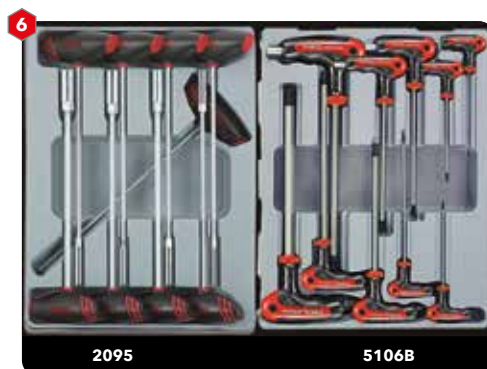
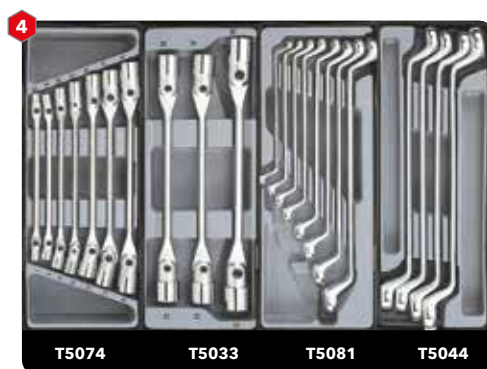
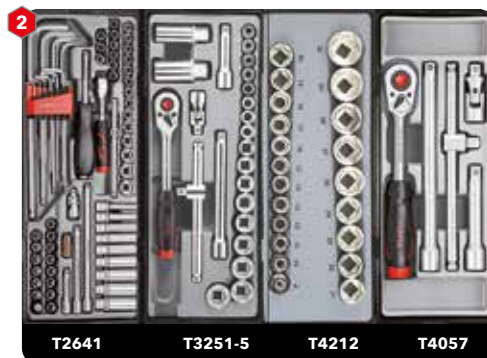
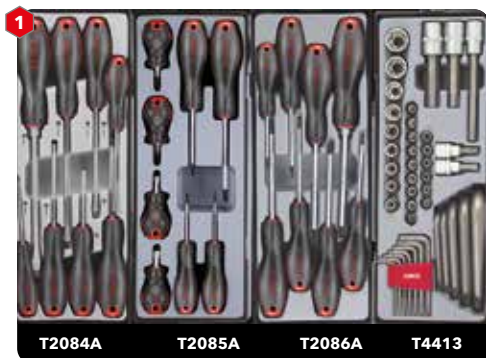
Assortiment d'outils 286 pcs

- 22 modules pour 6 tiroirs



- FOR 10217C306 
- FOR 10217R306 
- FOR 10217A306 
- FOR 10217B306 

306-delige Gereedschapswagen 7 laden

- 6 laden gevuld 22 modules
- gewicht : 106.7 kg

Servante mobile d'atelier 7 tiroirs avec 306 pcs d'outils

- 22 modules pour 6 tiroirs
- poids 106.7 kg

FOR VUL 306



Assortiment gereedschap 306 delig

- 6 laden - 22 modules

Assortiment d'outils 306 pcs

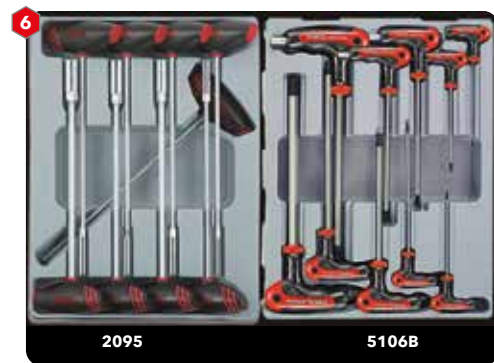
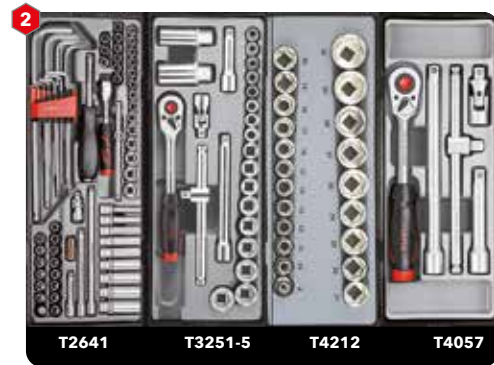
- 22 modules pour 6 tiroirs



FOR 10217C361 
 FOR 10217R361 

361-delige Gereedschapswagen 7 laden

- 6 laden gevuld 24 modules
- gewicht : 107.3 kg

Servante mobile d'atelier 7 tiroirs avec 361 pcs d'outils

- 24 modules pour 6 tiroirs
- poids : 107.3 kg



FOR VUL 361



Assortiment gereedschap 361 delig

- 6 laden gevuld - 20 modules

Assortiment d'outils 361 pcs

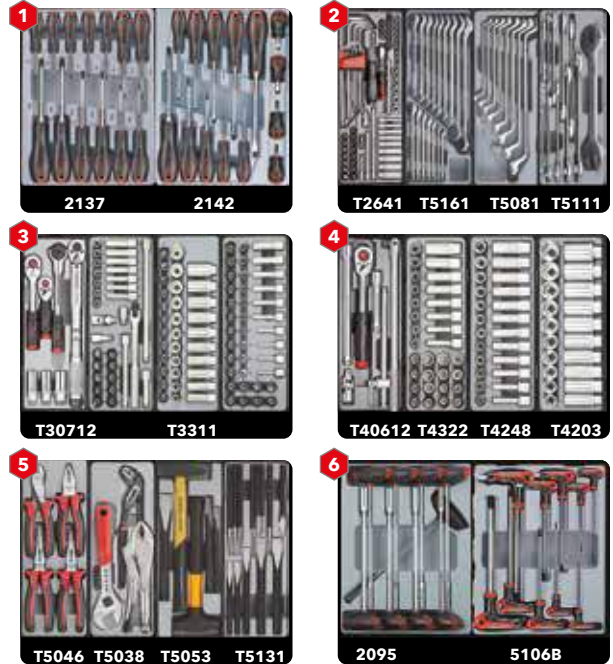
- 20 modules pour 6 tiroirs



FOR 10218C376 
 FOR 10218R376 
 FOR 10218B376 

376-delige Gevulde gereedschapswagen 8 laden

- 6 laden gevuld 22 modules
- gewicht : 112.7 kg

Servante mobile d'atelier 8 tiroirs avec 376 pcs d'outils

- 22 modules pour 6 tiroirs
- gewicht 112.7 kg



FOR VUL 376

Assortiment gereedschap 376 delig

- 6 laden - 22 modules

Assortiment d'outils 376 pcs

- 22 modules pour 6 tiroirs

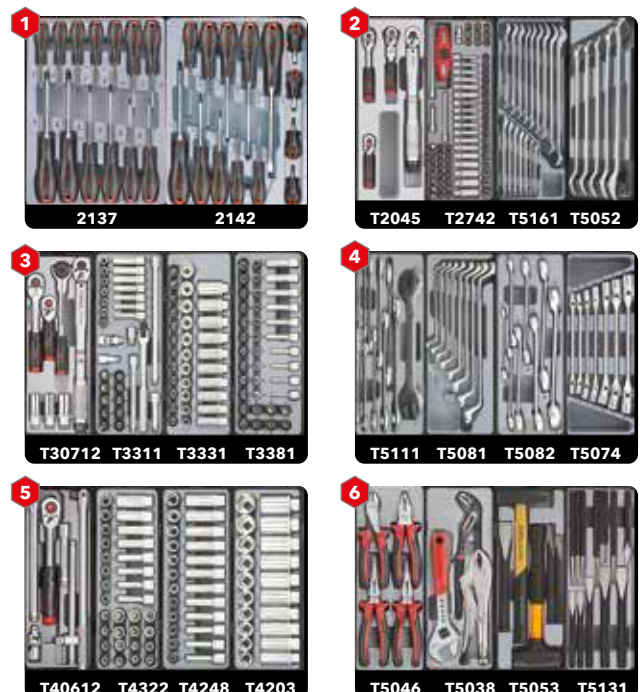

Gevulde gereedschapswagen Maxi tower - servante d'atelier



FOR 1013-562

562-delige Gevulde gereedschapswagen 8 laden gevuld + koffer 5 laden met gereedschap

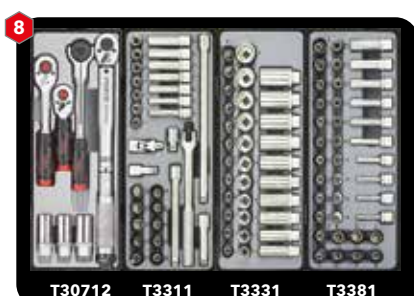
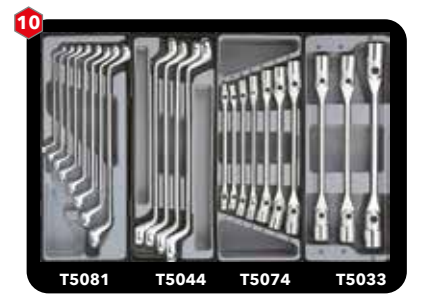
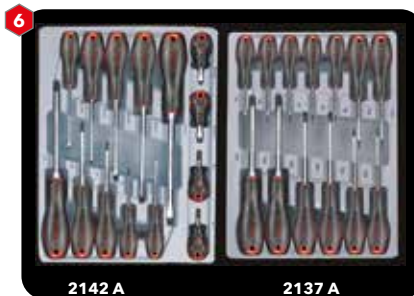
Servante mobile d'atelier 8 tiroirs avec coffret 5 tiroirs avec 562 pcs d'outils



Gevulde gereedschapswagen jumbo - servante d'atelier jumbo

FOR 10318C437 
 FOR 10318R437 

437-delige Gevulde gereedschapswagen 8 laden

- 6 laden gevuld 32 modules
- gewicht :192 kg

Servante mobile d'atelier 8 tiroirs avec 437 pcs d'outils

- 32 modules pour 6 tiroirs
- poids : 192kg

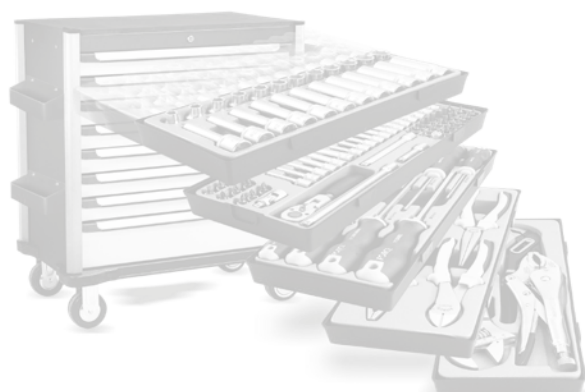

JUMBO

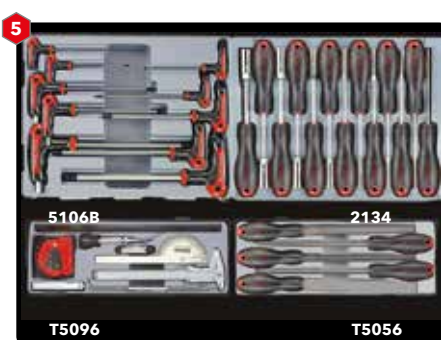

FOR VUL 437

Assortiment gereedschap 437 delig

- 6 laden 32 modules

Assortiment d'outils 437 pcs

- 32 modules pour 6 tiroirs

Gevulde gereedschapswagen foam - servante d'atelier système mousse

FOR 10217C198

198-delige Gevulde gereedschapswagen 7 laden

- 5 laden gevuld foams
- gewicht : 111kg

Servante mobile d'atelier 7 tiroirs avec 198 pcs d'outils

- 5 tiroirs avec mousse
- poids : 111kg

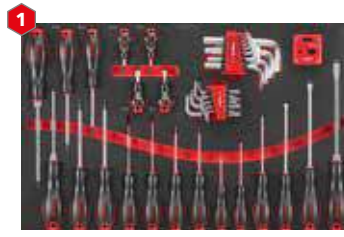

FOR F2412 Module schroevendraaiers + L sleutels
41 delig



FOR F4882 Module 1/4"-3/8"-1/2"
assortiment doppen
88 delig - Module de douilles 88 pcs



FOR F5361 Sleutelset 36 delig - set de clés 36 pcs

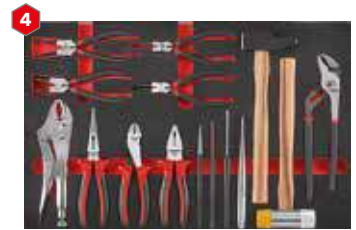

FOR F5155 tangen & hamerset 15 delig -
set de pincés & marteau 15 pcs



FOR F5186 Combinatieset 18 delig - assortiments
18 pcs

FOR 10217C308

308-delige Gevulde gereedschapswagen 7 laden

- 6 laden gevuld
- gewicht : 111kg

Servante mobile d'atelier 7 tiroirs avec 308 pcs d'outils

- 6 tiroirs avec 6 modules mousse
- poids : 111kg



FOR F2412 Module schroevendraaiers + L sleutels 41 delig

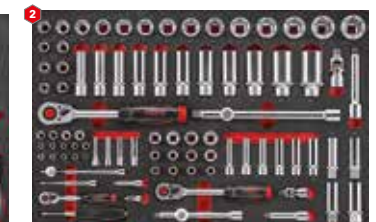

FOR F4882 Module 1/4"-3/8"-1/2"
assortiment doppen - 88 delig - Module de douilles 88 pcs



FOR F41041 Combinatieset 104 delig - set de combination



FOR F5361 sleutelset 36 delig - set de clés 36 pcs



FOR F5207 Tangen & batelset 20 delig - assortiments 20 pcs

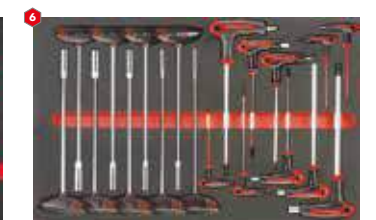

FOR F2195 Thendel set 19 delig - assortiments 19 pcs

FOR 10218C405

405-delig Gevulde gereedschapswagen 8 laden
gewicht : 111 kg

Servante mobile d'atelier 8 tiroirs avec 405 pcs d'outils

- 8 tiroirs avec mousse
- poids : 111kg



1 FOR F2262 Module schroevendraaiers 26dlg - module de 26 tournevis

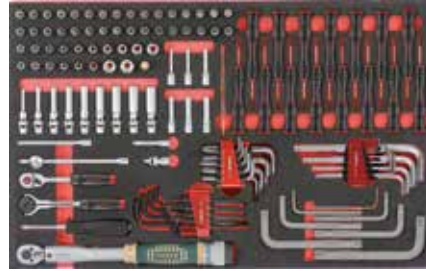

2 FOR F21261 Module 1/4" assortiment doppen & L sleutels 126 dlg - Module de douilles 126 pcs



3 FOR F3981 Doppenset 3/8"98 dlg - module de douilles 98pcs



4 FOR F4662 Doppenset 1/2" 66dlg modules de douilles 66pcs

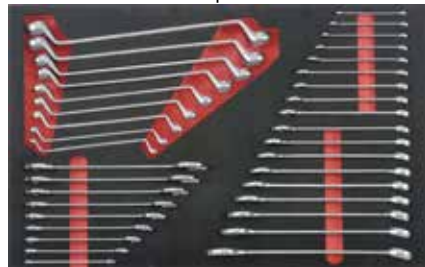

5 FOR F5363 Sleutelset 36 dlg modules de 36 clés

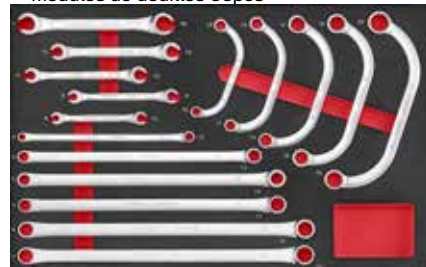

6 FOR F5168 Sleutelset 16 dlg module de 16 clés



7 FOR F5207 Tang & beitset 20 dlg module de pinces 20pcs



8 FOR F5178 Tangenset 17 dlg module de pinces 17pcs

FOR 10218C512**512 delig Gevulde gereedschapswagen 8 laden**

- 8 laden gevuld
- gewicht : 124.4 kg

Servante mobile d'atelier 8 tiroirs avec 512 pcs d'outils

- 8 modules pour 8 tiroirs
- poids : 124.4 kg

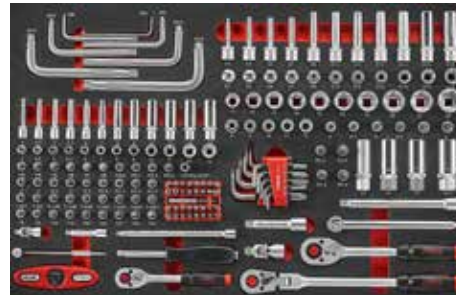
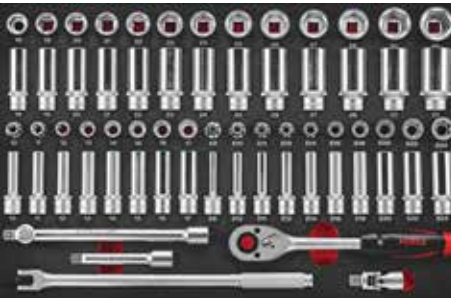
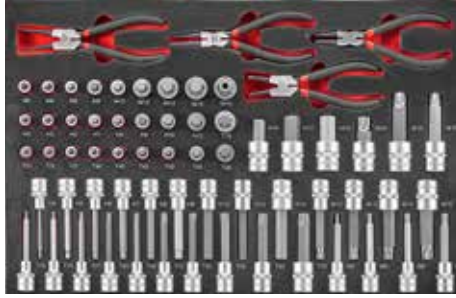
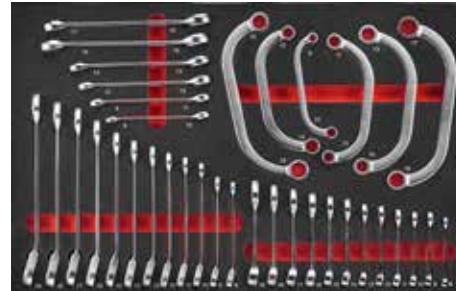
**1** FOR F2415 Module schroevendraaiers 41 dlg**2** FOR F31751 Module 1/4"- 3/8" assortiment doppen & L sleutels 175dlg - Module de douilles 175 pcs**3** FOR F4686 Doppenset 1/2"68dlg
jeu de douilles 68pcs**4** FOR F4642 Doppenset 1/2" - circlips tangen
64dlg - jeu de douilles 64pcs - pinces circlips**5** FOR F5361 Sleutelset 36 dlg - jeu de clés 36pcs**6** FOR F5367 Sleutelset 36dlg - jeu de clés 36pcs**7** FOR F5225 Tang & beiterset 22 dlg
jeu de pinces 22pcs**8** FOR F4702 Krachtdoppenset 70 dlg
jeu de douilles à chocs 70pcs

Gevulde gereedschapswagen foam JUMBO - servante d'atelier

FOR 10318C298

298-delige Gevulde jumbo gereedschapswagen 8 laden

- 5 laden gevuld

Servante mobile d'atelier 8 tiroirs avec 298 pcs d'outils

- 5 modules pour 8 tiroirs

JUMBO



FOAM
SYSTEM
MOUSSE

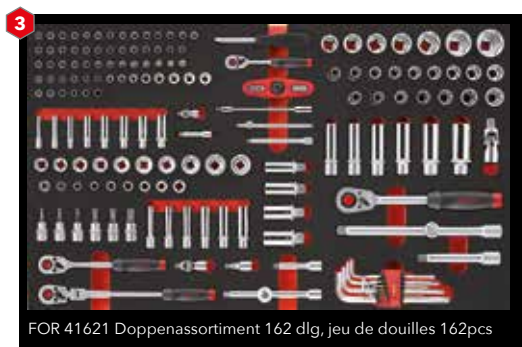

FOR 10318C610A

610-delige Gevulde jumbo gereedschapswagen 8 laden
 • 8 laden gevuld

Servante mobile d'atelier 8 tiroirs avec 610 pcs d'outils
 • 8 modules pour 8 tiroirs

JUMBO



**FOAM
SYSTEM
MOUSSE**

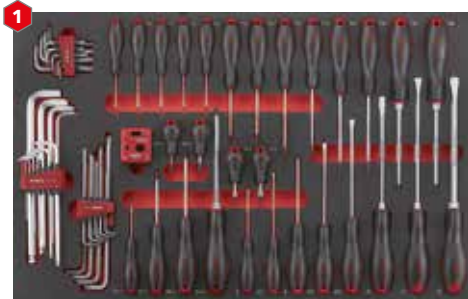

FOR F2592 schroevendraaiers + L sleutels 59dlg



FOR F5461 sleutelset 46dlg, jeu de 46 clés

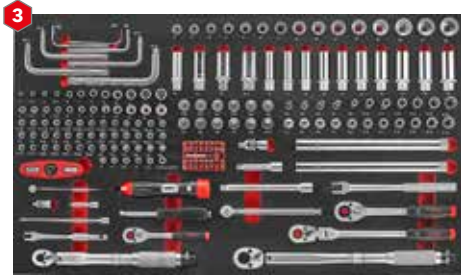

FOR F31921A 1/4"-3/8" combinatie set 192dlg



FOR F5296 tangen-beitset 29dlg

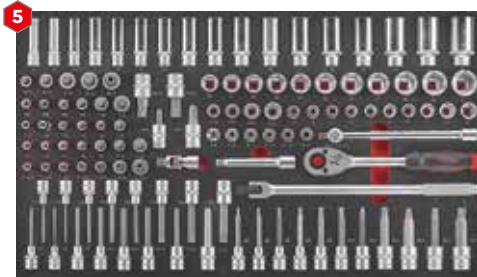

FOR F41162 1/2" doppenset 116dlg, jeu de douilles 116pcs



FOR F5292 sleutelset 29dlg, jeu de clés 29pcs



FOR F5505 sleutelset 50dlg 6-32mm, jeu de clés 50pcs



FOR F4891 slagdoppenset 89dlg, jeu de douilles à choc

FOR 10318C607

607-delige Gevulde jumbo gereedschapswagen 8 laden voor trucks

- 8 laden gevuld

Servante mobile d'atelier 8 tiroirs avec 607 pcs d'outils

- 8 modules pour 8 tiroirs

JUMBO TRUCK

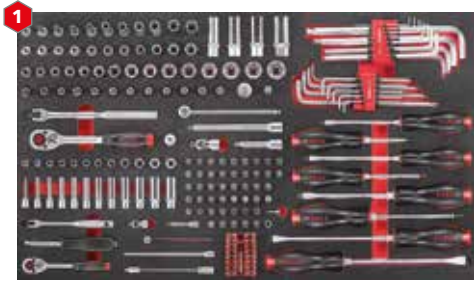

FOR F32031 1/4"-3/8" combinatieset 203dlg

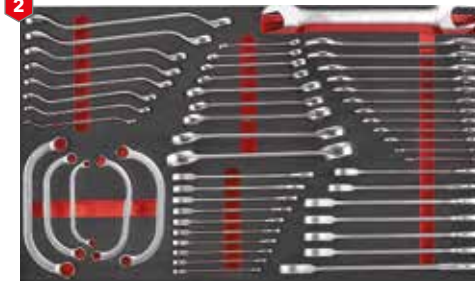

FOR F5522 sleutelset 42dlg, jeu de clés 42pcs

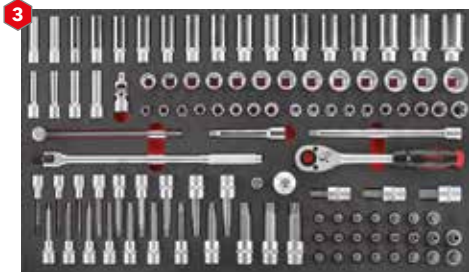

FOR F41062 doppenset 1/2" 106dlg, jeu de douilles 106pcs



FOR F6342 doppenset 3/4" 34 dlg 17-50mm



FOR F41001 slagdoppenset 1/2" 100 dlg, jeu de douilles 100pcs



FOR F6431 slagdoppenset 3/4" 43dlg 17-46mm



FOR F5422 sleutelset 42 dlg 6-38mm, jeu de clés 42pcs



FOR F5272 combinatieset 27dlg, jeu de combination 27pcs



TC TRAYS



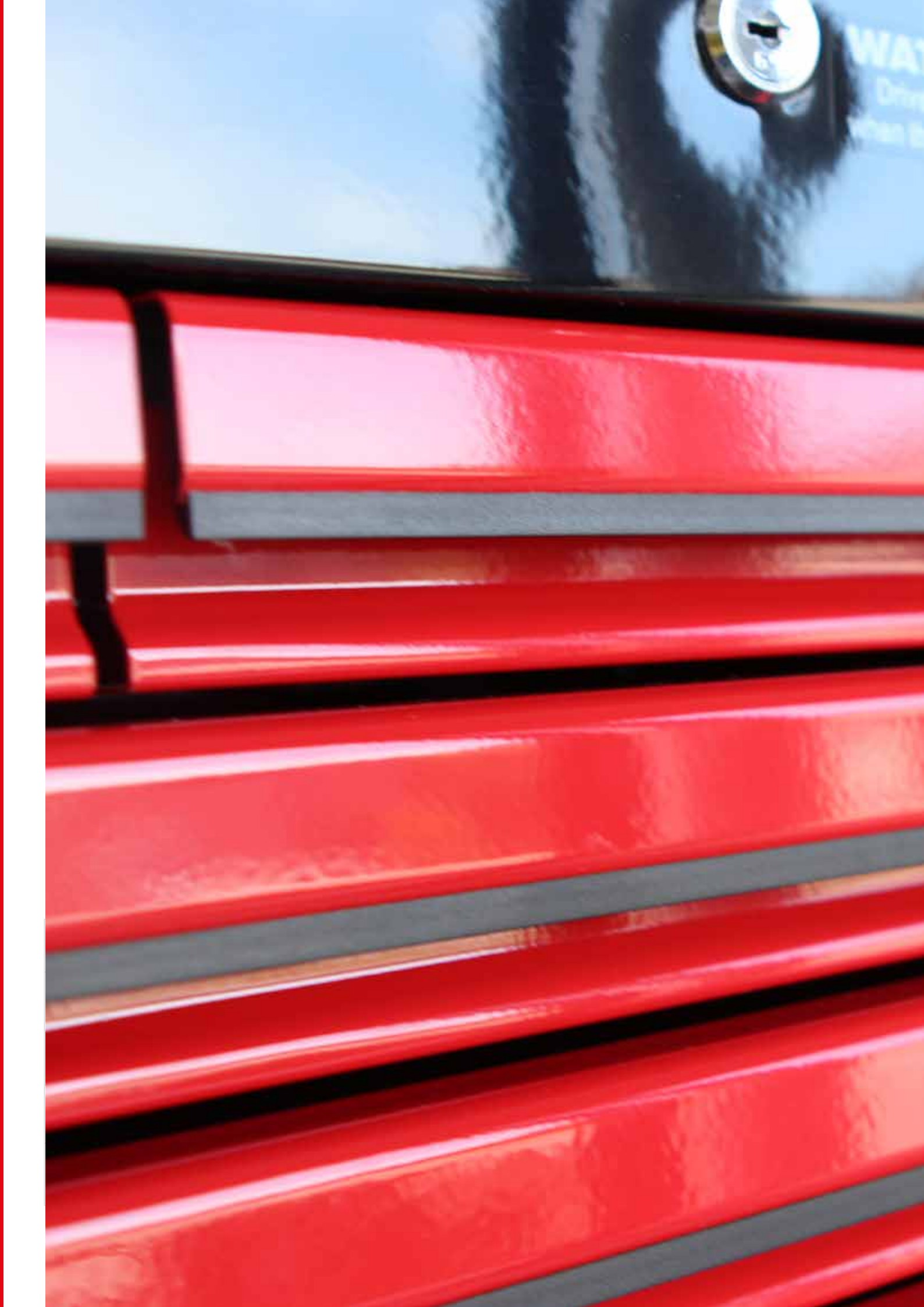

TC TRAYS

TC module systeem

maak je eigen selectie en stel zelf je gereedschapswagen samen
composer votre servante

- 4 modules per lade (50223-10225-10217-10218) / 4 modules par tiroir
- 6 modules per lade (enkel Jumbo model 10318) 6 modules par tiroir
- afm. TC module 37cm x 14cm
- alle modules ook leeg verkrijgbaar - module vide livrable

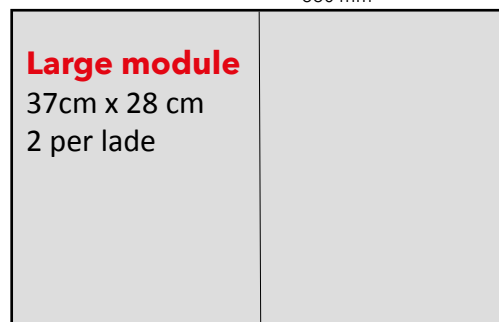
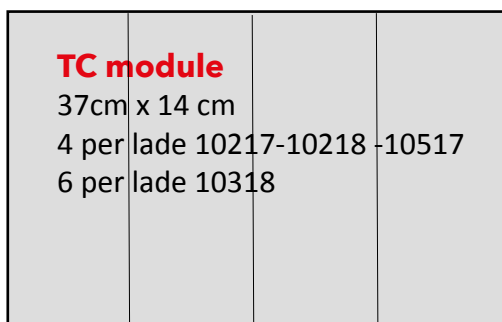
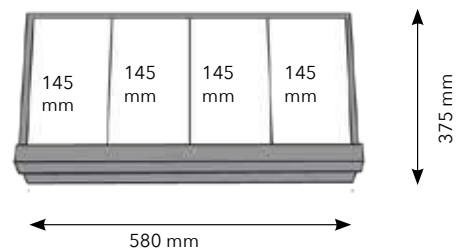

FOR T2084A

Schroevendraaierset 8 delig
Module 8 tournevis



FOR T2085A

Schroevendraaierset pozidriv 8 delig
Module 8 tournevis pozidriv



FOR T2086A

Torx schroevendraaierset 8 delig
Module 8 tournevis torx



FOR T20712

Schroevendraaierset geïsoleerd 8 delig
Module 8 tournevis 1000v



FOR T2173

Mini schroevendraaierset 17 delig
Module 17 tournevis mini



FOR T20715N

Schroevendraaierset geïsoleerd 7 delig
Module 7 tournevis 1000v



FOR T50637

Module 6 inbussleutel met handvat
Module 6 clés mâles avec poignée L 2-3-4-5-6-8mm



FOR T20612

Module 6dlg schroevendraaier op dop
Module 6 tournevis sur douilles



TC TRAYS 1/4"

FOR T2045

Module 1/4" Ratelset 4 delig
Module cliquet 1/4" 4 pcs



FOR T2641

Module 1/4" Doppenassortiment 65 delig
Module douilles et acc. 65 pcs 1/4"



FOR T2742

Module 1/4" Doppenassortiment 74 delig
Module assortiment douilles 1/4" 74 pcs



FOR T2741

1/4" Doppenassortiment mm + Inch 74 delig
Module douilles et acc. 74 pcs 1/4" mm + Inch



FOR PT.....

Alle lege modules verkrijgbaar
Toutes les modules livrables, ajouter "P" devant la référence
pour obtenir la module vide

FOR T4583

Module 58dlg dop -bit-torx- inbus set
Module 58 embouts - douilles torx hex



FOR T50636

Module 6 torx-resistrox sleutels met handvat
Module 6 clés torx-resistorx



TC TRAYS 3/8"

FOR T30711

Module 3/8" Ratelset 7 delig
Module cliquet 3/8" 7 pcs



FOR T30712

Module 3/8" Ratelset 7 delig
Module cliquet 3/8" 7 pcs



FOR T3251 5

Module 3/8" Doppensortiment 24 delig 6kant
Module douilles et acc. 24 pcs 3/8" 6pans



FOR T3212

3/8" Doppensortiment 21 delig inch
Module douilles et acc. en pouce 21 pcs 3/8"



FOR T3193

3/8" Doppenset kort + lang inch 19 delig 6k
Module 19 douilles en pouce 3/8" 6p

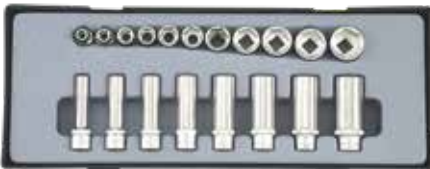

FOR T3121

3/8" Lange doppenset 12 delig 6k
Module 12 douilles longues 6p



FOR T3331

3/8" Doppenset 33 delig kort + lang
Module 33 douilles 3/8"



FOR T3322

3/8" Doppensortiment 32 delig mm & inch
Module de douilles 32 pcs mm + inch



FOR T3311

3/8" Kombinatieset 31 delig
Module douilles et acc. 31 pcs 3/8"



FOR T3381

3/8" Torx & XZN set 38 delig
Module 38 douilles torx & XZN 3/8"



TC TRAYS

FOR T3521

Module Torxset 52 delig
Module jeu de torx 52 pcs



FOR T3361

Module Doppenassortiment 36 delig
Module douilles et acc 36 pcs



FOR T31010

Module 3/8" Bougiedoppenset 10 dlg
Module douilles pour bougies 3/8" 10pcs



FOR T50618-18

Module bougie gereedschapset 3/8" 6 dlg
Module pour bougies 3/8" 6pcs



FOR T3382

Module torx doppenset 3/8" 38 dlg
Module de douilles torx 3/8" 38pcs



FOR T3224

Module Doppenset met kniegewricht 3/8" 22 dlg
Module de 22 douilles Cardan Universel 3/8"

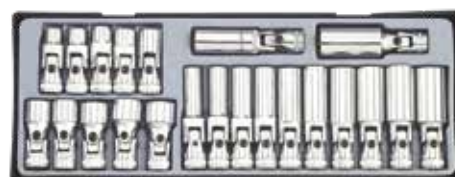

FOR T3251 9

Module 3/8" Doppenassortiment 24 delig 12kant
Module douilles et acc. 24 pcs 3/8" 12pans



FOR T4217

Module 21 doppen kort + lang 6 kant 1/2"
Module 21 douilles 6 pans 1/2"



TC TRAYS 1/2"

FOR T4057

1/2" Ratelset & accessoires 5 delig
Module de 4 accessoires + cliquet 1/2"



FOR T40612

1/2" Ratelset & accessoires 6 delig
Module de 5 accessoires + cliquet 1/2"



FOR T4212

1/2" Doppenset metric 6k 21 delig
Module 21 douilles 6 pans 1/2"



FOR T4212-9

1/2" Doppenset 12k 21 delig
Module 21 douilles 12 pans 1/2"



FOR T4194

1/2" Doppenset 19 delig inch 6k
Module 19 douilles 6 pans en pouce 1/2"



FOR T4203

1/2" Doppenset kort + lang 6kant 20 delig
Module 20 douilles 6 pans 1/2"



FOR T4143

1/2" Lange doppenset 6k 14 delig
Module 14 douilles longues 6 pans 1/2"



FOR T4143 9

1/2" Lange doppenset 12k 14 delig
Module 14 douilles longues 12 pans 1/2"



FOR T4248S

1/2" Doppenset kort + lang inch 6k 24 delig
Module 24 douilles 6 pans en pouce 1/2"



FOR T4248

1/2" Doppenset kort + lang 6k 24 delig
Module 24 douilles 6 pans 1/2"



FOR T4226

1/2" Doppenset 6k 22 delig
Module douilles 6 pans 22 pcs 1/2"



FOR T4413

Torxset 41 delig
Module douilles torx 41 pcs



FOR T4122

1/2" Mixed doppenset 12 delig
Module 12 douilles tournevis 1/2"



FOR T4116

1/2" Mixed doppenset 11 delig
Module 11 douilles 1/2"



FOR T4322

1/2" Torx & XZN dopbitset 32 delig
Module 32 douilles torx & XZN 1/2"



FOR T4281

1/2" Doppenassortiment 27 delig
Module 27 douilles 1/2"



FOR T4355

1/2" Torx & XZN dopbitset 35 delig
Module 35 douilles torx & XZN 1/2"



FOR T41710

1/2" Inbus doppenset 17 delig
Module 17 douilles hexagonales 1/2"

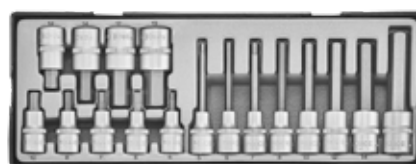

FOR T4179

1/2" XZN dopbitset 17 delig
Module 17 douilles XZN 1/2"

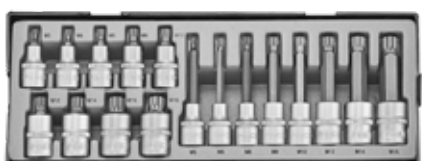

FOR T4165

1/2" Torx doppenset 16 delig
Module 16 douilles torx 1/2"



Slagdoppen - douilles à choc

FOR T4193

1/2" Slagdoppenset 19 delig 6kant
Module 19 douilles à choc 1/2" 6pans



FOR T4193 9

1/2" Slagdoppenset 19 delig 12kant
Module 19 douilles à choc 1/2" 12pans



FOR T4205

1/2" Slagdoppenset torx-inbus 20 delig
Module 20 douilles à chocs torx-hex



FOR T4119

1/2" Lange slagdoppenset 11 delig 6kant
Module 11 douilles à choc longues 1/2" 6pans



FOR T40813

1/2" Lange slagdoppenset 11 delig 12kant
Module 11 douilles à choc longues 1/2" 12pans



FOR T40813-5

1/2" Lange slagdoppenset 11 delig 6kant
Module 11 douilles à choc longues 1/2" 6pans



FOR T8151

Slagmoer adapter set 15 delig
Module 15 réducteur à choc



FOR T6121

3/4" Slagdoppenset 12 delig 6kant
Module 12 douilles à choc 3/4" 6pans



FOR T6085

3/4" Lange slagdoppenset 8 delig
Module 8 douilles à choc longues 3/4"



TC Trays tangen - pincen

FOR T5046

Tangenset 4 delig
Module 4 pincen



FOR T5043A

Borgveertangenset 4 delig
Module 4 pincen circlips



FOR T50410

Geisoleerde tangenset 4 delig
Module 4 pincen isolées 1000v



FOR T5038

Tangenset 3 delig
Module 3 pincen



FOR T5023

Verstelbare moersleutelset 2 delig
Module 2 clés à molette



FOR T5036

Verstelbare moersleutelset 2 delig
Module 2 clés à molette



FOR T5047

Lange tangenset 4 delig
Module 4 pincen longues



FOR T50814

Minitangenset 8 delig
Module 8 pincen mini



FOR T5057

Multi grip tangenset 5 delig
Module 5 pincen étau axiale



TC Trays sleutels - clés

FOR T5161

Steekringsleutelset 16 delig
Module 16 clés mixtes



FOR T5134

Steekringsleutelset inch 13 delig
Module 13 clés mixtes en pouce



FOR T5181

Steekringsleutelset 18 delig
Module 18 clés mixtes



FOR T5089

Steekringsleutelset 8 delig
Module 8 clés mixtes



FOR T5052

Steekringsleutelset 5 delig
Module 5 clés mixtes



FOR T51214

Mini steekringsleutelset 12 delig
Module 12 clés mixtes courte



FOR T5111S

Steeksleutelset 11 delig inch
Module 11 clés à fourches en pouce



FOR T5111

Steeksleutelset 11 delig
Module 11 clés à fourches



FOR T50634

Module 6 "S" vormige ringsleutels
Module 6 clés coudées en forme "S"



FOR T5081

**Gebogen ringsleutelset 8 delig 75°
Module 8 clés polygonales 75°**



FOR T5044

**Gebogen ringsleutelset 4 delig 75°
Module 4 clés polygonales**



FOR T5079S

**Gebogen ringsleutelset inch 7 delig 75°
Module 7 clés polygonales 75° en pouce**



FOR T5085

**Gebogen ringsleutelset 8 delig 45°
Module 8 clés polygonales 45°**



FOR T51226

**Platte ringsleutelset 12 delig 6-32 mm
Module 12 clés à polygonales plates 6-32 mm**



FOR T5085S

**Gebogen ringsleutelset inch 8 delig 45°
Module 8 clés polygonales 45° en pouce**



FOR T50817

**Pijpsleutelset 8 delig 6k
Module 8 clés en tube**



FOR T5114

**Gebogen pijpsleutelset 11 delig
Module 11 clés à pipe débouchée**



FOR T5082

**Open ringsleutelset 8 delig
Module 8 clés tuyauter**



FOR T50710S

**Open ringsleutelset inch 7 delig
Module 7 clés tuyauter en pouce**



FOR T5074

Kniesleutelset 7 delig
Module 7 clés à douilles articulées

**FOR T5033**

Kniesleutelset 3 delig
Module 3 clés à douilles articulées

**FOR T50616S**

Kniesleutelset 6 delig inch
Module 6 clés à douilles articulées inch

**FOR T5172**

Opsteek steeksleutelset 17 delig
Module 17 clés pied à corneille

**FOR T51211**

Ratel-steekringsleutel omkeerbaar 12 delig
Module 12 clés mixtes à cliquet resersible 8-19 mm

**FOR T51210**

Ratel-steekringsleutel 12 delig
Module 12 clés mixtes à cliquet

**FOR T5164R**

Omkeerbare ratelsleutelset met adapters 16 delig
Module 16 clés mixtes à cliquet réversible

**FOR T50617**

Ring ratelsleutel torx 6 delig
Module 6 clés à cliquet torx

**FOR T50810**

Ring-ratelsleutelset 8 delig 8-22 mm
Module 8 clés polygonales à cliquet 8-22 mm

**FOR T50811**

Gebogen ringratelsleutelset 8 delig 8-22 mm
Module 8 clés polygonales courbé à cliquet 8-22 mm



TC Trays

FOR T51811

Riveteertangset 181 delig
Module pince à riveter 181 pcs



FOR T5056

Vijlenset 5 delig
Module 5 limes



FOR T5122

Olie pluggenset 12 delig
Module 12 outils de graissage



FOR T905M2

Demontage gereedschapset 5 delig
Module 5 grattoirs & crochets



FOR T5131

Beitel - en peneudrijverset 13 delig
Module 13 poinçons et burins



FOR T51229

Beitel - en peneudrijverset 12 delig
Module 12 poinçons et burins



FOR T50725

Module beitelset 7 dlj
Module 7 burins



FOR T50723A

Module pendrijver & doorslagenset 7 dlj
Module de 7 chasse goupilles



FOR T50822

Module hamer & beitelset 8 dlj
Module de marteau & burins 8pcs



FOR T5053

Hamer - beitelset 5 delig
Module 5 acc.marteau et burins



FOR T5331

Repair tools set 33 delig
Module 33 outils reparation

**FOR T5303**

Module haakse sleutel en bitset 30 dlg
Module de clés mâles coudées & embouts 30pcs

**FOR T5096**

Meetgereedschapset 9 delig
Module d'outillage de mesure 9 pcs

**FOR T5055**

Snijgereedschapset 5 delig
Module 5 outils à couper

**FOR PT5000**

Module leeg B38cm x L14 cm x H4.5cm
Module vide 38x14 cm



Large

Modulair systeem | 2 per lade (28x37cm x H4cm)

FOR 2142A

Schroevendraaierset 14 delig
Module 14 tournevis



FOR 2137A

Torx schroevendraaierset 13 delig
Module 14 tournevis torx



FOR 2108

Hamer schroevendraaierset 10 delig philips
Module 10 tournevis à frappe, philips/plat



FOR 2109

Hamer schroevendraaierset 10 delig pozidriv
Module 10 tournevis à fraper pozidriv/plat



FOR 2125

Schroevendraaierset 1000v PH 12 delig
Module 12 tournevis 1000v



FOR 2126

Schroevendraaierset 1000v pozidriv 12 delig
Module 12 tournevis 1000v pozidriv



FOR 2095

Dop op T handvat 9 delig
Module 9 douilles poignées en T

**FOR 2095S**

Dop op T handvat inch 9 delig
Module 9 douille sur douille en pouce - poignées en T

**FOR 5106B**

Inbus-ballpoint L hendel 10 delig
Module 10 clés mâles poignées en L

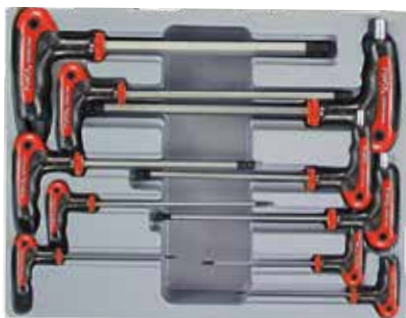
**FOR 50910BS**

Inbus-ballpoint L hendel 9 delig inch
Module 9 clés mâles poignées en L en pouce

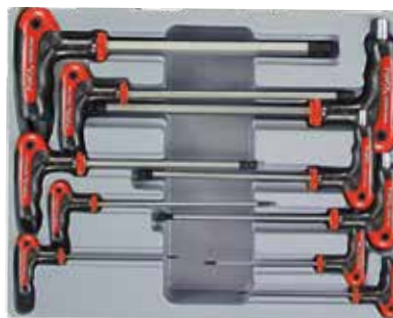
**FOR 2097**

Inbussleutel op T handvat 9 delig
Module 9 clés mâles poignées en T

**FOR 2097B**

Inbus met bolkop op T handvat 9 delig
Module 9 clés mâles poignées en T

**FOR 2097S**

Inbus op T handvat 9 delig inch
Module 9 clés mâles poignées en T tête sphér. en pouce

**FOR 50912**

T sleutels met inbus 9 delig
Module 9 clés mâles poignées en T

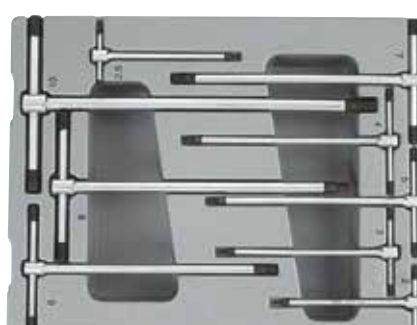

FOR 2141

Torx op T handvat 14 delig
Module 14 torx poignées en T



FOR 2141T

Resistorx T handvat 14 delig
Module 14 resistorx poignées en T



FOR 51010T

Resistorx op L handvat 10 delig
Module resistorx 10 pcs



FOR 2096

Inwendige torx dop op T handvat 9 delig
Module 9 torx sur douille - poignées en T



FOR 2134

Dopschroevendraaier 6k 13 delig
Modules 13 tournevis douilles



FOR 5048

Striptangenset 4 delig
Module 4 pinces à sertir



FOR 54111

Strip set 411 delig
Module 411 pcs + pince à dénuder

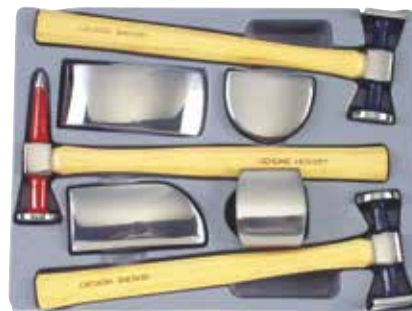
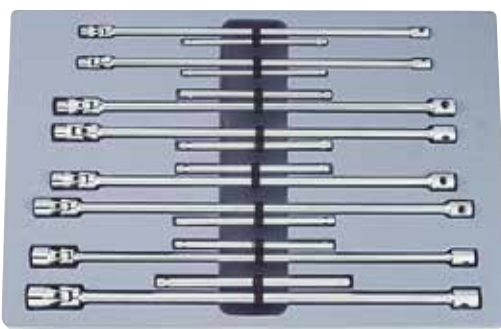
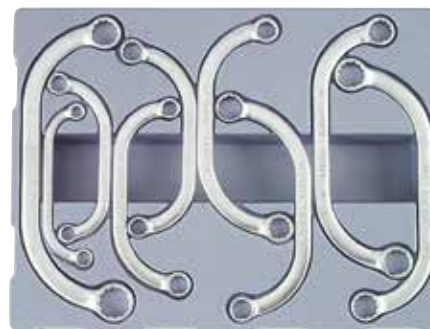

FOR 5138**Beitel-doorslagenset 13 delig****Module 13 burins & poinçons gainés****FOR 5139****Module 13 pendrijver en beitelset****Module de 13 burins & chasse-goupilles****FOR 50713****Uitdeukset 7 delig****Module kit de deblossage 7 pcs****FOR 50816****Universeel cardangewrichtsleutels lang 8 delig****Clés cardan universelles 8 pcs****FOR 50911****Halvemaansleutelset 9 delig****Module 9 clés demi-lune****FOR PPTSK130****Open doos voor TC module (38 x 14 mm x 4.5)****TC module vide****FOR PPVSK130****Deksel voor TC module****Couvercle pour TC module**

FOAMS

MOUSSES



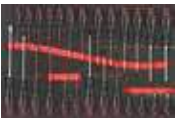
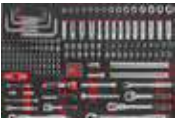

	Foamsets - mousse	74
	Foam sets Jumbo - mousse pour Jumbo	87

Foam system -mousse

- ieder gereedschap zijn eigen plaats, dit zorgt voor een hogere productiviteit
- beter georganiseerd, snel toegankelijk
- chemisch bestendig schuim
- tweekleurig systeem, het valt direct op welke gereedschappen ontbreken
- het gereedschap blijft op zijn plaats tijdens het transport



FOR 10225 - FOR 50223

FOR 10217

FOR 10218

FOR 10517

afmeting/dim foam

57cm x 37.5 cm



FOR 10318 Jumbo

afmeting / dim foam

74cm x 43.5 cm

Foam - mousse 10225-10217-10218-10517

FOR F2262

Schroevendraaierset 26 delig
Module 26 tournevis

713 03....08	3-3.5-4-5.5-6.5-8 mm
713055S - 713065S	5.5-6.5 mm (25mmL)
7111 - 7112 - 7113	PH1-PH2-PH3
7111S - 7112S	PH1-PH2 (25mmL)
716 05....45	T5-T6-T8-T9-T10-T15-T20-T25-T27-T30-T40-T45

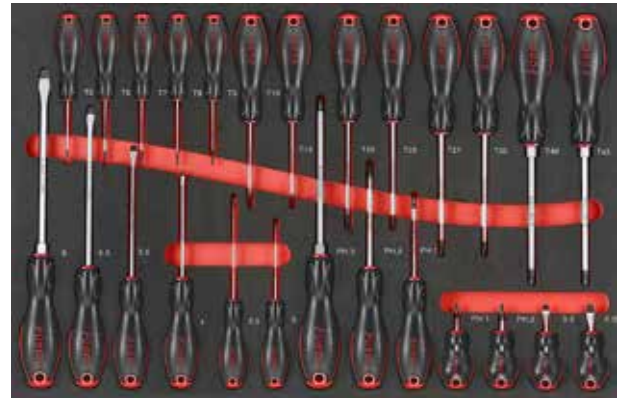

FOR F2412

Schroevendraaierset & L sleutel set 41 delig
Module tournevis & clés mâles 41 pcs

713 03....08	3-4-5.5-6.5-8 mm
713055S - 713065S	5.5-6.5 mm (25mmL)
7110 - 7111 - 7112 - 7113	PH0-PH1-PH2-PH3
7111S - 7112S	PH1-PH2 (25mmL)
716 10...40	T10-T15-T20-T25-T27-T30-T40
766 10...50 torx L	FOR 5098 - T10-T15-T20-T25-T27-T30-T40-T45-T50
764 1.5....12 inbus L	FOR 5116 - 1.5-2-2.5-3-4-5-6-7-8-10-12 mm
88601	demagnetiseur



FOR F2415

Schroevendraaierset & L sleutel set 41 delig
Module tournevis & clés mâles 41 pcs

71303 t/m 71308	3-3.5-4-5.5-6.5-8 mm
713055S - 713065S	5.5-6.5 mm (25mmL)
7110 - 7111 - 7112 - 7113	PH0-PH1-PH2-PH3
7111S - 7112S	PH1-PH2 (25mmL)
716 10.... 40	T10-T15-T20-T25-T27-T30-T40
766 10...50 torx L	FOR 5098L - T10-T15-T20-T25-T27-T30-T40-T45-T50
764 1.5....12 inbus L	FOR 5116L - 1.5-2-2.5-3-4-5-6-7-8-10-12 mm



FOR F2182

**Schroevendraaierset & tangen 1000v 18 delig
Module 18 tournevis & pinces 1000v**

711N0	ph0 (60 mm L)
711N1	ph1 (80 mm L)
711N2	ph2 (100 mm L)
711N3	ph3 (150 mm L)
713N025	2.5 mm (75 mm L)
713N03	3 mm (100 mm L)
713N035	3.5 mm (100 mm L)
713N04	4 mm (100 mm L)
713N055	5.5 mm (125 mm L)
713N065	6.5 mm (150 mm L)
713N08	8 mm (175 mm L)
6903180	kombinatietang 180 mm L, pince universelle
6904200	lange bektang 200 mm L, pince à becs long
6911200	kniptang 200 mm L, pince coupante
6912160	striptang 160 mm L, pince à sertir
6909250	kabel snijder 250 mm
6806	striptang, pince a sertir
88408	Voltage tester 6-400v ac



FOR F5117

**Tangenset 11 delig
Module 11 pinces**

649250E	moersleutel, clé à molette 250 mm
613B250	waterpomptang, pince multiprise
614250	vise grip tang, pince grip
610B200	lange bektang, pince à becs long 200 mm
611B175	universele tang, pince universelle 175 mm
612B175	kniptang, pince coupante 175 mm
5047P1	lange bektang, pince à becs long
5047P2	lange bektang, pince à becs long 45°
5047P3	lange bektang, pince à becs long 90°
5047P4	multi tang 4 punts grip, pince multi grip
673B215	motortang, pince moteur



FOR F51217

**Tangenset 12 delig
Module 12 pinces**

610B200	lange bektang, pince à becs long 200 mm
610B200B	lange gebogen bektang, pince à becs long coudé 200 mm
611B175	kombinatietang, pince universelle 175 mm
612B175	kniptang, pince coupante 175 mm
614250	vise grip tang, pince grip 250 mm
613B250	waterpomptang, pince multiprise 250 mm
649250A	moersleutel, clé à molette 250 mm
609ASO	circlips tang, pince circlips 1.8 mm open
609ASC	circlips tang, pince circlips 1.8 mm gesloten
609ABO	circlips tang, pince circlips 1.8 mm 90° open
609ABC	borgveertang, pince circlips 1.8 mm 90° gesloten
6982	schaar, ciseau



FOR F5155

Tangen-hamerset 15 delig
Module pinces & marteaux 15 pcs

60226200C	koudbeitel 26 mm 200 mm L, burin
6044190	doorslag 4 mm 190 mm L, chasse goupilles
6046210	doorslag 6 mm 210 mm L
6074185	center punt 4 mm 185 mm L
613250	waterpomptang, pince multiprise
614250	vise grip tang, pince grip
610B200	lange bektang, pince à becs long 200 mm
611B175	universele tang, pince universelle 175 mm
612B175	kniptang, pince coupante 175 mm
609ASC	circlipstang 1.8 mm gesloten, pince circlips
609ASO	circlipstang 1.8 mm open, pince circlips
609ABO	circlipstang 1.8 90° open
609ABC	circlipstang 1.8 mm 90° gesloten
616A400	hamer 400gr, marteau
616F032	rivette hamer 32 mm, marteau rivette



FOR F5178

Foam tangen-beitelset 17 delig
Module pinces & burins 17 pcs

50814P2	precisie platte bektang
50814P3	precisie combinatietang
50814P4	precisie lange bektang
50814P5	precisie telefoontang
50814P6	precisie lange bektang gebogen
50814P7	precisie kopkniptang
50814P8	precisie zijkniptang
5047P1	extra lange rechte bektang 280mmL
5047P2	extra lange bektang 45° gebogen
5047P3	extra lange bektang 90° gebogen
5047P4	extra lange bougiestekker tang
609ABC	circlipstang voor binnenringen, 90° gebogen
609ABO	circlipstang voor buitenringen, 90° gebogen
609ASC	circlipstang voor binnenringen, recht
609ASO	circlipstang voor buitenringen, recht
6805A	kabelstriptang



FOR F5207

Tangen-beitelset 20 delig
Module pinces & burins 20 pcs

60226200C	koudbeitel 26 mm 200 mm L, burin
6044190	doorslag 4 mm 190 mm L, chasse goupille
6045200	doorslag 5 mm 200 mm L
6046210	doorslag 6 mm 210 mm L
6048215	doorslag 8 mm 215 mm L
60725185	center punt 2.5 mm 185 mm L
6074185	center punt 4 mm 185 mm L
6076185	center punt 6 mm 185 mm L
60212150	platte beitel 12mm, burin
60212180	platte beitel 15mm
60219200	platte beitel 19mm
613B250	waterpomptang, pince multiprise
614250	vise grip tang, pince grip
610B200	lange bektang, pince à becs long 200 mm
610B200B	gebogen lange bektang 200 mm
611B175	universele tang, pince universelle 175 mm
612B175	kniptang, pince coupante 175 mm
649250	moersleutel 250 mm L, clé à molette
616300	hamer 300gr, marteau
616480	rubber hamer 400gr, marteau choutchouc



FOR F5225

Foam tangen-beitelset 25 delig
Module pinces & burins 25 pcs

6042140	pendrijver 2mm
6043150	pendrijver 3mm
6044190	pendrijver 4 mm 190 mm L, chasse goupille
6045200	pendrijver 5 mm 200 mm L
6046210	pendrijver 6 mm 210 mm L
6048215	pendrijver 8 mm 215 mm L
60410230	pendrijver 10mm 230mmL
6074185	center punt 4 mm 185 mm L
60212150	platte beitel 12mm, burin
60219200	platte beitel 19mm
60225220	platte beitel 25mm
603150	kapbeitel
613B250	waterpomptang, pince multiprise
614250	vise grip tang, pince grip
610B200	lange bektang, pince à becs long 200 mm
610B200B	gebogen lange bektang 200 mm
611B175	universele tang, pince universelle 175 mm
612B175	kniptang, pince coupante 175 mm
649250	moersleutel 250 mm L, clé à molette
616300	hamer 300gr, marteau
616400	rubber hamer 400gr, marteau choutchouc
68021	monteurs mes



FOR F21261

Foam combinatieset 126 dlg 1/4"
Jeu de combinaison 126 pcs 1/4"

52504 t/m 52513	1/4"	4-4.5-5-5.5-6-7-8-9-10-11-12-13 mm (korte doppen - douilles)
5255006 t/m 13	1/4"	6-7-8-9-10-11-12-13 mm (lange doppen, douilles longues)
52604 t/m 52610	1/4"	E4-E5-E6-E7-E8-E10
5265004 t/m 5265010	1/4"	E4-E5-E6-E7-E8-E10 (lang, longues)
8042050...150	1/4"	verlengstuk, rallonges 50 mm-100 mm-150 mm
80521	1/4"	kniegewricht, cardan universelle
80932	1/4"	adapter 3/8" x 1/4"
802215 - 802223	1/4"	ratel 20 tanden - flexibele ratel 72 tanden
8143	1/4"	steekhecht, manche tournevis
81225	1/4"	magneet, aiment
6472270	1/4"	momentsleutel
3263208 t/m 40	1/4"	torx T8-T10-T15-T20-T25-T27-T30-T40
3273208 t/m 40	1/4"	resistorx T8H-T10H-T15H-T20H-T25H-T27H-T30H-T40H
3243203 t/m 8	1/4"	inbus, hex 3-4-5-6-7-8mm
321 320...322	1/4"	PH0-PH1-PH2
322 320...322	1/4"	PZ0-PZ1-PZ2
323 32 03..65	1/4"	plat 3-4.-5.5 - 6.5 mm
7650127L t/m 76510L	5102LB	1.27-1.5-2-2.5-3-4-5-6-8-10mm (inbus sleutels)
76610BL t/m 76650BL	5098LB	T10-T15-T20-T25-T27-T30-T40-T45-T50 (haakse torx sleutels)
76F10 t/m 76F50	50913	TS10-TS15-TS20-TS25-TS27-TS30-TS40-TS45-TS50
76805K t/m 76816K		M5-M6-M8-M10-M12-M14-M16 (spline haakse sleutels)
731A040000-A4000		PH.000-PH.00 precisie schroevendraaier
733A04001	plat	1.0-1.2-1.5-1.8-2.0-2.5mm
734040009 t/m 15	inbus	0.9-1.3-1.5mm
736A04005 t/m 7	torx	T5-T6-T7-T8

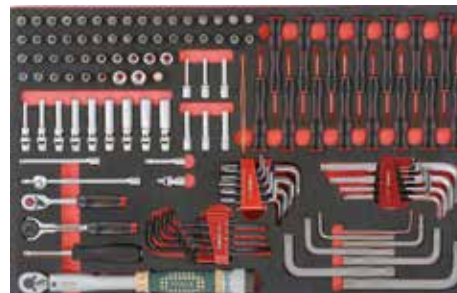

FOR F3981

Foam doppen combinatieset 3/8" 98dlg
Module mousse douilles 3/8" 98pcs

53506 t/m 22	3/8"	doppen 6-7-8-9-10-11-12-13-14-15-16-17-18-19-20-21-22 mm
805358510 t/m 19	3/8"	kniegewricht doppen 10-11-12-13-14-15-16-17-18-19mm
53606 t/m 16	3/8"	torx doppen E6-E7-E8-E10-E11-E12-E14-E16
5365506 t/m 16	3/8"	torx doppen lang E6-E7-E8-E10-E11-E12-E14-E16
3365008 t/m 60	3/8"	torx T8-T10-T15-T20-T25-T30-T40-T45-T50-T55-T60
3375008 t/m 60	3/8"	resistorx T8H-T10H-T15H-T20H-T25H-T27H-T30H-T40H-T50H-T55H-T60H
3385005 t/m 12	3/8"	XZN M5-M6-M8-M9-M10-M12
3345003 t/m 12	3/8"	inbus, hex 3-4-5-6-7-8-10-12 mm
33645U	3/8"	torx stiftkop met kniegewricht
802315	3/8"	ratel 30 tanden
802323		flexibele ratel 72 tanden
804375-150-225mm	3/8"	verlengstuk, rallonges 75 mm-150 mm-225mm
80633	3/8"	adapter voor verlengstuk 3/8" x 3/8"
80531	3/8"	kniegewricht, cardan universelle
832318-832324	3/8"	moment adapters 18Nm-24Nm
6473380	3/8"	momentsleutel 19-110Nm
807316-18-20.6	3/8"	bougiedoppen 16-18-20.6mm
807325014M-8 07325016M	3/8"	magnetische bougiedop 14 mm-16 mm 250mmL

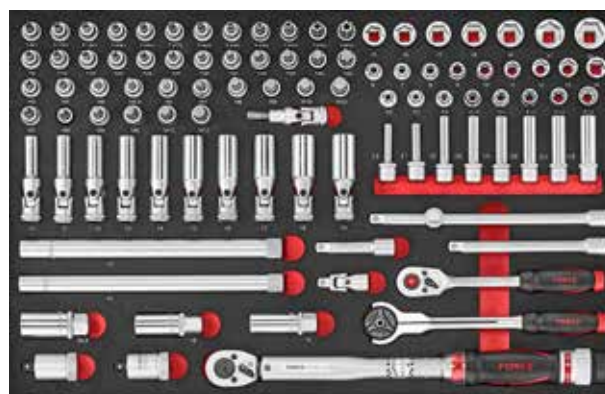

FOR F31751

1/4"-3/8" Kombinatieset 175 delig**Jeu de combinaison 1/4"-3/8" 175 pcs**

52504 t/m 52513	1/4"	4-4.5-5-5.5-6-7-8-9-10-11-12-13 mm (korte doppen - douilles)
5255006 t/m 13	1/4"	6-7-8-9-10-11-12-13 mm (lange doppen,douilles longues)
321320 t/m 323	1/4"	PH0-PH1-PH2-PH3
322320 t/m 323	1/4"	PZ0-PZ1-PZ2-PZ3
3233203 t/m 6.5	1/4	plat 3-4.-5.5 -6-6.5 mm
3243203 t/m 08	1/4"	inbus, hex 3-4-5-6-7-8mm
3263208 t/m 40	1/4"	torx T8-T10-T15-T20-T25-T27-T30-T40
3273208 t/m 40	1/4"	resistorx T8H-T10H-T15H-T20H-T25H-T27H-T30H-T40H
8042050-8042150	1/4"	verlengstuk 50mm-150mm
80521	1/4"	kniegewricht
8143	1/4"	spinner
8032115	1/4"	T hendel 115mm
80222	1/4"	ratel 24 tanden
802220	1/4"	T mini ratel
2331		security bit set 33 dlg
53508 t/m 22	3/8"	doppen 8-9-10-11-12-13-14-15-16-17-18-19-20-21-22 mm
53604 t/m 18	3/8"	torx doppen E4-E5-E6-E7-E8-E10-E11-E12-E14-E18
5365504 t/m 18	3/8"	torx doppen lang E4-E5-E6-E7-E8-E10-E11-E12-E14-E16-E18
		haakse XZN sleutels M5-M6-M8-M10-M12-M14-M16
		philips bit doppen PH.3-PH.4
		pozidriv bit doppen PZ.3-PZ.4
		platte bit doppen 5-5.5-6-6.5-7-8mm
80232	3/8"	ratel 24 tanden
802318		flexibele ratel 30 tanden
804375-150	3/8"	verlengstuk, rallonges 75 mm-150 mm
8033165	3/8"	T hendel 165mm
80531	3/8"	kniegewricht, cardan universele
807314 t/m 20.6	3/8	bougiedoppen 14-16-18-20.6mm
	50913	haakse 5-kant resistorx TS sleutels
		TS10-TS15-TS20-TS25-TS27-TS30-TS40-TS45-TS50

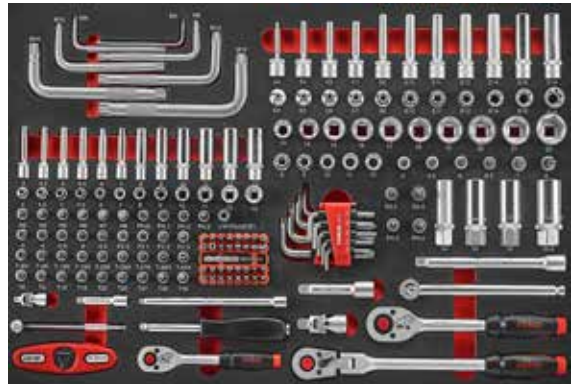

FOR F4451

1/2" Kombinatieset 45 delig 6kant
Jeu de combination 1/2" 45 pcs 6 pans

545 08....32	1/2"	douilles 8-9-10-11-12-13-14-15-16-17-18-19-20-21-22-23-24-26-27-28-30-32 mm
54577 10....32	1/2"	douilles longues 10-12-13-14-15-17-19-21-22-23-24-30-32 mm
80242	1/2"	ratel, cliquet
8044125..250	1/2"	2 verlengstukken, rallonges 125 mm-250 mm
8014380	1/2"	wringstaaf met kniestuk, manche flex
80541	1/2"	kniegewricht, cardan univeselle
8034250	1/2"	wringstaaf, manche en T
609ASC		borgveertang, pince circlips
609ABO		borgveertang, pince circlips
609ASO		borgveertang, pince circlips
609ABC		borgveertang, pince circlips



FOR F4882

1/4" - 3/8" - 1/2" doppenassortiment 88 delig 6kant
Jeu de douilles 88 pcs 1/4" - 3/8" - 1/2" 6 pans

525 3.2.....14	1/4"	3.2-4-4.5-5-5.5-6-7-8-9-10-11-12-13 mm (korte doppen)
52550 06....13	1/4"	6-7-8-10 mm (lange doppen, douilles longues)
8042050...150	1/4"	verlengstuk, rallonges 50 mm-100 mm-150 mm
802215	1/4"	ratel, cliquet
80521	1/4"	kniegewricht, cardan universelle
8032115	1/4"	wringstaaf, manche en T
8143	1/4"	steekhecht, manche tournevis
81225	1/4"	magneet, aimant
535 08...19	3/8"	8-9-10-11-12-13-14-15-16-17-18-19 mm
53563 08....14	3/8"	8-9-10-12-13-14 mm
802315	3/8"	ratel, cliquet
	3/8"	adapter voor verlengstuk
804375...150	3/8"	verlengstuk, rallonges 75 mm-150 mm
80531	3/8"	kniegewricht, cardan universelle
8033165	3/8"	Wringstaaf, manche en T
807314M	3/8"	bougiedop 14 mm magnetisch
807316M	3/8"	bougiedop 16 mm magnetisch
807318M	3/8"	bougiedop 18 mm magnetisch
807320.6M	3/8"	bougiedop 20.6 mm magnetisch
545 10...32	1/2"	10-11-12-13-14-15-16-17-18-19-20-21-22-23-24-26-27-28-30-32 mm
54577 13 ...32	1/2"	13-14-15-17-19-21-22-24-27-30-32 mm 77 mm L
802415	1/2"	ratel, cliquet
8044125 8044250	1/2"	verlengstukken, rallonges 125 mm-250 mm
80541	1/2"	kniegewricht, cardan universelle
80634	1/2"	adapter 3/8"*1/2"

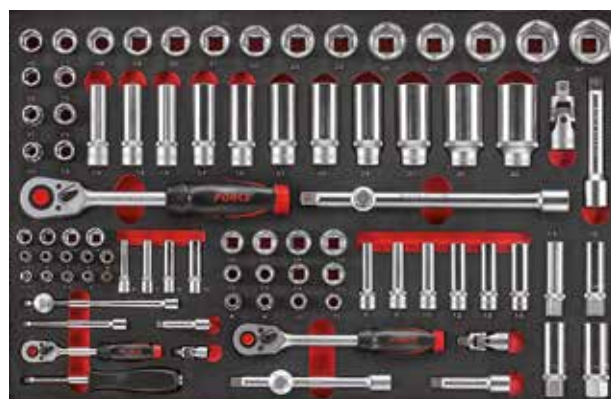

FOR F41041

Doppen torx assortiment 1/4"-3/8"-1/2" 104 delig
Jeu de douilles - torx 104 pcs 1/4" - 3/8" - 1/2"

526 4...10	1/4"	E4-E5-E6-E7-E8-E10
52650 04...10	1/4"	E4-E5-E6-E7-E8-E10 (50 mm L)
32632 08...30	1/4"	Torx op dop T8-T9-T10-T15-T20-T25-T27-T30
32F32 10...40	1/4"	Vijfkant TS10-TS15-TS20-TS25-TS27-TS30-TS40
80923	1/4"	Adapter 1/4"*3/8"
33F50 45-50	3/8"	vijfkant TS45-TS50
536 06...12	3/8"	E6-E8-E10-E12
546 11...24	1/2"	E11-E12-E14-E16-E18-E20-E22-E24
546577 11...24	1/2"	E11-E12-E14-E16-E18-E20-E22-E24 (77 mm L)
34655 40...70	1/2"	T40-T45-T47-T50-T55-T60-T70 (55 mm L)
3467080	1/2"	T80 (70 mm L)
346100 20...100	1/2"	T20-T25-T27-T30-T40-T45-T50-T55-T60-T70-T90-T100 (100 mm L)
34614060	1/2"	T60 (140 mm L)
34710055	1/2"	Resistorx T55 (100 mm L)
34710570	1/2"	Resistorx T70 (105 mm L)
34713030	1/2"	Resistorx T30 (130 mm L)
34714080	1/2"	Resistorx T80 (140 mm L)
80546 14...24	1/2"	Dop met kniegewricht E14-E16-E18-E20-E24
80943	1/2"	adapter 1/2*3/8
756 0608A...2024A		Torx sleutel 75° E6xE8-E10xE12-E14xE18-E20xE24
5098LT		Resistorx L sleutel T10H-T15H-T20H-T25H-T27H-T30H-T40H-T45H-T50H
50913		Vijfkant met gat TS10-TS15-TS20-TS25-TS27-TS30-TS40-TS45-TS50

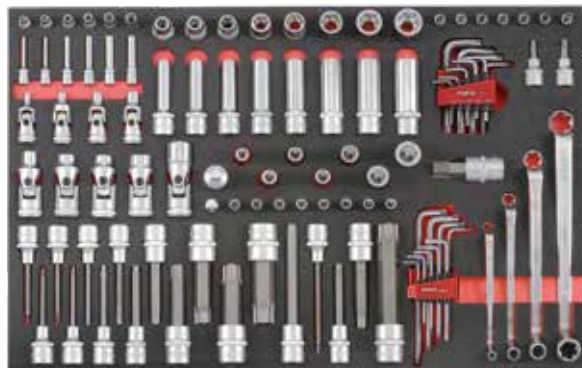

FOR F4642

Doppen - tangen assortiment 1/2" 64 delig
Jeu de douilles 64 pcs 1/2"

609ASC		circlipstang voor binnenringen, recht
609ASO		circlipstang voor buitenringen, recht
609ABC		circlipstang voor binnenringen, 90° gebogen
609ABO		circlipstang voor buienringen, 90° gebogen
34405504 tm 19	1/2"	inbus doppen 4-5-6-7-8-9-10-12-14-17-19mm
34410004 tm 14	1/2"	inbus doppen lang 4-5-6-7-8-10-11-12-14mm
3465520 tm 70	1/2"	T20-T25-T27-T30-T40-T45-T50-T55-T60-T70 (55 mm L)
346100 20...100	1/2"	T20-T25-T27-T30-T40-T45-T50-T55-T60-T70(100 mm L)
34805505 tm 18	1/2"	XZN kort M5-M6-M8-M9-M10-M12-M14-M16-M18
34810005 tm 18	1/2"	XZN lang M5-M6-M8-M9-M10-M12-M14-M16-M18
34805516T	1/2"	XZN M16 met gat voor VAG
34810016T	1/2"	XZN M16 met gat 100mmL voor VAG

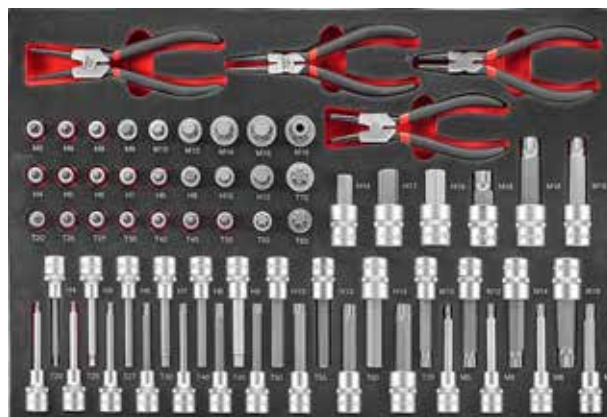

FOR F4686

1/2" doppenassortiment 68 delig 6kant
Jeu de douilles 68 pcs 1/2" 6 pans

54510 t/m 54532	1/2"	10-11-12-13-14-15-16-17-18-19-20-21-22-23-24-25-26-27-28-30-32 mm
5457710 t/m 32	1/2"	10-11-12-13-14-15-16-17-18-19-20-21-22-23-24-25-26-27-28-30-32 mm 77 mm L
54608 t/m 54624	1/2"	kort E8-E10-E11-E12-E14-E16-E18-E20-E22-E24
5467708 t/m 24	1/2"	lang E8-E10-E11-E12-E14-E16-E18-E20-E22-E24
80242	1/2"	ratel 24 tanden, cliquet
8044125 8044250	1/2"	verlengstukken, rallonges 125 mm-250 mm
80541	1/2"	kniegewricht, cardan universelle
80634	1/2"	adapter 3/8"*1/2"
8014380	1/2"	wringstaaf 380mmL

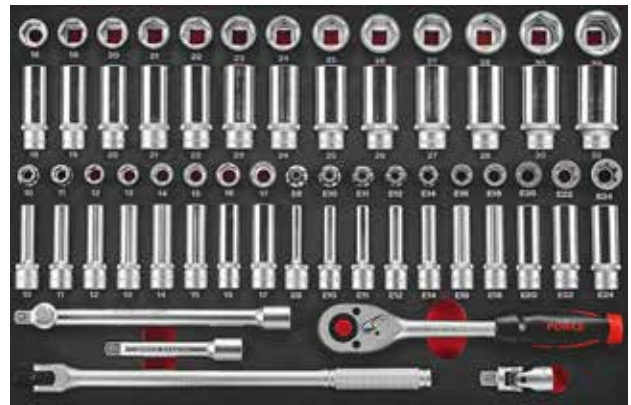

FOR F4702

1/2" slag doppenassortiment 47 delig 6kant
Jeu de douilles à chocs 47 pcs 1/2" 6 pans

44585810 t/m 4458532	1/2"	10-11-12-13-14-15-16-17-18-19-20-21-22-23-24-27-30-32 mm lange slagdoppen
4458517C	1/2"	alu velgen dop 17mm
4458519C	1/2"	alu velgen dop 19mm
4458521C	1/2"	alu velgen dop 21mm
24406004 tm 19	1/2"	inbus 4-5-6-7-8-10-12-14-17-19mm (60mmL)
24606020 tm 70	1/2"	torx T20-T25-T27-T30-T40-T45-T50-T55-T60-T70
24806008 tm 12	1/2"	M8-M10-M12 (60mmL)
24807814 tm 18	1/2"	M14-M16-M18 (78mmL)
8044125MPB	1/2"	verlengstuk 125mm
8044250MPB	1/2"	verlengstuk 250mm
80541MPB	1/2"	kogelgewricht
80934MPB		adapter 3/8" x 1/2"
80964MPB		adapter 3/4" x 1/2"



FOR F5351

Sleutelset 35 delig
Jeu de clés 35 pcs

755 06...32	6-7-8-9-10-11-12-13-14-15-16-17-18-19-21-22-23-24-26-27-28-30-32 mm steekring - clés mixtes
759 0607...3032	6x7-8x9-10x11-12x13-14x15-16x17-18x19-21x22-23x26-24x27-25x28-30x32 mm, polygonales



FOR F5421

Sleutelset 42 delig
Jeu de clés 42 pcs

755 06....23	6-7-8-9-10-11-12-13-14-15-16-17-18-19-20-21-22-23 mm
754 0607....3032	6x7-8x9-10x11-12x13-14x15-16x17-18x19-20x22-21x23-24x27-30x32 mm
758 0809....2224	8x9-10x11-12x13-14x15-16x17-18x19-21x23-22x24 mm
751 0911....1719	9x11-x10x12-12x14-14x17-17x19 mm open ring

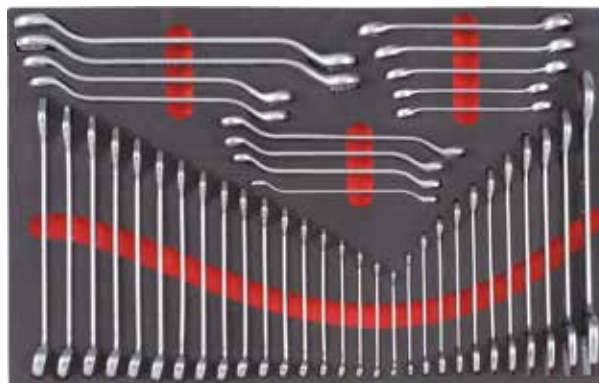

FOR F5361

Sleutelset 36 delig
Jeu de clés 36 pcs

75506...32	6-7-8-9-10-11-12-13-14-15-16-17-18-19-21-22-23-24-26-27-28-30-32 mm steerkingsleutel - clés mixtes
7590607...3032	6x7-8x9-10x11-12x13-14x15-16x17-18x19-21x22-23x26-24x27-25x28-30x32 mm gebogen ring



FOR F5363

Sleutelset 36 delig
Jeu de clés 36 pcs

75506 t/m 75524	steekringsleutels - clés mixtes 6-7-8-9-10-11-12-13-14-15-16-17-18-19-20-21-22-24mm
7590607 t/m 7592123	gebogen ringsleutels 6x7-8x9-10x11-12x13-14x15-16x17-18x19-20x22-21x23mm
7540607 t/m 7542123	steeksleutels 6x7-8x9-10x11-12x13-14x15-16x17-18x19-20x22-21x23mm

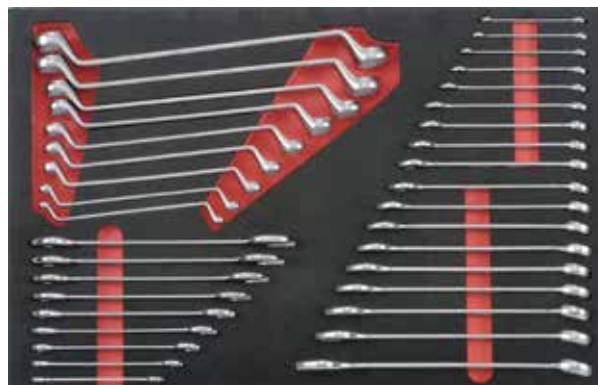

FOR F5367

Sleutelset 36 delig
Jeu de clés 36 pcs

75708 t/m 75719	steek-ratelsleutels omkeerbaar 8-9-10-11-12-13-14-15-16-17-18-19mm
75508S t/m 75519S	mini steekringsleutels 8-9-10-11-12-13-14-15-16-17-18-19mm
7510810 t/m 7511719	open ringsleutels 8x10-9x11-12x13-14x15-16x18-17x19mm
7610810 t/m 7611719	halve maansleutels 8x10-11x13-12x14-13x15-16x18-17x19mm

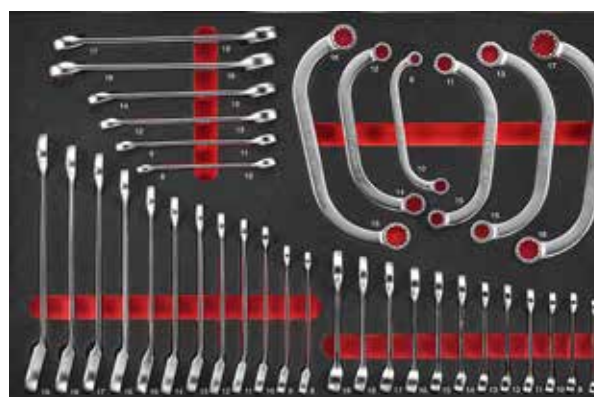

FOR F5168

Sleutelset 16 delig
Jeu de clés 36 pcs

7510810 t/m 7511419	open ringsleutels 8x10-9x11-11x13-12x14-14x19mm
7610810 t/m 7611719	halve maansleutels 8x10-11x13-12x14-13x15-16x18-17x19mm
7600810 t/m 7601719	dubbele ringsleutels 8x10-12x14-13x15-14x17-16x18-17x19mm

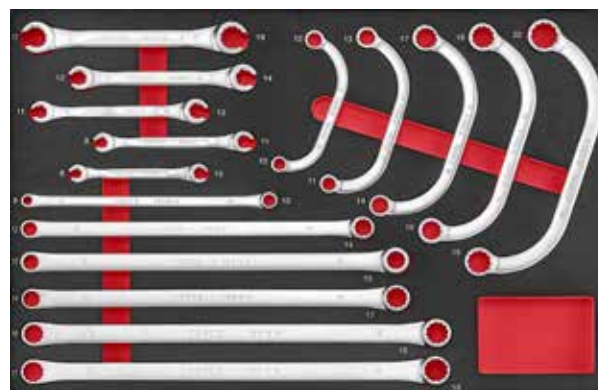

FOR F5182

Beitel & hamerset 18 delig
Burins & marteaux 18 pcs

602 12150Q...22200Q	beitels, burins 12-15-19-22 mm
603150q	kapbeitel, bédane
604 2140Q...8215Q	doorslagen, chasse-goupilles 2-3-4-5-6-8 mm
6066185Q	puntslag, pointeau 6 (185 mm L)
6076185Q	centerpunt, pointeau 6 (185 mm L)
5055P1	schaar, ciseau
5055P4	cuttermes, couteau universel
616300	hamer, marteau 300 gr
616400	rubber hamer, marteau caoutchouc 400 gr
66303	zaag, scie



FOR F5186

Assortiment vijlen en acc. 18 delig
Jeu de limes & acc. 18 pcs

5056P1	platte vijl - lime plat
5056P2	halfronde vijl - lime demi ronde
5056P3	ronde vijl - lime ronde
5056P4	vierkantsvijl - lime carré
5056P5	driehoeksvijl - lime triangle
5055p4	universeel mes - couteau universel
66303	mini zaag - scie
6981250	alles snijder - cutter à lame
5056P1	schuifmlaat - pied à coulisse
5096P4	hoekmeter - rapporteur inox
9U3003	stalen borstel
5096P7	stalen kraspen - pointe à tracer
5096P8	meter 5 m - mètre à ruban
5096P2	center punt - pointeau
5096P5	voelmaatjes - jauge d'épaisseur mm
5096P6	voelmaatjes Inch - jauge d'épaisseur inch
5096P3	liniaal 30cm, règle métal



FOR F4175

Slagmoerset 1/2" - 17 delig

Jeu de douilles à choc 1/2" - 17 pcs

445 13...24	slagdoppen, douilles à chocs 1/2" 13-14-15-16 17-18-19-21-22-24 mm
44585 17...21C	alu doppen 1/2" 17-19-21 mm, jantes
6474535	1/2" momentsleutel, clé dynamométrique 40-210nw
825A41	slagmoersleutel op batterij + lader
6821	wielgewichttang, pince pour masses



FOR F2195

Inbussleutelset - dop op handvat 19 delig

Jeu de douilles à poignée en T & clés hex 19 delig

744300 05...13	5-6-7-8-9-10-11-12-13 mm (300 mm L)
765 2G...12G	inbus 2-2.5-3-4-5-6-7-8-10-12 mm

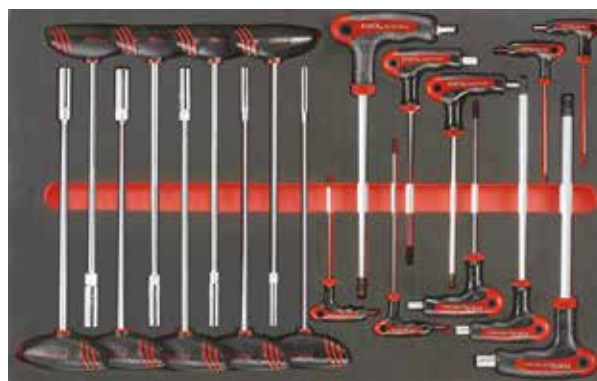

FOR F6213

Doppenset 3/4" - 21 delig 6kant

Set de douilles 6 pans 3/4" - 21 pcs

565 19...50	19-21-22-23-24-26-27-29-30-32-35-36-38-41-46- 50mm
8046100	verlengstuk, rallonge 100 mm
8046200	verlengstuk, rallonge 200 mm
8026820	ratel, cliquet 500 mm
80968	adapter, reducteur



Foam - mousse 10323 - 10318 Jumbo

JUMBO

FOR F2452 - Jumbo

Schroevendraaierset 45 delig
Jeu de tournevis 45 pcs

7111S-7112S	PH1-PH2 (25 mm L)
7110 - 7111	PH0 (60 mm L) - PH1 (60 mm L)
7112 - 7113	PH2 (100 mm L) - PH3 (150 mm L)
713055S - 713065S	5.5 mm (25 mm L)-6.5 mm (25 mm L)
71303-713035	3 mm (75 mm L) - 3.5 mm (100 mm L)
71304-713055	4 mm (100 mm L) - 5.5 mm (125 mm)
713065-71308	6.5 mm (150 mm L) - 8 mm (175 mm L)
655306 - 65512	6 mm extra lang 400 mm - PH2 extra lang 450 mm
716 05...45	T5-T6-T7-T8-T10-T15-T20-T25-T27-T30-T40-T45 torx schroevendraaiers
767 06 ...60	T6H-T7H-T8H-T9H-T10H-T15H-T20H-T25H-T27H-T30H- T40H-T45H-T50H-T55H-T60H resistorx L sleutels (FOR 5151T)
88601	magnetiseur-demagnetiseur



FOR F2335 - Jumbo

Schroevendraaierset 33 delig
Jeu de tournevis 33 pcs

7111S-7112S	PH1-PH2 (25 mm L)
7110 - 7111	PH0 (60 mm L) - PH1 (60 mm L)
7112 - 7113	PH2 (100 mm L) - PH3 (150 mm L)
713055S-713065S	5.5 mm (25 mm L)-6.5 mm (25 mm L)
71303-713035	3 mm (75 mm L) - 3.5 mm (100 mm L)
71304-713055	4 mm (100 mm L) - 5.5 mm (125 mm)
713065-71308	6.5 mm (150 mm L) - 8 mm (175 mm L)
88601	magnetiseur-demagnitiseur
716 05...45 torx	T5-T6-T7-T8-T10-T15-T20-T25-T27-T30-T40-T45
905M2P1 ... 905M2P5	5 clipsverwijderaars, grattoirs et crochets

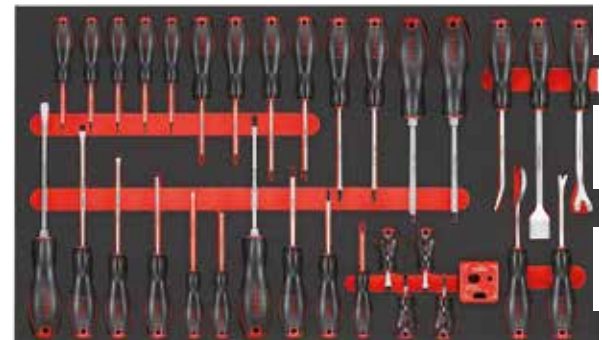

FOR F2592 - Jumbo

Schroevendraaierset 59 delig
Jeu de tournevis 59 pcs

7111S-7112S	PH1-PH2 (25 mm L)
7110 - 7111	PH0 (60 mm L) - PH1 (60 mm L)
7112 - 7113	PH2 (100 mm L) - PH3 (150 mm L)
713055S-713065S	5.5 mm (25 mm L)-6.5 mm (25 mm L)
71303-713035	3 mm (75 mm L) - 3.5 mm (100 mm L)
71304-713055	4 mm (100 mm L) - 5.5 mm (125 mm)
713065-71308	6.5 mm - 8 mm
71310M - 71312M	10-12mm hamer schroevendraaiers
88601	magnetiseur-demagnitiseur
716 05...45 torx	T5-T6-T7-T8-T10-T15-T20-T25-T27-T30-T40-T45
765 015XL...12XL	Haakse XL kogelinbus sleutels 1.5-2-2.5-3-4-5-6-7-8- 10-12 mm (FOR 5116XLB)
767 10XL...50XL	Haakse XL resistorx sleutels T10H-T15H-T20H-T25H- T27H-T30H-T40H-T45H-T50H (FOR 5098XLT)
76F 10...50	Haakse 5-kant Resistorx TS sleutels TS10-TS15-TS20- TS25-TS27-TS30-TS40-TS45-S50 (FOR 50913)

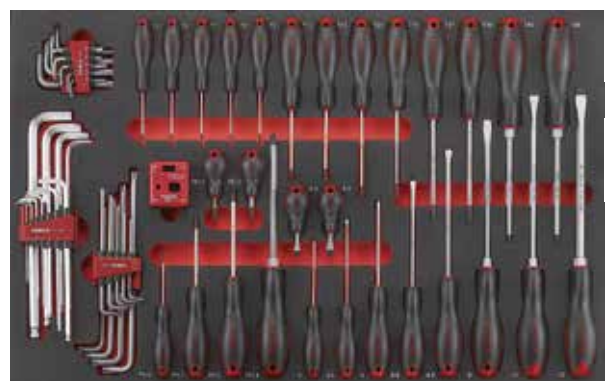

FOR F21251 - Jumbo

Doppen 1/4" & tangenset 125 delig 6kant
Set racagnac, douilles 1/4" & de pinces 125 pcs 6 pans

525 032....13	1/4" 3-2-4-4.5-5-5.5-6-7-8-9-10-11-12-13 mm
5255 004...13	1/4" 4-4.5-5-5.5-6-7-8-9-10-11-12-13 mm (55mmL)
52604...10	1/4" E4-E5-E6-E7-E8-E10 korte inwendig torx
5265 04...10	1/4" E4-E5-E6-E7-E8-E10 lang inwendig torx
321 320...323	1/4" PH0-PH1-PH2-PH3
322 320...323	1/4" PZ0-PZ1-PZ2-PZ3
323 32 04...32065	1/4" plat 4-5.5-6.5 mm
324 32 04...10	1/4" inbus 3-4-5-6-7-8-10 mm
326 32 08...10	1/4" torx T8-T10-T15-T20-T25-T27-T30-T40
327 32 08...40	1/4" resistorx T8H-T10H-T15H-T20H-T25H-T27H-T30H-T40H
32F3210....40	TS10-TS15-TS20-TS25-TS27-TS30-TS40
5116L	inbus L sleutel set, clés mâles
765 01.5L....765 012L	1.5-2-2.5-3-4-5-6-7-8-10-12 mm



802223	1/4" ratel, cliquet
802215	1/4" ratel, cliquet
802220	1/4" mini ratel, cliquet mini
8032115	1/4" wringstaaf, manche en T
81225	1/4" magneet pick up, aiment
8143	steekhecht, manche tournevis
8111	flexibel verlengstuk, rallonge flex
8042 50-100-150-250	1/4" verlengstuk, rallonge 50-100-150-250 mm
80521	1/4" kniegewricht, cardan universelle
6472300W	1/4" momentsleutel, clé dynamom. 6-30nw
6472150	1/4" momentsleutel, clé dynamom.
50814P1 tot P8	8 mini tangen, 8 pince mini
	schaar/pincet/precisiemes
11 precisie schroev.	PH000-PH00 plat 1.0-1.2-1.5-1.8-2.0-2.4 mm
	inbus, hex 0.9-1.3-1.5 mm

FOR F32031 - Jumbo

Kombinatieset 1/4" - 3/8" 203 delig 6kant

Jeu de douilles 1/4" - 3/8" 203 pcs 6 pans

525 032....13	1/4" 4-4.5-5-5.5-6-7-8-9-10-11-12-13 mm
5255 004...13	1/4" 4-4.5-5-5.5-6-7-8-9-10-11-12-13 mm (55mmL)
321 320...323	1/4" PH0-PH1-PH2-PH3
322 320...323	1/4" PZ0-PZ1-PZ2-PZ3
323 32 03...065	1/4" plat 3-4-5-5-6-6.5 mm
324 32 04...10	1/4" inbus 3-4-5-6-7-8-9-10 mm
326 32 08...10	1/4" torx T8-T9-T10-T15-T20-T25-T27-T30-T40
327 32 08...40	1/4" resistorx T8H-T9H-T10H-T15H-T20H-T25H-T27H-T30H-T40H
32F3210....40	1/4" TS10-TS15-TS20-TS25-TS27-TS30-TS40
8012140	1/4" Schuifbar 140mmL - poignée articulée
80222	1/4" Ratel, cliquet
8032115	1/4" Wringstaaf met schuifstuk 115mmL - Poignée coulissante
8042050-8042150	1/4" Verlengstuk 50-150mm - Rallonges
80521	1/4" Kniegewricht - cardan
8092225	Bit adapter 1/4" x 1/4"
80932	Adapter 3/8" x 1/4", reducteur
81022	Bit houder 1/4" x 1/4", porte embouts
8111	1/4" Flexibel verlengstuk
8143	Steekhecht 1/4" - manche tournevis
331503 -331504	3/8" Philips bit PH3 - PH4
332503-332504	3/8" Pozidriv bit PZ3-PZ4
333 50 05.....65	3/8" Platte bit 5-5.5-6-6.5-7-8
33F5045...33F5050	3/8" Vijf ster resistorx TS45-TS50
535 08....22	3/8" 8-9-10-11-12-13-14-15-16-17-18-19-20-21-22mm
536 04...18	3/8" E4-E5-E6-E7-E8-E10-E11-E12-E14-E16-E18 torx doppen
53655 04...18	3/8" E4-E5-E6-E7-E8-E10-E11-E12-E14-E16-E18 lange torx doppen
8013215	3/8" Wringstaaf met kniegewricht 215mmL
80232	3/8" Ratel, cliquet
8033165	3/8" Wringstaaf met schuifstuk 165mmL
8043075-8043150	3/8" Verlengstuk 75mm-150mm
80531	3/8" Kniegewricht - cardan universelle
8073 14...20.6	3/8" Bougiedop 14-16-18-20.6mm
80923	Adapter 1/4" x 3/8", reducteur
80943	Adapter 1/2" x 3/8", reducteur
7111M-7112M-7113M	Philips hamer schroevendraaierPH1-PH2-PH3
713 055M...12M	platte hamer schroevendraaier 5.5-6.5-8-10-12mm
5098XL	9dlg torx L sleutels T10-T15-T20-T25-T27-T30-T40-T45-T50
2331A	1/4" Bit set 33dlg
5116XLB 765 01.5XL....765 012XL	inbus L sleutel set 1.5-2-2.5-3-4-5-6-7-8-10-12 mm

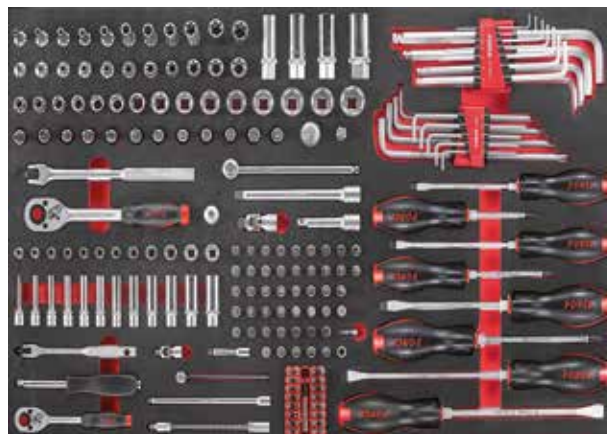

FOR F31921A- Jumbo

Doppen 1/4"-3/8" kombinatieset 192 delig 6-12 kant
Set 1/4" - 3/8" 192 pcs 6-12 pans

JUMBO

525 04...13	1/4" 4-4.5-5-5.5-6-7-8-9-10-11-12-13 mm
5255 004...13	1/4" 4-4.5-5-5.5-6-7-8-9-10-11-12-13 mm (55mmL)
5260 4...10	E4-E5-E6-E7-E8-E10 korte inwendig torx
5265 04...10	E4-E5-E6-E7-E8-E10 lang inwendig torx
321 320...323	1/4" PH0-PH1-PH2-PH3
322 320...323	1/4" PZ0-PZ1-PZ2-PZ3
323 32 03...32065	1/4" plat 3-4-5-5-6.5 mm
324 32 04...08	1/4" inbus 3-4-5-6-7-8mm
326 32 08...10	1/4" torx T8-T9-T10-T15-T20-T25-T27-T30-T40
327 32 08...40	1/4" resistorx T8H-T9H-T10H-T15H-T20H-T25H-T27H-T30H-T40H
32F3210....40	TS10-TS15-TS20-TS25-TS27-TS30-TS40

80222	1/4" ratel, cliquet
802220	1/4" mini ratel, cliquet mini
6472270	1/4" momentsleutel 5-25nw
64721608	1/4" momentsleutel 1-8Nm
8032115	1/4" wringstaaf, manche en T
8012140	1/4" wringstaaf met kniegewricht
81022	bithouder 1/4" x 1/4"
8143	steekhecht, manche tournevis
8042 50-150	1/4" verlengstuk, rallonge 50-150 mm
80521	kniegewricht, cardan universelle
2331	security bitset 33dlg
haakse XZN sleutels	M5-M6-M8-M10-M12-M14-M16, clés mâles XZN
539 08...22	3/8" doppen 8-9-10-11-12-13-14-15-16-17-18-19-20-21-22mm (12kant)
5356310....19	3/8" 10-11-12-13-14-15-16-17-18-19mm lange doppen
536 04...18	3/8" torx E4-E5-E6-E7-E8-E10-E11-E12-E14-E16-E18
53655 04...18	3/8" torx L E4-E5-E6-E7-E8-E10-E11-E12-E14-E16-E18 (55mmL)
331503 331504	3/8" PH3-PH4
332503 332504	3/8" PZ3-PZ4
333500 5....8	3/8" 5-5.5-6-6.5-7-8mm
80232	3/8" ratel 24t, cliquet
802318	3/8" flexibele ratel 30t, cliquet
6473365	3/8" momentsleutel 19 -210nw
8013215	3/8" wringijzer 215mm, manche en T
8043075-8043150	3/8" verlengstukken, rallonges 75-150mm
8033165	3/8" T hendel, manche en T
80521	3/8" kniegewricht, cardan universelle
8073 14...20.6	3/8" bougiedoppen 14-16-18-20.6MM
8073250 14 - 16	3/8" bougiedoppen 14-16mm (250mmL)

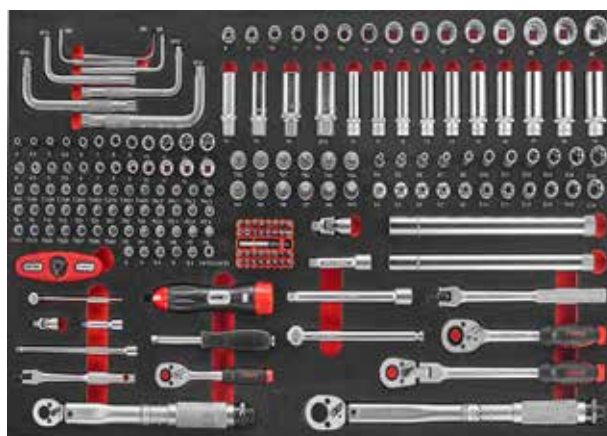

FOR F41621 - Jumbo

Kombinatieset 1/4"-3/8"-1/2" 162 delig 6kant
Set 1/4"-3/8"-1/2" 162 pcs 6 pans

JUMBO

525 3.2...14	1/4" doppen 3.2-4-4.5-5-5.5-6-7-8-9-10-11-12-13-14 m
525500 06...13	1/4" doppen lang 6-7-8-9-10-11-12-13 mm
526 04...10	1/4" inwendig torx E4-E5-E6-E7-E8-E10
321 320...323	1/4" PH0-PH1-PH2-PH3
322 320...323	1/4" PZ0-PZ1-PZ1*PZ3
323 3204...065	1/4" plat 3-4-5.5-6.5 mm
324 3203...10	1/4" inbus 3-4-5-6-7-8-9-10 mm
326 3208...40	1/4" torx T8-T10-T15-T20-T25-T27-T30-T35-T40
327 3208.... 40	1/4" resistorx T8H-T10H-T15H-T20H-T25H-T27H-T30H-T35H-T40H
802215	1/4" ratel, cliquet
802220	1/4" ratel mini, cliquet
8032115	1/4" wringstaaf
8042050 - 8042100	1/4" verlengstuk 50 + 100 mm
8111	1/4" flexibel verlengstuk, rallonge flexible
8143	1/4" steekhecht, mache tournevis
80521	1/4" kniegewricht, cardan
81225	1/4" magneet, aimant
535 06...24	3/8" doppen 6-7-8-9-10-11-12-13-14-15-16-17-18-19-20-21-22-23-24 mm
53563 08...14	3/8" lange doppen 8-9-10-12-13-14 mm
802315	3/8" ratel, cliquet
802318	3/8" flexibele ratel, cliquet flexible
8043075 - 8043150	3/8" verlengstuk, rallonge 75 mm & 150 mm
8043044W	3/8" verlengstuk, rallonge 44 mm
80531	3/8" kniegewricht, cardan
80643	adapter voor verlengstuk 1/2" x 3/8"
807314	3/8" bougie dop 14 mm
807316	3/8" bougie dop 16 mm
807318	3/8" bougie dop 18 mm
807320.6	3/8" bougie dop 20.6 mm
3385005....12	3/8" XZN (12k) M5-M6-M8-M9-M10-M12
545 10....32	1/2" 10-11-12-13-14-15-16-17-18-19-21-22-23-24-27-30-32 mm (douilles)
54577 14....32	1/2" 14-15-17-19-22-24 mm (douilles longues)
546 10....24	1/2" E10-E12-E14-E16-E18-E20-E22-E24 (kort)
802415	1/2" ratel, cliquet 36t
80541	1/2" kniegewricht, cardan universel
80634	adapter voor verlengstuk 3/8" x 1/2"
8044 125-250	1/2" 2 verlengst, rallonges 125 mm-250 mm
81047	bithouder 1/2" * 10 mm porte embouts
5102LB	1.27-1.5-2-2.5-3-4-5-6-8-10 mm, clés mâles

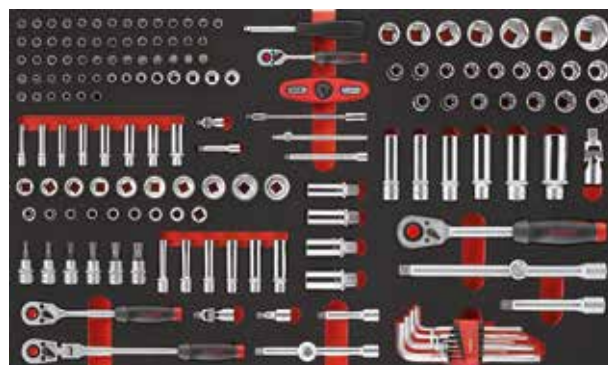

FOR F41062- Jumbo

Kombinatieset 1/2" 106 delig 6kant
Jeu de combination 1/2" 106 pcs 6 pans

JUMBO

545 10....32	10-11-12-13-14-15-16-17-18-19-20-21-22-23-24-26-27-28-30-32 mm (douilles)
54577 10....32	10-11-12-13-14-15-16-17-18-19-20-21-22-23-24-26-27-28-30-32 mm (77mmL)
546 08....24	E8-E10-E11-E12-E14-E16-E18-E20-E22-E24 (kort)
344055 05...19	1/2" Inbus dop 5-6-7-8-9-10-12-14-17-19mm (55mmL)
346055 27...70	1/2 Torx dop T27-T30-T40-T45-T50-T55-T60-T70
347055 27...70	1/2" Resistorx T27H-T30H-T40H-T45H-T50H-T55H-T60H-T70H (55mmL)
348100 05...18	1/2" XZN M5-M6-M7-M8-M9-M10-M12-M14-M16-M18-M16T (100mmL)
349100 05...14	1/2" Ribe dop M5-M6-M7-M8-M9-M10-M12-M13-M14 (100mmL)
8014380	1/2" Wringstaaf met kniegewricht 380mmL
80242	1/2" Ratel, cliquet
8034250	1/2" Wringstaaf met kniegewricht 250mmL
8044125-8044250	1/2" Verlengstuk 125mm-250mm rallonge
80541	1/2" Kniegewricht - cardan
80934	Adapter 3/8" x 1/2", reducteur
80964	Adapter 3/4" x 1/2", reducteur

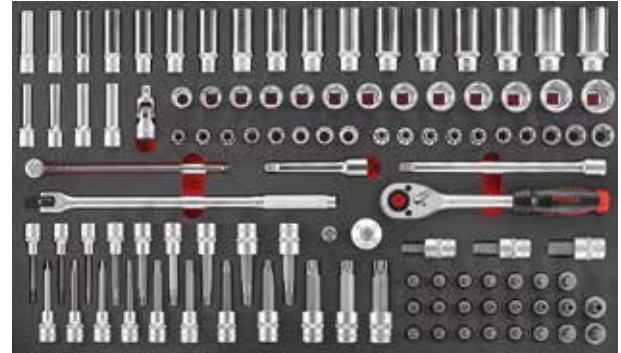

FOR F41491 - Jumbo

Kombinatieset 1/2" 149 delig 6kant
Jeu de combination 1/2" 149 pcs 6kans

JUMBO

54510 t/m 54532	10-11-12-13-14-15-16-17-18-19-20-21-22-23-24-26-27-28-30-32 mm (douilles)
54577 10 t/m 32	10-11-12-13-14-15-16-17-18-19-20-21-22-23-24-26-27-28-30-32 mm (77mmL)
546 10 t/m 24	E10-E11-E12-E14-E16-E18-E20-E22-E24 (kort)
546 77 04 t/m 24	E10-E11-E12-E14-E16-E18-E20-E24 (lang)
174 30 04...12	4-5-6-7-8-10-12 mm (30mmL inbus)
174 75 04...12	4-5-6-7-8-10-12 mm (75mmL inbus)
176 30 20...60	T20-T25-T27-T30-T40-T45-T50-T55-T60 (30 mmL)
176 75 20...60	T20-T25-T27-T30-T40-T45-T50-T55-T60 (75 mmL)
176 120 40...55	T40-T45-T50-T55 (120 mmL)
177 30 20...60	T20H-T25H-T27H-T30H-T40H-T45H-T50H-T55H-T60H (L30 mm) resistorx
177 75 20...60	T20H-T25H-T27H-T30H-T40H-T45H-T50H-T55H-T60H (L75 mm) resistorx
178 30 05...12	M5-M6-M8-M10-M12 (30 mmL) XZN
178 75 05...12	M5-M6-M8-M10-M12 (75 mmL) XZN
179 30 04...14	M4-M5-M6-M8-M9-M10-M12-M13-M14 (30mmL) ribe
179 75 04...14	M4-M5-M6-M8-M9-M10-M12-M13-M14 (75mmL) ribe
802415	ratel, cliquet 36t
80541	kniegewricht, cardan universeel
8034250	wringstaaf, manche en T
8044 075-125-250	3 verlengstukken, rallonges 75 mm-125 mm-250 mm
81047	bithouder 1/2" * 10 mm porte embouts



FOR F41162 - Jumbo

Kombinatieset 3/8" - 1/2" 116 delig 6kant
Jeu de combination 3/8" - 1/2" 116 pcs 6kans

545 10....32	10-11-12-13-14-15-16-17-18-19-20-21-22-23-24--25-26-27-28-30-32 mm (douilles)
54577 10....32	14-15-16-17-18-19-20-21-22-23-24-25-26-27-28-30-32 mm (77mmL)
546 10....24	E8-E10-E11-E12-E14-E16-E18-E20-E22-E24
344050 05...19	5-6-4-8-9-10-12-14-17mm (50mmL) inbus
344100 05...14	5-6-7-8-9-10-12-14mm (100mmL) inbus
346055 27...70	T27-T30-T40-T45-T50-T55-T60-T70 (55mmL)
346100 27...70	T27-T30-T40-T45-T50-T55-T60-T70 (100mmL)
347055 30...70	T30H-T40H-T45H-T50H-T55H-T60H-T70H (55mmL) resistorx
348055 05...18	M5-M6-M8-M9-M10-M12-M14-M16-M18 (55mmL) XZN
348100 05...18	M5-M6-M8-M9-M10-M12-M14-M18 (100mmL) XZN
34805516T	M16 met gat (55mmL) voor VAG
34810016T	M16 met gat (100mmL) voor VAG
8014380	schuifbar 380mmL
80242	ratel, cliquet 24t
80541	kniegewricht, cardan universeel
80634	adapter voor verlengstuk 250mm
8044125	verlengstuk 125mm, rallonge
8044250	verlengstuk 250mm, rallonge

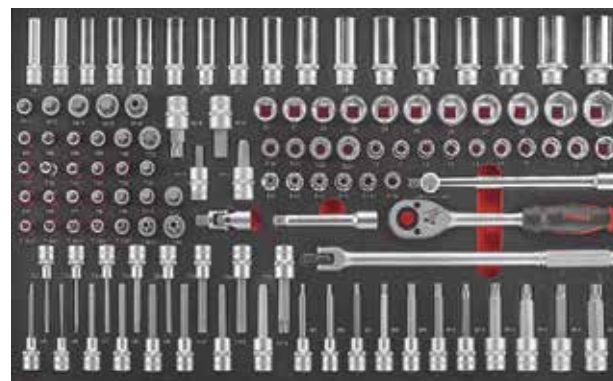

FOR F4491 - Jumbo

Slagmoerset 1/2" 49 delig 6kant
Jeu de douilles à chocs & acc. 1/2" 49 pcs 6pans

JUMBO

445 10...32	1/2" 10-11-12-13-14-15-16-17-18-19-20-21-22-23-24-26-27-28-30-32 mm korte slagdoppen
44585 10...32	1/2" 10-11-12-13-14-15-16-17-18-19-20-21-22-23-24-26-27-28-30-32 mm (85mmL)
445 85 17...21C	1/2" 17-19-21 mm alu doppen, douilles à chocs
8044125MPP	verlengstuk, rallonge 125 mm
80541MPP	1/2" kniegewricht, cardan universeel
681A300	wielsleutel 17-19-13/16" -1/2", clé à croix pliable
6474530W	1/2" momentsleutel, clé dynamometrique
6821	wielgewichttang
82544	slagmoersleutel, clé à chocs 1/2"



FOR F4891 - Jumbo

Slagmoerset 1/2" 89 delig
Jeu de douilles à chocs & acc. 1/2" 89 pcs

445 10...36	1/2" kort 8-10-11-12-13-14-15-16-17-18-19-20-21-22-23-24-26-27-28-30-32-33-34-35-36 mm
44585 10...36	1/2" longues 8-10-11-12-13-14-15-16-17-18-19-20-21-22-23-24-26-27-28-30-32-33-34-35-36 mm (85mmL)
445 85 17...21C	1/2" 17-19-21 mm alu velg doppen, douilles à chocs
8044125MPP	1/2" verlengstuk, rallonge 125 mm
24406004....19	1/2" inbus 4-5-6-7-8-10-12-14-17-19mm (60mm)
24606020....70	1/2" torx T20-T25-T27-T30-T40-T45-T50-T55-T60-T70 (60mmL)
24806008...12	1/2" XZN M8-M10-12 (60mmL)
24807814....18	1/2" XZN M14-M16-M18 (78mmL)
80541MPP	1/2" kniegewricht, cardan universeel
8044125MPP	verlengstuk, rallonge 125mm
8044250MPP	verlengstuk, rallonge 250mm
80934MPB	adapter 3/8" x 1/2", reducteur
80964MPB	adapter 3/4" x 1/2", reducteur
6474470	1/2" momentsleutel 42-210 Nm, clé dynamométrique



FOR F41001 - Jumbo

Slagmoerdoppenset 1/2" 100 delig 6kant
Jeu de douilles à chocs & acc. 1/2" 100 pcs 6 pans

JUMBO

445 10...32	kort 8-9-10-11-12-13-14-15-16-17-18-19-20-21-22-23-24-25-26-27-28-29-30-32 mm
44585 08...32	lang 8-9-10-11-12-13-14-15-16-17-18-19-20-21-22-23-24-25-26-27-28-29-30-32 mm (85mmL)
445 85 17...24C	17-19-21-22-24 mm alu doppen, douilles à chocs
244060 04.... 24	inbus 4-5-6-7-8-10-12-14-16-17-19-21-22-24mm (60mm)
246060 20....70	torx T20-T25-T27-T30-T40-T45-T50-T55-T60-T70 (60mmL)
248060 08....12	XZN M8-M10-12 (60mmL)
248078 14...18	XZN M14-M16-M18 (78mmL)
80541MPP	1/2" kniegewricht, cardan universeel
8044125MPP	verlengstuk, rallonge 125mm
8044250MPP	verlengstuk, rallonge 250mm
80934MPB	adapter 3/8" x 1/2", reducteur
80964MPB	adapter 3/4" x 1/2", reducteur



FOR F6431 - Jumbo

Slagdoppenset 3/4" 43 delig
Jeu de douilles à choc 3/4" 43 pcs

465 100 17...46	3/4" lange doppen 17-19-21-22-23-24-27-28-30-32-33-34-35-36-38-41-46mm (100mmL)
465 17...46	3/4" korte doppen 17-19-21-22-23-24-27-28-30-32-33-34-35-36-38-41-46mm
466 110 18...24	3/4" Torx doppen E18-E20-E22-E24
8046175MPB	3/4" Verlengstuk 175mmL, rallonge
8046250MPB	3/4" Verlengstuk 250mmL, rallonge
80561MPB	3/4" Kniegewricht - cardan
80946MPB	Adapter 1/2" x 3/4"
80986MPB	Adapter 1" x 3/4"



FOR F6342 - Jumbo

Kombinatieset 3/4" 34 delig 6-12kant
Jeu de combination 3/4" 34 pcs 6-12 pans

364080 14...22	3/4" Inbus dop 14-16-17-19-22mm (80mmL)
366080 60....100	3/4" Torx dop T60-T70-T80-T90-T100 (80mmL)
569 17...50	3/4" Doppen 12kant 17-19-21-22-23-24-27-30-32-33-34-35-36-38-41-46-50mm
8026500	3/4" Ratel, cliquet
8036500	3/4" Wringstaaf met schuifstuk 500mmL
8046200	3/4" Verlengstuk 200mmL - rallonge
8046400	3/4" Verlengstuk 400mmL - rallonge
80946	Adapter 1/2" x 3/4" , reducteur
80986	Adapter 1" x 3/4" , reducteur
8156450	3/4" L hendel 450mmL



FOR F5481 - Jumbo

Sleutelset 48 delig
Jeu de clés 48 pcs

755 06...32	6-7-8-9-10-11-12-13-14-15-16-17-18-19-21-22-23-24-26-27-28-30-32 mm steekringsleutels - clés mixtes
759 0607....3032	6x7-8x9-10x11-12x13-14x15-16x17-18x19-21x23-20x22-23x26-24x27-25x28-30x32 mm gebogen ringsleutels - clés polygonales
757 08F...19F	8-9-10-11-12-13-14-15-16-17-18-19 mm flexible ratelsleutels - clés mixte à cliquet flexible

JUMBO

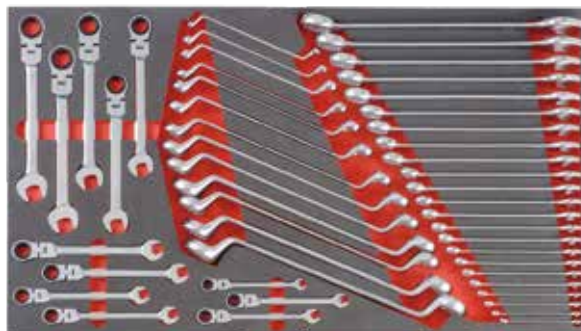

FOR F5505 - Jumbo

Sleutelset 50 delig
Jeu de clés 50 pcs

755 06...32	6-7-8-9-10-11-12-13-14-15-16-17-18-19-20-21-22-23-24-25-26-27-28-30-32 mm steekring, clés mixtes
759 0607....3032	6x7-8x9-10x11-12x13-14x15-16x17-18x19-20x22-21x23-24x27-25x28-30x32 mm gebogen ringsleutels - clés polygonales
754 0607...3032	6x7-8x9-10x11-12x13-14x15-16x17-18x19-20x22-21x23-24x27-25x28-30x32 mm steeksleutels - clés à fourche

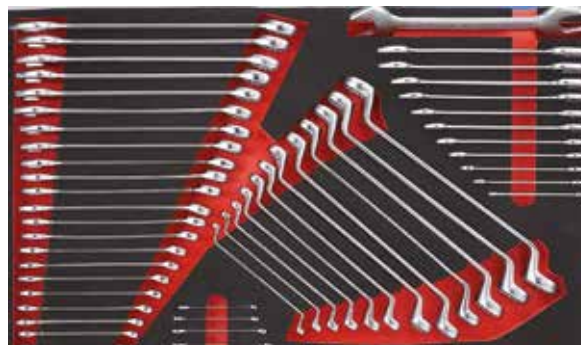

FOR F5461 - Jumbo

Sleutelset 46 delig
Jeu de clés 46 pcs

757 08...19	8-9-10-11-12-13-14-15-16-17-18-19 mm ratel steeksleutels
760 0810...2224	8x10-12x14-13x15-16x18-17x19-21x23-22x24 mm XL
755S08....19	8-9-10-11-12-13-14-15-16-17-18-19 mm mini steekring
751 0810....3032	8x10-9x11-12x13-14x15-16x18-17x19-19x22-24x27-30x32 mm open ringsleutels, clés à tuyauter
756 0607....2024	E6xE8-E7xE11-E10xE12-E14xE18-E16xE22-E20xE24 torx sleutels, clés torx



FOR F5522 - Jumbo

Sleutelset 52 delig
Jeu de clés 52 pcs

751 0810....3032	8x10-9x11-12x13-14x15-16x18-17x19-19x22-24x27-30x32 open ringsleutels - clés à tuyauter
757 08....24	8-9-10-11-12-13-14-15-16-17-18-19-20-21-22-23-24mm ratelsleutels - clés mixte à cliquet
761 0810....17.19	8x10-11x13-12x14-13x15-17x19mm halve maansleutels - clés demi-lune
758 0809....2224	8x9-10x11-12x13-14x15-16x17-18x19-21x23-22x24 mm gebogen ringsleutels - clés polygonales
754 0607...3032	6x7-8x9-10x11-12x13-14x15-16x17-18x19-20x22-21x23-24x26-25x28-27x30-32x36 mm steeksleutels- clés à fourches

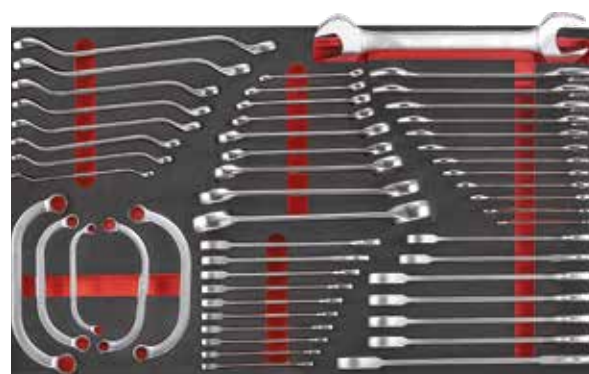

FOR F5422 - Jumbo

Sleutelset 42 delig
Jeu de clés mixtes 42 pcs

755 06....38	6-7-8-9-10-11-12-13-14-15-16-17-18-19-20-21-22-23-24-25-26-27-28-30-32-33-34-36-38 mm steekringsleutels - clés mixtes
755S08....19	8-9-10-11-12-13-14-15-16-17-18-19mm mini steekringsleutels - clés mixte courtes

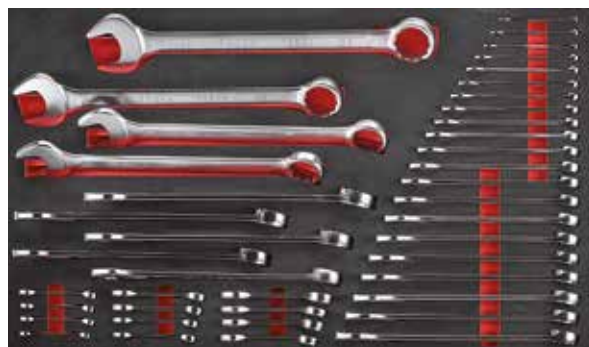

FOR F5292 - Jumbo

Sleutel-haakset 29dlg
Jeu de clés 29pcs

905M2P1	vork voor deurbekleding, grattoir
905M2P2	schraper plat, grattoir plat
905M2P3	schraper, grattoir
905M2P4	schraper gebogen, grattoir coudée
905M2P5	haak algemeen gebruik, crochet
905M1	Clipverwijderaars 5dlg
774300 06...14	6-7-8-9-10-11-12-13-14mm T greep dopsleutels
765 02....12	2-2.5-3-4-5-6-7-8-10-12mm L greep kogelinbus sleutels, clés mâles à tête sphérique



FOR F5173 - Jumbo

Tangenset 17 delig
Jeu de pinces 17 pcs

609ASC	borgveertang, pince circlips
609ASO	borgveertang, pince circlips
609ABC	borgveertang, pince circlips
609ABO	borgveertang, pince circlips
610B200	lange bektang, pince à becs long 200 mm
610B200B	gebogen lange bektang, pince à becs long coudé 200 m
611B175	kombinatietang, pince universelle 175 mm
612B175	kniptang, pince coupante 175 mm
613B250	waterpomptang, pince multiprise 250 mm
614250	vise grip tang, pince grip 250 mm
65202	schuine vise grip tang, pince étau à becs coudé
649250A	moersleutel, clé à molette 250 mm
6805	striptang, pince à sertir
6923160	kabelsnijtang, coupe câble
6921160	4 in 1 electrical tang
673B215	universele rondebek tang
6925160	kniptang 160 mm

JUMBO

FOR F5188 - Jumbo

Tangenset 18 delig
Jeu de pinces 18 pcs

609ASC	borgveertang, pince circlips
609ASO	borgveertang, pince circlips
609ABC	borgveertang, pince circlips
609ABO	borgveertang, pince circlips
610B200	lange bektang, pince à becs long 200 mm
610B200B	gebogen lange bektang, pince à becs long coudé 200 m
611B175	kombinatietang, pince universelle 175 mm
612B175	kniptang, pince coupante 175 mm
673B215	combinatietang met vergrendeling
613B250	waterpomptang, pince multiprise 250 mm
614250	vise grip tang, pince grip 250 mm
65202	schuine vise grip tang, pince étau à becs coudé
649250C	moersleutel, clé à molette 250 mm
649250E	moersleutel, clé à molette 250 mm
5047P1	lange bektang, pince à becs long
5047P2	lange bektang, pince à becs long 45°
5047P3	lange gebogen bektang
5047P4	lange bougietrekkertang



FOR F5242 - Jumbo

Hamer & beiterset 24 delig
Jeu de burins & acc. 24 pcs

602 12150Q...22200Q	10-12-15-19-22-25 mm beitels, burins
603150Q	kapbeitel, bédane
604 2140Q...8215Q	2-3-4-5-6-8 mm puntslag, pointeau
606	4-5-6 mm puntbeitel
616300	hamer, marteau mecanicien 300 gr
616280	rubber hamer, marteau anti retour 280 gr
5055P4	mes, cutter à lame
5096P8	meter, mètre à ruban 5m
6982	schaar, ciseau
5055P1	metaalplaatschaar, ciseau pour métal
66302	mini zaag, scie mini



FOR F5296 - Jumbo

Tangenset 29 delig
Jeu de pinces 29 pcs

6609ASC	borgveertang, pince circlips
609ASO	borgveertang, pince circlips
609ABC	borgveertang, pince circlips
609ABO	borgveertang, pince circlips
610B200	lange bektang, pince à becs long 200 mm
610B200B	gebogen lange bektang, pince à becs long coudé 200 mm
611B175	kombinatietang, pince universelle 175 mm
612B175	kniptang, pince coupante 175 mm
613B250	waterpomptang, pince multiprise 250 mm
614250	vise grip tang, pince grip 250 mm
6805	automatische striptang
649250	moersleutel, clé à molette 250 mm
616300	bankhamer 300gr, marteau de mécanicien
616400	rubber hamer 400gr, marteau anti retour
905M2P3	schraper
618	voelmaatjes
68021	mes, couteau
60212150	beitel 12, burin
60219200	beitel 19, burin
60225220	beitel 25, burin
603150	kapbeitel
6074185	center punt 4 185mmL
6042140	doorslag 2
6043150	doorslag 3
6044190	doorslag 4
6045200	doorslag 5
6046210	doorslag 6
6048215	doorslag 8
60410230	doorslag 10

JUMBO



FOR F5272 - Jumbo

Hamer & beitelset 27 delig
Jeu de burins & acc. 27 pcs

602 12150Q...22200Q	12-19-25 mm beitels, burins
603150Q	kapbeitel, bédane
604 2140Q...8215Q	2-3-4-5-6-8 mm puntslag, pointeau
60410230Q	puntslag 10 230mmL, pointeau
6074185Q	center punt 4 185mmL
616500	hamer, marteau mecanicien 500 gr
616G1250	blokhamer, massette 1250 gr
5055P4	mes, cutter à lame
5096P805	meter, mètre à ruban 5m
5056P1	platte vijl - lime plat
5056P2	halfronde vijl - lime demi ronde
5056P3	ronde vijl - lime ronde
5056P5	driehoeksvijl - lime triangle
610B200	lange bektang - pince à becs long
610B200B	lange gebogen bektang - pince à becs long coudé
611B175	kombinatietang - pince universelle
612B175	kniptang - pince coupante
613B250	waterpomptang - pince multiprise
614250	vise grip tang - pince grip
905M2P3	schraper, grattoir



FOR F5521 - Jumbo

Vijl & meetset 52 delig
Outils de mesure 52 pcs

751 0810....3032	8x10-9x11-11x13-12x14-14x17-16x18-17x19-24x27-30x32 mm open ringsleutel-clé à tuyauter
5056P1	platte vijl, lime plat
5056P2	half ronde vijl, lime demi rond
5056P3	ronde vijl, lime ronde
5056P4	vierkants vijl, lime quarré
5056P5	driehoeksvijl, lime triangle
8174	slagschroevendraaier + 12 bits, tournevis à frappe
63005	linkse tappenset, extracteurs
5096P1	schuif mm, pied à coulisse
5096P2	kraspen, pointe à tracer
5096P3	meetlat, règle en metal
5096P4	gradenboog, rapporteur
5096P5	voelermaatjes, jauges d'épaisseur 0.25-6 mm
5096P6	voelermaatjes, jauges d'épaisseur 4-62 inch
61802	voelermaatjes, jauges d'épaisseur mm+inch



FOR F5352 - Jumbo

Vijl & meetset 35 delig
Outils de mesure 35 pcs

5055p4	universeel mes- cutter à lame
5056P1	platte vijl, lime plat
5056P2	half ronde vijl, lime demi rond
5056P3	ronde vijl, lime ronde
5056P4	vierkants vijl, lime quarré
5056P5	driehoeksvijl, lime triangle
616300	hamer, marteau 300fr
616A400	kunststof hamer, marteau
6981250	blikscvhaar
9U3003	stalen borstel
5096P1	schuifmaat, pied à coulisse
66303	metaalzaag
5096P2	kraspen, pointe à tracer
5096P3	stalen meetlat 30cm
5096P4	gradenboog, rapporteur
5096P5	voelermaatjes, jauges d'épaisseur 0.25-6 mm
5096P6	voelermaatjes, jauges d'épaisseur 4-62 inch
5096P7	stalen naald
6983	schaar
5096P8	meter 5m
617L	magnetische flexible pick up tool
603150	kapbeitel
6042140	doorslag 2
6043150	doorslag 3
6044190	doorslag 4
6045200	doorslag 5
6046210	doorslag 6
6048215	doorslag 8



























DOPPENSETS

JEU DE DOUILLES





	Doppensets - jeu de douilles 1/4"	104
	Doppen - douilles 1/4"	110
	Ratels - cliquets 1/4"	114
	Accessoires 1/4"	115
	Doppensets - jeu de douilles 3/8"	116
	Doppensets inch - jeu de douilles en pouce 3/8"	120
	Doppen - douilles 3/8"	122
	Accessoires 3/8"	124
	Ratels - cliquets 3/8"	125
	Doppensets - jeu de douilles 1/2"	126
	Doppensets inch maten - jeu de douilles en pouce	131
	Doppensets - jeu de douilles 1/2"	132
	Doppensets inbus - jeu de douilles hex 1/2"	133
	Doppensets torx - jeu de douilles torx 1/2"	134
	Doppensets - jeu de douilles 1/2"	136
	Doppensets XZN - jeu de douilles XZN 1/2"	137
	Doppen - douilles 1/2"	138
	Doppen inch - douilles inch 1/2"	139
	Accessoires 1/2"	139
	Ratels - cliquets 1/2"	146
	Doppensets - jeu de douilles 3/4"	147
	Doppen & toebehoren - douilles 3/4"	148
	Doppensets - jeu de douilles 1"	150
	Accessoires 1"	151

1/4"

FOR 2133-5

1/4" Doppenset 6 kant 13 delig op rail
1/4" Jeu de douilles 6 pans 13 pcs sur rail



525 04....14	4-4.5-5-5.5-6-7-8-9-10-11-12-13-14 mm
--------------	---------------------------------------

FOR 2133

1/4" Doppenset 12 kant 13 delig op rail
1/4" Jeu de douilles 12 pans 13 pcs sur rail



529 04....14	4-4.5-5-5.5-6-7-8-9-10-11-12-13-14 mm
--------------	---------------------------------------

FOR 21110-5

1/4" Lange 6 kant doppenset 11 delig op rail SAE
1/4" Douilles longues 6 pans 11 pcs sur rail SAE



5/32"- 3/16"-7/32"-1/4"-9/32"-5/16"-11/32"-3/8"-7/16"-1/2"-9/16"
--

FOR 21110

1/4" 12 kant doppenset 11 delig op rail SAE
1/4" Douilles 12 pans 11 pcs sur rail en pouce



529	5/32"- 3/16"-7/32"-1/4"-9/32"-5/16"-11/32"-3/8"-7/16"-1/2"-9/16"
-----	--

FOR 21115

1/4" Lange 6 kant doppenset 11 delig op rail
1/4" Douilles longues 6 pans 11 pcs sur rail



5255 004.....14	4-5-6-7-8-9-10-11-12-13-14 mm (50mmL)
-----------------	---------------------------------------

FOR 21115-9

1/4" Lange 12 kant doppenset 11 delig op rail
1/4" Douilles longues 12 pans 11 pcs sur rail



5255 004.....14	4-5-6-7-8-9-10-11-12-13-14 mm (50mmL)
-----------------	---------------------------------------

FOR 21016

1/4" Torx E dopen 10dlg op rail

1/4" Jeu de douilles Torx E 10pcs sur rail



526 serie	1/4"	E4-E5-E6-E7-E8-E10-E11-E12-E14-E16
-----------	------	------------------------------------

FOR 20812

Torxset 1/4" 8 delig
Jeu de Torx 1/4" 8pcs



32632 08....40	1/4"	T8-T10-T15-T20-T25-T27-T30-T40 (32 mm L)
----------------	------	---



FOR 2111I

Torxset 1/4" - 3/8" 11 delig
Jeu de Torx 1/4" - 3/8" 11 pcs



32632 10....30	1/4"	T10-T15-T20-T25-T27-30 (32 mm L)
33650 40....60	3/8"	T40-T45-T50-T55-T60 (50 mm L)



FOR 2112I

Resistorxset 1/4" - 3/8" 11 delig
Resistorx 1/4" - 3/8" 11 pcs



32732 10....30	1/4"	T10H-T15H-T20H-T25H-T27H-30H (32mmL)
33750 40....60	3/8"	T40H-T45H-T50H-T55H-T60H (32mmL)



FOR 20711

1/4" Resistorx 5 kant doppenset 7 delig op rail
1/4" Resistorx 5 pans douilles 7 pcs sur rail



32F32 10.....40	TS10-TS15-TS20-TS25-TS27-TS30-TS40 (32mmL)
-----------------	--



FOR 2073

1/4" Inbus doppenset 7 delig op rail
1/4" Jeu de douilles hexagonales 7 pcs sur rail



32432 03...10	3-4-5-6-7-8-10 mm (32mmL)
---------------	---------------------------



FOR 2073S

1/4" Inbus doppenset inch 7 delig op rail
1/4" Jeu de douilles hexagonales en pouce 7 pcs sur rail



32432 1.8.....3.8	1/2"-5/32"-3/16"-7/32"-1/4"-5/16"-3/8"
-------------------	--



FOR 2222

1/4" Doppenset 22 delig 1/4" Jeu de douilles 22 pcs

display stand (12 sets)



121251 3	1/4" PH1 - PH2 - PH3 (25 mm L)
12325 04 065	1/4" plat 4-5,5-6,5 mm
12425 03..... 06	1/4" inbus 3-4-5-6 mm
12625 10..... 30	1/4" torx 10-T15-T20-T25-T30
525 06..... 13	1/4" 6-7-8-10-13 mm dop 6-kant
8092225	bit adapter 1/4" - 1/4"
802214	1/4" ratel, cliquet



FOR 2292

1/4" Doppenset 29 delig geleverd in pvc koffer 1/4" Jeu de douilles 29 pcs 6 pans



5250 04...13	doppen-douilles 6k 4-4,5-5-5,5-6-7-8-9-10-11-12-13 mm
323 04...07	bit dop plat 4-5,5-7
324 03...08	inbus-hex 3-4-5-6-8
321 01...2	philips 1-2
322 01...2	pozidriv 1-2
8143	steekhecht, manche tournevis
8042050	verlengstuk - rallonge 50 mm
8032115	wringstaaf, manche en T
80222	ratel, cliquet
80521	kniegewricht, cardan universeel



FOR 2421

1/4" Doppenset 42 delig geleverd in pvc koffer 1/4" Jeu de douilles 42 pcs 6 pans



	doppen 6 kant - douilles 6 pans
525 032..... 14	3,2-4,-4,5-5-5,5-6-7-8-9-10-11-12-13-14 mm
12425 03..... 08	Inbus-hex 3,4,5,6,8 mm
12625 10..... 40	Torx T10-T15-T20-T25-T30-T40
12325 04..... 065	plat 4-5,5-6,5 mm
12125 1..... 3	philips PH-1-PH-2-PH-3
12225 1..... 3	pozidriv PZ,1-PZ-2-PZ,3
80229	ratel, cliquet
8042 050..... 150	2 verlengstukken, rallonges 50-150 mm
80521	kniegewricht, cardan universeel
81022	bit houder 1/4"x1/4"
8143	steekhecht, manche tournevis
80632	1 adapter voor verlengstuk 3/8"x1,1/4"
81225	magneet, aiment



FOR 2312

1/4" Doppenset 12kant 31 delig mm + inch in pvc koffer
1/4" Jeu de douilles 12 pans mm + en pouce en coffret PVC 31 pcs



529 004.....14	12 k doppen metric, douille 12pans en pouce 4-4,5-5-5,5-6-7-8-9-10-11-12-13-14 mm
529 3,16.....9,16	12k doppen Inch 3/16"-7/32"-1/4"-9/32"-5/16" 11/32"-3/8"-7/16"-1/2"-9/16"
80222	ratel, cliquet
8042 050.....150	verlengstukken, rallonges 50-150 mm
80622	adapter 1/4"*1/4"
80521	kniegewricht, cardan universeel
8145	steekhecht, manche tournevis
81022	1 bit houder, porte embout
8111	flexibel verlengstuk, rallonge flex



FOR 2312-5

1/4" Doppenset 31 delig mm + inch in pvc koffer

- idem maar 6 kant doppen



1/4" Jeu de douilles 31 pcs metric + en pouce en coffret t PVC 6 pans

FOR 2711

1/4" Doppenset 71 dlg in metalen koffer 6kant
1/4" Jeu de douilles 71 pcs 6 pans box métal



525 04....13 6k	4-4,5-5-5,5-6-7-8-9-10-11-12-13 14mm lange doppen, douilles longues 6pans
52550 04....13	4-5-5,5-6-7-8-9-10-11-12-13-14 mm
52604....12	E4-E5-E6-E7-E8-E10-E11-E12 torx E doppen
321 320...323	PH.0-PH.1-PH.2-PH.3
322321-322322	PZ1-PZ2
32432 03....10	3-4-5-6-7-8-10mm inbus-hex
3233204...07	4-5-5-6-5-7mm plat
32632 08...40	T8-T10-T15-T20-T25-T27-T30-T40 torx
32732 08...40	T8H-T10H-T15H-T20H-T25H-T27H-T30H-T40H resistorex
80228	ratel, cliquet
8042 050....100	verlengstuk, rallonge 50-100 mm
8032115	T schuifstuk, manche en T
80521	kniegewricht, cardan universeel
8143	steekhecht, manche tournevis



FOR T2741

TC module met doppenassortiment 74 delig mm + inch maten 6k
TC module 74 pcs jeu de douilles & acc. mm + et en pouce 6 pans



	6k doppen - douilles 6 pans
525 04...13	4-4,5-5-5,5-6-7-8-9-10-11-12-13 mm
525 3,16...1,2	3/16"-1/4"-9/32"-11/32"-3/8"-1/2"
	6k lange doppen - douilles longues 6p
52550 04...13	4-4,5-5-5,5-6-7-8-9-10-11-12-13 mm
52550 3,16...1,2	3/16"-1/4"-9/32"-11/32"-3/8"-1/2"
32432 03...10	Inbus 3-4-5-6-7-8-10 mm
32432 1,8...3,8	Inbus 1/8"-3/16"-7/32"-1/4"-3/8"
32132 1...3	Philips PH1-PH2-PH3
32232 1...3	Pozidriv PZ1-PZ2-PZ3
32332 03...065	Plat 3-4-5,5-6,5 mm
32632 08...40	Torx T8-T10-T15-T20-T25-T27-T30-T40
802215	ratel, cliquet
8042 050...150	verlengstukken, rallonges 50-100-150 mm
80521	kniegewricht, cardan universeel
8143	steekhecht, manche tournevis
81225	magneet pick up tool, aiment
8032115	wringstaaf, manche en T



FOR T2742

TC module met doppenassortiment 74 delig 6k
TC module 74 pcs jeu de douilles & acc. 6 pans



52504.....13	doppen - douilles 4-4,5-5-5,5-6-7-8-9-10-11-12-13 mm
5255004.....13	12 lange doppen - douilles longues 4-4,5-5-5,5-6-7-8-9-10-11-12-13 mm
52604.....10	6 torx doppen - douilles torx E4-E5-E6-E7-E8-E10
52650 04.....10	6 lange torx doppen - douilles torx longues E4-E5-E6-E7-E8-E10 1/4" 32 dop bits (32 mm L)
32432 03.....10	Inbus -hex 3-4-5-6-7-8-10 mm
321320.....2	philips PH0-PH1-PH2
322232 0.....2	pozidriv PZ0-PZ1-PZ2
32332 04.....065	plat 4-5,5-6,5 mm
32632 08.....40	torx T8-T10-T15-T20-T25-T27-T30-T40
32732 08.....40	resistorx T8H-T10H-T15H-T20H T25H-T27H-T30H-T40H
802220	Tmini ratel, cliquet mini
8042 050.....150	3 verlengstukken, rallonges 50-100-150 mm
80521	kniegewricht, cardan universeel
81225	magneet, aiment



FOR T2045

TC module met 3 ratels & momentsleutel
TC module 3 cliquets & clé dynamométrique



6472270	Momentsleutel, clé dynamométrique 5-25nw
802215	Ratel, cliquet
802219	Stubby ratel, cliquet court
802218	Flexibel ratel, cliquet flexible

FOR T2641

TC module met doppenassortiment 65 delig 6 kant
TC module 65 pcs douilles et acc. 6 pans



525 032....14	doppen 6 kant - douilles 6 pans 3,2-4-4,5-5-5,5-6-7-8-9-10-11-12-13-14 mm
52550 05....13	lange doppen - douilles longues 6p 5-6-7-8-9-10-11-12-13 mm dop bit (32 mm L)
32432 03.....10	inbus 3-4-5-6-7-8-10 mm
32132 1.....3	philips PH1-PH2-PH3
32232 1.....3	pozidriv PZ1-PZ2-PZ3
3233204.....065	plat 4-5,5-6,5 mm
32632 08.....40	torx T8-T10-T15-T20-T25-T27-T30-T40
802222	ratel, cliquet
8042 050.....150	3 verlengstukken, rallonge 50-100-150 mm
8032115	wringstaaf, manche en T
80521	kniegewricht, cardan universeel
8143	steekhecht, manche tournevis
81225	magneet, aiment
5102XLB	ball point inbussleutelset, clés mâles 1,27-1,5-2-2,5-3-4-5-6-8-10 mm

Art.nr	mm	L mm
FOR 52504	4 mm	25
FOR 525045	4.5 mm	25
FOR 52505	5 mm	25
FOR 525055	5.5 mm	25
FOR 52506	6 mm	25
FOR 52507	7 mm	25
FOR 52508	8 mm	25
FOR 52509	9 mm	25
FOR 52510	10 mm	25
FOR 52511	11 mm	25
FOR 52512	12 mm	25
FOR 52513	13 mm	25
FOR 52514	14 mm	25



Doppen 6 kant 1/4"
Douilles 6 pans 1/4"



Art.nr	mm	L mm
FOR 52904	4 mm	25
FOR 52905	5 mm	25
FOR 52955	5.5mm	25
FOR 52906	6 mm	25
FOR 52907	7 mm	25
FOR 52908	8 mm	25
FOR 52909	9 mm	25
FOR 52910	10 mm	25
FOR 52911	11 mm	25
FOR 52912	12 mm	25
FOR 52913	13 mm	25
FOR 52914	14 mm	25



Doppen 12 kant 1/4"
Douilles 12 pans 1/4"



Art.nr	mm	L mm
FOR 5253.16	3/16"	25
FOR 5257.32	7/32"	25
FOR 5251.4	1./4"	25
FOR 5259.32	9/32"	25
FOR 5255.16	5/16"	25
FOR 52511.32	11/32"	25
FOR 5253.8	3/8"	25
FOR 5257.16	7/16"	25
FOR 5251.2	1/2"	25
FOR 5259.16	9/16"	25



Doppen 6 kant 1/4" SAE
Douilles 6 pans 1/4" SAE



Art.nr	mm	L mm
FOR 5255004	4 mm	50
FOR 5250045	4.5 mm	50
FOR 5255005	5 mm	50
FOR 52550055	5.5 mm	50
FOR 5255006	6 mm	50
FOR 5255007	7 mm	50
FOR 5255008	8 mm	50
FOR 5255009	9 mm	50
FOR 5255010	10 mm	50
FOR 5255011	11 mm	50
FOR 5255012	12 mm	50
FOR 5255013	13 mm	50
FOR 5255014	14 mm	50



Lange doppen 6 kant 1/4"
Douilles longues 6 pans 1/4"



Art.nr	mm	L mm
FOR 5290045	4.5 mm	50
FOR 5295005	5 mm	50
FOR 52950055	5.5 mm	50
FOR 5295006	6 mm	50
FOR 5295007	7 mm	50
FOR 5295008	8 mm	50
FOR 5295009	9 mm	50
FOR 5295010	10 mm	50
FOR 5295011	11 mm	50
FOR 5295012	12 mm	50
FOR 5295013	13 mm	50



Lange doppen 12 kant 1/4"
Douilles longues 12 pans 1/4"



Art.nr	mm	L mm
FOR 525503.16	3/16"	50
FOR 525507.32	7/32"	50
FOR 525501.4	1/4"	50
FOR 525509.32	9/32"	50
FOR 525505.16	5/16"	50
FOR 5255011.32	11/32"	50
FOR 525503.8	3/8"	50
FOR 525507.16	7/16"	50
FOR 525501.2	1/2"	50
FOR 525509.16	9/16"	50



Lange doppen 6 kant 1/4" SAE
Douilles longues 6 pans 1/4"SAE



Art.nr	mm	L mm
FOR 52604	E4	25
FOR 52605	E5	25
FOR 52606	E6	25
FOR 52607	E7	25
FOR 52608	E8	25
FOR 52610	E10	25
FOR 52611	E11	25
FOR 52612	E12	25
FOR 52614	E14	25
FOR 52616	E16	25



Torx doppen inwendig 1/4"
Douilles Torx 1/4"



Art.nr	mm	L mm
FOR 5265004	E4	50
FOR 5265005	E5	50
FOR 5265006	E6	50
FOR 5265007	E7	50
FOR 5265008	E8	50
FOR 5265010	E10	50



Lange torx doppen inwendig 1/4"
Douilles Torx longues 61/4"



Onderdelen - Accessoires 1/4"

Inbus op dop 6 kant 1/4"
Embouts sur douilles hex 6 pans 1/4"



Art.nr	mm	L mm
FOR 3243203	3 mm	32
FOR 3243204	4 mm	32
FOR 3243205	5 mm	32
FOR 3243206	6 mm	32
FOR 3243207	7 mm	32
FOR 3243208	8 mm	32
FOR 3243209	9 mm	32
FOR 3243210	10 mm	32
FOR 324321.4	1/4"	32
FOR 324321.8	1/8"	32
FOR 32423.16	3/16"	32
FOR 324323.8	3/8"	32
FOR 324327.32	7/32"	32

Torx - Resistorx op dop 1/4"
Embouts sur douilles torx - Resistorx 1/4"



Art.nr	mm	L mm
FOR 3263208	T8	32
FOR 3263209	T9	32
FOR 3263210	T10	32
FOR 3263215	T15	32
FOR 3263220	T20	32
FOR 3263225	T25	32
FOR 3263227	T27	32
FOR 3263230	T30	32
FOR 3263235	T35	32
FOR 3263240	T40	32



FOR 3273208	T8H	32
FOR 3273209	T9H	32
FOR 3273210	T10H	32
FOR 3273215	T15H	32
FOR 3273220	T20H	32
FOR 3273225	T25H	32
FOR 3273227	T27H	32
FOR 3273230	T30H	32
FOR 3273235	T35H	32
FOR 3273240	T40H	32

Resistorx 5 kant op dop 1/4"
Embouts sur douilles Resistorx 5 pans 1/4"



Art.nr	mm	L mm
FOR 32F3210	TS10	32
FOR 32F3215	TS15	32
FOR 32F3220	TS20	32
FOR 32F3225	TS25	32
FOR 32F3227	TS27	32
FOR 32F3230	TS30	32
FOR 32F3240	TS40	32

Art.nr	mm	L mm
FOR 321320	PH0	32
FOR 321321	PH1	32
FOR 321322	PH2	32
FOR 321323	PH3	32

FOR 322320	PZ0	32
FOR 322321	PZ1	32
FOR 322322	PZ2	32
FOR 322323	PZ3	32



Philips-pozidriv op dop 1/4"
Embouts sur douilles philips 1/4"



Art.nr	mm	L mm
FOR 3233204	0.8x4	32
FOR 32332055	1.0x5.5	32
FOR 32332065	1.2x6.5	32
FOR 3233207	1.2x7	32



Platte bit op dop 1/4"
Embouts sur douilles plat 1/4"



Ratels - Cliquets 1/4"

Ratel 24 tanden 1/4"
Cliquet 24 dents 1/4"



Art.nr		L mm
FOR 80222	24T	143 mm
FOR 80222P	herstelkit	kit rep
FOR 80228	72 T	140

Ratel 72 tanden 1/4"
Cliquet 72 dents 1/4"



Art.nr		L mm
FOR 80229		116 mm
FOR 80229P	herstelkit	kit rep

Ratel 20 tanden 1/4"
Cliquet 20 dents 1/4"



Art.nr		L mm
FOR 802215		133 mm
FOR 802215P	herstelkit	kit rep

Ratel knikbaar 72 tanden 1/4"
Cliquet 72 dents 1/4"



Art.nr		L mm
FOR 802223		148 mm
FOR 802223P	herstelkit	kit rep

Ratel 72 tanden 1/4"
Cliquet 72 dents 1/4"



Art.nr		L mm
FOR 802222		123 mm
FOR 802222P	herstelkit	kit rep

Ratel knikbaar 20 tanden 1/4"
Cliquet 20 dents 1/4"



Art.nr		L mm
FOR 802218		127 mm
FOR 802218P	herstelkit	kit rep

Ratel mini 20 tanden 1/4"
Cliquet mini 20 dents 1/4"



Art.nr		L mm
FOR 802219		100 mm
FOR 802219P	herstelkit	kit rep

T Ratel mini 48 tanden 1/4"
T Cliquet mini 48 dents 1/4"



Art.nr		L mm
FOR 802220		110 mm



Onderdelen - Accessoires 1/4"

Kniegewricht 1/4"
Cardan universel 1/4"

Art.nr	L mm
FOR 80521	37 mm

Adapter 1/4" - 3/8"
Adaptateur 1/4" - 3/8"

Art.nr	L mm
FOR 80923	26 mm

Adapter 1/4"
Adaptateur 1/4" -

Art.nr	L mm
FOR 8092230	1/4" Hex 1/4" Sq30mmL
FOR 8092250	1/4" Hex 1/4" sq50mmL

Magneet dop 1/4"
Porte-embouts magnétique 1/4"

Art.nr	L mm
FOR 81225	25 mm

Bithouder 1/4"x 1/4"
Porte embout 1/4"

Art.nr	L mm
FOR 81022	25 mm
FOR 81022M	25 mm

Adapter 5/16"
Adaptateur 1/4" - 5/16

Art.nr	L mm
FOR 8095330	5/16" hex x 3/83 SQ

Verlengstuk 1/4"
Rallonge 1/4"

Art.nr	L mm
FOR 8042050	50 mm
FOR 8042100	100 mm
FOR 8042100W	100 mm
FOR 8042150	150 mm
FOR 8042250	250 mm

Flexibel verlengstuk 1/4"
Rallonge flexible 1/4"

Art.nr	L mm
FOR 8111	145 mm

Magnetisch bit houder
Porte embout

Art.nr	L mm
FOR 81260	1/4" Hex - 1/4" inhex
FOR 81260Q	1/4" Hex - 1/4" inhex
FOR 81280Q	1/4" hex - 1/4" inhex

Steekhecht 1/4"
Manche tournevis 1/4"

Art.nr	L mm
FOR 8145	150 mm

Steekhecht 1/4"
Manche tournevis 1/4"

Art.nr	L mm
FOR 8143	150 mm

Steekhecht 1/4"
Manche tournevis 1/4"

Art.nr	L mm
FOR 8144	215 mm

Wringstaaf 1/4"
Poignée coulissante 1/4"

Art.nr	L mm
FOR 8032115	115 mm

Wringstaaf met kniegewricht
Poignée articulée 1/4"

Art.nr	L mm
FOR 8012140	140 mm

Rail voor 10 doppen 1/4"
Rail pour 10 douilles 1/4"

Art.nr	
FOR 819210	10 doppen
FOR 819213M	13 doppen

Doppensets - Jeu de douilles 3/8"

FOR 3093

3/8" Doppenset op rail 9 delig 6 kant
3/8" Jeu de douilles sur rail 9 pcs 6 pans



535 09...19	9-10-11-12-13-14-15-17-19 mm
--------------------	------------------------------

FOR 3082

3/8" Lange doppenset op rail 8 delig 6 kant
3/8" Jeu de douilles longues sur rail 8 pcs 6 pans



53563 08....19	8-10-12-13-14-16-17-19 mm (63 mm L)
-----------------------	-------------------------------------

FOR 3075

3/8" Inbus doppenset 7 delig op rail
3/8" Jeu de douilles hexagonales 7 pcs sur rail



334050 03...10	3-4-5-6-7-8-10 mm (50 mm L)
-----------------------	-----------------------------

FOR 3099

3/8" 1/2" Inbus doppenset 9 delig op rail
3/8" 1/2" Jeu de douilles hexagonales 9 pcs sur rail



334050 04...10	3/8" 4-5-6-7-8-10 mm (50 mm L)
344050 12...17	1/2" 12mm (55mmL) 14mm (65mmL) 17mm (70mmL)

FOR 3086

3/8" Torx doppenset 8 delig op rail
3/8" Torx douilles 8 pcs sur rail



33650 20....55	T20-T25-T27-T30-T40-T45-T50-T55 (50mmL)
-----------------------	---

FOR 3095

1/4" - 3/8" 5 tands resistorx doppenset 9 delig op rail
1/4" - 3/8" 5 pans resistorx douilles 9 pcs sur rail

32F32 10....40	1/4" TS10-TS15-TS20-TS25-TS27-TS30-TS40
33F50 45....50	3/8" TS45-TS50



FOR 30911

3/8" -1/2" XZN doppen 9 delig op rail
3/8" -1/2" XZN Douilles 9 pcs sur rail



3385005...10	5-6-8-9-10
34805512...16	12-14-16
34805516T	

FOR 30912

3/8" 1/2" Ribe doppen 9 delig op rail
3/8" - 1/2" Douilles Ribe 9 pcs sur rail



33909005...10	M5-M6-M7-M8-M9-M10 (90mmL)
349100 12....14	M12-M13-M14 (100mmL)

FOR 3261

3/8" Doppenset 26 dlg in pvc koffer
Set de douilles 26pcs



535 06.....22	6-7-8-9-10-11-12-13-14-15-16-17-18-19-20-21-22-24mm
80232	ratel, cliquet
8043 044.....150	3 verlengstukken, rallonge 44mm-75 mm-150 mm
80531	kniegewricht, cardan universeel
80643	adapter voor verlengstuk
8073 16.....20,6	2 bougiedoppen, douilles pour bougie 16-20,6 mm

FOR T30712

TC module 7 delig ratels & momentsleutel 3/8"
TC module 7 cliquet & acc. 3/8"



6473365	Momentsleutel, clé dynamométrique
802323	Ratel, cliquet 72t
80232	Ratel, cliquet 24t
802319	Stubby ratel, cliquet 30t
8073 16.....20,6M	3-bougiedoppen, douilles 16-18-20,6 mm

FOR T3251 5

TC module met assortiment 6kant doppen 24 delig
TC module douilles 6 pans & acc. 24 pcs



535 06.....22	6-7-8-9-10-11-12-13-14-15-16-17-18-19-20-21-22mm
80232	ratel, cliquet
8043 075.....150	2 verlengstukken, rallonge 75 mm-150 mm
80531	kniegewricht, cardan universeel
8033165	wringstaaf, manche en T
8073 16.....20,6	2 bougiedoppen, douilles 16-20,6 mm

FOR T3251 9

TC module met assortiment 12kant doppen 24 delig
TC module douilles 12 pans & acc. 24 pcs

FOR T3121

TC module met 12 lange doppen 6 kant
TC module 12 douilles longues 6 pans



53563 08.....22	8-10-11-12-13-14-15-16-17-18-19-22 mm
------------------------	---------------------------------------

FOR T3361

TC module doppen assortiment 36 delig 6kant
TC module douilles & acc. 6 pans 36 pcs



535 06.....22	6-7-8-9-10-11-12-13-14-15-16-17-18-19-20-21-22mm
80239	ratel, cliquet
8043 075.....225	3 verlengstukken, rallonges 75-150-225 mm
8073 16.....20,6	2 bougiedoppen 16-20, 6 mm
80531	kniegewricht, cardan universeel
80643	adapter 1/2" * 3/8"
755 07.....17	7-8-9-10-11-12-13-14-15-16-17 mm steekring, clés mixtes

FOR T3311

TC module doppenset & toebehoren 31 delig 6kant
TC module douilles & acc. 31 pcs 6 pans



535 06.....12	6-7-8-9-10-11-12 mm
53563 06.....12	lange doppen 6-7-8-9-10-11-12 mm
334050 03.....12	Hex dop bit 50 mm L
	3-4-5-5,5-7-8-9-10-12 mm
8013215	wringstaaf met kniegewricht, poignée articulée
8043 044.....250	verlengstukken, rallonge 44-75-150-250 mm
80531	kniegewricht, cardan universeel
80633	adapter 3/8"

FOR T3331

TC module doppenset kort & lang 33 delig 6 kant
TC module 33 douilles 6 pans



535 13.....24	13-14-15-16-17-18-19-20-21-22-24mm doppen
53563 13.....22	13-14-15-16-17-18-19-20-21-22mm lange doppen
33650 08.....60	T8-T10-T15-T20-T25-T27-T30
	T40-T45-T50-T55-T60 (50mmL) torx doppen

FOR T3381

TC module torx XZN doppenset 28 delig 6 kant
TC module 28 douilles torx + XZN 6 pans



	Torx doppen, douilles torx
536 04.....16	E4-E5-E6-E7-E8-E10-E11-E12-E14-E16
	Torx lange doppen, douilles longues torx
53655 04...07	E4-E5-E6-E7-E8-E10-E11-E12-E14-E16
53663 08.....16	E8-E10-E11-E12-E14-E16
33750 08.....60	T8H-T10H-T15H-T20H-T25H-T27H-T30H
	T40H-T45H-T50H-T55H-T60H ResisTorx (50mmL)
33850 05.....12	MX-M6-M8-M9-M10-M12 XZN (50mmL)

FOR T3521

TC module tor x Bitset 52 delig
TC module douilles & acc. torx 52 pcs

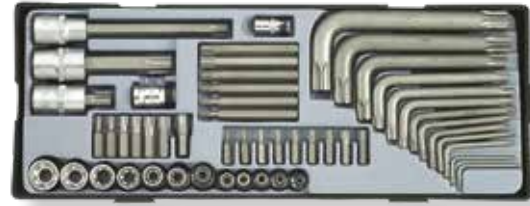

15630 20.....55	5/16" torx bit T20-T25-T30-T40-T50-T55 (30mmL)
15670 20.....50	5/16" T20-T30-T40-T45-T50 (70 mm L)
526 04....08	1/4" Torx dop E4-E5-E6-E7-E8
536 10...20	3/8" E10-E11-E12-E14-E16-E18-E20
766 09....70	star L sleutel T9-T10-T15-T20-T25-T27 T30-T40-T45-T50-T55-T60-T70
12725 08....40	1/4" Resistorx bit T8H-T10H-T15H T20H-T25H-T27H-T30H-T35H-T40H (25 mm L) 3 Torx bit 1/2"
34614055	T55 (140 mm L)
34605560	T60 (55 mm L)
34610070	T70 (100 mm L)
810 22....35	bit houder, porte embout 1/4" x 1/4" - 3/8" x5/16"

FOR T31010

TC module bougie vervangset 3/8" 10 dlg
TC module douilles pour bougie 3/8" 10pcs



80531E	kniegewricht
832 318...324	torque adapter 18Nm-24Nm
807314M	magnetische bougiedoppen 14 mm
807316M	bougiedop 16 mm
807318M	bougiedop 18 mm
807320.6M	bougiedop 20.6m
807325014M	14 mm 250 mmL
807325016M	16 mm 250 mmL
807325020.6M	20.6 mm 250 mmL

FOR T50618-24

TC module bougie gereedschapset 3/8" 6 dlg
TC module pour bougie 3/8" 6pcs

807316M	magnetische bougiedop 16 mm
807320.6M	magnetische bougiedop 20.6mm
807325016M	magnetische bougiedop 16 mm (250mmL)
807325020.6M	magnetische bougiedop 20.6m (250mmL)
647318P	momentsleutel 18Nm
5047P4	lange bougietrektang



FOR T3382

TC module torx doppenset 38 delig 6 kant
TC module douilles torx 6 pans 38pcs

	Torx doppen, douilles torx
536 04.....16	E4-E5-E6-E7-E8-E10-E11-E12-E14-E16-E18-E20 Torx lange doppen, douilles longues torx
53663 04...18	E4-E5-E6-E7-E8-E10-E11-E12-E14-E16-E18
33650 30.....60	T30-T40-T45-T50-T55-T60 (50mmL)
5098XL	T10-T15-T20-T25-T27-T30-T40-T45-T70



Doppensets inch maten - Jeu de douilles 3/8" en pouce

FOR 3113S(12kant)/FOR 3113S-5 (6kant)

3/8" Doppenset op rail 11 delig 6k inch maten
3/8" Jeu de douilles sur rail 11 pcs 6 pans



535 1.4....15.16	1/4"-5/16"-3/8"-7/16"-1/2"-9/16"-5/8"-11/16"-3/4"-13/16"-15/16"
-------------------------	---



FOR T3212

TC module met 6k doppensortiment 21 delig inch
TC module douilles 6 pans & acc. et en pouce 21 pcs



535 1.4....7.8	1/4"-5/16"-3/8"-7/16"-1/2"-9/16"
	19/32"-5/8"-11/16"-3/4"-25/32"-13/16"-7/8"
80232	ratel, cliquet
8033165	wringstaaf, manche en T
8043 075...250	verlengstukken, rallonge 75-150-250 mm
80531	kniegewricht, cardan universeel
8073 16...20,06	bougie doppen, douilles 16-20.6 mm



FOR T3322

TC module met doppensortiment 32 delig mm+ inch
TC module douilles & acc. mm et en pouce 6p 32 pcs



535 06....22	6-7-8-9-10-11-12-13-14-15-16-17-18-19-20-21-22
535 1.4....13.16	1/4"-3/8"-1/2"- 9/16"-5/8"-11/16"-13/16"
802322	ratel, cliquet 72t
80643	adapter, adaptateur 1/2" x 3/8"
8043 075...225	verlengstukken, rallonges 75-150-225 mm
80531	kniegewricht, cardan universeel
8073 16...20,06	bougie doppen, douilles



FOR T3193

TC module met 19 doppen 6k inch maten
TC module 19 douilles en pouce 6 pans



535 1.4.....7.8	1/4"-5/16"-3/8"-7/16"-1/2"-9/16"
	5/8"-11/16"-3/4"-13/16"-7/8"
53563 5,16.....3,4	5/16"-3/8"-7/16"-1/2"-9/16"-5/8"-11/16"-3/4"



FOR 3075S

3/8" Inbus doppenset 7 delig op rail
3/8" Jeu de douilles hexagonales sur rail 7pcs



334050 1/8....3/8"	1/8"-5/32"-3/16"-7/32"-1/4"-5/16"-3/8"
---------------------------	--



Art.nr	mm	L mm
FOR 53506	6 mm	28
FOR 53507	7 mm	28
FOR 53508	8 mm	28
FOR 53509	9 mm	28
FOR 53510	10 mm	28
FOR 53511	11 mm	28
FOR 53512	12 mm	28
FOR 53513	13 mm	28
FOR 53514	14 mm	30
FOR 53515	15 mm	30
FOR 53516	16 mm	30
FOR 53517	17 mm	30
FOR 53518	18 mm	30
FOR 53519	19 mm	30
FOR 53520	20 mm	30
FOR 53521	21 mm	30
FOR 53522	22 mm	32
FOR 53524	24 mm	32

Doppen 6 kant 3/8"
Douilles 6 pans 3/8"



FOR 5351.4	1/4"	28
FOR 5355.16	5/16	28
FOR 5353.8	3/8"	28
FOR 5357.16	7/16"	28
FOR 5351.2	1/2"	28
FOR 5359.16	9/16"	30
FOR 5355.8	5/8"	30
FOR 53511.16	11/16"	30
FOR 5353.4	3/4"	30
FOR 53513.16	13/16"	30
FOR 5357.8	7/8"	30
FOR 53519.32	19/32"	30

Doppen 6 kant 3/8" SAE
Douilles 6 pans 3/8" SAE

Art.nr	mm	L mm
FOR 5356306	6 mm	63
FOR 5356307	7 mm	63
FOR 5356308	8 mm	63
FOR 5356309	9 mm	63
FOR 5356310	10 mm	63
FOR 5356311	11 mm	63
FOR 5356312	12 mm	63
FOR 5356313	13 mm	63
FOR 5356314	14 mm	63
FOR 5356315	15 mm	63
FOR 5356316	16 mm	63
FOR 5356317	17 mm	63
FOR 5356318	18 mm	63
FOR 5356319	19 mm	63
FOR 5356320	20 mm	63
FOR 5356321	21 mm	63
FOR 5356322	22 mm	63

Lange doppen 6 kant 3/8"
Douilles longues 6 pans 3/8"



FOR 535635.16	5/16	63
FOR 535633.8	3/8"	63
FOR 535637.16	7/16"	63
FOR 535631.2	1/2"	63
FOR 535639.16	9/16"	63
FOR 535635.8	5/8"	63
FOR 5356311.16	11/16"	63
FOR 535633.4	3/4"	63
FOR 5356313.16	13/16"	63
FOR 535637.8	7/8"	63

Lange doppen 6 kant 3/8" SAE
Douilles longues 6 pans 3/8" SAE

Doppen 3/8" - douilles 3/8"

Art.nr	mm	L mm
FOR 53604	E4	28
FOR 53605	E5	28
FOR 53606	E6	28
FOR 53607	E7	28
FOR 53608	E8	28
FOR 53610	E10	28
FOR 53611	E11	28
FOR 53612	E12	28
FOR 53614	E14	28
FOR 53616	E16	28
FOR 53618	E18	28
FOR 53620	E20	28



Torx doppen inwendig 3/8"
Douilles Torx 3/8"



Art.nr	mm	L mm
FOR 5365504	E4	55
FOR 5365505	E5	55
FOR 5365506	E6	55
FOR 5365507	E7	55
FOR 5366308	E8	63
FOR 5366310	E10	63
FOR 5366311	E11	63
FOR 5366312	E12	63
FOR 5366314	E14	63
FOR 5366316	E16	63
FOR 5366318	E18	63



Torx doppen inwendig 3/8"
Douilles Torx 3/8"



Art.nr	mm	L mm
FOR 807314	14	63
FOR 807316	16	63
FOR 807318	18	63
FOR 807320.6	20.6	63
FOR 807314M	14	70
FOR 807316M	16M	70
FOR 807318M	18M	70
FOR 807320.6M	20.6M	70
FOR 807325014M	14M	250
FOR 807325016M	16M	250
FOR 807314MTH	14	70
FOR 807316MTH	16	70
FOR 807318MTH	18	70
FOR 807320.6MTH	20.5	70

Bougiedop 3/8"
Douilles pour bougies 3/8"



M = magnetisch
M = magnétique
MTH = dunwandig

Dop met kniegewricht 3/8"
Douille cardan 3/8"

Art.nr	L mm	mm
FOR 8053510	42	10mm
FOR 8053511	42	11mm
FOR 8053512	42	12mm
FOR 8053513	42	13mm
FOR 8053514	42	14mm
FOR 8053516	42	16mm

Art.nr	L mm	mm
FOR 805358510	85	10mm
FOR 805358511	85	11mm
FOR 805358512	85	12mm
FOR 805358514	85	14mm
FOR 805358516	85	16mm
FOR 805358519	85	19mm



Art.nr	mm	L mm
FOR 33405003	3 mm	50
FOR 33405004	4 mm	50
FOR 33405005	5 mm	50
FOR 33405055	5.5 mm	50
FOR 33405006	6 mm	50
FOR 33405007	7 mm	50
FOR 33405008	8 mm	50
FOR 33405009	9 mm	50
FOR 33405010	10 mm	50
FOR 33405012	12 mm	50



Inbus op dop 3/8"
Embouts sur douilles hex 3/8"



Art.nr	mm	L mm
FOR 3365008	T8	50
FOR 3365010	T10	50
FOR 3365015	T15	50
FOR 3365020	T20	50
FOR 3365025	T25	50
FOR 3365027	T27	50
FOR 3365030	T30	50
FOR 3365040	T40	50
FOR 3365045	T45	50
FOR 3365050	T50	50
FOR 3365055	T55	50
FOR 3365060	T60	50



Torx op dop 3/8"
Embouts sur douilles torx 3/8"



Art.nr	mm	L mm
FOR 3375008	T8H	50
FOR 3375010	T10H	50
FOR 3375015	T15H	50
FOR 3375020	T20H	50
FOR 3375025	T25H	50
FOR 3375027	T27H	50
FOR 3375030	T30H	50
FOR 3375040	T40H	50
FOR 3375045	T45H	50
FOR 3375050	T50H	50
FOR 3375055	T55H	50
FOR 3375060	T60H	50



Resistorx op dop 3/8"
Embouts sur douilles resistorx 3/8"



Art.nr	mm	L mm
FOR 3385005	M5	50
FOR 3385006	M6	50
FOR 3385008	M8	50
FOR 3385009	M9	50
FOR 3385010	M10	50
FOR 3385012	M12	50



XZN op dop 3/8"
Embouts sur douilles XZN 3/8"



Art.nr	mm	L mm
FOR 33909006	M6	90
FOR 33909007	M7	90
FOR 33909008	M8	90



Ribe (5k) dop bit 3/8"
Embout sur douilles Ribe (5p) 3/8"



Toebehoren - Accessoires 3/8"

Verloopstuk 3/8"
Adaptateurs 3/8"



Art.nr	mm	L mm
FOR 80934	3/8" x 1/2"	46
FOR 80932	3/8" x 1/4"	35
FOR 80643	1/2" 3/8"	46
FOR 81037	bithouder	

Verlengstuk 3/8"
Ralongs 3/8"



Art.nr		L mm
FOR 8043044		44 mm
FOR 8043044W	zwenkbaar	44 mm
FOR 8043075		75 mm
FOR 8043150		150 mm
FOR 8043200		200 mm
FOR 8043225		225 mm
FOR 8043250		250 mm
FOR 8043300		300 mm
FOR 8043450		450 mm

Kniegewricht 3/8"
Cardan universel 3/8"



Art.nr	mm	L mm
FOR 80531		46

Wringstaaf met schuifstuk 3/8"
Poignée coulissante 3/8"



Art.nr	mm	L mm
FOR 8033165		165

Wringstaaf met kniegewricht 3/8"
Poignée articulées 3/8"



Art.nr	mm	L mm
FOR 8013215		215

Rail voor 13 doppen 3/8"
Rail pour 13 douilles 3/8"



Art.nr	mm	L mm
FOR 819313		280 mm
FOR 819316M		

T sleutel met cardangewricht 3/8"
Clés T avec cardan 3/8"

Art.nr	L mm
FOR 784206U	400
FOR 784207U	400
FOR 784208U	400
FOR 784209U	450
FOR 784310U	450
FOR 784311U	450
FOR 784312U	450
FOR 784313U	450
FOR 784314U	500
FOR 784315U	500
FOR 784316U	500
FOR 784317U	500
FOR 784418U	500
FOR 784419U	500



FOR 3039

3/8" Verlengstukken 3dlg
3/8" Jeu de rallonges 3pcs

8043075....250	75mm-150mm-250mm
-----------------------	------------------



Ratels - cliquets 3/8"

Ratel met ronde kop 3/8"
Cliquet 3/8"



Art.nr	tanden	L mm
FOR 80239	72	189
FOR 80239P	herstelkit	kit rep.

Ratel knikbaar 3/8"
Cliquet flexibel 3/8"



Art.nr	tanden	L mm
FOR 802323	72	230
FOR 802323P	herstelkit	kit rep.

Ratel met ronde kop 3/8"
Cliquet 3/8"



Art.nr	tanden	L mm
FOR 802322	72	180
FOR 802322P	herstelkit	kit rep.

Ratel 3/8"
Cliquet 3/8"



Art.nr	tanden	L mm
FOR 80232	24	200
FOR 80232P	herstelkit	kit rep.

Ratel met kniegewricht 3/8"
Cliquet avec cardan 3/8"



Art.nr	tanden	L mm
FOR 802318		273
FOR 802318P	herstelkit	kit rep.

Ratel 3/8"
Cliquet 3/8"



Art.nr	tanden	L mm
FOR 802315	30	198
FOR 802315P	herstelkit	kit rep.

Mini ratel 3/8"
Cliquet stubby 3/8"



Art.nr	tanden	L mm
FOR 802319		134
FOR 802319P	herstelkit	kit rep.

Ratel 3/8"
Cliquet 3/8"



Art.nr	tanden	L mm
FOR 80238	72	190
FOR 80238P	herstelkit	kit rep.



Doppensets - Jeu de douilles 1/2"

FOR 4106 

1/2" Doppenset op rail 6k 10 delig

1/2" Jeu de douilles sur rail 6 pans 10 pcs

545 11....24	11-12-13-14-15-17-19-21-22-24 mm
--------------	----------------------------------



FOR 41018 (6k-6p) 

FOR 41018-9 (12k-12p) 

1/2" Doppenset op rail 10 delig

1/2" Jeu de douilles sur rail 10 pcs

545 10....24	10-11-12-13-14-15-17-18-19mm
--------------	------------------------------



FOR 40815-9 (12k-12p) 

FOR 40815 (6k-6p) 

1/2" Doppenset op rail 8 delig

1/2" Jeu de douilles sur rail 8 pcs

545 20....32	20-21-22-23-24-27-30-32mm
--------------	---------------------------



FOR 4082 

1/2" Lange doppenset 6k op rail 8 delig

1/2" Douilles longues sur rail 6 pans 8 pcs

54577 13....24	13-14-15-17-19-21-22-24 mm (77mmL)
----------------	------------------------------------



FOR 41018D 

1/2" Lange doppenset 6k op rail 10 delig

1/2" Douilles longues sur rail 6 pans 10 pcs

54577 10....19	10-11-12-13-14-15-16-17-18-19 mm (77mmL)
----------------	--



FOR 41014Q 

Lange doppenset inwendig XZN 10 delig

1/2" Douille longues XZN (12p) 10 pcs

54Q77 10....24	10-11-12-14-16-18-20-24 (77 mm L) 12kant inwendig
----------------	---



FOR 4083 

1/2" Lange doppenset inwendig torx op rail 8 delig

1/2" Douille longues torx sur rail 8 pcs

54677 10....24	E10-E11-E12-E14-E16-E18-E20-E24 (77mmL)
----------------	---



FOR 4113 

1/4" -3/8"- 1/2" Doppenset op rail inwendig torx 11 delig

1/4" -3/8"- 1/2" Douilles torx sur rail 11 pcs

526 05...08	1/4" E5-E6-E7-E8
536 10...14	3/8" E10-E11-E12-E14
546 16...20	1/2" E16-E18-E20



FOR 4158 

1/2" - 3/8"- 1/4" Doppenset op rail inwendig torx 14 delig

1/2" - 3/8" - 1/4" Douilles torx sur rail 14 pcs

526 04...08	1/4" E4-E5-E6-E7-E8
536 10...14	3/8" E10-E11-E12-E14
546 16...24	1/2" E16-E18-E20-E22-E24



FOR 4178

1/4" -3/8"- 1/2" Lange doppen op rail 6k 17 delig
1/4" -3/8" -1/2" Jeu de douilles longues sur rail 17 pcs

5255 06....12	1/4" 6-7-8-9-10-11-12mm
53563 13...18	3/8" 13-14-15-16-17-18mm
54577 19....24	1/2" 19-21-22-24mm



FOR T4212

TC Module met 21 doppen 6k 1/2"
TC Module 21 douilles 6 pans 1/2"

545 08...32	8-10-11-12-13-14-15-16-17-18-19-20-21-22-23-24-26-27-28-30-32 mm
--------------------	--



FOR T4212-9

TC Module met 21 doppen 12k 1/2"
TC Module 21 douilles 12 pans 1/2"

549 08...32	8-10-11-12-13-14-15-16-17-18-19-20-21-22-23-24-26-27-28-30-32 mm
--------------------	--



FOR T4143

TC module met 14 lange doppen 6k 1/2"
TC module 14 douilles longues 6 pans 1/2"

54577 10...32	10-12-13-14-15-17-19-21-22-23-24-27-30-32 mm
----------------------	--



FOR T4143-9

TC module met 14 lange doppen 12k 1/2"
TC module 14 douilles longues 12 pans 1/2"

54977 10...32	10-12-13-14-15-17-19-21-22-23-24-27-30-32 mm
----------------------	--



FOR T4248

TC module met 24 doppen kort + lang 6k 1/2"
TC module 24 douilles 6 pans 1/2"

545 08....19	8-9-10-11-12-13-14-15-16-17-18-19 mm
54577 08...19	8-9-10-11-12-13-14-15-16-17-18-19 mm



FOR T4203

TC module met 20 doppen 6k kort + lang 1/2"

TC module 20 douilles 6 pans 1/2"



545 20....32	20-21-22-23-24-26-27-28-30-32 mm
54577 20....32	20-21-22-23-24-26-27-28-30-32 mm



FOR T4217

TC module met 21 doppen 6kant 1/2"

TC module 21 douilles 6 pans 1/2"



545 25....32	25-26-27-28-30-32 mm
54577 10....24	10-11-12-13-14-15-16-17-18-19-20-21-22-23-24 mm



FOR T4226

TC module 22 delig doppenset 6 kant 1/2"

TC module 22 douilles & acc. 6 pans 1/2"



545 08 ... 26	8-9-10-11-12-13-14-15-16-17-18-19-20-21-22-23-24 mm
80248	ratel, cliquet
80634	3/8" x 1/2" adapter voor verlengstuk
8044125...250	verlengstuk, rallonge 125 mm-250mm
80541	kniegewricht, cardan universeel



FOR T4057

TC module met ratel-sleutelset 5 delig 1/2"

TC module 5 accessoires & cliquet 1/2"



802422	ratel, cliquet
8044 125...250	2 verlengstukken, rallonge 125-250 mm
8034250	wringstaaf, manche en T
80541	kniegewricht, cardan universeel



FOR T40612

TC module ratel-sleutelset 6 delig 1/2"

TC module 6 accessoires 1/2" & cliquet



802415	ratel, cliquet 72t
8044 125...250	2 verlengstukken, rallonge 125-250 mm
8034250	wringstaaf, manche en T
80541	kniegewricht, cardan universeel
8014380	wringstaaf met kniegewricht, manche avec cardan



FOR 4243-5

1/2" Doppenset 24 delig 6 kant
1/2" Jeu de douilles 24 pcs 6 pans

545 10 ... 32	10-11-12-13-14-15-16-17-18-19-20-21-22-23-24-27-30-32mm
80243	ratel, cliquet
8034250	wringstaaf, manche en T
8044125...250	2 verlengstukken, rallonge 125 mm-250 mm
80541	kniegewricht, cardan universeel
8014380	wringstaaf met kniegewricht, poignée articulée

FOR 4243

547 10 ... 32	10-11-12-13-14-15-16-17-18-19-20-21-22-23-24-27-30-32mm golf profiel doppen, profiel convexe
80243	ratel, cliquet
8034250	wringstaaf, manche en T
8044125...250	2 verlengstukken, rallonge 125 mm-250 mm
80541	kniegewricht, cardan universeel
8014380	wringstaaf met kniegewricht, poignée articulée



FOR 4243-9

1/2" Doppenset 24 delig 12 kant
1/2" Jeu de douilles 24 pcs 12 pans

549 10 ... 32	10-11-12-13-14-15-16-17-18-19-20-21-22-23-24-27-30-32mm
80243	ratel, cliquet
8034250	wringstaaf, manche en T
8044125...250	2 verlengstukken, rallonge 125 mm-250 mm
80541	kniegewricht, cardan universeel
8014380	wringstaaf met kniegewricht, poignée articulée

FOR K4087

Adapterset 8 delig
Jeu de réducteurs & augmentateurs 8 pcs

80923	1/4" x 3/8"
80932	3/8" x 1/4"
80934	3/8" x 1/2"
80943	1/2" x 3/8"
80946	1/2" x 3/4"
80964	3/4" x 1/2"
80968	3/4" x 1"
80986	1" x 3/4"



FOR 4941-5

1/4" - 1/2" Kombinatieset 94 delig 6 kant

1/4" - 1/2" Jeu de douilles 94 pcs 6 pans

525 04...14	1/4" doppen 4-4,5-5,5-6-7-8-9-10-11-12-13-14 mm
52550 06...13	1/4" lange doppen 6-7-8-9-10-11-12-13 mm
32432 03...6	1/4" inbus 3-4-5-6 mm
32332 04...065	1/4" plat 4-5,5-6,5 mm
32132 1...2	1/4" PH 1-PH2
32232 1...2	1/4" PZ 1-PZ2
32632 08...30	1/4" TX T10-T15-T20-T25-T27-T30
764	3 inbusleutel 1,5-2-2,5 mm
526 04...08	1/4" 5-E doppen E4-E5-E6-E7-E8
80222	1/4" ratel, cliquet 72t
8042 050...100	1/4"2 verlengstukken, rallonge 50-100 mm
80521	1/4"kniegewricht, cardan universeel 1/4"
8032115	wringstaaf, manche en T
8143	steekhecht, manche tournevis
546 10...32	1/2" doppen 10-11-12-13-14-15 16-17-18-19-20-21-22-24-27-30-32 mm
54677 14...22	1/2" lange doppen 14-15-17-19-22 mm
80242	1/2" ratel, cliquet 72t
8044 125...250	2 verlengstukken, rallonge 125 mm-250 mm
80634	1 adaptor 1/2" x 3/8"
80541	1 kniegewricht, cardan 1/2"
81045	1 bits adaptor 1/2"-5/16"
8074 16...20,6	2 bougiedoppen, douilles bougie 16-21 mm
15430 07...14	5/16" hex 7-8-10-12-14 (30mmL)
15630 40...60	5/16" TX T40-T45-T50-T55 (30mmL)
15330 08...12	5/16" plat 8-10-12 mm (30mmL)
15130 3...4	5/16" PH 3-PH4 (30mmL)
15230 3...4	5/16" PZ 3-PZ4 (30mmL)



FOR 41082-5

1/4" - 1/2" Kombinatieset 108 delig 6 kant

1/4" - 1/2" Jeu de combinaison 108 pcs 6 pans

5270 04...14	1/4" doppen 4-4,5-5,5-6-7-8-9-10-11-12-13-14 mm
52750 06...13	1/4" lange doppen 6-7-8-9-10-11-12-13 mm
32432 03...6	1/4" inbus 3-4-5-6 mm
32332 04...065	1/4" plat 4-5,5-6,5 mm
32132 1...2	1/4" PH 1-PH2
32232 1...2	1/4" PZ 1-PZ2
32632 08...30	1/4" TX T10-T15-T20-T25-T27-T30
764	3 inbusleutel 1,5-2-2,5 mm
526 04...08	1/4" 5-E doppen E4-E5-E6-E7-E8
80222	1/4" ratel 72t
8042 050...100	1/4" 2 verlengstukken, rallonge 50-100 mm
80521	1/4"kniegewricht, cardan universeel 1/4"
8143	steekhecht, manche tournevis
547 10...32	1/2" doppen 10-11-12-13-14-15 16-17-18-19-20-21-22-24-27-30-32 mm
54777 14...22	1/2" 14-15-17-19-22 mm (77mmL)
546 10...24	1/2" E10-E11-E12-E14 - E16-E18-E20-E24
80242	1/2" ratel, cliquet 72t
8044 125...250	1/2" verlengstukken, rallonge 125 mm-250 mm
80634	1 adaptor 1/2"-3/8"
80541	1/2" kniegewricht, cardan universeel 1/2"
81045	1 bits adaptor 1/2"-5/16"
8074 16...20,6	1/2" 2 bougiedoppen, douilles pour bougie 16-21 mm
15430 07...14	5/16" hex 7-8-10-12-14
15630 40...60	5/16" TX T40-T45-T50-T55
15330 08...12	5/16" plat 8-10-12 mm
15130 3...4	5/16"PH 3-PH4
15230 3...4	5/16" PZ 3-PZ4



Doppensets inch maten - Jeu de douilles 1/2" en pouce

FOR 4127

1/2" Doppenset op rail 6 kant 12 delig inch maten
1/2" Jeu de douilles en pouce sur rail 6 pans 12 pcs



545 5.16"....1"	5/16"-3/8" -7/16"-1/2"-9/16"-5/8"-11/16"-3/4"- 13/16"-7/8"-15/16"-1"
-----------------	---

FOR T4194

TC module met 19 inch doppen 6 kant 1/2"
TC module 19 douilles en pouce 6 pans



545 5.16...1.1/4	5/16"-3/8"-7/16"-15/32"-1/2"-9/16"-19/32"-5/8"- 11/16"-3/4"-25/32"-13/16"-7/8"-15/16"-1"-1-1/16"-1- 1/8"-1 3/16"-1 1/4"
------------------	---

FOR T4248S

TC module met 24 inch doppen 6 kant kort + lang 1/2"
TC module 24 douilles et en pouce 6 pans



545 3.8...1.1.16	6k 3/8"-7/16"-1/2"-9/16"-5/8"-11/16"- 3/4"- 13/16" - 7/8" - 15/16" - 1" - 1 1/16"
54577 3.8.....1.1.16	6k3/8"-7/16"-1/2"-9/16"-5/8"-11/16"- 3/4" - 13/16" - 7/8" - 15/16" - 1" - 1 1/16" (77mmL)

FOR 4246S

1/2" Doppenset 24 delig 6 kant inch
1/2" Jeu de douilles 24 pcs 6 pans et en pouce



547 5/ 16" ... 1-1/4"	5/16"-3/8"-7/16"-1/2"-9/16"-19/32"-5/8"-11/16" 3/4'-25/32'-13/16'-7/8'-15/16'-1'-1 1/16'-1 1/8' 1-3/16'-1 1/4'
80243	ratel, cliquet
8034250	wringstaaf, poignée coulissante
8044125...250	2 verlengstukken 125 mm-250 mm
80541	kniegewricht, cardan universeel
807420.6	bougiedop 20.6 mm, douille pour bougie

FOR 4111S

1/2" Inbus kort op dop 10 delig inch
1/2" Jeu de 10 douilles sur embout hexagonales



344055 5.32...1.2	5/32"-3/16"-7/32"-1/4"-5/16"-3/8"-1/2" (55 mm L)
344065 9.16...5.8	9/16"-5/8" (65 mm L)
344070 3.4	3/4" (70 mm L)

Doppensets - Jeu de douilles 1/2"

FOR 4611-5

1/4" - 1/2" Kombinatieset 60 delig 6 kant

1/4" - 1/2" Jeu de combination 60 pcs 6 pans

525 04.....10	1/4" 4-5-5,5-6-7-8-9-10 mm
52550 08.....10	1/4" douilles longues 8-10 mm (50 mm L)
32432 04.....06	1/4" inbus dop bit 4-5-6 mm
32632 10.....30	1/4" torx T10-T20-T25-T30
32132 1.....2	1/4" philips PH1-PH2-PH3
32332 04.....07	1/4" plat 4-5,5 mm
80222	1/4" ratel, cliquet 1/4"
8042 050.....150	1/4" verlengstuk, rallonge 50-150 mm
80521	1/4" kniegewricht, cardan universeel
8143	steekhecht, manche tournevis
764-4	4 allensleutels, clés allen 1,25-1,5-2,-2,5 mm
545 10.....32	1/2" 10-11-12-13-14-15-17-19-22-24-30-32 mm
54577 12.....17	1/2" lange doppen 12-13-17 mm (77mmL)
344100 07.....10	1/2" inbus dop bit 7-8-10 mm (100 mm L)
346055 40.....50	1/2" torx dop bit T40-T45-T50 (55 mm L)
341553	1/2" philips dop bit PH3
34305508	1/2" plat dop bit 8 mm
80242	1/2" ratel, cliquet 1/2"
8074 16..20,6	1/2" bougiedoppen 16-20,6 mm
808410	1/2" verlengstuk, rallonge 250 mm
8034250	wringstaaf, poignée coulissante



FOR 41391

1/4" - 1/2" Kombinatieset 139 delig 6 kant

1/4" - 1/2" Jeu de combination 139 pcs 6 pans

525 04.....13	1/4" 4-5-6-7-8-9-10-11-12-13 mm doppen
80222	1/4" ratel, cliquet 1/4"
8042 050.....100	1/4" verlengstuk, rallonge 50-100 mm
80521	1/4" kniegewricht, cardan universeel
8143	steekhecht, manche tournevis
8032115	wringstaaf 115mm
8111	flexibel verlengstuk 145mm
81022	bithouder 1/4" x 1/4"
545 10.....32	1/2" 10-11-12-13-14-15-16-17-18-19-20-21-22-23-24-27-30-32 mm
80243	1/2" ratel, cliquet 1/2"
8074 16..20,6	1/2" bougiedoppen 16-20,6 mm
8044 75...250	1/2" verlengstuk 75-250mmL, rallonge 75-250 mm
8014380	1/2" wringstaaf met kniegewricht
80521	1/2" kniegewricht
81045	adapter 1/2" x 5/16"
121300..2 - 122301..2	1/4" PH0-PH1-PH2 (30mmL) - PZ1-PZ2
151303..4 - 152303..4	5/16" PH3-PH4 (30mmL) - PZ3-PZ4
12330 04...065	1/4" 4-5-5,5-6,5mm (30mmL) plat
15330 08...12	5/16" 8-10-12mm (30mmL) plat
12430 03...08	1/4" 3-4-5-6-8mm (30mmL) inbus-hex
15430 04...12	5/16" 4-5-6-7-8-10-12mm (70mmL) inbus-hex
12630 08...30	1/4" T8-T10-T15-T20-T25-T27-T30 (30mmL) torx
15630 40...55	5/16" T40-T45-T50-T55 (30mmL)
60219200-60225220	beitels 19mm-25mm
604...	pendrijvers 2-3-4-5
6064185	doorslag 4 (185mmL)
611B175	kombinatietang 175mm - pince universelle
613B250	waterpomptang - pince multiprice 250mm
616300	hamer - marteau 300gr
6806	kabelschoentang + terminal pack
71125 - 7112	PH2 (25mmL) - PH 2 (100mmL)
7130655 - 713065	plat 6,5mm (25mmL) 6,5mm (150mmL)
steekringsleutels	6-7-8-9-10-11-12-13-14-15-16-17-19-22-24-27mm



Doppensets inbus - Jeu de douilles hex 1/2"

FOR 4111

1/2" Inbus kort op dop 10 delig
1/2" Jeu de 10 douilles sur embout hexagonales



344055 04....12	4-5-6-7-8-10-12 mm (55 mm L)
34406514	14 mm (65 mm L)
344070 17...19	17-19 mm (70 mm L)



FOR 40715

1/2" Inbus kort op dop op rail 7 delig
1/2" Jeu de 7 douilles sur embout hexagonales sur rail



344055 05....12	5-6-7-8-10-12 mm (55 mm L)
34406514	14 mm (65 mm L)



FOR 4092

1/2" Inbus lang op dop 8 delig
1/2" Jeu de 8 douilles sur embout hex longues



344110 05...17	5-6-7-8-10-12-14-17 (110 mm L)
-----------------------	--------------------------------



FOR 40715L

1/2" Inbus lang op dop 7 delig op rail
1/2" Jeu de 7 douilles sur embout hex longues sur rail



344110 05...14	5-6-7-8-10-12-14 (110 mm L)
-----------------------	-----------------------------



FOR T41710

TC module 1/2" inbusdoppenset 17 delig
TC module 17 douilles hexagonales 1/2"



344055 05...19	5-6-7-8-9-10-12-14-17-19 mm (55 mm L)
344100 05...14	5-6-7-8-10-11-12-13-14 mm (100 mm L)
34411017	17 mm (110 mm L)

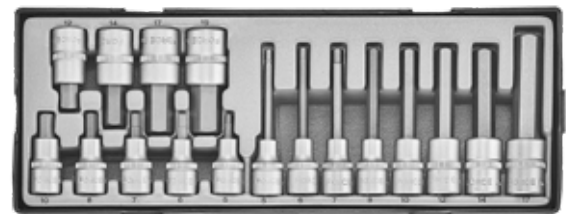

FOR 4206

1/2" Inbusdoppenset 20 delig in pvc koffer
1/2" Jeu de douilles hexagonales 20 pcs



344055 05...19	5-6-7-8-9-10-12-14-17-19 mm (55 mm L)
344100 05...14	5-6-7-8-10-11-12-13-14 mm (100 mm L)
34411017	17 mm (110 mm L)



Doppensets torx - Jeu de douilles 1/2"

FOR 40717

1/2" Torx doppenset 7delig
1/2" Jeu de 7 douilles torx



346055 30...70	T30-T40-T45-T50-T 55-T60-T70 (55mmL)
----------------	--------------------------------------



FOR 40913L

1/2" Torx lange doppenset 9delig
1/2" Jeu de 9 douilles torx longues



3460100 20...60	T20-T25-T27-T30-T40-T45-T50-T 55-T60 (100mmL)
-----------------	---



FOR 4172

1/2" Torx doppenset 16 delig inwendig-uitwendig
1/2" Jeu de 16 douilles torx



546 10...20	E10-E11-E12-E14-E16-E18-E20-E22-E24
346055 40...70	T40-T45-T47-T50-T 55-T60-T70



FOR 4192

3/8" - 1/2" Torx doppenset 18 delig inwendig-uitwendig
3/8" - 1/2" Jeu de 18 douilles torx



536 10...18	3/8" E10-E11-E12-E14-E16-E18
546 20...24	1/2" E20-E22-E24
336050 20...40	3/8" T20-T25-T27-T30-T40 (50 mm L)
346055 45...60	1/2" T45-T50-T55-T60 (55 mm L)



FOR 4093

1/2" Torx doppenset 9 delig inwendig
1/2" Jeu de 9 douilles torx



546 10...24	E10-E11-E12-E14-E16-E18-E20-E22-E24
-------------	-------------------------------------



FOR 4041

1/2" Torx dop bitset 4 delig op rail
1/2" Jeu de 4 douilles torx sur rail



346100 40...70	T40-T45-T55-T70 (100 mm L)
----------------	----------------------------



FOR 4068

1/2" Resistorx dop bitset 6 delig
1/2" Jeu de 6 douilles resistorx



347 100 20...50	T20H-T25H-T30H-T40H-T45H-T50H (100 mm L)
-----------------	--



FOR 4263

1/2" Torx doppenset 26 delig in pvc koffer
1/2" Jeu de douilles torx 26 pcs



346055 20...70	T20-T25-T27-T30-T35-T40-T45-T47-T50-T55-T60-T70 (55 mm L)
346100 20...100	T20-T25-T27-T30-T40-T45-T50-T55-T60-T70-T80-T90-T100 (100 mm L)
34614060	T60 (140 mm L)

FOR T4165

TC module 1/2" Torx doppenset 16 delig
TC module 16 douilles torx 1/2"



346055 27...70	T27-T30-T40-T45-T50-T55-T60-T70 (55 mm L)
346100 27...70	T27-T30-T40-T45-T50-T55-T60-T70 (100 mm L)

FOR T4413

TC module assortiment torx 41 delig
TC module 41 assortiment torx



76610...70	Torx sleutel T10 tot T70
32632 08..40	1/4" Torx dop bit
	T8-T9-T10-T15-T20-T25-T27-T30-T40
33650 45..50	3/8" Torx dop bit T45-T50 (50 mm L)
34614055	1/2" Torx dop T55 (140 mm L)
34610060	1/2" Torx dop T60 (100 mm L)
34610070	1/2" Torx dop T70 (100 mm L)
526 04..10	1/4" Torx dop E4-E5-E6-E7-E8-E10
536 10..20	3/8" Torx dop E10-E11-E12-E14-E16-E18-E20
546 22..24	1/2" Torx dop E22-E24

FOR T4322

TC Module met 32 torx + XZN assortiment 1/2"
TC Module 32 douilles torx + XZN 1/2"



546 10...24	E10-E11-E12-E14-E16-E18-E20-E24
54677 10...24	E10-E11-E12-E14-E16-E18-E20-E24 torx (77mmL)
346055 50...70	T50-T55-T60-T70 (55mmL)
347055 50...70	T50H-T55H-T60H-T70H resistorx (55mmL)
348055 08...16	M5-M6-M8-M10-M12-M14-M16 XZN (55mmL)

FOR T4122

TC Module met 12 torx + inbus assortiment 1/2"
TC Module 12 douilles torx + hex 1/2"



34418005	5mm (180mmL)
344100 06....08	6-7-8mm (100mmL)
346120 40...45	T40-T45 (120mmL)
346140 55..70	T55-T70 (140mmL)
348100 06...12	M6-M8-M10-M12 XZN (100mmL)

Doppensets - Jeu de douilles 1/2"

FOR T4116

TC Module met 11 torx + XZN + inbus assortiment 1/2"
TC Module 11 douilles torx + XZN + hex 1/2"

34418005..06	inbus 5mm (180mmL) inbus 6mm (160mmL) 7mm (100mmL) inbus 8mm (120mmL) 10mm (140mmL)
346140 40...45	T40-T45 (140mmL)
34610070	T70 (100mmL)
348100 08...10	M8-M10 XZN (100mmL)
34814012	M12 XZN (140mmL)



FOR T4281

TC Module met 28 torx + XZN + inbus assortiment 1/2"
TC Module 28 douilles torx + XZN + hex 1/2"

344055 04..12	inbus 4-5-6-7-8-10-12mm (55mmL)
34406514	inbus 14mm (65mmL)
34407017	inbus 17mm (70mmL)
34408008	inbus 8mm (80mmL)
34414010	inbus 10mm (140mmL)
348055 05...16	M5-M6-M8-M10-M12-M14-M16 XZN (55mmL)
348110 10..12	M10-M12 XZN (110mmL)
34812005	M8 XZN (120mmL)
33405040 04..10	3/8" inbus dop 4-5-6-7-8-10mm (50mmL)

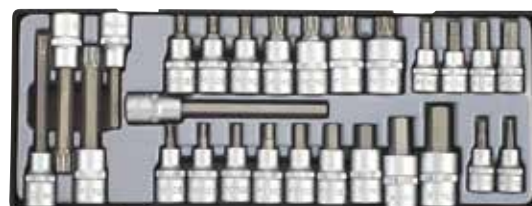

FOR T4355

TC Module met 35 torx + XZN + inbus assortiment 1/2"
TC Module 35 douilles torx + XZN + hex 1/2"

344055 05..12	inbus 5-6-7-8-10-12mm (55mmL)
34406514	inbus 14mm (65mmL)
34407017...19	inbus 17mm-19mm (70mmL)
346055 27...70	torx T27-T30-T40-T45-T50-T55-T60-T70 (55mmL)
348055 05...16	M5-M6-M8-M10-M12-M14-M16 XZN (55mmL)
54610....24	E10-E11-E12-E14-E16-E18-E20-E22-E24
34805516T	M16 XZN (55mmL)



FOR 40716

1/2" XZN dop-bitset 7 delig op rail
1/2" Jeu de 7 douilles XZN sur rail

348055 05....14	M5-M6-M8-M9-M10-M12-M14 XZN (55 mm L)
------------------------	---------------------------------------



FOR 40811

1/2" XZN dop-bitset 8 delig
1/2" Jeu de 8 douilles XZN

348055 05....16	M5-M6-M8-M9-M10-M12-M14-M16 XZN (55 mm L)
------------------------	---



Doppensets XZN- Jeu de douilles 1/2" XZN

FOR 40716L

1/2" Dop bit set XZN 7 delig
1/2" Jeu de 7 douilles XZN



348100 05....14	M5-M6-M8-M9-M10-M12-M14 (100 mm L)
------------------------	------------------------------------



FOR 4061

1/2" Dop bit set XZN 6 delig
1/2" Jeu de 6 douilles XZN



348055 06....10	M6-M8-M10 (55 mm L)
348100 08....12	M8-M10-M12 (100 mm L)

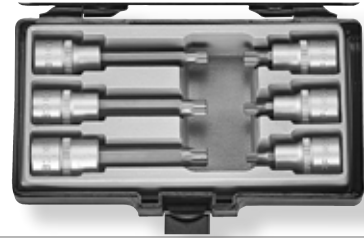

FOR T4179

TC Module 1/2" Dop bit set XZN 17 delig
TC module 17 douilles XZN



348055 05....10	M5-M6-M8-M9-M10-M12-M14-M16 (55 mm L)
348100 08....12	M5-M6-M8-M9-M10-M12-M14-M16 (100 mm L)
34805516T	M16(55mmL)

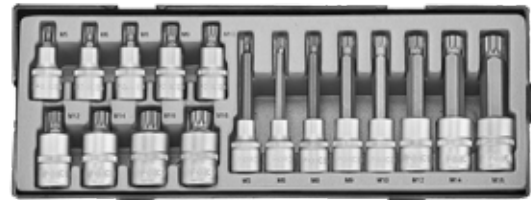

FOR 4285

1/2" XZN doppenset 28 delig in pvc koffer
1/2" Jeu de 28 douilles XZN



348055 05....16	M5-M6-M8-M9-M10-M12-M14-M16 (55 mm L)
348100 05....18	M5-M6-M8-M9-M9.5-M10-M12-M14-M16-M18 (100 mm L)
348140 08...14	M8-M9-M10-M12-M14 (140mmL)
348055 14T....16T	M14-M16 (55 mm L) veiligheidsbit
34810016T	M16 (100mmL) veiligheidsbit
678	M10 alternator tools M10 (110mmL)



FOR 4266

1/2" Special doppenset 26 delig in pvc koffer
1/2" Jeu de douilles special 26 pcs

34410011-13	inbus 11-13 mm (100mmL)	34814008...12	XZN M8-M9-M10-M12 (140 mm L)
34414010	inbus 10mm (140mmL)	34805516T	XZN M16 (55mmL) veiligheidsbit
34610060-70	Torx T60-T70 (100mmL)	34810016T	XZN M16 (100 mm L)
34614060	Torx T60 (140mmL)	34910013	Ribe M13 (100 mm L)
34710055	Resistorx T55 (100 mmL)	34912012	Ribe M12 (120 mm L)
34710570	Resistorx T70 (105mmL)	34914009	Ribe M9 (140 mm L)
34713030	Resistorx T30 (130mmL)	34914010	Ribe M10 (140 mm L)
34714080	Resistorx T80 (140mm L)	674	M10 alternator tools
34810014	XZN 14 (100mmL)	678	T50 x 110 mm L
34812009	XZN 9 (120mmL)		



FOR 40915

1/2" Dop bit set ribe 9 delig
1/2" Jeu de 9 douilles ribe

349 100 05...14	M5-M6-M7-M8-M9-M10-M12-M13-M14 (100 mm L)
------------------------	---



Doppen 1/2" - Douilles 1/2"

Art.nr	mm	L mm
FOR 54508	8 mm	38
FOR 54509	9 mm	38
FOR 54510	10 mm	38
FOR 54511	11 mm	38
FOR 54512	12 mm	38
FOR 54513	13 mm	38
FOR 54514	14 mm	38
FOR 54515	15 mm	38
FOR 54516	16 mm	38
FOR 54517	17 mm	38
FOR 54518	18 mm	38
FOR 54519	19 mm	38
FOR 54520	20 mm	38
FOR 54521	21 mm	38
FOR 54522	22 mm	38
FOR 54523	23 mm	40
FOR 54524	24 mm	40
FOR 54525	25 mm	43
FOR 54526	26 mm	43
FOR 54527	27 mm	43
FOR 54528	28 mm	43
FOR 54529	29 mm	45
FOR 54530	30 mm	45
FOR 54532	32 mm	45
FOR 54534	34 mm	45
FOR 54536	36 mm	45



Doppen 6 kant 1/2"
Douilles 6 pans 1/2"



Art.nr	mm	L mm
FOR 54908	8 mm	38
FOR 54910	10 mm	38
FOR 54911	11 mm	38
FOR 54912	12 mm	38
FOR 54913	13 mm	38
FOR 54914	14 mm	38
FOR 54915	15 mm	38
FOR 54916	16 mm	38
FOR 54917	17 mm	38
FOR 54918	18 mm	38
FOR 54919	19 mm	38
FOR 54920	20 mm	38
FOR 54921	21 mm	38
FOR 54922	22 mm	38
FOR 54923	23 mm	40
FOR 54924	24 mm	40
FOR 54925	25 mm	43
FOR 54926	26 mm	43
FOR 54927	27 mm	43
FOR 54928	28 mm	43
FOR 54929	29 mm	45
FOR 54930	30 mm	45
FOR 54932	32 mm	45



Doppen 12 kant 1/2"
Douilles 12 pans 1/2"



Doppen inch 1/2" - Douilles inch 1/2"

Art.nr	mm	L mm
FOR 545.16	5/16"	38
FOR 5453.8	3/8"	38
FOR 5457.16	7/16"	38
FOR 54515.32	15/32"	38
FOR 5451.2	1/2"	38
FOR 5459.16	9/16"	38
FOR 54519.32	19/32"	38
FOR 5455.8	5/8"	38
FOR 54511.16	11/16"	38
FOR 5453.4	3/4"	38
FOR 54525.32	25/32"	38
FOR 54513.16	13/16"	38
FOR 5457.8	7/8"	38
FOR 54515.16	15/16"	40
FOR 5451.0	1.0"	43
FOR 5451.1.16	1.1.16"	43
FOR 5451.1.8	1.1.8"	45
FOR 5451.3.16	1.3.16"	45
FOR 5451.1.4	1.1.4"	45



Doppen 6 kant inch 1/2"
Douilles 6 pans en pouce 1/2"



FOR 545773.8	3/8"	77
FOR 545777.16	7/16"	77
FOR 544771.2	1/2"	77
FOR 545779.16	9/16"	77
FOR 545775.8	5/8"	77
FOR 5457711.16	11/16"	77
FOR 545773.4	3/4"	77
FOR 5457713.16	13/16"	77
FOR 545777.8	7/8"	77
FOR 5457715.16	15/16"	77
FOR 545771.0	1.0"	77
FOR 545771.1.16	1"1/16"	77



Lange inch doppen 6 kant 1/2"
Douilles longues 6 pans en pouce 1/2"



Doppen 1/2" - Douilles 1/2"

Art.nr	mm	L mm
FOR 5457708	8 mm	77
FOR 5457709	9 mm	77
FOR 5457710	10 mm	77
FOR 5457711	11 mm	77
FOR 5457712	12 mm	77
FOR 5457713	13 mm	77
FOR 5457714	14 mm	77
FOR 5457715	15 mm	77
FOR 5457716	16 mm	77
FOR 5457717	17 mm	77
FOR 5457718	18 mm	77
FOR 5457719	19 mm	77
FOR 5457720	20 mm	77
FOR 5457721	21 mm	77
FOR 5457722	22 mm	77
FOR 5457723	23 mm	77
FOR 5457724	24 mm	77
FOR 5457725	25 mm	77
FOR 5457726	26 mm	77
FOR 5457727	27 mm	77
FOR 5457728	28 mm	77
FOR 5457729	29 mm	77
FOR 5457730	30 mm	77
FOR 5457732	32 mm	77



Lange doppen 6 kant 1/2"
Douilles longues 6 pans 1/2"



Art.nr	mm	L mm
FOR 5497708	8 mm	77
FOR 5497709	9 mm	77
FOR 5497710	10 mm	77
FOR 5497711	11 mm	77
FOR 5497712	12 mm	77
FOR 5497713	13 mm	77
FOR 5497714	14 mm	77
FOR 5497715	15 mm	77
FOR 5497716	16 mm	77
FOR 5497717	17 mm	77
FOR 5497718	18 mm	77
FOR 5497719	19 mm	77
FOR 5497720	20 mm	77
FOR 5497721	21 mm	77
FOR 5497722	22 mm	77
FOR 5497723	23 mm	77
FOR 5497724	24 mm	77
FOR 5497725	25 mm	77
FOR 5497726	26 mm	77
FOR 5497727	27 mm	77
FOR 5497728	28 mm	77
FOR 5497729	29 mm	77
FOR 5497730	30 mm	77
FOR 5497732	32 mm	77



Lange doppen 12 kant 1/2"
Douilles longues 12 pans 1/2"



Art.nr	mm	L mm
FOR 54608	E8	38
FOR 54610	E10	38
FOR 54611	E11	38
FOR 54612	E12	38
FOR 54614	E14	38
FOR 54616	E16	38
FOR 54618	E18	38
FOR 54620	E20	38
FOR 54622	E22	38
FOR 54624	E24	40



Torx doppen inwendig 1/2"

Douilles torx 1/2"



Art.nr	mm	L mm
FOR 5467710	E10	77
FOR 5467711	E11	77
FOR 5467712	E12	77
FOR 5467714	E14	77
FOR 5467716	E16	77
FOR 5467718	E18	77
FOR 5467720	E20	77
FOR 5467722	E22	77
FOR 5467724	E24	77



Lange torx doppen inwendig 1/2"

Douilles torx longues 1/2"



Art.nr	mm	L mm
FOR 34605520	T20	55
FOR 34605525	T25	55
FOR 34605527	T27	55
FOR 34605530	T30	55
FOR 34605535	T35	55
FOR 34605540	T40	55
FOR 34605545	T45	55
FOR 34605547	T47	55
FOR 34605550	T50	55
FOR 34605555	T55	55
FOR 34605560	T60	55
FOR 34605570	T70	55
FOR 34607080	T80	70
FOR 34610020	T20	100
FOR 34610025	T25	100
FOR 34610027	T27	100
FOR 34610030	T30	100
FOR 34610040	T40	100
FOR 34610045	T45	100
FOR 34610050	T50	100
FOR 34610055	T55	100
FOR 34610060	T60	100
FOR 34610070	T70	100
FOR 34610080	T80	100
FOR 34610090	T90	100
FOR 346100100	T100	100
FOR 34612040	T40	120
FOR 34612045	T45	120
FOR 34614045	T45	140
FOR 34614050	T50	140
FOR 34614055	T55	140
FOR 34614060	T60	140
FOR 34614070	T70	140
FOR 346140100	T100	140
FOR 34611050R	T50	110



Torx doppen 1/2"

Douilles torx 1/2"



Art.nr	mm	L mm
FOR 34705520	T20H	55
FOR 34705527	T27H	55
FOR 34705530	T30H	55
FOR 34705540	T40H	55
FOR 34705545	T45H	55
FOR 34705550	T50H	55
FOR 34705555	T55H	55
FOR 34705560	T60H	55
FOR 34705570	T70H	55
FOR 34707080	T80H	70
FOR 34710030	T30H	100
FOR 34710040	T40H	100
FOR 34710045	T45H	100
FOR 34710050	T50H	100
FOR 34710055	T55H	100
FOR 34710060	T60H	100
FOR 34710070	T70H	100
FOR 348100100	T100H	100
FOR 34713030	T30H	130
FOR 34714050	T50H	140



Resistorx doppen 1/2" Douilles Resistorx 1/2"



Art.nr	mm	L mm
FOR 34805505	M5	55
FOR 34805506	M6	55
FOR 34805508	M8	55
FOR 34805509	M9	55
FOR 34805510	M10	55
FOR 34805512	M12	55
FOR 34805514	M14	55
FOR 34805516	M16	55
FOR 34810005	M5	100
FOR 34810006	M6	100
FOR 34810008	M8	100
FOR 34810009	M9	100
FOR 34810010	M10	100
FOR 34810012	M12	100
FOR 34810014	M14	100
FOR 34810016	M16	100
FOR 34810018	M18	100
FOR 34812008	M8	120
FOR 34812010	M10	120
FOR 34814008	M8	140
FOR 34814010	M10	140
FOR 34814012	M12	140
FOR 34814014	M14	140
FOR 34880008	M8	800
FOR 34880010	M10	800



XZN doppen 1/2" Douilles XZN 1/2"



Extra lange Spline dopsleutel voor montage van aandrijfasschroeven vanaf de buitenzijde door de wielkast bij VW en Audi. Spaart kostbare tijd en geen zware verlengstukken meer nodig.

XZN doppen magnetisch 1/2"

Douilles XZN magnetique 1/2"

Art.nr	mm	L mm
FOR 34805514T	M14	55
FOR 34805516T	M16	55
FOR 34810016T	M16	100



Art.nr	mm	L mm
FOR 34405504	4	55
FOR 34405505	5	55
FOR 34405506	6	55
FOR 34405507	7	55
FOR 34405508	8	55
FOR 34405509	9	55
FOR 34405510	10	55
FOR 34405512	12	55
FOR 34406514	14	65
FOR 34407017	17	70
FOR 34407019	19	70
FOR 34408008	8	80
FOR 34410005	5	100
FOR 34410006	6	100
FOR 34410007	7	100
FOR 34410008	8	100
FOR 34410009	9	100
FOR 34410010	10	100
FOR 34410011	11	100
FOR 34410012	12	100
FOR 34411005	5	110
FOR 34411006	6	110
FOR 34411007	7	110
FOR 34411008	8	110
FOR 34411010	10	110
FOR 34411012	12	110
FOR 34411014	14	110
FOR 34411017	17	110
FOR 34411019	19	110
FOR 34412008	8	120
FOR 34414006	6	140
FOR 34414008	8	140
FOR 34414010	10	140
FOR 34416006	6	160
FOR 34418005	5	180
FOR 34422006	6	220



Inbus doppen 1/2"

Douilles hexagonales 1/2"



Art.nr		L mm
FOR 3440555.32	5/32"	55
FOR 3440553.16	3/16"	55
FOR 3440557.32	7/32"	55
FOR 3440555.16	5/16"	55
FOR 3440553.8	3/8"	55
FOR 3440557.16	7/16"	55
FOR 3440559.16	9/16"	65
FOR 3440555.8	5/8"	32
FOR 3440553.4	3/4"	70



Inbus doppen 1/2" inch

Douilles hexagonales en pouce 1/2"



Onderdelen - Accessoires 1/2"

Art.nr	mm	L mm
FOR 34910005	M5	100
FOR 34910006	M6	100
FOR 34910007	M7	100
FOR 34910008	M8	100
FOR 34910009	M9	100
FOR 34910010	M10	100
FOR 34910012	M12	100
FOR 34910013	M13	100
FOR 34910014	M14	100
FOR 34910016	M16	100
FOR 34912009	M9	120



Ribe doppen 1/2"
Douilles Ribe 1/2"



Art.nr	mm	L mm
FOR 807416	16	63
FOR 807418	18	63
FOR 807420.6	20.6	63
FOR 807414M	14	70
FOR 807416M	16	70
FOR 807418M	18	70
FOR 807420.6M	20.6	70

M - magnetisch
M = magnétique

Bougiedop 6 1/2"
Douilles pour bougies 1/2"



Art.nr		L mm
FOR 819409	9 doppen	260
FOR 819414M	14 doppen	magnetisch



Rail voor doppen 1/2"
Rail pour douilles 1/2"



FOR 4049

1/2" Verlengstukken 4 delig
1/2" Jeu de 4 rallonges

8044 75...250	75mmL-125mmL-150mmL-250mmL
----------------------	----------------------------



Verloopstuk 1/2" Adaptateur 1/2"



Art.nr	mm	L mm
FOR 80943	1/2" x 3/8"	46
FOR 80946	1/2" x 3/4"	46
FOR 80634	3/8" x 1/2"	46

Adapter Porte-embouts



Art.nr	mm	L mm
FOR 81042	1/2" x 1/4"	38
FOR 81045	1/2" x 5/16"	38
FOR 81047	1/2" x 10 mm	38
FOR 810414	1/2" x 14 mm	38

Kniegewricht 1/2" Cardan universel 1/2"



Art.nr		L mm
FOR 80541		70

Verlengstuk 1/2" Rallonges 1/2"



Art.nr		L mm
FOR 8044050		50
FOR 8044075		75
FOR 8044125		125
FOR 8044250		250
FOR 8044500		500
FOR 8044050W	wobble	50
FOR 8044125W	wobble	125
FOR 80441250W	wobble	250

Wringstaaf met schuifstuk 1/2" Poignée coulissante 1/2"



Art.nr		L mm
FOR 8034250		250
FOR 803A4300		300

Wringstaaf met kniegewricht 1/2" Poignée articulée 1/2"



Art.nr		L mm
FOR 8014380		380
FOR 8014380P	herstelkit	kit rep.

Verlengstuk met kniegewricht 1/2" Rallonges à cardan 1/2"



Art.nr		L mm
FOR 8044500U		500
FOR 8044700U		500

Wringstaaf met kniegewricht 1/2" Poignée articulée 1/2"



Art.nr		L mm
FOR 8014600		600
FOR 8014600P	repair set	kit rep.

Ratels - cliquets 1/2"

Ratel met ronde kop 1/2"
Cliquet 1/2"



Art.nr	tanden	L mm
FOR 80249	72	270
FOR 80249P	herstelkit	kit rep.

Ratel knikbaar 1/2"
Cliquet flexible 1/2"



Art.nr	tanden	L mm
FOR 802423	72	312
FOR 802423P	herstelkit	kit rep.

Ratel met ronde kop 1/2"
Cliquet 1/2"



Art.nr	tanden	L mm
FOR 802422	72	267
FOR 802422P	herstelkit	kit rep.

Ratel 1/2"
Cliquet 1/2"



Art.nr	tanden	L mm
FOR 80242	24	275
FOR 80243	24	2
FOR 80242P	herstelkit	kit rep.
FOR 80243P	herstelkit	kit rep.

Ratel met kniegewricht 1/2"
Cliquet flexible 1/2"



Art.nr	tanden	L mm
FOR 802418	36	306
FOR 802418P	herstelkit	

Ratel 1/2"
Cliquet 1/2"



Art.nr	tanden	L mm
FOR 802415	36	255
FOR 802415P	kit rep.	
FOR 80248	72	265
FOR 80248P	kit rep	

L hendel 1/2"
Manche "L" 1/2"



Art.nr		L mm
FOR 815A4315		315

Aanpasbare hendel 1/2"
Poignée 1/2"



Art.nr		L mm
FOR 8334300		310

Ratel 1/2"
Cliquet 1/2"



Art.nr		L mm
FOR 802433		330

Ratel 1/2" + aanpasbare hendel
Cliquet 1/2" + poignée



Art.nr	Normal	L mm
FOR 802434	435 mm	680 mm

Doppensets - Jeu de douilles 3/4"

FOR 6201 5

3/4" Doppenset 20 delig 6 kant in metalen koffer
3/4" Coffret de 20 pcs douilles 6 pans mm

565 19....50	19-21-22-23-24-26-27-29-30-32-35-36-38-41-46-50
8026500	1 ratel, cliquet 500 mm L
8036450	1 wringstaaf, manche en T 450 mm L
8046100	verlengstuk, rallonge 100 mm
8046200	verlengstuk, rallonge 200 mm



FOR 6201

3/4" Doppenset 20 delig 12 kant in metalen koffer
3/4" Jeu de douilles 20 pcs 12 pans

FOR 6233-5

3/4" Doppenset 23 delig 6 kant in metalen koffer
3/4" Coffret de 23 pcs douilles 6 pans

565 19....50	19-21-22-24-27-28-30-32-33-34-35-36-38-41-46-50-55 mm
8026500	1 ratel, cliquet 500 mm L
8036450	1 wringstaaf, manche en T 450 mm L
8046 125-200-400	verlengstuk, rallonge 125-200-400mm



FOR 6233

3/4" Doppenset 23 delig 12 kant in metalen koffer
3/4" Jeu de douilles 23 pcs 12 pans

FOR F6213 (10217-10218)

Doppenset 3/4" 6 kant - 21 delig foam
Module mousse 21 outils 6 pans 3/4"

565 19...50	19-21-22-23-24-26-27-29-30-32-35-36-38-41-46-50
8046100	verlengstuk, rallonge 100 mm
8046200	verlengstuk, rallonge 200 mm
8026500	ratel, cliquet 500 mm
80968	adapter, adaptateur



FOR F6342 - Jumbo (10318)

Kombinatieset 3/4" 34 delig 12 kant FOAM
Module mousse 34 outils 3/4" 12 pans

364080 14...22	3/4" Inbus dop 14-16-17-19-22mm (80mml)
366080 60....100	3/4" Torx dop T60-T70-T80-T90-T100 (80mml)
569 17...50	3/4" 12k 17-19-21-22-23-24-27-30-32-33-34-35-36-38-41-46-50mm
8026500	3/4" Ratel, cliquet
8036500	3/4" Wringstaaf met schuifstuk 500mml, poignée
8046200	3/4" Verlengstuk 200mml - rallonge
8046400	3/4" Verlengstuk 400mml - rallonge
80946	Adapter 1/2" x 3/4"
80986	Adapter 1" x 3/4"
8156450	L hendel 450mml



Onderdelen - Accessoires 3/4"

Art.nr	mm	L mm
FOR 56519	19	50
FOR 56521	21	50
FOR 56522	22	50
FOR 56523	23	50
FOR 56524	24	51
FOR 56526	26	52
FOR 56527	27	52
FOR 56528	28	52
FOR 56529	29	52
FOR 56530	30	54
FOR 56532	32	56
FOR 56533	33	56
FOR 56534	34	56
FOR 56535	35	58
FOR 56536	36	58
FOR 56538	38	60
FOR 56540	40	62
FOR 56541	41	64
FOR 56546	46	68
FOR 56550	50	72
FOR 56555	55	76
FOR 56560	60	78



Doppen 6 kant 3/4"
Douilles 6 pans 3/4"



Art.nr	mm	L mm
FOR 56919	19	50
FOR 56921	21	50
FOR 56922	22	50
FOR 56923	23	50
FOR 56924	24	51
FOR 56926	26	52
FOR 56927	27	52
FOR 56928	28	52
FOR 56929	29	52
FOR 56930	30	54
FOR 56932	32	56
FOR 56933	33	56
FOR 56934	34	56
FOR 56935	35	58
FOR 56936	36	58
FOR 56938	38	60
FOR 56941	41	64
FOR 56946	46	68
FOR 56950	50	72
FOR 56955	55	76
FOR 56960	60	78
FOR 56965	65	82



Doppen 12 kant 3/4"
Douilles 12 pans 3/4"



Art.nr	mm	L mm
FOR 36408017	17	80
FOR 36408019	19	80
FOR 36408022	22	80

Doppen inbus 3/4"
Douilles hex 3/4"



Art.nr	L mm	gewicht/poids
FOR 8046100	100	417gr
FOR 8046200	200	740gr
FOR 8046400	400	1358gr

Verlengstuk 3/4"
Rallonge 3/4"



Art.nr	L mm	gewicht/poids
FOR 8036450	450	1388gr
FOR 8036500	500	1514gr

Wringstaaf 3/4"
Poignée coulisante 3/4"



Art.nr	L mm	gewicht/poids
FOR 8016475	475 mm	1900gr
FOR 80161000	1000 mm	3670gr
FOR 80161000P	repair kit	

Wringstaaf met kniegewricht 3/4"
Poignée articulée 3/4"



Art.nr	L mm	gewicht/poids
FOR 8026500	500	1970gr
FOR 8026500P	repair kit	

Ratel 3/4" - cliquet



Art.nr		L mm
FOR 80964	3/4" x 1/2"	58
FOR 80968	3/4" x 1"	68

Verloopstuk 3/4"
Adaptateur 3/4"



Art.nr	L mm	gewicht/poids
FOR 80561	109	625gr

Kniegewricht 3/4"
cardan universel 3/4"



Doppenset 1" - Jeu de douilles 1"

FOR 8141

1" Doppenset 14 delig 12 kant in metalen koffer
1" Jeu de douilles 14 pcs 12 pans



589 36....80	36-41-46-50-55-60-65-70-75-80 mm
8028650	1 ratel, cliquet 650 mm L
8038550	1 wringstaaf, poignée coulissante 550 mm L
8048200	verlengstuk, rallonge 200 mm
8048400	verlengstuk, rallonge 400 mm



Art.nr	mm	L mm
FOR 58936	36	65
FOR 58941	41	70
FOR 58946	46	75
FOR 58950	50	75
FOR 58955	55	80
FOR 58960	60	84
FOR 58965	65	87
FOR 58970	70	93
FOR 58975	75	97
FOR 58980	80	103
FOR 58985	85	103



Doppen 12 kant 1"
Douilles 12 pans 1"



Onderdelen - Accessoires 1"

Art.nr	L mm	gewicht/poids
FOR 8048200	200	1330gr
FOR 8048400	400	2290gr

Verlengstuk 1"
Rallonges 1"



Art.nr	L mm	gewicht/poids
FOR 8038550	550	3288gr

Wringstaaf 1"
Poignée coulissante 1"



Art.nr	L mm	gewicht/poids
FOR 8018650	650	4122gr
FOR 80181000	1000	3785gr
FOR 80181000P	repair kit	

Wringstaaf met kniegewricht 1"
Poignée articulée 1"



Art.nr	L mm	gewicht/poids
FOR 8028650	650	4424gr
FOR 8028650P	repair kit	

Ratel 1" - cliquet 24 t



Art.nr	mm	L mm
FOR 80986	1" x 3/4"	74

Verloopstuk 1"
Adaptateur 1"



Art.nr	L mm	gewicht/poids
FOR 80581	143	1237gr

Kniegewricht 1"
Cardan universel 1"













SLAGDOPPENSETS

DOUILLES À CHOC



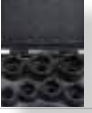

	Slagdoppensets - Jeu de douilles à choc 1/2"	154
	Lange slagdoppen - Douilles à choc longues 1/2"	156
	Slagdoppensets - Jeu de douilles à choc 1/2"	157
	Slagdoppen - Douilles à choc 1/2"	159
	Adapters - Adaptateurs	160
	Slagdoppensets - Jeu de douilles à choc 3/4"	161
	Slagdoppen - Douilles à choc 3/4"	162
	Slagdoppensets - Jeu de douilles à choc 3/4"	163
	Slagdoppen - Douilles à choc 3/4"	164
	Slagdoppen - Douilles à choc 1"	165
	Slaggereedschap - Accessoires à choc	167

Slagdoppensets - Jeu de douilles à choc 1/2"

FOR T4193

TC module 19 slagdoppen 6 kant 1/2"
TC module 19 douilles à choc 6 pans 1/2"



445 10....32	10-11-12-13-14-15-16-17-18-19-21-22-23-24-26-27-30-32 mm
8044125MPB	verlengstuk, rallonge 125 mm



FOR 4109

1/2" Slagdoppenset 6 kant 10 delig
Jeu de 10 douilles à choc 6 pans 1/2"



445 11....24	11-12-13-14-16-17-19-21-22-24 mm
---------------------	----------------------------------



FOR 4166

Koffer 16 slagdoppen 6 kant 1/2"
Coffret de 16 douilles à choc 6 pans 1/2"



445 10....36	10-12-13-14-15-16-17-18-19-21-22-23-24-27-30-32-36 mm
---------------------	---



Art.nr	mm	L mm
FOR 44508	8 mm	38
FOR 44509	9 mm	38
FOR 44510	10 mm	38
FOR 44511	11 mm	38
FOR 44512	12 mm	38
FOR 44513	13 mm	38
FOR 44514	14 mm	38
FOR 44515	15 mm	38
FOR 44516	16 mm	38
FOR 44517	17 mm	38
FOR 44518	18 mm	38
FOR 44519	19 mm	38
FOR 44520	20 mm	38
FOR 44521	21 mm	38
FOR 44522	22 mm	43
FOR 44523	23 mm	43
FOR 44524	24 mm	43
FOR 44525	25 mm	43
FOR 44526	26 mm	43
FOR 44527	27 mm	43
FOR 44528	28 mm	45
FOR 44529	29 mm	45
FOR 44530	30 mm	45
FOR 44531	31 mm	45
FOR 44532	32 mm	45
FOR 44533	33mm	45
FOR 44534	34mm	45
FOR 44535	35mm	45
FOR 44536	36 mm	45
FOR 44538	38 mm	45
FOR 44541	41 mm	45
FOR 44546	46 mm	45

Slagdoppen 6 kant 1/2" Douilles à choc 6 pans 1/2"



Slagdoppen 12 kant 1/2" Douilles à choc 12 pans 1/2"

Art.nr	mm	L mm
FOR 44812	12	38
FOR 44813	13	38
FOR 44817	17	38
FOR 44818	18	38
FOR 44819	19	38
FOR 44824	24	43
FOR 44830	30	43
FOR 44832	32	43
FOR 44834	34	43
FOR 44836	36	43



FOR 4107

1/2" Lange slagdoppenset 6k 10 delig
Jeu de 10 douilles à choc longues 6 pans



44585 11....24	11-12-13-14-16-17-19-21-22-24 mm
-----------------------	----------------------------------



FOR T4119

TC module 11 lange slagdoppen 6 kant 1/2"
TC module 11 douilles à choc longues 6 pans 1/2"



44585 12....32	12-14-17-19-21-22-23-24-27-30-32 mm
-----------------------	-------------------------------------



FOR T40813

TC module 11 lange slagdoppen 12 kant 1/2"
TC module 11 douilles à choc longues 12 pans 1/2"



44885 19....41	19-22-24-27-30-32-36-41 mm
-----------------------	----------------------------



FOR T40813-5

TC module 11 lange slagdoppen 6 kant 1/2"
TC module 11 douilles à choc longues 6 pans 1/2"



44585 19....41	19-22-24-27-30-32-36-41 mm
-----------------------	----------------------------



FOR 4166D

1/2" Lange slagdoppenset 6kant 16 delig
Jeu de 16 douilles à choc longues 6 pans



44585 10....36	10-12-13-14-15-16-17-18-19-21-22-24-27-30-36 mm
-----------------------	---



FOR 40912

1/2" Lange slagdoppenset 12 kant 9 delig
Jeu de 9 douilles à choc longues 12 pans



44885 27....36	27-30-32-34-35-36 mm (85mmL-
244060 14...19	14-17-19mm (60mmL) inbus-hex



Slagdoppen - Douilles à choc 1/2"

Lange slagdoppen 6 kant 1/2"
Douilles à choc longues 6 pans 1/2"

Art.nr	mm	L mm
FOR 4458508	8 mm	85
FOR 4458509	9 mm	85
FOR 4458510	10 mm	85
FOR 4458511	11 mm	85
FOR 4458512	12 mm	85
FOR 4458513	13 mm	85
FOR 4458514	14 mm	85
FOR 4458515	15 mm	85
FOR 4458516	16 mm	85
FOR 4458517	17 mm	85
FOR 4458518	18 mm	85
FOR 4458519	19 mm	85
FOR 4458520	20 mm	85
FOR 4458521	21 mm	85
FOR 4458522	22 mm	85
FOR 4458523	23 mm	85
FOR 4458524	24 mm	85
FOR 4458525	25 mm	85
FOR 4458527	27 mm	85
FOR 4458528	28 mm	85
FOR 4458529	29 mm	85
FOR 4458530	30 mm	85
FOR 4458531	31 mm	85
FOR 4458532	32 mm	85
FOR 4458533	33 mm	85
FOR 4458534	34 mm	85
FOR 4458535	35 mm	85
FOR 4458536	36 mm	85
FOR 4458541	41 mm	85



Lange slagdoppen 12 kant 1/2"
Douilles à choc longues 12 pans 1/2"

Art.nr	mm	L mm
FOR 4488517	17 mm	85
FOR 4488519	19 mm	85
FOR 4488522	22 mm	85
FOR 4488524	24 mm	85
FOR 4488527	27 mm	85
FOR 4488530	30 mm	85
FOR 4488532	32 mm	85
FOR 4488533	33 mm	85
FOR 4488534	34 mm	85
FOR 4488536	36 mm	85
FOR 4488541	41 mm	85



Verlengstukken
Rallonges

Art.nr	mm	L mm
FOR 8043075MPP	3/8"	75
FOR 8043150MPP	3/8"	150
FOR 8044125MPP	1/2"	125
FOR 8044125MPB	1/2"	125
FOR 8044250MPP	1/2"	250
FOR 8044250MPB	1/2"	250



MPP = pin type
MPB = ball type

Slagdoppensets - Jeu de douilles à choc 1/2"

FOR 41012

1/2" Inbus slagdoppenset 10 delig
Douilles à choc hexagonales 10 pcs 1/2"

244060 04...19	4-5-6-7-8-10-12-14-17-19 mm (60 mm L)
----------------	---------------------------------------



FOR 4077

1/2" Inbus slagdoppenset 7 delig
Douilles à choc hexagonales 7 pcs 1/2"

244060 04...14	4-5-6-7-8-10-12-14mm (60 mm L)
----------------	--------------------------------



FOR 41013

1/2" Torx slagdoppenset 10 delig
Douilles à choc torx 10 pcs 1/2"

2460 60 20...70	T20-T25-T27-T30-T40-T45-T50-T55-T60-T70 (60mmL)
-----------------	---



FOR 4078

1/2" Torx slagdoppenset 7 delig
Douilles à choc torx 7 pcs 1/2"

2460 60 30..70	T30-T40-T45-T50-T55-T60-T70 (60mmL)
----------------	-------------------------------------



FOR 40713

1/2" XZN slagdoppenset 7 delig
Douilles à choc XZN 7 pcs 1/2"

2480 60 08...12	M8-M10-M12 (60mmL)
248060 12...18	M12-M14-M16-M18 (78mmL)



FOR T4205

TC module 1/2" Torx- inbus slagdoppenset 20 delig
TC module 20 douilles à choc Torx- hex 1/2"

2460 60 20...70	T20-T25-T27-T30-T40-T45-T50-T55-T60-T70
2440 60 04....19	4-5-6-7-8-10-12-14-17-19 mm



FOR 4256

1/2" Torx- XZN slagdoppenset 25 delig
25 douilles à choc Torx- XZN 1/2"

2460 60 30...70	T30-T40-T45-T50-T55-T60-T70 (60mmL)
2480 60 08...12	M8-M10-M12 XZN (60mmL)
2480 78 14...18	M14-M16-M18 XZN (78mmL)
446 06...24	E6-E7-E8-E10-E11-E12-E14-E16-E18-E20-E22-E24



FOR 4267

1/2" Inbus - torx- XZN slagdoppenset 26 delig
26 Douilles à choc torx- hex - XZN 1/2"

2460 60 30...70	T20-T25-T27-T30-T40-T45-T50-T55-T60-T70 (60mmL)
2480 60 08...12	M8-M10-M12 XZN (60mmL)
2480 78 14...18	M14-M16-M18 XZN (78mmL)
2440 60 04...19	4-5-6-7-8-10-12-14-17-19mm



FOR 4117

1/2" Inwendige torx slagdoppenset 11 delig
Douilles à choc torx 11 pcs 1/2"

446 06...24	E6-E7-E8-E10-E12-E14-E16-E18-E20-E22-E24
--------------------	--



FOR 4073

1/2" Slagdoppenset inwendig torx 7 delig
Jeu de 7 douilles à choc E torx

446 06...18	E6-E8-E10-E12-E14-E16-E18
--------------------	---------------------------



Slagdoppen inbus 1/2"
Douilles à choc hexagonales 1/2"

Art.nr	mm	L mm
FOR 24406004	4	60
FOR 24406005	5	60
FOR 24406006	6	60
FOR 24406007	7	60
FOR 24406008	8	60
FOR 24406010	10	60
FOR 24406012	12	60
FOR 24406014	14	60
FOR 24406017	17	60
FOR 24406019	19	60



Slagdoppen torx 1/2"
Douilles à choc torx 1/2"

Art.nr	mm	L mm
FOR 24606020	T20	60
FOR 24606025	T25	60
FOR 24606027	T27	60
FOR 24606030	T30	60
FOR 24606040	T40	60
FOR 24606045	T45	60
FOR 24606050	T50	60
FOR 24606055	T55	60
FOR 24606060	T60	60
FOR 24606070	T70	60



Slagdoppen XZN spline 1/2"
Douilles à choc XZN spline 1/2"

Art.nr	mm	L mm
FOR 24806008	M8	60
FOR 24806010	M10	60
FOR 24806012	M12	60
FOR 24807812	M12	78
FOR 24807814	M14	78
FOR 24807816	M16	78
FOR 24807818	M18	78



Slagdoppen - Douilles à choc 1/2"

FOR 4032

1/2" Slagdoppenset 3 delig voor alu velgen 6k
Douilles à choc pour jantes en alu 3 pcs 1/2"

4458517C	17 mm (85 mm L)
4458519C	19 mm (85 mm L)
4458521C	21 mm (85 mm L)



FOR 4033

1/2" Lange slagdoppenset 3 delig voor alu velgen 6k
Douilles à choc longues pour jantes en alu 3 pcs 1/2"

44515017C	17 mm (150 mm L)
44515019C	19 mm (150 mm L)
44515021C	21 mm (150 mm L)



FOR 4032TH

1/2" Slagdoppenset 3 delig dunwandig 6k
Douilles à choc convexe à paroi fine 3 pcs 6p 1/2"

4458517TH	17 mm (85 mm L)
4458519TH	19 mm (85 mm L)
4458521TH	21 mm (85 mm L)



FOR 4035

1/2" Lange torsie slagdoppenset 3 delig voor alu velgen 6k
Douilles à choc torsion pour jantes en alu 3 pcs 1/2"

	17 mm
	19 mm
	21 mm



Art.nr	mm	L mm
FOR 4458517C	17 mm	85
FOR 4458519C	19 mm	85
FOR 4458521C	21 mm	85
FOR 44515017C	17 mm	105
FOR 44515019C	19 mm	105
FOR 44515021C	21 mm	105

Lange slagdoppen 6k alu velg 1/2"
Douilles à choc 6p gantes alu 1/2"



Adapters - Adaptateurs

FOR K4079

Slagmoer adapter set 7 delig (ball type)
Adaptateur à choc 7 pcs (avec bille)

80932MPB	3/8" x 1/4"
80934MPB	3/8" x 1/2"
80943MPB	1/2" x 3/8"
80946MPB	1/2" x 3/4"
80964MPB	3/4" x 1/2"
80968MPB	3/4" x 1"
80986MPB	1" x 3/4"



FOR T8151

Slagmoer adapter set 15 delig (ball type)
Adaptateur à choc 15 pcs (avec bille)

80923MPB 86MPB	1/4"x3/8" - 3/8"x1.4" - 3/8"x1/2" - 1/2"x3/8" - 1/2"x3/4" - 3/4"x1/2" - 3/4"x1" - 1"x3/4"
80531 MPB 61MPB	kniegewricht 3/8",1/2",3/4"
81032MPB 45MPB	impact bit holder 3/8"x1/4" - 3/8"x5/16" - 1/2"x1/4" - 1/2"x5/16"



Art.nr	mm	
FOR 80932MPB	3/8" x 1/4"	ball type
FOR 80934MPB	3/8" x 1/2"	ball type
FOR 80943MPB	1/2" x 3/8"	ball type
FOR 80946MPP	1/2" x 3/4"	pin type
FOR 80946MPB	1/2" 3/4"	ball type
FOR 80964MPB	3/4" x 1/2"	ball type
FOR 80968MPB	3/4" x 1"	ball type
FOR 80986MPP	1" x 3/4"	pin type
FOR 80986MPB	1" x 3/4"	ball type
FOR 809128MPP	1-1/2" x 1"	pin type
FOR 809812MPP	1" x 1-1/2"	pin type

Verloopstukken
Adaptateurs



Art.nr	mm	type
FOR 80541MPP	1/2"	pin type
FOR 80541MPB	1/2"	ball type
FOR 80561MPB	3/4"	ball type

Kniegewricht
Cardan universel



Slagdoppensets - Jeu de douilles à choc 3/4"

FOR 6081

3/4" Slagdoppenset 8 delig in metalen koffer
Jeu de douilles à choc 8 pcs 3/4" 6 pans

46526	26 mm
46527	27 mm
46529	29 mm
46530	30 mm
46532	32 mm
46535	35 mm
46536	36 mm
46538	38 mm



FOR 6083

3/4" Slagdoppenset 8 delig in metalen koffer 6k
Jeu de douilles à choc 8 pcs 3/4" 6 pans

46519	19 mm
46522	22 mm
46524	24 mm
46527	27 mm
46530	30 mm
46532	32 mm
46536	36 mm
46541	41 mm



FOR 6163

3/4" Slagdoppenset 16 delig in metalen koffer 6kant
Coffret de douilles à choc 16 pcs 3/4" 6 pans

465 19...46	19-21-22-24-26-27-28-29-30-32-33-34-36-38-41-46 mm
-------------	--



FOR T6121

TC module 12 slagdoppen 6kant 3/4"
Module 12 douilles à choc 3/4" 6 pans

465 17... 41	17-19-21-22-24-27-30-32-34-36-38-41 mm
--------------	--



FOR 6091

3/4" Slagdoppenset inbus 6kant 9 dlg
Coffret 3/4" douilles à chocs hex 9 pcs

26490 14.....32	14-16-17-19-22-24-27-30-32 mm
-----------------	-------------------------------



Slagdoppen - Douilles à choc 3/4"

Art.nr	mm	L mm
FOR 46517	17	50
FOR 46519	19	50
FOR 46521	21	50
FOR 46522	22	50
FOR 46523	23	50
FOR 46524	24	50
FOR 46526	26	50
FOR 46527	27	54
FOR 46528	28	54
FOR 46529	29	54
FOR 46530	30	54
FOR 46532	32	57
FOR 46533	33	57
FOR 46534	34	57
FOR 46535	35	57
FOR 46536	36	57
FOR 46538	38	57
FOR 46541	41	57
FOR 46542	42	57
FOR 46546	46	63
FOR 46550	50	68
FOR 46552	52	70
FOR 46555	55	72
FOR 46557	57	70
FOR 46560	60	75
FOR 46570	70	85

Slagdoppen 6 kant 3/4"
Douilles à choc 6 pans 3/4"



Art.nr	mm	L mm
FOR 46817	17	50
FOR 46819	19	50
FOR 46820	20	50
FOR 46824	24	50
FOR 46827	27	50
FOR 46846	46	50

Slagdoppen 12 kant 3/4"
Douilles à choc 12 pans 3/4"



Art.nr	mm	L mm
FOR 2649014	14	90
FOR 2649016	16	90
FOR 2649017	17	90
FOR 2649019	19	90
FOR 2649022	22	90
FOR 2649024	24	90
FOR 2649027	27	90
FOR 2649030	30	90
FOR 2649032	32	90

Slagdoppen inbus 6 kant 3/4"
Douilles à choc hex 6 pans 3/4"



Slagdoppensets - Jeu de douilles à choc 3/4"

FOR 6081D

3/4" Lange slagdoppenset 6k 8 delig in metalen koffer
Jeu de douilles à choc longues 6p 8 pcs 3/4"

46510026	26 mm
46510027	27 mm
46510029	29 mm
46510030	30 mm
46510032	32 mm
46510035	35 mm
46510036	36 mm
46510038	38 mm



FOR 6083D

3/4" Lange slagdoppenset 6k 8 delig in metalen koffer
Jeu de douilles à choc longues 6p 8 pcs 3/4"

46510019	19 mm
46510022	22 mm
46510024	24 mm
46510027	27 mm
46510030	30 mm
46510032	32 mm
46510036	36 mm
46510041	41 mm



FOR T6085

TC module 8 lange slagdoppen 6k 3/4"
Module 8 douilles longues à choc 6p 3/4"

465100 19 41	19-22-24-27-30-32-36-41 mm
--------------	----------------------------



FOR 6115D

3/4" Lange slagdoppenset 6k 11 delig
Coffret de 11 douilles à choc longues 6pans 3/4"

465100 17...48	17-19-21-22-24-27-30-32-33-36-48 mm
----------------	-------------------------------------



Slagdoppen - Douilles à choc 3/4"

Art.nr	mm	L mm
FOR 46510017	17	100
FOR 46510019	19	100
FOR 46510020	20	100
FOR 46510021	21	100
FOR 46510022	22	100
FOR 46510023	23	100
FOR 46510024	24	100
FOR 46510026	26	100
FOR 46510027	27	100
FOR 46510028	28	100
FOR 46510029	29	100
FOR 46510030	30	100
FOR 46510031	31	100
FOR 46510032	32	100
FOR 46510033	33	100
FOR 46510034	34	100
FOR 46510035	35	100
FOR 46510036	36	100
FOR 46510038	38	100
FOR 46510040	40	100
FOR 46510041	41	100
FOR 46510042	42	100
FOR 46510046	46	100
FOR 46510048	48	100
FOR 46510050	50	100

3/4" Lange slagdop 24mm voor naafbouten VAG
Douille à choc longue 24mm pour VAG

46810024	24 mm
----------	-------

Lange slagdoppen 6 kant 3/4"
 Douilles à choc longues 6 pans 3/4"



Lange slagdop 24mm 12 kant 3/4"
 Douille à choc longue 12 pans 3/4"



Slagdoppen - Douilles à choc 1"

FOR 8081

1" Slagdoppenset 8 delig metalen koffer
Jeu de douilles à choc 8 pcs 1" 6 pans

48524	24 mm
48527	27 mm
48530	30 mm
48532	32 mm
48533	33 mm
48536	36 mm
48538	38 mm
48541	41 mm



FOR 8071

1" Slagdoppenset 7 delig pvc koffer met foam
Jeu de douilles à choc 7 pcs 1" en coffre PVC avec foam 6 pans

48546	46 mm
48550	50 mm
48555	55 mm
48560	60 mm
48565	65 mm
48570	70 mm
48575	75 mm



Art.nr	mm	L mm
FOR 48517	17	58
FOR 48519	19	58
FOR 48524	24	58
FOR 48526	26	58
FOR 48527	27	58
FOR 48530	30	60
FOR 48532	32	60
FOR 48533	33	60
FOR 48535	35	62
FOR 48536	36	65
FOR 48538	38	65
FOR 48541	41	67
FOR 48542	42	70
FOR 48544	44	70
FOR 48546	46	75
FOR 48548	48	75
FOR 48550	50	75
FOR 48552	52	75
FOR 48554	54	80
FOR 48555	55	80
FOR 48558	58	85
FOR 48560	60	85
FOR 48565	65	90
FOR 48567	67	90
FOR 48570	70	90
FOR 48572	72	95
FOR 48575	75	95
FOR 48580	80	100
FOR 48585	85	110
FOR 48590	90	110
FOR 48595	95	110

Slagdoppen 6 kant 1"
Douilles à choc 6 pans 1"



FOR 8081D

1" Lange slagdoppenset 8 delig metalen koffer
Jeu de douilles à choc longues 8 pcs 1" 6p

FOR 48510024	24 mm
FOR 48510027	27 mm
FOR 48510030	30 mm
FOR 48510032	32 mm
FOR 48510033	33 mm
FOR 48510036	36 mm
FOR 48510038	38 mm
FOR 48510041	41 mm



Art.nr	mm	L mm
FOR 48510024	24	100
FOR 48510026	26	100
FOR 48510027	27	100
FOR 48510028	28	100
FOR 48510029	29	100
FOR 48510030	30	100
FOR 48510032	32	100
FOR 48510033	33	100
FOR 48510034	34	100
FOR 48510035	35	100
FOR 48510036	36	100
FOR 48510038	38	100
FOR 48510041	41	100
FOR 48510046	46	100
FOR 48510050	50	100
FOR 48510055	55	100

Lange slagdoppen 6 kant 1"
Douilles à choc longues 6 pans 1"



Art.nr	mm	L mm	kg
FOR 4125105	105	120	11kg

Slagdop 6 kant 1-1/2"
Douille à choc 6 pans 1-1/2"



Slaggereedschap - Accessoires à choc

Art.nr	mm	L mm
FOR 8043075MPP	3/8"	75
FOR 8043150MPP	3/8"	150
FOR 8044075MPB	1/2"	75
FOR 8044125MPB	1/2"	125
FOR 8044125MPP	1/2"	125
FOR 8044250MPP	1/2"	250
FOR 8044250MPB	1/2"	250
FOR 8046100MPP	3/4"	100
FOR 8046100MPB	3/4"	100
FOR 8046175MPP	3/4"	175
FOR 8046175MPB	3/4"	175
FOR 8046250MPP	3/4"	250
FOR 8046330MPP	3/4"	330
FOR 8048250MPP	1"	250
FOR 8048330MPP	1"	330

Verlengstukken
Rallonges

MPP = pin type
MPB = ball type

Art.nr	mm	type
FOR R1935	1/2"	O ring 19-3.5
FOR P2030	1/2"	pin 20L dia 3.0
FOR R2435	1/2"	O ring 24-3.5
FOR P2530	1/2"	pin 25L dia 3.0

O ring & pin
Bague en caoutchouc + goupille de sécurité

FOR R3355	3/4"	O ring 33-5.5
FOR P3040	3/4"	pin 35L dia 4.0
FOR R3755	3/4"	O ring 37-5.5
FOR P3540	3/4"	pin35L dia 4.0
FOR R4455	3/4"-1"	O ring 44-5.5
FOR P4540	3/4"-1"	pin 45L dia 4.0

FOR R7555	1"	O ring 75-5.5
FOR P7550	1"	pin 75L dia 5.0



Minimale afname 5 st
Commande min. 5 pcs

Gereedschapskoffer - Coffre d'outils

ZA 104855

Gevulde gereedschapskoffer 85 delig

- L468 mm x B218 mm x H203 mm
- 12.50kg

Coffre d'outils 85 pcs

- L468 mm x B218 mm x H203 mm
- 12.50kg

1/2" doppen, douilles	10-11-12-13-14-15-16-17-18-19-20-21-22-23-24-27-30-32 mm
1/2" ratel, cliquet	
1/2" verlengstuk	rallonge 125 mm
1/2" wringstaaf	manche en T
1/2" kniegewricht	cardan universel
1/4" doppen, douilles	4-4.5-5-5.5-6-7-8-9-10-11-12-13 mm
1/4" ratel	cliquet
1/4" verlengstuk	ralonge 75 mm
1/4" bits - 6	embouts
	schroevendraaier handvat, manche tournevis
1- meter 3m	mètre à ruban
12 steekringsleutels	6-8-9-10-11-12-13-14-15-16-17-19 mm
9-inbussleutel	1.5-2-2.5-3-4-5-6-8-10 mm
waterpomptang	pince multiprise
1-lange bektang	pince à becs long
4-schroevendraaiers	plat: 5×75 mm L, plat:6×100 mm L, 6.5×150 mm L PH#2×100 mm L, PH#1×75 mm L
1-mes	10 reservemesjes
1 vise grip tang	pince grip





















SLEUTELS

CLÉS



	Steekringsleutels mm - clés mixtes	172
	Steekringsleutelsets - Jeu de clés mixtes	173
	Steekringsleutels inch - clés mixtes en pouces	175
	Steekringsleutels met ratel- Clés mixtes à cliquet	176
	Steeksleutels - clés à fourches	178
	Gebogen ringsleutels - clés polygonales	179
	ringsleutels - clés polygonales	180
	Pijpsleutels - clés à pipe	183
	Open ringsleutels - clés à tuyauter	184
	Kniesleutels - clés à douille articulée	185
	Dopsleutels - clés à douilles	186
	Verstelbare moersleutels - clés à molettes	188
	Momentsleutels - clés dynamométrique	188
	Haakse sleutels - Clés mâles	191
	Inbussleutels - Jeu de clés mâles	193
	Haakse torx sleutels - Clés mâles torx	195
	Inbussleutels op handvat - Clés mâles	197
	Torx - resistorx	199

Steekringsleutels - Clés mixtes mm

Steekring metrisch

Art.nr	mm	L mm	gewicht/poids gr
FOR 75504	4	96	13
FOR 75505	5	96	13
FOR 75506	6	100	16
FOR 75507	7	110	21
FOR 75508	8	120	26
FOR 75509	9	130	33
FOR 75510	10	140	38
FOR 75511	11	150	48
FOR 75512	12	160	56
FOR 75513	13	170	73
FOR 75514	14	180	85
FOR 75515	15	190	99
FOR 75516	16	200	117
FOR 75517	17	210	136
FOR 75518	18	220	158
FOR 75519	19	230	175
FOR 75520	20	240	216
FOR 75521	21	250	227
FOR 75522	22	260	258
FOR 75523	23	270	285
FOR 75524	24	280	309
FOR 75525	25	290	330
FOR 75526	26	300	377
FOR 75527	27	310	403
FOR 75528	28	320	448
FOR 75529	29	330	499
FOR 75530	30	340	536
FOR 75532	32	360	637
FOR 75533	33	385	616
FOR 75534	34	385	603
FOR 75535	35	410	850
FOR 75536	36	410	840
FOR 75538	38	435	998
FOR 75541	41	460	1281
FOR 75542	42	460	1258
FOR 75546	46	500	1679
FOR 75548	48	540	2170
FOR 75550	50	540	2130
FOR 75555	55	560	3054
FOR 75560	60	600	3850
FOR 75565	65	680	5826
FOR 75570	70	680	5625



FOR 51313

Steekringsleutelset extra lang 13 delig
Jeu de 13 clés mixtes longues

Art.nr	mm	L mm
FOR 75508L	8	148
FOR 75510L	10	167
FOR 75511L	11	186
FOR 75512L	12	196
FOR 75513L	13	205
FOR 75514L	14	223
FOR 75515L	15	233
FOR 75516L	16	243
FOR 75517L	17	262
FOR 75518L	18	272
FOR 75519L	19	281
FOR 75522L	22	319
FOR 75524L	24	339



Steekringsleutelsets - Jeu de clés mixtes

FOR 5121

Steekringsleutelset 12 delig in hoes
Jeu de clés mixtes 12 pcs en trousse

755 08....23	8-10-11-12-13-14-15-16-17-19-22-23 mm
--------------	---------------------------------------

FOR 5141C

Steekringsleutelset 14 delig in hoes
Jeu de clés mixtes 14 pcs en trousse

755 10....32	10-11-12-13-14-17-19-21-22-23-24-27-30-32 mm
--------------	--



FOR 5261C

Steekringsleutelset 26 delig in hoes
Jeu de clés mixtes 26 pcs en trousse

755 06....32	6-7-8-9-10-11-12-13-14-15-16-17-18-19-20- 22 23-24-25-26-27-28-29-30-32 mm
--------------	--

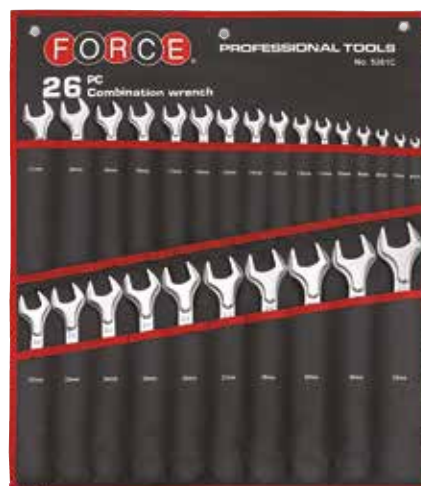

FOR 5115

Steekringsleutelset op houder 11 delig
Jeu de 11 clés mixtes

755 08....22	8-10-11-12-13-14-15-17-18-19-21-22 mm
--------------	---------------------------------------



FOR 50651

Steekringsleutelset 6 delig in hoes
Jeu de clés mixtes 6 pcs en trousse

755 32... 46	32-34-36-38-41-46 mm
--------------	----------------------



FOR 5213C

Steekringsleutelset 21 delig in hoes
Jeu de clés mixtes 21 pcs en trousse

755 06....36	6-7-8-9-10-11-12-13-14-15-16-17-18-19-21- 22-24-27-30-32 -36 mm
--------------	---



FOR T5161

TC module 16 steekringsleutels
TC module 16 clés mixtes

755 06...24 6-7-8-9-10-11-12-13-14-15-16-17-18-19-22-24 mm



FOR T5181

TC module 18 steekringsleutels
TC module 18 clés mixtes

755 06...23 6-7-8-9-10-11-12-13-14-15-16-17-18-19-20-21-22-23 mm



FOR T5052

TC module 5 steekringsleutels
TC module 5 clés mixtes

755 26...32 26-27-28-30-32 mm



FOR T5089

TC module 8 steekringsleutels
TC module 8 clés mixtes

755 24...32 24-25-26-27-28-29-30-32 mm



FOR 5086

Set 8 steekringsleutels op houder
Jeu de 8 clés mixte

755 10...22 10-11-12-13-14-17-19-22 mm



FOR T51214

TC module mini steekringsleutelset 12 delig
TC module 12 clés mixtes mini

755S 08...19 8-9-10-11-12-13-14-15-16-17-18-19 mm



Art.nr	mm	L mm
FOR 755S08	8	91
FOR 755S09	9	97
FOR 755S10	10	97
FOR 755S11	11	100
FOR 755S12	12	105
FOR 755S13	13	108
FOR 755S14	14	115
FOR 755S15	15	118
FOR 755S16	16	122
FOR 755S17	17	130
FOR 755S18	18	133
FOR 755S19	19	138

Steekringsleutel kort
Clés mixte mini



Steekringsleutels inch - clés mixtes en pouces



Art.nr	inch	L mm
FOR 7551.4	1/4"	100
FOR 7555.16	5/16"	120
FOR 7553.8	3/8"	140
FOR 7557.16	7/16"	150
FOR 7551.2	1/2"	170
FOR 7559.16	9/16"	180
FOR 755.8	5/8"	200
FOR 75511.16	11/16"	210
FOR 7553.4	3/4"	230
FOR 75513.16	13/16"	250
FOR 7557.8	7/8"	260
FOR 75515.16	15/16"	280
FOR 7551.0	1"	300
FOR 7551.1.16	1 1/16"	310
FOR 7551.1.8	1 1/8"	340
FOR 7551.1.4	1 1/4"	360
FOR 7551.5.16	1 5/16"	385
FOR 7551.3.8	1 3/8"	410
FOR 7551.7.16	1 7/16"	435
FOR 7551.1.2	1 1/2"	435
FOR 7551.5.8	1 5/8"	460
FOR 7551.11.16	1 11/16"	460
FOR 7551.3.4	1 3/4"	500

FOR T5134

TC module 13 steekringsleutels inch maten
TC module 13 clés mixtes en pouce

755	1/4"-5/16"-3/8"-7/16"-1/2"-9/16"-5/8"-11/16"-3/4"-13/16"-7/8"-15/16"-1"
-----	---



FOR 5115S

Steekringsleutelset inch op houder 11 delig
Jeu de 11 clés mixtes en pouce

755	1/4"-5/16"-3/8"-7/16"-1/2"-9/16"-5/8"-11/16"-3/4"-13/16"-7/8"
-----	---



FOR 5121S

Steekringsleutelset 12 delig in hoes
Jeu de 12 clés mixtes en trousse



755 1/4".... 75515.16"	1/4"-5/16"-3/8"-7/16"-1/2"-9/16"-5/8"-11/16"-3/4"-13/16"-7/8"-15/16"
---------------------------	--

FOR 5141S

Steekringsleutelset 14 delig in hoes
Jeu de 14 clés mixtes en trousse



755 5/161.1/4	5/16"-3/8"-7/16"-1/2"-9/16"-5/8"-11/16"-3/4"-13/16" 7/8"-15/16"-1"-1-1/8"-1-1/4"
-----------------------	--



FOR K51225

Flexibel ratelsleutelset 12 delig (foam met deksel)
Clés mixtes à cliquet flexible 12 pcs (foam)



757 5.16F....1.0F	5/16"-3/8"-7/16"-1/2"-9/16"-5/8"-11/16"-3/4"-13/16"-7/8"-15/16"-1"
-------------------	--



FOR 50651S

Steekringsleutelset Jumbo 6delig in hoes
Jeu de 6 clés mixtes en trousse

755	1 1/4"-1 5/16"-1 3/8"-1 7/16"-1 1/2"-1 5/8"
-----	---



Steekringsleutels met ratel- Clés mixtes à cliquet

Art.nr	mm	L mm
FOR 75708	8	140
FOR 75709	9	150
FOR 75710	10	160
FOR 75711	11	165
FOR 75712	12	170
FOR 75713	13	180
FOR 75714	14	190
FOR 75715	15	200
FOR 75716	16	210
FOR 75717	17	223
FOR 75718	18	233
FOR 75719	19	244
FOR 75720	20	275
FOR 75721	21	275
FOR 75722	22	290
FOR 75724	24	290

Steekringsleutel met ratel
Clés mixte à cliquet



Art.nr	mm	L mm
FOR 75708R	8	140
FOR 75709R	9	150
FOR 75710R	10	160
FOR 75711R	11	165
FOR 75712R	12	170
FOR 75713R	13	180
FOR 75714R	14	190
FOR 75715R	15	200
FOR 75716R	16	210
FOR 75717R	17	223
FOR 75718R	18	233
FOR 75719R	19	244
FOR 75724R	24	290

Steekringsleutel met omkeerbare ratelsleutel
Clés mixtes à cliquet reversible



Art.nr	mm	L mm
FOR 75708F	8	130
FOR 75709F	9	155
FOR 75710F	10	155
FOR 75711F	11	173
FOR 75712F	12	173
FOR 75713F	13	185
FOR 75714F	14	191
FOR 75715F	15	215
FOR 75716F	16	215
FOR 75717F	17	230
FOR 75718F	18	248
FOR 75719F	19	248

Steekringsleutel met flexibele ratel
Clés mixtes à cliquet flexible



FOR K51210F

Flexibel ratelsleutelset 12 delig (foam met deksel)
Module mousse 12 clés mixtes à cliquet flexible

757 08F...19F	8-9-10-11-12-13-14-15-16-17-18-19 mm
---------------	--------------------------------------



FOR K50726F

Flexibel ratelsleutelset 7 delig
7 clés mixtes à cliquet flexible

757 08F...19F	8-10-12-13-14-16-17-19 mm
---------------	---------------------------



FOR T51211

TC module omkeerbare steekratel sleutelset 12 delig
TC module 12 clés mixtes à cliquet réversible

757 08R...19R	8-9-10-11-12-13-14-15-16-17-18-19 mm
---------------	--------------------------------------



FOR T51210

TC module platte ratelsleutelset 12 delig
TC module 12 clés mixtes à cliquet

757 08...19	8-9-10-11-12-13-14-15-16-17-18-19 mm
-------------	--------------------------------------



FOR T5164R

TC module omkeerbare ratelsleutelset 16 delig
TC module 16 clés mixtes à cliquet réversible

757 08R....19R	8-9-10-11-12-13-14-15-16-17-18-19 mm
831 210....419	1/4" (10 mm) 3/8" (13 mm-) 1/2" (19 mm)
831H210	1/4" inbus 10 mm bithouder



FOR T51115

TC module platte ratelsleutelset 11 delig
TC module 11 clés mixtes à cliquet

757 08...19	8-10-12-13-14-17-19 mm
828 0608 2024	Torx E6xE8-E10xE12-E14xE18-E20xE24



Steeksleutels - clés à fourches



Art.nr	mm	L mm
FOR 7540607	6x7	123
FOR 7540809	8x9	141
FOR 7541011	10x11	157
FOR 7541213	12x13	172
FOR 7541415	14x15	190
FOR 7541617	16x17	205
FOR 7541819	18x19	220
FOR 7542022	20x22	236
FOR 7542123	21x23	246
FOR 7542224	22x24	246
FOR 7542427	24x27	259
FOR 7542528	25x28	279
FOR 7543032	30x32	297
FOR 7543236	32x36	350
FOR 7543436	34x36	350
FOR 7543641	36x41	380
FOR 7544146	41x46	415
FOR 7544650	46x50	465

Art.nr	mm	L mm
FOR 7540608S	1/4"x5/16"	123
FOR 7540810S	5/16"x3/8"	141
FOR 7541011S	3/8"x7/16"	157
FOR 7541314S	1/2"x9/16"	180
FOR 7541416S	9/16"x5/8"	190
FOR 7541617S	5/8"x11/16"	195
FOR 7541719S	11/16"x3/4"	220
FOR 7542122S	13/16"x7/8"	236
FOR 7542425S	15/16"x1"	255
FOR 7542427S	15/16"x1 1/16"	259
FOR 7542932S	1 1/8"x1 1/4"	297



FOR T5111

TC module 11 steeksleutels
TC module 11 clés à fourches

6x7-8x9-10x11-12x13-14x15-16x17-18x19- 20x22-21x23-
24x27-30x32



FOR T5111S

TC module 11 steeksleutels SAE
TC module 11 clés à fourches SAE

1/4"x5/16" - 5/16"x3/8" - 3/8"x7/16" - 1/2"x9/16"-9/16"x 5/8" -
5/8"x11/16" - 11/16"x3/4" - 13/16"x7/8" - 15/16"x1" - 15/16"x1 1/16"
1 1/8"x1 1/4"



FOR 5128C

Steeksleutelset 12 delig in hoës
Jeu de 12 clés à fourche en trousse

6x7-8x9-10x11-12x13-14x15-16x17-18x19 - 20x22-21x23-24x27-
25x28-30x32



Gebogen ringsleutels - clés polygonales

Art.nr	mm	L mm
FOR 7590607	6x7	175
FOR 7590809	8x9	190
FOR 7591011	10x11	205
FOR 7591213	12x13	220
FOR 7591415	14x15	245
FOR 7591617	16x17	270
FOR 7591819	18x19	300
FOR 7592022	20x22	325
FOR 7592122	21x22	325
FOR 7592123	21x23	335
FOR 7592224	22x24	335
FOR 7592326	23x26	345
FOR 7592427	24x27	345
FOR 7592528	25x28	355
FOR 7592628	26x28	355
FOR 7593032	30x32	370



Art.nr	mm	L mm
FOR 7590608S	1.4"x5/16"	175
FOR 7591011S	3/8"x7/16"	205
FOR 7591314S	1/2"x9/16"	220
FOR 7591617S	5/8"x11/16"	270
FOR 7591719S	11/16"x3/4"	300
FOR 7591922S	3/4"x7/8"	325
FOR 7592122S	13/16"x7/8"	325
FOR 7592425S	15/16"x1"	345



FOR T5081

TC module 8 gebogen ringsleutels 75°
Tc module 8 clés polygonales coudées 75°

6x7-8x9-10x11-12x13-14x15-16x17-18x19-21x23 mm



FOR T5044

TC module 4 gebogen ringsleutels 75°
TC module 4 clés polygonales 75°

23x26-24x27-25x28-30x32 mm



FOR T5085

TC module 8 gebogen ringsleutels 45°
Tc module 8 clés polygonales coudées 45°

8x9-10x11-12x13-14x15-16x17-18x19-21x23 -22x24 mm



FOR T50634

TC module 6 S vormige ringsleutels
Tc module 6 clés coudées en forme "S"

10x12-11x13-14x15-16x18-17x19-22x24 mm



Ringsleutels - clés polygonales

FOR 51213C

Gebogen ringsleutelset 75° 12 delig in hoës
12 Clés polygonales 75° en trousse

759 0607....3032 6x7-8x9-10x11-12x13-14x15-16x17-18x19 - 20x22-21x23-24x27-25x28-30x32 mm



FOR T5085S

TC module 8 gebogen ringsleutels 45° inch maten
TC module 8 clés polygonales 45° en pouces



758 0608S....2425S 1/4" x 5/16" - 3/8" x 7/16" - 7/16" x 1/2"
 1/2" x 9/16" - 5/8" x 11/16" - 11/16" x 3/4" -
 13/16" x 7/8" - 7/8" x 15/16"



FOR T5079S

TC module 7 gebogen ringsleutels 75° inch maten
TC module 7 clés polygonales en pouces



759 0608S....2425S 1/4" x 5/16" - 3/8" x 7/16"
 1/2" x 9/16" - 5/8" x 11/16" - 3/4" x 7/8" -
 13/16" x 7/8" - 15/16" x 1"



FOR T51226

TC module 12 platte ringsleutels
TC module 12 clés polygonales à fourches

760M 0607....3032 6x7-8x9-10x11-12x13-14x15-16x17-18x19
 20x22-21x23-22x24-26x28-30x32 mm



FOR T51226A

TC module 12 platte ringsleutels 15°
TC module 12 clés polygonales a fourches 15°

760 0607A....3032A 6x7-8x9-10x11-12x13-14x15-16x17-18x19
 20x22-21x23-22x24-26x28-30x32 mm



FOR 5041

Torx ringsleutelset 4 delig
Clés torx 4 pcs



756 0608....2024

E6xE8 - E10xE12 - E14xE18
- E20xE24

Art.nr	mm	L mm
FOR 7560608	6X8	112
FOR 7560711	7X11	125
FOR 7561012	10X12	140
FOR 7561418	14X18	180
FOR 7561622	16x22	200
FOR 7562024	20X24	224

FOR 50911

Halvemaan sleutelset 9 delig
Clés demi-lune 9 pcs



761 0810....1922

8x10 - 10x11 - 10x12 - 11x13
- 12x14 - 13x15 - 14x17 -
16x18 - 17x19 - 19x22 mm

Art.nr	mm	L mm
FOR 7610810	8x10	138
FOR 7611012	10x12	141
FOR 7611113	11x13	165
FOR 7611214	12x14	165
FOR 7611315	13x15	190
FOR 7611417	14x17	190
FOR 7611618	16x18	220
FOR 7611719	17x19	220
FOR 7611922	19x22	255
FOR 7612224	22x24	285

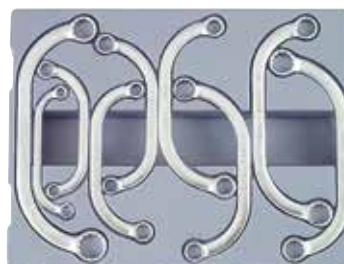

FOR 50622

Rechte ringsleutels extra lang 6 delig
6 Clés polygones droite extra longues

Art.nr	mm	L mm
FOR 7601012	10x12	290
FOR 7601214	12x14	330
FOR 7601315	13x15	360
FOR 7601417	14x17	370
FOR 7601618	16x18	405
FOR 7601719	17x19	405



FOR T50810

TC module ratel-ringsleutelset plat 8 delig
TC module 8 clés plates à cliquet

824 0607....2122	6x7-8x9-10x11-12x13-14x15-16x18-17x19-21x22 mm
-------------------------	--



FOR T50811

TC module rechte ratel-ringsleutelset gebogen 8 delig
Tc module 8 clés polygones à cliquet

825 0607....2122	6x7-8x9-10x11-12x13-14x15-16x18-17x19-21x22 mm
-------------------------	--



FOR T50617

TC module ratel-ringsleutelset torx 6 delig
Tc module 6 clés polygones à cliquet torx

826 0607....2224	E6xE7 - E8xE10 - E11xE12 - E14xE16 - E18xE20 - E22xE24
-------------------------	--



Montagesleutels

Art.nr	mm	L mm
FOR 8221719	17x19	315
FOR 8221922	19x22	315
FOR 8221924	19x24	315
FOR 8222224	22x24	315



Pijpsleutels - Clés à pipe

Art.nr	mm	L mm kort	L mm lang
FOR 75306	6	26	94
FOR 75307	7	28	98
FOR 75308	8	32	114
FOR 75309	9	34	122
FOR 75310	10	37	129
FOR 75311	11	40	140
FOR 75312	12	43	147
FOR 75313	13	45	157
FOR 75314	14	47	164
FOR 75315	15	49	172
FOR 75316	16	53	186
FOR 75317	17	55	194
FOR 75318	18	58	197
FOR 75319	19	63	209
FOR 75322	22	69	231

Pijpsleutel gebogen 6 kant
Clés à pipe débouchée 6 pans



FOR T5114

TC module 11 gebogen pijpsleutels 6 kant
Tc module 11 clés à pipe débouchées 6 pans

753 08....19	8-10-11-12-13-14-15-16-17-18-19 mm
---------------------	------------------------------------



Art.nr	mm	L mm
FOR 7620607	6x7	127
FOR 7620809	8x9	132
FOR 7621011	10x11	132
FOR 7621213	12x13	144
FOR 7621415	14x15	153
FOR 7621617	16x17	162
FOR 7621819	18x19	175

Rechte pijpsleutel 6 kant
Clés en tube 6 pans



FOR T50817

TC module 8 rechte pijpsleutels 6 kant
TC module 8 clés en tube 6 pans

762 0607....1819	6x7-8x9-10x11-12x13-14x15-16x17-18x19
762220	1 wringbar, broche 220 mm L



Open ringsleutelsets - Clés à tuyauter

Open ringsleutels 12 kant/12 pans



Art.nr	mm	L mm
FOR 7510810	8x10	130
FOR 7510910	9x10	130
FOR 7511011	10x11	152
FOR 7511012	10x12	152
FOR 7511113	11x13	165
FOR 7511214	12x14	178
FOR 7511314	13x14	178
FOR 7511417	14x17	194
FOR 7511618	16x18	215
FOR 7511719	17x19	215
FOR 7511922	19x22	235
FOR 7512427	24x27	265
FOR 7513032	30x32	285



Art.nr	inch	L mm
FOR 7510810S	5/16"x3/8"	130
FOR 7511011S	3/8"x7/16"	152
FOR 7511112S	7/16"x1/2"	165
FOR 7511214S	1/2"x9/16"	178
FOR 7511619S	5/8"x3/4"	215
FOR 7511719S	11/16"x3/4"	215
FOR 7511922S	3/4"x7/8"	235

FOR 5066

Open ringsleutelset 6 delig
Jeu de clés à tuyauter 6 pcs

751 0810....1719	8x10 - 10x11 - 10x12 - 11x13 - 12x14 - 17x19
------------------	--



FOR T5082

TC module 8 open ringsleutels
TC module 8 clés à tuyauter

751 0810....3032	8x10 - 11x13 - 12x14 - 16x18 - 17x19 - 19x22 24x27 - 30x32 mm
------------------	---



FOR T50710

TC module 7 open ringsleutels
TC module 7 clés à tuyauter



751 0810S....1922S	5/16"x3/8" - 3/8"x7/16" - 7/16"x1/2" - 1/2"x9/16" - 5/8"x3/4" - 11/16"x3/4" - 3/4"x7/8"
--------------------	---



FOR T5172

TC module kraaienpoot ringsleutelset 12k 17 delig
TC module 17 clés pièd à cornaille 12 pans

7513 10....22	3/8" 10-11-12-13-14-15-16-17-18-19-21-22 mm
7514 23...26	1/2" 23-24-26 mm
808306	3/8" verlenstuk, rallonge 150 mm L
808405	1/2" verlenstuk, rallonge 125 mm L



Kniesleutels - clés à douilles articulée



Art.nr	mm	L mm
FOR 7520607	6x7	198
FOR 7520809	8x9	198
FOR 7521011	10x11	215
FOR 7521213	12x13	227
FOR 7521415	14x15	244
FOR 7521617	16x17	255
FOR 7521819	18x19	274
FOR 7522022	20x22	295
FOR 7522123	21x23	295
FOR 7522427	24x27	323



Art.nr	inch	L mm
FOR 7521011S	3/8"x7/16"	215
FOR 7521314S	1/2"x9/16"	232
FOR 7521617S	5/8"x11/16"	255
FOR 7521922S	3/4"x7/8"	290
FOR 7522122S	13/16"x7/8"	295
FOR 7522425S	15/16"x1"	323

FOR T5074

TC module 7 kniesleutels
TC module 7 clés à douille articulées

752 0607...1819 6x7-8x9-10x11-12x13-14x15-16x17-18x19



FOR T5033

TC module 3 kniesleutels
TC module 3 clés à douille articulées

752 2022....2427 20x22 - 21x23 - 24x27 mm



FOR T50616S

TC module 6 kniesleutels
TC module 6 clés à douille articulées



752 1011S....2425S 3/8"x7/16"-1/2"x9/16"-5/8"x11/16"-3/4"x7/8"-
13/16"x7/8"-15/16"x1"



FOR 50816

Universeel kniegewrichtenset 8 delig
Module de cardan universelle 8 pcs

784 307U...419U 7-8-10-12-13-14-17-19

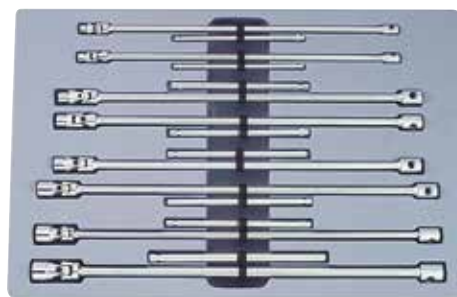

Dopsleutels - douilles sur manches

Art.nr	mm	L mm	Totale L mm
FOR 77430004	4 mm	260mm	300
FOR 77430005	5 mm	260mm	300
FOR 774300055	5.5 mm	260mm	300
FOR 77430006	6 mm	260mm	300
FOR 77430007	7 mm	260mm	300
FOR 77430008	8 mm	260mm	300
FOR 77430009	9 mm	260mm	300
FOR 77430010	10 mm	260mm	300
FOR 77430011	11 mm	260mm	300
FOR 77430012	12 mm	260mm	300
FOR 77430013	13 mm	260mm	300
FOR 77430014	14 mm	260mm	300
FOR 77430017	17 mm	260mm	300



FOR 2095

Dop op T handvat 9 delig
Jeu de 9 douilles à poignée en "T"

774300 05....13	5-6-7-8-9-10-11-12-13 mm
------------------------	--------------------------



FOR 2095S

Dop op T handvat inch maten 9 delig
Jeu de 9 douilles à poignée en "T" en pouces

Art.nr	inch	L mm	Totale L mm
FOR 774003.16	3/16"	260	300
FOR 7743001.4	1/4"	260	300
FOR 7743009.32	9/32"	260	300
FOR 7743005.16	5/16"	260	300
FOR 77430011.32	11/32"	260	300
FOR 7743003.8	3/8"	260	300
FOR 7743007.16	7/16"	260	300
FOR 7743001.2	1/2"	260	300
FOR 7743009.16	9/16"	260	300



FOR 2096

Torx dop op T handvat 9 delig
Jeu de 9 douilles torx à poignée "T"



Art.nr	mm	L mm	Totale L mm
FOR 77604	E4	260mm	300
FOR 77605	E5	260mm	300
FOR 77606	E6	260mm	300
FOR 77607	E7	260mm	300
FOR 77608	E8	260mm	300
FOR 77610	E10	260mm	300
FOR 77612	E12	260mm	300
FOR 77614	E14	260mm	300
FOR 77616	E16	260mm	300

FOR 2134

Dop op schroevendraaier 13 delig
Jeu de 13 tournevis - douilles



Art.nr	mm	L mm	Totale L mm
FOR 74425004	4 mm	135mm	250
FOR 74425005	5 mm	135mm	250
FOR 74425055	5.5 mm	135mm	250
FOR 7442506	6 mm	135mm	250
FOR 7442507	7 mm	135mm	250
FOR 7442508	8 mm	135mm	250
FOR 7442509	9 mm	135mm	250
FOR 7442510	10 mm	135mm	250
FOR 7442511	11 mm	135mm	250
FOR 7442512	12 mm	135mm	250
FOR 7442513	13 mm	135mm	250
FOR 7442514	14 mm	135mm	250

FORT20612

Tc module 6 dop op schroevendraaier
Module de 6 tournevis sur douilles



744300 05....13	6-7-8-10-12-13 mm
-----------------	-------------------

Verstelbare sleutels - Clés à molette

Art.nr	mm	L mm	Gewicht/poids gr
FOR 649200	24 mm	200	242gr
FOR 649250	29 mm	250	397gr
FOR 649300	33 mm	300	605gr
FOR 649375	46 mm	375	1140gr
FOR 649450	60 mm	450	1610gr
FOR 649600	70 mm	600	3280gr

Sleutel met karterwiel, gefosfateerd
Clés à molette phosphatée



Art.nr	mm	L mm	Gewicht/poids gr
FOR 649250A	33 mm	250	440gr
FOR 649375A	46 mm	375	1250gr

Sleutel met karterwiel,
bekleed handvat
Clés à molette chromées gainées



Art.nr	mm	L mm	Gewicht/poids gr
FOR 649200C	38 mm	200	280gr

Art.nr	mm	L mm	Gewicht/poids gr
FOR 649200E	24 mm	200	290gr
FOR 649250E	29 mm	250	500gr
FOR 649300E	33 mm	300	765gr



FOR 9U0701

Aanpasbare spansleutel 1/2" tot 2-3/4"
Clés à ergots 1/2" - 2 3/4"



FOR 823050

Verstelbare haaksleutel 30-50mm
Clés à ergots 30-50mm



FOR T5036

TC module verstelbare moersleutels 3 delig
TC module 3 clés à molette

649200	moersleutel 200 mm	24 mm
649250	moersleutel 250 mm	29 mm
649300	moersleutel 300 mm	33 mm



FOR T5023

TC module verstelbare moersleutels 2 delig
TC module 2 clés à molette

649200E	moersleutel 200 mm	24 mm
649300E	moersleutel 300 mm	33 mm



Slagsleutels - clés à frapper

Slagsteeksleutels
Clés à fourches à frapper

Art.nr	mm	L mm	Gewicht/poids gr
FOR 79136	36	296	700
FOR 79141	41	335	1015
FOR 79146	46	370	1230
FOR 79150	50	410	1810
FOR 79155	55	488	2720



Slag-ringsleutels
Clés polygones à frapper

Art.nr	mm	L mm	Gewicht/poids gr
FOR 79324	24	163	242
FOR 79326	26	180	340
FOR 79327	27	180	340
FOR 79336	36	205	518
FOR 79338	38	205	518
FOR 79346	46	205	930
FOR 79350	50	255	1162
FOR 79352	52	255	1162
FOR 79355	55	270	1362
FOR 79360	60	280	1681
FOR 79365	65	280	2050
FOR 79375	75	335	3000



Momentsleutels - Clés dynamométrique

Art.nr	NM	mm	L mm	nw
FOR 6472275K	5-25Nw	1/4"	270	770gr
FOR 6473270	5-25Nw	3/8"	270	775gr
FOR 6473365	19-110Nw	3/8"	365	1075gr
FOR 6474450K	42-210Nw	1/2"	470	1650gr
FOR 64761030	140-700Nw	3/4"	1030	7575gr
FOR 64781215	140-980Nw	1"	1215	8150gr
FOR 6472270P	repair kit	1/4		
FOR 6473270P	repair kit	3/8		
FOR 6473365P	repair kit	3/8		
FOR 6474470P	repair kit	1/2		

Art.nr	NM	mm	L mm	
FOR 6474535	40-210Nw	1/2"	535	2100gr
FOR 6474661	70-350nW	1/2"	660	2980gr
FOR 64781240	140-980Nw	1"	1240	8100gr
FOR 64781700	300-1500Nw	1"	1700	11580gr

Art.nr	NM	mm	L mm	
FOR 6472300W	6-30Nw	1/4"	300	800gr
FOR 6474530W	40-200nW	1/2"	530	1600gr
FOR 6472300WP	repair set			

Recfhtsomdraaiende momentsleutels



Art.nr	NM	mm	L mm	
FOR 6473383	15-80Nw	1/4"	383	740gr
FOR 6473385	19-110Nw	3/8"	383	960gr
FOR 6474536	40-210Nw	1/2"	535	1070gr

Alle momentsleutels worden geleverd in pvc box

Omschakelbare momentsleutels



Art.nr	NM	mm	L mm	
FOR 647G2360	3-30Nw	1/4"	360	1012gr
FOR 647G3440	10-100Nw	3/8"	440	1204gr
FOR 647G4640	35-350Nw	1/2"	640	2160gr
FOR 647G4075	adapter	1/2"	76	
FOR 647G2360A	3-30Nw	1/4"	360	1012gr
FOR 647G3440A	10-100NW	3/8"	440	1204gr
FOR 647G4640A	35-350NW	1/2"	640	2160gr

Digitale momentsleutels met ratel Clés dynamométrique digital



- Zoemer en LED indicator
- Piek & Volgend modes
- RS-232 data
- Links en rechtsom draaiend
- Gaat automatisch na 120 seconden in slaapstand
- Nauwkeurigheid van ±1%
- Slaat tot 10 metingen op
- Keuze uit: Nm / Ft-lb / In-lb / Kg-m
- Batterij: 1.5V AA batterijen 3x

Haakse sleutels - Clés mâles



Art.nr	mm	L mm	L mm
FOR 7640127	1.27mm	13	41
FOR 764015	1.5 mm	14	45
FOR 76402	2 mm	16	50
FOR 764025	2.5 mm	18	56
FOR 76403	3 mm	20	63
FOR 76404	4 mm	25	70
FOR 76405	5 mm	28	80
FOR 76406	6 mm	32	90
FOR 76407	7 mm	34	95
FOR 76408	8 mm	36	100
FOR 76410	10 mm	40	112
FOR 76411	11 mm	45	125
FOR 76412	12 mm	45	125
FOR 76413	13 mm	50	132
FOR 76414	14 mm	56	140
FOR 76417	17 mm	63	160
FOR 76419	19 mm	70	180
FOR 76422	22 mm	80	200
FOR 76424	24 mm	114	248
FOR 76427	27 mm	127	277

Haakse inbussleutel
Clés mâles 6 pans



Art.nr	mm	L mm	L mm
FOR 7640127L	1.27mm	13	69
FOR 764015L	1.5 mm	15	74
FOR 76402L	2 mm	16	80
FOR 764025L	2.5 mm	18	87
FOR 76403L	3 mm	20	96
FOR 76404L	4 mm	24	107
FOR 76405L	5 mm	28	120
FOR 76406L	6 mm	32	136
FOR 76407L	7 mm	34	145
FOR 76408L	8 mm	36	154
FOR 76410L	10 mm	40	172
FOR 76414L	14 mm	70	244
FOR 76422L	22 mm	102	352

Haakse inbussleutel lang
Clés mâles longues 6 pans



Art.nr	mm	L mm	L mm
FOR 7640127XL	1.27 mm	12	80
FOR 764015XL	1.5 mm	14	90
FOR 76402XL	2 mm	16	100
FOR 764025XL	2.5 mm	18	112
FOR 76403XL	3 mm	20	126
FOR 76404XL	4 mm	25	140
FOR 76405XL	5 mm	28	160
FOR 76406XL	6 mm	32	180
FOR 76407XL	7 mm	34	190
FOR 76408XL	8 mm	36	200
FOR 76410XL	10 mm	40	224
FOR 76412XL	12 mm	45	250
FOR 76413XL	13 mm	50	260
FOR 76414XL	14 mm	56	280
FOR 76417XL	17 mm	63	320
FOR 76419XL	19 mm	70	360

Haakse inbussleutel extra lang
Clés mâles extra longues 6 pans



FOR 5102

Inbussleutelset kort 10 delig plastic houder
Jeu de 10 clés mâles 6 pans

764 0127....10	1.27-1.5-2-2.5-3-4-5-6-8-10 mm
----------------	--------------------------------



FOR 5072F

Inbussleutelset 7 delig inklapbaar
Jeu de 7 clés mâles 6 pans

	2.5-3-4-5-6-8-10 mm
--	---------------------



FOR 5072XL

Inbussleutelset lang 7 delig plastic houder
Jeu de 7 clés mâles longues 6 pans

764 025XL....10XL	2.5-3-4-5-6-8-10 mm
-------------------	---------------------



FOR 5093XL

Inbussleutelset lang 9 delig plastic houder
Jeu de 9 clés mâles longues 6 pans

764 015XL....10XL	1.5-2-2.5-3-4-5-6-8-10 mm
-------------------	---------------------------



FOR 5102XL

Inbussleutelset lang 10 delig plastic houder
Jeu de 10 clés mâles longues 6 pans

764 0127XL....10XL	1.27-1.5-2-2.5-3-4-5-6-8-10 mm
--------------------	--------------------------------



FOR 5137XL

Inbussleutelset lange 13 delig plastic houder
Jeu de 13 clés mâles longues 6 pans

764 02XL...19XL	2-2.5-3-4-5-6-7-8-10-12-14-17-19 mm
-----------------	-------------------------------------



FOR 5137S

Inbussleutelset 13 delig plastic houder
Jeu de 13 clés mâles 6 pans



764 1.16...3.4	1/16"-5/64"-3/32"-1/8"-5/32"-3/16"-1/4"-5/16"-3/8"-1/2"-9/16"-5/8"-3/4"
----------------	---



FOR 5137XLS

Inbussleutelset lange 13 delig plastic houder
Jeu de 13 clés mâles longues 6 pans



764 1.16XL...3.4XL	1/16"-5/64"-3/32"-1/8"-5/32"-3/16"-1/4"-5/16"-3/8"-1/2"-9/16"-5/8"-3/4"
--------------------	---



Inbussleutels - Jeu de clés mâles



Art.nr	mm	L mm	L mm
FOR 765012L	1.27 mm	14	68
FOR 765015L	1.5 mm	15	74
FOR 76502L	2 mm	16	80
FOR 765025L	2.5 mm	18	87
FOR 76503L	3 mm	20	96
FOR 76504L	4 mm	24	107
FOR 76505L	5 mm	28	120
FOR 76506L	6 mm	32	136
FOR 76507L	7 mm	34	145
FOR 76508L	8 mm	36	154
FOR 76510L	10 mm	40	172
FOR 76512L	12 mm	45	190
FOR 76514L	14 mm	70	244

Haakse inbussleutel met kogelkop
Clés mâles avec tête sphérique 6 pans



Art.nr	mm	L mm	L mm
FOR 7650127XL	1.27 mm	12	80
FOR 765015XL	1.5 mm	14	90
FOR 76502XL	2 mm	16	100
FOR 765025XL	2.5 mm	18	112
FOR 76503XL	3 mm	20	126
FOR 76504XL	4 mm	25	140
FOR 76505XL	5 mm	28	160
FOR 76506XL	6 mm	32	180
FOR 76508XL	8 mm	36	200
FOR 76510XL	10 mm	40	224
FOR 76512XL	12 mm	57	262

Haakse inbussleutel met kogelkop
Clés mâles avec tête sphérique 6 pans



FOR 5072LB

Inbussleutelset lang kogelkop 7 delig
Jeu de 7 clés mâles longues tête sphérique

765 025L....10L	2.5-3-4-5-6-8-10 mm
-----------------	---------------------



FOR 5072XLB

Inbussleutelset extra lang kogelkop 7 delig
Jeu de 7 clés mâles extra longues tête sphérique

765 025XL....10XL	2.5-3-4-5-6-8-10 mm
-------------------	---------------------



FOR 5102LB

Inbussleutelset kogelkop 10 delig
Jeu de 10 clés mâles tête sphérique

765 0127L....10L	1.27-1.5-2-2.5-3-4-5-6-8-10 mm
------------------	--------------------------------



FOR 5072XLB S

Inbussleutelset kogelkop 7 delig
Jeu de 7 clés mâles longues tête sphérique



765 3.32XL....3.8XL	3/32"-1/8"-5/32"-3/16"-1/4"-5/16"-3/8"
---------------------	--



FOR 5102XLB

Inbussleutelset kogelkop lang 10 delig plastic houder
Jeu de 10 clés mâles longues tête sphérique

765 0127XL....10XL	1.27-1.5-2-2.5-3-4-5-6-8-10 mm
---------------------------	--------------------------------



FOR 5093LB

Inbussleutelset kogelkop lang 9 delig plastic houder
Jeu de 9 clés mâles longues tête sphérique

765 015XL....10XL	1.5-2-2.5-3-4-5-6-8-10 mm
--------------------------	---------------------------



FOR 5093XLS

Inbussleutelset kogelkop 9 delig extra lang
Jeu de 9 clés mâles longues tête sphérique longues



765 1.16XL....3.8XL	1/16"-5/64"-3/32"-1/8"-5/32"-3/16"-1/4"-5/16"-3/8"
----------------------------	--



FOR 5093LBS

Inbussleutelset kogelkop 9 delig extra lang
Jeu de 9 clés mâles longues tête sphérique longues



765 1.16L....3.8L	1/16"-5/64"-3/32"-1/8"-5/32"-3/16"-1/4"-5/16"-3/8"
--------------------------	--



FOR 5093XLB

Inbussleutelset kogelkop lang 9 delig plastic houder
Jeu de 9 clés mâles longues tête sphérique

765 015XL....10XL	1.5-2-2.5-3-4-5-6-8-10 mm
--------------------------	---------------------------



FOR 5116LB

Inbussleutelset kogelkop 11 delig
Jeu de 11 clés mâles longues à tête sphérique

765 015L....12L	1.5-2-2.5-3-4-5-6-7-8-10-12 mm
------------------------	--------------------------------



FOR 5116XLB

Inbussleutelset kogelkop 11 delig lange versie
Jeu de 11 clés mâles longues à tête sphérique extra longues

765 015XL....12X	1.5-2-2.5-3-4-5-6-7-8-10-12 mm
-------------------------	--------------------------------



FOR T5303

Module haakse sleutel & bitset 30 dlg
Module de clés mâles coudées & embouts 30pcs

21013	1/4" TS8-TS10-TS15-TS20-TS25-TS27+TS30-TS40-TS45-TS50
5093XLS	1/16"-5/64"-3/32"-1/8"-5/32"-3/16"-1/4"-5/16"-3/8"
5098XL	T10-T15-T20-T25-T27-T30-T40-T45-T50



Haakse torx sleutels - Clés mâles torx



Art.nr	mm	L mm	L mm
FOR 76606	T6	18	64
FOR 76607	T7	19	70
FOR 76608	T8	20	72
FOR 76609	T9	21	75
FOR 76610	T10	21	81
FOR 76615	T15	23	85
FOR 76620	T20	24	89
FOR 76625	T25	24	95
FOR 76627	T27	25	100
FOR 76630	T30	28	112.5
FOR 76640	T40	30	119
FOR 76645	T45	31	128
FOR 76650	T50	34	148
FOR 76655	T55	37	168
FOR 76660	T60	39	185
FOR 76670	T70	43	200
FOR 76680	T80	45	213

Haakse torx sleutel
Clés mâles pour vis TorxHaakse torx sleutel lang
Clés mâles pour vis Torx longues

Art.nr	mm	L mm	L mm
FOR 76606L	T6	18	68
FOR 76607L	T7	18	73
FOR 76608L	T8	18	77
FOR 76609L	T9	18	82
FOR 76610L	T10	19	86
FOR 76615L	T15	21	90
FOR 76620L	T20	23	95
FOR 76625L	T25	25	98
FOR 76627L	T27	26	105
FOR 76630L	T30	29	115
FOR 76640L	T40	33	1122
FOR 76645L	T45	36	138
FOR 76650L	T50	40	155
FOR 76655L	T55	45	172
FOR 76660L	T60	52	200

Haakse Resistorx sleutel
Clés mâles pour vis Resistorx

Art.nr	mm	L mm	L mm
FOR 76706L	T6H	21	68
FOR 76707L	T7H	21	73
FOR 76708L	T8H	23	76
FOR 76709L	T9H	23	79
FOR 76710L	T10H	24	85
FOR 76715L	T15H	28	88
FOR 76720L	T20H	29	94
FOR 76725L	T25H	32	98
FOR 76727L	T27H	33	104
FOR 76730L	T30H	32	118
FOR 76740L	T40H	38	126
FOR 76745L	T45H	38	138
FOR 76750L	T50H	42	160
FOR 76755L	T55H	51	178
FOR 76760L	T60H	57	197

FOR 5083F

Torx sleutelset in boekvorm 8 delig
Jeu de 8 clés torx

766 10....40	T9-T10-T15-T20-T25-T27-T30-T40
--------------	--------------------------------



FOR 5098LB

L torx + torx met bolkop 9 delig
Jeu de 9 clés pour vis torx + avec tête sphérique

766 10BL....50BL	T10-T15-T20-T25-T27-T30-T40-T45-T50
------------------	-------------------------------------



FOR 5071

L torx sleutelset 7 delig
Jeu de 7 clés pour vis torx

766 10....40

T10-T15-T20-T25-T27-T30-T40



FOR 5151

L torx sleutelset 15 delig
Jeu de 15 clés mâles pour vis torx

766 06....60

T6-T7-T8-T9-T10-T15-T20-T25-T27-T30-T40-T45-T50-T55-T60



FOR 5151L

L torx sleutelset lang 15 delig
Jeu de 15 clés pour vis torx longues

766 06L....60L

T8-T7-T8-T9-T10-T15-T20-T25-T27-T30-T40-T45-T50-T55-T60



FOR 5151LT

L Resistorx sleutelset lang 15 delig
Jeu de 15 clés pour vis resistorx longues

767 06H....60H

T8H-T7H-T8H-T9H-T10H-T15H-T20H-T25H-T27H-T30H-T40H-T45H-T50H-T55H-T60H



FOR 5098

L torx sleutelset lang 9 delig
Jeu de 9 clés pour vis torx

766 10....50

T10-T15-T20-T25-T27-T30-T40-T45-T50



FOR 5098LT

L Resistorx sleutelset lang 9 delig
Jeu de 9 clés pour vis resistorx longues

767 10H....50H

T10H-T15H-T20H-T25H-T27H-T30H-T40H-T45H-T50H



FOR 5098XLT

L Resistorx sleutelset extra lang 9 delig
Jeu de 9 clés pour vis resistorx extra longues

767 10H....50H

T10H-T15H-T20H-T25H-T27H-T30H-T40H-T45H-T50H



FOR 50913

Haakse 5-kant resistorx TS sleutelset 9 delig
Jeu de 9 clés mâles coudées Torx TS-5spans percés

TS10-TS15-TS20-TS25-TS27-TS30-TS40-TS45-TS50



Inbussleutels op handvat - Clés mâles

Art.nr	mm	L mm kort	L mm lang
FOR 76502G	2 mm	53	126 mm
FOR 765025G	2.5 mm	53	126 mm
FOR 76503G	3 mm	53	126 mm
FOR 76504G	4 mm	68	183 mm
FOR 76505G	5 mm	68	183 mm
FOR 76506G	6 mm	82	240 mm
FOR 76507G	7 mm	82	240 mm
FOR 76508G	8 mm	82	240 mm
FOR 76510G	10 mm	82	240 mm
FOR 76512G	12 mm	82	240 mm
FOR 7655.64G	5/64"	53	126 mm
FOR 7653.32G	3/32"	53	126 mm
FOR 7651.8G	1/8"	68	183 mm
FOR 7655.32G	5/32"	68	183 mm
FOR 7653.16G	3/16"	82	240 mm
FOR 7651.4G	1/4"	82	240 mm
FOR 7655.16G	5/16"	82	240 mm
FOR 7653.8G	3/8"	82	240 mm
FOR 7651.2G	1/2"	82	240 mm

Inbus met kogelkop
en L grip hendel
Clés à poignée en "L"
6 pans tête sphérique



FOR 5106B

Inbus + ball point op Lhandvat 10 delig
Jeu de 10 clés 6 pans à tête sphérique



765 02....12G	2-2.5-3-4-5-6-7-8-10-12 mm
---------------	----------------------------



FOR 50910BS

Inbus + ball point op L handvat 9 delig
Jeu de 9 clés 6 pans à tête sphérique



765 5.64.....1.2G	5/64"-3/32"-1/8"-5/32"-3/16"-1/4"-5/16"-3/8"-1/2"
-------------------	---

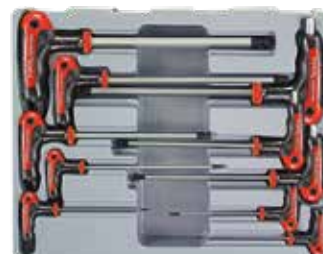

FOR T50637

Module Inbus op L handvat 6 delig
Module de 6 clés 6 pans



765 02....88G	2-3-4-5-6-8 mm
---------------	----------------



FOR 50912

T sleutelset inbus 9 delig
Jeu de 9 clés 6 pans - poignée en T



Art.nr	mm	L mm	L mm breedte
FOR 76402T	2 mm	125 mm	62
FOR 764025T	2.5 mm	125 mm	62
FOR 76403T	3 mm	150 mm	75
FOR 76404T	4 mm	180 mm	90
FOR 76405T	5 mm	180 mm	90
FOR 76406T	6 mm	210 mm	105
FOR 76407T	7 mm	210 mm	105
FOR 76408T	8 mm	250 mm	125
FOR 76410T	10 mm	300 mm	150

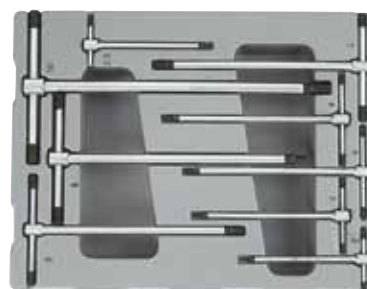

Art.nr	mm	L mm	Totale L mm
FOR 72402	2 mm	100mm	130 mm
FOR 724025	2.5 mm	100mm	130 mm
FOR 72403	3 mm	100mm	130 mm
FOR 72404	4 mm	150mm	185 mm
FOR 72405	5 mm	150mm	185 mm
FOR 72406	6 mm	200mm	240 mm
FOR 72407	7 mm	200mm	240 mm
FOR 72408	8 mm	200mm	240 mm
FOR 72410	10 mm	200mm	240 mm
FOR 72502	2 mm	100mm	130 mm
FOR 725025	2.5 mm	100mm	130 mm
FOR 72503	3 mm	100mm	130 mm
FOR 72504	4 mm	150mm	185 mm
FOR 72505	5 mm	150mm	185 mm
FOR 72506	6 mm	200mm	240 mm
FOR 72507	7 mm	200mm	240 mm
FOR 72508	8 mm	200mm	240 mm
FOR 72510	10 mm	200mm	240 mm

Inbus T grip hendel
Clés à poignée en "T"
6 pans (724 serie)



Inbus met kogelkop
en T grip hendel
Clés à poignée en "T"
6 pans tête sphérique
(725 serie)

FOR 2097

Inbussleutelset op T handvat 9 delig
Jeu de 9 clés 6 pans - poignée en "T"



724 02....10	2-2.5-3-4-5-6-7-8-10 mm
---------------------	-------------------------



FOR 2097B

Inbussleutelset met kogelkop T handvat 9 delig
Jeu de 9 clés 6 pans à tête sphérique



725 02....10	2-2.5-3-4-5-6-7-8-10 mm
---------------------	-------------------------



FOR 2097S

Inbussleutelset engele maten T handvat 9 delig
Jeu de 9 clés 6 pans



724 3.32.....3.8	3/32-7/64"-1/8"-5/32"-3/16"-7/32"-1/4"-5/16"-3/8"
-------------------------	---



Torx - resistorx

Art.nr	mm	L mm	Totale L mm
FOR 72606	T6	100 mm	130mm
FOR 72607	T7	100 mm	130mm
FOR 72608	T8	100 mm	130mm
FOR 72609	T9	100 mm	130mm
FOR 72610	T10	100 mm	130mm
FOR 72615	T15	100 mm	130mm
FOR 72620	T20	100 mm	135mm
FOR 72625	T25	100 mm	135mm
FOR 72627	T27	200 mm	240mm
FOR 72630	T30	200 mm	240mm
FOR 72640	T40	200 mm	240mm
FOR 72645	T45	200 mm	240mm
FOR 72650	T50	200 mm	240mm
FOR 72655	T55	200 mm	240mm

Art.nr	mm	L mm	Totale L mm
FOR 72706	T6H	100 mm	130mm
FOR 72707	T7H	100 mm	130mm
FOR 72708	T8H	100 mm	130mm
FOR 72709	T9H	100 mm	130mm
FOR 72710	T10H	100 mm	130mm
FOR 72715	T15H	100 mm	130mm
FOR 72720	T20H	100 mm	135mm
FOR 72725	T25H	100 mm	135mm
FOR 72727	T27H	200 mm	240mm
FOR 72730	T30H	200 mm	240mm
FOR 72740	T40H	200 mm	240mm
FOR 72745	T45H	200 mm	240mm
FOR 72750	T50H	200 mm	240mm

Torx T hendel
Clés à poignée "T" torx



Resistorx T hendel
Clés à poignée "T" resistorx



FOR 2141
FOR 2141T

T hendel torx set 14 delig
Jeu de 14 clés torx à poignée "T"

726 06....55	T6-T7-T8-T9-T10-T15-T20-T25-T27-T30-T40-T45-T50-T55
2141T	idem maar resistorx



Art.nr	mm	L mm	L mm
FOR 76710G	T10xT10H	53	126
FOR 76715G	T15xT15H	53	126
FOR 76720G	T20xT20H	68	126
FOR 76725G	T25xT25H	68	133
FOR 76727G	T27xT27H	68	133
FOR 76730G	T30xT30H	82	190
FOR 76740G	T40xT40H	82	190
FOR 76745G	T45xT45H	82	190
FOR 76750G	T50xT50H	82	190
FOR 76755G	T55xT55H	82	190

Torx - Resistorx L hendel
Clés à poignée "L" torx - resistorx



FOR 51010T

L hendel resistorx set 10 delig
Jeu de 10 clés resistorx à poignée "T"



767 10G....55G	T10H-T15H-T20H-T25H-T27H-T30H-T40H-T45T-T50H-T55H
-----------------------	---



FOR T50636

L hendel resistorx set 6 delig
Jeu de 6 clés resistorx à poignée "T"



767 10G....30G	T10H-T15H-T20H-T25H-T27H-T30H
-----------------------	-------------------------------

















SCHROEVENDRAAIERS

JEU DE TOURNEVIS





	Schroevendraaiers - tournevis	204
	Torx schroevendraaiers - tournevis torx	207
	Resistorx schroevendraaiers - tournevis resistorx	208
	Schroevendraaiers met stalen kop tournevis à frapper	209
	Slagschroevendraaier - tournevis à frapper	210
	Bitsen 5/16" - embouts 5/16"	211
	Schroevendraaiers 1000 v - tournevis VDE	213
	Bitsets - jeu d'embouts	214
	Bitsen - embouts 1/4"	216
	Bithouders - porte embout	215
	Bitsets 10 mm - jeu d'embouts 10 mm	218
	Bitsen - Embouts 10 mm	220

FOR T2084A

TC module schroevendraaierset 8 delig
TC module 8 tournevis

71303A	3 mm (75 mm L)
713035A	3,5 mm (100 mm L)
71304A	4 mm (100 mm L)
713055A	5,5 mm (125 mm L)
713065A	6,5 mm (125 mm L)
71308A	8 mm (150 mm L)
7111A	PH,1 (80 mm L)
7112A	PH,2 (100 mm L)



FOR 2068

Schroevendraaierset 6 delig
Jeu de 6 tournevis

71303A	3 mm (75 mm L)
71304A	4 mm (100 mm L)
713055A	5,5 mm (125 mm L)
713065A	6,5 mm (125 mm L)
7111A	PH 1 (80 mm L)
7112A	PH 2 (100 mm L)



FOR 20611

Schroevendraaierset extra lang 6 delig
Jeu de 6 tournevis extra longue

65511	PH1 (350 mm L)
65512	PH2 (350 mm L)
655304	4 mm (300 mm L)
655305	5 mm (300 mm L)
655306	6 mm (300 mm L)
655308	8 mm (300 mm L)



FOR T2085A

TC module schroevendraaierset 8 delig
TC module 8 tournevis

713055S	Plat 5,5 mm (25 mm L)
713065S	Plat 6,5 mm (38 mm L)
7110	Philips PH,0 (60 mm L)
7111S	PH,1 (25 mm L)
7120	PZ,0 (60 mm L)
7121	PZ,1 (80 mm L)
7121S	PZ,1 (25 mm L)
7122	PZ,2 (100 mm L)

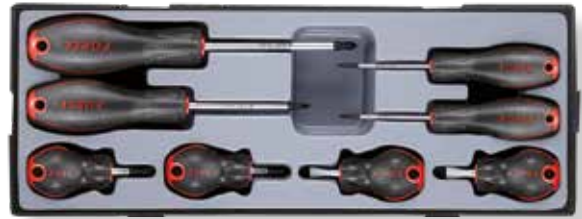

FOR 20915

Schroevendraaierset 9 delig
Jeu de 9 tournevis

713 03...065	3 mm (75 mm L), 4 mm (100 mm L), 5.5 mm (125 mm L) 6.5 mm (150 mm L)
713055S	5.5 mm (25 mm L)
7111-7112	PH1 (80 mm L) PH2 (80 mm L)
7111S-7112S	PH1 (25 mm L) PH2 (25 mm L)



FOR 2142A

Schroevendraaierset 14 delig
Jeu de 14 tournevis

71303	3 mm (75 mm L)
713035	3.5 mm (100 mm L)
71304	4 mm (100 mm L)
713055	5.5 mm (125 mm L)
713065	6,5 mm (150 mm L)
71308	8 mm (175 mm L)
713055S, 713065S	5,5 mm (25 mm L) 6,5 mm (125 mm L)
7110, 7111	PH 0 (60 mm L) PH 1 (80 mm L)
7112, 7113	PH 2 (100 mm L) PH 3(150 mm L)
7111S, 7112S	PH 1 (25 mm L) PH 2 (25 mm L)





Platte
plat

Art.nr	mm	schacht L mm	Totale lengte
FOR 713055AS	1.0 x 5.5	25 mm	75mm
FOR 713065AS	1.2 x 6.5	25 mm	75mm
FOR 71303A	0.5 x 3	75 mm	160mm
FOR 713035A	0.5 x 3.5	100 mm	185mm
FOR 71304A	0.8 x 4	100 mm	205mm
FOR 713055A	1.0 x 5.5	125 mm	230mm
FOR 713065A	1.2 x 6.5	150 mm	265mm
FOR 71308A	1.2 x 8	175 mm	300mm
FOR 655304	4	300 mm	400mm
FOR 655305	5	300 mm	400mm
FOR 655306	6	300 mm	400mm
FOR 655308	8	300 mm	400mm



Philips

Art.nr	mm	L mm	Totale lengte
FOR 7111AS	PH1	25 mm	75mm
FOR 7112AS	PH2	25 mm	75mm
FOR 7110A	PH0	60 mm	145mm
FOR 7111A	PH1	80 mm	185mm
FOR 7112A	PH2	100 mm	215mm
FOR 7113A	PH3	150 mm	275mm
FOR 65511	PH1	350 mm	450mm
FOR 65512	PH2	350 mm	450mm



Pozidriv

Art.nr	mm	L mm	Totale lengte
FOR 7121AS	PZ1	25 mm	75mm
FOR 7122AS	PZ2	25 mm	75mm
FOR 7120A	PZ0	60 mm	145mm
FOR 7121A	PZ1	80 mm	185mm
FOR 7122A	PZ2	100 mm	215mm
FOR 7123A	PZ3	150 mm	278mm



FOR T2086A

TC module schroevendraaierset torx 8 delig
TC module 8 tournevis torx



71608	T8
71610	T10
71615	T15
71620	T20
71625	T25
71627	T27
71630	T30
71640	T40



FOR 2137A

Torx schroevendraaierset 13 delig
Jeu de 13 tournevis torx



71605	T5
71606	T6
71608	T8
71610	T10
71615	T15
71620	T20
71625	T25
71630	T30
71640	T40
71645	T45



FOR 20719

Torx schroevendraaierset 7 delig 300 mm L
Jeu de 7 tournevis torx 300 mm L



71630010	T10	300 mm L
71630015	T15	300 mm L
71630020	T20	300 mm L
71630025	T25	300 mm L
71630027	T27	300 mm L
71630030	T30	300 mm L
71630040	T40	300 mm L



FOR 2119T

Resistorx schroevendraaierset 11 delig
Jeu de 11 tournevis resistorx



717 06....40	T6-T7-T8-T9-T10-T15-T20-T25-T27-T30-T40
--------------	---



Art. nr.	mm	L mm	Totale lengte
FOR 71605A	T5	75	145mm
FOR 71606A	T6	75	145mm
FOR 71607A	T7	75	145mm
FOR 71608A	T8	75	145mm
FOR 71609A	T9	75	145mm
FOR 71610A	T10	100	185mm
FOR 71615A	T15	100	185mm
FOR 71620A	T20	100	205mm
FOR 71625A	T25	100	205mm
FOR 71627A	T27	100	230mm
FOR 71630A	T30	100	230mm
FOR 71640A	T40	100	245mm
FOR 71645A	T45	100	255mm
FOR 71630010	T10	300	405mm
FOR 71630015	T15	300	405mm
FOR 71630020	T20	300	405mm
FOR 71630025	T25	300	405mm
FOR 71630027	T27	300	415mm
FOR 71630030	T30	300	415mm
FOR 71630040	T40	300	415mm
FOR 71630045	T45	300	427mm



Torx



Art.nr	mm	L mm	Totale lengte
FOR 71706A	T6H	60	145mm
FOR 71707A	T7H	60	145mm
FOR 71708A	T8H	60	145mm
FOR 71710A	T10H	80	185mm
FOR 71715A	T15H	80	185mm
FOR 71720A	T20H	100	205mm
FOR 71725A	T25H	100	205mm
FOR 71727A	T27H	115	230mm
FOR 71730A	T30H	115	230mm
FOR 71740A	T40H	130	245mm
FOR 71745A	T45H	130	245mm



Resistorx



Art.nr	mm	L mm	Totale lengte
FOR 71F10	TS10	150	255mm
FOR 71F15	TS15	150	255mm
FOR 71F20	TS20	150	255mm
FOR 71F25	TS25	150	255mm
FOR 71F27	TS27	150	270mm
FOR 71F30	TS30	150	270mm
FOR 71F40	TS40	150	280mm

Resistorx 5 kant

FOR 2108

Schroevendraaierset 10 delig met stalen kop
Jeu de 10 tournevis à frapper

713055M	5,5 (125 mm L)
713065M	6.5 (150 mm L)
71308M-71310M	8 (150 mm L) 10 (200 mm L)
71312M-71314M	12 (200 mm L) 14 (250 mm L)
7111M-7112M	PH1 (80 mm L) PH2 (100 mm L)
7113M-7114M	PH3 (150 mm L) PH4 (200 mm L)



FOR 2109

Schroevendraaierset 10 delig met stalen kop
Jeu de 10 tournevis à frapper

713055M	5,5 (125 mm L)
713065M	6.5 (150 mm L)
71308M-71310M	8 (150 mm L) 10 (200 mm L)
71312M-71314M	12 (200 mm L) 14 (250 mm L)
7121M-7122M	PZ1 (80 mm L) PZ2 (100 mm L)
7123M-7124M	PZ3 (150 mm L) PZ4 (200 mm L)



FOR 20610

Schroevendraaierset 6 delig met stalen kop
Jeu de 6 tournevis à frapper

713055M	5,5 (125 mm L)
713065M	6.5 (150 mm L)
71310M	10 (200 mm L)
71314M	12 (200 mm L)
7122M -7123M	PH2 (100 mm L) PH3 (150 mm L)



Art.nr	mm	L mm	Totale lengte
FOR 713055M	5.5 mm	125	230mm
FOR 713065M	6.5 mm	150	265mm
FOR 71308M	8 mm	150	275mm
FOR 71310M	10 mm	200	325mm
FOR 71312M	12 mm	200	325mm
FOR 71314M	14 mm	250	375mm
FOR 7111M	PH1	80	185mm
FOR 7112M	PH2	100	215mm
FOR 7113M	PH3	150	275mm
FOR 7114M	PH4	200	325mm
FOR 7121M	PZ1	80	185mm
FOR 7122M	PZ2	100	215mm
FOR 7123M	PZ3	150	275mm
FOR 7124M	PZ4	200	325mm



Stalen kop
Tournevis à frapper



FOR T2173

TC module precisie schroevendraaierset 17 delig
TC module 8 tournevis mini 17 pcs

731040 000... 00	PH000 PH 00 40 mm L
733040 01 ...024	plat 1-1.2-1.5-1.8-2.0-2.5 mm 40 mm L
734040 009...15	hex 0.9-1.3-1.5 mm
73640 05 ...08	T5-T6-T7-T8
2161.1	pincet
88601	demagnetiseur

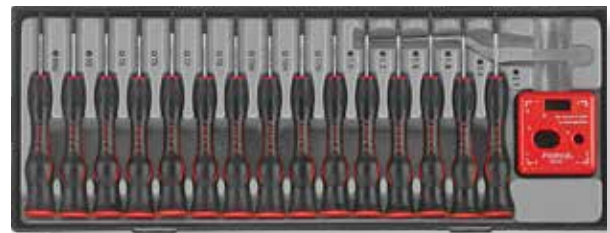

FOR 2087A

Mini precisie schroevendraaierset 8 delig
Jeu de 8 tournevis mini

731075 00... 1	PH 00 PH0 PH 1 (75mm L)
733040 02 ...04	plat 2-2.5-3.0 3.5 4.0 75 mm L



FOR 2088A

Mini precisie schroevendraaierset 8 delig
Jeu de 8 tournevis mini

736040 05...08	T5-T6-T7-T8mm (40mmL)
736075 09 ...20	T9-T10-T15-T20 mm (75mmL)

FOR 5171

Slagschroevendraaier 17 delig
Jeu de tournevis à frapper 17 pcs

8174	Slagschroevendraaier
151362.....3	5/16" Philips PH,2 - PH,3 (36 mm L)
152362.....3	5/16" Pozidriv PZ,2 - PZ3 (36 mm L)
1533609.....11	5/16" Plat 9-11 mm (36 mm L)
1563525.....50	5/16" Torx T25-T30-T40-T45-T50 (35 mm L)
1543606.....10	5/16" Hex 6-8-10 mm (36 mm L)
8095330	1 bit adapter 5/16" hex 3/8"
81045A	impact adapter houder 1/2"-5/16"

Flexibele dopschroevendraaier 6 kant
Tournevis flexible 6 pans

Art. nr.	mm	mm	Totale lengte
FOR 64806	6mm	160mm	270mm
FOR 64807	7mm	160mm	270mm
FOR 64808	8mm	160mm	270mm



Bitsen - Embouts 5/16"

5/16" Philips bit



Art.nr	mm	L mm
FOR 151301	PH.1	30 mm
FOR 151302	PH.2	30 mm
FOR 151303	PH.3	30 mm
FOR 151304	PH.4	30 mm
FOR 151361	PH.1	36 mm
FOR 151362	PH.2	36 mm
FOR 151363	PH.3	36 mm
FOR 151364	PH.4	36 mm
FOR 151384	PH.4	38 mm

5/16" Pozidriv bit



Art.nr	mm	L mm
FOR 152301	PZ.1	30 mm
FOR 152302	PZ.2	30 mm
FOR 152303	PZ.3	30 mm
FOR 152362	PZ.2	36 mm
FOR 152363	PZ.3	36 mm

5/16" Platte bit



Art.nr	mm	L mm
FOR 1533008	1.2x8	30 mm
FOR 1533010	1.6x10	30 mm
FOR 1533609	1.6x9	36 mm
FOR 1533611	1.8x11	36 mm

5/16" Inbus bit



Art.nr	mm	L mm
FOR 1543005	5	30 mm
FOR 1543006	6	30 mm
FOR 1543007	7	30 mm
FOR 1543008	8	30 mm
FOR 1543010	10	30 mm
FOR 1543012	12	30 mm
FOR 1543014	14	30 mm

5/16" Torx bit (156)



Art.nr	mm	L mm
FOR 1563010	T10	30 mm
FOR 1563015	T15	30 mm
FOR 1563020	T20	30 mm
FOR 1563025	T25	30 mm
FOR 1563027	T27	30 mm
FOR 1563030	T30	30 mm
FOR 1563040	T40	30 mm
FOR 1563045	T45	30 mm
FOR 1563050	T50	30 mm
FOR 1563055	T55	30 mm
FOR 1563060	T60	30 mm
FOR 1563530	T30	35 mm
FOR 1563540	T40	35 mm
FOR 1567020	T20	70 mm
FOR 1567025	T25	70 mm
FOR 1567030	T30	70 mm
FOR 1567040	T40	70 mm
FOR 1567045	T45	70 mm
FOR 1567050	T50	70 mm
FOR 1567055	T55	70 mm
FOR 1567060	T60	70 mm

5/16" Resistorx bit (157)



Art.nr	mm	L mm
FOR 1573010	T10	30 mm
FOR 1573015	T15	30 mm
FOR 1573020	T20	30 mm
FOR 1573025	T25	30 mm
FOR 1573027	T27	30 mm
FOR 1573030	T30	30 mm
FOR 1573040	T40	30 mm
FOR 1573045	T45	30 mm
FOR 1573050	T50	30 mm
FOR 1573055	T55	30 mm
FOR 1573060	T60	30 mm
FOR 1573530	T30	35 mm
FOR 1573540	T40	35 mm
FOR 1577020	T20	70 mm
FOR 1577025	T25	70 mm
FOR 1577030	T30	70 mm
FOR 1577040	T40	70 mm
FOR 1577045	T45	70 mm
FOR 1577050	T50	70 mm
FOR 1577055	T55	70 mm
FOR 1577060	T60	70 mm

FOR 2125 FOR 2126 pozidriv

Geïsoleerde schroevendraaierset 12 delig Jeu de 12 tournevis 1000v

713N025, 713N03	2,5 (75 mm L) 3 (100 mm L)
713N035, 713N04	3,5 (100 mm L) 4 (100 mm L)
713N055, 713N065	5,5 (125 mm L) 6,5 (150 mm L)
713N08	8 (175 mm L)
711N0, 711N1	PH0 (60 mm L) PH1 (80 mm L)
711N2, 711N3	PH2 (100 mm L) PH3 (150 mm L)
2125P1	circuit tester



FOR T20712

TC module geïsoleerde schroevendraaierset 7 delig TC module 7 tournevis 1000v

711N1, 711N2	PH1 (80 mm L) PH2 (100 mm L)
713N03	3 mm (100 mm L)
713N04	4 mm (100 mm L)
713N055	5.5 mm (125 mm L)
713N065	6.5 mm (150 mm L)
2125P1	circuit tester



FOR T20715

TC module geïsoleerde schroevendraaierset 7 delig TC module 7 tournevis 1000v

711N1, 711N2	PH1 (80 mm L) PH2 (100 mm L)
713N03	3 mm (100 mm L)
713N04	4 mm (100 mm L)
713N055	5.5 mm (125 mm L)
713N065	6.5 mm (150 mm L)



FOR 20916

Geïsoleerde schroevendraaierset 9 delig Jeu de 9 tournevis 1000v

713N025, 713N03	2,4 (75 mm L) 3 (100 mm L)
713N035, 713N04	3,5 (100 mm L) 4 (100 mm L)
713N055, 713N065	5,5 (125 mm L) 6,5 (150 mm L)
711N1, 711N2	PH1 (80 mm L) PH2 (100 mm L)
88401	circuit tester



1000v



Art.nr	mm	L mm schacht	Totale lengte
FOR 713N025	2.5 mm	75	160mm
FOR 713N03	3 mm	100	185mm
FOR 713N035	3.5 mm	100	185mm
FOR 713N04	4 mm	100	210mm
FOR 713N055	5.5 mm	125	235mm
FOR 713N065	6.5 mm	150	270mm
FOR 713N08	8 mm	175	305mm
FOR 711N0	PH0	60	145mm
FOR 711N1	PH1	80	190mm
FOR 711N2	PH2	100	220mm
FOR 711N3	PH3	150	280mm
FOR 712N0	PZ0	60	145mm
FOR 712N1	PZ1	80	190mm
FOR 712N2	PZ2	100	220mm
FOR 712N3	PZ3	150	280mm



FOR 88407

Stroomtester
Testeur de circuit



FOR 88601

Magnetiseur
Demagnetiseur



Bitsets 1/4" - Jeu d'embouts

FOR 2081C

Bitset 1/4" 8 delig

Jeu d'embouts 1/4" 8 pcs

12130 1G....3G	PH1-PH2-PH3 (30 mm L)
12230 1G....3G	PZ1-PZ2-PZ3 (30 mm L)
1233007G	platte bit 7 mm (30 mm L)
8152105	bit houder sleutel/porte embout

FOR 2081

Bitset resistorx 1/4" 8 delig

Jeu d'embouts resistorx 1/4" 8 pcs

12730 10...40	T10H-T15H-T20H-T25H-T27H-T30H-T40H (30mmL)
8152105	bit houder sleutel/porte embout (110mmL)



FOR 21111

Bitset 1/4" 11 delig

Jeu d'embouts 1/4" 11 pcs

12125 0....3	PH0-PH1-PH2-PH3 (25 mm L)
12225 0....3	PZ0-PZ1-PZ2-PZ3 (25 mm L)
12325 055....065	plat 5.5 mm-6.5 mm (25 mm L)
81260Q	magnetische bit houder/porte embout magnétique



FOR 21113

Bitset torx 1/4" 11 delig

Jeu d'embouts torx 1/4" 11 pcs

12625 07...40	T7-T8-T9-T10-T15-T20-T25-T27-T30-T40 (25mmL)
81260Q	magnetische bit houder/porte embout magnétique



FOR 2331

Veiligheidsbitset 1/4" 33 delig

Jeu d'embouts 1/4" 33 pcs

81260	magnetische bithouder (60 mm L)
121S25 06....10	6-8-10
122S25 01....04	Tri wing 1-2-3-4
123S25 04....10	spanner 4-6-8-10
124S25 02....06	inbus 2-2.5-3-4-5-6 mm
124S25 5.32....5.64	5/32"-9/64"-1/8"-7/64"-3/32"-5/64"
12725 08....40	resistorx T8H-T10H-T15H-T20H-T25T-T27H-T30H-T35H-T40H

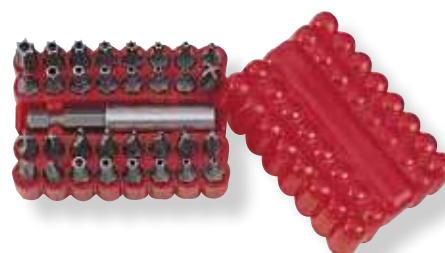

FOR 21022

Bitset 1/4" 102 delig

Jeu d'embouts 1/4" 102 pcs

12125 1....3	PH1-PH2-PH3 (25 mm L)
12225 1....3	PZ1-PZ2-PZ3 (25 mm L)
12325 04....065	plat 4-5.5-6.5 (25 mm L)
12425 02....06	inbus 2-3-4-5-6 mm (25 mm L)
12625 06....40	torx T6-T8-T10-T15-T20-T25-T27-T30-T40
12725 06....40	resistorx T6H-T8H-T10H-T15H-T20H-T25H-T27H-T30H-T40H
81260Q	magnetische bithouder, porte embout
81260	magnetisch bithouder (60 mm L)



FOR 21012

Torxset 1/4" 10 delig
Jeu de torx 1/4" 10 pcs



12625 07.....40	T7-T8-T9-T10-T15-T20-T25-T27-T30-T40
-----------------	--------------------------------------

FOR 21013

Resistorxset 5 kant 1/4" 10 delig
Resistorx 5 pans 1/4" 10 pcs



12F25 08.....50	TS08-TS10-TS15-TS20-TS25-TS27-TS30-TS45-TS50 25 mm L
-----------------	--

FOR 2311

Bitset 1/4" 31 delig
Jeu d'embouts 1/4" 31 pcs

81260Q	bithouder magnetisch 60 mm L
12125 0...3	PH0-PH1-PH2-PH3
12225 0...3	PZ0-PZ1-PZ2-PZ3
12325 03 ...065	plat 3-4-5-6.5 mm
12425 02...06	inbus 2-2.5-3-4-5-6 mm
12725 10...40	T10H-T15H-T20H-T25H-T27H-T30H-T35H-T40H



FOR 20918

Bitset 1/4" 9 dlg
Jeu d'embouts 1/4" 9 pcs

	1/4" PH1-PH2 (165mmL)
	1/4" PZ1-PZ2 (165mmL)
	1/4" 3x4mm - 5.5x7mm (165mmL)
	1/4" T8xT10-T15xT20-T25xT27-T30xT40
8152	1/4" inhex 125mm



ZA BT122

Bitset 122 dlg
Jeu d'embouts 122 pcs



Bitsen - Embouts 1/4"

1/4" Philips bit



Art.nr	mm	L mm
FOR 121250	PH.0	25 mm
FOR 121251	PH.1	25 mm
FOR 121252	PH.2	25 mm
FOR 121253	PH.3	25 mm



1/4" Pozidriv bit



Art.nr	mm	L mm
FOR 122250	PZ.0	25 mm
FOR 122251	PZ.1	25 mm
FOR 122252	PZ.2	25 mm
FOR 122253	PZ.3	25 mm



1/4" Platte bit



Art.nr	mm	L mm
FOR 1232503	0.5x3	25 mm
FOR 1232504	0.8x4	25 mm
FOR 1232505	0.8x5	25 mm
FOR 12325055	1.0x5.5	25 mm
FOR 12325065	1.2x6.5	25 mm



1/4" Inbus bit



Art.nr	mm	L mm
FOR 1242503	3	25 mm
FOR 1242504	4	25 mm
FOR 1242505	5	25 mm
FOR 1242506	6	25 mm
FOR 1242507	7	25 mm
FOR 1242508	8	25mm



1/4" Torx bit



Art.nr	mm	L mm
FOR 1262504	T4	25 mm
FOR 1262505	T5	25 mm
FOR 1262506	T6	25 mm
FOR 1262507	T7	25 mm
FOR 1262508	T8	25 mm
FOR 1262509	T9	25 mm
FOR 1262510	T10	25 mm
FOR 1262515	T15	25 mm
FOR 1262520	T20	25 mm
FOR 1262525	T25	25 mm
FOR 1262527	T27	25 mm
FOR 1262530	T30	25 mm
FOR 1262540	T40	25 mm
FOR 1263008	T8	30 mm
FOR 1263009	T9	30 mm
FOR 1263010	T10	30 mm
FOR 1263015	T15	30 mm
FOR 1263020	T20	30 mm
FOR 1263025	T25	30 mm
FOR 1263027	T27	30 mm
FOR 1263030	T30	30 mm
FOR 1263040	T40	30 mm
FOR 1263045	T45	30 mm
FOR 1263050	T50	30 mm
FOR 1263055	T55	30 mm



1/4" Resistorx bit



Art.nr	mm	L mm
FOR 1272508	T8	25 mm
FOR 1272509	T9	25 mm
FOR 1272510	T10	25 mm
FOR 1272515	T15	25 mm
FOR 1272520	T20	25 mm
FOR 1272525	T25	25 mm
FOR 1272527	T27	25 mm
FOR 1272530	T30	25 mm
FOR 1272535	T35	25 mm
FOR 1272540	T40	25 mm



Magneet dop 1/4"
Porte-embouts magnétique 1/4"



Art.nr	L mm	
FOR 81225	25 mm	1/4"

Bithouder 1/4"
Porte embout 1/4"



Art.nr	L mm	
FOR 81022M	25 mm	1/4" x 1/4"
FOR 81022	25 mm	1/4" x 1/4"

Bit adapter 1/4"
Porte embout 1/4"



Art.nr	L mm	
FOR 8092230	30 mm	1/4" x 1/4"
FOR 8092250	50 mm	1/4" x 1/4"
FOR 8095330	30 mm	5/16" x 3/8"

Bithouder magneet 1/4"
Porte embout 1/4"



Art.nr	L mm	
FOR 81260	60 mm	1/4" x 1/4"
FOR 81280Q	75 mm	1/4" x 1/4"

Bithouder 1/4"
Porte embout 1/4"



Art.nr	L mm	
FOR 81260Q	60 mm	1/4" x 1/4"

Magneet op dop
Porte embout 1/4"



Art.nr	L mm	
FOR 812M08	65mm	8mm
FOR 812M10	65mm	10mm
FOR 812M13	65mm	13mm

Bit dop schroevendraaier 1/4"
Manche tournevis 1/4"



Art.nr	L mm
FOR 8145	150 mm

Bit dop schroevendraaier 1/4"
Manche tournevis 1/4"



Art.nr	L mm
FOR 8143	150 mm

Dopschroevendraaier flexibel 1/4"
Manche tournevis 1/4"



Art.nr	L mm
FOR 8113	275 mm

Bitsets 10 mm - jeu d'embouts

FOR 4155

10 mm inbus bit set 15 delig
Jeu d'embouts 10 mm 15 pcs



17430 04...12	4-5-6-7-8-10-12 mm (30 mm L)
17475 04...12	4-5-6-7-8-10-12 mm (75 mm L)
81047	bit houder 1/2" x 10 mm



FOR 4156

10 mm torx bit set 15 delig
10 mm 15 embouts torx



17630 20..55	T20-T25T-30T-T40-T45-T50-T55 (30 mm L)
17675 20..55	T20-T25T-30T-T40-T45-T50-T55 (75 mm L)
81047	bit houder 1/2"x10 mm, porte embout



FOR 4283

10 mm bit set 28 delig
10 mm jeu de 28 embouts

17430 04..12	Inbus bit 4-5-6-7-8-10-12 mm (30 mm L)
17475 05..10	5-6-8-10 mm (75 mm L)
17830 05..10	Spline M5-M6-M8-M10 (30 mm L)
17875 06..12	M6-M8-M10-M12 (75 mm L)
17630 20..55	torx T20-T25-T30-T40-T45-T50-T55 (30 mm L)
81037	bit houder 3/8"x10 mm
81047	bithouder 1/2"x10 mm



FOR 4112

10 mm bit set XZN 11 delig
10 mm 11 embouts XZN

17830 05...12	M5-M6-M8-M10-M12 (30 mm L)
17875 05...12	M5-M6-M8-M10-M12 (75 mm L)
81047	bit houder 1/2"x10 mm, porte embout



FOR 4401/FOR 4401T

Bitset 10mm 40 delig - metalen koffer
Jeu de 40 embouts - coffre métal

17430 04 ... 12	Inbus 4-5-6-7-8-10-12 mm (30 mm L)
17475 04 ... 12	4-5-6-7-8-10-12 mm (75 mm L)
17630 20 ... 55	Torx T20-T25T-30T-40-T45-T50-T55 (30 mm L)
17675 20 ... 55	T20-T25-T30-T40-T45-T50-T55 (75 mm L)
17830 05.....12	XZN M5-M6-M8-M10-M12 (30 mm L)
17875 05.....12	XZN M5-M6-M8-M10-M12 (75 mm L)
810 37..47	bit houder 3/8"x10 mm - 1/2"x10 mm
	4401T idem maar resistorx



FOR 4401C

Bitset 40 delig - plastic koffer
Jeu de 40 embouts - coffre plastic

17430 04 tot 12	Inbus 4-5-6-7-8-10-12 mm (30 mm L)
17475 04 tot 12	4-5-6-7-8-10-12 mm (75 mm L)
17630 20 tot 55	Torx T20-T25T-30T-40-T45-T50-T55 mm (30 mm L)
17675 20 tot 55	T20-T25-T30-T40-T45-T50-T55 (75 mm L)
17830 05..12	XZN M5-M6-M8-M10-M12 (30 mm L)
17875 05..12	XZN M5-M6-M8-M10-M12 (75 mm L)
810 37..47	bit houder 3/8"x10 mm - 1/2"x10 mm



FOR T4583

TC module 58 dlg bit-torx set
Module 58 pcs embouts - douilles torx

17430 04 tot 12	Inbus 4-5-6-7-8-10-12 mm (30 mm L)
17475 04 tot 12	Inbus 4-5-6-7-8-10-12 mm (75 mm L)
17630 20 tot 55	Torx T20-T25T-30T-40-T45-T50-T55 mm (30 mm L)
17675 20 tot 55	Torx T20-T25-T30-T40-T45-T50-T55 (75 mm L)
17830 05..12	XZN M5-M6-M8-M10-M12 (30 mm L)
17875 05..12	XZN M5-M6-M8-M10-M12 (75 mm L)
810 37-81047	bit houder 3/8"x10 mm - 1/2"x10 mm
torx doppen	E8-E10-E11-E12-E14-E16-E18-E20-E22-E24



Bitsen - Embouts 10 mm

Art.nr	mm	L mm
FOR 1743004	4	30
FOR 1743005	5	30
FOR 1743006	6	30
FOR 1743007	7	30
FOR 1743008	8	30
FOR 1743010	10	30
FOR 1743012	12	30
FOR 1743014	14	30
FOR 1747504	4	75
FOR 1747505	5	75
FOR 1747506	6	75
FOR 1747507	7	75
FOR 1747508	8	75
FOR 1747510	10	75
FOR 1747512	12	75

Inbus



Art.nr	mm	L mm
FOR 1763020	T20	30
FOR 1763025	T25	30
FOR 1763027	T27	30
FOR 1763030	T30	30
FOR 1763040	T40	30
FOR 1763045	T45	30
FOR 1763050	T50	30
FOR 1763055	T55	30
FOR 1763060	T60	30
FOR 1767520	T20	75
FOR 1767525	T25	75
FOR 1767527	T27	75
FOR 1767530	T30	75
FOR 1767540	T40	75
FOR 1767545	T45	75
FOR 1767550	T50	75
FOR 1767555	T55	75
FOR 1767560	T60	75
FOR 17611555	T55	115
FOR 17612040	T40	120
FOR 17612050	T50	120
FOR 17612055	T55	120

Torx



Art.nr	mm	L mm
FOR 1967560	T60	75
FOR 1967570	T70	75

Torx bits 14 mm
Embouts 14 mm



Art.nr	mm	L mm
FOR 1773010	T10H	30
FOR 1773015	T15H	30
FOR 1773020	T20H	30
FOR 1773025	T25H	30
FOR 1773027	T27H	30
FOR 1773030	T30H	30
FOR 1773040	T40H	30
FOR 1773045	T45H	30
FOR 1773050	T50H	30
FOR 1773055	T55H	30
FOR 1773060	T60H	30
FOR 1777510	T10H	75
FOR 1777515	T15H	75
FOR 1777520	T20H	75
FOR 1777525	T25H	75
FOR 1777530	T30H	75
FOR 1777540	T40H	75
FOR 1777545	T45H	75
FOR 1777550	T50H	75
FOR 1777555	T55H	75
FOR 1777560	T60H	75

Resistorx



Art.nr	mm	L mm
FOR 1783005	M5	30
FOR 1783006	M6	30
FOR 1783008	M8	30
FOR 1783010	M10	30
FOR 1783012	M12	30
FOR 1783014	M14	30
FOR 1787505	M5	75
FOR 1787506	M6	75
FOR 1787508	M8	75
FOR 1787510	M10	75
FOR 1787512	M12	75

XZN Spline 12K



Art.nr	mm	L mm
FOR 81037	3/8" x 10 mm	
FOR 81042	1/2" x 1/4"	38
FOR 81045	1/2" x 5/16	38
FOR 81047	1/2" x 10 mm	38
FOR 810414	1/2" x 14 mm	38









Bit houder
Porte-embouts

TANGEN

PINCES





	Tangen - pincés	224
	Tangen 1000v - pincés 1000v	225
	Borgveertangen - pincés circlips	226
	Griptangen - pince grip	227
	Waterpomptangen - pince multiprise	227
	Lange bektangen - pince à becs longues	228
	Riveteertang - pince à riveter	228
	Tangensets- en modules - jeu de pincés	229

Lange bektang Pince à becs long

Art.nr	L mm	
FOR 610B160	160 mm	
FOR 610B200	200 mm	220gr



Lange gebogen bektang Pince à becs long coudé

Art.nr	L mm	
FOR 610B200B	200 mm	220gr



Kombinatietang Pince universelle

Art.nr	L mm	
FOR 611B160	160 mm	
FOR 611B175	175 mm	280gr



Zijkniptang Pince coupante

Art.nr	L mm	
FOR 612B160	160 mm	
FOR 612B175	175 mm	260gr



Kopkniptang Pince coupante de devant

Art.nr	L mm	
FOR 6976200	200 mm	



Striptang Pince à sertir

Art.nr	L mm	
FOR 6804B160	160 mm	



Tangen 1000 V - Pincés 1000v

Lange platte bektang
Pince à becs long



Art. nr.		mm
FOR 6904160	1000v	160
FOR 6904200	1000v	200
FOR 6913160	1000v	160

Kniptang
Pince coupante



Art. nr.		mm
FOR 6905160	1000v	160 mm
FOR 6911200	1000V	200 mm

Universele tang
Pince universelle

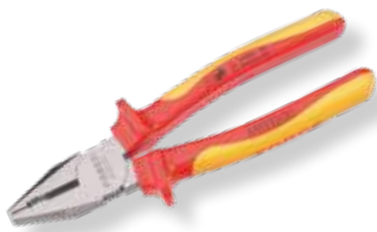

Art. nr.		mm
FOR 6903180	1000v	180 mm

Striptang
Pince à dénuder



Art. nr.		mm
FOR 6912160	1000v	160 mm

Buigtang ronde bekken
Pince à becs ronds



Art. nr.		mm
FOR 6908160	1000v	160 mm

Waterpomptang
Pince multiprise



Art. nr.		mm
FOR 6907250	1000v	250 mm

Borgveertangen - Pinces circlips

Inwendige borgveertang met rechte bekken
Pince circlips intérieure



Art. nr.	mm	min-max	
FOR 60905ASO	1.3	8.25mm	80gr
FOR 609ASO	1.8	19-60 mm	150gr
FOR 60909ASO	1.8	40-100 mm	300gr

Inwendige borgveertang met rechte bekken
Pince circlips intérieure



Art. nr.	mm	min-max	
FOR 60905ASC	1.3	8.25mm	80gr
FOR 609ASC	1.8	19.60 mm	150gr
FOR 60909ASC	1.8	40.100 mm	300gr

Uitwendige borgveertang met 90° bek
Pince circlips extérieur coudé à 90°



Art. nr.	mm	min-max	
FOR 60905ABO	1.3	8-36mm	80gr
FOR 609ABO	1.8	19.60 mm	150gr
FOR 60909ABO	1.8	40-100 mm	300gr

Uitwendige borgveertang met 90° bek
Pince circlips extérieur coudé a 90°



Art. nr.	mm	min-max	
FOR 60905ABC	1.3	8.25mm	80gr
FOR 609ABC	1.8	19.60 mm	150gr
FOR 60909ABC	1.8	40-100 mm	300gr

FOR T5043A

TC module 4 borgveertangen
TC module 4 pinces circlips

609ASO	buitenborgveertang met rechte bekken
609ASC	binnenborgveertang met rechte bekken
609ABO	buitenborgveertang met gebogen bekken
609ABC	binnenborgveertang met gebogen bekken



FOR 50653

Borgveertangenset in hoes 6 delig
Set de pinces circlips 6 pcs en trousse

609ASO	buitenborgveertang met rechte bekken
609ASC	binnenborgveertang met rechte bekken
609ABO	buitenborgveertang met gebogen bekken
609ABC	binnenborgveertang met gebogen bekken
60909ASC	binnenborgveertang met rechte bekken 150mm
60909ASO	buitenborgveertang met rechte bekken 150mm



Tangen - Pincas

Grip tang ronde bek
Pince grip



Art. nr.		mm	
FOR 614125		125 mm	190gr
FOR 614175		175 mm	370gr
FOR 614250		250 mm	550gr

Grip tang lange bekken
Pince grip



Art. nr.		mm	
FOR 615150		150 mm	220gr

C grip tang
Pince-étaux longue portée



Onmisbaar bij laswerkzaamheden aan wielkasten en vloerplaten

Art. nr.		mm	
FOR 66011			750gr

Waterpomptang
Pince multiprise



Art. nr.		mm	
FOR 613B250		250 mm	410gr

Waterpomptang
Pince multiprise



Art. nr.		mm	
FOR 613A500		500 mm	1700gr

Waterpomptang
Pince multiprise



Art. nr.		mm	
FOR 613410		410 mm	1300gr

Lange rechte bektang
Pince à becs longues



Art. nr.	mm		
FOR 5047P1	280		330gr

Lange gebogen bektang
Pince à becs longues coudé



Art. nr.	mm		
FOR 5047P2	280	45°	330gr



Art. nr.	mm		
FOR 5047P4	280	4 punts	330gr



Art. nr.	mm		
FOR 5047P3	280	90°	330gr

Zijkniptang voor kunststof
Pince coupante



Art. nr.		mm	
FOR 6925160		160	140gr

4 in 1 electriciens tang
Pince electriciens



Art. nr.		mm	
FOR 6921160		160	160gr

Combinatietang met vergrendeling
Pince universelle



Art. nr.		mm	
FOR 673B215		215	275gr

Kabel kniptang
Pince coupe câble universel



Art. nr.		mm	
FOR 6923160		160	180gr
FOR 6924250		250	530gr

Draadborgtang
Pince pour fil à freiner



Art. nr.		mm	
FOR 6958160		160	220gr

Nijptang
Tenaille russe



Art. nr.		mm	
FOR 6971230		230	
FOR 6971250		250	480gr

Riveteertang
Pince à riveter



Art. nr.		mm L	
FOR 67801		180	785gr

Riveteertang
Pince à riveter à levier



Art. nr.	mmL		
FOR 678535	180	van 3.0 tot 6.4mm	

FOR T5046

TC module 4 tangen
TC module 4 pinces

610B200	lange bektang, pince à becs long 200 mm
610B200B	gebogen bektang, pince à becs long coudé 200 mm
611B175	universele tang, pince universelle 175 mm
612B175	kniptang, pince coupante 175 mm



FOR T50814

TC module 8 mini tangen
TC module 8 pinces mini

50814P1	buigtang ronde bek, becs ronds 125 mm
50814P2	telefoontang, pince à becs longues 125 mm
50814P3	universele tang, pince universelle 125 mm
50814P4	platte bektang, becs plat 125 mm
50814P5	halfronde bektang 150 mm
50814P6	lange gebogen bektang 150 mm
50814P7	kopkniptang, pince coupante 150 mm
50814P8	zijkniptang, pince coupante 150 mm

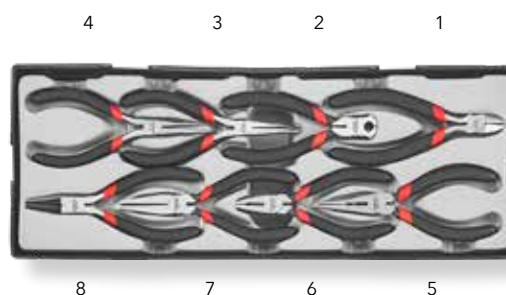

FOR T5047

TC module 4 lange tangen
TC module 4 pinces à becs longs

5047P1	extra lange platte bektang 280 mm
5047P2	extra lange platte bektang 45° 280 mm
5047P3	extra lange bektang 90° 280 mm
5047P4	extra lange 4 punts tang 280 mm



FOR T50410

TC module 4 tangen 1000v
TC module 4 pinces 1000v

6903180	universele tang, pince universelles 180 mm
6904160	lange bektang, pince à becs long 160 mm
6911200	zijkniptang, pince coupante 200 mm
6912160	striptang, pince à dénuder 160 mm



FOR T5038

TC module met 3 tangen
TC module 3 pinces

649250B	verstelbare moersleutel, clé à molette 250 mm
613B250	waterpomptang, pince multiprise 250 mm
614250	griptang, pince grip 250 mm



FOR T51811

TC module riveteertang 181 pcs
TC module pince à riveter 181 pcs

67801	riveteertang, pince à riveter
51811-1	alu rivetten 4x8
51811-2	alu rivetten 4x10
51811-3	alu rivetten 4.8x8
51811-4	alu rivetten 4.8x10
51811-5	stalen rivetten 4x7
51811-6	stalen rivetten 4x10



FOR T5057

TC module 5 tangen multi grip
TC module 5 pinces etau pour carrossier

67901	platte bektang, màchoir large et plat
67902	dubbele griptang, double courbe
67903	màchoir large et courbe
67904	rechthoekige bek, màchoir à becs
67905	rechte bektang, màchoir droite



FOR 912U1

Circlipstangenset XL 400mm
Coffret 2 pinces circlips XL



FOR 903U1

Circlipstangenset XL
Pinces circlips XL



FOR 920U2

Circlipstangenset 20 delig
Set de pinces circlips 20pcs





HAMERS

MARTEAUX



	Pendrijvers - chase goupilles	234
	Beitel-doorslagen sets - jeu de burins & chase-goupilles	235
	Beitels - burins	235
	Doorslagen - burins pointeau	237
	Hamers - marteaux	238

FOR 5054

Beitel pendrijvers set 5 delig Jeu de burins 5pcs

60212150	beitel 12 (150mmL)
603150	kapbeitel (150mmL)
6044190	pendrijver 4 (190mmL)
6063185	doorslag 3 (185mmL)
6074185	centerpunt 4 (185mmL)



FOR 50613

Pendrijvers 6 delig Jeu de 6 chasse-goupilles

604 2140	2 mm (140 mm L)
604 3150	3 mm (150 mm L)
604 4190	4 mm (190 mm L)
604 5200	5 mm (200 mm L)
604 6210	6 mm (210 mm L)
604 8215	8 mm (215 mm L)



FOR 50511

Centerpuntset 5 delig Jeu de 5 pointeau's

60725185	2.5 (185mm L)
6074185	4 (185mm L)
6076185	6 (185mm L)
6078185	8 (185mm L)
60710185	10 (185mm L)



Beitels-doorslag - Burins

FOR T5131

TC module 13 beitels & doorslagen
TC module 13 burins chasse-goupilles

602 10150	beitel, burin 10 (150 mm L)
602 12150	beitel, burin 12 (150 mm L)
602 15180	beitel, burin 15 (180 mm L)
602 19200	beitel, burin 19 (200 mm L)
602 22200	beitel, burin 22 (200 mm L)
603150	kapbeitel, bedane 150 mm L
604 2140 - 6043150	doorslag, chasse-goupille 2 (140 mm L) 3 (150 mm L)
604 4190	doorslag, chasse-goupille 4 (190 mm L)
606 2185 - 6063185	beitel plat, burin plat 2 (185 mm L) 3 (185 mm L)
606 4185	beitel plat, burin plat 4 (185 mm L)
6074185	puntslag 4 (185 mm L) pointeau



FOR T51229

TC module 12 beitels & doorslagen
TC module 12 burins chasse-goupilles

602 12150	beitel, burin 12 (150 mm L)
602 15180	beitel, burin 15 (180 mm L)
602 22200	beitel, burin 22 (200 mm L)
603150	kapbeitel, bedane 150 mm L
604 2140 - 6043150	pendrijver, chasse-goupille 2 (140 mm L) 3 (150 mm L)
604 4190 - 6045200	doorslag, chasse-goupille 4 (190 mm L) 5 (200 mm L)
6046210-6048215	pendrijver 6 (210 mm L) - 8 (215 mm L)
60410230	pendrijver 10 (230 mm L)
6074185	puntslag 4 (185 mm L) pointeau

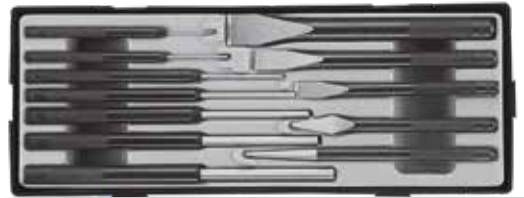

FOR T5053

TC module beitel & hamers 5 delig
TC module burins-marteaux 5 pcs

616300	hamer, marteau 300 gr
616400	rubber hamer, marteau chaoutchouc 400 gr
60215180	beitel, burin 15 (180 mm L)
60219200	beitel, burin 19 (200 mm L)
60225220	beitel, burin 25 (220 mm L)



FOR T50822

TC module beitel & hamers 8 delig
TC module burins-marteaux 8 pcs

616500	hamer, marteau 500 gr
905M2P3	schraper
618	voelermatjes
60212150	beitel, burin 12
603150	kapbeitel, burin
6044190	pendrijver, chasse-goupille 4
6063185	doorslag, pointeau 3
6074185	centerpunt, pointeau 4



FOR T50723A

TC module 7 beitels & doorslagen TC module 7 burins chasse-goupilles

6042140Q	doorslag, chasse-goupille 2 (140 mm L)
6043150Q	doorslag, chasse-goupille 3 (150mmL)
6044190Q	doorslag, chasse-goupille 4 (190 mm L)
6045200Q	doorslag, chasse-goupille 5 (200 mm L)
6046210Q	doorslag, chasse-goupille 5 (210mmL)
6048215Q	doorslag, chasse-goupille 8 (215mmL)
6074185Q	puntslag 4 (185 mm L) pointeau



FOR T50725

TC module 7 beitels TC module 7 burins

60210150Q	beitel, burin 10 (150 mm L)
60212150Q	beitel, burin 12 (150 mm L)
60215180Q	beitel, burin 15 (180 mm L)
60219200Q	beitel, burin 19 (200 mm L)
60222200Q	beitel, burin 22 (200 mm L)
60225220Q	beitel, burin 25 (220mmL)
603150Q	kapbeitel, bedane 150 mm L



FOR 5138

Beitel-penuitdrijverset bekleed 13 delig Burins-chasse goupilles 13 pcs avec protection

604 2140Q	doorslag, chasse-goupilles 2 (140 mm L)
604 3150Q	doorslag, chasse-goupilles 3 (150 mm L)
604 4190Q	doorslag, chasse-goupilles 4 (190 mm L)
604 5200Q	doorslag, chasse-goupilles 5 (200 mm L)
604 6210Q	doorslag, chasse-goupilles 6 (210 mm L)
604 8215Q	doorslag, chasse-goupilles 8 (215 mm L)
604 10230Q	doorslag, chasse-goupilles 10 (230 mm L)
604 12280Q	doorslag, chasse-goupilles 12 (280 mm L)
604 14290Q	doorslag, chasse-goupilles 14 (290 mm L)
606 4185Q	drevel, pointeau 4 (185 mm L)
606 5185Q	drevel, pointeau 5 (185 mm L)
606 6185Q	drevel, pointeau 6 (185 mm L)
6076185Q	center punt, chasse-goupilles centre 6 (185 mm L)



FOR 5139

Beitel-penuitdrijverset bekleed 13 delig Burins-chasse goupilles 13 pcs avec protection

6042140Q	doorslag, chasse-goupilles 2 (140 mm L)
6043150Q	doorslag, chasse-goupilles 3 (150 mm L)
6044190Q	doorslag, chasse-goupilles 4 (190 mm L)
6045200Q	doorslag, chasse-goupilles 5 (200 mm L)
6046210Q	doorslag, chasse-goupilles 6 (210 mm L)
6048215Q	doorslag, chasse-goupilles 8 (215 mm L)
603150Q	kapbeitel, bedane 3
60212150Q	beitel, burin 12 (150mmL)
60215180Q	beitel, burin 15 (180mmL)
60219200Q	beitel, burin 19 (200mmL)
60222200Q	beitel, burin 22 (200mmL)
6066185Q	doorslag, pointeau 6 (185mmL)
6076185Q	center punt, chasse-goupilles centre 6 (185 mm L)



Hamer-beitels - Chasse goupilles

Pendrijvers Chasse-goupilles



Art. nr.		Lmm
FOR 6042140	2 mm	140 mm
FOR 6043150	3 mm	150 mm
FOR 6044190	4 mm	190 mm
FOR 6045200	5 mm	200 mm
FOR 6046210	6 mm	210 mm
FOR 6048215	8 mm	215 mm
FOR 60410230	10 mm	230 mm
FOR 60412280	12 mm	280 mm
FOR 60414290	14 mm	290 mm
FOR 60416310	16 mm	310 mm

Pendrijvers bekleed Chasse-goupilles gainés



Art. nr.		Lmm
FOR 6042140Q	2 mm	140 mm
FOR 6043150Q	3 mm	150 mm
FOR 6044190Q	4 mm	190 mm
FOR 6045200Q	5 mm	200 mm
FOR 6046210Q	6 mm	210 mm
FOR 6048215Q	8 mm	215 mm
FOR 60410230Q	10 mm	230 mm
FOR 60412280Q	12 mm	280 mm
FOR 60414290Q	14 mm	290 mm

Beitels Burins



Art. nr.		Lmm
FOR 60210150	10	150 mm
FOR 60212150	12	150 mm
FOR 60215180	15	180 mm
FOR 60219200	19	200 mm
FOR 60222200	22	200 mm
FOR 60225220	25	220 mm

Beitels bekleed Burins gainés



Art. nr.		Lmm
FOR60212150Q	12	150 mm
FOR 60215180Q	15	180 mm
FOR 60219200Q	19	200 mm
FOR 60222200Q	22	220 mm

Doorslag Burins pointeau



Art. nr.		Lmm
FOR 6062185	2	185 mm
FOR 6063185	3	185 mm
FOR 6064185	4	185 mm
FOR 6065185	5	185 mm
FOR 6066185	6	185 mm

Doorslag bekleed Burins pointeau gainés



Art. nr.		Lmm
FOR 6064185Q	4	185 mm
FOR 6065185Q	5	185 mm
FOR 6066185Q	6	185 mm

Kapbeitel Bédane



Art. nr.		Lmm
FOR 603150		150 mm

Centerpunt Pointeau



Art. nr.	mm	L mm
FOR 60725185	2.5	185 mm
FOR 6074185	4	185 mm
FOR 6076185	6	185 mm
FOR 6076185Q	6	185 mm

Hamers - marteaux

Bankhamer met houten steel
 Marteaux de mécanicien manche en bois



Art. nr.	
FOR 616300	300 gr
FOR 616500	500 gr
FOR 6161000	1000 gr
FOR 6161500	1500 gr

Blokhamer met houten steel
 Masette manche en bois



Art. nr.		mm L
FOR 616G1250	1250 gr	260
FOR 616G1500	1500 gr	280

Rubber hamer
 Maillets anti-rebond



Art. nr.		mm L	totaal gewicht
616400	400 gr	280	520gr
616580	580 gr	300	690gr
616800	810 gr	300	940gr

Kunststof hamer met verwisselbare hamerdoppen
 Masettes à embouts interchangeables



Art. nr.		mm	
FOR 616A035	505gr	35 mm	

Kunststof hamer houten steel
 Marteaux



Art. nr.			
FOR 616A400			400gr

Bankhamer
 Marteaux de mécanicien



Art. nr.			
FOR 616F032	32mm		600gr



FORCE® 6161500

SNIJGEREEDSCHAP

COUPER MESURER



	Tappensets - jeu de tarauds	242
	Boren - mêches	243
	Meetgereedschap - mesurer	244
	Snijgereedschap - couper	246
	Vijlen - limes	247
	Knippen - pince coupe	248
	Pijptangen - clés serre tube	249

Tap- en kussenset - Tarrauds & filières

ZA T110 1

Tap- en kussenset metric 110 delig
Jeu de tarauds et de filières 110 pcs

M2x0.4	M10x0.75	M14x1.0
M3x0.5	M10x1.0	M14x1.25
M4x0.7	M10x1.25	M14x1.5
M5x0.8	M10x1.5	M14x2.0
M6X0.75	M11x0.75	M16x1.0
M6x1.0	M11x1.0	M16x1.5
M7X0.75	M11x1.25	M16x2.0
M7x1.0	M11x1.5	M18x1.5
M8x1.0	M12x0.75	2 kussen wringijzer, porte filièr
M8x1.25	M12x1.0	2 tappen wringijzer
M9x0.75	M12x1.25	1 T tapkrukratel
M9x1.0	M12x1.5	
M9x1.25	M12x1.75	



Wringijzer voor tappen verstelbaar Tourne à gauche pour tarauds



Art. nr.		lengte
FOR 881A13	M5-M13	275mmL
FOR 881A19	M6-M19	380mmL
ZA ET110W1 2	M8-M25	480mmL

Wringijzer voor snijkussens Porte-filières



Art. nr.		lengte
ZA ET110W25	25x9	
ZA ET110W38	38x14	



Taphouder met ratelfunctie Tourne à gauche

Art. nr.		lengte
FOR 8812090	3-6mm	90mmL

FOR 63005

Linkse tappenset 5 dlg
Extracteurs de vis en jeux 5pcs

1/8" (M3) tot 1/4" (M6)
1/4" (M6) tot 5/16" (M8)
5/16" (M8) tot 7/16" (M11)
7/16" (M11) tot 9/16" (M14)
9/16" (M14) tot 3/4" (M18)



FOR 920U3

Extractor set 20 dlg
Jeu de extracteurs 20 pcs

Voor het uitdraaien van schroeven, moeren en bouten, als de inzetschroefdraad of de zeskant beschadigd is. Door de bijzondere constructie van de doppen (conisch en speciaal links profiel) kunnen schroeven, moeren en bouten probleemloos los- en uitgedraaid worden. De linkse tap (ook "boutuitdraaier" genoemd) heeft linkse draad, waardoor deze de bout aangrijpt en gelijk losdraait, probleem opgelost.

Linkse tap 1/8" - 1/4" (M3 - M6) (artikel 9UXBM06)
 Linkse tap 1/4" - 5/16" (M6 - M8) (artikel 9UXBM08)
 Linkse tap 5/16" - 7/16" (M8 - M11) (artikel 9UXBM11)
 Linkse tap 7/16" - 9/16" (M11 - M14) (artikel 9UXBM14)
 Linkse tap 9/16" - 3/4" (M14 - M18) (artikel 9UXBM18)
 Linkse profiel doppen 8 - 10 - 11 - 12 - 13 - 14 - 15 - 16 - 17 - 19mm
 L-sleutel 6mm
 3/8" Adapter voor verlengstuk 3/8"(F) x 3/8"(M)
 3/8" Verlengstuk 150mmL
 3/8" Wobble verlengstuk 44mmL
 3/8" Quick-grip sleutel



FOR T5331

TC module repair tool set 33 delig
Tc module demontage/réparation extraction

8174	slagschroevendraaier, tournevis à frapper
15136 2...3	philips bit PH2-PH3 (36 mm L)
15236 2...3	pozidriv bit PZ2-PZ3 (36 mm L)
15336 09...11	platte bit 9-11 mm (36 mm L)
15436 06...10	inbus bit 6-8-10 mm (36 mm L)
15635 25...50	torx bit T25-T30-T40-T45-T50 (35 mm L)
15180 2...3	philips bit PH2-PH3 (80 mm L)
15380 09...11	platte bit 9-11 mm (80 mm L)
8095330	adapter 3/8" * 5/16" inbus
81045A	bit houder 1/2" x 5/16"
818 06....12	tapuiteindehalers 6-8-10-12 mm
6720912	moersplijter 9-12 mm
6721216	moersplijter 12-16 mm
6721622	moersplijter 16-22 mm
63005	linkse tappenset - extracteurs de vis



FOR 672

Moersplijterset 4 delig
Casse écrous en set

- pour fendre et extraire les écrous grippés ou roulés

Art. nr	
FOR 6720912	9-12 mm
FOR 6721216	12-16 mm
FOR 6721622	16-22 mm
FOR 6722227	22-27 mm

FOR 9U1101

Schroefdraadvijl
Lime de filon filetage

Voor het nabewerken van beschadigde buiten- en binnenschroefdraad (M5 tot M27.) Geschikt voor zowel linkse als rechtse draad. Speciaal ontworpen voor gebruik op moeilijk bereikbare plaatsen
Pour restauration ou nettoyage de filetages extérieurs et intérieurs (M5 - M27.) Exécution: pour filetages métriques.



FOR 66901

Schroefdraadvijl
Lime de filon filetage

Voor het nabewerken van beschadigde buitenschroefdraad, geschikt voor zowel linkse als rechtse draad.
Pour restauration ou nettoyage de filetages extérieurs. Exécution: pour filetages métriques.



ZA HSS170

Borensset 170 delig
Jeu de mèches 170 pcs

ZA STI

V coil schroefdraad reparatieset
Jeu de réparations de filets C-coil
- M5-M12

Snij-meetgereedschap - Couper-mesurer

FOR T5096

TC module meet en aftekengereedschap 9 delig

TC module 9 outils de mesure et traçage

FOR 5096P1	universle schuifmaat, pied à coulisse
FOR 5096P2	center punt, pointeau
FOR 5096P3	liniaal 30 cm, règle métal 30cm
FOR 5096P4	hoek meter, rapporteur inox
FOR 5096P5	voelermaatjes 0.25-6, jauge d'épaisseur
FOR 5096P6	voelermaatjes 4-62 SAE, jauge d'épaisseur
FOR 61802	voelermaatjes SAE-metric, jauge d'épaisseur
FOR 5096P7	stalen kraspen, pointe à tracer
FOR 5096P8	meter 5m, mètre à ruban



FOR 5096P1

Universele schuifmaat metaal
Pied à coulisse



FOR 5096P2

Center punt
Pointeau



FOR 5096P3

Liniaal 30cm
Règle métal 30cm



FOR 5096P4

Metalen hoekmeter
Rapporteur inox



FOR 5096P7

Stalen kraspen
Pointe à tracer



FOR 5096P5

Voelermatjes 0.25-6 mm
Jauge d'épaisseur

FOR 5096P6

Voelermatjes 4-62 SAE
Jauge d'épaisseur

**FOR 618**

Voelermatjes 0.05mm tot 1.00mm
Jauge d'épaisseur

FOR 61802

Voelermatjes 0.04mm tot 0.63mm
Jauge d'épaisseur

**FOR 5096P803**

Rolmeter 3 meter in ABS huis

- met blokkering

Mètre à ruban 3m

- avec bloçage

**FOR 5096P8**

Rolmeter 5 meter in ABS huis

- met blokkering

Mètre à ruban 5m

- avec bloçage

**FOR 5096A805**

Rolmeter 5 meter in ABS huis

- met blokkering

Mètre à ruban 5m boîtier ABS

- antichoc bi-matières ruban en acier



FOR T5055**TC module 5 delig snijgereedschap****TC module 5 d'outils à couper**

FOR 5055P1	schaar, ciseau
FOR 66302	mini hakzaag, scie mini
FOR 5055P3	2 zaagbladen, lame de reserve
FOR 5055P4	cuttermes, couteau

**FOR 5055P4****Universeel veiligheidsmes**
Cutter à lames**FOR 5055P4P****Reserve mesjes (5 stuks)**
Lames (5 pcs)**FOR 68021****Vouwmes met kunststof heft**
Couteau à cran d'arrêt manche bi-matière**FOR 66302****Mini zaagbeugel**
Scie mini

Gemaakt van lichtgewicht, sterk aluminium met zacht kunststof handgreep. Het zaagblad is verstelbaar onder 6 hoeken. Eenvoudige zaagblad wisseling. Op deze ijzerzaag passen standaard zaagbladen. Geschikt voor metaal, hout en plastic. Zaagbladlengte 150 mm.

FOR 5055P3**Reservezaagje**
Lame**FOR 66301****Zaagbeugel metaalzaag**
Monture de scie à métaux

Geschikt voor metaal, hout en plastic, met ergonomische handgreep en snelwissel-systeem.



FOR 66303

Zaagbeugel metaalzaag 135mm
Mini scie à métaux 135mm

Kleine, compacte metaalzaag voor werkzaamheden op moeilijk bereikbare plaatsen (bv. glad afzagen van pijpen, schroeven, enz.)
Aluminium frame met 2-componenten-handgreep.



FOR 5055P1

Metaalschaar 51mm
Ciseaux pour metal

"Heavy-Duty" metaalschaar met gehard stalen bladen en een kniplengte van 51 mm.
Geschikt voor het knippen van dun ferro en non-ferro plaatstaal.
Dubbel gedompelde zachte grip.
Lengte schaar 254 mm.



FOR 6982

Beklede electricien schaar
Ciseaux universel d'atelier

Elektricien schaar met zacht TPR rubberen handgrepen en een smalle inkeping in het blad voor draadstrippen.
Precies geslepen om zuiver en zonder te slijpen te snijden.



FOR 6981250

Blikschaar rechte snede
Cisaille d'aviation coupe universelle

Blikschaar met rechte snede, geschikt voor metaal, aluminium, koper, kunststof, leer etc.
Voor het knippen van rechte sneden.
Kniplengte 38 mm.



FOR T5056

TC module 5 vijlen
TC module 5 limes

FOR 5056P1	platte vijl, lime plat
FOR 5056P2	half ronde vijl, lime demi ronde
FOR 5056P3	ronde vijl, lime ronde
FOR 5056P4	vierkante vijl, lime carré
FOR 5056P5	driehoek vijl, lime triangulaire



Boutenschaar Coupe boulon bras forgé

Art. nr.		mm	
FOR 9U050118	18"	455 mm L	1613gr
FOR 9U050124	24"	610 mm L	2375gr
FOR 9U050130	30"	762 mm L	4000gr
FOR 9U050136	36"	863 mm L	6080gr
FOR 9U050142	42"	1060 mm L	9033gr



FOR 6923160

Kabel kniptang 160mmL Pince coupe-câbles

Robuuste kabelschaar voor dagelijks gebruik door de professionele gebruiker. De schaar knipt kabels eenvoudig en zuiver door zonder de kabel te vervormen. Geschikt voor o.a. kabelstrengen van gevlochten 2/O koperdraad en gevlochten 4/O aluminium draad.

Niet geschikt voor gewapende kabelbundels (ACSR) en niet voor staal.

Pour couper les câbles en cuivre et en aluminium unifilaire et multifilaire. Coupe nette facile à une main, sans écrasement du câble.



FOR 6924250

Kabel kniptang 250mmL Pince coupe-câbles

FOR 65607

Kunststof leidingschaar 42 mm Coupe-tube PVC à cliquet pour tubes plastiques



FOR 65601

Telescopische pijpsnijder 3-29 mm Coupe-tubes 3-29 mm



FOR 65602

Mini telescopische pijpsnijder 3-22 mm Coupe-tubes mini 3-22 mm



Pijptangen - Clés serre-tube

Pijptangen model Stillson Clés serre-tubes modèle Stillson

Art. nr.	cap	L mm	gewicht/poids
FOR 68414	0 - 60mm	355mm	1340gr
FOR 64818	0 - 76mm	455MM	2090GR
FOR 68424	0 - 89mm	610mm	3670gr
FOR 68436	0 - 140mm	863mm	8340gr
FOR 68448	0 - 165mm	1220 mm	12000gr



Bijzonder robuuste pijptang van gietijzer model "Stillson" met geharde vertanding.
Klemt goed vast door nauwkeurige afwerking van schroefdraad en rol, ligt goed in de hand

Cette clé serre-tubes modèle "Stillson" possède un corps en fonte et une mâchoire mobile en acier forgé.

FOR 684C17

Pijpsleutel 440mmL 1 1/2" Clé serre-tubes 440mmL 1 1/2"

Verstelbare pijptang gemaakt van Chroom Vanadium staal, gesmeed en gehard en bevat inductie geharde tanden.
De S-bek zorgt voor klemming op drie punten en een betere krachtoverbrenging.
Uitgerust met klembeveiliging.

*Force clé serre-tube suédoises forme S en acier Chrome Vanadium forgée en renforcée avec denture trempée par induction.
Mâchoires parallèles étroites et biseautées pour l'accroche idéale des différents tubes et pièces.
Denture orientée dans le sens inverse de la rotation.
Serrage sur trois points sur le tube, autobloquante.
Bague de fixation imperdable.
Laquage électrostatique rouge, mâchoires polies.*



FOR 684C22

Pijpsleutel 560mmL 2" cap. 0-120mm Clé serre-tubes 560mmL 2"

FOR 6957240

Pijptang met griphandvat 240mmL Pince grip 240mmL















GARAGE EQUIPMENT

GARAGE EQUIPMENT





	Werkplaatsinrichting - garage equipment	252
	Vervangen filters - huile	258
	Ontsteking brandstof - allumage carburant	266
	Blokkeergereedschap - outils de calage	269
	Motor - moteur	279
	Remmen - freins	285
	Wielen - roues	291
	Aandrijving - suspension & transmission	295
	Trekkers - extracteurs	297
	Carrosserie	303
	Koevoeten - leviers	306
	Allerlei - magneten - aimant	307

Garage equipment

Hoe werkt een assteun:

Eerst lift u uw auto omhoog door middel van een autokrik. Eenmaal op juiste hoogte plaatst u de assteun onder de auto, hierdoor rust de auto nu op de assteun in plaats van de krik. De volgende stap is om de assteun, door middel van het blokkeersysteem, extra te beveiligen. De autokrik rolt u vervolgens onder de auto vandaan en klaar! Het is nu tijd om uw schoonmaak- of reparatiewerkzaamheden uit te voeren.

Let op: U gebruikt uw assteunen niet om uw voertuig te liften, dit doet u met een autokrik. De assteunen dienen puur ter ondersteuning, dit zorgt voor meer veiligheid en zekerheid.

TRI T42001C

Verstelbare assteunen 2 ton (per paar) met veiligheidspin Set de 2 chandelles 2 ton

	hoogte/haut	gewicht/poids
Min	268 mm	
Max	418 mm	4.80 kg



TRI T43001C

Verstelbare assteunen 3 ton (per paar) met veiligheidspin Set de chandelles 3 ton

	hoogte/haut	gewicht/poids
Min	276 mm	
Max	422 mm	6.4 kg



TRI T46001C

Verstelbare assteunen 6 ton met veiligheidspin (per paar) Set de chandelles 6 ton

	hoogte/haut	gewicht/poids
Min	388 mm	
Max	580 mm	13.5 kg



TRI TH91004

Fleskrik 10 ton Cric bouteille 10 ton

TRI TH92004

Fleskrik 20 ton Cric bouteille 20 ton

TRI TH95004

Fleskrik 50 ton Cric bouteille 50 ton

	Min hoogte/haut.	Lift hoogte/haut
TRI TH91004	222 mm	145 mm
TRI TH92004	235 mm	150 mm
TRI TH95004	280 mm	280 mm



TRI 60205

Garagekrik 2 ton met garage stand & wielblokkeerset
Cric rouleurs 2 ton avec chandelles & arrêts

	hoogte/haut	gewicht/poids
Min	140 mm	
Max	340 mm	8.7 kg



TRI T820050

Garagekrik 2 ton
Cric rouleurs 2 ton

	hoogte/haut	gewicht/poids
Min	135 mm	
Max	340 mm	8.7kg



TRI T82007

Garagekrik 2 ton
Cric rouleurs 2 ton

	hoogte/haut	gewicht/poids
Min	130 mm	
Max	350 mm	11 kg



TRI TL1525C

Garagekrik 2.5 ton laag profiel met quick lift dubbele pomp, nylon wielen
Cric rouleurs 3 ton extra bas pompe double

	hoogte/haut	gewicht/poids
Min	75 mm	
Max	510 mm	28.8 kg



TRI TL1525P

Garagekrik 2.5 ton "laag profiel" quick lift met dubbele pomp en pedaal, nylon wielen
Cric rouleurs 2.5 ton extra bas pompe double avec pédale

	hoogte/haut	gewicht/poids
Min	75 mm	
Max	510 mm	30.5 kg



TRI T24541

Motorsteun 500 kg
Support moteur sur roues pivotant 500 kg

	Cap.	gewicht/poids
	500kg	21 kg



TRI T32002X

Werkplaatskraan 2 ton plooibaar
Grue d'atelier pliable 2 ton pliable

	hoogte	gewicht/poids
Lifting	100-2200 mm	70 kg
takelbereik	25-2040mm	



TRI TRF2750

Motorhanger 680 kg voor het uitbalanceren van lasten op takels en kranen
Palonnier pour moteur basculante 680 kg

		gewicht/poids
		5.2 kg



TRI TW05001

Motorhouder 500 kg
Support moteur 500 kg

		gewicht/poids
Lengte	1500 mm	16 kg
Afm	1540x150x110 mm	



TRI TRF0322

Autoverplaatser (per paar)
Positionneur de véhicule (par paire)

		gewicht/poids
Cap	450kg	18kg



TRI TR6505

Ligbed opplooibaar
Couchette d'atelier

		gewicht/poids
920x430x140 mm		8.5 kg



TRI TRH6802-3

Ligbed magnetic tray met hoofdkussen
Couchette d'atelier en plastique

		gewicht/poids
1010x475x130 mm		5.4kg



TRI TR6100

Montagekruk
Tabouret de montage

		gewicht/poids
364x365x365mm		4.20kg



WIN 702016

Winch met stalen kabel 900kg 10m
Trueil manuel 900kg 10m



WIN KEW2000

Electrische winch 950 kg
 • Motor 0.7kw/0.9hp (12v)
 • kabel : 4 mm x 15m
Trueil électrique 950kg



TRI TRTH20A

Mini compressor 12v
 • 12volt
 • 10 bar
 • 35L/min
Compresseur mini 12 volt



TRI TR8485

Keldervijzel 48"
Cric mécanique 48"

	hoogte	gewicht/poids
Min	154 mm	
Max	1070 mm	14 kg

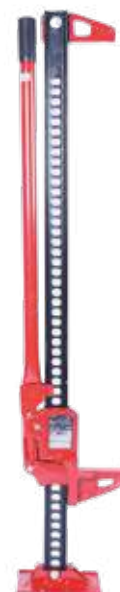

Opritten - rampes

TRI TRT7502

Oprijplaat alu plooibaar 340 kg (per paar)
Rampes en alu pliable 340kg (par paire)

- opgeplooid : 1160 mm

Afm.	2260mm x 2950 mm
gewicht/poids	7kg
Draagkracht	340 kg per stuk



TRI TRF4501

Aluminium oprijplaat 200kg
Rampe en alu 200kg

Afm.	1795x293x60mm
gewicht/poids	7kg
Draagkracht	200kg



TRI TRT5001

Rubberen wielblok
Calle de roue en caoutchouc

Afm.	220x195x155mm
gewicht/poids	2.2 kg



TRI TD2001G

Set van 2 minibruggen 2 ton
Set de 2 rampes 2 ton

Afm.	865x320x910mm
gewicht/poids	5.6 kg
Max band breedte	210 mm

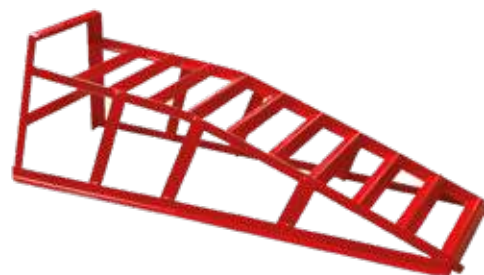

TRI TRD2005

Mini brug plastic per paar
Rampe, plastic par paire

Afm.	900x295x220 mm
gewicht/poids	4 kg
Draagkracht	2.5 ton per paar
Max band breedte	240 mm



Vervangen filters - Huile

FOR 61904

Regelbare oliefiltersleutel

- Demontage van filters 65 mm - 110 mm

Clé auto-serrante à 3 bras pour filtre à huile

Aandrijving met zowel 3/8" als 1/2" ratel of steeksleutel (21 mm) mogelijk.



FOR 61913

Regelbare oliefiltersleutel

- Demontage van filters 75 mm - 130 mm

Clé filtre à huile auto-régable



FOR 9B0704

Oliefiltersleutel 1/2" camion

- Demontage van filters 95 mm - 165 mm

Clé filtre à huile camion 1/2"



FOR 61902

Oliefilter bandsleutel

- 150-100mm

Clé à sangle nylon pour filtres à huile



FOR 619

Oliefiltersleutel met nylon band

Clé à sangle pour filtres à huile

- Oliefiltersleutel op basis van een kunststof spanband.
- Heeft een sterke hevelwerking en is ideaal als u de omliggende motordelen niet wilt krassen, of als u weinig werkruimte heeft.



FOR 61903

Oliefilter bandsleutel

- 50-300mm

Clé à sangle nylon pour filtres à huile



FOR 61908

Oliefiltersleutel met rubber band

- lengte band 500 mm
- cap 160 mm dia

Clé à sangle pour filtres à huile

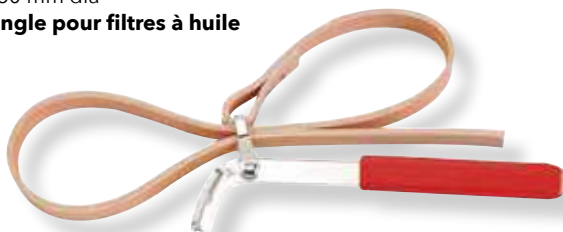

FOR 61912

Oliefiltersleutel met nylon band

- lengte band 850mm
- lengte handvat 300mm

Clé à sangle pour filtres à huile nylon



FOR 61911

Oliefiltersleutel kettingmodel

- cap 40-120 mm

Clé à chaîne pour filtres à huile

FOR 61914

Oliefiltersleutel kettingmodel**Clé à chaîne pour filtres à huile**

- cap 75-150 mm



FOR 61901

Oliefiltersleutel kettingmodel**Clé à chaîne pour filtres à huile**

- Oliefiltersleutel voor het aan- en afschroeven van oliefilters tot een diameter van 120 mm.
- Met ketting en 1/2" vierkant aansluiting.



FOR 61910

Oliefiltersleutel

- Demontage van filters 65 mm - 110 mm
- eenhandsbediening
- ook voor moeilijk bereikbare oliefilterbehuizing
- verstellen door draaiknop
- staalband vervangbaar

Clé filtre à huile

- demontage filtre 65 mm - 110 mm



FOR 61910L

Oliefiltersleutel

- Demontage van filters 110 mm - 155 mm

Clé filtre à huile

FOR 639250

Oliefiltertang 60-90 mm**Pince réglable pour filtre à huile 60-90 mm**

FOR 639300

Oliefiltertang 85-115 mm**Pince réglable pour filtre à huile 85-115 mm**

FOR 639365

Oliefiltertang 100-140 mm**Pince réglable pour filtre à huile 100-140 mm**

FOR 639230

Oliefiltertang

- Demontage van filters 53 mm - 118 mm
- lente : 230 mm

Pince étau pour filtre à huile

FOR 61933

Magnetische carterplug sleutel
Clé magnétique pour bouchon de vidange

- Met dit handige gereedschap kunt u de caterplug verwijderen zonder de plug of de hete olie met uw handen aan te raken
- Nooit meer olie doordrenkte handschoenen of het laten vallen van de carterplug in de hete olie, eenvoudig de magneet bevestigen aan de vooraf losgedraaide carterplug en draaien om te verwijderen
- Permet d'effectuer la vidange de l'huile moteur, du liquide de transmission ou de l'huile pour engrenages sans danger dû à la température des liquides. Aimant très puissant qui s'attache facilement aux bouchons d'huile. Permet un changement d'huile plus commode. La poignée brevetée permet une prise en main confortable. Application universelle.

Geen vieze en verbrande handen meer!

FOR 61920

Oliefilter doppenset 3 dlg 3/8"
Jeu de 3 clés filtre à huile type choche 3/8"

- 27 mm, 32 mm, 36 mm
- Mercedes, Vauxhall, Opel, BMW, Ford



FOR 61920B

Oliefilterdoppenset 5 dlg 3/8"
Jeu de 5 clés à huile tuyepe choche 3/8"

- 24 mm, 27 mm, 32 mm, 36 mm, 38 mm
- Caddillac, Mercedes, Vauxhall, Opel, BMW, Ford



FOR 61936

Oliefiltersleutelset 10 delig
Set clés filtre à huile type cloche 10 pcs

Geschikt voor montage van oliefilters bij Mercedes, BMW, Volvo, VW, Fiat, Renault, Honda, Mazda, Nissan, Toyota etc.

Inhoud:

- Adapter 1/2" (F) x 3/8" (M)
- Adapter 3/8"(F) x 1/2"(M)
- Oliefilter dop 27mm/6 kant
- Oliefilter dop 32mm/6 kant
- Oliefilter dop 36mm/6 kant
- Oliefilter dop 74mm/14 kant
- Oliefilter dop 76mm/14 kant
- Oliefilter dop 76mm/12 kant
- Oliefilter dop 86mm/16 kant
- Oliefilter dop 93mm/15 kant



FOR 61905135

Oliefiltersleutel

- 115-135mm

Clés filtre à huile type cloche

FOR 61906111

Oliefilter klembandsleutel

- 95-111mm

Clés filtre à huile

FOR 61915

Oliefiltersleutelset 15 delig

- voor losdraaien en vastzetten van oliefilterhuisdeksels
- voor Europese en japanse auto's

Set clés filtre à huile type cloche 15 pcs

- voitures Européen et Japonaises



FOR 61917

Oliefiltersleutelset 30 delig

- voor Europese en japanse auto's
- in kunststof koffer

Set clés filtre à huile type cloche 30 pcs

- voitures Européen et Japonaises



61915	61917	SW	vlakken
	*	66 mm	6
*	*	65 mm	4
*	*	65-67 mm	14
*	*	68 mm	14
*	*	73 mm	14
	*	74 mm	15
*	*	74-76 mm	15
*	*	75-77 mm	15
	*	76 mm	12
*	*	76 mm	14
*	*	76mm	30
	*	76 mm	8
	*	78 mm	15
*	*	80 mm	16
*	*	80-32 mm	15
	*	86 mm	16
	*	86 mm	18
*	*	90 mm	15
	*	92 mm	10
*	*	93 mm	15
*	*	93 mm	36
	*	93 mm	45
	*	95 mm	15
	*	96 mm	18
*	*	100 mm	15
	*	106 mm	15
	*	108 mm	15
	*	108 mm	18
	*	olie filtersleutel	
*	*	adapter	

Olíe - Huíle

FOR 9U0706

Carterplugsleutel 8 x 10 mm Clé de vidange 8x10 mm

- Voor Peugeot, Renault en Volvo carterpluggen in oliecarter en versnellingsbak.
- Ook voor achterassen.



FOR 5061

Carterpluggen set 6 delig Jeu de douilles pour carter 6 pcs

- 5/16" hex x 3/8" hex, 8 mmSq x 3/8" Sq, 11 mmSq x 12 mmSq, 13 mmSq x 14 mmSq, 17 mmSq x 1/5" HEx, 8 mmHex x 10 mmHex



FOR T5122

TC module olie service set 12 delig TC module de 12 d'outils de graissage

617	magneet met spiege, miroir
618	voelmaatjes, jauges d'épaisseur 0.05 mm tot 1 mm
619	oliefilter sleutel, clé de filtre d'huile
807416M-807420.6	bougiedop 16 mm & 20.6 mm, douille pour bougie
810421	sleutelhouder 21 mm
carterpluggen	5/16" Hex 3/8" Hex, 8 mm x 3/8", 11x12 mm 13x14 mm, 17 mm x 1/2" H, 8 mm x 10 mm



FOR 964G1

Herstelkit oliecarterplug 64 delig Set de révision pour filtrage 64 pcs

Voor het snel en doeltreffend repareren van ernstig beschadigde olie carter schroefdraad in aluminium oliecarter pannen.

Regelmatig komt het voor dat de oorspronkelijke schroefdraad van het olie carter zo ernstig beschadigd is, dat alleen volledig vernieuwen de enige goede oplossing is.

- Draadtap M13 x 1.5 met 5 Carterpluggen en aluminium afdichtringen M13 x 1.5
- Draadtap M15 x 1.5 met 5 Carterpluggen en aluminium afdichtringen M15 x 1.5
- Draadtap M17 x 1.5 met 5 Carterpluggen en aluminium afdichtringen M17 x 1.5
- Draadtap M20 x 1.5 met 5 Carterpluggen en aluminium afdichtringen M20 x 1.5

Geschikt voor Audi, BMW, Citroen, Mercedes-Benz, FORd, Fiat, Honda, Mazda, Mitsubishi, Nissan, Opel, Peugeot, Porsche, Renault, Saab, Seat, Skoda, Toyota, Volvo en VW.



FOR T50618-18

TC module 3/8" bougiedoppenset 6 dlg TC module 3/8" douilles pour bougies 6pcs

647318P	momentsleutel 18Nm
8073250 14,16,20.6	mag. bougiedop 16.mm - 14mm -20.6 250mL
807316M- 807320.6M	mag.bougiedop 16 mm & 20.6 mm, douille pour bougie
5047P4	bougiestekertang 280mmL



1/2" Doppen XZN douilles

FOR 34805514T	M16 55 mm L	magnetisch
FOR 34805516T	M16 55 mm L	magnetisch
FOR 34810016T	m16 100 mmL	magnetisch

- Spline dopsleutel met gat speciaal voor de oliecarterplug op de versnellingsbakken van Audi, Volkswagen, Skoda en Ford.
- Maat: Spline/Veeltand M16 met gat.
- Aansluiting 1/2", lengte 100 mm.

Toepassing:

- Audi A2, A3, A4, A6
- Volkswagen Golf IV, Passat B5, T4, T5 en LT4
- Skoda Fabia, Octavia en Superb, Ford Galaxy 1.9 TDI

FOR 34880008	M8	800 mmL
FOR 34880010	M10	800 mmL

- Extra lange spline dopsleutel voor montage van aandrijfsschroeven vanaf de buitenzijde door de wielkast bij VW en Audi
- Spaart kostbare tijd en geen zware verlengstukken meer nodig



Art.nr	mm		L mm
FOR 807314	14	6kant/6pans	63
FOR 807316	16	6kant/6pans	63
FOR 807318	18	6kant/6pans	63
FOR 807320.6	20.6	6kant/6pans	63
FOR 807314M	14	12kant/12pans	70
FOR 807316M	16Mag	12kant/12pans	70
FOR 807318M	18Mag	12kant/12pans	70
FOR 807320.6M	20.6Mag	12kant/12pans	70

Art.nr	mm		L mm
FOR 807325014M	14	12kant/12pans	250
FOR 807325016M	16	12kant/12pans	250

Art.nr	mm		L mm
FOR 807416	16	6kant/6pans	63
FOR 807418	18	6kant/6pans	63
FOR 807420.6	20.6	6kant/6pans	63
FOR 807414M	14	12kant/12pans	70
FOR 807416M	16	12kant/12pans	70
FOR 807418M	18	12kant/12pans	70
FOR 807420.6M	20.6	12kant/12pans	70

Bougiedop 3/8" Douilles pour bougies 3/8"



Bougiedop 1/2" Douilles pour bougies 1/2"

FOR T31010

TC module 3/8" bougiedoppenset 10 dlg TC module 3/8" douilles pour bougies 10pcs

- 3/8" Magnetische bougiedop 14 mm
- 3/8" Magnetische bougiedop 16 mm
- 3/8" Magnetische bougiedop 18 mm
- 3/8" Magnetische bougiedop 20.6 mm
- 3/8" Magnetische bougiedop lang (250 mm) 14 mm
- 3/8" Magnetische bougiedop lang (250 mm) 16 mm
- 3/8" Magnetische bougiedop lang (250 mm) 20.6 mm
- 3/8" Adapter met kogelgewricht
- 3/8" Adapter met draaimoment 18 Nm
- 3/8" Adapter met draaimoment 24 Nm



FOR 88704H9

Vetpomp 400 mL met vulnippel Pompe à graisse manuel avec embouts pour graisseurs

- pour cartouches de graisse standard 400 mL



FOR 887A500

Cardanspuit 500 mL Seringue aspirante refoulante 500 mL

- Enkelwerkende cardanspuit.
- Geschikt voor vullen en afzuigen van vloeistoffen.
- Verzinkt staal met zinken deksel.
- Geleverd met 300 mm transparante, flexibele slang.
- Inhoud 0.5 liter.



FOR 887C02

Oliekan metaal met flexibel 350 mL Burette à huile à bec flexible 350 mL



FOR 887D01

Metalen trechter Entonnoir en métal

Lengte 370mm



FOR 61928

Olie trechter Entonnoir pour huile

Lexus, Toyota, VW, Audi, BMW, Mercedes-Benz, Chevrolet, Volvo



FOR 887P01**Vatpomp telescopisch**
Pompe pour fût telescopic

- voor niet coorosieve vloeistoffen voor 60L tot 200L vat
- pour fluides non-corrosive

**FOR 908T9****Transmissie vulpomp incl adapters**
Système de remplissage de boîte de vitesse

- Compleet systeem voor onderhoud van gesloten automatische transmissies van o.a. Ford, Toyota, BMW, Honda, Nissan, VW, Audi, Mercedes en Volvo (ook voor DSG en CVT versnellingsbak.)
- Groot 7.5-liter reservoir met geïntegreerde handpomp, manometer en overdruk ventiel.
- Pour le remplissage des boîtes de vitesse et des différentiels, comprend un kit d'adaptation avec différents angles de sortie. Pratique pour les zones difficilement accessibles.



Ontsteking brandstof - allumage carburant

FOR 916G3

Set voor verwijderen van gebroken gloeibougies Set de réparation de filets pour bougies de préchauffage

16-delige set voor het verwijderen van beschadigde of moeilijk te demonteren gloeibougies uit de cilinderkop en tevens professionele reparatie van beschadigde schroefdraad.

Inhoud:

- Trekker voor vastzittende gloeibougies
- Stappenboren voor het uitboren van afgebroken gloeibougies in 7 x 5,5 mm en 9 x 5,5 mm
- Schroefdraadtappen M8 x 1,0, / M10 x 1,0 / 6,3 (1/4")-28UNF om nieuw schroefdraad te tappen
- Houder voor schroefdraadtappen met ratelfunctie
- E10 dop



FOR 933G1

Gloeibougie schroefdraad herstellings set Kit réparation de filetage bougie de prechauffage

31 Delige set voor het reparereren van 8 mm, 10 mm en 12 mm gloeibougie schroefdraad in aluminium cilinderkoppen bij dieselloertuigen.

Inhoud:

- Schroefdraadtap M8 x 1,0
- Schroefdraadtap M10 x 1,0
- Schroefdraadtap M10 x 1,25
- Schroefdraadtap M12 x 1,0
- Schroefdraadtap M12 x 1,25
- Schroefdraadtap M14 x 1,25
- 5 Draadbussen M8 x 1,0 (binnendraad)
- 5 Draadbussen M10 x 1,0 (binnendraad)
- 5 Draadbussen M10 x 1,25 (binnendraad)
- 5 Draadbussen M12 x 1,25 (binnendraad)
- Draadbus montagegereedschap M8 x 1.0 / M10 x 1.0
- Draadbus montagegereedschap M10 x 1.25 / M12 x 1.25
- Handvat
- Montagestang voor draadbussen
- 3 Bougie-eindafsluiters



FOR 909G6

Pneumatische trildoppenset met laag koppel die speciaal ontwikkeld is om vastzittende gloeibougies van dieselmotoren los te draaien. Extracteur réversible à percussion à couple réglable pour bougies de préchauffage

- Door het gecontroleerde koppel in combinatie met de trilfunctie kunnen gloeibougies veilig losgedraaid worden en verkleint u de kans op afbreken van de gloeibougie.
- De pneumatische slagsleutel heeft vier vast ingestelde koppels en de draairichting is omkeerbaar.
- Het set bevat vijf 1/4" trildoppen van chroom-molybdeen staal (8-9-10-11-12 mm), 2 verlengstukken en een kogelgewricht adapter voor gebruik in kleine ruimtes. Het gereedschap kan ook met andere doppen worden gebruikt om verbindingen los te draaien die bijvoorbeeld door corrosie of koolafzetting vastzitten.



FOR 904G12

Stoppenset voor rem & brandstofleidingen
Jeu de 4 pinces d'obturation pour tuyaux et raccords

- Deze verende stoppers zijn geschikt om losgekoppelde stalen remolie- en brandstofleidingen af te stoppen om te voorkomen dat vloeistof uit de leiding weglekt.
- Voorkomt weglekken van bijv. remolie of brandstof en verontreiniging van de werkvloer
- Perfect voor het werkzaamheden aan remleidingen en brandstofleidingen
- Verend voor instant on/off
- Maten: Banjo, 3/8", 5/16", 1/2"
- Geschikt voor alle automotieve vloeistoffen



FOR 9G0715

Tang voor brandstofleidingen
Pince pour raccords carburant

FOR 9G0716

Tang voor brandstofleidingen
Pince pour raccords carburant

FOR 9G0104

Brandstof klemtang clic R
Pince pour collier clic R

FOR 9G0109

Slangklemtang clic clic R
Pince pour collier clic R

FOR 9G1001

Gloeibougie stekker tang
Pince droite pour bougies de préchauffage

- Ontworpen om op moeilijk bereikbare plaatsen, zonder schade aan te richten de gloeibougie stekkers te verwijderen. Recht model met soft grip handvat en voorzien van duim uitsparingen voor makkelijk gebruik en extra kracht te zetten.
- Geschikt voor dieslmodellen van Audi, BMW, Mercedes, Opel en Volkswagen



FOR 9G0123

Dop voor brandstoffilter 1/2" 27 mm 1/2" Douille pour filtre de carburant 27 mm

- Citroën C4 2.0 HDi 16v, C4 Picasso 2.0/2.2 HDi, C5/C8
- 2.0/2.2 HDi 16v Jumpy 2.0/2.2 HDi
- Fiat : Scudo/Ulysse Mk 2.0 JTD 16v
- Ford : Focus - C Max - Galaxy - Kuga - S Max 2.0 TDCi
- Peugeot : 307-308-407-607-807-Expert 2.0 HDi 16v
- Volvo : C30-C70-S40 mK ii/v50 2.0 DIESEL (136HP)



FOR 904G10

Set koppelingen met veersluiting 4 delig Jeu d'acouplements de verrou à ressort 4pcs

- Pour conduites d'airco 3/8"-1/2"-5/8"-3/4"
- voor airco leidingen

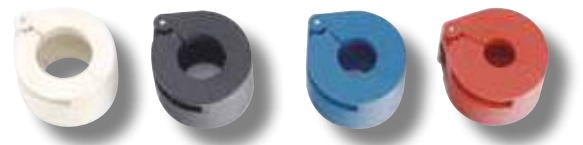

Blokkeergereedschap - outils de calage

FOR 9G0605

Vliegwiel blokkeergereedschap
Outil de calage volant moteur



FOR 9G0606

Universele nokkenas tegenhouder

- Alfa Romeo, Audi, Citroën, Fiat, Ford, Opel, Renault, Rover, Skoda, VW, Volvo
- voor het draaien en op plaats houden van de poelies van nokkenas en de injectiepomp

Outils universel pour retenir l'arbre à came

Pour bloquer, d'entraîner et maintenir les poulies d'arbres à cames et de pompes d'injection. Universel pour Volkswagen, Seat & Skoda Diesel, Rover & Land Rover Diesel, Renault & Fiat avec double arbre à cames,

Ford Zetec, Citroën & Peugeot etc.



FOR 9G0617

Universele nokkenas blokkeersleutel

Outils universel pour retenir l'arbre à came

- Universeel inzetbaar voor het verdraaien van tandwielen of voor het blokkeren van de nokkenas om de nokkenas bout los te draaien. Geschikt voor het verdraaien en fixeren van het nokkenafstandswiel
- instelbare opening van 50-150 mm



FOR 908G4

Time toolset universeel 8 delig

Jeu d'outils de réglage universels 8 pcs



FOR 919G1

Blokkeergereedschap voor nokkenas en krukas 19 delig

Outil de calage pour arbre à cames et vilebrequin 19 pcs



FOR 913G3

Blokkegereedschap voor diesel en benzinemotoren 13 delig Outils de calage pour moteurs diesel et essence 13 pcs

- Audi, Citroën, Fiat, Peugeot, VW, Volvo



FOR 9G0121

1/2" Dop voor injectiepomp 33k spline x 56 mmL Douille spéciale 33 pans pour pompe à injection

- Mercedes
- Voor demontage van de drukventielhouders aan MRSF-ERE brandstof injectiepompen bij Mercedes Benz 601, 602, 603, 605, 606, 615, 616 en 617 diesel modellen.
- Douille à denture multiple pour le montage et démontage de la soupape de compression de la pompe d'injection MRSF-ERE sur véhicules de Mercedes Benz diesel 601, 602, 603, 605, 606, 615, 616 et 617.



FOR 9G0122

1/2" Dop XZN voor voorkamer Mercedes 58t 1/2" Douille spline pour pré-chambre Mercedes

- diesel motoren Mercedes Benz 601, 602, 602.91, 603, 604, 605, 606, 661, 662
- Pour extraire l'anneau de fermeture sur la chambre diesel de pré-combustion de Mercedes sur les moteurs à partir de 1989. Code moteurs: 601, 602, 602,91, 603, 604, 605, 606, 661, 662.



FOR 903G20

Montagehulp voor elastische riemen Jeu d'outils pour courroies Elastiques Uni-Flex

- Geschikt voor elastische riemen zoals bij Alfa-Romeo, BMW, Citroën, Chrysler, Dacia, Fiat, Ford, Mazda, Opel, Peugeot, Renault, Seat, Skoda, Smart, VW en Volvo.
- Utilisable pour le montage et de démontage des courroies Elastiques Uni-Flex. Les courroies stretchy ou flexibles d'entraînement d'auxiliaire sont apparues environ en 2004. Elles associent des matériaux leur conférant des propriétés élastiques. Cette élasticité permet "d'étirer" les courroies pour les mettre en place au lieu d'avoir à utiliser des tendeurs ou des poulies. Cependant ces courroies ne peuvent pas être étirées en place à la main, un outil est nécessaire pour les guider pendant que l'on fait tourner les poulies.
- Approprié par Alfa-Romeo, BMW, Citroën, Chrysler, Dacia, Fiat, Ford, Mazda, Opel, Peugeot, Renault, Seat, Skoda, Smart, VW et Volvo.



Blokeergereedschap - outils de calage BMW

FOR 905G1

Tijdafstelset BMW M52,M54,M56

Coffret calage de distribution BMW M52, M54, M56

- Tijdafstelset voor BMW 6-cilinder dubbele Vanos benzine motoren (M52TU, M54, M56) vanaf 1998.
- Geschikt voor BMW 6-cilinder benzine motoren: M52TU (1998-2000), M54 (2001-2004) en M56 (vanaf 2003.)
- Ce coffret est composé d'outils pour le blocage de l'arbre à cames par moteurs essence avec Valvetronic (M52TU, M54, M56) à partir 1998. BMW a installé un système double vanos sur les moteurs essence 6 cylindres à double arbre à came et chaîne de distribution.
- Les unités d'ajustement de vanos sont adaptées à l'arbre à cames (entrée et sortie) et doivent être remises à zéro pour aligner avec les arbres à cames en réglant la synchronisation du moteur après remplacement de la chaîne etc. Convient pour moteurs essence BMW 6 cylindres double vanos: M52TU (1998-2000), M54 (2001-2004) et M56 (à partir 2003.)



FOR 913G6

Tijdafstelset BMW M41, M51, M47, M57

Coffret calage de distribution BMW M41, M51, M47, M57

- Geschikt voor werkzaamheden aan dieselmotoren van BMW, Rover en Opel.



FOR 908G9

Tijdafstelset BMW N42,N46, N64T

Coffret calage de distribution BMW N42, N46, N46T

- Geschikt voor met ketting aangedreven 1.8 & 2.0 liter benzinemotoren van BMW voorzien van Vanos technologie.

Modellen:

- BMW: 118/120 E81, E82, E87 (2004-2009)
- BMW: 318/320 E90, E91, E93 (2005-2009)
- BMW: Z4 E85, E86 (2004-2009)
- BMW: X3 E83 (2005-2009)
- BMW: 316/COMPACT E46 (2001-2005)
- BMW: 318/COMPACT E46 (2001-2007)

Motor codes:

- N42 / N46 / N46T B18, B18A, B20, B20A, B20B



FOR 904G11

Tijdafstelset BMW N47, N47S Coffret calage de distribution BMW N47, N47S

- Geschikt voor met ketting aangedreven 1.6l, 1.8l, 2.0l, 2.3l, 2.5l
- dieselmotoren van BMW met motorcodes N47, N47S, N57 en N57S.



FOR 905G12

Tijdafstelset BMW, Mini, Citroën, Peugeot Coffret calage de distribution BMW, Mini, Citroën, Peugeot

- Geschikt voor een groot aantal ketting-aangedreven benzinemotoren van BMW, Mini, Citroën en Peugeot.
- Het gereedschap is specifiek ontworpen om de nokkenas en krukas op hun plaats te vergrendelen zodat de nokkenas distributie correct kan worden gecontroleerd en ingesteld.



FOR 907G3

Blokkeersleutelset voor Mercedes & BMW Coffret clés visco embrayage couplage ventil refroidissement

- Voor het blokkeren van de Visco koppeling bij BMW, Mercedes en Ford.
- Stelt u in staat om de poelie van de waterpomp in de juiste positie te zetten terwijl tegelijkertijd de ventilator gedemonteerd wordt.
- 7 clés pour le démontage ou le maintien du ventilateur de refroidissement, de l'arbre d'entraînement de Visco Embrayage Ford, Mercedes et BMW.
- Permet le tenir la poulie de la pompe à eau en place.



Blokeergereedschap - outils de calage

FOR 904G15

Tijdafstelset VW Coffret calage de distribution VW

- Voor de vergrendeling van beide nokkenassen en krukas bij VAG 1.2 liter 3-cilinder 6V en 12V benzine motoren.
- Nokkenas uitlijngereedschap 6V
- Nokkenas uitlijngereedschap 12V (2)
- Krukasborggereedschap 6V & 12V

Toeassing:

- Volkswagen Polo, Lupo en Fox 1.2 liter, 3-cilinder 6V en 12V (vanaf 2002)
- Seat Cordoba en Ibiza 1.2 liter, 3-cilinder 6V (2002-2009)
- Skoda Fabia en Roomster 1.2 liter, 3-cilinder 6V en 12V (2002-2010)



FOR 902G2

Blokeergereedschap Vw, Audi, Seat, Skoda Outils de calage moteur VW, Audi



FOR 906G4

Blokeergereedschapset voor VAG TDI Outils de calage moteur VAG TDI

Geschikt voor VAG 2.0L TDi PD DOHC motoren zoals in de Audi A2/ A3/A4/A5/A6, Skoda Octavia II, Seat Leon, Volkswagen Golf en meer. Tevens geschikt voor de VAG ASZ en ASZ1 motoren in de Ford Galaxy.

Inhoud:

- Krukas borggereedschap voor ovale krukas (tot 2004)
- Krukas borggereedschap voor ronde krukas
- Injectiepomp borgpen (2)
- Distributieriemspanner borgpen
- Spanpoelie borgpen

(OEM: 310 085/T10050, T10100, 3359/T20102, T10115, T10060/A)



FOR 9G1206

Nokkenas blokkeergereedschap VAG Outil de blocage pour arbre à cames VAG

Blokkage gereedschap voor het blokkeren van de nokkenas bij het vervangen van de tandriem.

Te gebruiken bij 4 cilinder 16V injectiemotoren van Audi, Seat, Skoda en VW.

OEM: T10016 / T10074.

Toepassingen:

- Audi A2 1.4 (2000-2006)
- Seat Arosa 1.4 (1999-2005), Cordoba 1.4 (1999-2008), Ibiza 1.4 (1999-2008), Inca 1.4 (2000-2004), Leon 1.4, 1.6 (1999-2005), Toledo 1.4, 1.6 (1999-2005)
- Skoda Fabia 1.4 (1999-2005), Octavia 1.4 (1999-2005)
- VW Beetle 1.4, 1.6 (2001-2008), Bora 1.4, 1.6 (1997-2008), Caddy 1.4, 1.6 (1999-2008), Golf 1.4, 1.6 (1997-2008), Lupo 1.4, 1.6 (1998-2005), Polo 1.4, 1.6 (1998-2007)

Motor codes:

- Audi: AFK, AHW, AKQ, APE, ARR, AQQ, AUA, AUB, AXP, BBY, BBZ, BCA, BKY
- Seat: AFK, AHW, APE, AQQ, AUA, AUB, AUS, AXP, AZD, BBY, BBZ, BCA, BCB, BKY, BXW
- Skoda: AUA, AUB, AXP, BBY, BBZ, BCA, BKY, BUD, BXW
- VW: AFK, AHW, AJV, AKQ, APE, AQQ, ARC, ARR, AUA, AUB, ATN, AUS, AVY, AXP, AZD, BBY, BBZ, BCA



FOR 904G17

Tijdafstelset Bosch 3 in 1 VW Coffret calage de distribution VW Bosch 3 in 1

Past op Bosch VE injectie pompen

Gebruiken in combinatie met een meetklokje

- M8 adapter
- M10 adapter
- M12 adapter

Geschikt voor:

- Bosch VE injectie pomp
- Diesel kiki
- Nippondenso pompen



FOR 9G1208

Krukas borggereedschap Outils de calage moteur

- Volkswagen, Audi, Seat, Skoda, 2.0 Tdi

Voor het blokkeren van de krukas tandwiel van VAG 1.9 en 2.0 TDI dieselmotoren met pompverstuiver, inclusief DOHC.

Geschikt voor de 1.9 en 2.0 TDI motoren met een ovale profiel vertanding.

OEM T10100

Toepassingen:

- Audi: A3, A4, A6
- Seat: Altea, Alhambra, Leon, Toledo
- Skoda: Fabia, Octavia 2
- Volkswagen: Beetle, Bora, Caddy, Fox, Golf, Golf Plus, Jetta, Lupo, Passat, Sharan, Touran

Motor codes:

- AZV, BKD, BMN, BMP



Blokeergereedschap - outils de calage BMW

FOR 928G1

Tijdafstelset VW, Audi, Seat & Skoda Coffret calage de distribution VAG

- Tijdafstel borgset voor benzine en diesel motoren van de VAG groep (Audi / Seat / Skoda / VW) vanaf 1976.
- Tevens geschikt voor een aantal modellen van Volvo en Ford waar een VAG motor in ligt.

Benzine motoren:

- 1.2 6V - 1.2 12V - 1.4 - 1.6 - 1.8 - 1.8T - 2.0 16V
- Audi: 80 - A2 - A3 - S3 - A4 - A6 - TT
- Seat: Alhambra , Arosa, Cordoba, Ibiza, Inca, Leon, Toledo
- Skoda: Fabia, Octavia (vanaf 1996)
- VW: Bora, Caddy, Fox, Golf, Lupo, nieuwe Kever, Passat, Polo, Sharan, Touran

Diesel motoren:

- 1.2, 1.4, 1.9, 2.0 TDI PD
- 1.7, 1.9 D / TD / SDI / TDI
- 2.5 V6 TDI
- Audi: 80, A2, A3, A4, A6, Cabrio (1995-2000)
- Seat: Alhambra , Arosa, Altea, Cordoba, Ibiza, Inca, Leon, Toledo
- Skoda: Fabia, Felicia, Octavia (1993-2005)
- VW: Bora, Caddy, Golf, Lupo, nieuwe Kever, Passat, Polo, Sharan, Transporter, Touran



FOR 907G13

Tijdafstelset VAG 2.0 FSI & 2.0 FSI Turbo Coffret calage de distribution VAG 2.0 FSI & 2.0 FSI Turbo

- Speciaal gereedschap voor het blokkeren van de nokkenas en krukas.
- Geschikt voor 2.0 liter FSI motoren.

Toepassingen:

- Audi A3, VW Golf / Touran (vanaf 2004)
- Motorcodes:
- AWA / AXW / BHD / BMB / BGB / BPJ / BPY



FOR 906G6

Tijdafstelset VW Coffret calage de distribution VW

- VW Transporter, LT, Crafter 2.4D, 2.5DI, 2.5TDI, 2.5TDI common rail



FOR 904G16

Tijdafstelset VAG 1.4 & 1.6 FSI Coffret calage de distribution VAG 1.4 & 1.6 FSI

- Speciaal gereedschap voor o.a. distributieriem vervanging bij
- VAG 1.4 & 1.6 FSI

Toepassingen:

- Audi A3 (2003-2007)
- Skoda Octavia (2004-2009)
- VW Polo (2002-2008), Golf (2003-2009), Golf Plus (2005-2009), Jeta (2006-2009), Passat (2005-2009), Touran (2003-2009)



FOR 914G5

Tijdafstelset VAG 2.7 & 3.0 V6 TDI Coffret calage de distribution VAG 2.7 & 3.0 V6 TDI

- Dit set is geschikt voor 2.7 en 3.0 V6 modellen van Audi (A4, A5, A6, AB, Q5, Q7) en VW (Touareg, Phaeton.)
- Bevat speciale adapters voor het draaien en positioneren van de krukas ten opzichte van de cilinderkop.

Inhoud:

- Krukas TDC Borgschroef
- Injectiepompborgpen
- Krukasdraaigereedschap Type 1
- Krukasdraaigereedschap Type 2
- Nokkenasborgpennen (2 stuks)
- Nokkenasuitlijnings-/borggereedschap
- Nokkenastandhoudgereedschap
- Spannerborgpennen 3.3 mm (2 stuks)
- Coffret outils de calage de distribution pour moteur 2.7 et 3.0 V6 TDi Volkswagen et Audi, VAG Groupe.
- Contenu:
- Vis de blocage de PMH de vilebrequin
- Cheville de blocage de pompe à injection
- Outil de rotation de vilebrequin Type 1
- Outil de rotation de vilebrequin Type 2
- Adaptateur de boulon de poulie de vilebrequin (2pcs)
- Outil de positionnement/blocage d'arbre à cames
- Outil de maintien de roue dentée d'arbre à cames
- Cheville de blocage de tendeur 3.3mm (2pcs)
- (OEM: T40062, T40041, T40049, 3359, T40058, T40060, 3342)



Diesel verstuivers - injecteurs diesel

FOR 903G17

Kit verstuivertrekkers Kit extracteurs d'injecteurs

- Mercedes, C class, E-class, Sprinter



FOR 904G3

Kit verstuivertrekkers 4 delig 1/2" Kit extracteurs d'injecteurs 4 pcs 1/2"

- 22 mm 6p 110 mm L
- 22 mm 12p 75 mm L
- 27 mm 12p 78 mm L
- 28 mm 12p 78 mm L



FOR 907G7

Set frezen voor diesel verstuiverzitting Nettoyeur siège injecteur

- 15 mm plat - universeel
- 17 mm plat Delphi, Bosch injectors BMW, PSA, Renault, Ford
- 19 mm plat Bosch injectors, Mercedes CRD
- 19 mm konisch Fiat, Iveco
- T hendel



FOR 921G3

Diesel verstuiver demontageset Coffret extracteur d'injecteur diesel universel

- Balhoofd bout M18 x 1.5 voor aansluiting van de adapters aan een slagtrekker
- Speciale inbus dopsleutel 10 mm x Ø 7.6 (1/2" aansluiting; voor het losdraaien van de bevestigingsring zoals bijvoorbeeld bij Bosch injectoren van Mercedes Benz CDI en PSA HDI)
- Speciale Inbus dopsleutel 10 mm x Ø 6.6: (1/2" aansluiting; voor het losdraaien van de interne schroef van CR-injectoren)
- Adapter IT M16 x 1.0 voor Denso (Toyota 2.2D)
- Adapter IT M17 x 1.0 voor Bosch injectoren, Alfa, BMW, Fiat, Mercedes Benz, PSA en Renault
- Adapter IT M20 x 1.0 voor Denso
- Adapter IT M25 x 1.0 voor Siemens injectoren, PSA (DW10)
- Adapter IT M27 x 1.0 voor Siemens injectoren, PSA (DW10)
- Adapter OT M16 x 1.5 trek adapters voor M16 x 1.5 draad
- Adapter OT M14 x 1.5 voor binnendraad voor Bosch/ Delphi injectoren, Mercedes Benz (OM 629/642/646), PSA (DV4 / DW12), VW (CBD), BMW (M47)
- Adapter OT M25 x 0.5 voor Denso
- Adapter OT M25 x 0.75 voor Denso
- Adapter OT M27 x 1.0 voor Siemens, Citroën C5, Citroën Jumpy/ Xsara, Fiat Ducato JTD, Peugeot 206 / 307 / 406 / Boxer (2.0 / 2.2 / 2.3 HDI), Mercedes-Benz CDI (behalve A-Class, Sprinter en Vito)
- Verstuiverdop (open dop) 25 mm voor Siemens Injectoren - 2.0 HDI (DW Series), PSA, Ford, Toyota etc.
- Verstuiverdop (open dop) 27 mm voor Siemens Piezo Injectoren - 2.0 HDI Piezo (DW Series), PSA etc.
- Verstuiverdop (open dop) 29 mm voor Bosch type injectoren - Bosch CDI / HDI motoren
- Verstuiverdop (open dop) 30 mm voor Bosch Type injectoren - Bosch Renault / Nissan 1.9DCI
- Trekbeugel 12 mm voor Mercedes-Benz motoren (behalve Sprinter, Vito en A-Class)
- Trekbeugel 13.5 mm voor Opel, Nissan en Renault F9Q
- Trekbeugel 16 mm voor Fiat Ducato JTD, Citroën C5, Citroën Xsara, Citroën Jumpy en Jumper HDI en Peugeot 206 / 307 / 406 / Boxer HDI (2.0, 2.2, 2.3l)
- Trekbeugel 26 mm voor Opel Z19DT, Z19DTH / Z19DTL motoren, A20DTH (LBS) / A20DTR (LBY) / A20DTJ (LBX) / A20DTC (LCD) en Fiat 1.9 JTD



FOR 904G9

Diesel injectiepomp verstuiver trekkers Delphi & Bosch Set adaptateurs pour extracteurs d'injecteurs



FOR 912G6

Kit pompverstuivertrekkers VAG TDI 1 FSI Kit extracteurs d'injecteurs pompe

- Speciaal ontworpen voor het professioneel (de)monteren van FSI injectoren en diesel pompverstuivers.
- Geschikt voor Volkswagen, Audi, Seat en Skoda met direct ingespoten benzinemotoren en Common-Rail dieselmotoren.

Inhoud:

- Slagtrekker
- Trek adapter voor demontage van FSI injectoren
- Trek adapter met klauw voor demontage van FSI injectoren
- Trek adapter voor demontage van diesel pompverstuivers
- Montagekegel voor het monteren van de verbrandingskamer afdichtingen
- 3 Kalibratiehulpstukken voor het monteren van de verbrandingskamer afdichtingen
- Montagedrevel voor het opnieuw monteren van de FSI injectoren



FOR 904G7

Diesel injectiepomp trekker BMW Extracteur pompe injection diesel BMW

Brandstof injectiepomp trekker en distributieketting spanner set voor BMW, Land Rover en Opel.
(OEM: 135120, 135190, 135191, 135192)

Voor BMW met M47, M47T2, M47TU, M57, M57TU, M57D2 motor op BMW 318D, 320D (E46) 1988-2005 en 318TD, 320TD, 525D 530D, 530, 535 (E60-E61) 2000-2006 en Land Rover TD4 M47 2.0.

Tevens geschikt voor Opel Omga B, Land Rover Freelander en Rover 75.



FOR 9G0114

Diesel verstuiver trekker Extracteur d'injecteurs diesel

Voor verwijderen van moeilijk te verwijderen, vastzittende Bosch en Lucas diesel injectoren (verstuivers).
Slagtrekker met 3 adapters in de maten M8 - M12 - M14.
Geschikt voor Volvo en Scania.



Motor - moteur**FOR 904G10****Set koppelingen met veersluiting 4 delig**

- voor airco leidingen

Jeu d'acouplements de verrou à ressort 4 pcs

- Pour conduites d'airco 3/8"-1/2"-5/8"-3/4"

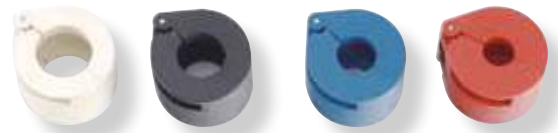
**FOR 62104****Klep veer spanner****Tendeur de ressort de soupape**

- Spanbereik 35 - 200 mm
- Met omzetbare klepspie adapters Ø 25 mm en 30 mm
- Universele klepverentang, inzetbaar op 95% van het wagenpark
- Voor zowel benzine- en dieselmotoren met moeilijk bereikbare en diep zittende kleppen

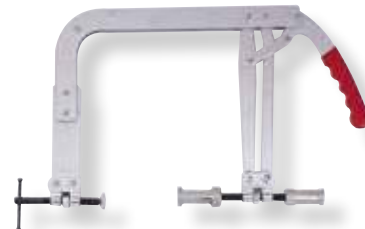
**FOR 62110****Universele kleppenlichter****Compresseur de ressorts de soupapes universel**

- Heavy Duty stalen beugel
- 5 Uitwisselbare drukstiften; Ø 16, 19, 23, 25 en 30 mm
- 3 Spanschroeven; 70 mmL / 110 mmL / 120 mmL

**FOR 9G0609****Universeel spanningstester voor motorriem****Mesures tension courroie moteur****FOR 9G0804****Distributieriem spanning meter**

- controleer de distributie spanning in 10 sec

Tensiomètre courroie distribution

- contrôle tension courroie distribution en 10 sec

**FOR 922G3****Universele kit voor alternator 22 delig****Kit universel pour alternateur 22 pcs**

- VW, Audi, Seat, Mercedes, Renault, MBW, Ford, Fiat etc
- Voor het monteren en demonteren van dynamo vrijloop poelie Bij werkzaamheden aan de dynamo poelie bij moet de as geblokkeerd worden met spline of torx en een adapter waar doorheen de dop-sleutel past in de vrijlopende poelie



FOR 67402

Spanrol alternator 33 tands VAG, volvo
Outils pour courroie multi VW, Audi



FOR 678

T50 Alternator tools

- 1/2" torx dop bit T50 x110 mm L
- voor Mercedes A klasse



FOR 6203125

Zuigveerklem 53-125 mm
Compresseur de segments 53-125 mm

FOR 6206175

Zuigveerklem 90-175 mm
Compresseur de segments 90-175 mm



FOR 674

T50 Alternator tools

- 1/2" spline XNZ dop bit T50 x110 mm L
- voor VW, Audi, Skoda,
- Porsche, BMW, Ford, Mercedes



FOR 618

Voelmaatjes 20 delig
Jauge d'épaisseur 20 pcs

- metric 0.05 mm-1.00 mm

FOR 61802

Voelmaatjes 26 delig
Jauge d'épaisseur 26 pcs

- 0.04 mm - 0.63 mm



FOR 9G0901

Cylinderruimer
Tête de pierrage pour cylindre moteur

- 3 stenen 100 x 10 x 8 mm
- geschikt voor cilinder diameter van 50-178 mm
- Voor het snel en effectief honen van cilinders, remcilinders, koppelingcilinders, reinigt en verwijdert koolstof afzetting.



FOR 906G2

Kit voor bijvullen en ontluichten van koelingsysteem
Kit pour purger et remplir le système de refroidissement

**FOR 908G1**

Benzine compressiemeter set 8 delig
Set compressiomètre essence 8 pcs

- 0-20 bar adapters M10*1.0 - M12*1.25 - M14*1.25 - M18*1.5

**FOR 913G1**

Diesel compressiemeter
Set compressiomètre diesel

- 0-70 bar

**FOR 938G1**

Diesel lekkage cylinder test kit
Compressiomètre diesel masterkit

- Geschikt om auto en vrachtwagen motoren te testen via de verstuiver, de gloeibougie of de injectoren (TDI/CDI.)
- Voor diesel compressie druk 0-1000 Psi en 0-70 Bar.
- Met goed leesbare schaalverdeling en snel-ontluchtingsventiel.
- Rubberslang met snelkoppeling, adapters met M20- M22 M24 & Ford aansluiting, standadyne du mmy adapters, 90 graden omgezette aansluitadapter en klemplaat.

**FOR 902G9**

Montage hulp voor elastische riemen
Coffret d'outils pour courroie flexible multi V

- Elastische riemen zijn op steeds meer moderne motoren te vinden.
- Dankzij de elastische eigenschappen van de riem is gebruik van een spanrol niet meer nodig. Bij het vervangen van de de riem is voorzichtigheid geboden, omdat de riem bij verkeerde montage eenvoudig schade kan oplopen.
- Met deze montagehulp kan de elastische riem gemakkelijk en zonder schade van de poelie verwijderd worden en er weer terug opgelegd worden.
- Geschikt voor elastische riemen zoals bij PSA en Ford motoren bv Ford
- Fiesta 1.4L/1.6L Focus 1.6L Citroën C4, Peugeot 307, Fiat Doblo , Dacia Logan



FOR 906G11**EGT sensoren demontage set 6dlg***Demontage capteur EGT*

- Speciale doppen set voor het demonteren van de EGT sensoren (uitlaatgas temperatuur sensoren). Geschikt voor o.a. auto's, vrachtwagens & bedrijfsvoertuigen.
- Rechte dop 13, Rechte dop 14, • Rechte dop 17
- Haakse dop 13, Haakse dop 14, Haakse dop 17

**FOR 907G2****Lambdasonde set 7 delig****Kit d'èblèvements de sondes lambda 7 pcs**

- Voor het monteren en demonteren van lambdasondes of dieselinjectoren zonder kabels of leidingen te beschadigen
- Speciaal voor lambdasondes op moeilijk bereikbare plaatsen
- Geschikt voor montage van dieselinjectoren van BMW, Ford, Mercedes, Opel, Rover, Seat, VAG, Volvo etc.
- 22 mm 1/2" x 7/8" x 50 mmL
- 22 mm 3/8" x 7/8" x 30 mmL
- 22 mm 3/8" x 7/8" 6kant 80 mmL
- 22 mm 3/8" x 7/8" 6kant 90 mmL
- 5- 3/8" x 1" x 1-1/16" x 74 mmL
- 6 1/2" x 29 mm 6kant 90 mmL

**FOR 44315022****Lambdasonde dop****Douille pour montage-démontage sondes lambda**

- 1/2" 22 mm 6k 150 mm L

**FOR 902G11****Electronische motor stethoscoop****Stethoscope électronique**

- Voor het eenvoudig definiëren en lokaliseren van bijgeluiden
- aan motor, aandrijving etc.
- Instelbaar volume
- Gehard stalen probe
- Koptelefoon met oorpads om achtergrond geluiden af te sluiten

**FOR 9U0401****Infrarood thermometer****Thermomètre infrarouge**

- Voor nauwkeurige contactloze temperatuurmeting
- Te gebruiken voor het snel meten van temperatuur van bijvoorbeeld koelsysteem, remmen, airco, motor en uitlaatdelen.
- Met laser markering.
- Bereik -20°C tot 500°C.
- Nauwkeurigheid ± 2°C bij -20°C tot 100°C en ± 2% bij 100°C tot 500°C.

**FOR 885G01****Gloeibougie tester 12 volt***Analyseur de bougies de préchauffage 12 Volt*

- Met deze gloeibougietester diagnostiseert u snel en eenvoudig de staat van uw gloeibougies zonder deze uit het motorblok te moeten verwijderen.
- Geschikt voor gebruik op 12 Volt gloeibougies van dieselmotoren en is rechtstreeks op de accu van het voertuig aan te sluiten.
- Beschikt over zes LED-uitlezinging die de status van de gloeibougie aangeeft en tevens of de accu voldoende is opgeladen om de gloeibougies van stroom te kunnen voorzien.

**FOR 885G02****Brandstof injecteur tester 12 volt****Testeur d'injecteur essence 12 Volt**

- Test brandstof-injectoren van benzinemotoren om problemen met de brandstoftoevoer met elektronische brandstofinspuiting vast te stellen.
- Werkt met uitgeschakelde motor en de pulstimer kan worden gebruikt met een brandstofdrukmeter.
- De tester heeft een 4 pulsmodus, (1) Kort, (2) Gemiddeld, (3) Lang en (4) Continue modus die helpt bij het identificeren van goede of slechte injectoren. Geschikt om fouten in het brandstofsysteem te lokaliseren, zoals:
- Verstopte of lekkende injectoren
- Trage of uitgebrande injectoren
- Kabelboom defecten



FOR 9G0201**Slangklemtang****Pince à cable pour colliers auto serrants**

- Capaciteit 0 - 100 mm
- Lengte Bowdenslang 630 mm
- Geschikt voor CTC slangklemmen

Geschikt voor o.a. Audi, Citroen, Peugeot, Porsch, Renault, Seat, Skoda, Toyota, Volkswagen.

**FOR 9G0109****Slangklemtang met draaibare koppen****Pince à colliers avec têtes pivotantes**

Ces pince clic pratique est adaptée pour desserrer et réinstaller des colliers de serrage Clic et Clic-R. Les mâchoires réversibles et orientables permettent d'adapter la pince aux différents colliers et permettent d'accéder facilement aux différents positionnement des ergots sur les colliers. Idéal pour les endroits difficiles d'accès. Convient à VW/Audi, Citroën, Fiat, Mercedes, Opel, Peugeot, Renault, etc.

**FOR 9G0104****Clic en Clic-R slangklemtang****Pince pour colliers Clic en Clic R**

Speciale tang voor het vakkundig openen en hersluiten van herplaatsbare Clic en Clic-R slangklemmen.

Clic en Clic-R slangklemmen worden meest gebruikt op brandstofleidingen.

Bekken met speciaal profiel en comfortabel kunststof handvat.

**FOR 62518****Slangklemtang****Pince à collier de durite**

Pince permettant d'enlever rapidement et simplement les colliers de serrage rapide des durites de liquide de refroidissement, essence, etc. Un mécanisme à "cliquet" permet le maintien du collier en position ouverte, la pince comprend deux paires de mâchoires pivotantes qui s'adaptent au collier sous différents angles.

**FOR 909G3****Slangklem tangenset 9 delig****Set de pinces 9 pcs**

- 1 x Slangklemtang Bowden, op afstand bedienbaar met Bowdenkabel voor verende slangklemmen van 18-54 mm
- 1 x Slangklemtang met "+" bek
- 1 x Slangklemtang met "U" bek
- 1 x Slangklemtang voor draadveerklemmen
- 1 x Slangklemtang gebogen voor draadveerklemmen
- 1 x Slangklemtang CLIC-R
- 1 x Slangklemtang voor ashoes slangklemmen



FOR 904U4**Haak & priemset 4 dlg
Jeu de 4 crochets**

- Mini uitvoering, handig voor het verwijderen van bijv. o-ringen, keerringen, stofringen en bussen voor verschillende toepassingen.
- Elk gereedschap is voorzien van een RVS haak en een duurzaam kunststof handvat met softgrip.
- Mini priem (150mm)
- Mini ronde haak (150mm)
- Mini 45° haak (150mm)
- Mini 90° haak (150mm)

**FOR 9G0113****Keering trekker
Extracteur de joints d'étanchéité****FOR 61937****Dieselfilter sleutel filterhuis VW & Volvo
Clé à filtre de carburant diesel VW & Volvo**

Speciale filter sleutel om de plastic behuizing te verwijderen bij vervanging van het papieren brandstoffilter 1/2" aansluiting. Volkswagen Crafter 2.5 TDi (2006-2013) Volvo 4 en 5 cilinder 2.0 en 2.4 dieselmotoren: C30, C70, S40, S60, S80, V50, V60, V70, XC60, XC70, XC90

**FOR 5042****Set van 4 tapeindeuithalers
Set de 4 extracteurs de goujons**

FOR 81806	6 mm
FOR 81808	8 mm
FOR 81810	10 mm
FOR 81812	12 mm

**FOR 818B****Kracht tapeindverwijderaar
Extracteur de goujons universel**

Voor het uitdraaien van beschadigde, verroeste of gebroken tapeinden. Geschikt voor slagmoersleutels. Traploos verstelbaar van Ø 6 - 12 mm

FOR 818B01	3/8"
FOR 818B02	1/2"

**FOR 9G0206****Bougiestekker trekker
Outil spécial bougie de préchauffage**

Voor het losmaken van moeilijk bereikbare bougiestekkers van zeer diepliggende bougies zoals bij VW 16V motoren. Doordat de trekker halfzijdig open is wordt de bougiekabel niet beschadigd tijdens het demonteren.

Ook geschikt voor metalen bougiestekkers. Toepasbaar bij o.a. VW, Audi, Mercedes, Smart enz.



Remmen - freins**FOR 903G12**

Set van 3 tangen voor flexibele slangen
Set de 3 pinces pour tuyaux flexibles

- 10 mm-15 mm-24 mm

**FOR 903G18**

Slang klemtangenset 90° gebogen
Jeu de 3 pinces coudées à clamer les durites

- 3 Hittebestendige klemtangen voor het afklemmen van bijv. koelvloeistof-, brandstof- of vacuümslangen.
- Met afgeronde bekken om beschadiging aan de slang te voorkomen.
- Verstelbaar middels houderring en eenvoudig met 1 hand te bedienen.
- Geschikt voor slangen met een diameter van 15 mm tot 60 mm.
- Slang klemtang 90° gebogen 225 mm
- Slang klemtang 90° gebogen 165 mm
- Slang klemtang 90° gebogen 155 mm

**FOR 904G8**

Set van 4 klemmen voor flexibele slangen
Set de 4 pinces pour tuyaux flexibles

**FOR 9T0108**

Remschijf demontage gereedschap
170-400mm

Extracteur de disque de frein

- Extracteur de disque de frein pour un démontage rapide et sûr des disques de frein. Réduit les charges vibratoires des roulements de roue, des capteurs électroniques, des joints à rotule, etc.
- Extracteur de disque de frein avec branches à ressort à grande capacité de réglage
- Convient pour des disques de 170 mm à 400 mm de diamètre

**FOR 65305**

Remleiding buigtang
Pince à cintrer les tuyaux de freins

- Pince à cintrer pour tubes du cuivre, de l'aluminium, et de l'acier de diamètres 3/16" - 1/4" - 5/16" - 3/8" (4.8 - 6.4 - 7.9 - 9.5 mm.) Cintrage des conduites de freins, carburants et autres jusqu'à 180°.



FOR 9G0111

Gereedschap voor flexibele slangen Outil pour tuyaux flexibles

Afsluitklem voor het eenvoudig en effectief afsluiten van radiator-slangen, remleidingen en brandstofleidingen.
De schroefactie zorgt ervoor dat de slang echt helemaal dicht is.
Door de ronde vorm wordt de slang/leiding niet beschadigd.
Geheel metalen uitvoering.



FOR 9T0203

Remveerplaatser

- om de aandrukveren van trommelremmen te spannen
- Outil pour pose et dépose des ressorts de frein**



FOR 9B0101

Tang voor remveren

- voor het verwijderen van de terugtrekveren van de remschoenen

Pince à ressort de frein

Pour les garnitures de frein rivetées et collées sur le frein à tambour avec la griffe mobile, facilement enlève et installe les ressorts de retour de chaussure sur la plupart des freins, chrome plaqué.



FOR 9B0102

Tang voor remveren

- voor het verwijderen van de terugtrekveren van de remschoenen

Pince à ressort de frein

Pince pour ressorts de frein permettant de monter et démonter le ressort de rappel des mâchoires de frein.



FOR 9U3003

Staalborstel 200 mmL

Brosse acier 200 mmL



FOR 9B1701

Remschoen afstelgereedschap

Levier de réglage des freins



FOR 88501

Remvloeistof tester
Testeur de liquide de frein

FOR 88502

Remvloeistofmeter led display
Testeur de liquide de frein

Un outil simple pour tester le pourcentage d'eau dans le liquide de frein essentiel pour les contrôles de sécurité réguliers sur vos freins. Permet de contrôler la qualité des liquides frein DOT3, DOT4 et DOT5. Outil rapide et simple.



FOR 9G0902

Cylinderruimer
Tête de pierrage pour cylindre de frein

- 3 stenen 28.5 x 5
- geschikt voor cilinder diameter 19-63 mm
- Pour le déglacement et rectifications des cylindres 19-63mm, modèle à 3 branches idéal pour les systèmes de freinage.
- Outil à 3 branches petit taille pour déglacement des cylindres de frein
- Avec une pression réglable pas de coupures dans le cylindre
- Têtes de meulage de 28.5 mm de dureté moyenne
- S'utilise avec une perceuse ou visseuse
- Pour cylindres de diamètre 19 à 63mm



FOR 9T0107

Remtrommel schuifmaat
Jauge de mesure pour frein à tambour

Remtrommel schuifmaat geschikt om de dikte van de remtrommel op te meten. Meet de mate van slijtage van de remtrommel om binnen de vastgestelde marges van te fabrikant te blijven. Capaciteit 160 - 400 mm, met metrische en inch schaalverdeling.



FOR 904B2

Remknecht en stuurwielhouder
Kit repousse pédale frein et bloc volant

Dit handige gereedschap is te gebruiken als pedaalsteun (remknecht) Voor indrukken van het rempedaal, checken van de remlichten, remdruk, zuigers etc. Ook voor indrukken van gaspedaal, koppeling, enzovoorts. Daarnaast kan dit gereedschap ook gebruikt worden om het stuurwiel stevig op zijn plaats te houden bij het uitlijnen.



FOR 65802

Remzuigerterugstelgereedschap 13 delig

- Universeel remzuigerterugstelgereedschap voor linksom en rechtsom terugstellen. Voor diverse automerken.

Set d'outils repousse piston de freins 13 pcs

- gauche-droite



FOR 65805

Remzuigerterugstelgereedschap 18 delig

- Universeel remzuigerterugstelgereedschap voor linksom en rechtsom terugstellen. Voor diverse automerken.

- 15 adapters en 2 trekkers

Set d'outils repousse piston de freins 18 pcs



FOR 65815

Terugstelset remzadelzuigers pneumatisch links-rechts 16 delig

Set d'outils pneumatique pour repousser pistons de freins gauche-droite 16 pcs

- Met deze set draait u de remzuiger met luchtdruk in enkele seconden terug zijn ruststand.
- Nooit meer remklauwen demonteren om te zuiger terug te kunnen draaien. Geleverd met 15 adapters, geschikt voor Audi, Fiat, Ford, Isuzu, Honda, Jaguar, BMW, Nissan, Mitsubischi, VW, Saab, Mazda, Toyota enz



FOR 65803

Terugstelset remzadelzuigers 3 delig

Repousse piston de freins 3 pcs

- Ford, Honda, Jaguar, Mazda, Mitsubischi, Nissan,
- Rover, Subaru, Toyota met ABS



FOR 904B1**Borgklemmen voor remcilinder**
Jeu de 4 pinces garniture de frein à tambour

- Set van 4 klemmen om de zuigers van remcilinders in trommelremmen te borgen.
- Voorkomt lekkage van remvloeistof langs de zuigers bij het vervangen van de remblokken.

**FOR 904G12****Stoppenset voor rem & brandstofleidingen**
Jeu de 4 pinces d'obturation pour tuyaux et raccords

- Verend voor instant on/off
- Maten: Banjo, 3/8", 5/16", 1/2"
- Geschikt voor alle automotive vloeistoffen

**FOR 9T0106****Schuifmaat voor remschijven**
Piede à coulisse pour disques de frein

- Kleine handige schuifmaat om de dikte van remschijven te meten en tevens geschikt als bandenprofielmeter.
- Meetbereik: 0-60 mm
- Materiaal: aluminium
- Afmeting: 182 x 115 x 13 mm

**FOR 4036****1/2" 5kant doppen en bitdop voor remmen 3 dlg**
1/2" Douilles et embout sur douille 5 pans pour freins 3 pcs

- douille embout 10 mm 55 mmL Girling
- douille 14 mm : Smart-Astra G-Zafira
- douille 19 mm : Bendix-Citroën-Peugot-Renault

**FOR 908G8****Kit druk- en onderdrukpomp**

- Druk en onderdruk
- geschikt voor lucht en vloeistof

Kit pompe pression/dépression

- Permet de nombreuses applications techniques : contrôle de l'avance à dépression, des capsules à dépression, du turbo etc

**FOR 9B0402****Remklauwdop voor VAG & Porsche****Douille 10 pans pour étrier de frein VAG & Porsche 9mm**

Applications: Porsche Macan, Cayenne et Cayman, VW Touareg et Audi Q7, S8. Tailles: 9 mm x 10 pans x 38 mm de long. Carré d'entraînement: 1/2".



FOR 656

Kit felgereedschap voor remleiding 8 dlg Kit evasement de tuyau de freins

- Geschikt voor enkele en dubbele felskragen op koperen en zachtstalen leidingen met een wanddikte tot 1 mm.
- Remleiding moet dubbel gefelst worden.
- Wordt geleverd met 7 adapters in de inch maten: 3/16" - 1/4" - 5/16" - 3/8" - 7/16" - 1/2" en 5/8"
- Convient pour les collets simples ou doubles, coniques et plates, pour cuivre doux ou aluminium jusqu'à 1 mm d'épaisseur.
- Fourni avec 7 adaptateurs pour les tubes 3/16" - 1/4" - 5/16" - 3/8" - 7/16" - 1/2" et 5/8"
- Convient pour les tubes Ø 4 - 6 - 8 - 10 - 12 - 14 et 16 mm



FOR 656M

- Geschikt voor leidingen van Ø 4 - 5 - 6 - 8 - 10 - 12 en 14 mm.

FOR 65601

Telescopische pijpsnijder 3-29 mm Coupe-tubes 3-29 mm



FOR 65602

Mini telescopische pijpsnijder 3-22 mm Coupe-tubes mini 3-22 mm



FOR 9B0109

Veerplatentang voor trommelremmen Pince pour ressorts garnitures de freins

- Mercedes A klasse, Citroen, Renault, Peugeot, Land Rover, Ford Honda etc



Wielen - roues

FOR 681B400

Versterkte kruissleutel 17-19-21-22

- 1/2" met adapter (400 mm L)

Clé en croix renforcée 17-19-21-22



FOR 681600

Kruissleutel 24-27-32 mm

- 3/4" met adapter (600 mm L)

Clé croix pliable 24-27-32 mm

- 3/4" avec adaptateur (600 mmL)



FOR 4032

Set 3 lange slagdoppen voor alu velgen

Jeu de 3 douilles longues à choc 1/2"

- 17-19-21 mm 1/2"



FOR 4033

Set 3 lange slagdoppen voor alu velgen

Jeu de 3 douilles longues à choc 1/2"

- 17-19-21 mm 1/2" (150 mmL)



FOR 4032TH

Set 3 lange dunwandige slagdoppen

Jeu de 3 douilles longues à choc 1/2"

- 17-19-21 mm 1/2"



FOR 4035

Set 3 torsie slagdoppen

Jeu de 3 douilles longues à choc torsion

- 17-19-21 mm 1/2"
- Deze doppen zijn voorzien van een koppelbegrenzer (115 Nm) waardoor de wielbout nooit te vast kan worden aangedraaid.



FOR 40710

Wiel sleutelset 7 delig

- 17-19-21-23 mm 1/2" lange slagdoppen voor alu velgen
- telescopische wielsleutel met aanpasbaar handvat
- wringijzer 300 mm L

Jeu de clés de roue 7 pcs

17-19-21-23mm



FOR 906T5

Wielbouten schroefdraad herstellingskit

Kit de réparation des filets de boulons de roues

M12 x 1.25

M12 x 1.5

M14 x 1.5

Speciale set voor het herstellen van de wielbouten schroefdraad.

Door het verkeerd aandraaien van de wielbouten kan de schroefdraad beschadigd raken. Met deze speciale tappen kan de schroefdraad op relatief eenvoudige wijze worden hersteld.

De tappen kunnen door het gespleten ontwerp op het onbeschadigde gedeelte van de schroefdraad worden geplaatst, dit is meestal het aan de basis van de bout. Vervolgens kan de tap met de meegeleverde dop worden terug gedraaid.



FOR 907U5

1/2" Anti-diefstal wielbout verwijderaars set 7 dlg

1/2" Extracteurs de boulons de roues anti vol 7pcs

- 17-18.5-20-21.5-23-24.5-26mm



FOR 912U3

12 delig twist doppen set 3/8" & 1/2"

voor beschadigde of afgeronde bouten, wielmoeren...

- 3/8" 8-10-12-13 mm
- 1/2" 14-15-16-17-19-21 mm

Set de 12 douilles twist

- kit pour les vis, écrous de roue, boulons etc
- 3/8" 8-10-12-13 mm
- 1/2" 14-15-16-17-19-21 mm



FOR 9T0206

Krachedop voor wielbouten Mercedes 17 mm 1/2"

Douille speciale écrous de roues pour Mercedes

- C-klasse, GLK (W204), E klasse (W211, W212, W207), SLK (W172)
- M-klasse (W164, W166) CL-klasse (W216), S klasse (W221, W222) en Maybach



FOR 920U3

Uitdraaien van schroeven, bouten en moeren

Kit de réparation des filets de boulons de roues

Voor het uitdraaien van schroeven, moeren en bouten, als de inzet-schroefdraad of de zeskant beschadigd is. Door de bijzondere constructie van de doppen (conisch en speciaal links profiel) kunnen schroeven, moeren en bouten probleemloos los- en uitgedraaid worden. De linkse tap (ook "boutuitdraaier" genoemd) heeft linkse draad, waardoor deze de bout aangrijpt en gelijk losdraait.

- Linkse tap 1/8" - 1/4" (M3 - M6) (artikel 9UXBM06)
- Linkse tap 1/4" - 5/16" (M6 - M8) (artikel 9UXBM08)
- Linkse tap 5/16" - 7/16" (M8 - M11) (artikel 9UXBM11)
- Linkse tap 7/16" - 9/16" (M11 - M14) (artikel 9UXBM14)
- Linkse tap 9/16" - 3/4" (M14 - M18) (artikel 9UXBM18)
- Pinkse profiel doppen 8 - 10 - 11 - 12 - 13 - 14 - 15 - 16 - 17 - 19mm
- L-sleutel 6mm
- 3/8" Adapter voor verlengstuk 3/8"(F) x 3/8"(M)
- 3/8" Verlengstuk 150mmL
- 3/8" Wobble verlengstuk 44mmL
- 3/8" Quick-grip sleutel



FOR 62701**Spiraalveerspanner
Compresseurs de ressorts****FOR 627270****Spiraalveerspanner 270 mm L per paar
Compresseurs de ressorts 270 mm L****FOR 627370****Spiraalveerspanner 370 mm L per paar
Compresseurs de ressorts 370 mm L****FOR 62521****Ashoes klemband spanner en knipper
Pince et ajusteur pour les colliers de soufflet de cardan**

- Voor het bevestigen van bandstaal klembanden bij ashoezen, met opspan en afknip mechanisme.
- Trek de klemband door de geleidingssleuf aan de voorkant en schuif het door de sleuf in de middelste draaihandel. Met de middelste draaihandel klemt u de spanband vast over de aandrijfhoes. Dan knipt u het af met het roterende mes aan de voorkant.

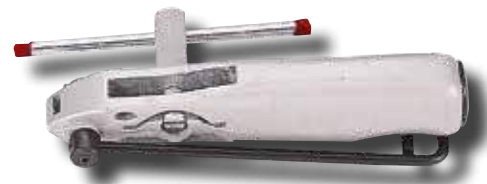
**FOR 62527****Ashoes klemtang met aanhaalmoment
Pince de serrage pour soufflet de cardan**

Een defecte ashoes vervangen is een klus die de nodige aandacht vraagt. Aan de ene kant is het belangrijk dat de ashoes bij de montage niet beschadigd raakt, aan de andere kant is het belangrijk dat de hoes op de juiste manier wordt vastgezet.

Deze klemtang met aanhaalmoment biedt hierbij uitkomst. Dit handige gereedschap is niet alleen ontwikkeld voor de probleemloze montage van ashoezen van het materiaal hytrel, maar ook voor het met het juiste moment monteren van de klemband.

Hiervoor kan een 3/8" momentsleutel op de klemtang worden gebruikt.

Geschikt voor onder andere VW, Audi, Seat, Skoda, Opel en FORd.

- Met 3/8" aandrijving, maakt gebruik van momentsleutel mogelijk
- Geschikt voor het vastzetten van klembanden op de ashoezen
- Voor gebruik bij RVS klembanden van de ashoezen
- Lengte 255 mm



FOR 62520

Ashoes klemtang Pince pour colliers de serrage

Voor (de)montage van click slangklemmen op ashoezen, koel- en brandstofleidingen van o.a: VW, Audi, Opel, BMW, Mercedes Benz, Honda, Nissan en Mazda.

- Geen beschadigen van klem bij het knijpen
- Gelijkmatic samenknijpen van de klem vergrendeling
- Geen beschadiging aan de ashoes
- Cette pince permet de mettre en place les colliers de soufflets de cardan, durites de radiateur et carburants. Conception robuste pour travailler sur des colliers en inox ou acier. Convient par VW, Audi, Opel, BMW, Mercedes Benz, Honda, Nissan, Mazda, etc.



FOR 681D515

Kracht wielmoersleutel Démultiplicateur de force pour boulons de roues

Verwijderd vastzittende moeren vlug en gemakkelijk

- lengte : 515 mm



FOR 750200

Bandenlichter 200 mm Outil pour pneu 200 mm

FOR 750380

Bandenlichter 380 mm Outil pour pneu 380 mm



FOR 750500

Bandenlichter 500 mm Outil pour pneu 500 mm



FOR 750650B

Bandenlichter 650 mm Outil pour pneu 650 mm

FOR 9B0302

Ventiel inzetsleutel Clé valve du pneu



FOR 904T4

Banden repair kit set 4 delig

Kit de réparation pour pneus 4 pcs

Kit réparation des pneus, multifonctionnel, facile à utiliser et durable à utiliser. Essentielle pour les véhicules avec des pneus tubeless. Ce kit vous permettra de réparer les perforations rapidement et efficacement et que vous avez sur votre chemin à nouveau dans quelques minutes.



Aandrijving - suspension & transmission

FOR 40912

1/2" Aandrijfas doppenset 9 dlg
1/2" Jeu de 9 douilles pour cardan

Doppenset voor het demonteren van de 12-kant moeren op de aandrijfas en het inbusprofiel in de cardanas zoals bijv. bij Golf IV, Polo, Seat, Skoda, Audi, BMW, Mercedes etc.

- Inhoud:
- 1/2" Krachtdop Inbus 14 mm: VW Passat (1996-2001), Audi A4 vóór- en achteras (AWD)
- 1/2" Krachtdop Inbus 17 mm: VW Passat (1998-2005), Audi A6 (1999-2004) / Audi A4 (2002-2005) vóór- en achteras (AWD)
- 1/2" Krachtdop Inbus 19 mm: VW T4 / T5, Skoda Fabia
- 1/2" Krachtdop 12-kant 27 mm: Ford Powerstroke, Volvo 480
- 1/2" Krachtdop 12-kant 30 mm: BMW E36 / E46, Citroen Saxo, Ford Galaxy, Mercedes W123 / W124 / W126 / W129 / W201 / W203 / W211, Opel Astra F / Astra G, Renault Scenic / Clio / Kangoo, Toyota Avensis / Picnic, VW Golf III / Golf IV / Lupo / Touareg / T5
- 1/2" Krachtdop 12-kant 32 mm: Fiat Punto, Ford Escort / Mondeo, Mercedes W140, Nissan Almera, Opel Astra H / Vivaro, Subaru Outback
- 1/2" Krachtdop 12-kant 34 mm: GM Motors
- 1/2" Krachtdop 12-kant 35 mm: Mazda
- 1/2" Krachtdop 12-kant 36 mm: Audi, BMW E36 / E39 / X5, Ford Transit / Seat Ibiza / Cordoba, Nissan Primera, VW Polo / Golf V / Touareg



FOR 907T8

Draadeinde reinigingset
Brosse de nettoyage pour goujons de roues

- 1/2" Bit-adapter
- Nylon opzet-adapter
- Opzetborstel Ø 12mm (7/16")
- Opzetborstel Ø 13mm (1/2")
- Opzetborstel Ø 14mm (9/16")
- Opzetborstel Ø 16mm (5/8")
- Opzetborstel Ø 22mm (7/8")
- Opzetborstel Ø 28mm (1-1/8")



FOR 9T1481

Naafmoersleutel VW/Audi
Clé moyeu pour VW/Audi

- 22 mm



FOR 9T0205

Aandrijfas dop voor VAG 4WD
Douille écrou d'arbre d'entraînement

Geschikt voor de aandrijfasmoer van de VAG 4WD/Quattro 6-versnellingsbak (0A3)

- Bijvoorbeeld zoals bij de Audi A4 (vanaf 2001) of de Audi A6 (vanaf 2005)
- 12-kant
- Aansluiting: 3/4"
- Lengte: 124 mm



FOR 904T1

Schokbrekersleutels VW/Audi
Jeu de outils ecrou amortisseur autos Allemande

Passend op de zuigerstangmoer van de schokdemper.

- No.1: 10.5 mm VW Golf
- No.2: 12.5 mm VW Polo
- No.3: 14.5 mm Polo, Golf, Passat, Audi 80
- No.3: 14.5 mm Austin Maestro



FOR 902T1**Uitlaat rubber trekkers
Crochets de traction 2 pcs**

Geschikt voor verwijderen en plaatsen van uitlaatrubbers op de ophanghaken van de uitlaat.
Voorzien van afgeronde haken en met kunststof overtrokken handgreep.

Facilite la mise en place des anneaux caoutchouc lors d'un échange d'échappement.

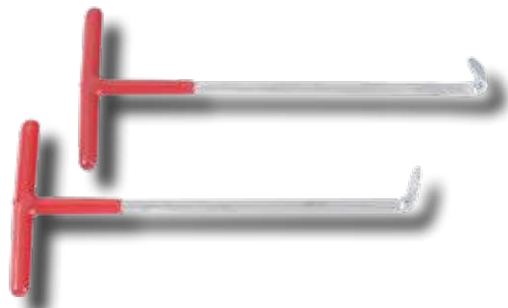
**FOR 9T0316****Tang voor uitlaat rubbers
Pince pour caoutchoucs d'échappement**

Speciale tang voor het eenvoudig met één hand verwijderen van uitlaat draag- en ophangrubbers.

Deze speciale tang heeft een openingshoek van 25° en is daardoor in vele posities te gebruiken.

Een stevige solide tang die is voorzien van een rubber coating handvat voor extra grip.

Lengte: 360 mm.

**FOR 907G5****Airbag demontage set
Kit outils special airbag**

Universele set voor vlotte en veilige demontage van airbags bij de meest gangbare automerken.

La longueur des clés permet d'atteindre facilement les vis de fixation des airbag (cousin gonflable).

- 1999-04 VW Passat, Jetta, Golf and Beetle
- Mercedes, BMW

**FOR 911T1****Gereedschapset voor TPMS
Coffret d'outils pour SSPP**

Deze uitgebreide set bevat alle gereedschappen dat nodig is om een TPMS-sensor juist in de velg te monteren.

- 1/4" Momentsleutel 1-5Nm
- 1/4" momentsleutel 3.-15Nm
- verlengstuk 50 mm
- 1//4" lange doppen 11 mm-12 mm
- 1/4 Torx bits T10-T15-T20
- binnenventeldraaier rood 0.25Nm-zwart 0.45Nm



Trekkers - extracteurs

FOR 664

Slaggewicht + trekkers 17 delig

Set marteau à inertie + arraches 17 pcs

Professionele heavy duty slagtrekker voor in- en uitwendig trekken met 2 of 3 haken, als steekastrekker, wielnaaftrekker, remtrommeltrekker en plaatwerktrekker.



FOR 664P

Trekkerset universeel

Set marteau à inertie

Universeel lager-en poulietrekset met zelfklemmende en centrerende armen. Door de overlappende maatvoering te gebruiken voor bijna alles wat u tegen mocht komen. De trekkerarmen zijn onderling uit te wisselen voor de meest uiteenlopende klussen. Geschikt voor zowel inwendig als uitwendig gebruik.

Inhoud:

- Houder voor 2 armen
- Houder voor 3 armen
- 3 armen van 32mm
- 3 armen van 47mm
- 3 armen van 123mm
- 1 spindel met buitenspindel
- 3 bout en moer om armen vast te zetten in houder
- Zelfklem en centreer plaat



FOR 66603

Montagekit dichtingen 10 delig

Kit de montage 10 pcs

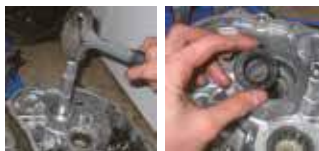

FOR 66601

Set kogellagertrekkers

Coffret decolleurs de roulement avec potences



FOR 66610

Set kogellagertrekkers

Coffret decolleurs de roulements avec potences

Bijzonder geschikt om lagers, binnenringen en andere hecht vastzittende onderdelen los te maken.

Door de schotels samen te trekken, grijpen de scherpe, wigvormige bekken van de schotels achter het los te maken onderdeel.

- Capaciteit schotels 30 mm - 50 mm en 50 mm - 75 mm.
- Incl. verlengstangen en spindels.



FOR 917T1

Trekbusset 10-42 mm
Coffret decolleurs

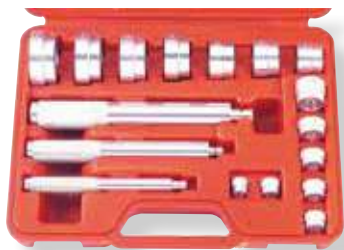
**FOR 906T3**

Fusee stuurkogel trekker
Coffret d'extracteurs de rotule

Dit set is geschikt voor personen- en bedrijfswagens. Hiermee kunt u moeiteloos stuurkogels, fuseekogels, stabilisatorstangen, draagarmen, geleidearmen en spoorstangarmen lospersen. De trekkers in dit set kunnen in verschillende posities worden ver- steld, hierdoor is het set universeel en geschikt voor alle merken auto's en lichte vrachtwagens.

- Kogelgewricht trekker, bereik ca. 35-64 mm, opening 20-22 mm, diepte 20-22 mm
- Stuurkogel trekker, opening 18 mm, breedte 38 mm, hoogte 36 mm
- Trekker, opening 35 mm, diepte 75 mm
- Trekker, opening 28 mm, diepte 60 mm
- Trekker 2-armig, opening 0-250 mm, diepte 170 mm, arm- lengte 120 mm

**FOR 62801**

Stuurkogeltrekker 19 mm
Extracteur pour billes 19 mm

**FOR 62806**

Stuurkogel trekker
Extracteur de rotules à 2 positions XL

Extra grote stuurkogel trekker met een maximaal spanbereik van 80 mm voor lichte bestel- en transportvoertuigen van o.a. Audi, BMW, FORd, Honda, Mercedes-Benz, Nissan, Opel, Renault, Seat, Skoda, Toyota, Volkswagen en Volvo. Belastbaar tot 45Nm, de druk op de kogel is dan 3 ton, ideaal bij ernstig vastgeroeste kogels.

- Opening bek: 22 mm
- Met 2 werkposities door het verstelbare scharnier, met een maximaal spanbereik van 50 mm en van 80 mm



FOR 62817**Stuurkogeltrekker
Arrache rotule**

Handig gereedschap voor stuurkogels, reactiestangen en andere kogelgewrichten. Deze gewrichten zijn meestal conisch van vorm en zitten daarmee vaak erg stevig vast. Geschikt voor kleine auto's.

- Opening bek 18 mm
- Spanbereik 15 - 40 mm
- Maximaal aanhaalmoment 20 Nm

**FOR 62814****Stuurkogel trekker
Extracteur de rotules**

- Opening: 2-1/2" (64mm)
- Trekker: 2-1/4" (57mm)

**FOR 628300****Demontage vork 300mmL 15/16"**
Fourche pour rotule de direction 15/16"**FOR 628400****Demontage vork 400mmL 21/32"**
Fourche pour rotule de direction 21/32"

Geschikt voor het lossen van de in de conusitting vastzittende kogelgewrichten, het lossen van stuurstangen en voor allerlei andere soorten demontagewerkzaamheden.

**FOR 904T5****Bougietrekker set 4 delig
Set extracteurs de bobines 4 pcs**

- VW, Audi



FOR 9T0204

Universele stuurstang montage- en demontagesleutel
Clé universelle de montage et démontage de bielles de direction

- 400 mm L
- 35-45 mm



FOR 66617

Microlagertrekker
Arache roulements

Trekker set dat geschikt is voor kleine lagers.

Lagers van 19 tot 45mm
 1 Ton
 Zelf centreren

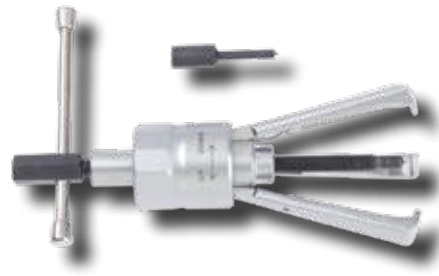

FOR 917T3

Set lagertrekkers VW-T5 dia 85 mm
Coffret outils pour roulements de roues Ø 85 mm

Speciaal voor het monteren en demonteren van HBU 2.1 wielnaaf lagereenheden (wiellagers) met een diameter van 85 mm. De demontage en montage kan direct aan het voertuig uitgevoerd worden zonder de anders noodzakelijke demontage van de wielophanging.

- Geschikt voor:
- VW T5 en VW Touareg met 16-inch chassis.
- Inhoud:
- Drukplaat
- Trekspindel & moer
- 2 Druk/pers schijven
- 5 Drukstukken
- 2 Steunringen
- 2 Cilinder schroeven



FOR 905T4

Kit voor vervangen van silentrubbers achteraan VW, Audi
Kit pour remplacer les silentblocs axe arrière VW-Audi

- Golf IV, Bora, Audi, 1.4-1.6-1.8-2.0-1.9D



FOR 905T10

Fuseekogel demontage set Mercedes
Coffret de démontage de rotule inférieur Mercedes

- Geschikt voor montage en demontage van onderste fuseekogels bij
- Mercedes Benz zonder uitbouw van de draagarm.
- Mercedes 220 S (1998-2005)
- Mercedes 211E (2002-2009)
- Mercedes 230SL (2001 - heden)



Lagertrekker Decolleurs de roulements

Art. nr.	cap	bout
FOR 666105	75-105mm	16mm x 165mmL
FOR 65909130	105-150mm	19mm x 260mmL



Twee armige zelfklemmende trekkers Extracteur à 2 bras

Art. Nr.		
FOR 6590103	2 ton	40-75 mm
FOR 6590104	4 ton	50-100 mm
FOR 6590106	6 ton	70-150 mm
FOR 6590108	10 ton	95-200 mm
FOR 6590112	15 ton	140-300mm



Twee armige trekkers Extracteurs à 2 bras

Art. nr.		maat
FOR 65909090	3 ton	90
FOR 65909130	3 ton	130
FOR 65909200	5 ton	200
FOR 65909250	7,5 ton	250



Drie armige trekkers Extracteurs 3 bras

Art. nr		
FOR 6590203	3 ton	40/75 mm
FOR 6590204	6 ton	50/100 mm
FOR 6590206	9 ton	170/50 mm
FOR 6590208	15 ton	95/200 mm
FOR 6590212	22 ton	140/300 mm



FOR 65113L

Krachtvermeerderaar 3/4" x 1" 2500Nm

- Compleet met reactievoet en stang 90°

Multiplicateur de couple, pour serrage droite/gauche



FOR 9T3711

Olie lekbak voor truck

Jeu de cartes d'huile pour essieux pour camions

- 3 liter
- Deze wielas olie opvangbak is ontworpen voor vrachtwagens, heeft een capaciteit van 3 liter en past precies in de schotel van het wiel. Capaciteit 3 liter. Gemaakt van sterk polyethyleen kunststof. Gewicht circa 400 gram. Voorzien van uitschenk voorziening.



FOR 909T3

Dopsleutelset voor kroonmoeren van kogellagers uitwendig Coffret de clés à douilles pour écrous KM, embouts à l'extérieur

- 1/2" KM 4-5-6-7
- 3/4" KM 8-9-10-11-12

Permet une intervention aisée sur les écrous à encoches de type locknut pour roulements.

9 Delig kroonmoer dopsleutel set geschikt voor het los- en vastdraaien van kroonmoeren zoals bijvoorbeeld lagermoeren.

Art. nr		inwendig	uitwendig
FOR 9TS4KM04	1/2'	28mm	35mm
FOR 9TS4KM05	1/2"	36mm	41mm
FOR 9TS4KM06	1/2"	41mm	48mm
FOR 9TS4KM07	1/2"	48mm	57mm
FOR 9TS6KM08	3/4"	53mm	63mm
FOR 9TS6KM09	3/4"	60mm	70mm
FOR 9TS6KM10	3/4"	65mm	75mm
FOR 9TS6KM11	3/4"	70mm	80mm
FOR 9TS6KM12	3/4"	75mm	85mm



FOR 909K1

Wielmontage centreerpennen 9dlg

Jeu d'outils de centrage d'embrayage universel 9pcs

- M18 x 1.5 - Daf, Iveco, Man, Renault, Volvo
- M20 x 1.5 - Daf, Ford, Man, Renault, Volvo, Mercedes, Scania
- M22 x 1.5 - Man, Mercedes

Ontworpen om de wielen te beschermen tegen beschadigingen als je de wiel gaat demonteren.

Pour le montage et le démontage de roues avec jantes à base creuse de véhicules utilitaires et PL centrées. Pas de détérioration du filetage et centrage précis de la jante.



Carrosserie

FOR 905M1

Clipverwijderaars 5 delig
Set enlève clips nylon 5 pcs

Kunststof gereedschap van hoge kwaliteit PVC voor het demonteren van het dashboard, portierbekleding, deurpaneel, dashboard, interieur, bekleding en sierlijst zonder dat lak, kunststof of ander materiaal beschadigd. Ook te gebruiken voor bedieningsknoppen van de verwarming. Door de verschillende afmetingen en vormen vindt u voor elke situatie een passende tool.



FOR 904M3

Interieurbekleding-verwijderset 4 dlg
Set enlève clips 4 pcs

Set van 5 hulpstukken geschikt voor (de)montage werkzaamheden aan interieur, dashboard en sierlijsten.
Vervaardigd van speciaal hard plastic/nylon.



FOR 904M6

Kunststof steekbeitels 4 dlg
Jeu de grattoirs plastique 4 pcs

Uitermate geschikt voor het verwijderen van onderdelen, uitsteken van siliconen voegen en verwijderen van plaklood op aluminium velgen zonder de onderdelen te beschadigen. Gebruik van een hamer is toegestaan bij deze beitels. Door het slijpen van het snijvlak met een vijl kan het gereedschap altijd optimaal gebruikt blijven worden. Snijkanten op 3 zijden voor veelzijdig gebruik.



FOR 904U1

Schraper set 4 delig
Set grattoirs 4 pcs

FOR T905M2

TC module haken, schraper & clipsverwijderaar 5 delig
Tc module 5 grattoirs et crochets

FOR905M2P1	vork voor deurbekleding, pour clips de porte
FOR 905M2P2	priem smal
FOR 905M2P3	priem
FOR 905M2P4	priem gebogen haak, gratoir
FOR 905M2P5	haak voor algemeen gebruik, usage universel



FOR 904M1

Bekleding clip verwijderset 4 dlg
Jeu de 4 extracteurs de garnitures

Voor het snel en onbeschadigd verwijderen van sierlijsten, bekledingclips, bumperstrippen en raamhendels. Vermindert het risico op interieur- en lakschade. Voorzien van carbon stalen schachten.

Platte U-hefboom (binnenmaat: 8.7 mm / buitenmaat: 21.7 mm)
Platte V-hefboom (binnenmaat: 0.5 mm tot 15 mm / buitenmaat: 20 mm)

Lange platte V-hefboom met gebogen schacht (binnenmaat: 0.3 mm tot 13 mm / buitenmaat: 19.4 mm)
Raamhendel demontage tool



FOR 9M0101

Tang voor verwijderen van clips

om nietjes, clips, deurpanelen bekledingshouders enz. snel en zonder schade te verwijderen

Pince enlève clips



FOR 665B

Uitdeukset 11 delig

Kit de débosselage 11 pcs

Uitdeukset met een slagtrekker van 4 kg en verschillende adapters voor de meest gangbare carrosseriewerkzaamheden.

Met adapters (haak, ketting hendel...) voor de diverse soorten deuken en overige toepassingen.

- Inhoud:
- Slagtrekker 4 kg
- Handvat
- Trekhaak 90° / 10 mm
- Trekhaak 90° / 22 mm
- Trekhaak 135° / 35 mm
- Trekhaak 135° / 65 mm
- Fixeerbout met schroef 70 mm
- Platte buis 95 mm
- Platte haak 190 mm
- Dubbel verloopstuk
- Bevestigingshaak met ketting 440 mm



FOR 50713

Uitblutset 7 delig

Kit de débosselage 7 pcs

FOR 62602	uitdeukhamer, marteau postillon
FOR 62603	uitdeukhamer, marteau à panne droite et tête ronde plat
FOR 62604	uitdeukhamer, marteau à rétreindre
FOR 68301	handtas universeel, tas virgule
FOR 68302	handtas in hakvorm, tas talon
FOR 68303	handtas hielvorm, tas tampon
FOR 68304	handtas in wigvorm, tas à courbure



FOR 911M1

Plaatwerk set 11 dlg

Mallette marteau de carrossier a embouts interchangeable

Perfect om mee uit de deuken of diepe krassen omhoog te werken. Set bestaat uit een hamer met 9 uitwisselbare stempels en een aambeeld 3 in 1.

Marteau avec 9 embouts interchangeables, rond, pointu et plat.

- 1 marteau porte outils
- 9 tas assortis à fixer au marteau
- Super pratique



FOR 9M0106**Verzet- ponstang****Pince à soyer et poinçonner (tête rotative)**

Gecombineerde tang voor het omzetten van de randen van metaalplaten en voor het ponsen van dunne plaat t.b.v. gat-puntlassen.

Tang met geharde bekken waarmee u een overlapping kan maken in plaat tot 1 mm dikte, ook kunnen er gaatjes van 6 mm mee geponst worden. Dit is een perfect stuk gereedschap voor de auto restauratie.

- Met de tang kunt u een klein verzet plooiën en een gat ponsen.
- Deze plaat schuif je dan onder de bestaande plaat.
- U last het gat terug toe waardoor beide platen mooi aan elkaar hangen

**FOR 904M5****Ruit demontage set****Set outils pour pare-brise**

Gereedschapset waarmee op een professionele wijze voertuigruiten kunnen worden gedemonteerd.

De set bestaat uit een hoogwaardig metalen doorvoerpen die voorzien is van een ergonomisch gevormd kunststof handvat. Daarnaast heeft de doorvoerpen een speciaal gevormde inkeping die ervoor zorgt dat de RVS snijdraad op zijn plaats blijft als deze door de kit gevoerd wordt. Naast de doorvoerpen bestaat de set uit een tweetal handvaten die vervaardigd zijn uit een zeer hoogwaardig kunststof. Met deze handvaten is het mogelijk om de meegeleverde RVS snijdraad (21 meter) met weinig kracht en zeer vloeiend door de kit te trekken waardoor de voertuigruit op zeer eenvoudige manier kan worden gedemonteerd.

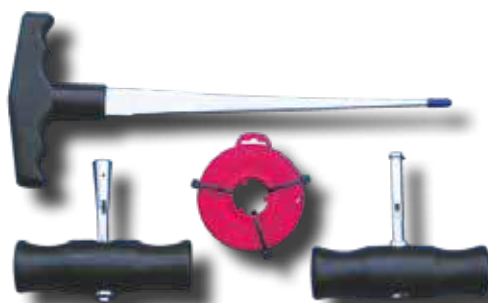
**FOR 905M5****Ruitenwisserarm demonteerset 5dlg****Coffret d'extracteur bras d'essuie-glace**

Onmisbaar voor snelle en zorgvuldige demontage van alle gangbare ruitenwisserarmen.

Ideaal bij gecorrodeerde en vastzittende ruitenwisserarmen.

- Universeel inzetbaar
- Met slagtrekker en uitdruk adapter
- Alternatieve demontage mogelijk middels 2 armige trekker

**FOR 65701****Houder voor carrosserievijl verstelbaar**

- voor vijlenbladen van 350 mm

Support pour lime de carrosserie**FOR 6571409****Carrosserie vijl 12 tanden per inch****Lime de carrosserie**

Koevoeten

FOR 687400H

**Koevoet -breekijzer met gebogen bek & punt
Levier 400 mmL**

Koevoet voor het oplichten van cilinderkoppen, afnemen van tandwielen, losmaken van vastgeroeste delen, in- en uitbouw van kogel-lagers, .



FOR 904U5

**Hevel en koevoetset 4 delig
Set de levers 4 pcs**

- 200 - 300 - 450 - 600 mm



FOR 904U6

**Koevoetset met klauw en punt 4 delig
Set de 4 levers**

- 150 - 300 - 400 - 500 mm



FOR 687910A

Extra groot breekijzer 910mmL**Levier 910mm**

Zeer robuust, groot breekijzer voor het zware werk. Handvat is zuurbestendig en voorzien van een metalen slagkop. Lengte 910 mm.



FOR 904U2

**Hevel en koevoetset heavy duty 4 delig
Set de 4 levers à lame traversante**

- 930 mm recht
- 930 mm 30°
- 690 mm 75°
- 690 mm 90°



FOR 68755

**Verstelbare telescopische koevoet
Pied de biche télescopique**

- Min lengte : 42 cm
- Max lengte : 55.5cm
- moment : 35



FOR 68790

**Verstelbare telescopische koevoet
Pied de biche télescopique**

- Min lengte : 65.5 cm
- Max lengte : 90.5cm
- moment : 50



Voor het verwijderen en afstellen van afdichtingen, lagers en verdelstukken, evenals aandrijfassen, assen en brandstofinjectors. De koevoet is voorzien van een punt en klauw voor vele toepassingen. De koevoet kan eenvoudig worden uitgeschoven via een drukknoop in de handgreep.

Magneten

FOR 88902

Telescopische magneet

- lengte : 135 mm - 65 mm
- cap magneet 1.6kg

Pick up magnétique avec aimant fort

- longuer : 135 mm - 65 mm
- cap aimant : 1.6kg



FOR 61702

Flexibele magneet 5.0 mm 400 mm L**totale lengte : 510 mm**

- magneet cap. 0.7kg

Aiment sur flexible

FOR 61701

Flexibele magneet 8.5 mm 440 mm L

- totale lengte : 535 mm
- magneet cap. 1.6kg

Aiment sur flexible

FOR 617

Telescopische magneet met spiegel**Mirroiir télescópique avec tête ronde**

Spiegel uit resistent mineraalglas

360° draaibaar Ø 40 mm

Telescoopgreep, verstelbaar van 130 tot 640 mm

Resistent tegen olie, vet en remvloeistof

Met pocket-clip en krasnaald voor markering of reinigen



FOR 617L

3 in 1 Flexibele LED inspectie lamp met magneet en spiegel, een handig hulpmiddel bij montagewerkzaamheden. Kan door de flexibele zwanenhals in iedere positie worden gebogen.

- Lengte 455 mm
- Diameter lamp 8.5 mm
- Magneet 1.6 Kg
- Spiegel 25 x 50 mm

Lampe inspection flexible avec aimant et miroir

FOR 88001

Magneetschaal dia 150 mm**Plateau magnétiques 150 mm**

FOR 88004

Magneetschaal 293X270mm**Plateau magnétiques**

FOR 88013

Magneet pick up zeer veelzijdig en handig hulpmiddel om metalen onderdelen op te pakken. Door aan de hendel te trekken laat het materiaal los.

Aiment pick up 400mmL, 6.36kg



FOR 88011

Magneet pick up 680 mmL

Aiment pick up 680 mmL

- cap. 3.63kg



FOR 88801

Beschermhoes met 4 zakken & magnetische strips
1100x560 mm

Housse protection magnetique 1100x560 mm

- avec 4 pochettes



FOR G81

Zetelbeschermhoes

Protection de siège

- 140 mmx 70 mm



FOR 63201

Gereedschapshouder

Rail pour outillage







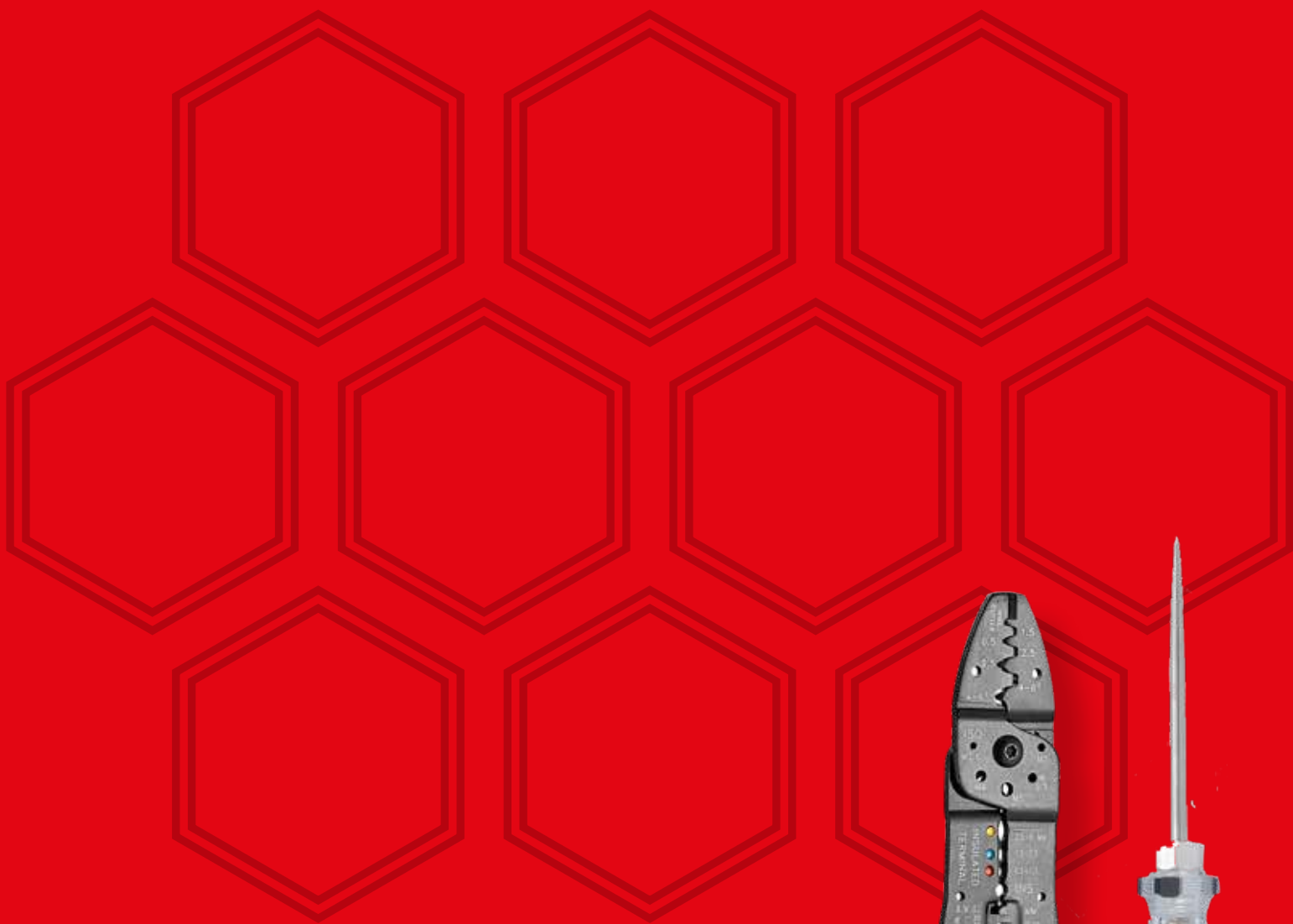

ELECTRICITEIT

ÉLECTRICITÉ



	Electriciteit	312
	Tangen 1000 V	315
	Tangen	316
	Ledlampen	319
	Booster	321

1000v

FOR 3313

Assortiment 3/8" 1000v
Assortiment 1000v 3/8"

6903180	universele tang, pince universelles 180 mm
6904160	lange bektang, pince à becs long 160 mm
6905160	zijknijptang, pince coupante 160 mm
713024N	platte schroevendraaier 2.4 mm
71304N	platte schroevendraaier 4 mm
713055N	platte schroevendraaier 5.5 mm
7112N	PH2
7111N	PH1
88401	testlamp
82907	steekring 7 mm - clé mixte
82908	steekring 8 mm - clé mixte
82910	steekring 10 mm - clé mixte
82912	steekring 12 mm - clé mixte
82914	steekring 14 mm - clé mixte
8043150n	verlengstuk 150 mm - rallonge
8043250N	verlengstuk 250 mm rallonge
802320n	ratel 3/8 - cliquet
53906N tot 53919N	doppen 6 tot 19 mm



FOR F2182

Foam 10217 serie assortiment 1000v
Assortiment 1000v foam

711N0	ph0 (60 mm L)
711N1	ph1 (80 mm L)
711N2	ph2 (100 mm L)
711N3	ph3 (150 mm L)
713N025	2.5 mm (75 mm L)
713N03	3 mm (100 mm L)
713N035	3.5 mm (100 mm L)
713N04	4 mm (100 mm L)
713N055	5.5 mm (125 mm L)
713N065	6.5 mm (150 mm L)
713N08	8 mm (175 mm L)
6903180	kombinatietang 180 mm L, pince universelle
6904200	lange bektang 200 mm L, pince à becs long
6911200	kniptang 200 mm L, pince coupante
6912160	striptang 160 mm L, pince à sertir
6909250	kabel snijder 250 mm
6806	striptang, pince a sertir
88408	Voltage tester 6-400v ac



FOR T50410

TC module 4 tangen 1000v

TC module 4 pinces 1000v

6903180	universele tang, pince universelles 180 mm
6904160	lange bektang, pince à becs long 160 mm
6911200	zijknijptang, pince coupante 200 mm
6912160	striptang, pince à dénuder 160 mm



FOR 2125

FOR 2126 pozidriv

Geïsoleerde schroevendraaierset 12 delig

Jeu de 12 tournevis 1000v

713N024, 713N03	2,4 (75 mm L) 3 (100 mm L)
713N035, 713N04	3,5 (100 mm L) 4 (100 mm L)
713N055, 713N065	5,5 (125 mm L) 6,5 (150 mm L)
713N08	8 (175 mm L)
711N0, 711N1	PH0 (60 mm L) PH1 (80 mm L)
711N2, 711N3	PH2 (100 mm L) PH3 (150 mm L)
2125P1	circuit tester



FOR T20712

TC module geïsoleerde schroevendraaierset 7 delig

TC module 7 tournevis 1000v

711N1, 711N2	PH1 (80 mm L) PH2 (100 mm L)
713N03	3 mm (100 mm L)
713N04	4 mm (100 mm L)
713N055	5.5 mm (125 mm L)
713N065	6.5 mm (150 mm L)
2125	circuit tester



FOR T20715

TC module geïsoleerde schroevendraaierset 7 delig

TC module 7 tournevis 1000v

711N1, 711N2	PH1 (80 mm L) PH2 (100 mm L)
713N03	3 mm (100 mm L)
713N04	4 mm (100 mm L)
713N055	5.5 mm (125 mm L)
713N065	6.5 mm (150 mm L)



FOR 20916

Geïsoleerde schroevendraaierset 9 delig

Jeu de 9 tournevis 1000v

713N024, 713N03	2,4 (75 mm L) 3 (100 mm L)
713N035, 713N04	3,5 (100 mm L) 4 (100 mm L)
713N055, 713N065	5,5 (125 mm L) 6,5 (150 mm L)
711N1, 711N2	PH1 (80 mm L) PH2 (100 mm L)
88401	circuit tester





1000v

Art.nr	mm	L mm
FOR 713N025	2.4 mm	75
FOR 713N03	3 mm	100
FOR 713N035	3.5 mm	100
FOR 713N04	4 mm	100
FOR 713N055	5.5 mm	125
FOR 713N065	6.5 mm	150
FOR 713N08	8 mm	175

FOR 711N0	PH0	60
FOR 711N1	PH1	80
FOR 711N2	PH2	100
FOR 711N3	PH3	150

FOR 712N0	PZ0	60
FOR 712N1	PZ1	80
FOR 712N2	PZ2	100
FOR 712N3	PZ3	150



FOR 5048

Module 4 kabelschoentangen Module 4 pinces à sertir

6801	kabelschoentang vr geïsoleerde kabelschoenen
6802	niet geïsoleerde kabelschoenen
6803	niet geïsoleerde kabelschoenen
6804	striptang, pince à dénuder



FOR 68013

Ratel kabelschoenkrimptang 7 dlg Set pince à sertir automatique 7pcs

- Kabelschoentang
- 4x Losse mondstuk
- Draad stripper
- Inbussleutel
- 6x Plastic bakje



FOR 54111

Module 411 delig bindtang met kabelbinders Module 411 pcs pince à dénuder incl strips

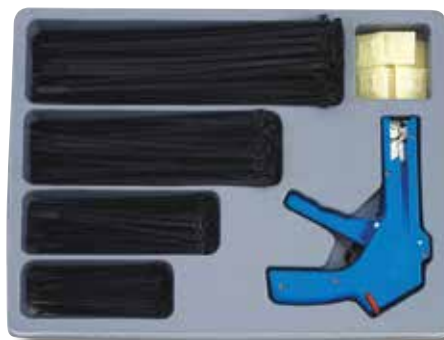

Tangen 1000v - Pincés

Lange bektang
Pince à becs long



Art. nr.		mm
FOR 6904160	1000v	160
FOR 6904200	1000v	200

Kniptang
Pince coupante



Art. nr.		mm
FOR 6905160	1000v	160 mm
FOR 6911200	1000V	200 mm

Universele tang
Pince universelle



Art. nr.		mm
FOR 6903180	1000v	180 mm

Striptang
Pince à dénuder



Art. nr.		mm
FOR 6912160	1000v	160 mm

Buigtang ronde bekken
Pince à becs ronds



Art. nr.		mm
FOR 6908160	1000v	160 mm

Waterpomptang
Pince multiprise



Art. nr.		mm
FOR 6907250	1000v	250 mm

Kabel snijmes geïsoleerd
Couteau isolée 1000v



Art. nr.		mm
FOR 83001	1000v	

Kabel snijmes gebogen geïsoleerd
Couteau isolée 1000v



Art. nr.		mm
FOR 83002	1000v	

Tangen - Pinces

Kabelschoentang, voor geïsoleerde kabelschoenen

Pince à sertir, pour cosses isolées

Bereik: 22-10 AWG (0.5-6 mm² DIN)



Art. nr.	mm	mm
FOR 6801	22-10AWG 0.5-6mm DIN	233 mm

Kabelschoentang voor niet geïsoleerde kabelschoenen

Pince à sertir, pour cosses non-isolées



Art. nr.	mm	mm
FOR 6802	0.5,0.75,1.0,1.5,2.5,4	233 mm

Kabelschoentang voor niet geïsoleerde kabelschoenen

Pince à sertir pour cosses non-isolées



Art. nr.	mm	mm
FOR 6803	0.5-1,1.1-2.5,4-6	233

Striptang

Pince à dénuder frontale autorégable



Art. nr.	mm	mm
FOR 6804	0.2 tot 3.5 mm	178 mm

Krimptang voor coax, BNC & TNC

Pince à sertissage pour COAX, BNC & TNC



Art. nr.	mm	mm
FOR 6807	RG58.RG 59/62	233

Automatische striptang

Pince à dénuder



Art. nr.	mm	mm
FOR 6805A		210L

Kabelschoentang

Pince à sertir



Art. nr.	mm	mm
FOR 6806		245L

Electriciteit / Électricité

FOR 88407

Spanningszoeker contactloos AC100 - 600V
Testeur de circuit



FOR 88401

Stroomtester 110 -250V AC
Testeur de circuit



FOR 88403

Spanningstester 110-250V AC
Testeur de circuit



FOR 88423A

Stroomtester 6-24v
Testeur de circuit 6-24v



FOR 88425

Stroomtester 3.28V
Testeur de circuit 3-28v



FOR 88431

Stroomtester 6-12-24v
Testeur de circuit 6-12-24v



FOR 88408

Universele elektronische tweepolige spannings tester
6-400V AC/DC met 7traps LED 6V-12V-24V-50V-120V-
220V-400V
Testeur de tension 6-400v AC/DC



FOR 88426

Multi tester , alternator controle , startcontrole en
accutester 12v met magneet
Testeur simple pour batteries 12v et alternateurs avec
aimant



FOR 88427

Spanningszoeker 3 -48 volt
Testeur de circuit 3-48volt



FOR 88443

Digitale stroomtester 12-24volt
Testeur de circuit digital professionnel 12-24 volt



FOR 918C1

Radio verwijderset 18 delig Set de demontage pour le radio 18 pcs

Geschikt voor : VW, Ford, Audi, Grundig, Blaupunkt, BMW, Becker, Mercedes, Porsche, Opel, Skoda



FOR 912C1

Stekkertrekker 12 delig Set de déconnecteurs de fiche 12 pcs

- Ford, BMW, Mercedes, Opel, VW, Fiat, MAN, Saab, Renault, Porsche, PSA, Skoda, Audi, Mazda, Toyota



FOR 990C1

Automotive kabeltestset Kit de sondes de test automobile

Uitgebreide set meetsnoeren en onderdelen geschikt voor het testen, opsporing en onderzoek van automotive elektronische schakelingen. Set bevat standaard 4 mm stekkers, geschikt voor gebruik met de meeste diagnostische multimeters en testapparatuur. Geleverd in een overzichtelijke koffer voor snelle locatie van de benodigde onderdelen.

Ce kit complet de sondes de test est conçu pour contrôler, isoler et évaluer les circuits électriques des véhicules. Le kit comprend les prises et connectiques standards de 4mm adaptés pour une utilisation avec des multimètres et d'autres appareils de test. Chaque sonde de test a sa place dans le coffret pour trouver facilement la sonde requise.



FOR 902C1

Doorsteekpennen Paire de pique-fils pour prive de tension

Geschikt voor Ø1.5 - Ø4.5mm
Voltage: 0 - 30V

Max 5A



Led lampen - Lampes à LED

FOR 68611

- Ultra dunne COB LED lamp voor inspectie van krappe ruimtes of verlichting van een werkgebied zoals motorruim of een wielkast.
 - Deze krachtige COB LED lamp geeft enorm veel licht tot 935 Lumen en is voorzien van een sterke magneet onder aan de handgreep.
 - De magneet is gemonteerd in een vastelbaar kogelgewricht waardoor de lamp 360° draaibaar is.
 - Handig om te bevestigen aan bv de binnenzijde van de motorkap of elders aan de carrosserie.
 - De lichtintensiteit kan traploos worden ingesteld door een draaiknop aan de handgreep.
 - De lamp is oplaadbaar via de meegeleverde 220v adapter of via de 12v USB aansluiting.
 - Li-on batterij 3.7v - 2200mAh (3.5uur laden voor 2.5 uur verlichting)
- Baladeuse rechargeable munie de la technologie "LED COB": puissance élevée, haute efficacité. Nouvelle technologie LED COB rechargeable permettant une capacité d'éclairage optimale. Grande luminosité puissance maximale 15W, 410 Lumens!! Corps extra plate, permet d'éclairer dans des zones confinées difficiles d'accès.



FOR 68612

COB LED Pen licht 5w

- Lamp type: COB LED
- Magneet: Ja
- Lichtintensiteit: 100 Lumen
- Afm. 165x25x35 mm
- Batterij type: 3 x 1.5 V AAA (meegeleverd)



FOR 68602

Flexibele LED lamp met magnetische voet



LED ST-3463

LED werklicht met zoekfunctie

- 3 leds
- telescopische lengte 0.5m
- flexibele hals
- magnetisch
- 12p ctn/48

LED lampe stylo

- 3 leds
- telescopique longueur 0.5m
- magnetique



LED 10-113

LED werklicht

- 24 leds
- display box 12 pcs
- met magneet



FOR 9C2005

Accudrager

Poignée porte batterie automobile

- Het zelfklemmend mechanisme en de rubberse pads zorgen voor de benodigde grip en een veilige lift.
- De ideale hulp voor het gemakkelijk van bovenaf verwijderen van accu's
- Met 1 hand te bedienen
- Cette poignée de transport de batterie résout tous les problèmes. Transporter une batterie automobile est toujours compliqué. Son poids important fait qu'il est difficile de la prendre à deux mains et de la porter devant soi.
- Votre dos supporte alors un effort anormal qui devient rapidement pénible. De plus, une batterie est souvent recouverte de projections d'acide qui vont se déposer sur vos doigts ou sur vos vêtements sur lesquels vous retrouverez des trous après le prochain lavage.
- Cette poignée batterie est constitué de deux croisillons avec des patins grip caoutchouc qui une fois posés de chaque côté de la batterie vont naturellement se rapprocher et se serrer en levant la batterie. Une poignée ergonomique avec un revêtement caoutchouc permettra un portage naturel et confortable. Cette poignée de transport de batterie résout tous les problèmes;
- Vous enlevez votre batterie de son logement dans le compartiment moteur, la transportez et la remettez en place sans effort, sans vous blesser, et sans contact avec l'acide présent sur les côtés ou le dessus.
- Largeur de serrage: 110 mm à 180 mm
- Poids max. 35 Kg



FOR 9C2010

Connector verwijderaar VAG

Extracteur pour connecteurs à poussoir VAG

- Om individuele stekkers met sluitmechanisme uit combi-stekkers los te maken zonder ze te beschadigen. Deze stekkers bevinden zich op de MAF sensoren, ontstekingen, mist- en koplampen, waterpas en richting sensoren enz. Met zwart kunststof handvat. Geschikt voor Audi, Porsche, Seat, Skoda en Volkswagen.
- L'outil permet de fournir juste le bon levier pour permettre d'extraire ces connecteurs sans les endommager. Ces connecteurs sont fréquemment utilisés sur la gamme VAG pour les sondes d'admission d'air, les bobines d'allumage, les feux anti brouillard, les sondes de niveaux, etc. Convient par Audi, Porsche, Seat, Skoda et Volkswagen.



Boosters 12v / 12-24v

CAR SB016

Startbooster 12 volt
Demarreur 12 volt

Voltage	12v
Boost rate	3500A
Internal battery- tension batterie	12V-23Ah
Startstroomsterkte-courage de démarrage	1150A
Netto gewicht - poids net	9.2kg
Electronische automatische oplader	12V 1.5A
Automatische oplader	ja
lengte kabels - câble	90cm
koper kabels - câbles	28 mm ²



CAR C16-3000

Professional Start booster met condensator 12v
Démarreur à condensateur 12volt

Voltage	12V
Piekintensiteit/intensité de pointe	9000A
Startintensiteit/intensité de démarrage	1800A
veiligheidszekering	500A
laadtijd met batterij/temps de charge	10 sec tot 2 min. bij draaiende motor
laadtijd met oplader	6-7 uur met adapter
Netto gewicht	9.5kg
oplader	12V 50 Hz
Alarm buzzer	ja
automatische acculader	ja
12v accessoire aansluiting	ja
aan/uit schakelaar	ja
lengte kabels	160cm
dikte kabels	50mm ²



CAR CB50S

Batterijlader

- Rated input : 230

Rated cap. 480/730

- Voltage : 12/24
- Rated current : 25
- Boost current : 30

Ref. cap. Ah15h : 120/320

- gewicht : 15
- 370x250x250



CAR 61220

Acculader druppellader 6/12v 2.0A
3 adapters

CAR 1238

Acculader druppellader 12v 3.8A
3 adapters

CAR 122470





Acculader druppellader 12/24V 7.0A
3 adapters



PNEUMATIC TOOLS

OUTILLAGE PNEUMATIQUE



	Verfspuiten	324
	Pneumatic tools	326
	Handschoenen	328
	Kompressors	327
	Bankschroeven	329

Verfspuiten - Pistolets de peinture

VERF FR107 1.4

Verfspuit met plastic bovenbeker 1.4 mm 600cc
Pistolet à godet supérieur 1.4 mm 600cc

VERF FR107 1.7

Verfspuit met plastic bovenbeker 1.7 mm 600cc
Pistolet à godet supérieur 1.7 mm 600cc

VERF FR107 2.0

Verfspuit met plastic bovenbeker 2.0 mm 600cc
Pistolet à godet supérieur 2.0 mm 600cc

VERF FR107 2.5

Verfspuit met bovenbeker 2.5 mm 600cc
Pistolet à godet supérieur 2.5 mm 600cc

- Werkdruk : 2-5 bar
- Luchtverbruik : 160-300Lmin
- Gewicht : 750gr

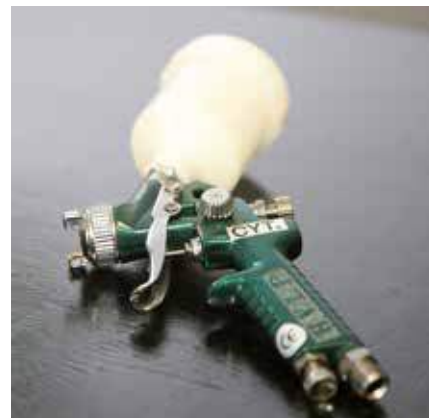

VERF CY-1827

Verfspuit met bovenbeker 1.7 mm
Pistolet à godet supérieur 1.7 mm

- kunststof beker 600cc
- werkdruk : 4bar
- Luchtdrukverbruik : 400L/min
- gewicht : 600gr



VERF SJ101A

Star verfspuit met onderbeker

- luchtverbruik 175-300 l/m druk 3 kg
- luchtregeling 1.8 mm - tête 1.8 mm

Star pistolet de peinture à godet inférieur

Art. Nr.	
VERF ON SJ101K	Naald sproeierset 1.8 mm
VERF ON SJ101AR	O ringen set



VERF FR206 0.8

Bovenbeker HVLP 250cc

- spuitopening 0.8 mm - tête 0.8 mm

Pistolet à godet supérieur HVLP 250cc



VERF FR206 1

Bovenbeker HVLP 250cc

- spuitopening 1.0 mm - tête 1.0 mm

Pistolet à godet supérieur HVLP 250cc

- Professioneel verfspuitpistool voor perfecte lakresultaten in de automobielsector.
- Precies, gelijkmatig en optimaal verf aanbrengen.
- Met lucht- en verfhoeveelheidsregeling.
- Met High Volume Low Pressure: lage verstuivingsdruk vermindert de verspreiding van de spuitnevel: aanbrengen van meer materiaal bij minder lakverbruik.
- Traploos instelbaar voor ronde en brede straal.
- Werkdruk : 2-3 Bar
- Luchtverbruik : 100-170 l/min
- Kunststof voorraadbeker 600 ml
- Roestvrij stalen naald

VERF FR906 1.4

Verfspuit HVLP bovenbeker 1.4 mm 600cc

Pistolet à godet supérieur 1.4 mm 600cc

VERF FR906 1.7

Verfspuit HVLP bovenbeker 1.7 mm 600cc

VERF FR906 2.0

Verfspuit HVLP bovenbeker 2 mm 600cc



Onderdelen - Assecoires

Art. Nr.	
VERF ON FR107 1.4	Naald sproeierset 1.4 mm
VERF ON FR107 1.7	Naald sproeierset 1.7 mm
VERF ON FR107 2.5	Naald sproeierset 2.5 mm
VERF ON FR906 1.4	Naald sproeierset 1.4 mm
VERF ON FR906 1.7	Naald sproeierset 1.7 mm
VERF ON H827W R	o ringen set
VERF ON FR107 28	bovenbeker 600cc



Pneumatic tools

FOR 9U0202

Blaaspistool 150 mm
Soufflette 150 mm



FOR 9U0203

Blaaspistool 300 mm
Soufflette 300 mm



FOR 825411

Korte slagmoersleutel 1/2"

- 9000tm 677Nm
- gewicht 1.3kg
- lengte : 109 mm

1/2" Clé à chocs réversible compacte



PNE CY2855

Slagmoersleutel 1/2"

- 7000 t/m 678nw £

Clé à chocs 1/2"



PNE CY3260

Slagmoersleutel 1/2" composite

- Max torq 1350 Nw
- Working torque 70-1100 Nw
- dubbele hamer

Clé à chocs réversible 1/2" en materiau composite



PNE CY222

Slagmoersleutel 3/4"

- 6500 t/m 750 ft/lbs

Clé à chocs 3/4"



PNE CY3266

Slagmoersleutel 3/4" composite

- Max torq 1450Nw
- working torque 70-1200 Nw
- dubbele hamer

3/4" Clé à chocs réversible en matériau composite



FOR 9U0201**Persluchthaspel 15 meter
Enrouler à air 15 mètre**

- 8mm x12.0 mm
- max 20 bar
- afm 330x150x410 mm

**FOR 9U0201A****Persluchthaspel 12 meter
Enrouler à air 12 mètre**

- 10mmx13.5 mm
- max 20 bar
- afm 330x150x410 mm

**KOM KA25200****Kompressor 25L**

- 220 L/min aangezogen/min aspiré
- 8 bar
- 2pk monofasig 230V/2cv monofasé
- 1 cyl kop 2800tr /min / Tête 1 cyl
- 25 L ketelinhoud / 25 L de réservoir
- L 610 x B270 x H590 - 25kg 76dB

**KOM 050240****Kompressor 50L**

- 240 L/min aangezogen / min aspiré
- 8 bar
- 2pk monofasig 230V/ 2cv monofasé
- 1 cil kop 900 tr/min / Tête 1cyl
- 50 L ketelinhoud / 50 L de réservoir
- L 850 x B400 x H740 - 54kg 72dB

**KOM 100400****Kompressor 100L**

- 400 L/min aangezogen / min aspiré
- 8 bar
- 3pk monofasig 230V/ 3cv monofasé
- 2 cil kop 800 tr/min / Tête 2 cyl
- 100 L ketelinhoud / 100 L de réservoir
- L 1200 x B450 x H830 - 65kg 72dB



Handschoenen - gants

HAN D251

Driver handschoen wit + blauw schaapsnappa leder + katoenen rug

- Verpakking :10/200 per karton
- maat 9 of 10

Gants driver blanc + blue (cuir de chèvre)



HAN 3-1260

Latex werkhandschoen, rode polyester met zwarte latex foamcoating op de handpalm

Gants latex



Bankschroeven - Etaux

FOR 6540204A

Bankschroef 100 mm
Etau 100 mm

FOR 6540205A

Bankschroef 125 mm
Etau 125 mm

FOR 6540206A

Bankschroef 150 mm
Etau 150 mm

FOR 6540208A

Bankschroef 200 mm
Etau 200 mm



FORCE
PROFESSIONAL TOOLS

DIVERSEN

DIVERS





	Kledij	323
	Display	333
	Catalogi	337

Kledij - vêtements

FOR G11

**Petje Force
Casquette**



FOR G16

**Polo Force
maten S-M-L-XL**



FOR FLEECE

**Fleece Force
Maten L-XL**



Stickers - Autocollants

Art. Nr.	
FOR LOGO12	12 cm lang
FOR LOGO30	30 cm lang
FOR LOGO50	50 cm lang



Display

FOR 2751

Schroevendraaierset 75 delig
Jeu de tournevis 75 pcs

Art. Nr.	
7110-7111-7113	PH0 (60 mm L) PH1 (80 mm L) PH3 (150 mm L)
7111S-7112S	PH1 (25 mm L) PH2 (25 mm L)
713 03....08	3 mm (75 mm L) 3.5 mm (100 mm L) 4 mm (100 mm L) 5.5 mm (125 mm L) 6.5 mm (150 mm L) 8 mm (175 mm L)
713055S-713065S	5.5 mm (25 mm L) 6.5 mm (25 mm L)
	5 schroevendraaiers van ieder
7112	PH2 (100 mm L) 10 stuks



FOR 2752

Schroevendraaierset 75 delig
Jeu de tournevis 75 pcs

Art. Nr.	
7120-7121-7123	PZ0 (60 mm L) PZ1 (80 mm L) PZ3 (150 mm L)
7121S-7122S	PZ1 (25 mm L) PZ2 (25 mm L)
713 03....08	3 mm (75 mm L) 3.5 mm (100 mm L) 4 mm (100 mm L) 5.5 mm (125 mm L) 6.5 mm (150 mm L) 8 mm (175 mm L)
713055S-713065S	5.5 mm (25 mm L) 6.5 mm (25 mm L)
	5 schroevendraaiers van ieder
7122	PZ2 (100 mm L) 10 stuks



Hangers voor doppen - crochet pour douilles

Art. Nr.	
FOR 8162	1/4"
FOR 8163	3/8"
FOR 8164	1/2"
FOR 8166	3/4"



Hangers voor ratels - crochet pour cliquets

Art. Nr.	
FOR PI8022	1/4"
FOR PI8023	3/8"
FOR PI8024	1/2"



Hangers voor T hendel - crochet pour manche

Art. Nr.	
FOR PI8032	1/4"
FOR PI8033	3/8"
FOR PI8034	1/2"



FOR 50121

Doppenkast 3 verdiepingen
Armoire pour douilles



FOR 50121A429

Doppenkast 429 delig
Jeu de douilles 429 pcs

Art. Nr.		1/4"
525 04....14	6 kant - 6 pans 10 st/ pcs	4-4.5-5-5.5-6-7-8-9-10-11-12-13-14 mm
		3/8"
535 08....19	10 stuks / pcs	8-10-12-13-14 mm
	9 stuks/ pcs	17-19 mm
		1/2"
545 08....32	10 stuks	8 - 10-11-12-13-14-15-16-17-18-19-20-22-23-24 mm
	9 stuks	25-26-27 mm
	8 stuks	28-30-32 mm
	20 stuks	21 mm



FOR 50121A408

Doppenkast 408 delig engelse maten
Jeu de douilles en pouces 408 pcs



FOR 50121B460

Doppenkast 460 delig torx - inbus Jeu de douilles 460 pcs torx - hex

Art. Nr.		1/4"
32432 03....08	10 st/ pcs	3-4-5-6-7-8 mm inbus-hex
32632 08....40	10 st/ pcs	T8-T10-T15-T20-T25-T27-T30-T40 torx
		1/2" inbus-hex
344055 07...12	10 st/ pcs	7-8-10-12 mm inbus-hex
34406514	10 st/ pcs	14 mm (65 mm L) inbus-hex
344070 17....19	10 st/ pcs	17-19 mm (70 mm L) inbus
344100 06....10	10 st/ pcs	6-8-10 (100 mm L) inbus
34410012	9 st/ pcs	12 mm (100 mm L)
346055 45....70	10st/ pcs	T45-T50-T55-T60-T70
		1/2" Torx
34607080	10st/ pcs	T80 (70 mm L)
346100 40	10st/ pcs	T40 (100 mm L)
346100 60...70	9st/ pcs	T60-T70 (100 mm L)
348055 06...14	10st/ pcs	M6-M8-M10-M12-M14
34810016T	10st/ pcs	M16 (100 mm L) magnetisch
348100 08....10	10st/ pcs	M8-M9-M10 (100 mm L)
348100 12....14	9st/ pcs	M12-M14 (100 mm L)
34810018	7st/ pcs	M18 (100 mm L)
34810016T	8st/ pcs	M16 (100 mm L) magnetisch



FOR 50121E275

Doppenkast 275 delig slagdoppen Jeu de douilles à choc 275 pcs

Art. Nr.		1/2"
445 10...41	10 stuks/ pcs	10-12-13-14-15-16-17-18-19-21-22 mm
	9 stuks/ pcs	24 mm
	8 stuks/ pcs	27 mm
	7 stuks/ pcs	30-32 mm
	6 stuks/ pcs	36 mm
	5 stuks/ pcs	41 mm
44585 1036	10 stuks/ pcs	10-12-13-14-15-16 mm
	8 stuks/ pcs	17-18-19 mm
	7 stuks/ pcs	21-22 mm
	6 stuks/ pcs	24 mm
	5 stuks/ pcs	27-30-32 mm
	4 stuks/ pcs	36 mm



FOR 10217BBS E

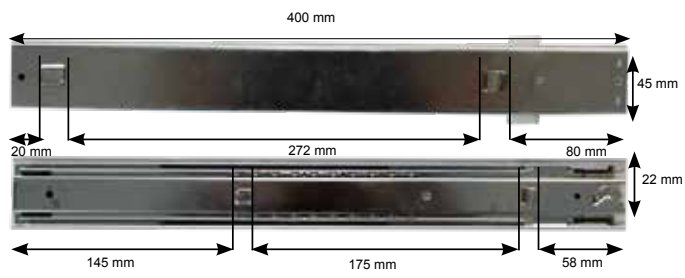

FOR 10318BBS F



Catalogi

ZA CAT 2023-2024

Algemene catalogus Zasco
Catalogue générale Zasco



FOR CAT V9

Algemene catalogus Force
Catalogue générale Force



FOR CAT V6

Catalogus Force Tool Storage V6

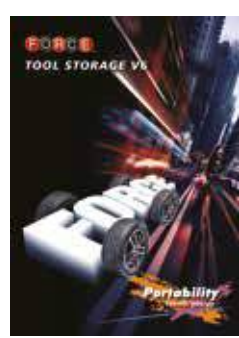

FOR CAT V4

Catalogus Force Auto Special Tools

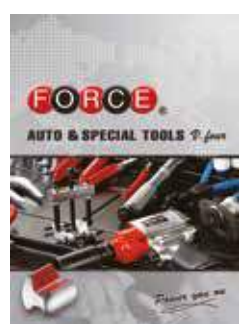

Index

1

FOR 121250	216
FOR 121251	216
FOR 121252	216
FOR 121253	216
FOR 122250	216
FOR 122251	216
FOR 122252	216
FOR 122253	216
FOR 1232503	216
FOR 1232504	216
FOR 1232505	216
FOR 12325055	216
FOR 12325065	216
FOR 1242503	216
FOR 1242504	216
FOR 1242505	216
FOR 1242506	216
FOR 1242507	216
FOR 1242508	216
FOR 1262504	216
FOR 1262505	216
FOR 1262506	216
FOR 1262507	216
FOR 1262508	216
FOR 1262509	216
FOR 1262510	216
FOR 1262515	216
FOR 1262520	216
FOR 1262525	216
FOR 1262527	216
FOR 1262530	216
FOR 1262540	216
FOR 1263008	216
FOR 1263009	216
FOR 1263010	216
FOR 1263015	216
FOR 1263020	216
FOR 1263025	216
FOR 1263027	216
FOR 1263030	216
FOR 1263040	216
FOR 1263045	216
FOR 1263050	216
FOR 1263055	216
FOR 1272508	216
FOR 1272509	216
FOR 1272510	216
FOR 1272515	216
FOR 1272520	216
FOR 1272525	216
FOR 1272527	216
FOR 1272530	216
FOR 1272535	216
FOR 1272540	216
FOR 151301	211
FOR 151302	211
FOR 151303	211
FOR 151304	211
FOR 151361	211
FOR 151362	211
FOR 151363	211
FOR 151364	211
FOR 151384	211
FOR 152301	211
FOR 152302	211
FOR 152303	211
FOR 152362	211
FOR 152363	211
FOR 1533008	211
FOR 1533010	211
FOR 1533609	211
FOR 1533611	211
FOR 1543005	211
FOR 1543006	211
FOR 1543007	211
FOR 1543008	211
FOR 1543010	211
FOR 1543012	211

FOR 1543014	211
FOR 1563010	211
FOR 1563015	211
FOR 1563020	211
FOR 1563025	211
FOR 1563027	211
FOR 1563030	211
FOR 1563040	211
FOR 1563045	211
FOR 1563050	211
FOR 1563055	211
FOR 1563060	211
FOR 1563530	211
FOR 1563540	211
FOR 1567020	211
FOR 1567025	211
FOR 1567030	211
FOR 1567040	211
FOR 1567045	211
FOR 1567050	211
FOR 1567055	211
FOR 1567060	211
FOR 1743004	220
FOR 1743005	220
FOR 1743006	220
FOR 1743007	220
FOR 1743008	220
FOR 1743010	220
FOR 1743012	220
FOR 1743014	220
FOR 1747504	220
FOR 1747505	220
FOR 1747506	220
FOR 1747507	220
FOR 1747508	220
FOR 1747510	220
FOR 1747512	220
FOR 17611555	220
FOR 17612040	220
FOR 17612050	220
FOR 17612055	220
FOR 1763020	220
FOR 1763025	220
FOR 1763027	220
FOR 1763030	220
FOR 1763040	220
FOR 1763045	220
FOR 1763050	220
FOR 1763055	220
FOR 1763060	220
FOR 1767520	220
FOR 1767525	220
FOR 1767527	220
FOR 1767530	220
FOR 1767540	220
FOR 1767545	220
FOR 1767550	220
FOR 1767555	220
FOR 1767560	220
FOR 1773010	221
FOR 1773015	221
FOR 1773020	221
FOR 1773025	221
FOR 1773027	221
FOR 1773030	221
FOR 1773040	221
FOR 1773045	221
FOR 1773050	221
FOR 1773055	221
FOR 1773060	221
FOR 1777510	221
FOR 1777515	221
FOR 1777520	221
FOR 1777525	221
FOR 1777530	221
FOR 1777540	221
FOR 1777545	221
FOR 1777550	221
FOR 1777555	221
FOR 1777560	221

FOR 1783005	221
FOR 1783006	221
FOR 1783008	221
FOR 1783010	221
FOR 1783012	221
FOR 1783014	221
FOR 1787505	221
FOR 1787506	221
FOR 1787508	221
FOR 1787510	221
FOR 1787512	221
FOR 1967560	220
FOR 1967570	220

2

FOR 2649014	162
FOR 2649016	162
FOR 2649017	162
FOR 2649019	162
FOR 2649022	162
FOR 2649024	162
FOR 2649027	162
FOR 2649030	162
FOR 2649032	162

3

FOR 321320	113
FOR 321321	113
FOR 321322	113
FOR 321323	113
FOR 322320	113
FOR 322321	113
FOR 322322	113
FOR 322323	113
FOR 3233204	113
FOR 32332055	113
FOR 32332065	113
FOR 3233207	113
FOR 32423.16	112
FOR 3243203	112
FOR 3243204	112
FOR 3243205	112
FOR 3243206	112
FOR 3243207	112
FOR 3243208	112
FOR 3243209	112
FOR 324321.4	112
FOR 324321.8	112
FOR 3243210	112
FOR 324323.8	112
FOR 324327.32	112
FOR 3263208	112
FOR 3263209	112
FOR 3263210	112
FOR 3263215	112
FOR 3263220	112
FOR 3263225	112
FOR 3263227	112
FOR 3263230	112
FOR 3263235	112
FOR 3263240	112
FOR 3273208	112
FOR 3273209	112
FOR 3273210	112
FOR 3273215	112
FOR 3273220	112
FOR 3273225	112
FOR 3273227	112
FOR 3273230	112
FOR 3273235	112
FOR 3273240	112
FOR 32F3210	112
FOR 32F3215	112
FOR 32F3220	112
FOR 32F3225	112
FOR 32F3227	112
FOR 32F3230	112
FOR 32F3240	112

FOR 33405003	123	FOR 34414010	143	FOR 34814008	142
FOR 33405004	123	FOR 34416006	143	FOR 34814010	142
FOR 33405005	123	FOR 34418005	143	FOR 34814012	142
FOR 33405006	123	FOR 34422006	143	FOR 34814014	142
FOR 33405007	123	FOR 34605520	141	FOR 34880008	142
FOR 33405008	123	FOR 34605525	141	FOR 34880008	263
FOR 33405009	123	FOR 34605527	141	FOR 34880010	142
FOR 33405010	123	FOR 34605530	141	FOR 34880010	263
FOR 33405012	123	FOR 34605535	141	FOR 34910005	144
FOR 33405055	123	FOR 34605540	141	FOR 34910006	144
FOR 3365008	123	FOR 34605545	141	FOR 34910007	144
FOR 3365010	123	FOR 34605547	141	FOR 34910008	144
FOR 3365015	123	FOR 34605550	141	FOR 34910009	144
FOR 3365020	123	FOR 34605555	141	FOR 34910010	144
FOR 3365025	123	FOR 34605560	141	FOR 34910012	144
FOR 3365027	123	FOR 34605570	141	FOR 34910013	144
FOR 3365030	123	FOR 34607080	141	FOR 34910014	144
FOR 3365040	123	FOR 346100100	141	FOR 34910016	144
FOR 3365045	123	FOR 34610020	141	FOR 34912009	144
FOR 3365050	123	FOR 34610025	141	FOR 36408017	148
FOR 3365055	123	FOR 34610027	141	FOR 36408019	148
FOR 3365060	123	FOR 34610030	141	FOR 36408022	148
FOR 3375008	123	FOR 34610040	141		
FOR 3375010	123	FOR 34610045	141	4	
FOR 3375015	123	FOR 34610050	141	FOR 4125105	166
FOR 3375020	123	FOR 34610055	141	FOR 44508	154
FOR 3375025	123	FOR 34610060	141	FOR 44509	154
FOR 3375027	123	FOR 34610070	141	FOR 44510	154
FOR 3375030	123	FOR 34610080	141	FOR 44511	154
FOR 3375040	123	FOR 34610090	141	FOR 44512	154
FOR 3375045	123	FOR 34611050R	141	FOR 44513	154
FOR 3375050	123	FOR 34612040	141	FOR 44514	154
FOR 3375055	123	FOR 34612045	141	FOR 44515017C	159
FOR 3375060	123	FOR 346140100	141	FOR 44515019C	159
FOR 3385005	123	FOR 34614045	141	FOR 44515021C	159
FOR 3385006	123	FOR 34614050	141	FOR 44515	154
FOR 3385008	123	FOR 34614055	141	FOR 44516	154
FOR 3385009	123	FOR 34614060	141	FOR 44517	154
FOR 3385010	123	FOR 34614070	141	FOR 44518	154
FOR 3385012	123	FOR 34705520	142	FOR 44519	154
FOR 33909006	123	FOR 34705527	142	FOR 44520	154
FOR 33909007	123	FOR 34705530	142	FOR 44521	154
FOR 33909008	123	FOR 34705540	142	FOR 44522	154
FOR 34405504	143	FOR 34705545	142	FOR 44523	154
FOR 34405505	143	FOR 34705550	142	FOR 44524	154
FOR 34405506	143	FOR 34705555	142	FOR 44525	154
FOR 34405507	143	FOR 34705560	142	FOR 44526	154
FOR 34405508	143	FOR 34705570	142	FOR 44527	154
FOR 34405509	143	FOR 34707080	142	FOR 44528	154
FOR 34405510	143	FOR 34710030	142	FOR 44529	154
FOR 34405512	143	FOR 34710040	142	FOR 44530	154
FOR 3440553.16	143	FOR 34710045	142	FOR 44531	154
FOR 3440553.4	143	FOR 34710050	142	FOR 44532	154
FOR 3440553.8	143	FOR 34710055	142	FOR 44533	154
FOR 3440555.16	143	FOR 34710060	142	FOR 44534	154
FOR 3440555.32	143	FOR 34710070	142	FOR 44535	154
FOR 3440555.8	143	FOR 34713030	142	FOR 44536	154
FOR 3440557.16	143	FOR 34714050	142	FOR 44538	154
FOR 3440557.32	143	FOR 34805505	142	FOR 44541	154
FOR 3440559.16	143	FOR 34805506	142	FOR 44546	154
FOR 34406514	143	FOR 34805508	142	FOR 4458508	156
FOR 34407017	143	FOR 34805509	142	FOR 4458509	156
FOR 34407019	143	FOR 34805510	142	FOR 4458510	156
FOR 34408008	143	FOR 34805512	142	FOR 4458511	156
FOR 34410005	143	FOR 34805514	142	FOR 4458512	156
FOR 34410006	143	FOR 34805514T	143	FOR 4458513	156
FOR 34410007	143	FOR 34805514T	263	FOR 4458514	156
FOR 34410008	143	FOR 34805516	142	FOR 4458515	156
FOR 34410009	143	FOR 34805516T	143	FOR 4458516	156
FOR 34410010	143	FOR 34805516T	263	FOR 4458517	156
FOR 34410011	143	FOR 34810005	142	FOR 4458517C	159
FOR 34410012	143	FOR 34810006	142	FOR 4458518	156
FOR 34411005	143	FOR 34810008	142	FOR 4458519	156
FOR 34411006	143	FOR 34810009	142	FOR 4458519C	159
FOR 34411007	143	FOR 348100100	142	FOR 4458520	156
FOR 34411008	143	FOR 34810010	142	FOR 4458521	156
FOR 34411010	143	FOR 34810012	142	FOR 4458521C	159
FOR 34411012	143	FOR 34810014	142	FOR 4458522	156
FOR 34411014	143	FOR 34810016	142	FOR 4458523	156
FOR 34411017	143	FOR 34810016T	143	FOR 4458524	156
FOR 34411019	143	FOR 34810016T	263	FOR 4458525	156
FOR 34412008	143	FOR 34810018	142	FOR 4458527	156
FOR 34414006	143	FOR 34812008	142	FOR 4458528	156
FOR 34414008	143	FOR 34812010	142		

FOR 5295013	111	FOR 54508	138	FOR 54616	141
FOR 52955	110	FOR 54509	138	FOR 54618	141
FOR 53506	121	FOR 5451.0	139	FOR 54620	141
FOR 53507	121	FOR 5451.1.16	139	FOR 54622	141
FOR 53508	121	FOR 5451.1.4	139	FOR 54624	141
FOR 53509	121	FOR 5451.1.8	139	FOR 5467710	141
FOR 5351.2	121	FOR 5451.2	139	FOR 5467711	141
FOR 5351.4	121	FOR 5451.3.16	139	FOR 5467712	141
FOR 53510	121	FOR 54510	138	FOR 5467714	141
FOR 53511.16	121	FOR 54511.16	139	FOR 5467716	141
FOR 53511	121	FOR 54511	138	FOR 5467718	141
FOR 53512	121	FOR 54512	138	FOR 5467720	141
FOR 53513.16	121	FOR 54513.16	139	FOR 5467722	141
FOR 53513	121	FOR 54513	138	FOR 5467724	141
FOR 53514	121	FOR 54514	138	FOR 54908	138
FOR 53515	121	FOR 54515.16	139	FOR 54910	138
FOR 53516	121	FOR 54515.32	139	FOR 54911	138
FOR 53517	121	FOR 54515	138	FOR 54912	138
FOR 53518	121	FOR 54516	138	FOR 54913	138
FOR 53519.32	121	FOR 54517	138	FOR 54914	138
FOR 53519	121	FOR 54518	138	FOR 54915	138
FOR 53520	121	FOR 54519.32	139	FOR 54916	138
FOR 53521	121	FOR 54519	138	FOR 54917	138
FOR 53522	121	FOR 54520	138	FOR 54918	138
FOR 53524	121	FOR 54521	138	FOR 54919	138
FOR 5353.4	121	FOR 54522	138	FOR 54920	138
FOR 5353.8	121	FOR 54523	138	FOR 54921	138
FOR 5355.16	121	FOR 54524	138	FOR 54922	138
FOR 5355.8	121	FOR 54525.32	139	FOR 54923	138
FOR 5356306	121	FOR 54525	138	FOR 54924	138
FOR 5356307	121	FOR 54526	138	FOR 54925	138
FOR 5356308	121	FOR 54527	138	FOR 54926	138
FOR 5356309	121	FOR 54528	138	FOR 54927	138
FOR 535631.2	121	FOR 54529	138	FOR 54928	138
FOR 5356310	121	FOR 5453.4	139	FOR 54929	138
FOR 5356311.16	121	FOR 5453.8	139	FOR 54930	138
FOR 5356311	121	FOR 54530	138	FOR 54932	138
FOR 5356312	121	FOR 54532	138	FOR 5497708	140
FOR 5356313.16	121	FOR 54534	138	FOR 5497709	140
FOR 5356313	121	FOR 54536	138	FOR 5497710	140
FOR 5356314	121	FOR 5455.8	139	FOR 5497711	140
FOR 5356315	121	FOR 5457.16	139	FOR 5497712	140
FOR 5356316	121	FOR 5457.8	139	FOR 5497713	140
FOR 5356317	121	FOR 5457708	140	FOR 5497714	140
FOR 5356318	121	FOR 5457709	140	FOR 5497715	140
FOR 5356319	121	FOR 545771.0	139	FOR 5497716	140
FOR 5356320	121	FOR 545771.1.16	139	FOR 5497717	140
FOR 5356321	121	FOR 5457710	140	FOR 5497718	140
FOR 5356322	121	FOR 5457711.16	139	FOR 5497719	140
FOR 535633.4	121	FOR 5457711	140	FOR 5497720	140
FOR 535633.8	121	FOR 5457712	140	FOR 5497721	140
FOR 535635.16	121	FOR 5457713.16	139	FOR 5497722	140
FOR 535635.8	121	FOR 5457713	140	FOR 5497723	140
FOR 535637.16	121	FOR 5457714	140	FOR 5497724	140
FOR 535637.8	121	FOR 5457715.16	139	FOR 5497725	140
FOR 535639.16	121	FOR 5457715	140	FOR 5497726	140
FOR 5357.16	121	FOR 5457716	140	FOR 5497727	140
FOR 5357.8	121	FOR 5457717	140	FOR 5497728	140
FOR 5359.16	121	FOR 5457718	140	FOR 5497729	140
FOR 53604	122	FOR 5457719	140	FOR 5497730	140
FOR 53605	122	FOR 5457720	140	FOR 5497732	140
FOR 53606	122	FOR 5457721	140	FOR 56519	148
FOR 53607	122	FOR 5457722	140	FOR 56521	148
FOR 53608	122	FOR 5457723	140	FOR 56522	148
FOR 53610	122	FOR 5457724	140	FOR 56523	148
FOR 53611	122	FOR 5457725	140	FOR 56524	148
FOR 53612	122	FOR 5457726	140	FOR 56526	148
FOR 53614	122	FOR 5457727	140	FOR 56527	148
FOR 53616	122	FOR 5457728	140	FOR 56528	148
FOR 53618	122	FOR 5457729	140	FOR 56529	148
FOR 53620	122	FOR 545773.4	139	FOR 56530	148
FOR 5365504	122	FOR 545773.8	139	FOR 56532	148
FOR 5365505	122	FOR 5457730	140	FOR 56533	148
FOR 5365506	122	FOR 5457732	140	FOR 56534	148
FOR 5365507	122	FOR 545775.8	139	FOR 56535	148
FOR 5366308	122	FOR 545777.16	139	FOR 56536	148
FOR 5366310	122	FOR 545777.8	139	FOR 56538	148
FOR 5366311	122	FOR 545779.16	139	FOR 56540	148
FOR 5366312	122	FOR 5459.16	139	FOR 56541	148
FOR 5366314	122	FOR 54608	141	FOR 56546	148
FOR 5366316	122	FOR 54610	141	FOR 56550	148
FOR 5366318	122	FOR 54611	141	FOR 56555	148
FOR 544771.2	139	FOR 54612	141	FOR 56560	148
FOR 545.16	139	FOR 54614	141	FOR 56919	148

FOR 7120A	206	FOR 71F40	208	FOR 7521415	185
FOR 7121A	206	FOR 72402	198	FOR 7521617	185
FOR 7121AS	206	FOR 724025	198	FOR 7521617S	185
FOR 7121M	209	FOR 72403	198	FOR 7521819	185
FOR 7122A	206	FOR 72404	198	FOR 7521922S	185
FOR 7122AS	206	FOR 72405	198	FOR 7522022	185
FOR 7122M	209	FOR 72406	198	FOR 7522122S	185
FOR 7123A	206	FOR 72407	198	FOR 7522123	185
FOR 7123M	209	FOR 72408	198	FOR 7522425S	185
FOR 7124M	209	FOR 72410	198	FOR 7522427	185
FOR 712N0	213	FOR 72502	198	FOR 75306	183
FOR 712N0	314	FOR 725025	198	FOR 75307	183
FOR 712N1	213	FOR 72503	198	FOR 75308	183
FOR 712N1	314	FOR 72504	198	FOR 75309	183
FOR 712N2	213	FOR 72505	198	FOR 75310	183
FOR 712N2	314	FOR 72506	198	FOR 75311	183
FOR 712N3	213	FOR 72507	198	FOR 75312	183
FOR 712N3	314	FOR 72508	198	FOR 75313	183
FOR 713035A	206	FOR 72510	198	FOR 75314	183
FOR 71303A	206	FOR 72606	199	FOR 75315	183
FOR 71304A	206	FOR 72607	199	FOR 75316	183
FOR 713055A	206	FOR 72608	199	FOR 75317	183
FOR 713055AS	206	FOR 72609	199	FOR 75318	183
FOR 713055M	209	FOR 72610	199	FOR 75319	183
FOR 713065A	206	FOR 72615	199	FOR 75322	183
FOR 713065AS	206	FOR 72620	199	FOR 7540607	178
FOR 713065M	209	FOR 72625	199	FOR 7540608S	178
FOR 71308A	206	FOR 72627	199	FOR 7540809	178
FOR 71308M	209	FOR 72630	199	FOR 7540810S	178
FOR 71310M	209	FOR 72640	199	FOR 7541011	178
FOR 71312M	209	FOR 72645	199	FOR 7541011S	178
FOR 71314M	209	FOR 72650	199	FOR 7541213	178
FOR 713N025	213	FOR 72655	199	FOR 7541314S	178
FOR 713N025	314	FOR 72706	199	FOR 7541415	178
FOR 713N03	213	FOR 72707	199	FOR 7541416S	178
FOR 713N03	314	FOR 72708	199	FOR 7541617	178
FOR 713N035	213	FOR 72709	199	FOR 7541617S	178
FOR 713N035	314	FOR 72710	199	FOR 7541719S	178
FOR 713N04	213	FOR 72715	199	FOR 7541819	178
FOR 713N04	314	FOR 72720	199	FOR 7542022	178
FOR 713N055	213	FOR 72725	199	FOR 7542122S	178
FOR 713N055	314	FOR 72727	199	FOR 7542123	178
FOR 713N065	213	FOR 72730	199	FOR 7542224	178
FOR 713N065	314	FOR 72740	199	FOR 7542425S	178
FOR 713N08	213	FOR 72745	199	FOR 7542427	178
FOR 713N08	314	FOR 72750	199	FOR 7542427S	178
FOR 71605A	208	FOR 74425004	187	FOR 7542528	178
FOR 71606A	208	FOR 74425005	187	FOR 7542932S	178
FOR 71607A	208	FOR 74425055	187	FOR 7543032	178
FOR 71608A	208	FOR 7442506	187	FOR 7543236	178
FOR 71609A	208	FOR 7442507	187	FOR 7543436	178
FOR 71610A	208	FOR 7442508	187	FOR 7543641	178
FOR 71615A	208	FOR 7442509	187	FOR 7544146	178
FOR 71620A	208	FOR 7442510	187	FOR 7544650	178
FOR 71625A	208	FOR 7442511	187	FOR 755.8	175
FOR 71627A	208	FOR 7442512	187	FOR 75504	172
FOR 71630010	208	FOR 7442513	187	FOR 75505	172
FOR 71630015	208	FOR 7442514	187	FOR 75506	172
FOR 71630020	208	FOR 7510810	184	FOR 75507	172
FOR 71630025	208	FOR 7510810S	184	FOR 75508	172
FOR 71630027	208	FOR 7510910	184	FOR 75508L	172
FOR 71630030	208	FOR 7511011	184	FOR 75509	172
FOR 71630040	208	FOR 7511011S	184	FOR 7551.0	175
FOR 71630045	208	FOR 7511012	184	FOR 7551.1.16	175
FOR 71630A	208	FOR 7511112S	184	FOR 7551.1.2	175
FOR 71640A	208	FOR 7511113	184	FOR 7551.1.4	175
FOR 71645A	208	FOR 7511214	184	FOR 7551.1.8	175
FOR 71706A	208	FOR 7511214S	184	FOR 7551.11.16	175
FOR 71707A	208	FOR 7511314	184	FOR 7551.2	175
FOR 71708A	208	FOR 7511417	184	FOR 7551.3.4	175
FOR 71710A	208	FOR 7511618	184	FOR 7551.3.8	175
FOR 71715A	208	FOR 7511619S	184	FOR 7551.4	175
FOR 71720A	208	FOR 7511719	184	FOR 7551.5.16	175
FOR 71725A	208	FOR 7511719S	184	FOR 7551.5.8	175
FOR 71727A	208	FOR 7511922	184	FOR 7551.7.16	175
FOR 71730A	208	FOR 7511922S	184	FOR 75510	172
FOR 71740A	208	FOR 7512427	184	FOR 75510L	172
FOR 71745A	208	FOR 7513032	184	FOR 75511.16	175
FOR 71F10	208	FOR 7520607	185	FOR 75511	172
FOR 71F15	208	FOR 7520809	185	FOR 75511L	172
FOR 71F20	208	FOR 7521011	185	FOR 75512	172
FOR 71F25	208	FOR 7521011S	185	FOR 75512L	172
FOR 71F27	208	FOR 7521213	185	FOR 75513.16	175
FOR 71F30	208	FOR 7521314S	185	FOR 75513	172

FOR 75513L	172	FOR 75714	176	FOR 76403	191
FOR 75514	172	FOR 75714F	176	FOR 76403L	191
FOR 75514L	172	FOR 75714R	176	FOR 76403T	197
FOR 75515.16	175	FOR 75715	176	FOR 76403XL	191
FOR 75515	172	FOR 75715F	176	FOR 76404	191
FOR 75515L	172	FOR 75715R	176	FOR 76404L	191
FOR 75516	172	FOR 75716	176	FOR 76404T	197
FOR 75516L	172	FOR 75716F	176	FOR 76404XL	191
FOR 75517	172	FOR 75716R	176	FOR 76405	191
FOR 75517L	172	FOR 75717	176	FOR 76405L	191
FOR 75518	172	FOR 75717F	176	FOR 76405T	197
FOR 75518L	172	FOR 75717R	176	FOR 76405XL	191
FOR 75519	172	FOR 75718	176	FOR 76406	191
FOR 75519L	172	FOR 75718F	176	FOR 76406L	191
FOR 75520	172	FOR 75718R	176	FOR 76406T	197
FOR 75521	172	FOR 75719	176	FOR 76406XL	191
FOR 75522	172	FOR 75719F	176	FOR 76407	191
FOR 75522L	172	FOR 75719R	176	FOR 76407L	191
FOR 75523	172	FOR 75720	176	FOR 76407T	197
FOR 75524	172	FOR 75721	176	FOR 76407XL	191
FOR 75524L	172	FOR 75722	176	FOR 76408	191
FOR 75525	172	FOR 75724	176	FOR 76408L	191
FOR 75526	172	FOR 75724R	176	FOR 76408T	197
FOR 75527	172	FOR 7590607	179	FOR 76408XL	191
FOR 75528	172	FOR 7590608S	179	FOR 76410	191
FOR 75529	172	FOR 7590809	179	FOR 76410L	191
FOR 7553.4	175	FOR 7591011	179	FOR 76410T	197
FOR 7553.8	175	FOR 7591011S	179	FOR 76410XL	191
FOR 75530	172	FOR 7591213	179	FOR 76411	191
FOR 75532	172	FOR 7591314S	179	FOR 76412	191
FOR 75533	172	FOR 7591415	179	FOR 76412XL	191
FOR 75534	172	FOR 7591617	179	FOR 76413	191
FOR 75535	172	FOR 7591617S	179	FOR 76413XL	191
FOR 75536	172	FOR 7591719S	179	FOR 76414	191
FOR 75538	172	FOR 7591819	179	FOR 76414L	191
FOR 75541	172	FOR 7591922S	179	FOR 76414XL	191
FOR 75542	172	FOR 7592022	179	FOR 76417	191
FOR 75546	172	FOR 7592122	179	FOR 76417XL	191
FOR 75548	172	FOR 7592122S	179	FOR 76419	191
FOR 7555.16	175	FOR 7592123	179	FOR 76419XL	191
FOR 75550	172	FOR 7592224	179	FOR 76422	191
FOR 75555	172	FOR 7592326	179	FOR 76422L	191
FOR 75560	172	FOR 7592425S	179	FOR 76424	191
FOR 75565	172	FOR 7592427	179	FOR 76427	191
FOR 7557.16	175	FOR 7592528	179	FOR 7650127XL	193
FOR 7557.8	175	FOR 7592628	179	FOR 765012L	193
FOR 75570	172	FOR 7593032	179	FOR 765015L	193
FOR 7559.16	175	FOR 7601012	181	FOR 765015XL	193
FOR 755S08	174	FOR 7601214	181	FOR 765025G	197
FOR 755S09	174	FOR 7601315	181	FOR 765025L	193
FOR 755S10	174	FOR 7601417	181	FOR 765025XL	193
FOR 755S11	174	FOR 7601618	181	FOR 76502G	197
FOR 755S12	174	FOR 7601719	181	FOR 76502L	193
FOR 755S13	174	FOR 7610810	181	FOR 76502XL	193
FOR 755S14	174	FOR 7611012	181	FOR 76503G	197
FOR 755S15	174	FOR 7611113	181	FOR 76503L	193
FOR 755S16	174	FOR 7611214	181	FOR 76503XL	193
FOR 755S17	174	FOR 7611315	181	FOR 76504G	197
FOR 755S18	174	FOR 7611417	181	FOR 76504L	193
FOR 755S19	174	FOR 7611618	181	FOR 76504XL	193
FOR 7560608	181	FOR 7611719	181	FOR 76505G	197
FOR 7560711	181	FOR 7611922	181	FOR 76505L	193
FOR 7561012	181	FOR 7612224	181	FOR 76505XL	193
FOR 7561418	181	FOR 7620607	183	FOR 76506G	197
FOR 7561622	181	FOR 7620809	183	FOR 76506L	193
FOR 7562024	181	FOR 7621011	183	FOR 76506XL	193
FOR 75708	176	FOR 7621213	183	FOR 76507G	197
FOR 75708F	176	FOR 7621415	183	FOR 76507L	193
FOR 75708R	176	FOR 7621617	183	FOR 76508G	197
FOR 75709	176	FOR 7621819	183	FOR 76508L	193
FOR 75709F	176	FOR 7640127	191	FOR 76508XL	193
FOR 75709R	176	FOR 7640127L	191	FOR 7651.2G	197
FOR 75710	176	FOR 7640127XL	191	FOR 7651.4G	197
FOR 75710F	176	FOR 764015	191	FOR 7651.8G	197
FOR 75710R	176	FOR 764015L	191	FOR 76510G	197
FOR 75711	176	FOR 764015XL	191	FOR 76510L	193
FOR 75711F	176	FOR 76402	191	FOR 76510XL	193
FOR 75711R	176	FOR 764025	191	FOR 76512G	197
FOR 75712	176	FOR 764025L	191	FOR 76512L	193
FOR 75712F	176	FOR 764025T	197	FOR 76512XL	193
FOR 75712R	176	FOR 764025XL	191	FOR 76514L	193
FOR 75713	176	FOR 76402L	191	FOR 7653.16G	197
FOR 75713F	176	FOR 76402T	197	FOR 7653.32G	197
FOR 75713R	176	FOR 76402XL	191	FOR 7653.8G	197

FOR 7655.16G	197	FOR 77606	187	FOR 802415	146
FOR 7655.32G	197	FOR 77607	187	FOR 802415P	146
FOR 7655.64G	197	FOR 77608	187	FOR 802418	146
FOR 76606	195	FOR 77610	187	FOR 802418P	146
FOR 76606L	195	FOR 77612	187	FOR 80242	146
FOR 76607	195	FOR 77614	187	FOR 802422	146
FOR 76607L	195	FOR 77616	187	FOR 802422P	146
FOR 76608	195	FOR 784206U	124	FOR 802423	146
FOR 76608L	195	FOR 784207U	124	FOR 802423P	146
FOR 76609	195	FOR 784208U	124	FOR 80242P	146
FOR 76609L	195	FOR 784209U	124	FOR 80243	146
FOR 76610	195	FOR 784310U	124	FOR 802433	146
FOR 76610L	195	FOR 784311U	124	FOR 802434	146
FOR 76615	195	FOR 784312U	124	FOR 80243P	146
FOR 76615L	195	FOR 784313U	124	FOR 80248	146
FOR 76620	195	FOR 784314U	124	FOR 80248P	146
FOR 76620L	195	FOR 784315U	124	FOR 80249	146
FOR 76625	195	FOR 784316U	124	FOR 80249P	146
FOR 76625L	195	FOR 784317U	124	FOR 8026500	149
FOR 76627	195	FOR 784418U	124	FOR 8026500P	149
FOR 76627L	195	FOR 784419U	124	FOR 8028650	151
FOR 76630	195	FOR 79136	189	FOR 8028650P	151
FOR 76630L	195	FOR 79141	189	FOR 8032115	115
FOR 76640	195	FOR 79146	189	FOR 8033165	124
FOR 76640L	195	FOR 79150	189	FOR 8034250	145
FOR 76645	195	FOR 79155	189	FOR 8036450	149
FOR 76645L	195	FOR 79324	189	FOR 8036500	149
FOR 76650	195	FOR 79326	189	FOR 8038550	151
FOR 76650L	195	FOR 79327	189	FOR 803A4300	145
FOR 76655	195	FOR 79336	189	FOR 8042050	115
FOR 76655L	195	FOR 79338	189	FOR 8042100	115
FOR 76660	195	FOR 79346	189	FOR 8042100W	115
FOR 76660L	195	FOR 79350	189	FOR 8042150	115
FOR 76670	195	FOR 79352	189	FOR 8042250	115
FOR 76680	195	FOR 79355	189	FOR 8043044	124
FOR 76706L	195	FOR 79360	189	FOR 8043044W	124
FOR 76707L	195	FOR 79365	189	FOR 8043075	124
FOR 76708L	195	FOR 79375	189	FOR 8043075MPP	156
FOR 76709L	195			FOR 8043075MPP	167
FOR 76710G	200	8		FOR 8043150	124
FOR 76710L	195	FOR 8012140	115	FOR 8043150MPP	156
FOR 76715G	200	FOR 8013215	124	FOR 8043150MPP	167
FOR 76715L	195	FOR 8014380	145	FOR 8043200	124
FOR 76720G	200	FOR 8014380P	145	FOR 8043225	124
FOR 76720L	195	FOR 8014600	145	FOR 8043250	124
FOR 76725G	200	FOR 8014600P	145	FOR 8043300	124
FOR 76725L	195	FOR 80161000	149	FOR 8043450	124
FOR 76727G	200	FOR 80161000P	149	FOR 8044050	145
FOR 76727L	195	FOR 8016475	149	FOR 8044050W	145
FOR 76730G	200	FOR 80181000	151	FOR 8044075	145
FOR 76730L	195	FOR 80181000P	151	FOR 8044075MPB	167
FOR 76740G	200	FOR 8018650	151	FOR 80441250W	145
FOR 76740L	195	FOR 802215	114	FOR 8044125	145
FOR 76745G	200	FOR 802215P	114	FOR 8044125MPB	156
FOR 76745L	195	FOR 802218	114	FOR 8044125MPB	167
FOR 76750G	200	FOR 802218P	114	FOR 8044125MPP	156
FOR 76750L	195	FOR 802219	114	FOR 8044125MPP	167
FOR 76755G	200	FOR 802219P	114	FOR 8044125W	145
FOR 76755L	195	FOR 802220	114	FOR 8044250	145
FOR 76760L	195	FOR 80222	114	FOR 8044250MPB	156
FOR 774003.16	186	FOR 802222	114	FOR 8044250MPB	167
FOR 77430004	186	FOR 802222P	114	FOR 8044250MPP	156
FOR 77430005	186	FOR 802223	114	FOR 8044250MPP	167
FOR 774300055	186	FOR 802223P	114	FOR 8044500	145
FOR 77430006	186	FOR 80222P	114	FOR 8044500U	145
FOR 77430007	186	FOR 80228	114	FOR 8044700U	145
FOR 77430008	186	FOR 80229	114	FOR 8046100	149
FOR 77430009	186	FOR 80229P	114	FOR 8046100MPB	167
FOR 7743001.2	186	FOR 802315	125	FOR 8046100MPP	167
FOR 7743001.4	186	FOR 802315P	125	FOR 8046175MPB	167
FOR 77430010	186	FOR 802318	125	FOR 8046175MPP	167
FOR 77430011.32	186	FOR 802318P	125	FOR 8046200	149
FOR 77430011	186	FOR 802319	125	FOR 8046250MPP	167
FOR 77430012	186	FOR 802319P	125	FOR 8046330MPP	167
FOR 77430013	186	FOR 80232	125	FOR 8046400	149
FOR 77430014	186	FOR 802322	125	FOR 8048200	151
FOR 77430017	186	FOR 802322P	125	FOR 8048250MPP	167
FOR 7743003.8	186	FOR 802323	125	FOR 8048330MPP	167
FOR 7743005.16	186	FOR 802323P	125	FOR 8048400	151
FOR 7743007.16	186	FOR 80232P	125	FOR 80521	115
FOR 7743009.16	186	FOR 80238	125	FOR 80531	124
FOR 7743009.32	186	FOR 80238P	125	FOR 8053510	122
FOR 77604	187	FOR 80239	125	FOR 8053511	122
FOR 77605	187	FOR 80239P	125	FOR 8053512	122

FOR 8053513	122	FOR 81037	124	FOR R1935	167
FOR 8053514	122	FOR 81037	221	FOR R2435	167
FOR 8053516	122	FOR 810414	145	FOR R3355	167
FOR 805358510	122	FOR 810414	221	FOR R3755	167
FOR 805358511	122	FOR 81042	145	FOR R4455	167
FOR 805358512	122	FOR 81042	221	FOR R7555	167
FOR 805358514	122	FOR 81045	145		
FOR 805358516	122	FOR 81045	221	TC XC100	37
FOR 805358519	122	FOR 81047	145	TC XC100PL	37
FOR 80541	145	FOR 81047	221	TC XC 150	37
FOR 80541MPB	160	FOR 8111	115	TC XC 150PL	37
FOR 80541MPP	160	FOR 8113	217	TC XC 200	37
FOR 80561	149	FOR 81225	115	TC XC200PL	37
FOR 80561MPB	160	FOR 81225	217	TC XC75	37
FOR 80581	151	FOR 81260	115	TC XC75PL	37
FOR 80634	145	FOR 81260	217	TC XC SH11	37
FOR 80643	124	FOR 81260Q	115	TC XC SH12	37
FOR 807314	122	FOR 81260Q	217	TC XC SH13	37
FOR 807314	263	FOR 81280Q	115	TC XC SH21	37
FOR 807314M	122	FOR 81280Q	217	TC XC SH22	37
FOR 807314M	263	FOR 812M08	217	TC XC SH23	37
FOR 807314MTH	122	FOR 812M10	217		
FOR 807316	122	FOR 812M13	217	VERF ON FR107 1.4	325
FOR 807316	263	FOR 8143	115	VERF ON FR107 1.7	325
FOR 807316M	122	FOR 8143	217	VERF ON FR107 2.5	325
FOR 807316M	263	FOR 8144	115	VERF ON FR107 28	325
FOR 807316MTH	122	FOR 8145	115	VERF ON FR906 1.4	325
FOR 807318	122	FOR 8145	217	VERF ON FR906 1.7	325
FOR 807318	263	FOR 815A4315	146	VERF ON H827W R	325
FOR 807318M	122	FOR 8162	333	VERF ON SJ101AR	324
FOR 807318M	263	FOR 8163	333	VERF ON SJ101K	324
FOR 807318MTH	122	FOR 8164	333		
FOR 807320.6	122	FOR 8166	333	ZA ET110W1 2	242
FOR 807320.6	263	FOR 81806	284	ZA ET110W25	242
FOR 807320.6M	122	FOR 81808	284	ZA ET110W38	242
FOR 807320.6M	263	FOR 81810	284		
FOR 807320.6MTH	122	FOR 81812	284		
FOR 807325014M	122	FOR 818B01	284		
FOR 807325014M	263	FOR 818B02	284		
FOR 807325016M	122	FOR 819210	115		
FOR 807325016M	263	FOR 819213M	115		
FOR 807414M	144	FOR 819313	124		
FOR 807414M	263	FOR 819316M	124		
FOR 807416	144	FOR 819409	144		
FOR 807416	263	FOR 819414M	144		
FOR 807416M	144	FOR 8221719	182		
FOR 807416M	263	FOR 8221922	182		
FOR 807418	144	FOR 8221924	182		
FOR 807418	263	FOR 8222224	182		
FOR 807418M	144	FOR 83001	315		
FOR 807418M	263	FOR 83002	315		
FOR 807420.6	144	FOR 8334300	146		
FOR 807420.6	263	FOR 8812090	242		
FOR 807420.6M	144	FOR 881A13	242		
FOR 807420.6M	263	FOR 881A19	242		
FOR 809128MPP	160				
FOR 8092230	115	9			
FOR 8092230	217	FOR905M2P1	303		
FOR 8092250	115	FOR 905M2P2	303		
FOR 8092250	217	FOR 905M2P3	303		
FOR 80923	115	FOR 905M2P4	303		
FOR 80932	124	FOR 905M2P5	303		
FOR 80932MPB	160	FOR 9U050118	248		
FOR 80934	124	FOR 9U050124	248		
FOR 80934MPB	160	FOR 9U050130	248		
FOR 80943	145	FOR 9U050136	248		
FOR 80943MPB	160	FOR 9U050142	248		
FOR 80946	145				
FOR 80946MPB	160	FOR LOGO12	332		
FOR 80946MPP	160	FOR LOGO30	332		
FOR 8095330	115	FOR LOGO50	332		
FOR 8095330	217				
FOR 80964	149	FOR P2030	167		
FOR 80964MPB	160	FOR P2530	167		
FOR 80968	149	FOR P3040	167		
FOR 80968MPB	160	FOR P3540	167		
FOR 809812MPP	160	FOR P4540	167		
FOR 80986	151	FOR P7550	167		
FOR 80986MPB	160	FOR PI8022	333		
FOR 80986MPP	160	FOR PI8023	333		
FOR 81022	115	FOR PI8024	333		
FOR 81022	217	FOR PI8032	333		
FOR 81022M	115	FOR PI8033	333		
FOR 81022M	217	FOR PI8034	333		



VAMATEC

THE PLACE TO BE FOR THE METAL INDUSTRY

De Tonne 89-91 • Industriezone 5 • 9800 Deinze

T 09 386 69 31 • F 09 380 38 41

info@vamatec.be  visit us online www.vamatec.be