



**FORCE**

PROFESSIONAL TOOLS

tools & equipment

**2019**



tools & equipment  
**2019**

<b>Symbolen</b>	<b>6</b>
<b>Gereedschapskoffers - coffret d'outils</b>	<b>8</b>
Lege gereedschapskoffers - caisse d'outils	
Notebook	12
Gevulde gereedschapskoffers-caisse d'outils	13
<b>Gereedschapswagens-servantes d'atelier</b>	<b>23</b>
Practical series 10217-10218	22
Toebehoren - accessoires 10217-10218	24
Gereedschapswagen-servante Jumbo 10318	26
Toebehoren - accessoires 10318	27
<b>Service cart - station service 10517</b>	<b>29</b>
<b>Werkbanken - etablis</b>	<b>31</b>
<b>Ladenkasten - Armoires de rangements</b>	<b>32</b>
<b>Gevulde gereedschapswagens - servante d'atelier</b>	<b>34</b>
Gevulde gereedschapswagen Jumbo - servante d'atelier Jumbo	39
Gevulde gereedschapswagen Maxi tower - servante d'atelier	37
Gevulde gereedschapswagens foam - servante d'atelier système mousse	42
Gevulde gereedschapswagen foam JUMBO - servante d'atelier système mousse	44
<b>TC TRAYS</b>	<b>48</b>
TC Trays 1/4"	49
TC Trays 3/8"	50
TC Trays slagdoppen - douilles à choc	51
TC Trays 1/2"	52
TC Trays tangen - pincen	54
TC Trays sleutels - clés	56
TC Trays Large	59
<b>Foamsets - mousse</b>	<b>63</b>
<b>Doppensets - Jeu de douilles 1/4"</b>	<b>88</b>
Doppen 1/4" - Douilles 1/4"	88
Ratels - Cliquets 1/4"	98
Onderdelen - Accessoires 1/4"	99
<b>Doppensets - Jeu de douilles 3/8"</b>	<b>100</b>
Doppensets inch maten - Jeu de douilles 3/8" en pouce	104
Doppen 3/8" - douilles 3/8"	105
Toebehoren - Accessoires 3/8"	108
<b>Doppensets - Jeu de douilles 1/2"</b>	<b>110</b>
Doppensets inch maten - Jeu de douilles 1/2" en pouce	115
Doppensets - Jeu de douilles 1/2"	116
Doppensets inbus - Jeu de douilles hex 1/2"	117
Doppensets torx- Jeu de douilles 1/2"	118
Doppensets XZN- Jeu de douilles 1/2" XZN	121
Doppen 1/2" - Douilles 1/2"	122
<b>Doppen - Douilles 1/2"</b>	<b>124</b>
Onderdelen - Accessoires 1/2"	128
<b>Doppensets - Jeu de douilles 3/4"</b>	<b>131</b>
<b>Doppenset 1" - Jeu de douilles 1"</b>	<b>134</b>
<b>Slagdoppensets - Jeu de douilles à choc 1/2"</b>	<b>137</b>
<b>Slagdoppen - Douilles à choc 1/2"</b>	<b>139</b>
<b>Adapters - Adaptateurs</b>	<b>143</b>
<b>Slagdoppensets - Jeu de douilles à choc 3/4"</b>	<b>144</b>
<b>Slagdoppen - Douilles à choc 3/4"</b>	<b>145</b>
<b>Slagdoppensets - Jeu de douilles à choc 3/4"</b>	<b>146</b>
<b>Slagdoppen - Douilles à choc 3/4"</b>	<b>147</b>
<b>Slagdoppen - Douilles à choc 1"</b>	<b>148</b>
<b>Slaggereedschap - Assecoires à choc</b>	<b>150</b>
<b>Slagdoppen - Douilles à choc 1/2"</b>	<b>151</b>
<b>Gereedschapskoffer- Valise alu</b>	<b>152</b>

<b>Steekringsleutels - Clés mixtes mm</b>	<b>156</b>
Steekringsleutels inch - clés mixtes en pouces	157
Steekringsleutels met ratel- Clés mixtes à cliquet	158
Steeksleutels - clés à fourches	162
Gebogen ringsleutels - clés polygonales	163
Ringsleutels - Clés polygonales	164
Pijpsleutels - Clés à pipe	167
Open ringsleutelsets - Clés à tuyauter	168
Kniesleutels - clés à douilles articulées	169
Dopsleutels - douilles sur manches	170
Verstelbare sleutels - Clés à molette	172
Momentsleutels - Clés dynamométrique	175
<b>Schroevendraaiers - Jeu de tournevis</b>	<b>177</b>
Schroevendraaiers torx - Tournevis torx	180
Slag schroevendraaiers - Tournevis à frapper	182
Bitsen - Embouts 5/16"	184
Schroevendraaiers 1000v-Tournevis	186
Bitsets 1/4" - Jeu d'embouts	188
Bitsen - Embouts 1/4"	190
Bitsets 10 mm - jeu d'embouts	192
<b>Inbussleutels - Clés mâles</b>	<b>197</b>
Haakse sleutels - Clés mâles	198
Haakse torx sleutels - Clés mâles torx	202
Inbussleutels op handvat - Jeu de clés à poignée	204
Torx - resistorx	206
Resistorx	207
<b>Tangen - Pincen</b>	<b>209</b>
Tangen 1000 V - Pincen 1000v	210
Borgveertangen - Pincen circlips	211
<b>Hamers - zagen - boren - knippen - Scie - marteau -</b>	<b>216</b>
Beitels-doorslag - Burins	217
Hamer-beitels- Chasse goupilles	218
Hamers - marteaux	219
Tap- en kussenset - Tarrauds & filières	220
<b>V coil</b>	<b>221</b>
<b>Snij-meetgereedschap - Couper-mesurer</b>	<b>222</b>
<b>Pijptangen - Clés serre-tube</b>	<b>227</b>
<b>Garage equipment</b>	<b>229</b>
Vervangen filters - Huile	236
Ontsteking brandstof - allumage carburant	244
Blokkeergereedschap - outils de calage	248
Diesel verstuivers - injecteurs diesel	256
Motor - moteur	258
Remmen - freins	264
Wielen - roues	270
Aandrijving - suspension & transmission	274
Trekkers - extracteurs	276
Special tools	281
Truck	282
Carrosserie	284
Special tools	286
Electriciteit	291
Tangen - Pincen	294
<b>Electriciteit</b>	<b>297</b>
Led lampen	298
Omvormers DC/AC - converteurs	299
Boosters 12v / 12-24v	300
<b>Pneumatic tools</b>	<b>302</b>
<b>Bagagespanners - Sangles</b>	<b>306</b>
<b>Bankschroeven - Etaux</b>	<b>307</b>
<b>Takels - Palans</b>	<b>308</b>
Winches	309
<b>Divers</b>	<b>310</b>
<b>Catalogi</b>	<b>315</b>
<b>Index</b>	<b>316</b>
<b>Algemene voorwaarden - Conditions générale</b>	<b>324</b>





## Wij heten u van harte welkom in onze nieuwe Zasco catalogus 2019-2020

ZASCO is een im-exporteur van professionele gereedschappen voor de vakhandel actief op de Benelux markt.

In België is ZASCO exclusief verdeler van het merk Force, een producent van gevulde gereedschapswagens en handgereedschap, toegespitst naar de automobielsector.

Ons gamma wordt verder aangevuld met divers gereedschap zoals gereedschapsets, diverse tangen, hamers, tappen - en kussensets, winches, automotive tools, takels, bagagespanners, werkhandschoenen, verfspuiten, pneumatische tools, bankschroeven, snijgereedschap

Wij wensen U alvast een boeiende ontdekkingstocht en hopen u binnenkort te mogen verwelkomen in de wereld van Zasco.

**ZASCO Tools & Equipment is uw beste professionele partner als het om gereedschap gaat.**

## Bienvenue dans notre nouveau catalogue 2019-2020

ZASCO est une société d'import - et export d'outillage professionnel pour la vente aux professionnels. Nous sommes active sur le marché du Benelux.

En Belgique Zasco est le distributeur officiel pour la marque FORCE, fabricant de servantes complètes et d'outillage à main dans le domaine de l'automobile.

Notre gamme d'outillage se complète d'autre matériaux divers : des marteaux, tarauds et filières, sangles, treuils, pistolets de peinture, matériaux pneumatique, chandelles, ...

Prenez le temps de consulter notre catalogue et avez-vous des questions, n'hésitez pas à nous contacter. Nous vous contacterons le plus vite possible.

**ZASCO Tools & Equipment votre meilleur partenaire quand il s'agit d'outillage**

bezoek/visitez  
**Zasco.be**



### Onze site

Boordevol Tools & equipment voor de professional. Promo's, info en vooral een handige webshop waar je online 24/24 terecht kan voor uw bestellingen. Surf vlug naar [www.zasco.be](http://www.zasco.be) en registreer je nu!

### Notre site

Plein avec tools & equipment pour le professional. Promos, info et surtout un webshop pratique pour toutes vos commandes online 24/24.

Enregistrez-vous vite sur [www.zasco.be](http://www.zasco.be)!

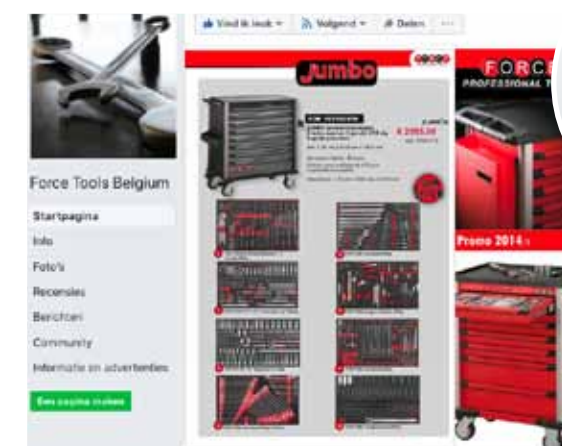

### Bedrijfsinformatie/ Coördonnées

**Maatschappelijke zetel  
siège social**

**Telefoon  
Téléphone**

**Fax**

**E-mail**

**Website**

**Bank  
Compte de banque**

**Ondernemingsnummer  
Numéro d'entreprise**

**Openingsuren - Heures d'ouverture**

Wassenhovestraat 3 - 9620 Zottegem

09 360 01 52 – bestelling : 09 367 49 95

09 361 36 30

info@zasco.be, orders@zasco.be

www.zasco.be

**KBC** IBAN BE34 4444 6567 8190 - BIC KREDBEBB

**BNP PARIBAS** IBAN BE77 2850 3790 8942 - BIC GEBABEBB

BE 0432.389.277

8u00 - 12u00 - 13u00 - 17u00 - (Vrijdag/vendredi 13u00-15u00)





-  6 kant - 6 pans
-  12 kant - 12 pans
-  Torx inwendig
-  XZN dop inwendig
-  plat
-  philips
-  pozidrive
-  hexagonales
-  hexagonales met kogelkop
-  Torx
-  Resistorx
-  XZN (12 tanden)
-  Ribe
-  inch

**GARANTIES "Force"**

Force gereedschappen worden voor professioneel en intensief gebruik, zowel voor onderhoud als reparatie, ontwikkeld en geproduceerd volgens de normen en zijn voorzien van "levenslange" garantie, welke inhoudt dat het defecte gereedschap kosteloos zal vervangen worden. Deze garantie dekt alle handgereedschappen indien deze op een normale en correcte manier zijn gebruikt.











De garantie dekt alle handgereedschappen bij een defect indien deze een gevolg is van een fabricagefout. De garantie vervalt indien ze slijtage vertonen, van bv bitsen, zaagbladen, cuttermessen, vijlen, hamers etc. Of verkeerd en/of ondeskundig gebruik, schade die wordt veroorzaakt aan het gereedschap zoals brand, water, verkeerde toepassing. Ieder gereedschap moet compleet retour komen.

**GARANTIES "Force"**

Les outils de Force ont été développés pour utilisation professionnel et intensive, à la fois pour l'entretien et la réparation suivant les normes et ont une garantie à vie. Ce garantie couvre tous les outils qui ont été utiliser d'un façon correct.

La garantie couvre tous les outils défectueux à cause d'une faute de fabrication. La garantie est nulle si elles présentant une usure de p.e. embouts, lames, couteur, marteaux etc. Ou en abus et/ou une utilisation incorrecte. Tous les outils doivent nous être remis complet.



	Gereedschapskoffers - coffrets d'outils	8
	Gereedschapskoffers gevuld - coffrets d'outils	13
	Gereedschapswagens - servantes	23
	Accessoires gereedschapswagens -accessoires servantes	27
	Werkbank - établi	31
	Ladenkasten - armoires	32
	Gereedschapswagens gevuld met TC modules servantes avec outils	34
	Gereedschapswagens gevuld met foam modules servantes avec foam	42
	TC Trays	48
	Foam sets Jumbo 10318	63



### FOR 50230

#### Gereedschapstas in stof (leeg)

- met metalen draaghandvat en schouderband

#### Caisse à outils textile (vide)

- sangle pour transporter un niveau

Afm /dim	L 53.5cm	B 25.8cm	H 22.5cm
----------	----------	----------	----------



### FOR 50235

#### Gereedschapskoffer metaal met 5 vakken

- groot opbergvolume
- afsluitbaar met hangslot
- electrostatisch gepoedercoated
- Gewicht 8.2 kg

#### Coffret d'outils à 5 compartiments

- fermeture par cadenas (non fourni)
- 5 compartiments
- poids 8.2 kg



### FOR 50234

#### Gereedschapskoffer ABS op wielen

- afsluitbaar met sleutel

#### Valise avec trolley

- fermeture avec clés
- chariot demontable

Totale Afm/dim	L 45cm	B 33cm	H 15cm
gewicht/poids	3.3kg		



### FOR 50223C

### FOR 50223R

#### Gereedschapskoffer 3 laden

- 3 laden (12 TC modules 4 per lade)
- kogelgelagerd & centrale vergrendeling met 2 sleutels
- laden 100% uitschuifbaar
- anti blokkeersysteem 1 lade tegelijk open
- zijdelings dubbele handgrepen
- stapelbaar op gereedschapswagen 10217 & 10218
- alle laden voorzien van rubbermatten
- werkblad met dikke rubbermat

#### Coffre de servante d'atelier 3 tiroirs

- 3 tiroirs sur roulements à billes
- ouverture 100% des tiroirs
- à verrouillage centralisée
- système de blocage de tiroirs
- plan de travail en caoutchouc
- 2 poignées latéraux en acier

Afm/dim	L 70cm	B 47cm	H 34cm
Binnen maten laden/tiroirs	L 58cm	B 37.5cm	H 6cm
gewicht/poids	27.4kg		

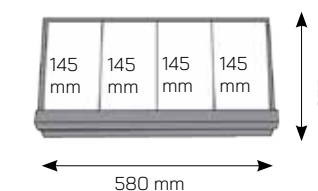

### FOR 50223S

#### Gereedschapskoffer metaal 3 laden

- zijdelingse handgrepen + handvat bovenaan
- 2 sluitingen
- 3 kogelgelagerde laden 100% uitschuifbaar

#### Coffret à outils 3 tiroirs

- 3 tiroirs sur roulements à billes
- 2 poignées latérales en acier

Totale Afm/dim	L 55.5cm	B 24cm	H 28cm
gewicht/poids	12.5kg		
Hoogte laden			H 4.5cm



### TC TBC123B

#### Gereedschapskoffer met 5 vakken

- groot opbergvolume
- afsluitbaar met hangslot

#### Coffret d'outils à 5 compartiments

- fermeture par cadenas (non fourni)
- 5 compartiments

Totale Afm/dim	L 52.5cm	B 20cm	H 19.5cm
gewicht/poids	3.8kg		





## FOR 10225C FOR 10225R

### Gereedschapskoffer 5 laden

- 5 laden (20 TC modules - 4 per lade)
- kogelgelagerd & centrale vergrendeling met 2 sleutels
- laden 100% uitschuifbaar
- anti blokkeersysteem 1 lade tegelijk open
- stapelbaar op gereedschapswagen 10217 & 10218
- zijdelingse handvaten
- alle laden voorzien van rubbermatten
- werkblad met rubbermat

### Coffre de servante d'atelier 5 tiroirs

- glissières à roulements à billes
- verouillage à clé
- ouverture 100% des tiroirs
- système de blocage de tiroirs
- plan de travail en caoutchouc
- 2 poignée latéraux en acier

Afm/dim	L 69cm	B 46cm	H 49cm
Binnenmaten laden/tiroirs	L 58cm	B 37,5cm	H 6cm
gewicht/poids	38,7kg		

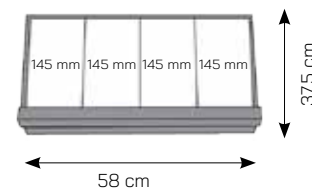

## FOR 10323C FOR 10323R

### Gereedschapskoffer 3 laden voor Jumbo

- 3 laden (18 TC modules - 6 per lade)
- kogelgelagerd & centrale vergrendeling met 2 sleutels
- laden 100% uitschuifbaar
- anti blokkeersysteem 1 lade tegelijk open
- stapelbaar op gereedschapswagen 10318
- zijdelingse handvaten
- alle laden voorzien van rubbermatten
- werkblad met rubbermat

### Coffre de servante d'atelier 3 tiroirs pour Jumbo

- glissières à roulements à billes
- fermeture centralisée avec 2 clés pliable
- système de blocage de tiroirs
- ouverture 100% des tiroirs
- plan de travail en caoutchouc
- 2 poignée latéraux en acier

Afm/dim	L 95cm	B 50cm	H 36cm
Binnenmaten laden/tiroirs	L 75cm	B 43,5cm	H 6cm
gewicht/poids	37,8kg		

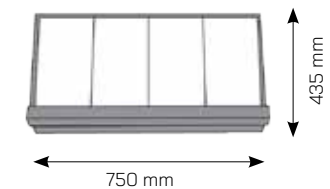

## FOR 50352

### Gereedschapswand 2 laden

- 2 laden
- centrale vergrendeling met 2 sleutels
- geleverd met 15 haken

### Armoire à outils 2 tiroirs

- 2 tiroirs
- verouillage à clé

Afm/dim	L 65,50cm	B 28cm	H 81cm
gewicht/poids	34 kg		





### FOR 50231-33

Notebook bag 34 delig

Trousse de bord composition de 34 outils

Afm/dim	L 38,5cm	B 24cm	H 5cm
gewicht/poids	4kg		

611B160	universele tang, pince universelle 160 mm
612B160	kniptang, pince coupante 160 mm
613B250	waterpomptang, pince multiprise 250 mm
616B16	hamer, marteau 635gr
649200	verstelbare moersleutel, clé à molette 200 mm
7111	schroevendraaier, tournevis PH1 80 mm L
7112	schroevendraaier, tournevis PH2 100 mm L
71304	schroevendraaier, tournevis plat 4 mm 100 mm L
713055	schroevendraaier, tournevis plat 5.5 mm 125 mm L
713065	schroevendraaier, tournevis plat 6.5 mm 150 mm L
755 08...19	steekringsleutels, clés mixtes 8-10-11-12-13-14-17-19 mm
5072F	inbusset, jeu de clés allen 2.5-3-4-5-6-8-10 mm
5083F	torx set T9-T10-T15-T20-T25-T27-T30-T40
9U3001	staalborstel, brosse en acier



### Gevulde gereedschapskoffer-caisse d'outils

#### FOR 50235-88

Gereedschapskoffer gevuld 1000v

- gereedschap 88 delig
- metalen koffer

Coffret d'outils avec 88 pcs d'outils 1000v

- coffret en metal peinture en poudre
- coffret d'électricien et maintenance générale

Afm/dim	L 53,5cm	B 25,8cm	H 22,5cm
gewicht/poids	18.2kg		



#### FOR C5153

Steekringsleutels 15 stuks, clés mixtes 15 pcs

8-10-11-12-13-14-15-16-17-18-19-21-22-23-24 mm



#### FOR C4482

525.....	1/4" douilles 6p 4-4.5-5-5.5-6-7-8-9-10-11-12 mm
545...	1/2" doppen 10-11-12-13-14-15-16-17-18-19-21-22-24
8044050-8044150	verlengstuk, rallonges 50 mm & 150 mm
80521/80541	kniegewricht, cardan 1/4" + 1/2"
81225	magneet, aimant
81022	bit houder 1/4" x 1/4"
802223	ratel, cliquet 1/4"
8032115	wringstaaf, manche en T 1/4"
8143	schroevendraaier handvat, manche
80242	ratel, cliquet 1/2"
8034250	wringstaaf, manche en T 1/2"
21111	bitset 11 delig, boîte de 11 embouts



#### FOR C50412

6903180	kombinatietang, pince universelle 1000v 180 mm
6904160	bektang, pince à becs long 1000v 160 mm
6905160	kniptang, pince coupante 1000v 160 mm
6912160	striptang, pince à dénuder



#### FOR C20913

711N1	PH1 (80 mm L)
711N2	PH2 (100 mm L)
713N025	2.5 (75 mm L)
713N04	4 (100 mm L)
713N055	5.5 (125 mm L)
713N065	6.5 (150 mm L)
88403	voltage tester 80-250v AC
5096P8	meter 5m, mètre à ruban 5m
68601	led lampje, lumière



#### FOR C51220

616300	hamer, marteau 300 gr
616A400	nylon hamer, marteau nylon 400 gr
6907250	waterpomptang, pince multiprise 1000v 250 mm
614250	vise grip tang, pince grip 250 mm
649200C	moersleutel, clé à molette 200 mm
66302	mini hakzaag, scie mini
5055P3	zaagblad, lame
6982	schaar, ciseau de technicien 145 mm
5055P4	cuttermes, cutter à lame
60212150	beitel, burin 12 (150 mm L)
60219180	beitel, burin 19 (180 mm L)





**FOR 50235-101**

Gereedschapskoffer 5 delig gevuld met gereedschap 101 delig  
 Caisse à outils 101 pcs  
 - coffret metal peinture en poudre à 5 étages

Afm/dim	L 53,5 cm	B 25,8 cm	H 22,5 cm
gewicht/poids	18,23 kg		

**FOR C5153**

Steekringsleutels 15 stuks, clés mixtes 15 pcs

8-10-11-12-13-14-15-16-17-18-19-21-22-23-24 mm

**FOR C5142**

613B250	waterpomptang, pince multiprise 250 mm
610B200	lange bektang, pince à becs long 200 mm
611B175	universele tang, pince universelle 175 mm
612B175	kniptang, pince coupante 175 mm
5102	inbusset 1.27 tot 10 mm, clés allen

**FOR C21114**

7110-7111-7112	PH0-PH1-PH2
7111S-7112S	PH1 - PH2 (25 mm L)
71303 - 71304	3 mm - 4 mm
713055-713065	5.5 mm - 6.5 mm
713055S-713065S	5.5 mm - 6.5 mm (25 mm L)

**FOR C4482**

1/4" doppen 525.....	douilles 6p 4-4.5-5-5.5-6-7-8-9-10-11-12 mm
1/2" doppen 545...	douilles 10-11-12-13-14-15-16-17-18-19-21-22-24mm
8044050-8044150	verlengstuk, rallonges 50 mm & 150 mm
80521/80541	kniegewricht, cardan 1/4" + 1/2"
81225	magneet, aimant
81022	bit houder 1/4" x 1/4", porte embout
802223	ratel, cliquet 1/4"
8032115	wringstaaf, manche en T 1/4"
8143	schroevendraaier handvat, manche
80242	ratel, cliquet 1/2"
8034250	wringstaaf, manche en T 1/2"
21111	bitset 11 delig, boîte de 11 embouts

**FOR C5136**

5055P4	1 cuttermes, cutter à lame
5096P8	meter 5m, mètre à ruban
60215180Q	beitel, burin 15 (180 mm L)
604419Q/6045200Q	puntbeitel, burin pointeau 4 (190 mm L) 5 (200 mm L)
6046210Q	puntbeitel, burin pointeau 6 (210 mm L)
614250	vise grip tang, pince grip 250 mm
616300	hamer 300 gr, marteau
616400	rubber hamer 400 gr, marteau anti retour
649250A	moersleutel 250 mm, clé à molette
66302	mini hakzaag + reservezaagjes /scie



**FOR 50235-187**

Gereedschapskoffer 5 delig gevuld met gereedschap 187 delig  
 Caisse à outils 187 pcs en mousse  
 - coffret metal à 5 étages

Afm/dim	L 53,5 cm	B 25,8 cm	H 22,5 cm
gewicht/poids	21 kg		



525 04...13	1/4" douilles 6p 4-4.5-5-5.5-6-7-8-9-10-11-12-13 mm
52555 08..12	1/4" lange doppen- langues 8-10-12
bits op dop	1/4" PH.0-PH.1-PH.2-PH.3-PZ1-PZ2
bits op dop plat	1/4" 4-5.5-6.5-7
inbus	1/4" 3-4-5-6-7-8-10mm
torx	1/4" T8-T10-T15-T20-T25-T27-T30
resistorx	1/4" T8H-T10H-T15H-T20H-T25H-T27H-T30H-T40H
8044050 - 8044100	verlengstuk, rallonges 50 mm & 100 mm
80521 - 80541	kniegewricht, cardan 1/4" + 1/2"
8143	1/4" spinner 150mmL, tournvis porte-embout
8032115	1/4" wringstaaf T 115mmL, manche en T
81022	Bit houder 1/4" x 1/4", porte embout
2331A	veiligheidsbitset 33dlg 1/4"
21013	vijf ster bitset 10dlg 1/4"
5457713...19	1/2" lange doppen, douilles longues 13-17-19mm
80228	ratel, cliquet 1/4"

545 10...32	1/2" 10-11-12-13-14-15-16-17-18-19-20-21-22-23-24-27-30-32
8044125 - 8044250	verlengstuk, rallonges 125 mm & 250 mm
80541	kniegewricht, cardan 1/2"
80634	adapter voor verlengstuk 3/8" x 1/2", adaptateur
807416 - 807420.6	1/2" bougiedop, douilles pour bougies 16mm- 20.6mm
80248	1/2" ratel 72tanden, cliquet
34605540...55	1/2" torx doppen T40-T45-T50-T55
<b>Steekringsleutels , clés mixtes</b>	
6-7-8-9-10-11-12-13-14-15-16-17-18-19mm	
5116LB inbus set 11dlg, 1.5mm-12mm	

616300	hamer 300gr, marteau
610B200	lange bektang, pince à becs long 200 mm
611B175	universele tang, pince universelle 175 mm
612B175	kniptang, pince coupante 175 mm
68021	mes, cutter à lame
68601	LED lamp (360° draaibaar)

613B250	waterpomptang, pince multiprise
614250	vise grip 250mm, pince grip 250mm
649250	moersleutel 250mm, clé à molette 250mm
609ABC-609ASO	circlipstangen, pince circlips
616A400	hamer 400gr PU + nylon, marteau
60212150 - 6074185	beitel 150mmL 12 - center punt 185mmL 4
50613	set doorslagen 6 dlg - chasse goupilles

7111 - 7113	PH1-PH3
7112M	PH2 hamer schroevendraaier
7111S - 7112S	PH1 - PH2 (25 mm L)
71303 - 713035 - 71304	3 mm - 3.5 mm -4 mm
713055 - 71308	5.5 mm - 8mm
713065M	6.5 hamer schroevendraaier
713055S - 713065S	5.5 mm - 6.5 mm (25 mm L)





## FOR 50230-95

Gereedschapstas met schouderriem gevuld met gereedschap 95 delig  
Sac d'outils avec 95 pcs d'outils

Afm/dim	L 53.5cm	B 25.8cm	H 22.5cm
gewicht/poids	10.8 kg		



610B160	lange bektang, pince à becs long 160 mm
612B160	kniptang, pince coupante 160 mm
611B160	universele tang, pince universelle 160 mm
5102	inbussleutelset, clés allen 1.27-10 mm
5055P4	cuttermes, cutter à lame
613200	waterpomptang, pince multiprise 200 mm
614175	vise grip tang, pince grip 175 mm
649200C	verstelbare moersleutel, clé à molette 200 mm
5096P803	meter 3m, mètre à ruban
75508.....24	steekringsleutel, clés mixtes 8 tot 24 mm
6982	schaar, ciseau de technicien
711N1	schroevendraaier, tournevis 1000v PH1
713N04	platte schroevendraaier, tournevis plat 4 mm 1000v
88407	tester, testeur
7111M	hamer schroevendraaier, tournevis à frappe PH1
7112M	hamer schroevendraaier, tournevis à frappe PH2

71308M	hamer schroevendraaier, tournevis à frapper 8 mm
713055M	hamer schroevendraaier, tournevis à frapper 5.5 mm
713065M	hamer schroevendraaier, tournevis à frapper 6.5 mm
71303	schroevendraaier, tournevis 3 mm
71304	schroevendraaier, tournevis 4 mm
7110	schroevendraaier, tournevis PH0
617F	3 in 1 magneet met spiegel, aimant avec miroir
2421F	doppenset, jeu de douilles 1/4" 42 delig
616A400	hamer, marteau 400 gr
616F032	bank hamer, marteau tête rivoir
6044190	doorslag, chasse goupilles 4 mm (190 mm L)
6074185	center punt, pointeau 4 (185 mm L)
60212150	beitel, burin 150 mm L
603150	kapbeitel, bedane 150 mm L
6063185	puntslag, burin pointeau 3 185 mm L
66301	hakzaag, scie

## FOR 50234-107

Gereedschapskoffer ABS op wielen gevuld met gereedschap 107 delig  
Valise porte-outils, poignée télescopique et chariot démontable avec 107 outils

Afm/dim	L 45 cm	B 33 cm	H 15 cm
gewicht/poids	12.9 kg		



6905160	kniptang, pince coupante 1000v 160 mm
6903160	kombinatietang, pince universelle 1000v 160 mm
6904160	lange bektang, pince à becs long 1000v 160 mm
6907250	waterpomptang, pince multiprise 1000v 250 mm
6912160	striptang, pince à dénuder 1000v
649250A	regelbare moersleutel, clé à molette 1000v 250 mm

614250	griptang, pince grip
5055P4	cuttermes, cutter à lame
5115	11 delig steekringsleutelset, clés mixtes 8-22 mm
5054	5 delig beitelset, jeu de burins
5102	10 delig inbussleutelset, jeu de clés mâle 1.27 tot 10 mm

711N1	PH1 1000v
711N2	PH2 1000v
713N03	3 mm 1000v
713N04	4 mm 1000v
713N055	5.5 mm 1000v
713N065	6.5 mm 1000v
7112AS	PH1 (25 mm)
713065AS	6.5 mm (25 mm)
7111	PH1
7112	PH2
7113	PH3
2125P1	tester, testeur

2421BF	doppenset, jeu de douilles 1/4" 42 delig
616300	hamer, marteau 300 gr
616400	rubber hamer, marteau anti retour
66302	mini hakzaag, scie
5096P8	meter 5m, mètre à ruban
2125P1	circuit tester, détecteur de tension
4106	1/2" doppenset op rail, jeu de douilles 10 tot 24 mm
80242	ratel, cliquet 1/2"
68604	dynamo lamp
5096P2	center punt, pointeau





## FOR 50223S103

Gereedschapskoffer 3 laden gevuld met gereedschap 103 delig 12kant

- metalen koffer

Coffret d'outils 3 tiroirs 103 pcs 12 pans

- coffret métal



Afm/dim	L 55,5 cm	B 24 cm	H 28 cm
gewicht/poids	21,4 kg		

## FOR F4721

1/4"-1/2" doppenassortiment 72 delig + bits, ass. douilles 72 pcs

12k doppen 12 pans 1/4" 4-4.5-5-5.5-6-7-8-9-10-11-12-13 mm

lange doppen 1/4" 8-10-13 mm - 1/2" 17-19-21 mm

549 14...32 12 pans 1/2" 14-15-16-17-18-19-20-21-22-24-27-30-32 mm

80521 - 80541 kniegewricht, cardan universelle 1/4" - 1/2"

802215 - 80243 1/4" ratel, cliquet 1/2" ratel

8032115 1/4" wringstaaf, manche en T

8042050 1/4" verlengstuk, rallonge 50 mm

8044075 - 8044250 1/2" verlengstuk, rallonges 75 mm & 250 mm

81022 bit houder, porte embouts

81022M magneet bit houder, porte embouts magnétique

8143 steekhecht, manche tournevis

8044125W 1/2" verlengstuk, rallonge 125 mm

80634 adapter voor verlengstuk, adaptateur pour rallonge



## FOR F20914

Schroevendraaierset 9 delig, module de 9 tournevis

7111 PH1

7112 PH2

7113 PH3

7112S PH 2 (25 mm L)

71304 4 mm

713055 5.5 mm

713065 6.5 mm

71308 8 mm

713065S 6.5 mm (25 mm L)



## FOR F51210FV

Flexibele ratelsleutelset 12 delig, module de 12 clés mixtes à cliquet flex

757 08...19 8-9-10-11-12-13-14-15-16-17-18-19 mm



## FOR F51012

Kombinatieset 10 delig, modules de combination 10 pcs

60212150/603150 beitel, burin 12 mm (150 mm L) - kapbeitel 150 mm

6074185 center punt, pointeau 4 (185 mm L)

6043150 doorslag, chasse goupil. 3 mm(150 mm L)

6044190 4 mm (190 mm L)

613B250 waterpomptang, pince multiprise 250 mm

610B200 lange bektang, pince à becs long 200 mm

611B175 kombinatietang, pince universelles 175 mm

612B175 kniptang, pince coupante 175 mm

616200 hamer, marteau 200 gr



## FOR 50223S116-5

Gereedschapskoffer 3 laden gevuld met gereedschap 116 delig 6kant

- metalen koffer

Coffret d'outils 3 tiroirs 116 pcs 6 pans

- coffret métal

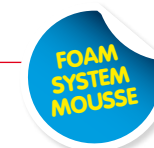

Afm/dim	L 55,5 cm	B 24 cm	H 28 cm
gewicht/poids	21,4 kg		

## FOR F4721 5

1/4"-1/2" doppenassortiment 72 delig + bits, ass. douilles 72 pcs

525 04...13 1/4" 4-4.5-5-5.5-6-7-8-9-10-11-12-13 mm

lange doppen 1/4" 8-10-13 mm - 1/2" 17-19-21 mm

545 14...32 1/2" 14-15-16-17-18-19-20-21-22-24-27-30-32 mm

80521 - 80541 kniegewricht, cardan universel 1/4" - 1/2"

802215 - 80243 1/4" ratel, cliquet 1/2" ratel

8032115 1/4" wringstaaf, manche en T

8042050 1/4" verlengstuk, rallonge 50 mm

8044075 - 8044250 1/2" verlengstuk, rallonges 75 mm & 250 mm

81022 bit houder, porte embouts

81022M magneet bit houder, porte embouts magnétique

8143 steekhecht, manche tournevis

8044125W 1/2" verlengstuk, rallonge 125 mm

80634 adapter voor verlengstuk, adaptateur pour rallonge



## FOR F20914

Schroevendraaierset 9 delig, module de 9 tournevis

7111 PH1

7112 PH2

7113 PH3

7112S PH 2 (25 mm L)

71304 4 mm

713055 5.5 mm

713065 6.5 mm

71308 8 mm

713065S 6.5 mm (25 mm L)



## FOR F5252

Steekringsleutels + inbussleutels 25 delig, module 25 clés mixtes

755 06...24 6-7-8-9-10-11-12-13-14-15-16-17-18-19-22-24 mm

5093LB 1.5-2-2.5-3-4-5-6-8-10 mm clés mâles



## FOR F51012

Kombinatieset 10 delig, module de combination 10 pcs

60212150 - 603150 beitel, burin 12 mm (150 mm L) - kapbeitel 150 mm

6074185 center punt, pointeau 4 (185 mm L)

6043150 doorslag, chasse goupil. 3 mm(150 mm L)

6044190 chasse goupil 4 mm (190 mm L)

613B250 waterpomptang, pince multiprise 250 mm

610B200 lange bektang, pince à becs long 200 mm

611B175 kombinatietang, pince universelles 175 mm

612B175 kniptang, pince coupante 175 mm

616200 hamer, marteau 200 gr





**FOR 10225C247**

**FOR 10225R247**

Gereedschapskoffer 5 laden  
 gevuld met gereedschap 247 delig  
 - 4 laden gevuld, 14 modules  
**Coffret d'outils 5 tiroirs 247 pcs**  
 - 4 tiroirs avec outils, 14 modules

Afm/dim	L 69 cm	B 46 cm	H 49 cm
gewicht/poids	65.2 kg		



**FOR 10225C181**

**FOR 10225R181**

Gereedschapskoffer 5 laden  
 gevuld met gereedschap 181 delig  
 - 4 laden gevuld, 4 foams  
**Coffret d'outils 5 tiroirs 181 pcs**  
 - 4 tiroirs avec outils, 4 mousse



Afm/dim	L 69 cm	B 46 cm	H 49 cm
gewicht/poids	65.2 kg		

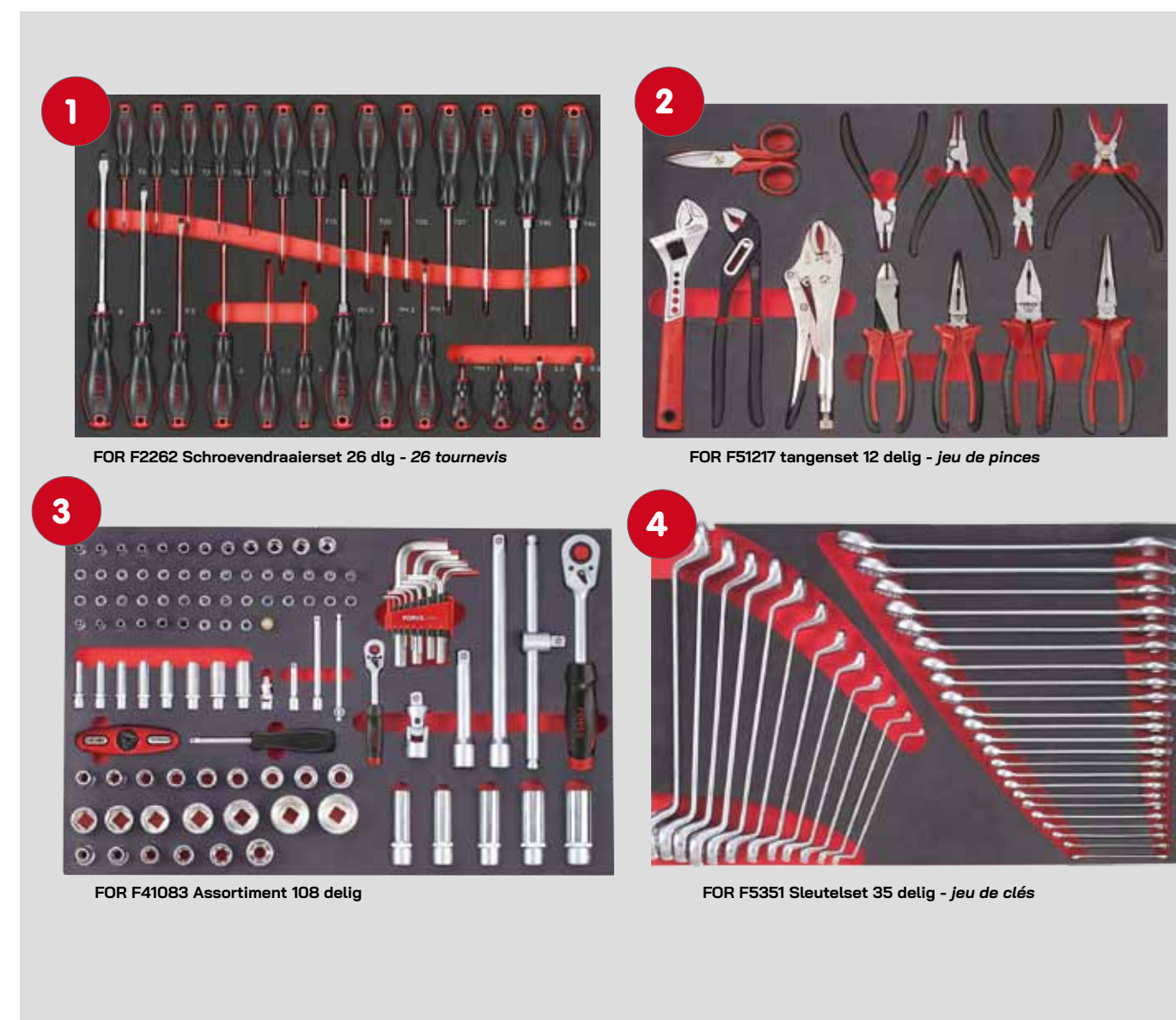
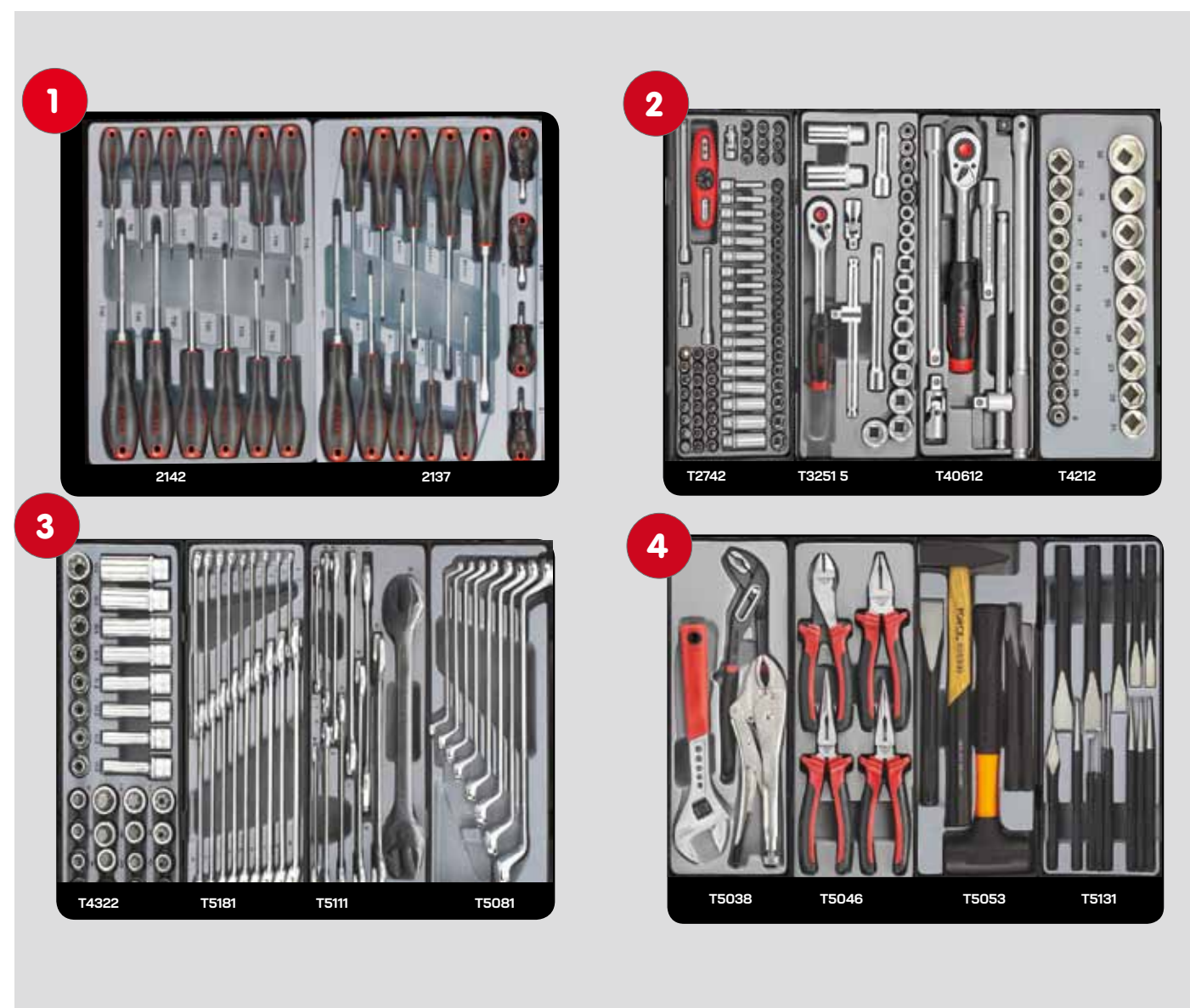







**FOR 102104R/102104C**

Zijtafel voor gereedschapswagen 10217-10218-10318  
*Table pour reception d'ordinateur portable*



**FOR 102105R/102105C**

Papierrolhouder 10217-10218-10318  
*Porte papier*



**FOR 102170CB**

Wiel zwenkbaar met rem dia 125 mm  
*Roue avec frein pivotante*



**FOR 102170C**

Wiel zonder rem dia 125 mm  
*Roue sans frein*



**FOR 102102R/102102C**

Flessenhouder aan de zijkant te bevestigen  
*Porte flacons latéral*



**FOR 102101R/102101C**

Zijkast afsluitbaar met slot & 2 sleutels  
*Coffret latéral avec serrure*



**FOR 102170BBS E**

Ladegeleiders zie pag.  
*Jeu de glissières à billes (voir pag)*

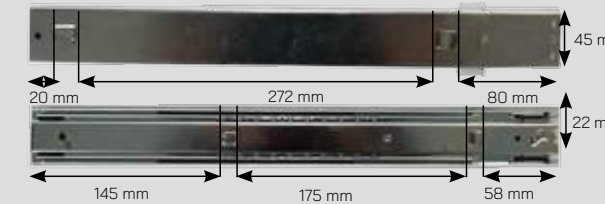

**FOR 102170LK**

Slot 2 sleutels (10225-10217-10218-10318)  
*Serrure + 2 clés (10225-10217-10218-10318)*



**FOR 102106R/102106**

Zijbakje voor spuitbussen  
*Support flacons (L43 x B9 x H12 cm)*



**FOR 102106B/102106A**

Zijbakje voor spuitbussen  
*Support flacons (L43 x B9 x H12 cm)*



**FOR 102170DS**

Lade small (L58cmxB38cmxH6cm)  
*Tiroir small*



**FOR 102170DL**

Lade Large (L58cmxB38xH12cm)  
*Tiroir large*

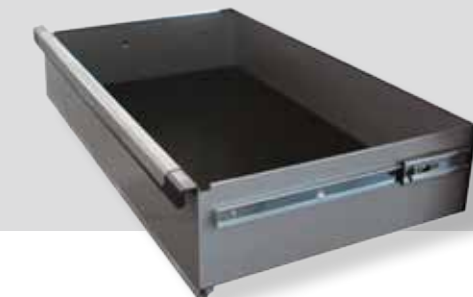

**FOR 102103**

ABS bovenblad 10217-10218  
- 2 ingebouwde handgrepen - 4 sorteerbakjes  
*Plan de travail ABS*



**FOR 10217 SL**

Sleutel (10225-10217-10218-10318)  
*clé (10225-10217-10218-10318)*  
- + nummer op slot vermelden



**FOR 10318C**

**FOR 10318R**  
**FOR 10318B**

**Jumbo Gereedschapswagen 8 laden**

- Afm/dim. laden : 75 cm x 43,5 cm
- 7 laden H 6cm 1 lade H 12cm
- wielen 130 mm : 2 vaste en 2 zwenkwielen waarvan 2 met rem
- kleur : zwart/rood/blauw
- bovenblad
- geleverd met 2 spuitbushouders regelbaar + zijhandvat
- 4 stootranden

**Servante Jumbo 8 tiroirs**

- tiroirs : 75 cm x 43,5 cm
- 7 tiroirs H 6cm 1 tiroir H12 cm
- roues 130 mm : 2 pivotantes 2 avec freins
- couleur : noir-rouge-blue
- 2 supports flaçons + poignée

Afm/dim	L 95 cm	B 50 cm	H 100 cm
gewicht/poids	97.7 kg		totale hoogte

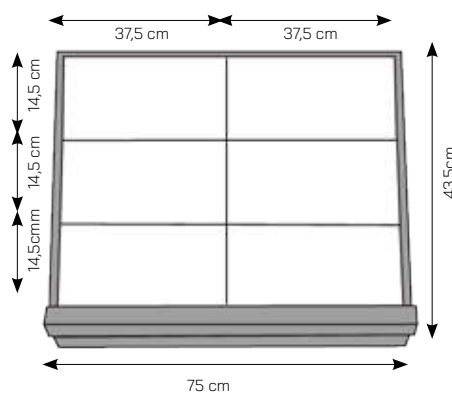

**Jumbo**



**FOR 103106**

Zijbakje voor spuitbussen 10318 jumbo zwart  
(L47 x B9 x H12 Cm)  
Support flaçons 10318 Jumbo noir



**FOR 103106R**

Zijbakje voor spuitbussen 10318 jumbo rood  
Support flaçons 10318 Jumbo rouge



**FOR 103180CB**

Wiel zwenkbaar met rem  
Roue avec frein pivotante



**FOR 103180C**

Vast wiel zonder rem  
Roue sans frein fixe



**FOR 10318BBS**

Ladegeleiders per paar (zie pag. 322)  
Jeu de glissières à billes (voir pag 322 )



**FOR 102170LK**

Slot 2 sleutels (10225-10217-10218-10318)  
Serrure + 2 clés (10225-10217-10218-10318)



**FOR 103180DS**

Lade small (L75cmxB44cmxH6cm)  
Tiroir small



**FOR 103180DL**

Lade Large (L75cmxB44cmxH12 mm)  
Tiroirs large

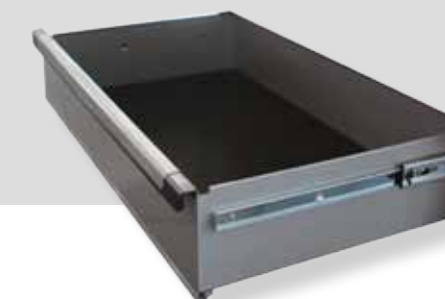



**FOR 10210H1**

Doppenhouder in metaal  
Support pour douilles en metal



**FOR 10210H2**

Houder voor schroevendraaiers  
Support pour tournevis



**FOR 10210H3**

Houder voor sleutels  
Support pour clés



**FOR 10210H4**

Houder voor T sleutels  
Support pour clés en T



**FOR 82023S**

Enkele haak 75 mm L  
Crochet simple 75 mm L



**FOR 82023D**

Dubbele haak 75 mm L  
Crochet double 75 mm L



**FOR 82026S**

Enkele haak 150 mm L  
Crochet simple 150 mm L



**FOR 82026U**

Dubbele haak 150 mm L  
Crochet double 150 mm L



**FOR 10517**

**Gereedschapswagen 7 laden**

- Afmeting laden : 580 mm x 375 mm
- 6 laden - 60 mm hoog
- 2 laden - 120 mm hoog
- 4 gelagerde wielen 130 mm : 2 vaste en 2 zwenkielen waarvan 2 met rem
- met handvat
- electrostatisch gepoedercoat

**Servante 7 tiroirs**

- dimensions tiroirs : 580 mm x 375 mm
- tiroirs 6x60 mm + 2x120 mm
- 4 roues 130 mm : 2 pivotantes 2 avec freins
- poignée en metal
- peinture en poudre epoxy

<b>Afm/dim</b>	L 69 cm	B 46,5 cm	H 98 cm
<b>gewicht/poids</b>	54 kg		totale hoogte

**FOR 50212**

**Service wagen 2 laden**

- Afmeting lades : 58 cm x 37,5 cm
- indeling van de lades hoogte 2x60 mm
- werkblad : 49 cm x 76 cm
- 4 wielen 100 mm : 2 vaste en 2 zwenkwielen waarvan 2 met rem
- handvat
- spuitbushouder
- afvalbakje
- gewicht 27,5kg

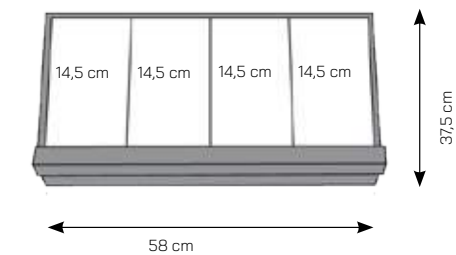

**Service station 2 tiroirs**

- dimensions tiroirs : 58 cm x 37,5 cm
- dimensions tiroirs hauteur 2x60 mm
- plateau : 49 cm x 76 cm
- 4 roues 100 mm : 2 pivotantes, 2 fixes
- poignée
- support flacons
- bac à déchets
- poids 27,5kg





### FOR 50253

#### Werkbank met gereedschapswand en koffer

- Ladenkoffer 3 laden (FOR 50223)
- indeling van de laden : op kogellagers
- veiligheidsslot met 2 sleutels
- bodem van de laden met rubbermatten
- geleverd met 10 dubbele haken
- 10 enkele haken

#### Etabli avec coffret et panneau

- coffret 3 tiroirs
- verrouillage centrale à clé
- livré avec 20 crochets
- capacité 1000kg



### FOR 50254

#### Werkbank met gereedschapswand en koffer

- gereedschapswand met mogelijkheid voor muurbevestiging, roldeur met veiligheidsslot
- Ladenkoffer 3 laden (50223)
- indeling van de laden : op kogellagers
- veiligheidsslot met 2 sleutels
- bodem van de laden met rubbermatten
- geleverd met 10 dubbele haken
- 10 enkele haken
- werkblad van multiplex hout met plastic laminaat
- laadcapaciteit 1000kg

#### Etabli complètement en métal avec coffret et porte-outils

- paroi porte outils
- coffret 3 tiroirs (50223)
- verrouillage à clé du volet
- livré avec 20 crochets
- plan de travail
- capacité 1000kg



### FOR 5001

#### Werkbank

- geleverd zonder koffer

#### Etabli

- sans coffret



### FOR 5003

#### Gereedschapswand

- gereedschapswand met mogelijkheid voor muurbevestiging, roldeur met veiligheidsslot met 2 sleutels
- geleverd met 10 dubbele haken
- 10 enkele haken
- 156cmL x 60.5cmB x 20cmD

#### Armoire

- paroi porte outils
- verrouillage à clé de volet
- livré avec 20 crochets

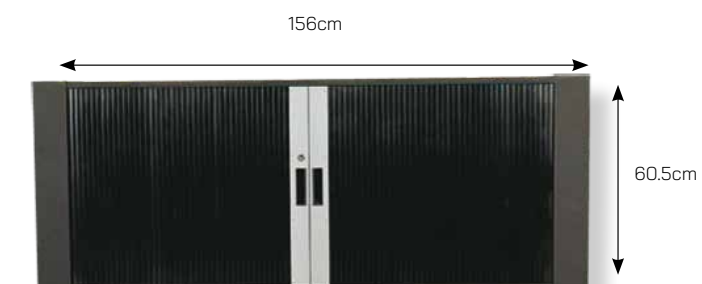

**Ladenkasten plaatstaal - Armoires de rangements**

- centrale vergrendeling met 2 sleutels -fermeture centrale
- 100 kg per lade belastbaar/100 kg par tiroir
- 100% uitschuifbaar, tiroirs s'ouvre 100%
- kleur-couleur : grijs-gris (RAL7035)
- alu handgrepen - manches alu

**TC XC90 5SG**
**Ladenkast 5 laden**
**Armoire 5 tiroirs**

Afm/dim	B 72,3 cm	D 65,3 cm	H 100 cm
3 laden/tiroirs			H 20 cm
2 laden/tiroirs			H 15 cm
gewicht/poids	100 kg		

**TC XC90 6SG**
**Ladenkast 6 laden**
**Armoire 6 tiroirs**

Afm/dim	B 72,3 cm	D 65,3 cm	H 100 cm
3 laden/tiroirs			H 10 cm
2 laden/tiroirs			H 15 cm
1 lade/tiroir			H 20 cm
gewicht/poids	108 kg		

**TC XC90 8SG**
**Ladenkast 8 laden**
**Armoire 8 tiroirs**

Afm/dim	B 72,3 cm	D 65,3 cm	H 100 cm
2 laden/tiroirs			H 7,5 cm
4 laden/tiroirs			H 10 cm
1 lade/tiroir			H 15 cm
1 lade/tiroir			H 20 cm
gewicht/poids	118,10 kg		

**TC XC90 10SG**
**Ladenkast 10 laden**
**Armoire 10 tiroirs**

Afm/dim	B 72,3 cm	D 65,3 cm	H 100 cm
4 laden/tiroirs			H 7,5cm
6 laden/tiroirs			H 10 cm
gewicht/poids	128,20 kg		

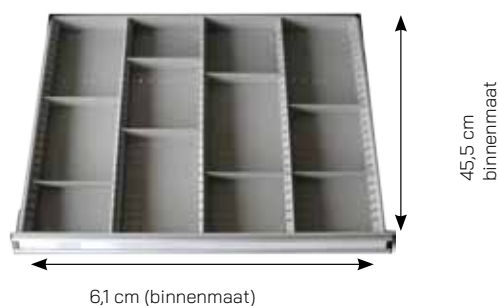
**TC XCDKC**
**Bovenblad frame**
**Plan de travail**

**PVC indelingen voor ladenkasten**
**Bacs de rangements**

Art. nr.	Afm/dim. mm	
TC XC SH11	150 x 150 x 28	roulementen
TC XC SH12	150 x 150 x 28	roulementen
TC XC SH13	150 x 150 x 28	met tusenschotjes
TC XC SH21	750 x 750 x 46	bakje, bacs
TC XC SH22	150 x 75 x 46	bakje, bacs
TC XC SH23	150 x 150 x 46	bakje, bacs

**Universele lade indeling van alle kasten**
**Présentation des tiroirs**
**Lade 1**

- SH11 6 stuks
- SH12 3 stuks
- SH13 3 stuks

**Tiroir 1**

- SH11 6 pièces
- SH12 3 pièces
- SH13 3 pièces

**Lade 2**

- SH21 16 stuks
- SH22 8 stuks
- SH23 4 stuks

**Tiroir 2**

- SH21 16 pièces
- SH22 8 pièces
- SH23 4 pièces

**Andere lades**

- metalen indelingen

**Autres tiroirs**

- rangements en métal

Art. nr.	Afm/dim. mm		
TC XC75	450Lx46H	3st	75 mmH
TC XC75PL	154Lx43H	8st	75 mmH
TC XC100	450Lx71hH	3st	100 mmH
TC XC100PL	154Lx65H	8st	100 mmH
TC XC 150	450Lx121H	3st	150 mmH
TC XC 150PL	154x115H	8st	150 mmH
TC XC 200	450Lx171H	3st	200 mmH
TC XC200PL	154Lx165H	8st	200 mmH





**FOR 10217C219**  
**FOR 10217R219**

**Gevulde gereedschapswagen 7 laden gevuld met gereedschap 219 delig**  
- 3 laden gevuld 12 modules  
gewicht : 87,3kg

**Servante d'atelier 7 tiroirs avec outils 219 pcs**  
- 12 modules pour 3 tiroirs  
poids : 87,3 kg



**FOR VUL 219**

**Assortiment gereedschap 219 delig**  
- 3 laden 12 modules

**Assortiment d'outils 219 pcs**  
- 12 modules pour 3 tiroirs

**FOR 10217C245**  
**FOR 10217R245**

**Gevulde gereedschapswagen 7 laden gevuld met gereedschap 245 delig**  
- 4 laden gevuld 15 modules  
- gewicht :100kg

**Servante d'atelier 7 tiroirs avec 245 pcs d'outils**  
- 15 modules pour 4 tiroirs  
- poids - 100kg



**FOR VUL 245**

**Assortiment gereedschap 245 delig**  
- 4 laden - 15 modules

**Assortiment d'outils 245 pcs**  
- 15 modules pour 4 tiroirs

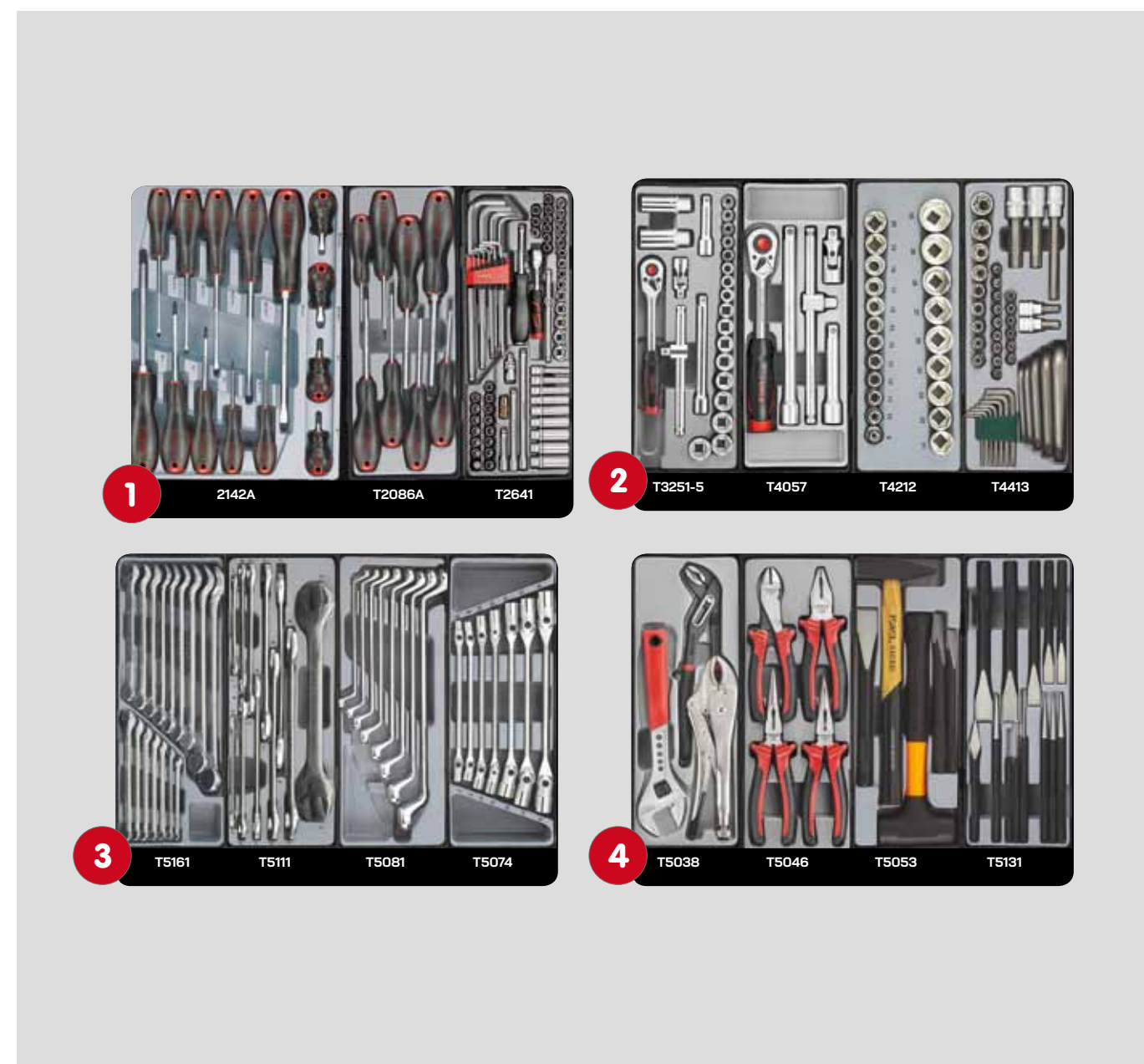
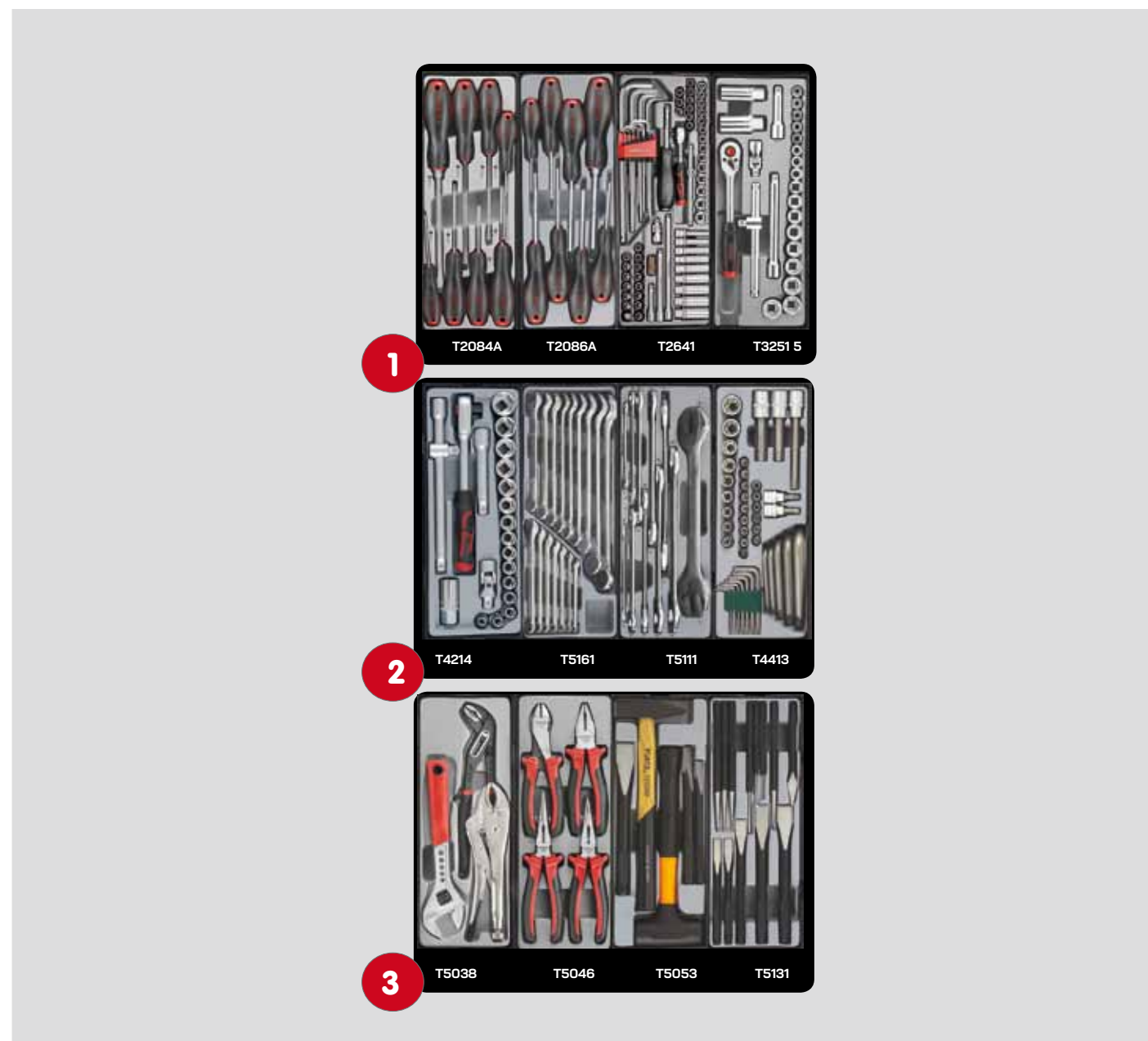



**FOR 10217C286**

**FOR 10217R286**

**FOR 10217A286**

**FOR 10217B286**

Gereedschapswagen 7 laden gevuld met gereedschap 286 delig

- 6 laden gevuld 22 modules
- gewicht :105kg

*Servante mobile d'atelier 7 tiroirs avec 286 pcs d'outils*

- 22 modules pour 6 tiroirs poids : 105 kg

**FOR VUL 286**

Assortiment gereedschap 286 delig

- 6 laden - 22 modules

*Assortiment d'outils 286 pcs*

- 22 modules pour 6 tiroirs



**FOR 10217C306**

**FOR 10217R306**

**FOR 10217A306**

**FOR 10217B306**

Gereedschapswagen 7 laden gevuld met gereedschap 306 delig

- 6 laden gevuld 22 modules
- gewicht : 106.7 kg

*Servante mobile d'atelier 7 tiroirs avec 306 pcs d'outils*

- 22 modules pour 6 tiroirs
- poids 106.7 kg

**FOR VUL 306**

Assortiment gereedschap 306 delig

- 6 laden - 22 modules

*Assortiment d'outils 306 pcs*

- 22 modules pour 6 tiroirs

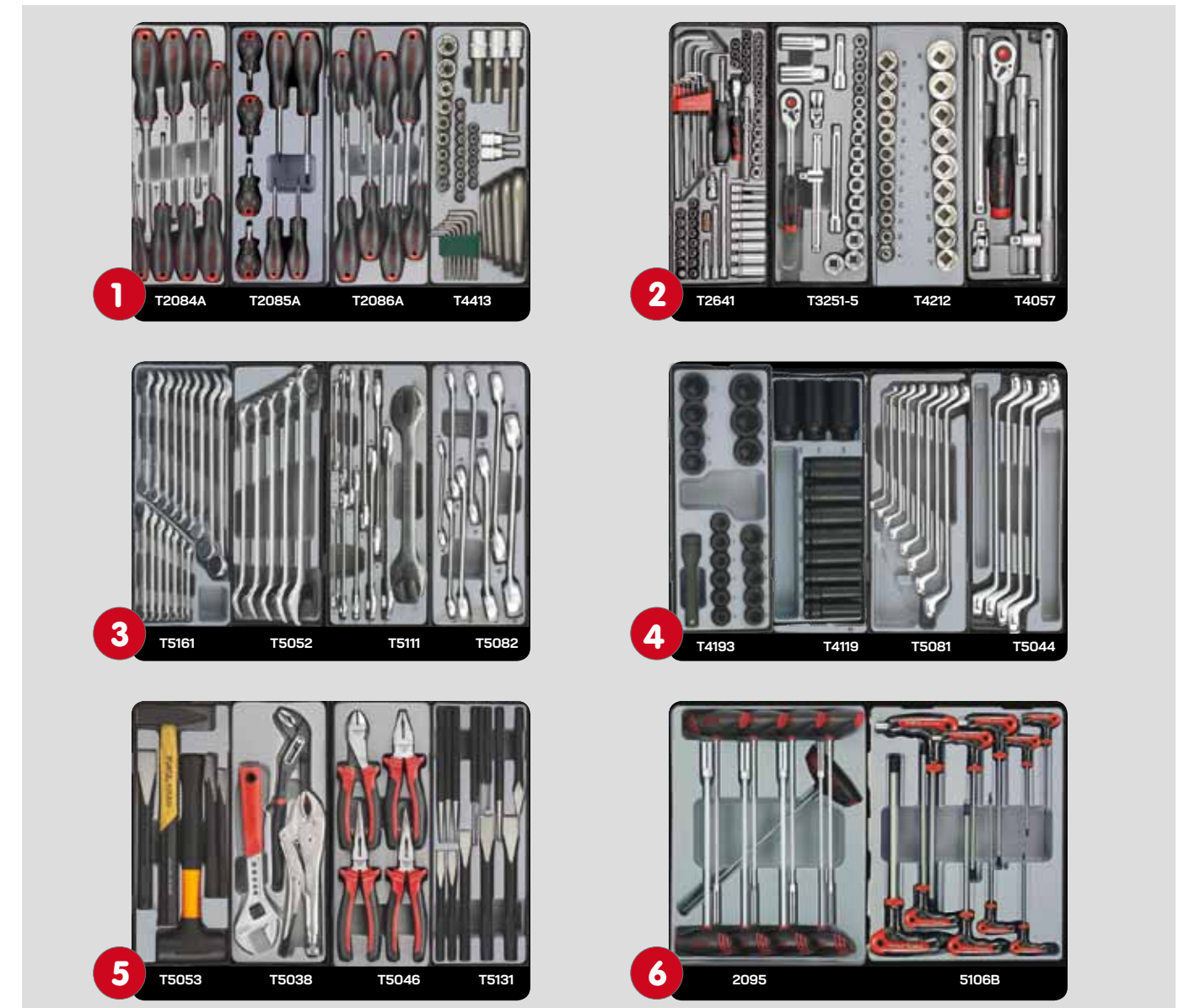
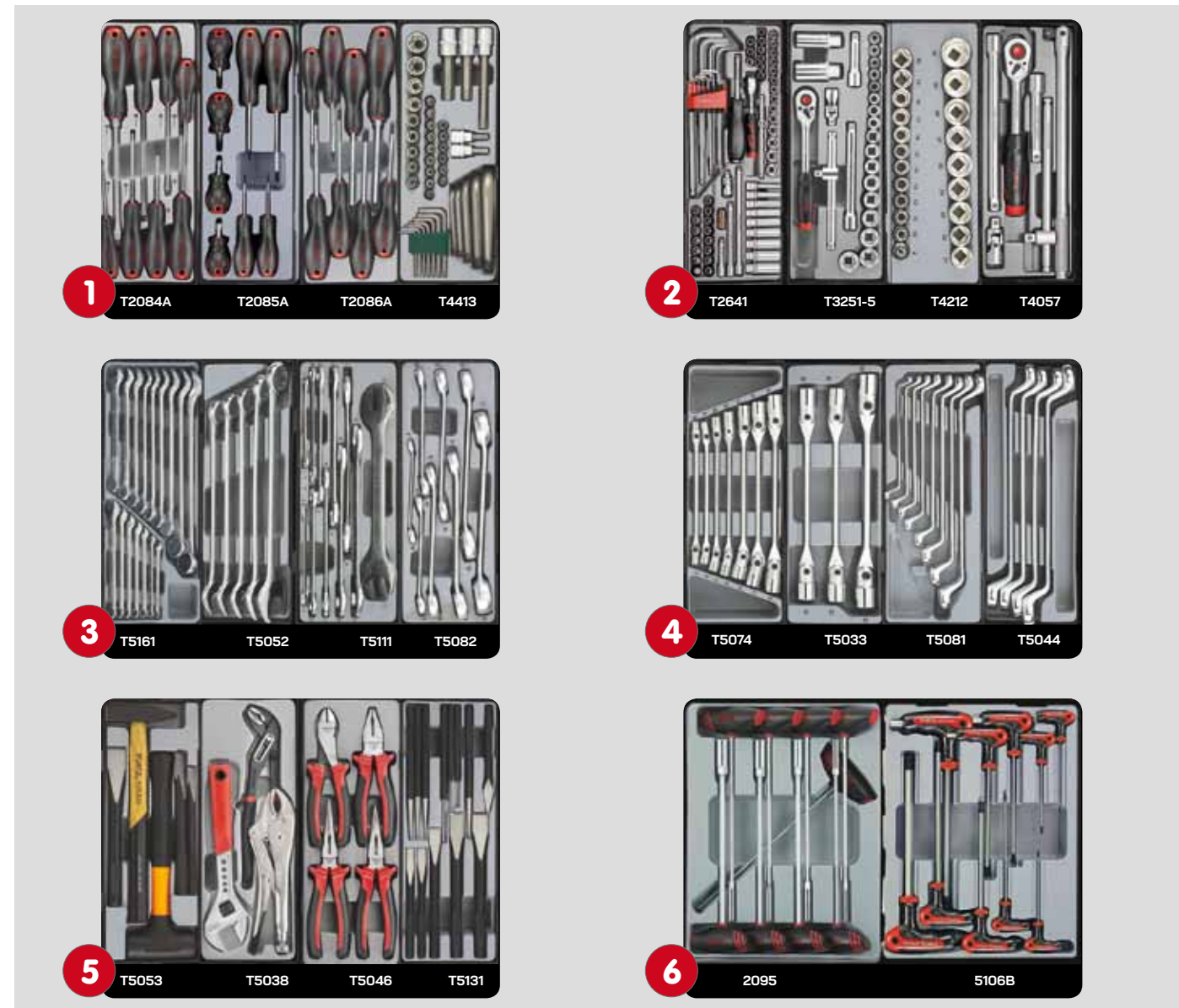



**FOR 10217C361**

**FOR 10217R361**

Gereedschapswagen 7 laden gevuld met gereedschap 361 delig

- 6 laden gevuld 24 modules
- gewicht : 107.3 kg

Servante mobile d'atelier 7 tiroirs avec 361 pcs d'outils

- 24 modules pour 6 tiroirs
- poids : 107.3 kg



**FOR VUL 361**

Assortiment gereedschap 361 delig

- 6 laden gevuld - 20 modules

Assortiment d'outils 361 pcs

- 20 modules pour 6 tiroirs

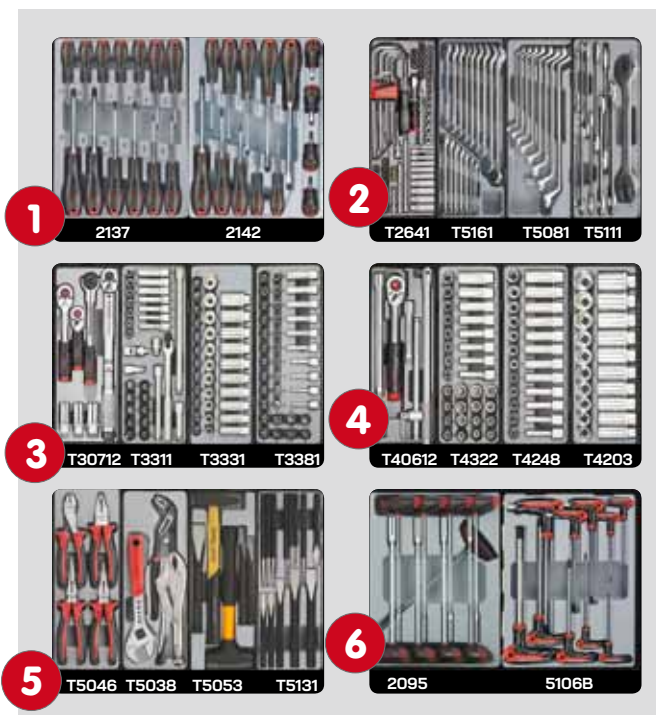

**FOR 10218C376**

**FOR 10218R376**

**FOR 10218B376**

Gevulde gereedschapswagen 8 laden gevuld met gereedschap 376 delig

- 6 laden gevuld 22 modules
- gewicht : 112.7 kg

Servante mobile d'atelier 8 tiroirs avec 376 pcs d'outils

- 22 modules pour 6 tiroirs
- gewicht 112.7 kg



**FOR VUL 376**

Assortiment gereedschap 376 delig

- 6 laden - 22 modules

Assortiment d'outils 376 pcs

- 22 modules pour 6 tiroirs

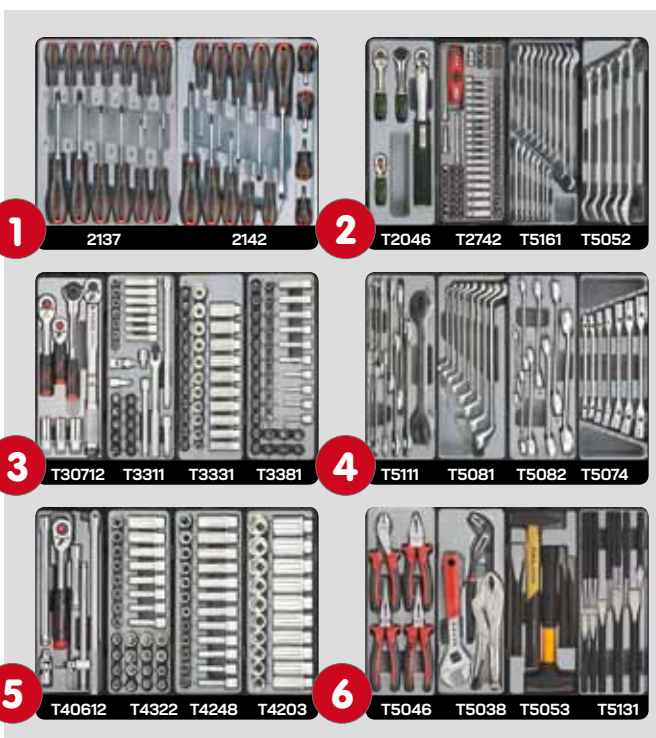

**FOR 10318C437**

**FOR 10318R437**

Gevulde gereedschapswagen 8 laden gevuld met gereedschap 437 delig

- 6 laden gevuld 32 modules
- gewicht :192 kg

Servante mobile d'atelier 8 tiroirs avec 437 pcs d'outils

- 32 modules pour 6 tiroirs
- poids : 192kg



**Jumbo**

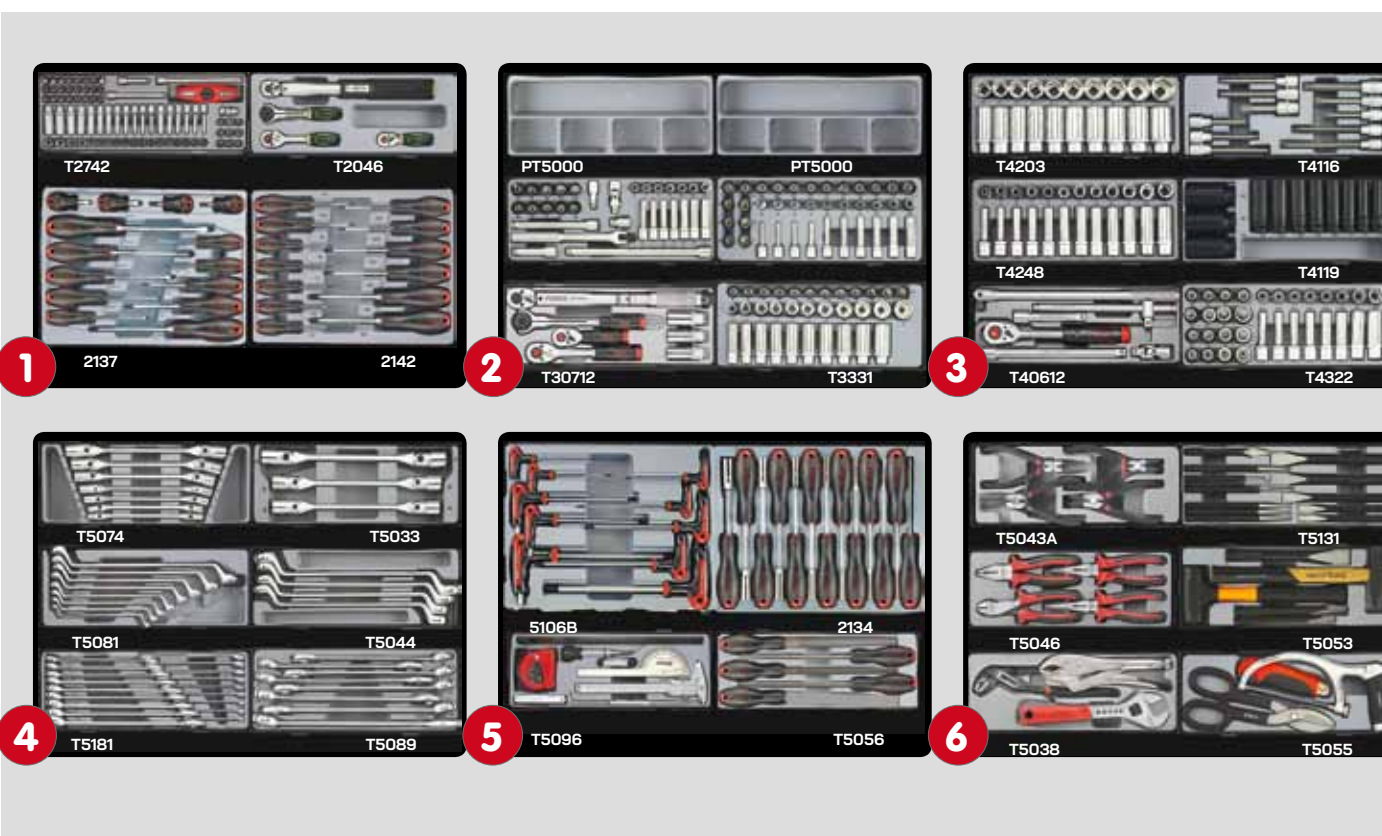

**FOR VUL 437**

Assortiment gereedschap 437 delig

- 6 laden 32 modules

Assortiment d'outils 437 pcs

- 32 modules pour 6 tiroirs





**FOR 10318C431**

Gereedschapswagen 6 laden gevuld met gereedschap 431 delig mm & engelse maten

- 6 laden gevuld 32 modules
- gewicht : 200kg

Servante mobile d'atelier 8 tiroirs avec 431 pcs d'outils metric + en pouce

- 6 tiroirs avec 22 modules
- poids : 200kg



**Jumbo**

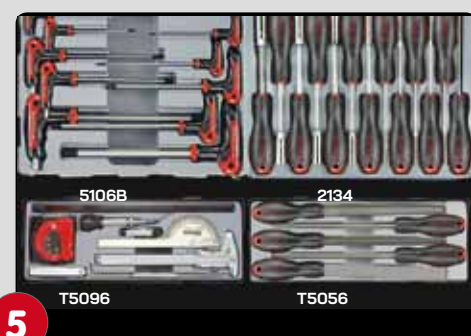

**FOR 1013-562  
FOR 1013R562**

Gevulde gereedschapswagen 8 laden gevuld + koffer 5 laden met gereedschap 562 delig

Servante mobile d'atelier 8 tiroirs avec coffret 5 tiroirs avec 562 pcs d'outils

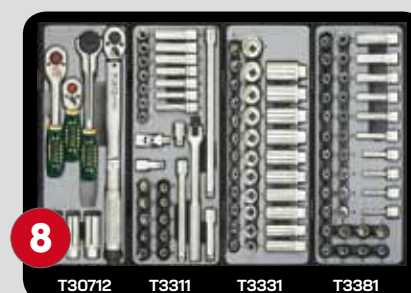



**FOR 10217C198**

**Gevulde gereedschapswagen 7 laden gevuld met gereedschap 198 delig**

- 5 laden gevuld foams
- gewicht : 111kg

**Servante mobile d'atelier 7 tiroirs avec 198 pcs d'outils**

- 5 tiroirs avec mousse
- poids : 111kg

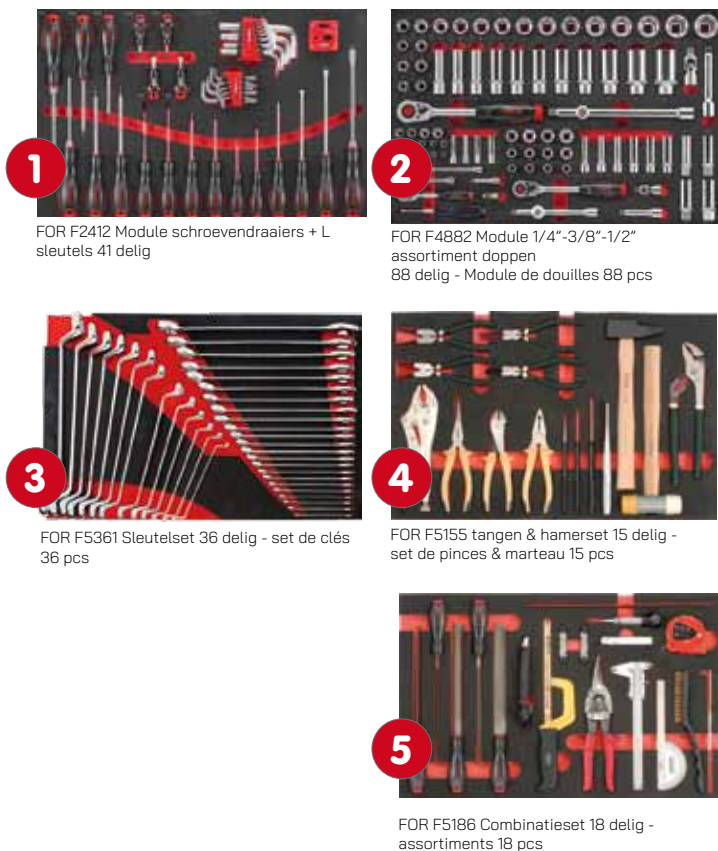

**FOR 10217C259**

**Gevulde gereedschapswagen 7 laden gevuld met gereedschap 259 delig**

- 5 laden gevuld 5 foams
- gewicht 74.5kg

**Servante mobile d'atelier 7 tiroirs avec 259 pcs d'outils**

- 5 modules en mousse
- poids : 75.4 kg

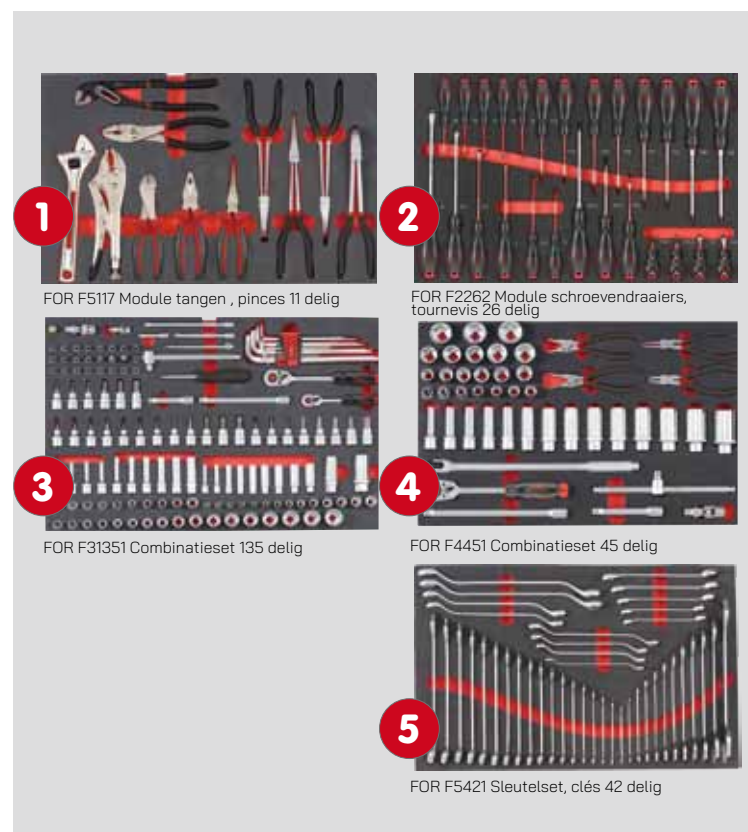

**FOR 10217C308**

**Gevulde gereedschapswagen 7 laden gevuld met gereedschap 308 delig**

- 6 laden gevuld
- gewicht : 111kg

**Servante mobile d'atelier 7 tiroirs avec 308 pcs d'outils**

- 6 tiroirs avec 6 modules mousse
- poids : 111kg

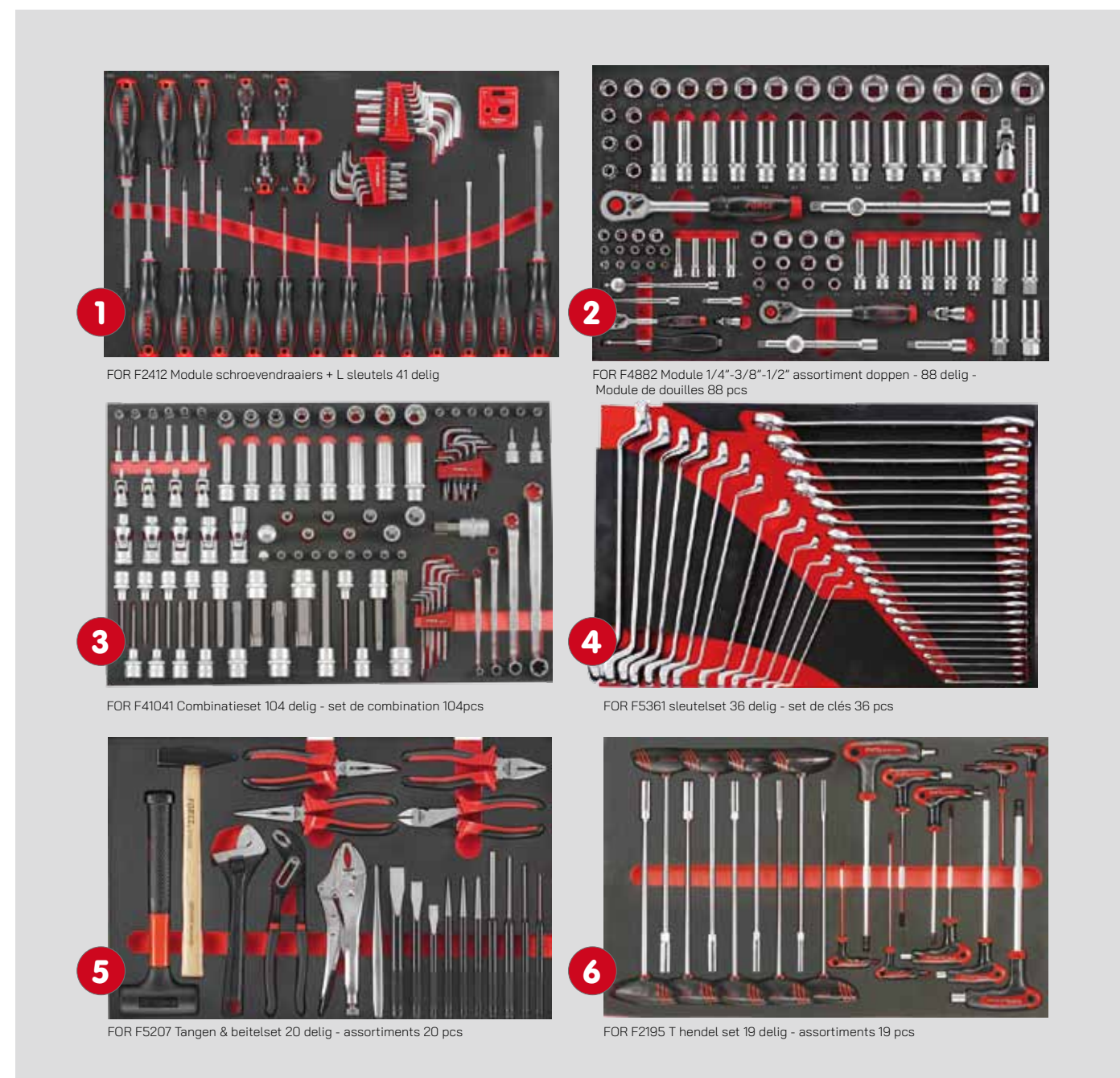



**FOR 10318C298**

Gevulde jumbo gereedschapswagen 8 laden  
gevuld met gereedschap 298 delig  
- 5 laden gevuld

Servante mobile d'atelier 8 tiroirs avec 298 pcs d'outils  
- 5 modules pour 8 tiroirs



**Jumbo**



**FOR 10318C610**

Gevulde jumbo gereedschapswagen 8 laden  
gevuld met gereedschap 610 delig  
- 8 laden gevuld

Servante mobile d'atelier 8 tiroirs avec 610 pcs d'outils  
- 8 modules pour 8 tiroirs



**Jumbo**

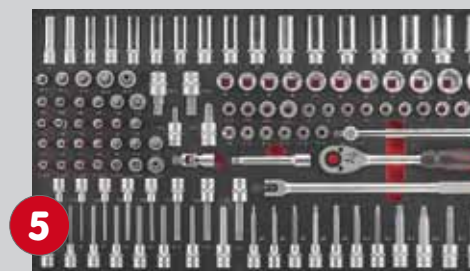
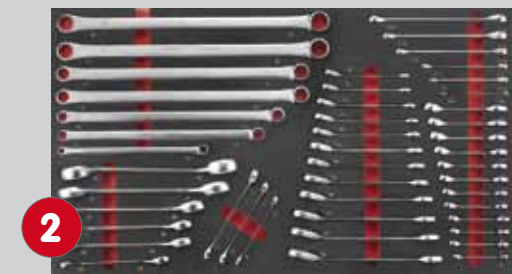
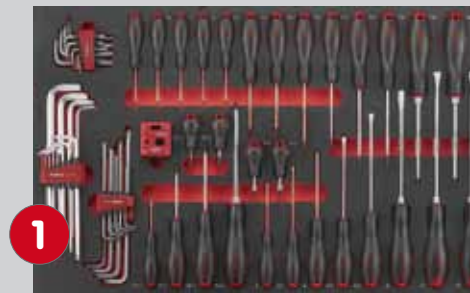
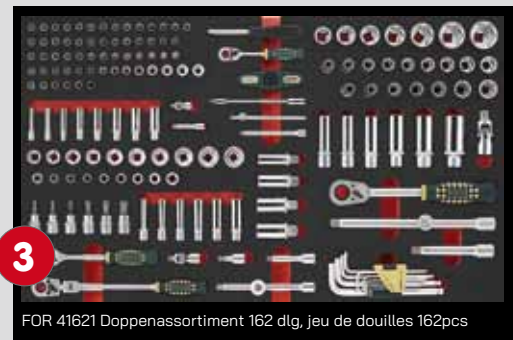
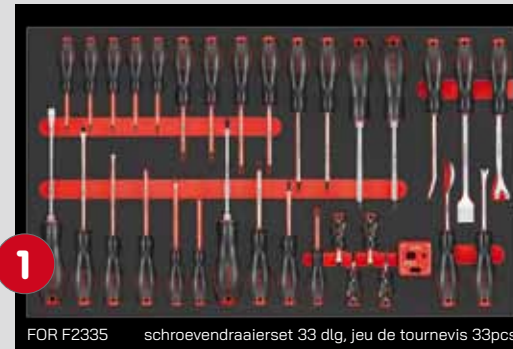



**FOR 10318C509**  
**FOR 10318R509**

Gevulde jumbo gereedschapswagen 8 laden  
gevuuld met gereedschap 509 delig  
- 8 laden gevuld

*Servante mobile d'atelier 8 tiroirs avec 509 pcs d'outils*  
- 8 modules pour 8 tiroirs

**Jumbo**

FOAM  
SYSTEM  
MOUSSE



**FOR 10318C607**

Gevulde jumbo gereedschapswagen 8 laden  
gevuuld met gereedschap 607 delig voor trucks  
- 8 laden gevuld

*Servante mobile d'atelier 8 tiroirs avec 607 pcs d'outils*  
- 8 modules pour 8 tiroirs

FOAM  
SYSTEM  
MOUSSE

**Jumbotruck**

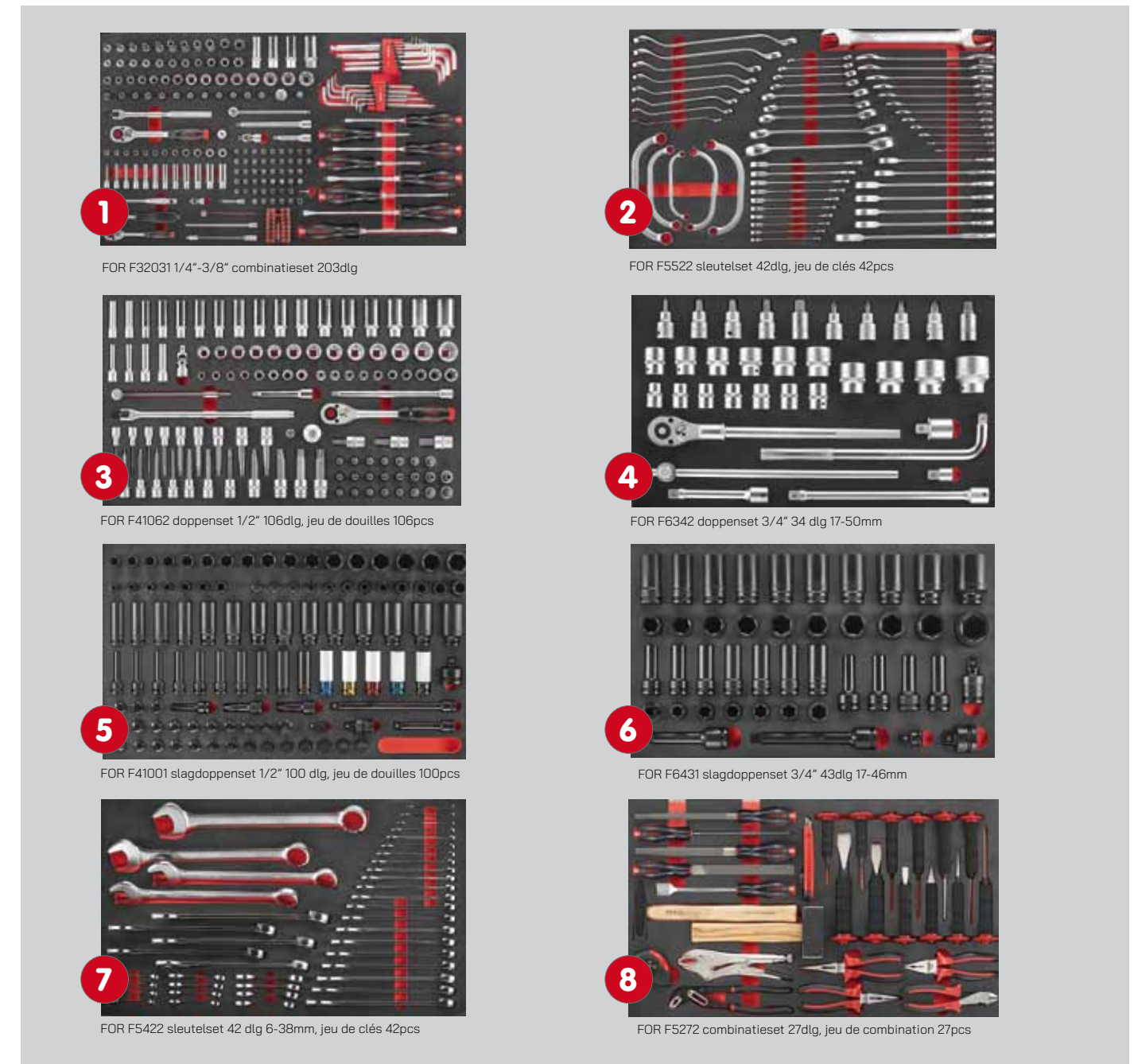
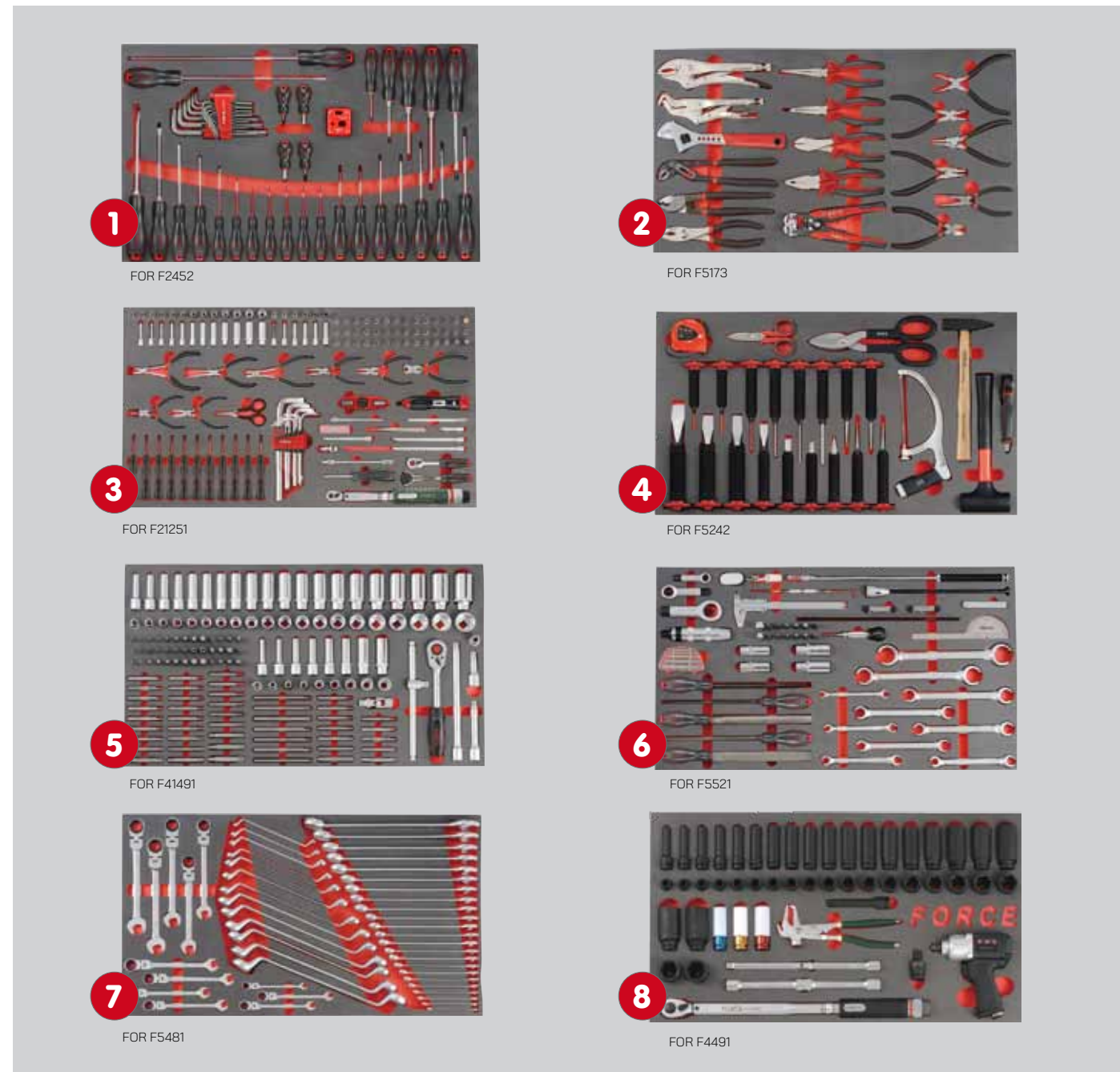



## TC module systeem

maak je eigen selectie en stel zelf je gereedschapswagen samen  
composer votre servante

- 4 modules per lade (50223-10225-10217-10218)
- 6 modules per lade (enkel Jumbo model 10318)
- afm. TC module 37cm x 14cm
- alle modules ook leeg verkrijgbaar - module vide livrable

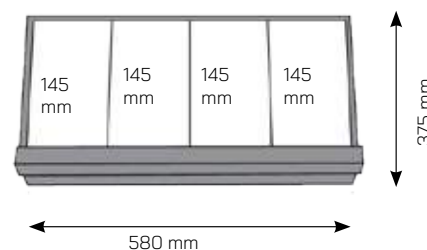

<b>TC module</b> 37cm x 14 cm 4 per lade 10217-10218 -10517 6 per lade 10318			
---	--	--	--

<b>Large module</b> 37cm x 28 cm 2 per lade	
---	--

### FOR T2084A

Schroevendraaierset 8 delig  
Module 8 tournevis



### FOR T2085A

Schroevendraaierset pozidriv 8 delig  
Module 8 tournevis pozidriv

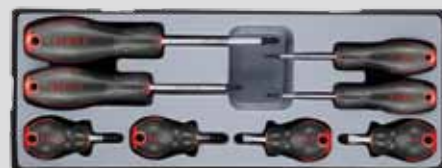

### FOR T2086A

Torx schroevendraaierset 8 delig  
Module 8 tournevis torx



### FOR T20712

Schroevendraaierset geïsoleerd 8 delig  
Module 8 tournevis 1000v



### FOR T2173

Mini schroevendraaierset 17 delig  
Module 17 tournevis mini

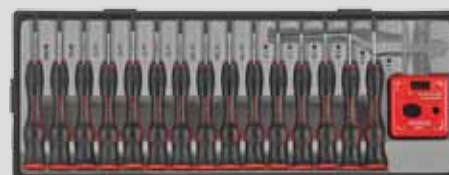

### FOR T20612

Module 6dlg schroevendraaiers op dop  
Module 6 tournevis sur douilles



### FOR T50637

Module 6 inbussleutel met handvat  
Module 6 clés mâles avec poignée L 2-3-4-5-6-8mm

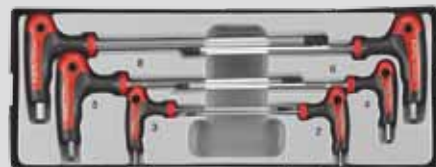

### FOR T2045

1/4" Ratelset 4 delig  
Module cliquet 1/4" 4 pcs



### FOR T2641

1/4" Doppenassortiment 65 delig  
Module douilles et acc. 65 pcs 1/4"



### FOR T2742

1/4" Doppenassortiment 74 delig  
Module assortiment douilles 1/4" 74 pcs



### FOR T2741

1/4" Doppenassortiment mm + Inch 74 delig  
Module douilles et acc. 74 pcs 1/4" mm + Inch



### FOR PT.....

Alle lege modules verkrijgbaar  
Toutes les modules livrables, ajouter "P" devant la référence pour obtenir la module vide

### FOR T4583

Module 58dlg dop-bit-torx- inbus set  
Module 58 embouts - douilles torx hex





**FOR T30711**

3/8" Ratelset 7 delig  
Module cliquet 3/8" 7 pcs

**FOR T30712**

3/8" Ratelset 7 delig  
Module cliquet 3/8" 7 pcs

**FOR T3521**

Torxset 52 delig  
Module jeu de torx 52 pcs

**FOR T3361**

Doppenassortiment 36 delig  
Module douilles et acc 36 pcs

**FOR T3251 5**

3/8" Doppenassortiment 24 delig  
Module douilles et acc. 24 pcs 3/8"

**FOR T3212**

3/8" Doppenassortiment 21 delig inch  
Module douilles et acc. en pouce 21 pcs 3/8"

**FOR T31010**

3/8" Bougiedoppenset 10 dlg  
Module douilles pour bougies 3/8" 10pcs

**FOR T8151**

Slagmoer adapter set 15 delig  
Module 15 réducteur à choc

**FOR T3193**

3/8" Doppenset kort + lang inch 19 delig 6k  
Module 19 douilles en pouce 3/8" 6p

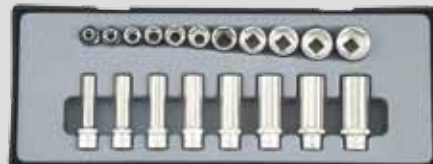
**FOR T3121**

3/8" Lange doppenset 12 delig 6k  
Module 12 douilles longues 6p

**FOR T3331**

3/8" Doppenset 33 delig kort + lang  
Module 33 douilles 3/8"

**FOR T3322**

3/8" Doppenassortiment 32 delig mm & inch  
Module de douilles 32 pcs mm + inch

**FOR T3311**

3/8" Kombinatieset 31 delig  
Module douilles et acc. 31 pcs 3/8"

**FOR T3381**

3/8" Torx & XZN set 38 delig  
Module 38 douilles torx & XZN 3/8"

**Slagdoppen - douilles à choc****FOR T4193**

1/2" Slagdoppenset 19 delig 6kant  
Module 19 douilles à choc 1/2" 6pans

**FOR T4205**

1/2" Slagdoppenset torx-inbus 20 delig  
Module 20 douilles à chocs torx-hex

**FOR T4119**

1/2" Lange slagdoppenset 11 delig 6kant  
Module 11 douilles à choc longues 1/2" 6pans

**FOR T40813**

1/2" Lange slagdoppenset 11 delig 12 kant  
Module 11 douilles à choc longues 1/2" 12pans

**FOR T6121**

3/4" Slagdoppenset 12 delig 6kant  
Module 12 douilles à choc 3/4" 6pans

**FOR T6085**

3/4" Lange slagdoppenset 8 delig  
Module 8 douilles à choc longues 3/4"





**FOR T4057**

1/2" Ratelset & accessoires 5 delig  
Module de 4 accessoires + cliquet 1/2"



**FOR T40612**

1/2" Ratelset & accessoires 6 delig  
Module de 5 accessoires + cliquet 1/2"



**FOR T4226**

1/2" Doppenset 6k 22 delig  
Module douilles 6 pans 22 pcs 1/2"



**FOR T4413**

Torxset 41 delig  
Module douilles torx 41 pcs



**FOR T4212**

1/2" Doppenset metric 6k 21 delig  
Module 21 douilles 6 pans 1/2"



**FOR T4212-9**

1/2" Doppenset 12k 21 delig  
Module 21 douilles 12 pans 1/2"



**FOR T4122**

1/2" Mixed doppenset 12 delig  
Module 12 douilles tournevis 1/2"

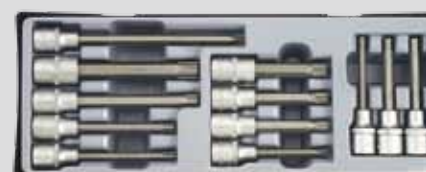

**FOR T4116**

1/2" Mixed doppenset 11 delig  
Module 11 douilles 1/2"

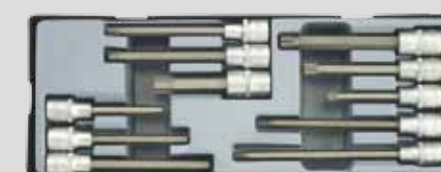

**FOR T4194**

1/2" Doppenset 19 delig inch 6k  
Module 19 douilles 6 pans en pouce 1/2"



**FOR T4203**

1/2" Doppenset kort + lang 6kant 20 delig  
Module 20 douilles 6 pans 1/2"



**FOR T4322**

1/2" Torx & XZN dopbitset 32 delig  
Module 32 douilles torx & XZN 1/2"



**FOR T4281**

1/2" Doppensortiment 27 delig  
Module 27 douilles 1/2"

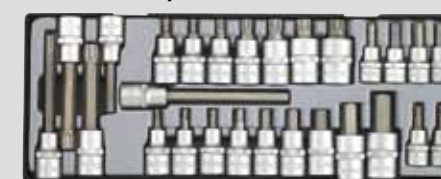

**FOR T4143**

1/2" Lange doppenset 6k 14 delig  
Module 14 douilles longues 6 pans 1/2"



**FOR T4143 9**

1/2" Lange doppenset 12k 14 delig  
Module 14 douilles longues 12 pans 1/2"



**FOR T4355**

1/2" Torx & XZN dopbitset 35 delig  
Module 35 douilles torx & XZN 1/2"



**FOR T41710**

1/2" Inbus doppenset 17 delig  
Module 17 douilles hexagonales 1/2"

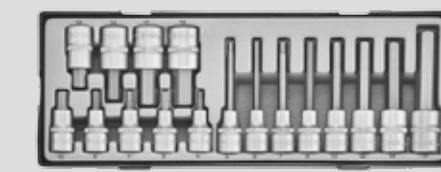

**FOR T4248S**

1/2" Doppenset kort + lang inch 6k 24 delig  
Module 24 douilles 6 pans en pouce 1/2"



**FOR T4248**

1/2" Doppenset kort + lang 6k 24 delig  
Module 24 douilles 6 pans 1/2"



**FOR T4179**

1/2" XZN dopbitset 17 delig  
Module 17 douilles XZN 1/2"

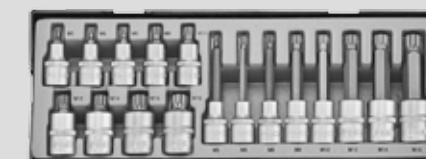

**FOR T4165**

1/2" Torx doppenset 16 delig  
Module 16 douilles torx 1/2"

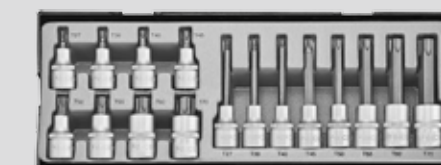



**FOR T5046**

Tangenset 4 delig  
Module 4 pinces



**FOR T5043A**

Borgveertangenset 4 delig  
Module 4 pinces circlips



**FOR T50410**

Geïsoleerde tangenset 4 delig  
Module 4 pinces isolées 1000v



**FOR T5038**

Tangenset 3 delig  
Module 3 pinces



**FOR T5023**

Verstelbare moersleutelset 2 delig  
Module 2 clés à molette



**FOR T5036**

Verstelbare moersleutelset 2 delig  
Module 2 clés à molette



**FOR T5047**

Lange tangenset 4 delig  
Module 4 pinces longues



**FOR T50814**

Minitangenset 8 delig  
Module 8 pinces mini



**FOR T5057**

Multi grip tangenset 5 delig  
Module 5 pinces étau axiale



**FOR T5161**

Steekringsleutelset 16 delig  
Module 16 clés mixtes



**FOR T5134**

Steekringsleutelset inch-13 delig  
Module 13 clés mixtes en pouce



**FOR T5181**

Steekringsleutelset 18 delig  
Module 18 clés mixtes



**FOR T5089**

Steekringsleutelset 8 delig  
Module 8 clés mixtes



**FOR T5052**

Steekringsleutelset 5 delig  
Module 5 clés mixtes



**FOR T51214**

Mini steekringsleutelset 12 delig  
Module 12 clés mixtes courte



**FOR T5111S**

Steekleutelset 11 delig inch  
Module 11 clés à fourches en pouce



**FOR T5111**

Steekleutelset 11 delig  
Module 11 clés à fourches



**FOR T5081**

Gebogen ringsleutelset 8 delig 75°  
Module 8 clés polygonales 75°



**FOR T5044**

Gebogen ringsleutelset 4 delig 75°  
Module 4 clés polygonales



**FOR T5074**

Kniesleutelset 7 delig  
Module 7 clés à douilles articulées



**FOR T5033**

Kniesleutelset 3 delig  
Module 3 clés à douilles articulées



**FOR T5079S**

Gebogen ringsleutelset inch 7 delig 75°  
Module 7 clés polygonales 75° en pouce



**FOR T5085**

Gebogen ringsleutelset 8 delig 45°  
Module 8 clés polygonales 45°



**FOR T50616S**

Kniesleutelset 6 delig inch  
Module 6 clés à douilles articulées inch



**FOR T5172**

Opsteek steeksleutelset 17 delig  
Module 17 clés pied à corneille



**FOR T51226**

Platte ringsleutelset 12 delig 6-32 mm  
Module 12 clés à polygonales plates 6-32 mm



**FOR T5085S**

Gebogen ringsleutelset inch 8 delig 45°  
Module 8 clés polygonales 45° en pouce



**FOR T51211**

Ratel-steekringsleutel omkeerbaar 12 delig  
Module 12 clés mixtes à cliquet resersible 8-19 mm



**FOR T51210**

Ratel-steekringsleutel 12 delig  
Module 12 clés mixtes à cliquet



**FOR T50817**

Pijpsleutelset 8 delig 6k  
Module 8 clés en tube



**FOR T5114**

Gebogen pijpsleutelset 11 delig  
Module 11 clés à pipe débouchée



**FOR T5164R**

Omkeerbare ratelsleutelset met adapters 16 delig  
Module 16 clés mixtes à cliquet réversible

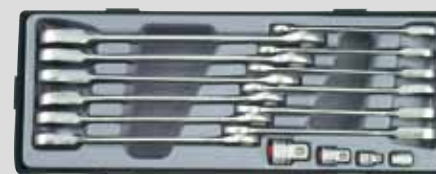

**FOR T50617**

Ring ratelsleutel torx 6 delig  
Module 6 clés à cliquet torx



**FOR T5082**

Open ringsleutelset 8 delig  
Module 8 clés tuyauter



**FOR T50710S**

Open ringsleutelset inch 7 delig  
Module 7 clés tuyauter en pouce



**FOR T50810**

Ring-ratelsleutelset 8 delig 8-22 mm  
Module 8 clés polygonales à cliquet 8-22 mm



**FOR T50811**

Gebogen ringratelsleutelset 8 delig 8-22 mm  
Module 8 clés polygonales courbé à cliquet 8-22 mm





**FOR T51811**

Riveteertangset 181 delig  
Module pince à riveter 181 pcs

**FOR T5056**

Vijlenset 5 delig  
Module 5 limes

**FOR T5122**

Olie pluggenset 12 delig  
Module 12 outils de graissage

**FOR T905M2**

Demontage gereedschapset 5 delig  
Module 5 grattoirs & crochets

**FOR T5331**

Repair tools set 33 delig  
Module 33 outils reparation

**FOR T5053**

Hamer - beitelset 5 delig  
Module 5 acc.marteau et burins

**FOR T5131**

Beitel - en penuitdrijverset 13 delig  
Module 13 poinçons et burins

**FOR T5096**

Meetgereedschapset 9 delig  
Module d'outillage de mesure 9 pcs

**FOR T5055**

Snijgereedschapset 5 delig  
Module 5 outils à couper

**FOR PT5000**

Module leeg B38cm x L14 cm x H4.5cm  
Module vide 38x14 cm



# Large

Modulair syteem | 2 per lade (28x37cm x H4cm)

**FOR 2142A**

Schroevendraaierset 14 delig  
Module 14 tournevis

**FOR 2137A**

Torx schroevendraaierset 13 delig  
Module 14 tournevis torx

**FOR 2108**

Hamer schroevendraaierset 10 delig philips  
Module 10 tournevis à frappe, philips/plat

**FOR 2109**

Hamer schroevendraaierset 10 delig pozidriv  
Module 10 tournevis à fraper pozidriv/plat

**FOR 2125**

Schroevendraaierset 1000v PH 12 delig  
Module 12 tournevis 1000v

**FOR 2126**

Schroevendraaierset 1000v pozidriv 12 delig  
Module 12 tournevis 1000v pozidriv



**FOR 2095**

Dop op T handvat 9 delig  
 Module 9 douilles poignées en T

**FOR 2095S**

Dop op T handvat inch 9 delig  
 Module 9 douille sur douille en pouce - poignées en T

**FOR 2141**

Torx op T handvat 14 delig  
 Module 14 torx poignées en T

**FOR 2141T**

Resistorx T handvat 14 delig  
 Module 14 resistorx poignées en T

**FOR 5106B**

Inbus-ballpoint L hendel 10 delig  
 Module 10 clés mâles poignées en L

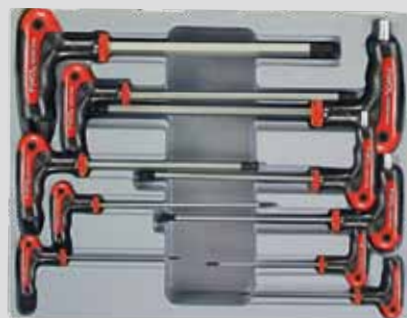
**FOR 50910BS**

Inbus-ballpoint L hendel 9 delig inch  
 Module 9 clés mâles poignées en L en pouce

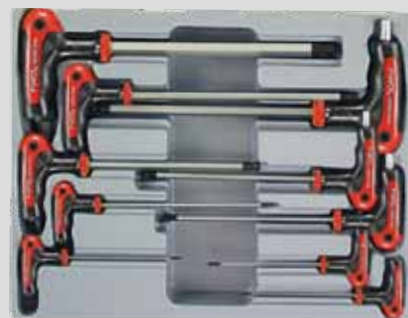
**FOR 51010T**

Resistorx op L handvat 10 delig  
 Module resistorx 10 pcs

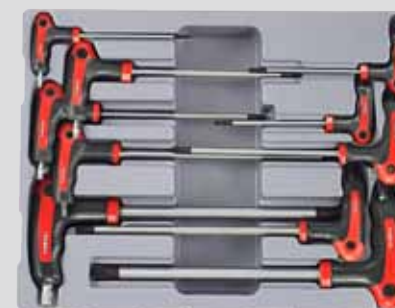
**FOR 2096**

Inwendige torx dop op T handvat 9 delig  
 Module 9 torx sur douille - poignées en T

**FOR 2097**

Inbusleutel op T handvat 9 delig  
 Module 10 clés mâles poignées en T

**FOR 2097B**

Inbus met bolkop op T handvat 9 delig  
 Module 9 clés mâles poignées en T

**FOR 2134**

Dopschroevendraaier 6k 13 delig  
 Modules 13 tournevis douilles

**FOR 2097S**

Inbus op T handvat 9 delig inch  
 Module 9 clés mâles poignées en T tête sphér. en pouce

**FOR 50912**

T sleutels met inbus 9 delig  
 Module 9 clés mâles poignées en T

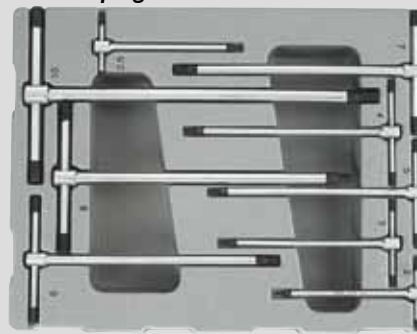



**FOR 5048**

Striptangenset 4 delig  
Module 4 pinces à sertir



**FOR 54111**

Strip set 411 delig  
Module 411 pcs + pince à dénuder



**FOR 5138**

Beitel-doorslagenset 13 delig  
Module 13 burins & poinçons gainés



**FOR 50713**

Uitdeukset 7 delig  
Module kit de deblossage 7 pcs



**FOR 50816**

Universeel cardangewrichtsleutels lang 8 delig  
Clés cardan universelles 8 pcs

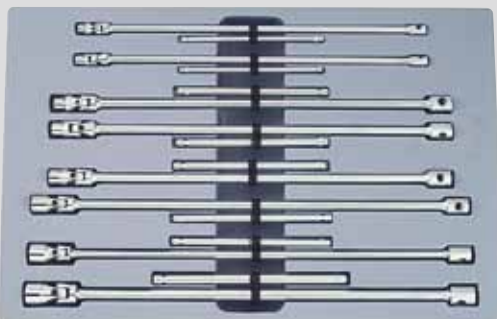

**FOR 50911**

Halvemaansleutelset 9 delig  
Module 9 clés demi-lune

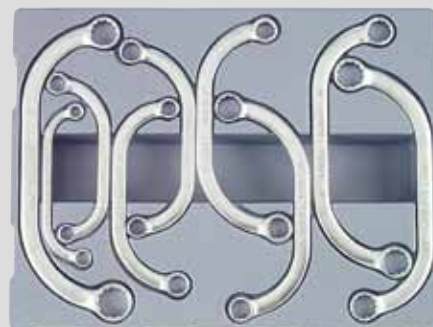

**FOR PPTSK130**

Open doos voor TC module (38 x 14 mm x 4.5)  
TC module vide



**FOR PPVSK130**

Deksel voor TC module  
Couvercle pour TC module



**Foam system -mousse**

- ✓ ieder gereedschap zijn eigen plaats, dit zorgt voor een hogere productiviteit
- ✓ beter georganiseerd, snel toegankelijk
- ✓ chemisch bestendig schuim
- ✓ tweekleurig systeem, het valt direct op welke gereedschappen ontbreken
- ✓ het gereedschap blijft op zijn plaats tijdens het transport

**FOR 10225 - FOR 50223**  
**FOR 10217**  
**FOR 10218**  
**FOR 10517**  
afmeting/dim foam  
57cm x 37 cm



**FOR 10318 Jumbo**  
afmeting / dim foam  
74cm x 43 cm



**system mousse**

- ✓ chaque outil à sa place, plus de productivité
- ✓ mieux organisé, accès facile
- ✓ mousse en bicolore
- ✓ résiste aux produits chimiques
- ✓ l'outillage rest en place pendant le transport



## FOR F2262

Schroevendraaierset 26 delig  
Module 26 tournevis

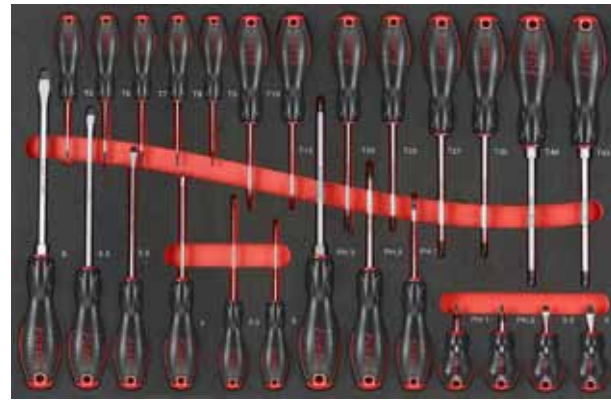

713 03...08	3-3.5-4-5.5-6.5-8 mm
713055S - 713065S	5.5-6.5 mm (25mmL)
7111 - 7112 - 7113	PH1-PH2-PH3
7111S - 7112S	PH1-PH2 (25mmL)
716 05...45	T5-T6-T8-T9-T10-T15-T20-T25-T27-T30-T40-T45

## FOR F2412

Schroevendraaierset & L sleutel set 41 delig  
Module tournevis & clés mâles 41 pcs



713 03...08	3-4-5.5-6.5-8 mm
713055S - 713065S	5.5-6.5 mm (25mmL)
7110 - 7111 - 7112 - 7113	PH0-PH1-PH2-PH3
7111S - 7112S	PH1-PH2 (25mmL)
716 15...40	T10-T15-T20-T25-T27-T30-T40
766 10...50 torx L	T10-T15-T20-T25-T27-T30-T40-T45-T50
764 1.5...12 inbus L	1.5-2-2.5-3-4-5-6-7-8-10-12 mm
88601	demagnetiseur

## FOR F2182

Schroevendraaierset & tangen 1000v 18 delig  
Module 18 tournevis & pinces 1000v



711N0	ph0 (60 mm L)
711N1	ph1 (80 mm L)
711N2	ph2 (100 mm L)
711N3	ph3 (150 mm L)
713N025	2.5 mm (75 mm L)
713N03	3 mm (100 mm L)
713N035	3.5 mm (100 mm L)
713N04	4 mm (100 mm L)
713N055	5.5 mm (125 mm L)
713N065	6.5 mm (150 mm L)
713N08	8 mm (175 mm L)
6903180	kombinatietang 180 mm L, pince universelle
6904200	lange bektang 200 mm L, pince à becs long
6911200	kniptang 200 mm L, pince coupante
6912160	striptang 160 mm L, pince à sertir
6909250	kabel snijder 250 mm
6806	striptang, pince a sertir
88408	Voltage tester 6-400v ac

## FOR F5117

Tangenset 11 delig  
Module 11 pinces

649250B	moersleutel, clé à molette 250 mm
613B250	waterpomptang, pince multiprise
614250	vise grip tang, pince grip
610B200	lange bektang, pince à becs long 200 mm
611B175	universele tang, pince universelle 175 mm
612B175	kniptang, pince coupante 175 mm
5047P1	lange bektang, pince à becs long
5047P2	lange bektang, pince à becs long 45°
5047P3	lange bektang, pince à becs long 90°
5047P4	multi tang 4 punts grip, pince multi grip
673B215	motortang, pince moteur



## FOR F51217

Tangenset 12 delig  
Module 12 pinces

610B200	lange bektang, pince à becs long 200 mm
610B200B	lange gebogen bektang, pince à becs long coudé 200 mm
611B175	kombinatietang, pince universelle 175 mm
612B175	kniptang, pince coupante 175 mm
614250	vise grip tang, pince grip 250 mm
613B250	waterpomptang, pince multiprise 250 mm
649250A	moersleutel, clé à molette 250 mm
609ASO	circlips tang, pince circlips 1.8 mm open
609ASC	circlips tang, pince circlips 1.8 mm gesloten
609ABO	circlips tang, pince circlips 1.8 mm 90° open
609ABC	borgveertang, pince circlips 1.8 mm 90° gesloten
6982	schaar, ciseau





## FOR F5155

### Tangen-hamerset 15 delig

#### Module pinces & marteaux 15 pcs

60226200C	koudbeitel 26 mm 200 mm L, burin
6044190	doorslag 4 mm 190 mm L, chasse goupilles
6046210	doorslag 6 mm 210 mm L
6074185	center punt 4 mm 185 mm L
613250	waterpomptang, pince multiprise
614250	vise grip tang, pince grip
610B200	lange bektang, pince à becs long 200 mm
611B175	universele tang, pince universelle 175 mm
612B175	kniptang, pince coupante 175 mm
609ASC	circlipstang 1.8 mm gesloten, pince circlips
609ASO	circlipstang 1.8 mm open, pince circlips
609ABO	circlipstang 1.8 90° open
609ABC	circlipstang 1.8 mm 90° gesloten
616A400	hamer 400gr, marteau
616F032	rivette hamer 32 mm, marteau rivette



## FOR F5207

### Tangen-beitelset 20 delig

#### Module pinces & burins 20 pcs

60226200C	koudbeitel 26 mm 200 mm L, burin
6044190	doorslag 4 mm 190 mm L, chasse goupille
6045200	doorslag 5 mm 200 mm L
6046210	doorslag 6 mm 210 mm L
6048215	doorslag 8 mm 215 mm L
60725185	center punt 2.5 mm 185 mm L
6074185	center punt 4 mm 185 mm L
6076185	center punt 6 mm 185 mm L
60212150	platte beitel 12mm, burin
60212180	platte beitel 15mm
60219200	platte beitel 19mm
613B250	waterpomptang, pince multiprise
614250	vise grip tang, pince grip
610B200	lange bektang, pince à becs long 200 mm
610B200B	gebogen lange bektang 200 mm
611B175	universele tang, pince universelle 175 mm
612B175	kniptang, pince coupante 175 mm
649250	moersleutel 250 mm L, clé à molette
616300	hamer 300gr, marteau
616480	rubber hamer 400gr, marteau choutchouc



## FOR F31351

### Kombinatieset 135 delig 1/4" - 3/8" 6kant

#### Jeu de combination 135 pcs 1/4" - 3/8" 6pans

525 3.2....14	1/4"	3.2-4-4.5-5-5.5-6-7-8-9-10-11-12-13-14 mm (korte doppen - douilles )
52550 06....13	1/4"	5-6-7-8-9-10-11-12-13 mm (lange doppen,douilles longues)
8042050...150	1/4"	verlengstuk, rallonges 50 mm-100 mm-150 mm
80521	1/4"	kniegewricht, cardan universelle
8032115	1/4"	wringstaaf
802215 - 802315	1/4"	ratel + ratel 3/8"
8143	1/4"	steekhecht, manche tournevis
81225	1/4"	magneet, aiment
326 32 08...40	1/4"	torx T8-T10-T15-T20-T25-T27-T30-T40
324 32 03...10	1/4"	inbus, hex 3-4-5-6-7-8-10 mm
321 321...323	1/4"	PH1-PH2-PH3
322 321...323	1/4"	PZ1-PZ2-PZ3
323 32 04...65	1/4"	plat 4.5 - 5 - 6.5 mm
535 06...22	3/8"	kort 6-7-8-9-10-11-12-13-14-15-16-17-18-19-20-21-22 mm
536 04...16	3/8"	E4-E5-E6-E7-E8-E10-E11-E12-E14-E14-E16
53655 04...16	3/8"	E4-E5-E6-E7-E8-E10-E11-E12-E14-E16
53563 06...22	3/8"	lang 6-7-8-9-10-11-12-13-14-15-16-17-18-19-20-21-22 mm
33750 08...60	3/8"	resistorx T8H-T10H-T15H-T20H-T25H-T27H-T30H-T40H-T50H-T55H-T60H
33850 05...12	3/8"	XZN M5-M6-M8-M9-M10-M12
33450 03...12	3/8"	inbus, hex 3-4-5-6-7-8-10-12 mm
765 03...10 mm		inbus, hex 1.27-1.5-2-2.5-3-4-5-6-8-10 mm
804375...150	3/8"	verlengstuk, rallonges 75 mm-150 mm
80531	3/8"	kniegewricht, cardan universelle
8033165	3/8"	Wringstaaf, manche en T
807316-807320.6	3/8"	bougiedop 16 mm-20.6 mm



## FOR F41083

### Kombinatieset 108 delig 1/4" - 1/2" 6kant

#### Jeu de combination 108 pcs 1/4" - 1/2" 6pans

525 4...13	1/4"	4-4.5-5-5.5-6-7-8-9-10-11-12-13 mm (korte doppen)
52550 06...13	1/4"	6-7-8-9-10-11-12-13 mm (lange doppen)
526 04...10	1/4"	E4-E5-E6-E7-E8-E10 (inwendig torx)
545 10...32	1/2"	10-11-12-13-14-15-16-17-18-19-21-22-24-27-30-32 mm (korte doppen )
54577 14...22	1/2"	14-15-17-19-22 mm (lange doppen )
546 12...24	1/2"	inwendig torx E12-E14-E16-E18-E20-E24
321 321...323	1/4"	PH1-PH2-PH3
322 321...323	1/4"	PZ1-PZ2-PZ3
323 3204...65	1/4"	plat 4-5.5-6.5 mm
324 32 03...08	1/4"	inbus 3-4-5-6-7-8 mm
326 32 08...40	1/4"	torx T8-T10-T15-T20-T25-T27-T30-T40
327 32 08...40	1/4"	resistorx TX8-TX10-TX15-TX20-TX25-TX30-TX40
5116 inbusset		1.5-2-2.5-3-4-5-6-7-8-10-12 mm
802220-802215	1/4"	2 ratels, cliquets
8024415	1/2"	ratel, cliquet
8032115-8034250		1/4" - 1/2" wringstaaf, manche en T
8042 50...100	1/4"	verlengstuk, rallonges 50 mm-100 mm
8044 125...250	1/2"	verlengstuk, rallonges 125 mm-250 mm
8143	1/4"	steekhecht, manche tournevis
80521-80541	1/4"	kniegewricht, cardan universelle
80541	1/2"	kniegewricht, cardan universelle
81225	1/4"	magneet pick up, aiment



## FOR F4451

### 1/2" Kombinatieset 45 delig 6kant

#### Jeu de combination 1/2" 45 pcs 6 pans

545 08...32	1/2"	douilles 8-9-10-11-12-13-14-15-16-17-18-19-20-21-22-23-24-26-27-28-30-32 mm
54577 10...32	1/2"	douilles longues 10-12-13-14-15-17-19-21-22-23-24-30-32 mm
80242	1/2"	ratel, cliquet
8044125...250	1/2"	2 verlengstukken, rallonges 125 mm-250 mm
8014380	1/2"	wringstaaf met kniestuk, manche flex
80541	1/2"	kniegewricht, cardan univeselle
8034250	1/2"	wringstaaf, manche en T
609ASC		borgveertang, pince circlips
609ABO		borgveertang, pince circlips
609ASO		borgveertang, pince circlips
609ABC		borgveertang, pince circlips



## FOR F4882

### 1/4" - 3/8" - 1/2" doppenassortiment 88 delig 6kant

#### Jeu de douilles 88 pcs 1/4" - 3/8" - 1/2" 6 pans

525 3.2...14	1/4"	3.2-4-4.5-5-5.5-6-7-8-9-10-11-12-13 mm (korte doppen)
52550 06...13	1/4"	6-7-8-10 mm (lange doppen, douilles longues)
8042050...150	1/4"	verlengstuk, rallonges 50 mm-100 mm-150 mm
802215	1/4"	ratel, cliquet
80521	1/4"	kniegewricht, cardan universelle
8032115	1/4"	wringstaaf, manche en T
8143	1/4"	steekhecht, manche tournevis
81225	1/4"	magneet, aimant
535 06...19	3/8"	8-9-10-11-12-13-14-15-16-17-18-19 mm
53563 06...14	3/8"	8-9-10-12-13-14 mm
802315	3/8"	ratel, cliquet
	3/8"	adapter voor verlengstuk
804375...150	3/8"	verlengstuk, rallonges 75 mm-150 mm
80531	3/8"	kniegewricht, cardan universelle
8033165	3/8"	Wringstaaf, manche en T
807314M	3/8"	bougiedop 14 mm magnetisch
807316M	3/8"	bougiedop 16 mm magnetisch
807318M	3/8"	bougiedop 18 mm magnetisch
807320.6M	3/8"	bougiedop 20.6 mm magnetisch
545 10...32	1/2"	10-11-12-13-14-15-16-17-18-19-20-21-22-23-24-26-27-28-30-32 mm
54577 13 ...32	1/2"	13-14-15-17-19-21-22-24-27-30-32 mm 77 mm L
802415	1/2"	ratel, cliquet
8044125 8044250	1/2"	verlengstukken, rallonges 125 mm-250 mm
80541	1/2"	kniegewricht, cardan universelle
80634	1/2"	adapter 3/8" * 1/2"

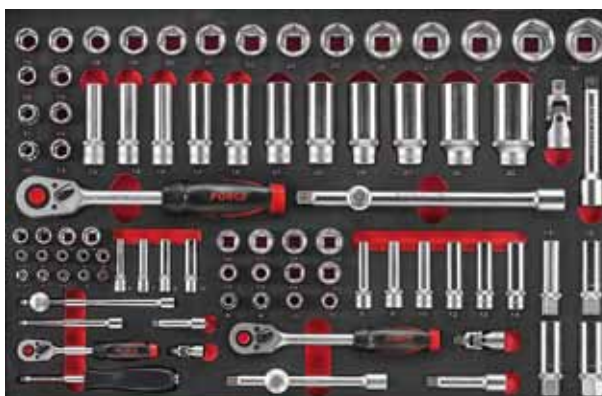

## FOR F41041

### Doppen torx assortiment 1/4"-3/8"-1/2"104 delig

#### Jeu de douilles - torx 104 pcs 1/4" - 3/8" - 1/2"

526 4...10	1/4"	E4-E5-E6-E7-E8-E10
52650 04...10	1/4"	E4-E5-E6-E7-E8-E10 (50 mm L)
32632 08...30	1/4"	Torx op dop T8-T9-T10-T15-T20-T25-T27-T30
32F32 10...40	1/4"	Vijfkant TS10-TS15-TS20-TS25-TS27-TS30-TS40
80923	1/4"	Adapter 1/4" * 3/8"
33F50 45-50	3/8"	vijfkant TS45-TS50
536 06...12	3/8"	E6-E8-E10-E12
546 11...24	1/2"	E11-E12-E14-E16-E18-E20-E22-E24
546577 11...24	1/2"	E11-E12-E14-E16-E18-E20-E22-E24 (77 mm L)
34655 40...70	1/2"	T40-T45-T47-T50-T55-T60-T70 (55 mm L)
3467080	1/2"	T80 (70 mm L)
346100 20...100	1/2"	T20-T25-T27-T30-T40-T45-T50-T55-T60-T70-T90-T100 (100 mm L)
34614060	1/2"	T60 (140 mm L)
34710055	1/2"	Resistorx T55 (100 mm L)
34710570	1/2"	Resistorx T70 (105 mm L)
34713030	1/2"	Resistorx T30 (130 mm L)
34714080	1/2"	Resistorx T80 (140 mm L)
80546 14...24	1/2"	Dop met kniegewricht E14-E16-E18-E20-E24
80943	1/2"	adapter 1/2" * 3/8"
756 0608A...2024A		Torx sleutel 75° E6xE8-E10xE12-E14xE18-E20xE24
5098LT		Resistorx L sleutel T10H-T15H-T20H-T25H-T27H-T30H-T40H-T45H-T50H
50913		Vijfkant met gat TS10-TS15-TS20-TS25-TS27-TS30-TS40-TS45-TS50





## FOR F5351

### Sleutelset 35 delig Jeu de clés 35 pcs

755 06...32	6-7-8-9-10-11-12-13-14-15-16-17-18-19-21-22-23-24-26-27-28-30-32 mm steekring - clés mixtes
759 0607...3032	6x7-8x9-10x11-12x13-14x15-16x17-18x19-21x22-23x26-24x27-25x28-30x32 mm, polygonales



## FOR F5421

### Sleutelset 42 delig Jeu de clés 42 pcs

755 06...23	6-7-8-9-10-11-12-13-14-15-16-17-18-19-20-21-22-23 mm
754 0607...3032	6x7-8x9-10x11-12x13-14x15-16x17-18x19-20x22-21x23-24x27-30x32 mm
758 0809...2224	8x9-10x11-12x13-14x15-16x17-18x19-21x23-22x24 mm
751 0911...1719	9x11-x10x12-12x14-14x17-17x19 mm open ring

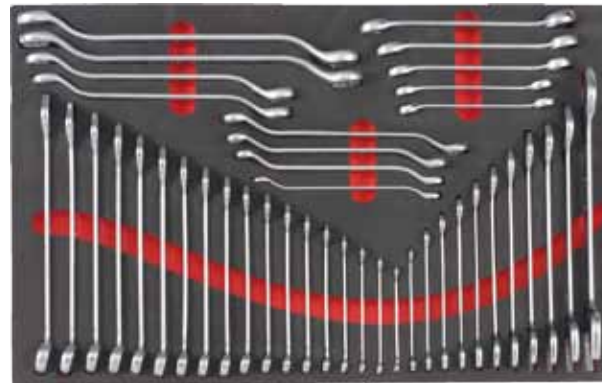

## FOR F5361

### Sleutelset 36 delig Jeu de clés 36 pcs

75506...32	6-7-8-9-10-11-12-13-14-15-16-17-18-19-21-22-23-24-26-27-28-30-32 mm steerkingsleutel - clés mixtes
7590607...3032	6x7-8x9-10x11-12x13-14x15-16x17-18x19-21x22-23x26-24x27-25x28-30x32 mm gebogen ring



## FOR F5182

### Beitel & hamerset 18 delig Burins & marteaux 18 pcs

602 12150Q...22200Q	beitels, burins 12-15-19-22 mm
603150q	kapbeitel, bédane
604 2140Q...8215Q	doorslagen, chasse-goupilles 2-3-4-5-6-8 mm
6066185Q	puntslag, pointeau 6 (185 mm L)
6076185Q	centerpunt, pointeau 6 (185 mm L)
5055P1	schaar, ciseau
5055P4	cuttermes, couteau universel
616300	hamer, marteau 300 gr
616400	rubber hamer, marteau caoutchouc 400 gr
66303	zaag, scie



## FOR F5186

### Assortiment vijlen en acc. 18 delig Jeu de limes & acc. 18 pcs

5056P1	platte vijl - lime plat
5056P2	halfronde vijl - lime demi ronde
5056P3	ronde vijl - lime ronde
5056P4	vierkantsvijl - lime carré
5056P5	driehoeksvijl - lime triangle
5055p4	universeel mes - couteau universel
66303	mini zaag - scie
6981250	alles snijder - cutter à lame
5056P1	schuifmaat - pied à coulisse
5096P4	hoekmeter - rapporteur inox
	stalen borstel
5096P7	stalen kraspen - pointe à tracer
5096P8	meter 5 m - mètre à ruban
5096P2	center punt - pointeau
5096P5	voelmaatjes - jauge d'épaisseur mm
5096P6	voelmaatjes Inch - jauge d'épaisseur inch
5096P3	liniaal 30cm, règle métal



## FOR F4175

Slagmoerset 1/2" - 17 delig

Jeu de douilles à choc 1/2" - 17 pcs

445 13...24	slagdoppen, douilles à chocs 1/2" 13-14-15-16-17-18-19-21-22-24 mm
44585 17...21C	alu doppen 1/2" 17-19-21 mm, jantes
6474535	1/2" momentsleutel, clé dynamométrique 40-210nw
825A41	slagmoersleutel op batterij + lader
6821	wielgewichttang, pince pour masses



## FOR F2195

Inbussleutelset - dop op handvat 19 delig

Jeu de douilles à poignée en T & clés hex 19 delig

744300 05...13	5-6-7-8-9-10-11-12-13 mm (300 mm L)
765 2G...12G	inbus 2-2.5-3-4-5-6-7-8-10-12 mm

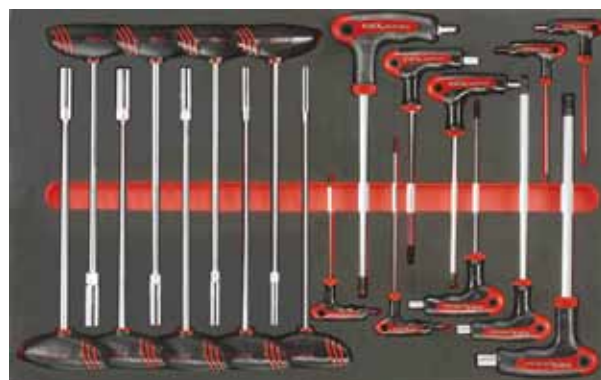

## FOR F6213

Doppenset 3/4" - 21 delig 6kant

Set de douilles 6 pans 3/4" - 21 pcs

565 19...50	19-21-22-23-24-26-27-29-30-32-35-36-38-41-46-50mm
8046100	verlengstuk, rallonge 100 mm
8046200	verlengstuk, rallonge 200 mm
8026500	ratel, cliquet 500 mm
80968	adapter, reducteur



## FOR F2452 - Jumbo

Schroevendraaierset 45 delig

Jeu de tournevis 45 pcs

7111S-7112S	PH1-PH2 (25 mm L)
7110 - 7111	PH0 (60 mm L) - PH1 (60 mm L)
7112 - 7113	PH2 (100 mm L) - PH3 (150 mm L)
713055S - 713065S	5.5 mm (25 mm L)-6.5 mm (25 mm L)
71303-713035	3 mm (75 mm L) - 3.5 mm (100 mm L)
71304-713055	4 mm (100 mm L) - 5.5 mm (125 mm)
713065-71308	6.5 mm (150 mm L) - 8 mm (175 mm L)
655306 - 65512	6 mm extra lang 400 mm - PH2 extra lang 450 mm
716 05...45	T5-T6-T7-T8-T10-T15-T20-T25-T27-T30-T40-T45 torx schroevendraaiers
767 06 60	T6H-T7H-T8H-T9H-T10H-T15H-T20H-T25H-T27H-T30H-T40H-T45H-T50H-T55H-T60H resistorx L sleutels (S151T)
88601	magnetiseur-demagnetiseur

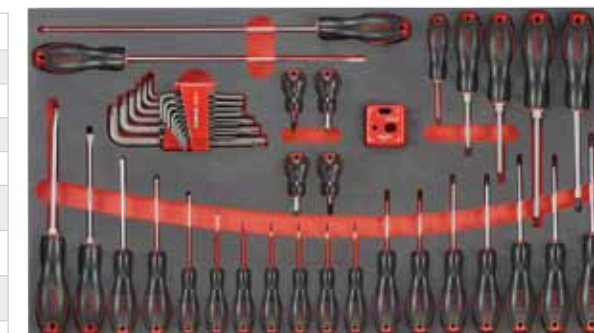

## FOR F2335 - Jumbo

Schroevendraaierset 33 delig

Jeu de tournevis 33 pcs

7111S-7112S	PH1-PH2 (25 mm L)
7110 - 7111	PH0 (60 mm L) - PH1 (60 mm L)
7112 - 7113	PH2 (100 mm L) - PH3 (150 mm L)
713055S-713065S	5.5 mm (25 mm L)-6.5 mm (25 mm L)
71303-713035	3 mm (75 mm L) - 3.5 mm (100 mm L)
71304-713055	4 mm (100 mm L) - 5.5 mm (125 mm)
713065-71308	6.5 mm (150 mm L) - 8 mm (175 mm L)
88601	magnetiseur-demagnetiseur
716 05...45 torx	T5-T6-T7-T8-T10-T15-T20-T25-T27-T30-T40-T45
905M2P1 ... 905M2P5	5 clipsverwijderaars, grattoirs et crochets

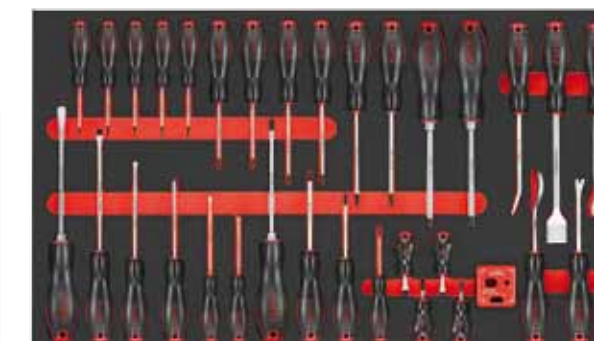

## FOR F2592 - Jumbo

Schroevendraaierset 59 delig

Jeu de tournevis 59 pcs

7111S-7112S	PH1-PH2 (25 mm L)
7110 - 7111	PH0 (60 mm L) - PH1 (60 mm L)
7112 - 7113	PH2 (100 mm L) - PH3 (150 mm L)
713055S-713065S	5.5 mm (25 mm L)-6.5 mm (25 mm L)
71303-713035	3 mm (75 mm L) - 3.5 mm (100 mm L)
71304-713055	4 mm (100 mm L) - 5.5 mm (125 mm)
713065-71308	6.5 mm - 8 mm
71310M - 71312M	10-12mm hamer schroevendraaier
88601	magnetiseur-demagnetiseur
716 05...45 torx	T5-T6-T7-T8-T10-T15-T20-T25-T27-T30-T40-T45
765 015XL...12XL	Haakse XL kogelinbus sleutels 1.5-2-2.5-3-4-5-6-7-8-10-12 mm
767 10XL...50XL	Haakse XL resistorx sleutels T10H-T15H-T20H-T25H-T27H-T30H-T40H-T45H-T50H
76F 10...50	Haakse 5-kant Resistorx TS sleutels TS10-TS15-TS20-TS25-TS27-TS30-TS40-TS45-S50

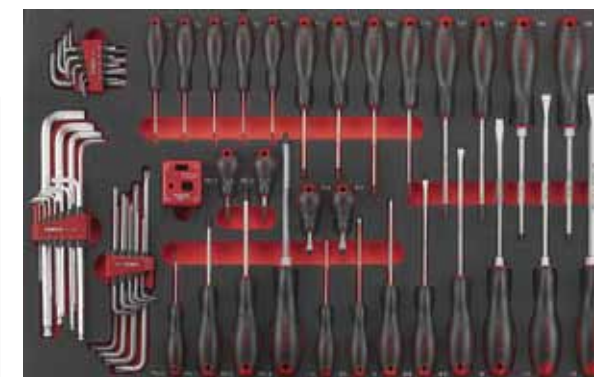



## FOR F21251 - Jumbo

Doppen 1/4" & tangenset 125 delig 6kant

Set racagnac, douilles 1/4" & de pincen 125 pcs 6pans

525 032...13	1/4" 3.2-4-4.5-5-5.5-6-7-8-9-10-11-12-13 mm
5255 004...13	1/4" 4-4.5-5-5.5-6-7-8-9-10-11-12-13 mm (55mmL)
52604...10	1/4" E4-E5-E6-E7-E8-E10 korte inwendig torx
5265 04...10	1/4" E4-E5-E6-E7-E8-E10 lang inwendig torx
321 320...323	1/4" PH0-PH1-PH2-PH3
322 320...323	1/4" PZ0-PZ1-PZ2-PZ3
323 32 04...32065	1/4" plat 4-5.5-6.5 mm
324 32 04...10	1/4" inbus 3-4-5-6-7-8-10 mm
326 32 08...10	1/4" torx T8-T10-T15-T20-T25-T27-T30-T40
327 32 08...40	1/4" resistorx T8H-T10H-T15H-T20H-T25H-T27H-T30H-T40H
32F3210...40	TS10-TS15-TS20-TS25-TS27-TS30-TS40
5116L	inbus L sleutel set, clés mâles
765 01.5L...765 012L	1.5-2-2.5-3-4-5-6-7-8-10-12 mm



802223	1/4" ratel, cliquet
802215	1/4" ratel, cliquet
802220	1/4" mini ratel, cliquet mini
8032115	1/4" wringstaaf, manche en T
81225	1/4" magneet pick up, aiment
8143	steekhecht, manche tournevis
8111	flexibel verlengstuk, rallonge flex
8042 50-100-150-250	1/4" verlengstuk, rallonge 50-100-150-250 mm
80521	1/4" kniegewricht, cardan universelle
6472300W	1/4" momentsleutel, clé dynamom. 6-30nw
6472150	1/4" momentsleutel, clé dynamom.
50814P1 tot P8	8 mini tangen, 8 pince mini
	schaar/pincet/precisiemes
11 precisie schroev.	PH000-PH00 plat 1.0-1.2-1.5-1.8-2.0-2.4 mm
	inbus, hex 0.9-1.3-1.5 mm

## FOR F32031 - Jumbo

Kombinatieset 1/4" - 3/8" 203 delig 6kant

Jeu de douilles 1/4" - 3/8" 203 pcs 6 pans

525 032...13	1/4" 4-4.5-5-5.5-6-7-8-9-10-11-12-13 mm
5255 004...13	1/4" 4-4.5-5-5.5-6-7-8-9-10-11-12-13 mm (55mmL)
321 320...323	1/4" PH0-PH1-PH2-PH3
322 320...323	1/4" PZ0-PZ1-PZ2-PZ3
323 32 03...065	1/4" plat 3-4-5.5-6-6.5 mm
324 32 04...10	1/4" inbus 3-4-5-6-7-8-9-10 mm
326 32 08...10	1/4" torx T8-T9-T10-T15-T20-T25-T27-T30-T40
327 32 08...40	1/4" resistorx T8H-T9H-T10H-T15H-T20H-T25H-T27H-T30H-T40H
32F3210...40	1/4" TS10-TS15-TS20-TS25-TS27-TS30-TS40
8012140	1/4" Schuifbar 140mmL - poignée articulée
80222	1/4" Ratel, cliquet
8032115	1/4" Wringstaaf met schuifstuk 115mmL - Poignée coulissante
8042050-8042150	1/4" Verlengstuk 50-150mm - Rallonges
80521	1/4" Kniegewricht - cardan
8092225	Bit adapter 1/4" x 1/4"
80932	Adapter 3/8" x 1/4", reducteur
81022	Bit houder 1/4" x 1/4", porte embouts
8111	1/4" Flexibel verlengstuk
8143	Steekhecht 1/4" - manche tournevis
331503 -331504	3/8" Philips bit PH3 - PH4
332503-332504	3/8" Pozidriv bit PZ3-PZ4
333 50 05...65	3/8" Platte bit 5-5.5-6-6.5-7-8
33F5045...33F5050	3/8" Vijf ster resistorx TS45-TS50
535 08...22	3/8" 8-9-10-11-12-13-14-15-16-17-18-19-20-21-22mm
536 04...18	3/8" E4-E5-E6-E7-E8-E10-E11-E12-E14-E16-E18 torx doppen
53655 04...18	3/8" E4-E5-E6-E7-E8-E10-E11-E12-E14-E16-E18 lange torx doppen
8013215	3/8" Wringstaaf met kniegewricht 215mmL
80232	3/8" Ratel, cliquet
8033165	3/8" Wringstaaf met schuifstuk 165mmL
8043075-8043150	3/8" Verlengstuk 75mm-150mm
80531	3/8" Kniegewricht - cardan universelle
8073 14...20.6	3/8" Bougiedop 14-16-18-20.6mm
80923	Adapter 1/4" x 3/8", reducteur
80943	Adapter 1/2" x 3/8", reducteur
7111M-7112M-7113M	Philips hamer schroevendraaier PH1-PH2-PH3
713 055M...12M	platte hamer schroevendraaier 5.5-6.5-8-10-12mm
5098XL	9dlg torx L sleutels T10-T15-T20-T25-T27-T30-T40-T45-T50
2331A	1/4" Bit set 33dlg
5116XLB	inbus L sleutel set
765 01.5XL...765 012XL	1.5-2-2.5-3-4-5-6-7-8-10-12 mm

# Jumbo

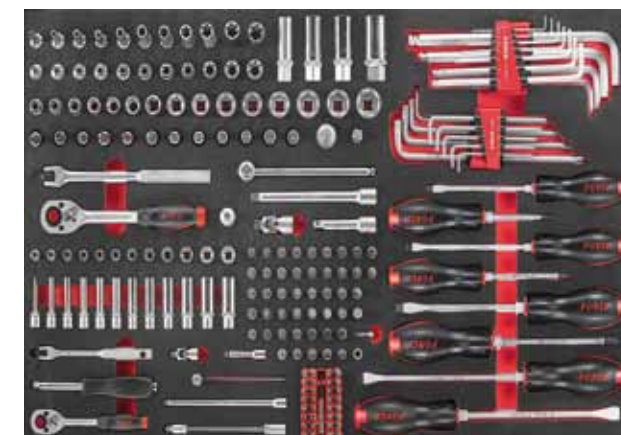

**FOR F31921- Jumbo**

Doppen 1/4"-3/8" kombinatieset 192 delig 6-12 kant  
Set 1/4" - 3/8" 192 pcs 6-12 pans

525 04...13	1/4" 4-4.5-5-5.5-6-7-8-9-10-11-12-13 mm
5255 004...13	1/4" 4-4.5-5-5.5-6-7-8-9-10-11-12-13 mm (55mmL)
5260 4...10	E4-E5-E6-E7-E8-E10 korte inwendig torx
5265 04...10	E4-E5-E6-E7-E8-E10 lang inwendig torx
321 320...323	1/4" PH0-PH1-PH2-PH3
322 320...323	1/4" PZ0-PZ1-PZ2-PZ3
323 32 03...32065	1/4" plat 3-4-5.5-6.5 mm
324 32 04...08	1/4" inbus 3-4-5-6-7-8mm
326 32 08...10	1/4" torx T8-T9-T10-T15-T20-T25-T27-T30-T40
327 32 08...40	1/4" resistorx T8H-T9H-T10H-T15H-T20H-T25H-T27H-T30H-T40H
32F3210...40	TS10-TS15-TS20-TS25-TS27-TS30-TS40

80222	1/4" ratel, cliquet
802220	1/4" mini ratel, cliquet mini
6472270	1/4" momentsleutel 5-25nw
64721608	1/4" momentsleutel 1-8Nm
8032115	1/4" wringstaaf, manche en T
8012140	1/4" wringstaaf met kniegewricht
81022	bithouder 1/4" x 1/4"
8143	steekhecht, manche tournevis
8042 50-150	1/4" verlengstuk, rallonge 50-150 mm
80521	kniegewricht, cardan universelle
2331	security bitset 33dlg
haakse XZN sleutels	M5-M6-M8-M10-M12-M14-M16, clés mâles XZN
539 08...22	3/8" doppen 8-9-10-11-12-13-14-15-16-17-18-19-20-21-22mm (12kant)
805358 10...19	3/8" 10-11-12-13-14-15-16-17-18-19mm kniegewricht doppen
536 04...18	3/8" torx E4-E5-E6-E7-E8-E10-E11-E12-E14-E16-E18
53655 04...18	3/8" torx L E4-E5-E6-E7-E8-E10-E11-E12-E14-E16-E18 (55mmL)
331503 331504	3/8" PH3-PH4
332503 332504	3/8" PZ3-PZ4
333500 5...8	3/8" 5-5.5-6-6.5-7-8mm
80232	3/8" ratel 24t, cliquet
802318	3/8" flexibele ratel 30t, cliquet
6473365	3/8" momentsleutel 19 -210nw
8013215	3/8" wringijzer 215mm, manche en T
8043075-8043150	3/8" verlengstukken, rallonges 75-150mm
8033165	3/8" T hendel, manche en T
80521	3/8" kniegewricht, cardan universelle
8073 14...20.6	3/8" bougiedoppen 14-16-18-20.6MM
8073250 14 - 16	3/8" bougiedoppen 14-16mm (250mmL)

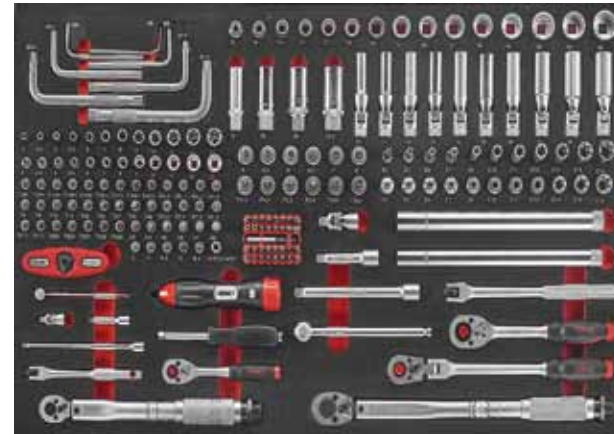
**FOR F41621 - Jumbo**

Kombinatieset 1/4"-3/8"-1/2" 162 delig 6kant  
Set 1/4"-3/8"-1/2" 162 pcs 6 pans

525 3.2...14	1/4" doppen 3.2-4-4.5-5-5.5-6-7-8-9-10-11-12-13-14 m
525500 06...13	1/4" doppen lang 6-7-8-9-10-11-12-13 mm
526 04...10	1/4" inwendig torx E4-E5-E6-E7-E8-E10
321 320...323	1/4" PH0-PH1-PH2-PH3
322 320...323	1/4" PZ0-PZ1-PZ2-PZ3
323 3204...065	1/4" plat 3-4-5.5-6.5 mm
324 3203...10	1/4" inbus 3-4-5-6-7-8-9-10 mm
326 3208...40	1/4" torx T8-T9-T10-T15-T20-T25-T27-T30-T35-T40
327 3208... 40	1/4" resistorx T8H-T10H-T20H-T25H-T27H-T30H-T35H-T40H
802215	1/4" ratel, cliquet
802220	1/4" ratel mini, cliquet
8032115	1/4" wringstaaf
8042050 - 8042100	1/4" verlengstuk 50 + 100 mm
8111	1/4" flexibel verlengstuk, rallonge flexible
8143	1/4" steekhecht, mache tournevis
80521	1/4" kniegewricht, cardan
81225	1/4" magneet, aimant
535 06...24	3/8" doppen 6-7-8-9-10-11-12-13-14-15-16-17-18-19-20-21-22-23-24 mm
53563 08...14	3/8" lange doppen 8-9-10-12-13-14 mm
802315	3/8" ratel, cliquet
802318	3/8" flexibele ratel, cliquet flexible
8043075 - 8043150	3/8" verlengstuk, rallonge 75 mm & 150 mm
8043044W	3/8" verlengstuk, rallonge 44 mm
80531	3/8" kniegewricht, cardan
80643	adapter voor verlengstuk 1/2" x 3/8"
807314	3/8" bougie dop 14 mm
807316	3/8" bougie dop 16 mm
807318	3/8" bougie dop 18 mm
807320.6	3/8" bougie dop 20.6 mm
3385005...12	3/8" XZN (12k) M5-M6-M8-M9-M10-M12
545 10...32	1/2" 10-11-12-13-14-15-16-17-18-19-21-22-23-24-27-30-32 mm (douilles)
54577 10...32	1/2" 14-15-17-19-22-24 mm (douilles longues)
546 10...24	1/2" E12-E14-E16-E18-E20-E22-E24 (kort)
802415	1/2" ratel, cliquet 36t
80541	1/2" kniegewricht, cardan universel
80634	adapter voor verlengstuk 3/8" x 1/2"
8044 125-250	1/2" 2 verlengst, rallonges 125 mm-250 mm
81047	bithouder 1/2" * 10 mm porte embouts
inbus - hex	1.27-1.5-2-2.5-3-4-5-6-8-10 mm, clés mâles

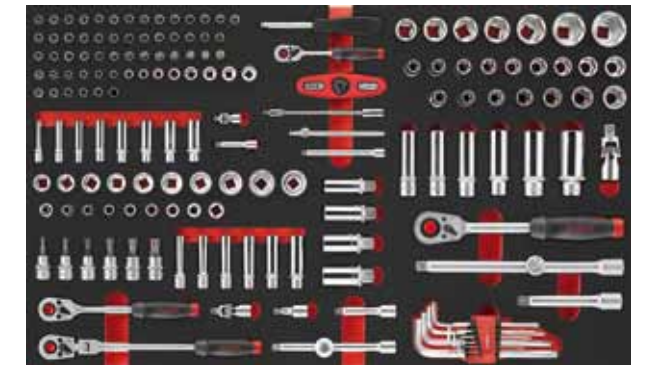



## FOR F41062- Jumbo

Kombinatieset 1/2" 106 delig 6kant  
Jeu de combination 1/2" 106 pcs 6pans

545 10....32	10-11-12-13-14-15-16-17-18-19-20-21-22-23-24-26-27-28-30-32 mm (douilles)
54577 10....32	10-11-12-13-14-15-16-17-18-19-20-21-22-23-24-26-27-28-30-32 mm (77mmL)
546 08....24	E8-E10-E11-E12-E14-E16-E18-E20-E22-E24 (kort)
344055 05....19	1/2" Inbus dop 5-6-7-8-9-10-12-14-17-19mm (55mmL)
346055 27....70	1/2 Torx dop T27-T30-T40-T45-T50-T55-T60-T70
347055 27....70	1/2" Resistorx T27H-T30H-T40H-T45H-T50H-T55H-T60H-T70H (55mmL)
348100 05....18	1/2" XZN M5-M6-M7-M8-M9-M10-M12-M14-M16-M18-M16T (100mmL)
349100 05....14	1/2" Ribe dop M5-M6-M7-M8-M9-M10-M12-M13-M14 (100mmL)
8014380	1/2" Wringstaaf met kniegewricht 380mmL
80242	1/2" Ratel, cliquet
8034250	1/2" Wringstaaf met kniegewricht 250mmL
8044125-8044250	1/2" Verlengstuk 125mm-250mm rallonge
80541	1/2" Kniegewricht - cardan
80934	Adapter 3/8" x 1/2", reducteur
80964	Adapter 3/4" x 1/2", reducteur

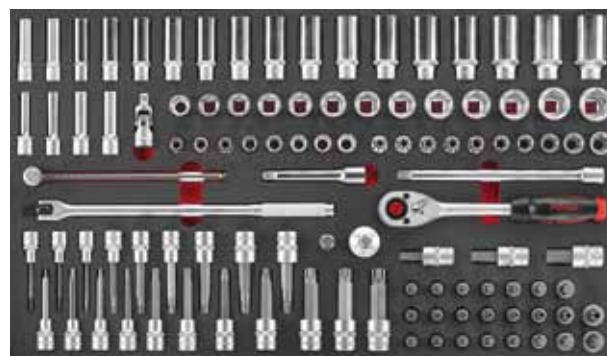

# Jumbo

## FOR F41491 - Jumbo

Kombinatieset 1/2" 149 delig 6kant  
Jeu de combination 1/2" 149 pcs 6pans

545 10....32	10-11-12-13-14-15-16-17-18-19-20-21-22-23-24-26-27-28-30-32 mm (douilles)
54577 10....32	10-11-12-13-14-15-16-17-18-19-20-21-22-23-24-26-27-28-30-32 mm (77mmL)
546 10....24	E10-E11-E12-E14-E16-E18-E20-E22-E24 (kort)
546 5504....24	E10-E11-E12-E14-E16-E18-E20-E24 (lang)
174 30 04....12	4-5-6-7-8-10-12 mm (30mmL inbus)
174 75 04....12	4-5-6-7-8-10-12 mm (75mmL inbus)
176 30 20....60	T20-T25-T27-T30-T40-T45-T50-T55-T60 (30 mmL)
176 75 20....60	T20-T25-T27-T30-T40-T45-T50-T55-T60 (75 mmL)
176 120 40....55	T40-T45-T50-T55 (120 mmL)
177 30 20....60	T20H-T25H-T27H-T30H-T40H-T45H-T50H-T55H-T60H (L30 mm) resistorx
177 75 20....60	T20H-T25H-T27H-T30H-T40H-T45H-T50H-T55H-T60H (L75 mm) resistorx
178 30 05....12	M5-M6-M8-M10-M12 (30 mmL) XZN
178 75 05....12	M5-M6-M8-M10-M12 (75 mmL) XZN
179 30 04....14	M4-M5-M6-M8-M9-M10-M12-M13-M14 (30mmL) ribe
179 75 04....14	M4-M5-M6-M8-M9-M10-M12-M13-M14 (75mmL) ribe
802415	ratel, cliquet 36t
80541	kniegewricht, cardan universeel
8034250	wringstaaf, manche en T
8044 075-125-250	3 verlengstukken, rallonges 75 mm-125 mm-250 mm
81047	bithouder 1/2" * 10 mm porte embouts



# Jumbo

## FOR F41162 - Jumbo

Kombinatieset 3/8" - 1/2" 116 delig 6kant  
Jeu de combination 3/8" - 1/2" 116 pcs 6pans

545 10....32	10-11-12-13-14-15-16-17-18-19-20-21-22-23-24--25-26-27-28-30-32 mm (douilles)
54577 10....32	14-15-16-17-18-19-20-21-22-23-24-25-26-27-28-30-32 mm (77mmL)
546 10....24	E8-E10-E11-E12-E14-E16-E18-E20-E22-E24
344050 05....19	5-6-4-8-9-10-12-14-17mm (50mmL) inbus
344100 05....14	5-6-7-8-9-10-12-14mm (100mmL) inbus
346055 27....70	T27-T30-T40-T45-T50-T55-T60-T70 (55mmL)
346100 27....70	T27-T30-T40-T45-T50-T55-T60-T70 (100mmL)
347055 30....70	T30H-T40H-T45H-T50H-T55H-T60H-T70H (55mmL) resistorx
348055 05....18	M5-M6-M8-M9-M10-M12-M14-M16-M18 (55mmL) XZN
348100 05....18	M5-M6-M8-M9-M10-M12-M14-M18 (100mmL) XZN
34805516T	M16 met gat (55mmL) voor VAG
34810016T	M16 met gat (100mmL) voor VAG
8014380	schuifbar 380mmL
80242	ratel, cliquet 24t
80541	kniegewricht, cardan universeel
8034250	wringstaaf, manche en T
8044 125-250	verlengstuk 125mm, rallonge
8044250	verlengstuk 200mm, rallonge

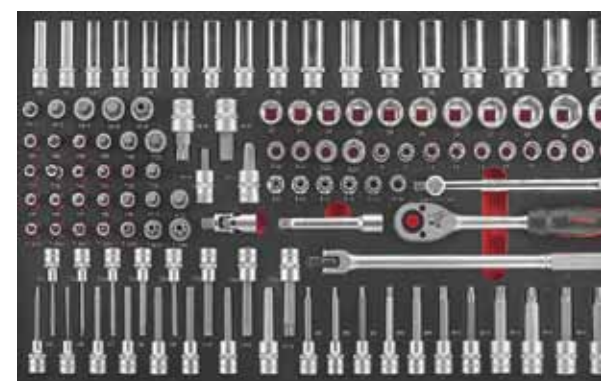

**FOR F4491 - Jumbo**

Slagmoerset 1/2" 49 delig 6kant

Jeu de douilles à chocs &amp; acc. 1/2" 49 pcs 6pans

445 10...32	1/2" 10-11-12-13-14-15-16-17-18-19-20-21-22-23-24-26-27-28-30-32 mm korte slagdoppen
44585 10...32	1/2" 10-11-12-13-14-15-16-17-18-19-20-21-22-23-24-26-27-28-30-32 mm (85mmL)
445 85 17...21C	1/2" 17-19-21 mm alu doppen, douilles à chocs
8044125MPP	verlengstuk, rallonge 125 mm
80541MPP	1/2" kniegewricht, cardan universeel
681A300	wielsleutel 17-19-13/16" -1/2", clé à croix pliable
6474530W	1/2" momentsleutel, clé dynamométrique
6821	wielgewichttang
82544	slagmoersleutel, clé à chocs 1/2"

**FOR F4891 - Jumbo**

Slagmoerset 1/2" 89 delig

Jeu de douilles à chocs &amp; acc. 1/2" 89 pcs

445 10...36	1/2" kort 8-10-11-12-13-14-15-16-17-18-19-20-21-22-23-24-26-27-28-30-32-33-34-35-36 mm
44585 10...36	1/2" longues 8-10-11-12-13-14-15-16-17-18-19-20-21-22-23-24-26-27-28-30-32-33-34-35-36 mm (85mmL)
445 85 17...21C	1/2" 17-19-21 mm alu velg doppen, douilles à chocs
8044125MPP	1/2" verlengstuk, rallonge 125 mm
24406004...19	1/2" inbus 4-5-6-7-8-10-12-14-17-19mm (60mm)
24606020...70	1/2" torx T20-T25-T27-T30-T40-T45-T50-T55-T60-T70 (60mmL)
24806008...12	1/2" XZN M8-M10-12 (60mmL)
24807814...18	1/2" XZN M14-M16-M18 (78mmL)
80541MPP	1/2" kniegewricht, cardan universeel
8044125MPP	verlengstuk, rallonge 125mm
8044250MPP	verlengstuk, rallonge 250mm
80934MPB	adapter 3/8" x 1/2", reducteur
80964MPB	adapter 3/4" x 1/2", reducteur
6474470	1/2" momentsleutel 42-210 Nm, clé dynamométrique

**FOR F41001 - Jumbo**

Slagmoerset 1/2" 100 delig 6kant

Jeu de douilles à chocs &amp; acc. 1/2" 100 pcs 6pans

445 10...32	kort 8-9-10-11-12-13-14-15-16-17-18-19-20-21-22-23-24-25-26-27-28-29-30-32 mm
44585 08...32	lang 8-9-10-11-12-13-14-15-16-17-18-19-20-21-22-23-24-25-26-27-28-29-30-32 mm (85mmL)
445 85 17...24C	17-19-21-22-24 mm alu doppen, douilles à chocs
244060 04... 24	inbus 4-5-6-7-8-10-12-14-16-17-19-21-22-24mm (60mm)
246060 20...70	torx T20-T25-T27-T30-T40-T45-T50-T55-T60-T70 (60mmL)
248060 08...12	XZN M8-M10-12 (60mmL)
248078 14...18	XZN M14-M16-M18 (78mmL)
80541MPP	1/2" kniegewricht, cardan universeel
8044125MPP	verlengstuk, rallonge 125mm
8044250MPP	verlengstuk, rallonge 250mm
80934MPB	adapter 3/8" x 1/2", reducteur
80964MPB	adapter 3/4" x 1/2", reducteur

**FOR F6431 - Jumbo**

Slagdoppenset 3/4" 43 delig

Jeu de douilles à choc 3/4" 43 pcs

465 100 17...46	3/4" lange doppen 17-19-21-22-23-24-27-28-30-32-33-34-35-36-38-41-46mm (100mmL)
465 17...46	3/4" korte doppen 17-19-21-22-23-24-27-28-30-32-33-34-35-36-38-41-46mm
466 110 18...24	3/4" Torx doppen E18-E20-E22-E24
8046175MPB	3/4" Verlengstuk 175mmL, rallonge
8046250MPB	3/4" Verlengstuk 250mmL, rallonge
80561MPB	3/4" Kniegewricht - cardan
80946MPB	Adapter 1/2" x 3/4"
80986MPB	Adapter 1" x 3/4"

**FOR F6342 - Jumbo**

Kombinatieset 3/4" 34 delig 6-12kant

Jeu de combinaison 3/4" 34 pcs 6-12pans

364080 14...22	3/4" Inbus dop 14-16-17-19-22mm (80mmL)
366080 60...100	3/4" Torx dop T60-T70-T80-T90-T100 (80mmL)
569 17...50	3/4" Doppen 12kant 17-19-21-22-23-24-27-30-32-33-34-35-36-38-41-46-50mm
8026500	3/4" Ratel, cliquet
8036500	3/4" Wringstaaf met schuifstuk 500mmL
8046200	3/4" Verlengstuk 200mmL - rallonge
8046400	3/4" Verlengstuk 400mmL - rallonge
80946	Adapter 1/2" x 3/4", reducteur
80986	Adapter 1" x 3/4", reducteur
8156450	3/4" L hendel 450mmL





### FOR F5481 - Jumbo

Sleutelset 48 delig  
Jeu de clés 48 pcs

755 06...32	6-7-8-9-10-11-12-13-14-15-16-17-18-19-21-22-23-24-26-27-28-30-32 mm steekringsleutels - clés mixtes
759 0607...3032	6x7-8x9-10x11-12x13-14x15-16x17-18x19-21x23-20x22-23x26-24x27-25x28-30x32 mm gebogen ringsleutels - clés polygonales
757 08F...19F	8-9-10-11-12-13-14-15-16-17-18-19 mm flexibele ratelsleutels - clés mixte à cliquet flexible

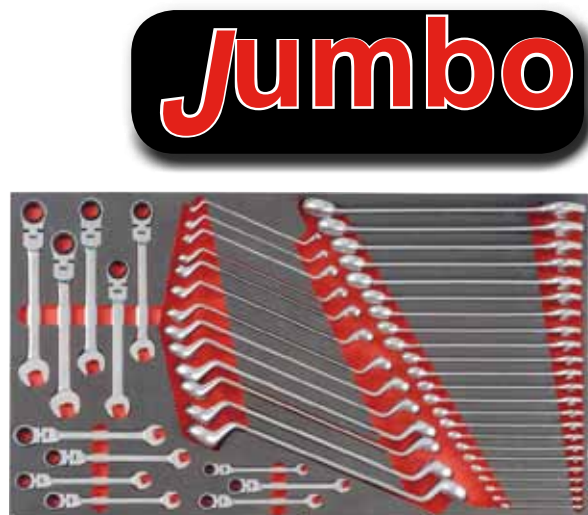

### FOR F5505 - Jumbo

Sleutelset 50 delig  
Jeu de clés 50 pcs

755 06...32	6-7-8-9-10-11-12-13-14-15-16-17-18-19-20-21-22-23-24-25-26-27-28-30-32 mm steekring, clés mixtes
759 0607...3032	6x7-8x9-10x11-12x13-14x15-16x17-18x19-20x22-21x23-24x27-25x28-30x32 mm gebogen ringsleutels - clés polygonales
754 0607...3032	6x7-8x9-10x11-12x13-14x15-16x17-18x19-20x22-21x23-24x27-25x28-30x32 mm steeksleutels - clés à fourche

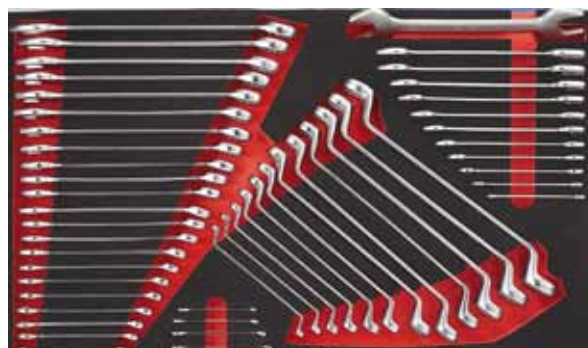

### FOR F5461 - Jumbo

Sleutelset 46 delig  
Jeu de clés 46 pcs

757 08...19	8-9-10-11-12-13-14-15-16-17-18-19 mm ratel steeksleutels
760 0810...2224	8x10-12x14-13x15-16x18-17x19-21x23-22x24 mm XL
755S08...19	8-9-10-11-12-13-14-15-16-17-18-19 mm mini steekring
751 0810...3032	8x10-9x11-12x13-14x15-16x18-17x19-19x22-24x27-30x32 mm open ringsleutels, clés à tuyauter
756 0607...2024	E6xE8-E7xE11-E10xE12-E14xE18-E16xE22-E20xE24 torx sleutels, clés torx



### FOR F5522 - Jumbo

Sleutelset 52 delig  
Jeu de clés 52 pcs

751 0810...3032	8x10-9x11-12x13-14x15-16x18-17x19-19x22-24x27-30x32 open ringsleutels -clés à tuyauter
757 08...24	8-9-10-11-12-13-14-15-16-17-18-19-20-21-22-23-24mm-ratelsleutels - clés mixte à cliquet
761 0810...1719	8x10-11x13-12x14-13x15-17x19mm halve maansleutels - clés demi-lune
758 0809...2224	8x9-10x11-12x13-14x15-16x17-18x19-21x23-22x24 mm gebogen ringsleutels -clés polygonales
754 0607...3032	6x7-8x9-10x11-12x13-14x15-16x17-18x19-20x22-21x23-24x26-25x28-27x30-32x36 mm steeksleutels- clés à fourches

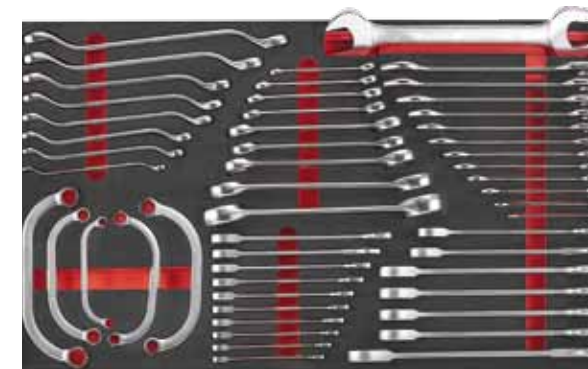

### FOR F5422 - Jumbo

Sleutelset 42 delig  
Jeu de clés mixtes 42 pcs

755 06...38	6-7-8-9-10-11-12-13-14-15-16-17-18-19-20-21-22-23-24-25-26-27-28-30-32-33-34-36-38 mm steekringsleutels - clés mixtes
755S08...19	8-9-10-11-12-13-14-15-16-17-18-19mm mini steekringsleutels - clés mixte courtes





**FOR F5173 - Jumbo****Tangenset 17 delig****Jeu de pinces 17 pcs**

609ASC	borgveertang, pince circlips
609ASO	borgveertang, pince circlips
609ABC	borgveertang, pince circlips
609ABO	borgveertang, pince circlips
610B200	lange bektang, pince à becs long 200 mm
610B200B	gebogen lange bektang, pince à becs long coudé 200 mm
611B175	kombinatietang, pince universelle 175 mm
612B175	kniptang, pince coupante 175 mm
613B250	waterpomptang, pince multiprise 250 mm
614250	vise grip tang, pince grip 250 mm
65202	schuine vise grip tang, pince étou à becs coudé
649250A	moersleutel, clé à molette 250 mm
6805	striptang, pince à sertir
6923160	kabelsnijtang, coupe câble
6921160	4 in 1 electrical tang
673B215	universele rondebek tang
6925160	kniptang 160 mm

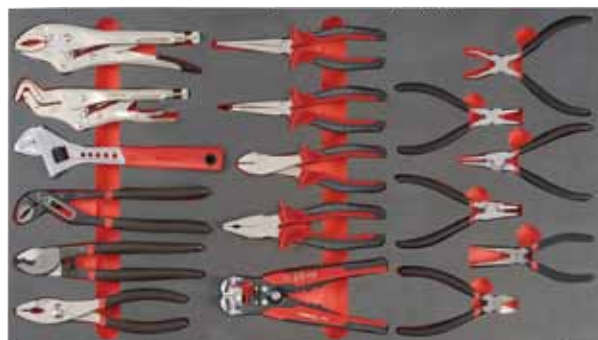
**FOR F5188 - Jumbo****Tangenset 18 delig****Jeu de pinces 18 pcs**

609ASC	borgveertang, pince circlips
609ASO	borgveertang, pince circlips
609ABC	borgveertang, pince circlips
609ABO	borgveertang, pince circlips
610B200	lange bektang, pince à becs long 200 mm
610B200B	gebogen lange bektang, pince à becs long coudé 200 mm
611B175	kombinatietang, pince universelle 175 mm
612B175	kniptang, pince coupante 175 mm
613B250	waterpomptang, pince multiprise 250 mm
614250	vise grip tang, pince grip 250 mm
65202	schuine vise grip tang, pince étou à becs coudé
649250E	moersleutel, clé à molette 250 mm
5047P1	lange bektang, pince à becs long
5047P2	lange bektang, pince à becs long 45°

**FOR F5296 - Jumbo****Tangenset 29 delig****Jeu de pinces 29 pcs**

609ASC	borgveertang, pince circlips
609ASO	borgveertang, pince circlips
609ABC	borgveertang, pince circlips
609ABO	borgveertang, pince circlips
610B200	lange bektang, pince à becs long 200 mm
610B200B	gebogen lange bektang, pince à becs long coudé 200 mm
611B175	kombinatietang, pince universelle 175 mm
612B175	kniptang, pince coupante 175 mm
613B250	waterpomptang, pince multiprise 250 mm
614250	vise grip tang, pince grip 250 mm
6805	automatische striptang
649250	moersleutel, clé à molette 250 mm
616300	bankhamer 300gr, marteau de mécanicien
616400	rubber hamer 400gr, marteau anti retour

**FOR F5242 - Jumbo****Hamer & beitelset 24 delig****Jeu de burins & acc. 24 pcs**

602 12150Q...22200Q	10-12-15-19-22-25 mm beitels, burins
603150Q	kapbeitel, bêdane
604 2140Q...8215Q	2-3-4-5-6-8 mm puntslag, pointeau
606 ....	4-5-6 mm puntbeitel
616300	hamer, marteau mécanicien 300 gr
616280	rubber hamer, marteau anti retour 280 gr
5055P4	mes, cutter à lame
5096P8	meter, mètre à ruban 5m
6982	schaar, ciseau
5055P1	metaalplaatshaar, ciseau pour métal
66302	mini zaag, scie mini

**FOR F5272 - Jumbo****Hamer & beitelset 27 delig****Jeu de burins & acc. 27 pcs**

602 12150Q...22200Q	12-19-25 mm beitels, burins
603150Q	kapbeitel, bêdane
604 2140Q...8215Q	2-3-4-5-6-8 mm puntslag, pointeau
60410230Q	puntslag 10 230mmL, pointeau
6074185Q	center punt 4 185mmL
616500	hamer, marteau mécanicien 500 gr
616G1250	blokhamer, massette 1250 gr
5055P4	mes, cutter à lame
5096P805	meter, mètre à ruban 5m
5056P1	platte vijl - lime plat
5056P2	halfronde vijl - lime demi ronde
5056P3	ronde vijl - lime ronde
5056P5	driehoeksvijl - lime triangle
610B200	lange bektang - pince à becs long
610B200B	lange gebogen bektang - pince à becs long coudé
611B175	kombinatietang - pince universelle
612B175	kniptang - pince coupante
613B250	waterpomptang - pince multiprise
614250	vise grip tang - pince grip
905M2P3	schraper, grattoir

**FOR F5292 - Jumbo****Sleutel-haakset 29dlg****Jeu de clés 29pcs**

905M2P1	vork voor deurbekleding, grattoir
905M2P2	schraper plat, grattoir plat
905M2P3	schraper, grattoir
905M2P4	schraper gebogen, grattoir coudée
905M2P5	haak algemeen gebruik, crochet
905M1	Clipverwijderaars 5dlg
774300 06...14	6-7-8-9-10-11-12-13-14mm T greep dopsleutels
765 02...12	2-2.5-3-4-5-6-7-8-10-12mm L greep kogelinbus sleutels, clés mâles à tête sphérique







## FOR F5521 - Jumbo

Vijl & meetset 52 delig

Outils de mesure 52 pcs

751 0810....3032	8x10-9x11-11x13-12x14-14x17-16x18-17x19-24x27-30x32 mm open ringsleutel-clé à tuyauter
5056P1	platte vijl, lime plat
5056P2	half ronde vijl, lime demi rond
5056P3	ronde vijl, lime ronde
5056P4	vierkants vijl, lime quarré
5056P5	driehoeksvijl, lime triangle
8174	slagschroevendraaier + 12 bits, tournevis à frappe
63005	linkse tappenset, extracteurs
5096P1	schuif mm, pied à coulisse
5096P2	kraspen, pointe à tracer
5096P3	meetlat, règle en metal
5096P4	gradenboog, rapporteur
5096P5	voelermaatjes, jauges d'épaisseur 0.25-6 mm
5096P6	voelermaatjes, jauges d'épaisseur 4-62 inch
61802	voelermaatjes, jauges d'épaisseur mm+inch

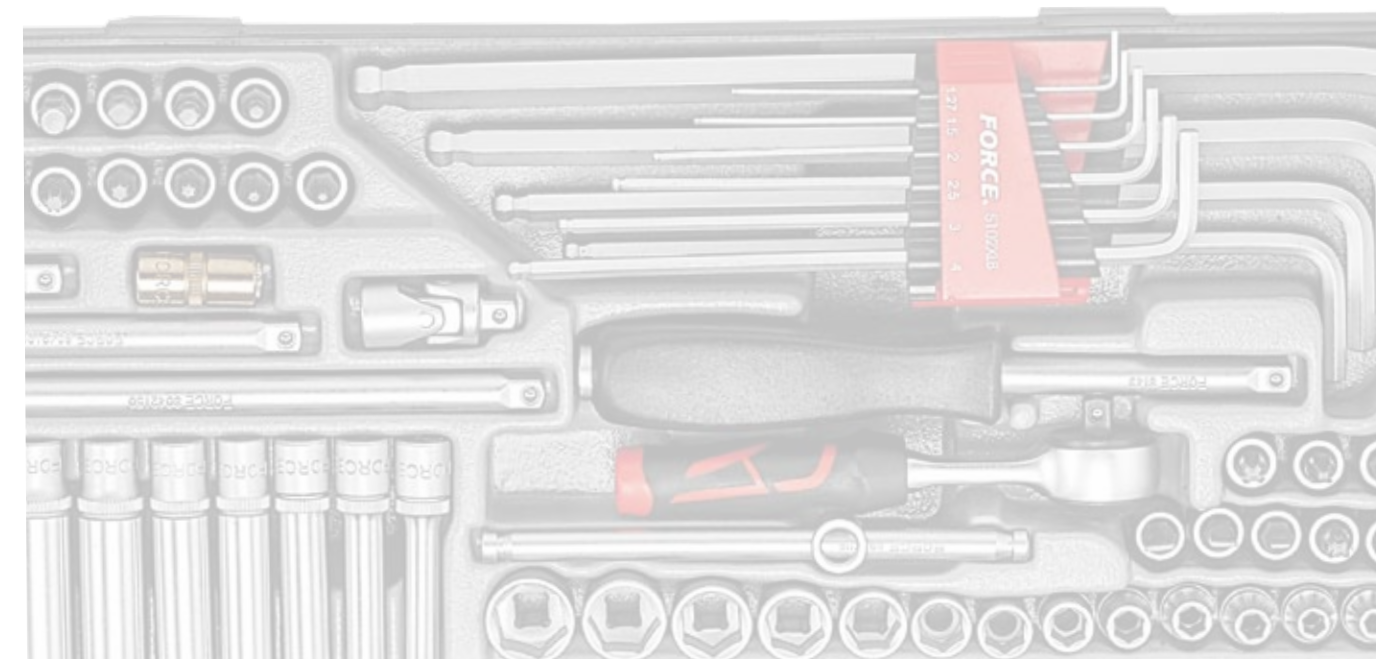
# Jumbo



## FOR F5352 - Jumbo

Vijl & meetset 35 delig

Outils de mesure 35 pcs

5055p4	universeel mes- cutter à lame
5056P1	platte vijl, lime plat
5056P2	half ronde vijl, lime demi rond
5056P3	ronde vijl, lime ronde
5056P4	vierkants vijl, lime quarré
5056P5	driehoeksvijl, lime triangle
8174	slagschroevendraaier + 12 bits, tournevis à frappe
63005	linkse tappenset, extracteurs
5096P1	schuifmaat, pied à coulisse
5096P2	kraspen, pointe à tracer
5096P3	stalen meetlat 30cm
5096P4	gradenboog, rapporteur
5096P5	voelermaatjes, jauges d'épaisseur 0.25-6 mm
5096P6	voelermaatjes, jauges d'épaisseur 4-62 inch
5096P7	stalen naald
60226200C	platte beitel 26x200L



	Doppensets - jeu de douilles 1/4"	88
	Doppen - douilles 1/4"	88
	Ratels - cliquets 1/4"	98
	Accessoires 1/4"	99
	Doppensets - jeu de douilles 3/8"	100
	Doppensets inch - jeu de douilles en pouce 3/8"	104
	Doppen - douilles 3/8"	105
	Ratels - cliquets 3/8"	109
	Accessoires 3/8"	108
	Doppensets - jeu de douilles 1/2"	110
	Doppensets inbus - jeu de douilles hex 1/2"	117
	Doppensets torx - jeu de douilles torx 1/2"	118
	Doppensets XZN - jeu de douilles XZN 1/2"	121
	Doppensets inch maten - jeu de douilles en pouce	121
	Doppen - douilles 1/2"	122
	Accessoires 1/2"	129
	Ratels - cliquets 1/2"	130
	Doppensets - jeu de douilles 3/4"	131
	Doppen & toebehoren - douilles 3/4"	132
	Doppensets - jeu de douilles 1"	134
	Accessoires 1"	135

### FOR 2133-5

1/4" Doppenset 6 kant 13 delig op rail  
1/4" Jeu de douilles 6 pans 13 pcs sur rail



525 04....14	4-4.5-5-5.5-6-7-8-9-10-11-12-13-14 mm
--------------	---------------------------------------

### FOR 21110-5

1/4" Lange 6 kant doppenset 11 delig op rail SAE  
1/4" Douilles longues 6 pans 11 pcs sur rail SAE



	5/32"- 3/16"-7/32"-1/4"-9/32"-5/16"-11/32"-3/8"-7/16"-1/2"-9/16"
--	--

### FOR 2133

1/4" Doppenset 12 kant 13 delig op rail  
1/4" Jeu de douilles 12 pans 13 pcs sur rail



529 04....14	4-4.5-5-5.5-6-7-8-9-10-11-12-13-14 mm
--------------	---------------------------------------

### FOR 21115

1/4" Lange 6 kant doppenset 11 delig op rail  
1/4" Douilles longues 6 pans 11 pcs sur rail



5255 004....14	4-5-6-7-8-9-10-11-12-13-14 mm (50mmL)
----------------	---------------------------------------

### FOR 21014

1/4" Lange 12 kant doppenset 10 delig op rail  
1/4" Douilles longues 12 pans 10 pcs sur rail



5295 005....14	5-6-7-8-9-10-11-12-13-14 mm (50mmL)
----------------	-------------------------------------

### FOR 21016

1/4" Torx E doppen 10dlg op rail  
Jeu de douilles Torx E 1/4" 10pcs sur rail



526 serie	1/4" E4-E5-E6-E7-E8-E10-E11-E12-E14-E16
-----------	---

### FOR 20812

Torxset 1/4" 8 delig  
Jeu de Torx 1/4" 8pcs



32632 08....40	1/4"	T8-T10-T15-T20-T25-T27-T30-T40 (32 mm L)
----------------	------	--

### FOR 21111

Torxset 1/4" - 3/8" 11 delig  
Jeu de Torx 1/4" - 3/8" 11 pcs



32632 10....30	1/4"	T10-T15-T20-T25-T27-30 (32 mm L)
33650 40....60	3/8"	T40-T45-T50-T55-T60 (50 mm L)

### FOR 21121

Resistorxset 1/4" - 3/8" 11 delig  
Resistorx 1/4" - 3/8" 11 pcs



32732 10....30	1/4"	T10H-T15H-T20H-T25H-T27H-30H (32mmL)
33750 40....60	3/8"	T40H-T45H-T50H-T55H-T60H (32mmL)

### FOR 20711

1/4" Resistorx 5 kant doppenset 7 delig op rail  
1/4" Resistorx 5 pans douilles 7 pcs sur rail



32F32 10....40	TS10-TS15-TS20-TS25-TS27-TS30-TS40 (32mmL)
----------------	--

### FOR 2073

1/4" Inbus doppenset 7 delig op rail  
1/4" Jeu de douilles hexagonales 7 pcs sur rail



32432 03....10	3-4-5-6-7-8-10 mm (32mmL)
----------------	---------------------------

### FOR 2073S

1/4" Inbus doppenset inch 7 delig op rail  
1/4" Jeu de douilles hexagonales 7 pcs sur rail



32432 1.8....3.8	1/2"-5/32"-3/16"-7/32"-1/4"-5/16"-3/8"
------------------	--





**FOR 2222**

1/4" Doppenset 22 delig  
1/4" Jeu de douilles 22 pcs

display stand (12 sets)



121251 .... 3	1/4" PH1 - PH2 - PH3 (25 mm L)
12325 04 .... 065	1/4" plat 4-5,5-6,5 mm
12425 03....06	1/4" inbus 3-4-5-6 mm
12625 10....30	1/4" torx 10-T15-T20-T25-T30
525 06....13	1/4" 6-7-8-10-13 mm dop 6-kant
8092225	bit adapter 1/4" - 1/4"
802214	1/4" ratel, cliquet



**FOR 2292**

1/4" Doppenset 29 delig geleverd in pvc koffer  
1/4" Jeu de douilles 29 pcs 6 pans



5250 04...13	doppen 6k 4-4,5-5-5,5-6-7-8-9-10-11-12-13 mm
323 04...07	bit dop plat 4-5,5-7
324 03...08	hex 3-4-5-6-8
321 01...2	philips 1-2
322 01...2	pozidriv 1-2
8143	steekhecht, manche tournevis
8042050	verlengstuk - rallonge 50 mm
8032115	wringstaaf, manche en T
80222	ratel, cliquet
80521	kniegewricht, cardan universeel



**FOR 2421**

1/4" Doppenset 42 delig geleverd in pvc koffer  
1/4" Jeu de douilles 42 pcs 6 pans



	doppen 6 kant - douilles 6 pans
525 032....14	3,2-4,-4,5-5-5,5-6-7-8-9-10-11-12-13-14 mm
12425 03....08	Inbus 3,4,5,6,8 mm
12625 10....40	Torx T10-T15-T20-T25-T30-T40
12325 04....065	plat 4-5,5-6,5 mm
12125 1....3	philips PH-1-PH-2-PH-3
12225 1....3	pozidriv PZ-1-PZ-2-PZ-3
80229	ratel, cliquet
8042 050....150	2 verlengstukken, rallonges 50-150 mm
80521	kniegewricht, cardan universeel
81022	bit houder 1/4"x1/4"
8143	steekhecht, manche tournevis
80632	1 adapter voor verlengstuk 3/8"x1/4"
81225	magneet, aiment



**FOR 2312**

1/4" Doppenset 12kant 31 delig mm + inch in pvc koffer  
1/4" Jeu de douilles 12 pans mm + en pouce en coffret PVC 31 pcs



529 004....14	12k doppen metric, douille 12pans en pouce 4-4,5-5-5,5-6-7-8-9-10-11-12-13-14 mm
529 3,16....9,16	12k doppen Inch 3/16"-7/32"-1/4"-9/32"-5/16" 11/32"-3/8"-7/16"-1/2"-9/16"
80222	ratel, cliquet
8042 050....150	verlengstukken, rallonges 50-150 mm
80622	adapter 1/4"*1/4"
80521	kniegewricht, cardan universeel
8145	steekhecht, manche tournevis
81022	1 bit houder, porte embout
8111	flexibel verlengstuk, rallonge flex



**FOR 2312-5**

1/4" Doppenset 31 delig mm + inch in pvc koffer  
- idem maar 6 kant doppen  
1/4" Jeu de douilles 31 pcs metric + en pouce en coffret t PVC 6 pans



**FOR 2402**

1/4" Doppenset 40 delig mm + inch in pvc koffer 6kant  
1/4" Jeu de douilles 40 pcs mm et en pouce 6 pans



525 04....13 6k	4-4,5-5-5,5-6-7-8-9-10-11-12-13 mm
525 3,16....1,2	3/16"-1/4"-9/32"-11/32"-3/8"-1/2" lange doppen, douilles longues 6pans
52550 04....13	4-5-5,5-6-7-8-9-10-11-13 mm
52550 3,16....1,2	3/16"-1/4"-3/8"-1/2"
80225	ratel, cliquet
8042 050....150	verlengstuk, rallonge 50-75-150 mm
8111	flexibel verlengstuk, rallonge flex
8032115	T schuifstuk, manche en T
80521	kniegewricht, cardan universeel
8143	steekhecht, manche tournevis



**FOR T2741**

TC module met doppenassortiment 74 delig mm + inch maten 6k  
 TC module 74 pcs jeu de douilles & acc. mm + et en pouce 6 pans



	<b>6k doppen - douilles 6 pans</b>
525 04...13	4-4,5-5-5,5-6-7-8-9-10-11-12-13 mm
525 3,16...1,2	3/16"-1/4"-9/32"-11/32"-3/8"-1/2"
	<b>6k lange doppen - douilles longues 6p</b>
52550 04...13	4-4,5-5-5,5-6-7-8-9-10-11-12-13 mm
52550 3,16...1,2	3/16"-1/4"-9/32"-11/32"-3/8"-1/2"
32432 03...10	Inbus 3-4-5-6-7-8-10 mm
32432 1,8...3,8	Inbus 1/8"-3/16"-7/32"-1/4"-3/8"
32132 1...3	Philips PH1-PH2-PH3
32232 1...3	Pozidriv PZ1-PZ2-PZ3
32332 03...065	Plat 3-4-5,5-6,5 mm
32632 08...40	Torx T8-T10-T15-T20-T25-T27-T30-T40
802215	ratel, cliquet
8042 050...150	verlengstukken, rallonge 50-100-150 mm
80521	kniegewricht, cardan universel
8143	steekhecht, manche tournevis
81225	magneet pick up tool, aiment
8032115	wringstaaf, manche en T

**FOR T2742**

TC module met doppenassortiment 74 delig 6k  
 TC module 74 pcs jeu de douilles & acc. 6 pans



52504...13	doppen - douilles
	4-4,5-5-5,5-6-7-8-9-10-11-12-13 mm
5255004...13	12 lange doppen - douilles longues
	4-4,5-5-5,5-6-7-8-9-10-11-12-13 mm
52604...10	6 torx doppen
	E4-E5-E6-E7-E8-E10
52650 04...10	6 lange torx doppen
	E4-E5-E6-E7-E8-E10
	1/4" 32 dop bits (32 mm L)
32432 03...10	Inbus 3-4-5-6-7-8-10 mm
321320...2	philips PH0-PH1-PH2
322232 0...2	pozidriv PZ0-PZ1-PZ2
32332 04...065	plat 4-5,5-6,5 mm
32632 08...40	torx T8-T10-T15-T20-T25-T27-T30-T40
32732 08...40	resistorx T8H-T10H-T15H-T20H
	T25H-T27H-T30H-T40H
802220	Tmini ratel, cliquet mini
8042 050...150	3 verlengstukken, rallonge 50-100-150 mm
80521	kniegewricht, cardan universel
81225	magneet, aiment

**FOR T2045**

TC module met 3 ratels & momentsleutel  
 TC module 3 cliquets & clé dynamométrique

6472270	Momentsleutel, clé dynamométrique 5-25nw
802215	Ratel, cliquet
802219	Stubby ratel, cliquet court
802218	Flexibel ratel, cliquet flexible



**FOR T2641**

TC module met doppenassortiment 65 delig 6 kant  
 TC module 65 pcs douilles et acc. 6 pans

525 032...14	doppen 6 kant - douilles 6 pans
	3,2-4-4,5-5-5,5-6-7-8-9-10-11-12-13-14 mm
52550 05...13	lange doppen - douilles longues 6p
	5-6-7-8-9-10-11-12-13 mm
	dop bit (32 mm L)
32432 03...10	inbus 3-4-5-6-7-8-10 mm
32132 1...3	philips PH1-PH2-PH3
32232 1...3	pozidriv PZ1-PZ2-PZ3
3233204...065	plat 4-5,5-6,5 mm
32632 08...40	torx T8-T10-T15-T20-T25-T27-T30-T40
80229	ratel, cliquet
8042 050...150	3 verlengstukken, rallonge 50-100-150 mm
8032115	wringstaaf, manche en T
80521	kniegewricht, cardan universel
8143	steekhecht, manche tournevis
81225	magneet, aiment
5102XLB	ball point inbussleutelset, clés mâles
	1,27-1,5-2-2,5-3-4-5-6-8-10 mm





Art.nr	mm	L mm
FOR 52504	4 mm	25
FOR 525045	4.5 mm	25
FOR 52505	5 mm	25
FOR 525055	5.5 mm	25
FOR 52506	6 mm	25
FOR 52507	7 mm	25
FOR 52508	8 mm	25
FOR 52509	9 mm	25
FOR 52510	10 mm	25
FOR 52511	11 mm	25
FOR 52512	12 mm	25
FOR 52513	13 mm	25
FOR 52514	14 mm	25



**Doppen 6 kant 1/4"**  
*Douilles 6 pans 1/4"*



Art.nr	mm	L mm
FOR 52604	E4	25
FOR 52605	E5	25
FOR 52606	E6	25
FOR 52607	E7	25
FOR 52608	E8	25
FOR 52610	E10	25
FOR 52611	E11	25
FOR 52612	E12	25
FOR 52614	E14	25
FOR 52616	E16	25



**Torx doppen 6 kant 1/4 "**  
*Douilles Torx 6 pans 1/4 "*



Art.nr	mm	L mm
FOR 52904	4 mm	25
FOR 52905	5 mm	25
FOR 52906	6 mm	25
FOR 52907	7 mm	25
FOR 52908	8 mm	25
FOR 52909	9 mm	25
FOR 52910	10 mm	25
FOR 52911	11 mm	25
FOR 52912	12 mm	25
FOR 52913	13 mm	25
FOR 52914	14 mm	25



**Doppen 12 kant 1/4"**  
*Douilles 12 pans 1/4"*



Art.nr	mm	L mm
FOR 5265004	E4	50
FOR 5265005	E5	50
FOR 5265006	E6	50
FOR 5265007	E7	50
FOR 5265008	E8	50
FOR 5265010	E10	50



**Lange torx doppen 6 kant 1/4"**  
*Douilles Torx longues 6 pans 1/4"*



Art.nr	mm	L mm
FOR 5255004	4 mm	50
FOR 52550045	4.5 mm	50
FOR 5255005	5 mm	50
FOR 52550055	5.5 mm	50
FOR 5255006	6 mm	50
FOR 5255007	7 mm	50
FOR 5255008	8 mm	50
FOR 5255009	9 mm	50
FOR 5255010	10 mm	50
FOR 5255011	11 mm	50
FOR 5255012	12 mm	50
FOR 5255013	13 mm	50
FOR 5255014	14 mm	50



**Lange doppen 6 kant 1/4"**  
*Douilles longues 6 pans 1/4"*



Art.nr	mm	L mm
FOR 5290045	4.5 mm	50
FOR 5295005	5 mm	50
FOR 52950055	5.5 mm	50
FOR 5295006	6 mm	50
FOR 5295007	7 mm	50
FOR 5295008	8 mm	50
FOR 5295009	9 mm	50
FOR 5295010	10 mm	50
FOR 5295011	11 mm	50
FOR 5295012	12 mm	50
FOR 5295013	13 mm	50



**Lange doppen 12 kant 1/4"**  
*Douilles longues 12 pans 1/4"*



**Inbus op dop 6 kant 1/4"**  
*Embouts sur douilles hex 6 pans 1/4"*



Art.nr	mm	L mm
FOR 3243203	3 mm	32
FOR 3243204	4 mm	32
FOR 3243205	5 mm	32
FOR 3243206	6 mm	32
FOR 3243207	7 mm	32
FOR 3243208	8 mm	32
FOR 3243210	10 mm	32

Art.nr	mm	L mm
FOR 321320	PH0	32
FOR 321321	PH1	32
FOR 321322	PH2	32
FOR 321323	PH3	32
FOR 322320	PZ0	32
FOR 322321	PZ1	32
FOR 322322	PZ2	32
FOR 322323	PZ3	32



**Philips-pozidriv op dop 1/4"**  
*Embouts sur douilles philips 1/4"*



**Torx - Resistorx op dop 1/4"**  
*Embouts sur douilles torx - Resistorx 1/4"*



Art.nr	mm	L mm
FOR 3263208	T8	32
FOR 3263210	T10	32
FOR 3263215	T15	32
FOR 3263220	T20	32
FOR 3263225	T25	32
FOR 3263227	T27	32
FOR 3263230	T30	32
FOR 3263240	T40	32



Art.nr	mm	L mm
FOR 3273208	T8H	32
FOR 3273210	T10H	32
FOR 3273215	T15H	32
FOR 3273220	T20H	32
FOR 3273225	T25H	32
FOR 3273227	T27H	32
FOR 3273230	T30H	32
FOR 3273235	T35H	32
FOR 3273240	T40H	32

Art.nr	mm	L mm
FOR 3233204	0.8x4	32
FOR 32332055	1.0x5.5	32
FOR 32332065	1.2x6.5	32
FOR 3233207	1.2x7	32



**Platte bit op dop 1/4"**  
*Embouts sur douilles plat 1/4"*



**Resistorx 5 kant op dop 1/4"**  
*Embouts sur douilles Resistorx 5 pans 1/4"*



Art.nr	mm	L mm
FOR 32F3210	TS10	32
FOR 32F3215	TS15	32
FOR 32F3220	TS20	32
FOR 32F3225	TS25	32
FOR 32F3227	TS27	32
FOR 32F3230	TS30	32
FOR 32F3240	TS40	32





**Ratel 24 tanden 1/4"**  
**Cliquet 24 dents 1/4"**

Art.nr		L mm
FOR 80222	24T	143 mm
FOR 80222P	herstelkit	kit rep
FOR 80228	72 T	140

**Ratel 72 tanden 1/4"**  
**Cliquet 72 dents 1/4"**

Art.nr		L mm
FOR 80229		116 mm
FOR 80229P	herstelkit	kit rep

**Ratel 20 tanden 1/4"**  
**Cliquet 20 dents 1/4"**

Art.nr		L mm
FOR 802215		133 mm
FOR 802215P	herstelkit	kit rep

**Ratel knikbaar 72 tanden 1/4"**  
**Cliquet 72 dents 1/4"**

Art.nr		L mm
FOR 802223		148 mm
FOR 802223P	herstelkit	kit rep

**Ratel 72 tanden 1/4"**  
**Cliquet 72 dents 1/4"**

Art.nr		L mm
FOR 802222		123 mm
FOR 802222P	herstelkit	

**Ratel knikbaar 20 tanden 1/4"**  
**Cliquet 20 dents 1/4"**

Art.nr		L mm
FOR 802218		127 mm
FOR 802218P		

**Ratel mini 20 tanden 1/4"**  
**Cliquet mini 20 dents 1/4"**

Art.nr		L mm
FOR 802219		100 mm
FOR 802219P	herstelkit	kit rep

**T Ratel mini 48 tanden 1/4"**  
**T Cliquet mini 48 dents 1/4"**

Art.nr		L mm
FOR 802220		110 mm

**Kniegewricht 1/4"**  
**Cardan universel 1/4"**

Art.nr	L mm
FOR 80521	37 mm

**Adapter 1/4" - 3/8"**  
**Adaptateur 1/4" - 3/8"**

Art.nr	L mm
FOR 80923	26 mm

**Magneet dop 1/4"**  
**Porte-embouts magnétique 1/4"**

Art.nr	L mm
FOR 81225	25 mm

**Bithouder 1/4"x 1/4"**  
**Porte embout 1/4"**

Art.nr	L mm
FOR 81022	25 mm
FOR 81022M	25 mm

**Verlengstuk 1/4"**  
**Rallonge 1/4"**

Art.nr	L mm
FOR 8042050	50 mm
FOR 8042100	100 mm
FOR 8042100W	100 mm
FOR 8042150	150 mm

**Flexibel verlengstuk 1/4"**  
**Rallonge flexible 1/4"**

Art.nr	L mm
FOR 8111	145 mm

**Steekhecht 1/4"**  
**Manche tournevis 1/4"**

Art.nr	L mm
FOR 8145	150 mm

**Steekhecht 1/4"**  
**Manche tournevis 1/4"**

Art.nr	L mm
FOR 8143	150 mm

**Wringstaaf 1/4"**  
**Poignée coulissante 1/4"**

Art.nr	L mm
FOR 8032115	115 mm

**Rail voor 10 doppen 1/4"**  
**Rail pour 10 douilles 1/4"**

Art.nr	L mm
FOR 819210	160 mm

**FOR 3093**

3/8" Doppenset op rail 9 delig 6 kant  
3/8" Jeu de douilles sur rail 9 pcs 6 pans



535 09...19	9-10-11-12-13-14-15-17-19 mm
-------------	------------------------------

**FOR 3082**

3/8" Lange doppenset op rail 8 delig 6 kant  
3/8" Jeu de douilles longues sur rail 8 pcs 6 pans



53563 08...19	8-10-12-13-14-16-17-19 mm (63 mm L)
---------------	-------------------------------------

**FOR 3065**

3/8" Inbus doppenset 6 delig op rail  
3/8" Jeu de douilles hexagonales 6 pcs sur rail



334050 04...10	4-5-6-7-8-10 mm (50 mm L)
----------------	---------------------------

**FOR 3099**

3/8" 1/2" Inbus doppenset 9 delig op rail  
3/8" 1/2" Jeu de douilles hexagonales 9 pcs sur rail



334050 04...10	3/8" 4-5-6-7-8-10 mm (50 mm L)
344050 12...17	1/2" 12mm (55mmL) 14mm (65mmL) 17mm (70mmL)

**FOR 3086**

3/8" Torx doppenset 8 delig op rail  
3/8" Torx douilles 8 pcs sur rail



33650 20...55	T20-T25-T27-T30-T40-T45-T50-T55 (50mmL)
---------------	---

**FOR 3095**

1/4" - 3/8" 5 tands resistorx doppenset 9 delig op rail  
1/4" - 3/8" 5 pans resistorx douilles 9 pcs sur rail



32F32 10...40	1/4" TS10-TS15-TS20-TS25-TS27-TS30-TS40
33F50 45...50	3/8" TS45-TS50

**FOR 30911**

3/8" XZN doppenset 9 delig op rail  
3/8" XZN Douilles 9 pcs sur rail

33850 20...55	T20-T25-T27-T30-T40-T45-T50-T55 (50mmL)
---------------	---



**FOR 30912**

3/8" 1/2" Ribe doppenset 9 delig op rail  
3/8" - 1/2" Douilles Ribe 9 pcs sur rail

33909005...10	M5-M6-M7-M8-M9-M10 (90mmL)
349100 12...14	M12-M13-M14 (100mmL)



**FOR 3039**

3/8" Verlengstukken 3dlg  
3/8" Jeu de rallonges 3pcs

8043075...250	75mm-150mm-250mm
---------------	------------------



**FOR T30712**

TC module 7 delig ratels & momentsleutel 3/8"  
TC module 7 cliquet & acc. 3/8"

6473365	Momentsleutel, clé dynamométrique
802323	Ratel, cliquet 72t
80232	Ratel, cliquet 24t
802319	Stubby ratel, cliquet 30t
8073 16...20,6M	3-bougiedoppen, douilles 16-18-20,6 mm



**FOR T3251 5**

TC module met assortiment 6kant doppen 24 delig  
TC module douilles 6 pans & acc. 24 pcs

535 06...22	6-7-8-9-10-11-12-13-14-15-16-17-18-19-20-21-22mm
80232	ratel, cliquet
8043 075...150	2 verlengstukken, rallonge 75 mm-150 mm
80531	kniegewricht, cardan universel
8033165	wringstaaf, manche en T
8073 16...20,6	2 bougiedoppen, douilles 16-20,6 mm





**FOR T3121**

TC module met 12 lange doppen 6 kant  
TC module 12 douilles longues 6 pans



53563 08....22	8-10-11-12-13-14-15-16-17-18-19-22 mm
----------------	---------------------------------------

**FOR T3361**

TC module doppen assortiment 36 delig 6kant  
TC module douilles & acc. 6 pans 36 pcs



535 06....22	6-7-8-9-10-11-12-13-14-15-16-17-18-19-20-21-22mm
80239	ratel, cliquet
8043 075....225	3 verlengstukken, rallonges 75-150-225 mm
8073 16....20,6	2 bougiedoppen 16-20, 6 mm
80531	kniegewricht, cardan universeel
80643	adapter 1/2" * 3/8"
755 07....17	7-8-9-10-11-12-13-14-15-16-17 mm steekring, clés mixtes

**FOR T3311**

TC module doppen set & toebehoren 31 delig 6kant  
TC module douilles & acc. 31 pcs 6 pans



535 06....12	6-7-8-9-10-11-12 mm
53563 06....12	lange doppen 6-7-8-9-10-11-12 mm
334050 03....12	Hex dop bit 50 mm L 3-4-5-5,5--7-8-9-10-12 mm
8013215	wringstaaf met kniegewricht, poignée articulée
8043 044....250	verlengstukken, rallonge 44-75-150-250 mm
80531	kniegewricht, cardan universeel
80633	adapter 3/8"

**FOR T3331**

TC module doppen set kort & lang 33 delig 6 kant  
TC module 33 douilles 6 pans



535 13....24	13-14-15-16-17-18-19-20-21-22-24mm doppen
53563 13....22	13-14-15-16-17-18-19-20-21-22mm lange doppen
33650 08....60	T8-T10-T15-T20-T25-T27-T30 T40-T45-T50-T55-T60 (50mmL) torx doppen

**FOR T3381**

TC module torx XZN doppen set 28 delig 6 kant  
TC module 28 douilles torx + XZN 6 pans



	Torx doppen, douilles torx
536 04....16	E4-E5-E6-E7-E8-E10-E11-E12-E14-E16 Torx lange doppen, douilles longues torx
53655 04....07	E4-E5-E6-E7-E8-E10-E11-E12-E14-E16
53663 08....16	E8-E10-E11-E12-E14-E16
33750 08....60	T8H-T10H-T15H-T20H-T25H-T27H-T30H T40H-T45H-T50H-T55H-T60H ResisTorx (50mmL)
33850 05....12	MX-M6-M8-M9-M10-M12 XZN (50mmL)

**FOR T3521**

TC module tor x Bitset 52 delig  
TC module douilles & acc. torx 52 pcs

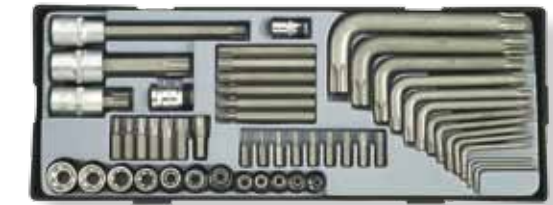

15630 20....55	5/16" torx bit T20-T25-T30-T40-T50-T55 (30mmL)
15670 20....50	5/16" T20-T30-T40-T45-T50 (70 mm L)
526 04....08	1/4" Torx dop E4-E5-E6-E7-E8
536 10....20	3/8" E10-E11-E12-E14-E16-E18-E20
766 09....70	star L sleutel T9-T10-T15-T20-T25-T27 T30-T40-T45-T50-T55-T60-T70
12725 08....40	1/4" Resistorx bit T8H-T10H-T15H T20H-T25H-T27H-T30H-T35H-T40H (25 mm L) 3 Torx bit 1/2"
34614055	T55 (140 mm L)
34605560	T60 (55 mm L)
34610070	T70 (100 mm L)
810 22....35	bit houder, porte embout 1/4" x 1/4" - 3/8" x5/16"

**FOR T31010**

TC module bougie vervangset 3/8" 10 dlg  
TC module douilles pour bougie 3/8" 10pcs



80531E	kniegewricht
832 318...324	torque adapter 18Nm-24Nm
807314M	magnetische bougiedoppen 14 mm
807316M	bougiedop 16 mm
807318M	bougiedop 18 mm
807320.6M	bougiedop 20.6mm
807325014M	14 mm 250 mL
807325016M	16 mm 250 mL
807325020.6M	20.6 mm 250 mL

**FOR 3261**

3/8" Doppenset 26 dlg in pvc koffer  
Set de douilles 26pcs

535 06....22	6-7-8-9-10-11-12-13-14-15-16-17-18-19-20-21-22-24mm
80232	ratel, cliquet
8043 044....150	3 verlengstukken, rallonge 44mm-75 mm-150 mm
80531	kniegewricht, cardan universeel
80643	adapter voor verlengstuk
8073 16....20,6	2 bougiedoppen, douilles pour bougie 16-20,6 mm



**FOR 3093S**

3/8" Doppenset op rail 9 delig 6k inch maten  
3/8" Jeu de douilles sur rail 9 pcs 6 pans



535 3.8....15.16	3/8"-7/16"-1/2"-9/16"-5/8"-11/16"-3/4"-13/16"-15/16"
------------------	--



**FOR T3212**

TC module met 6k doppenassortiment 21 delig inch  
TC module douilles 6 pans & acc. et en pouce 21 pcs



535 1.4....7.8	1/4"-5/16"-3/8"-7/16"-1/2"-9/16"
	19/32"-5/8"-11/16"-3/4"-25/32"-13/16"-7/8"
80232	ratel, cliquet
8033165	wringstaaf, manche en T
8043 075...250	verlengstukken, rallonge 75-150-250 mm
80531	kniegewricht, cardan universel
8073 16...20,06	bougie doppen, douilles 16-20.6 mm



**FOR T3322**

TC module met doppenassortiment 32 delig mm+ inch  
TC module douilles & acc. mm et en pouce 6p 32 pcs



535 06....22	6-7-8-9-10-11-12-13-14-15-16-17-18-19-20-21-22
535 1.4....13.16	1/4"-3/8"-1/2"- 9/16"-5/8"-11/16"-13/16"
802322	ratel, cliquet 72t
80643	adapter, adaptateur 1/2" x 3/8"
8043 075...225	verlengstukken, rallonges 75-150-225 mm
80531	kniegewricht, cardan universel
8073 16...20,06	bougie doppen, douilles



**FOR T3193**

TC module met 19 doppen 6k inch maten  
TC module 19 douilles en pouce 6 pans



535 1.4....7.8	1/4"-5/16"-3/8"-7/16"-1/2"-9/16"
	5/8"-11/16"-3/4"-13/16"-7/8"
53563 5,16....3,4	5/16"-3/8"-7/16"-1/2"-9/16"-5/8"-11/16"-3/4"



Art.nr	mm	L mm
FOR 53506	6 mm	28
FOR 53507	7 mm	28
FOR 53508	8 mm	28
FOR 53509	9 mm	28
FOR 53510	10 mm	28
FOR 53511	11 mm	28
FOR 53512	12 mm	28
FOR 53513	13 mm	28
FOR 53514	14 mm	30
FOR 53515	15 mm	30
FOR 53516	16 mm	30
FOR 53517	17 mm	30
FOR 53518	18 mm	30
FOR 53519	19 mm	30
FOR 53520	20 mm	30
FOR 53521	21 mm	30
FOR 53522	22 mm	32
FOR 53524	24 mm	32

FOR 5351.4	1/4"	28
FOR 5355.16	5/16	28
FOR 5353.8	3/8"	28
FOR 5357.16	7/16"	28
FOR 5351.2	1/2"	28
FOR 5359.16	9/16"	30
FOR 5355.8	5/8"	30
FOR 53511.16	11/16"	30
FOR 5353.4	3/4"	30
FOR 53513.16	13/16"	30
FOR 5357.8	7/8"	30

Art.nr	mm	L mm
FOR 5356306	6 mm	63
FOR 5356307	7 mm	63
FOR 5356308	8 mm	63
FOR 5356309	9 mm	63
FOR 5356310	10 mm	63
FOR 5356311	11 mm	63
FOR 5356312	12 mm	63
FOR 5356313	13 mm	63
FOR 5356314	14 mm	63
FOR 5356315	15 mm	63
FOR 5356316	16 mm	63
FOR 5356317	17 mm	63
FOR 5356318	18 mm	63
FOR 5356319	19 mm	63
FOR 5356320	20 mm	63
FOR 5356321	21 mm	63
FOR 5356322	22 mm	63

Art.nr	mm	L mm
FOR 535635.16	5/16	63
FOR 535633.8	3/8"	63
FOR 535637.16	7/16"	63
FOR 535631.2	1/2"	63
FOR 535639.16	9/16"	63
FOR 535635.8	5/8"	63
FOR 5356311.16	11/16"	63
FOR 535633.4	3/4"	63

**Doppen 6 kant 3/8"**  
**Douilles 6 pans 3/8"**



**Lange doppen 6 kant 3/8"**  
**Douilles longues 6 pans 3/8"**





Art.nr	mm	L mm
FOR 53604	E4	28
FOR 53605	E5	28
FOR 53606	E6	28
FOR 53607	E7	28
FOR 53608	E8	28
FOR 53610	E10	28
FOR 53611	E11	28
FOR 53612	E12	28
FOR 53614	E14	28
FOR 53616	E16	28
FOR 53618	E18	28
FOR 53620	E20	28

**Torx doppen inwendig 3/8"**  
*Douilles Torx 3/8"*



Art.nr	mm	L mm
FOR 33405003	3 mm	50
FOR 33405004	4 mm	50
FOR 33405005	5 mm	50
FOR 334050055	5.5 mm	50
FOR 33405006	6 mm	50
FOR 33405007	7 mm	50
FOR 33405008	8 mm	50
FOR 33405009	9 mm	50
FOR 33405010	10 mm	50
FOR 33405012	12 mm	50

**Inbus op dop 3/8"**  
*Embouts sur douilles hex 3/8"*



Art.nr	mm	L mm
FOR 5365504	E4	55
FOR 5365505	E5	55
FOR 5365506	E6	55
FOR 5365507	E7	55
FOR 5366308	E8	63
FOR 5366310	E10	63
FOR 5366311	E11	63
FOR 5366312	E12	63
FOR 5366314	E14	63
FOR 5366316	E16	63
FOR 5366318	E18	63

**Torx doppen inwendig 3/8"**  
*Douilles Torx 3/8"*



Art.nr	mm	L mm
FOR 3365008	T8	50
FOR 3365010	T10	50
FOR 3365015	T15	50
FOR 3365020	T20	50
FOR 3365025	T25	50
FOR 3365027	T27	50
FOR 3365030	T30	50
FOR 3365040	T40	50
FOR 3365045	T45	50
FOR 3365050	T50	50
FOR 3365055	T55	50
FOR 3365060	T60	50

**Torx op dop 3/8"**  
*Embouts sur douilles torx 3/8"*



Art.nr	mm	L mm
FOR 807314	14	63
FOR 807316	16	63
FOR 807318	18	63
FOR 807320.6	20.6	63
FOR 807314M	14	70
FOR 807316M	16M	70
FOR 807318M	18M	70
FOR 807320.6M	20.6M	70
FOR 807325014M	14M	250
FOR 807325016M	16M	250
FOR 807314MTH	14	70
FOR 807316MTH	16	70
FOR 807318MTH	18	70
FOR 807320.6MTH	20.5	70

**Bougiedop 6 kant 3/8"**  
*Douilles pour bougies 6 pans 3/8"*



Art.nr	mm	L mm
FOR 3375008	T8H	50
FOR 3375010	T10H	50
FOR 3375015	T15H	50
FOR 3375020	T20H	50
FOR 3375025	T25H	50
FOR 3375027	T27H	50
FOR 3375030	T30H	50
FOR 3375040	T40H	50
FOR 3375045	T45H	50
FOR 3375050	T50H	50
FOR 3375055	T55H	50
FOR 3375060	T60H	50

**Resistorx op dop 3/8"**  
*Embouts sur douilles resistorx 3/8"*



Art.nr	mm	L mm
FOR 3385005	M5	50
FOR 3385006	M6	50
FOR 3385008	M8	50
FOR 3385009	M9	50
FOR 3385010	M10	50
FOR 3385012	M12	50

**XZN op dop 3/8"**



Art.nr	mm	L mm
FOR 33909006	M6	90
FOR 33909007	M7	90
FOR 33909008	M8	90

**Ribe (5k) dop bit 3/8"**  
*Embout sur douilles Ribe (5p) 3/8"*



M = magnetisch  
M = magnétique  
MTH = dunwandig



**Verloopstuk 3/8"**  
**Adaptateurs 3/8"**



Art.nr	mm	L mm
FOR 80934	3/8" x 1/2"	46
FOR 80932	3/8" x 1/4"	35
FOR 80643	1/2" 3/8"	46
FOR 81037	bithouder	

**Verlengstuk 3/8"**  
**Ralongs 3/8"**



Art.nr		L mm
FOR 8043044		44 mm
FOR 8043044W	zwenkbaar	44 mm
FOR 8043075		75 mm
FOR 8043150		150 mm
FOR 8043225		225 mm
FOR 8043250		250 mm

**Ratel met ronde kop 3/8"**  
**Cliquet 3/8"**



Art.nr	tanden	L mm
FOR 80239	72	189
FOR 80239P	herstelkit	kit rep.

**Ratel knikbaar 3/8"**  
**Cliquet flexibel 3/8"**



Art.nr	tanden	L mm
FOR 802323	72	230
FOR 802323P	herstelkit	kit rep.

**Kniegewricht 3/8"**  
**Cardan universel 3/8"**



Art.nr	mm	L mm
FOR 80531		46

**Wringstaaf met schuifstuk 3/8"**  
**Poignée coulissante 3/8"**



Art.nr	mm	L mm
FOR 8033165		165

**Wringstaaf met kniegewricht 3/8"**  
**Poignée articulées 3/8"**



Art.nr	mm	L mm
FOR 8013215		215

**Rail voor 13 doppen 3/8"**  
**Rail pour 13 douilles 3/8"**



Art.nr	mm	L mm
FOR 819313		280 mm

**Ratel met ronde kop 3/8"**  
**Cliquet 3/8"**



Art.nr	tanden	L mm
FOR 802322	72	180
FOR 802322P	herstelkit	kit rep.

**Ratel 3/8"**  
**Cliquet 3/8"**



Art.nr	tanden	L mm
FOR 80232	24	200
FOR 80232P	herstelkit	kit rep.

**Ratel met kniegewricht 3/8"**  
**Cliquet avec cardan 3/8"**



Art.nr	tanden	L mm
FOR 802318		273
FOR 802318P	herstelkit	kit rep.

**Ratel 3/8"**  
**Cliquet 3/8"**



Art.nr	tanden	L mm
FOR 802315	30	198
FOR 802315P	herstelkit	kit rep.

**Mini ratel 3/8"**  
**Cliquet stubby 3/8"**



Art.nr	tanden	L mm
FOR 802319		134
FOR 802319P	herstelkit	kit rep.

**Ratel 3/8"**  
**Cliquet 3/8"**



Art.nr	tanden	L mm
FOR 80238	72	190
FOR 80238P	herstelkit	kit rep.

**T sleutel met cardangewricht 3/8"**  
**Clés T avec cardan 3/8"**



Art.nr	L mm
FOR 784206U	400
FOR 784207U	400
FOR 784208U	400
FOR 784209U	450
FOR 784310U	450
FOR 784311U	450
FOR 784312U	450
FOR 784313U	450
FOR 784314U	500
FOR 784315U	500
FOR 784316U	500
FOR 784317U	500
FOR 784418U	500
FOR 784419U	500





**FOR 4106**

1/2" Doppenset op rail 6k 10 delig  
1/2" Jeu de douilles sur rail 6 pans 10 pcs



545 11...24	11-12-13-14-15-17-19-21-22-24 mm
-------------	----------------------------------

**FOR 4082**

1/2" Lange doppenset 6k op rail 8 delig  
1/2" Douilles longues sur rail 6 pans 8 pcs



54577 13...24	13-14-15-17-19-21-22-24 mm (77mmL)
---------------	------------------------------------

**FOR 4083**

1/2" Lange doppenset inwendig torx op rail 8 delig  
1/2" Douille longues torx sur rail 8 pcs



54677 10...24	E10-E11-E12-E14-E16-E18-E20-E24 (77mmL)
---------------	---

**FOR 41014Q**

Lange doppenset inwendig XZN 10 delig  
1/2" Douille longues XZN (12p) 10 pcs



54Q77 10...24	10-11-12-14-16-18-20-24 (77 mm L) 12kant inwendig
---------------	---

**FOR 4113**

1/4" -3/8" - 1/2" Doppenset op rail inwendig torx 11 delig  
1/4" -3/8" -1/2" Douilles torx sur rail 11 pcs



526 05...08	1/4" E5-E6-E7-E8
536 10...14	3/8" E10-E11-E12-E14
546 16...20	1/2" E16-E18-E20

**FOR 4158**

1/2" - 3/8" - 1/4" Doppenset op rail inwendig torx 14 delig  
1/2" - 3/8" - 1/4" Douilles torx sur rail 14 pcs



526 04...08	1/4" E4-E5-E6-E7-E8
536 10...14	3/8" E10-E11-E12-E14
546 16...24	1/2" E16-E18-E20-E22-E24

**FOR T4212**

TC Module met 21 doppen 6k 1/2"  
TC Module 21 douilles 6 pans 1/2"



545 08...32	8-10-11-12-13-14-15-16-17-18-19-20-21-22-23-24-26-27-28-30-32 mm
-------------	--

**FOR T4212-9**

TC Module met 21 doppen 12k 1/2"  
TC Module 21 douilles 12 pans 1/2"



549 08...32	8-10-11-12-13-14-15-16-17-18-19-20-21-22-23-24-26-27-28-30-32 mm
-------------	--

**FOR T4143**

TC module met 14 lange doppen 6k 1/2"  
TC module 14 douilles longues 6 pans 1/2"



54577 10...32	10-12-13-14-15-17-19-21-22-23-24-27-30-32 mm
---------------	--

**FOR T4143-9**

TC module met 14 lange doppen 12k 1/2"  
TC module 14 douilles longues 12 pans 1/2"



54977 10...32	10-12-13-14-15-17-19-21-22-23-24-27-30-32 mm
---------------	--

**FOR T4248**

TC module met 24 doppen kort + lang 6k 1/2"  
TC module 24 douilles 6 pans 1/2"



545 08...19	8-9-10-11-12-13-14-15-16-17-18-19 mm
54577 08...19	8-9-10-11-12-13-14-15-16-17-18-19 mm

**FOR T4203**

1/2" TC module met 20 doppen 6k kort + lang  
1/2" TC module 20 douilles 6 pans 1/2"



545 20...32	20-21-22-23-24-26-27-28-30-32 mm
54577 20...32	20-21-22-23-24-26-27-28-30-32 mm

### FOR T4226

TC module 22 delig doppenset 6 kant 1/2"  
TC module 22 douilles & acc. 6 pans 1/2"

545 08 ... 26	8-9-10-11-12-13-14-15-16-17-18-19-20-21-22-23-24 mm
80248	ratel, cliquet
80634	3/8" x 1/2" adapter voor verlengstuk
8044125...250	verlengstuk, rallonge 125 mm-250mm
80541	kniegewricht, cardan universeel



### FOR T4057

TC module met ratel-sleutelset 5 delig 1/2"  
TC module 5 accessoires & cliquet 1/2"

802422	ratel, cliquet
8044 125...250	2 verlengstukken, rallonge 125-250 mm
8034250	wringstaaf, manche en T
80541	kniegewricht, cardan universeel



### FOR T40612

TC module ratel-sleutelset 6 delig 1/2"  
TC module 6 accessoires 1/2" & cliquet

802415	ratel, cliquet 72t
8044 125...250	2 verlengstukken, rallonge 125-250 mm
8034250	wringstaaf, manche en T
80541	kniegewricht, cardan universeel
8014380	wringstaaf met kniegewricht, manche avec cardan



### FOR K4087

Adapterset 8 delig  
Jeu de réducteurs & augmentateurs 8 pcs

80923	1/4" x 3/8"
80932	3/8" x 1/4"
80934	3/8" x 1/2"
80943	1/2" x 3/8"
80946	1/2" x 3/4"
80964	3/4" x 1/2"
80968	3/4" x 1"
80986	1" x 3/4"



### FOR 4243-5

1/2" Doppenset 24 delig 6 kant  
1/2" Jeu de douilles 24 pcs 6 pans

545 10 ... 32	10-11-12-13-14-15-16-17-18-19-20-21-22-23-24-27-30-32mm
80243	ratel, cliquet
8034250	wringstaaf, manche en T
8044125...250	2 verlengstukken, rallonge 125 mm-250 mm
80541	kniegewricht, cardan universeel
8014380	wringstaaf met kniegewricht, poignée articulée

### FOR 4243

547 10 ... 32	10-11-12-13-14-15-16-17-18-19-20-21-22-23-24-27-30-32mm golf profiel doppen, profiel convexe
80243	ratel, cliquet
8034250	wringstaaf, manche en T
8044125...250	2 verlengstukken, rallonge 125 mm-250 mm
80541	kniegewricht, cardan universeel
8014380	wringstaaf met kniegewricht, poignée articulée



### FOR 4243-9

1/2" Doppenset 24 delig 12 kant  
1/2" Jeu de douilles 24 pcs 12 pans

549 10 ... 32	10-11-12-13-14-15-16-17-18-19-20-21-22-23-24-27-30-32mm
80243	ratel, cliquet
8034250	wringstaaf, manche en T
8044125...250	2 verlengstukken, rallonge 125 mm-250 mm
80541	kniegewricht, cardan universeel
8014380	wringstaaf met kniegewricht, poignée articulée

### FOR 4255

1/2" Doppenset 25 delig 6kant  
1/2" Jeu de douilles 25 pcs 6 pans

545 10 ... 32	10-11-12-13-14-15-16-17-18-19-20-21-22-23-24-27-30-32mm
802433	ratel, cliquet
8334300	aanpasbare hendel
803A4300	wringstaaf, manche en T
8044125...250	2 verlengstukken, rallonges 125 mm-250 mm
80541	kniegewricht, cardan universeel
815A4315	L hendel 315 mm L





**FOR 4941-5**

1/4" - 1/2" Kombinatieset 94 delig 6 kant  
1/4" - 1/2" Jeu de douilles 94 pcs 6 pans

525 04...14	1/4" doppen 4-4,5-5,5-6-7-8-9-10-11-12-13-14 mm
52550 06...13	1/4" lange doppen 6-7-8-9-10-11-12-13 mm
32432 03...6	1/4" inbus 3-4-5-6 mm
32332 04...065	1/4" plat 4-5,5-6,5 mm
32132 1...2	1/4" PH 1-PH2
32232 1...2	1/4" PZ 1-PZ2
32632 08...30	1/4" TX T10-T15-T20-T25-T27-T30
764 ....	3 inbusseutel 1,5-2-2,5 mm
526 04...08	1/4" 5-E doppen E4-E5-E6-E7-E8
80222	1/4" ratel, cliquet 72t
8042 050...100	1/4"2 verlengstukken, rallonge 50-100 mm
80521	1/4"kniegewricht, cardan universeel 1/4"
8032115	wringstaaf, manche en T
8143	steekhecht, manche tournevis
546 10...32	1/2" doppen 10-11-12-13-14-15 16-17-18-19-20-21-22-24-27-30-32 mm
54677 14...22	1/2" lange doppen 14-15-17-19-22 mm
80242	1/2" ratel, cliquet 72t
8044 125...250	2 verlengstukken, rallonge 125 mm-250 mm
80634	1 adaptor 1/2" x 3/8"
80541	1 kniegewricht, cardan 1/2"
81045	1 bits adaptor 1/2"-5/16"
8074 16...20,6	2 bougiedoppen, douilles bougie 16-21 mm
15430 07...14	5/16" hex 7-8-10-12-14 (30mmL)
15630 40...60	5/16" TX T40-T45-T50-T55 (30mmL)
15330 08...12	5/16" plat 8-10-12 mm (30mmL)
15130 3...4	5/16" PH 3-PH4 (30mmL)
15230 3...4	5/16" PZ 3-PZ4 (30mmL)



**FOR 41082-5**

1/4" - 1/2" Kombinatieset 108 delig 6 kant  
1/4" - 1/2" Jeu de combinaison 108 pcs 6 pans

5270 04...14	1/4" doppen 4-4,5-5,5-6-7-8-9-10-11-12-13-14 mm
52750 06...13	1/4" lange doppen 6-7-8-9-10-11-12-13 mm
32432 03...6	1/4" inbus 3-4-5-6 mm
32332 04...065	1/4" plat 4-5,5-6,5 mm
32132 1...2	1/4" PH 1-PH2
32232 1...2	1/4" PZ 1-PZ2
32632 08...30	1/4" TX T10-T15-T20-T25-T27-T30
764 ....	3 inbusseutel 1,5-2-2,5 mm
526 04...08	1/4" 5-E doppen E4-E5-E6-E7-E8
80222	1/4" ratel, cliquet 72t
8042 050...100	1/4" 2 verlengstukken, rallonge 50-100 mm
80521	1/4"kniegewricht, cardan universeel 1/4"
8143	steekhecht, manche tournevis
547 10...32	1/2" doppen 10-11-12-13-14-15 16-17-18-19-20-21-22-24-27-30-32 mm
54777 14...22	1/2" 14-15-17-19-22 mm (77mmL)
546 10...24	1/2" E10-E11-E12-E14 - E16-E18-E20-E24
80242	1/2" ratel, cliquet 72t
8044 125...250	1/2" verlengstukken, rallonge 125 mm-250 mm
80634	1 adaptor 1/2"-3/8"
80541	1/2" kniegewricht, cardan universeel 1/2"
81045	1 bits adaptor 1/2"-5/16"
8074 16...20,6	1/2" 2 bougiedoppen, douilles pour bougie 16-21 mm
15430 07...14	5/16" hex 7-8-10-12-14
15630 40...60	5/16" TX T40-T45-T50-T55
15330 08...12	5/16" plat 8-10-12 mm
15130 3...4	5/16"PH 3-PH4
15230 3...4	5/16" PZ 3-PZ4



**FOR 4106S**

1/2" Doppenset op rail 6 kant 10 delig inch maten  
1/2" Jeu de douilles en pouce sur rail 6 pans 10 pcs

545 3.8...15.16	3/8" -7/16"-1/2"-9/16"-5/8"-11/16"-3/4"- 13/16"- 7/8"-15/16"
-----------------	--



**FOR T4194**

TC module met 19 inch doppen 6 kant 1/2"  
TC module 19 douilles en pouce 6 pans

545 5.16...1.1/4	5/16"-3/8"-7/16"-15/32"-1/2"-9/16"-19/32"-5/8"-11/16"- 3/4"-25/32"-13/16"-7/8"-15/16"-1"-1-1/16"-1-1/8"-1 3/16"-1-1/4"
------------------	--



**FOR T4248S**

TC module met 24 inch doppen 6 kant kort + lang 1/2"  
TC module 24 douilles et en pouce 6 pans

545 3.8...1.116	6k 3/8"-7/16"-1/2"-9/16"-5/8"-11/16"- 3/4"- 13/16" - 7/8" - 15/16" - 1" - 1 1/16"
54577 3.8...1.116	6k3/8"-7/16"-1/2"-9/16"-5/8"-11/16"- 3/4"- 13/16" - 7/8" - 15/16" - 1" - 1 1/16" (77mmL)



**FOR 4246S**

1/2" Doppenset 24 delig 6 kant inch  
1/2" Jeu de douilles 24 pcs 6 pans et en pouce

547 5/ 16" ... 1-1/4"	5/16"-3/8"-7/16"-1/2"-9/16"-19/32"-5/8"-11/16" 3/4"-25/32"-13/16"-7/8"-15/16"-1"-1-1/16"-1-1/8" 1-3/16"-1-1/4"
80243	ratel, cliquet
8034250	wringstaaf, poignée coulissante
8044125...250	2 verlengstukken 125 mm-250 mm
80541	kniegewricht, cardan universeel
807420.6	bougiedop 20.6 mm, douille pour bougie



**FOR 4111S**

1/2" Inbus kort op dop 10 delig inch  
1/2" Jeu de 10 douilles sur embout hexagonales

344055 5.32...1.2	5/32"-3/16"-7/32"-1/4"-5/16"-3/8"-1/2" (55 mm L)
344065 9.16...5.8	9/16"-5/8" (65 mm L)
344070 3.4	3/4" (70 mm L)





**FOR 4611-5**

1/4" - 1/2" Kombinatieset 60 delig 6 kant  
1/4" - 1/2" Jeu de combination 60 pcs 6 pans

525 04.....10	1/4" 4-5-5,5-6-7-8-9-10 mm
52550 08.....10	1/4" douilles longues 8-10 mm (50 mm L)
32432 04.....06	1/4" inbus dop bit 4-5-6 mm
32632 10.....30	1/4" torx T10-T20-T25-T30
32132 1.....2	1/4" philips PH1-PH2-PH3
32332 04.....07	1/4" plat 4-5,5 mm
80222	1/4" ratel, cliquet 1/4"
8042 050.....150	1/4" verlengstuk, rallonge 50-150 mm
80521	1/4" kniegewricht, cardan universel
8143	steekhecht, manche tournevis
764-4	4 allensleutels, clés allen 1,25-1,5-2,-2,5 mm
545 10.....32	1/2" 10-11-12-13-14-15-17-19-22-24-30-32 mm
54577 12.....17	1/2" lange doppen 12-13-17 mm (77mmL)
344100 07.....10	1/2" inbus dop bit 7-8-10 mm (100 mm L)
346055 40.....50	1/2" torx dop bit T40-T45-T50 (55 mm L)
341553	1/2" philips dop bit PH3
34305508	1/2" plat dop bit 8 mm
80242	1/2" ratel, cliquet 1/2"
8074 16..20,6	1/2" bougiedoppen 16-20,6 mm
808410	1/2" verlengstuk, rallonge 250 mm
8034250	wringstaaf, poignée coulissante



**FOR 41391**

1/4" - 1/2" Kombinatieset 139 delig 6 kant  
1/4" - 1/2" Jeu de combination 139 pcs 6 pans

525 04.....13	1/4" 4-5-6-7-8-9-10-11-12-13 mm doppen
80222	1/4" ratel, cliquet 1/4"
8042 050.....100	1/4" verlengstuk, rallonge 50-100 mm
80521	1/4" kniegewricht, cardan universel
8143	steekhecht, manche tournevis
8032115	wringstaaf 115mm
8111	flexibel verlengstuk 145mm
81022	bithouder 1/4" x 1/4"
545 10.....32	1/2" 10-11-12-13-14-15-16-17-18-19-20-21-22-23-24-27-30-32 mm
80243	1/2" ratel, cliquet 1/2"
8074 16..20,6	1/2" bougiedoppen 16-20,6 mm
8044 75...250	1/2" verlengstuk 75-250mmL, rallonge 75-250 mm
8014380	1/2" wringstaaf met kniegewricht
80521	1/2" kniegewricht
81045	adapter 1/2" x 5/16"
121300..2 - 122301..2	1/4" PH0-PH1-PH2 (30mmL) - PZ1-PZ2
151303..4 - 152303..4	5/16" PH3-PH4 (30mmL) - PZ3-PZ4
12330 04...065	1/4" 4-5,5-6,5mm (30mmL) plat
15330 08...12	5/16" 8-10-12mm (30mmL) plat
12430 03...08	1/4" 3-4-5-6-8mm (30mmL) inbus-hex
15430 04...12	5/16" 4-5-6-7-8-10-12mm (70mmL) inbus-hex
12630 08...30	1/4" T8-T10-T15-T20-T25-T27-T30 (30mmL) torx
15630 40...55	5/16" T40-T45-T50-T55 (30mmL)
60219200-60225220	beitels 19mm-25mm
604...	pendrijvers 2-3-4-5
6064185	doorslag 4 (185mmL)
611B175	kombinatietang 175mm - pince universelle
613B250	waterpomptang - pince multiprice 250mm
616300	hamer - marteau 300gr
6806	kabelschoentang + terminal pack
7112S - 7112	PH2 (25mmL) - PH 2 (100mmL)
713065S - 713065	plat 6,5mm (25mmL) 6,5mm (150mmL)
steekringsleutels	6-7-8-9-10-11-12-13-14-15-16-17-19-22-24-27mm



**FOR 4111**

1/2" Inbus kort op dop 10 delig  
1/2" Jeu de 10 douilles sur embout hexagonales

344055 04...12	4-5-6-7-8-10-12 mm (55 mm L)
34406514	14 mm (65 mm L)
344070 17...19	17-19 mm (70 mm L)



**FOR 40715**



1/2" Inbus kort op dop op rail 7 delig  
1/2" Jeu de 7 douilles sur embout hexagonales sur rail

344055 05...12	5-6-7-8-10-12 mm (55 mm L)
34406514	14 mm (65 mm L)



**FOR 4092**

1/2" Inbus lang op dop 8 delig  
1/2" Jeu de 8 douilles sur embout hex longues

344110 05...17	5-6-7-8-10-12-14-17 (110 mm L)
----------------	--------------------------------



**FOR 40715L**



1/2" Inbus lang op dop 7 delig op rail  
1/2" Jeu de 7 douilles sur embout hex longues sur rail

344110 05...14	5-6-7-8-10-12-14 (110 mm L)
----------------	-----------------------------



**FOR T41710**



TC module 1/2" inbusdoppenset 17 delig  
TC module 17 douilles hexagonales 1/2"

344055 05...19	5-6-7-8-9-10-12-14-17-19 mm (55 mm L)
344100 05...14	5-6-7-8-10-11-12-13-14 mm (100 mm L)
34411017	17 mm (110 mm L)

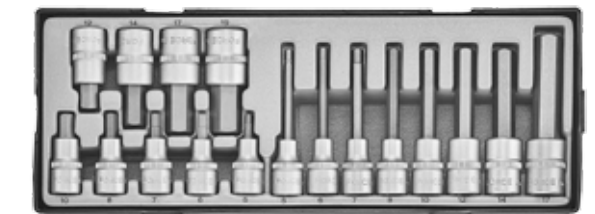

**FOR 4206**

1/2" Inbusdoppenset 20 delig in pvc koffer  
1/2" Jeu de douilles hexagonales 20 pcs

344055 05...19	5-6-7-8-9-10-12-14-17-19 mm (55 mm L)
344100 05...14	5-6-7-8-10-11-12-13-14 mm (100 mm L)
34411017	17 mm (110 mm L)





**FOR 40717**



1/2" Torx doppenset 7delig  
1/2" Jeu de 7 douilles torx

346055 30...70	T30-T40-T45-T50-T 55-T60-T70 (55mmL)
----------------	--------------------------------------



**FOR 4172**

1/2" Torx doppenset 16 delig inwendig-uitwendig  
1/2" Jeu de 16 douilles torx



546 10...20	E10-E11-E12-E14-E16-E18-E20-E22-E24
346055 40...70	T40-T45-T47-T50-T 55-T60-T70



**FOR 4192**

3/8" - 1/2" Torx doppenset 18 delig inwendig-uitwendig  
3/8" - 1/2" Jeu de 18 douilles torx



536 10...18	3/8" E10-E11-E12-E14-E16-E18
546 20...24	1/2" E20-E22-E24
336050 20...40	3/8" T20-T25-T27-T30-T40 (50 mm L)
346055 45...55	1/2" T45-T50-T55 (55 mm L)



**FOR 4093**

1/2" Torx doppenset 9 delig inwendig  
1/2" Jeu de 9 douilles torx

546 10...24	E10-E11-E12-E14-E16-E18-E20-E22-E24
-------------	-------------------------------------



**FOR 4042**

1/2" Torx dop bitset 4 delig op rail  
1/2" Jeu de 4 douilles torx sur rail



346100 40...70	T40-T45-T55-T70 (100 mm L)
----------------	----------------------------



**FOR 4068**

1/2" Resistorx dop bitset 6 delig  
1/2" Jeu de 6 douilles resistorx



347 100 20...50	T20H-T25H-T30H-T40H-T45H-T50H (100 mm L)
-----------------	--



**FOR 4263**

1/2" Torx doppenset 20 delig in pvc koffer  
1/2" Jeu de douilles torx 20 pcs



346055 20...70	T20-T25-T27-T30-T35-T40-T45-T47-T50-T55-T60-T70 (55 mm L)
346100 20...100	T20-T25-T27-T30-T40-T45-T50-T55-T60-T70-T80-T90-T100 (100 mm L)
34614060	T60 (140 mm L)



**FOR T4165**



TC module 1/2" Torx doppenset 16 delig  
TC module 16 douilles torx 1/2"



346055 27...70	T27-T30-T40-T45-T50-T55-T60-T70 (55 mm L)
346100 27...70	T27-T30-T40-T45-T50-T55-T60-T70 (100 mm L)



**FOR T4413**

TC module assortiment torx 41 delig  
TC module 41 assortiment torx



76610...70	Torx sleutel T10 tot T70
32632 08...40	1/4" Torx dop bit
	T8-T9-T10-T15-T20-T25-T27-T30-T40
33650 45...50	3/8" Torx dop bit T45-T50 (50 mm L)
34614055	1/2" Torx dop T55 (140 mm L)
34610060	1/2" Torx dop T60 (100 mm L)
34610070	1/2" Torx dop T70 (100 mm L)
526 04.10	1/4" Torx dop E4-E5-E6-E7-E8-E10
536 10.20	3/8" Torx dop E10-E11-E12-E14-E16-E18-E20
546 22.24	1/2" Torx dop E22-E24



**FOR T4322**

TC Module met 32 torx + XZN assortiment 1/2"  
TC Module 32 douilles torx + XZN 1/2"



546 10...24	E10-E11-E12-E14-E16-E18-E20-E24
54677 10...24	E10-E11-E12-E14-E16-E18-E20-E24 torx (77mmL)
346055 50...70	T50-T55-T60-T70 (55mmL)
347055 50...70	T50H-T55H-T60H-T70H resistorx (55mmL)
348055 08...16	M5-M6-M8-M10-M12-M14-M16 XZN (55mmL)



**FOR T4122**

TC Module met 12 torx + inbus assortiment 1/2"  
TC Module 12 douilles torx + hex 1/2"



34418005	5mm (180mmL)
344100 06...08	6-7-8mm (100mmL)
346120 40...45	T40-T45 (120mmL)
346140 55...70	T55-T70 (140mmL)
348100 06...12	M6-M8-M10-M12 XZN (100mmL)



**FOR T4116**

TC Module met 11 torx + XZN + inbus assortiment 1/2"  
TC Module 11 douilles torx + XZN + hex 1/2"

34418005..06	inbus 5mm (180mmL)
	inbus 6mm (160mmL) 7mm (100mmL)
	inbus 8mm (120mmL) 10mm (140mmL)
346140 40...45	T40-T45 (140mmL)
34610070	T70 (100mmL)
348100 08...10	M8-M10 XZN (100mmL)
34814012	M12 XZN (140mmL)

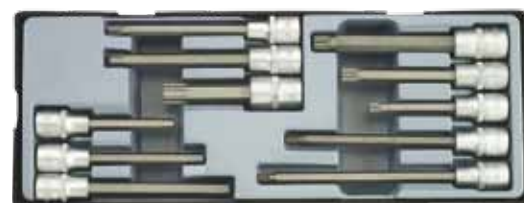

**FOR T4281**

TC Module met 28 torx + XZN + inbus assortiment 1/2"  
TC Module 28 douilles torx + XZN + hex 1/2"

344055 04..12	inbus 4-5-6-7-8-10-12mm (55mmL)
34406514	inbus 14mm (65mmL)
34407017	inbus 17mm (70mmL)
34408008	inbus 8mm (80mmL)
34414010	inbus 10mm (140mmL)
348055 05...16	M5-M6-M8-M10-M12-M14-M16 XZN (55mmL)
348110 10..12	M10-M12 XZN (110mmL)
34812005	M8 XZN (120mmL)
33405040 04..10	3/8" inbus dop 4-5-6-7-8-10mm (50mmL)



**FOR T4355**

TC Module met 35 torx + XZN + inbus assortiment 1/2"  
TC Module 35 douilles torx + XZN + hex 1/2"

344055 05..12	inbus 5-6-7-8-10-12mm (55mmL)
34406514	inbus 14mm (65mmL)
34407017...19	inbus 17mm-19mm (70mmL)
346055 27...70	torx T27-T30-T40-T45-T50-T55-T60-T70 (55mmL)
348055 05...16	M5-M6-M8-M10-M12-M14-M16 XZN (55mmL)
54610...24	E10-E11-E12-E14-E16-E18-E20-E22-E24
34805516T	M16 XZN (55mmL)



**FOR 40716**

1/2" XZN dop-bitset 7 delig op rail  
1/2" Jeu de 7 douilles XZN sur rail



348055 05...14	M5-M6-M8-M9-M10-M12-M14 XZN (55 mm L)
----------------	---------------------------------------



**FOR 40811**

1/2" XZN dop-bitset 8 delig  
1/2" Jeu de 8 douilles XZN

348055 05...16	M5-M6-M8-M9-M10-M12-M14-M16 XZN (55 mm L)
----------------	---



**FOR 40716L**



1/2" Dop bit set XZN 7 delig  
1/2" Jeu de 7 douilles XZN

348100 05...14	M5-M6-M8-M9-M10-M12-M14 (100 mm L)
----------------	------------------------------------



**FOR 4061**

1/2" Dop bit set XZN 6 delig  
1/2" Jeu de 6 douilles XZN

348055 06...10	M6-M8-M10 (55 mm L)
348100 08...12	M8-M10-M12 (100 mm L)



**FOR T4179**



TC Module 1/2" Dop bit set XZN 17 delig  
TC module 17 douilles XZN

348055 05...10	M5-M6-M8-M9-M10-M12-M14-M16 (55 mm L)
348100 08...12	M5-M6-M8-M9-M10-M12-M14-M16 (100 mm L)
34805516t	M16(55mmL)



**FOR 4285**

1/2" XZN doppenet 28 delig in pvc koffer  
1/2" Jeu de 28 douilles XZN

348055 05...16	M5-M6-M8-M9-M10-M12-M14-M16 (55 mm L)
348100 05...18	M5-M6-M8-M9-M9.5-M10-M12-M14-M16-M18 (100 mm L)
348140 08...14	M8-M9-M10-M12-M14 (140mmL)
348055 14T...16T	M14-M16 (55 mm L) veiligheidsbit
34810016T	M16 (100mmL) veiligheidsbit
678	M10 alternator tools M10 (110mmL)



**FOR 4266**

1/2" Special doppenet 26 delig in pvc koffer  
1/2" Jeu de douilles special 26 pcs

34410011-13	inbus 11-13 mm (100mmL)	34814008...12	XZN M8-M9-M10-M12 (140 mm L)
34414010	inbus 10mm (140mmL)	34805516T	XZN M16 (55mmL) veiligheidsbit
34610060-70	Torx T60-T70 (100mmL)	34810016T	XZN M16 (100 mm L)
34614060	Torx T60 (140mmL)	34910013	Ribe M13 (100 mm L)
34710055	Resistorx T55 (100 mmL)	34912012	Ribe M12 (120 mm L)
34710570	Resistorx T70 (105mmL)	34914009	Ribe M9 (140 mm L)
34713030	Resistorx T30 (130mmL)	34914010	Ribe M10 (140 mm L)
34714080	Resistorx T80 (140mm L)	674	M10 alternator tools
34810014	XZN 14 (100mmL)	678	T50 x 110 mm L
34812009	XZN 9 (120mmL)		



**FOR 40915**



1/2" Dop bit set ribe 9 delig  
1/2" Jeu de 9 douilles ribe

349 100 05...14	M5-M6-M7-M8-M9-M10-M12-M13-M14 (100 mm L)
-----------------	---







Art.nr	mm	L mm
FOR 5457708	8 mm	77
FOR 5457709	9 mm	77
FOR 5457710	10 mm	77
FOR 5457711	11 mm	77
FOR 5457712	12 mm	77
FOR 5457713	13 mm	77
FOR 5457714	14 mm	77
FOR 5457715	15 mm	77
FOR 5457716	16 mm	77
FOR 5457717	17 mm	77
FOR 5457718	18 mm	77
FOR 5457719	19 mm	77
FOR 5457720	20 mm	77
FOR 5457721	21 mm	77
FOR 5457722	22 mm	77
FOR 5457723	23 mm	77
FOR 5457724	24 mm	77
FOR 5457725	25 mm	77
FOR 5457726	26 mm	77
FOR 5457727	27 mm	77
FOR 5457728	28 mm	77
FOR 5457729	29 mm	77
FOR 5457730	30 mm	77
FOR 5457732	32 mm	77



**Lange doppen 6 kant 1/2"**  
**Douilles longues 6 pans 1/2"**



Art.nr	mm	L mm
FOR 54608	E8	38
FOR 54610	E10	38
FOR 54611	E11	38
FOR 54612	E12	38
FOR 54614	E14	38
FOR 54616	E16	38
FOR 54618	E18	38
FOR 54620	E20	38
FOR 54622	E22	38
FOR 54624	E24	40



**Torx doppen inwendig 1/2"**  
**Douilles torx 1/2"**



Art.nr	mm	L mm
FOR 5467710	E10	77
FOR 5467711	E11	77
FOR 5467712	E12	77
FOR 5467714	E14	77
FOR 5467716	E16	77
FOR 5467718	E18	77
FOR 5467720	E20	77
FOR 5467724	E24	77



**Lange torx doppen inwendig 1/2"**  
**Douilles torx longues 1/2"**



Art.nr	mm	L mm
FOR 5497708	8 mm	77
FOR 5497709	9 mm	77
FOR 5497710	10 mm	77
FOR 5497711	11 mm	77
FOR 5497712	12 mm	77
FOR 5497713	13 mm	77
FOR 5497714	14 mm	77
FOR 5497715	15 mm	77
FOR 5497716	16 mm	77
FOR 5497717	17 mm	77
FOR 5497718	18 mm	77
FOR 5497719	19 mm	77
FOR 5497720	20 mm	77
FOR 5497721	21 mm	77
FOR 5497722	22 mm	77
FOR 5497723	23 mm	77
FOR 5497724	24 mm	77
FOR 5497725	25 mm	77
FOR 5497726	26 mm	77
FOR 5497727	27 mm	77
FOR 5497728	28 mm	77
FOR 5497729	29 mm	77
FOR 5497730	30 mm	77
FOR 5497732	32 mm	77



**Lange doppen 12 kant 1/2"**  
**Douilles longues 12 pans 1/2"**



Art.nr	mm	L mm
FOR 34605520	T20	55
FOR 34605525	T25	55
FOR 34605527	T27	55
FOR 34605530	T30	55
FOR 34605535	T35	55
FOR 34605540	T40	55
FOR 34605545	T45	55
FOR 34605547	T47	55
FOR 34605550	T50	55
FOR 34605555	T55	55
FOR 34605560	T60	55
FOR 34605570	T70	55
FOR 34607080	T80	70
FOR 34610020	T20	100
FOR 34610025	T25	100
FOR 34610027	T27	100
FOR 34610030	T30	100
FOR 34610040	T40	100
FOR 34610045	T45	100
FOR 34610050	T50	100
FOR 34610055	T55	100
FOR 34610060	T60	100
FOR 34610070	T70	100
FOR 346100100	T100	100
FOR 34612040	T40	120
FOR 34612045	T45	120
FOR 34614045	T45	140
FOR 34614050	T50	140
FOR 34614055	T55	140
FOR 34614060	T60	140
FOR 34614070	T70	140
FOR 346140100	T100	140



**Torx doppen 1/2"**  
**Douilles torx 1/2"**





Art.nr	mm	L mm
FOR 34705520	T20H	55
FOR 34705527	T27H	55
FOR 34705530	T30H	55
FOR 34705540	T40H	55
FOR 34705545	T45H	55
FOR 34705550	T50H	55
FOR 34705555	T55H	55
FOR 34705560	T60H	55
FOR 34705570	T70H	55
FOR 34707080	T80H	70
FOR 34710030	T30H	100
FOR 34710040	T40H	100
FOR 34710045	T45H	100
FOR 34710050	T50H	100
FOR 34710055	T55H	100
FOR 34710060	T60H	100
FOR 347100100	T100H	100
FOR 34713030	T30H	130
FOR 34714050	T50	140



**Resistorx doppen 1/2"**  
**Douilles Resistorx 1/2"**



Art.nr	mm	L mm
FOR 34805505	M5	55
FOR 34805506	M6	55
FOR 34805508	M8	55
FOR 34805509	M9	55
FOR 34805510	M10	55
FOR 34805512	M12	55
FOR 34805514	M14	55
FOR 34805516	M16	55
FOR 34810005	M5	100
FOR 34810006	M6	100
FOR 34810008	M8	100
FOR 34810009	M9	100
FOR 34810010	M10	100
FOR 34810012	M12	100
FOR 34810014	M14	100
FOR 34810016	M16	100
FOR 34810018	M18	100
FOR 34812008	M8	120
FOR 34812010	M10	120
FOR 34814008	M8	140
FOR 34814010	M10	140
FOR 34814012	M12	140
FOR 34814014	M14	140
FOR 34880008	M8	800
FOR 34880010	M10	800



**XZN doppen 1/2"**  
**Douilles XZN 1/2"**



Extra lange Spline dopsleutel voor montage van aandrijfasschroeven vanaf de buitenzijde door de wielkast bij VW en Audi. Spaart kostbare tijd en geen zware verlengstukken meer nodig.

**XZN doppen magnetisch 1/2"**  
**Douilles XZN magnetique 1/2"**

Art.nr	mm	L mm
FOR 34805514T	M14	55
FOR 34805516T	M16	55
FOR 34810016T	M16	100



Art.nr	mm	L mm
FOR 34405504	4	55
FOR 34405505	5	55
FOR 34405506	6	55
FOR 34405507	7	55
FOR 34405508	8	55
FOR 34405509	9	55
FOR 34405510	10	55
FOR 34405512	12	55
FOR 34406514	14	65
FOR 34407017	17	70
FOR 34407019	19	70
FOR 34410005	5	100
FOR 34410006	6	100
FOR 34410007	7	100
FOR 34410008	8	100
FOR 34410009	9	100
FOR 34410010	10	100
FOR 34410011	11	100
FOR 34410012	12	100
FOR 34411005	5	110
FOR 34411006	6	110
FOR 34411007	7	110
FOR 34411008	8	110
FOR 34411010	10	110
FOR 34411012	12	110
FOR 34411014	14	110
FOR 34411017	17	110
FOR 34411019	19	110
FOR 34412008	8	120
FOR 34414006	6	140
FOR 34414008	8	140
FOR 34414010	10	140
FOR 34416006	6	160
FOR 34418005	5	180
FOR 34422006	6	220



**Inbus doppen 1/2"**  
**Douilles hexagonales 1/2"**



Art.nr	mm	L mm
FOR 34910005	M5	100
FOR 34910006	M6	100
FOR 34910007	M7	100
FOR 34910008	M8	100
FOR 34910009	M9	100
FOR 34910010	M10	100
FOR 34910012	M12	100
FOR 34910013	M13	100
FOR 34910014	M14	100
FOR 34910016	M16	100



### Ribe doppen 1/2" Douilles Ribe 1/2"



Art.nr	mm	L mm
FOR 807416	16	63
FOR 807418	18	63
FOR 807420.6	20.6	63
FOR 807416M	16	70
FOR 807418M	18	70
FOR 807420.6M	20.6	70

### Bougiedop 6 kant 1/2" Douilles pour bougies 1/2"



M - magnetisch  
M = magnétique

Art.nr	L mm
FOR 819409	260

### Rail voor 9 doppen 1/2" Rail pour 9 douilles 1/2"



### FOR 4049

1/2" Verlengstukken 4 delig  
1/2" Jeu de 4 rallonges

8044 75...250	75mmL-125mmL-150mmL-250mmL
---------------	----------------------------



### Verloopstuk 1/2" Adaptateur 1/2"



Art.nr	mm	L mm
FOR 80943	1/2" x 3/8"	46
FOR 80946	1/2" x 3/4"	46
FOR 80634	3/8" x 1/2"	46

### Kniegewricht 1/2" Cardan universel 1/2"



Art.nr	L mm
FOR 80541	70

### Wringstaaf met schuifstuk 1/2" Poignée coulissante 1/2"



Art.nr	L mm
FOR 8034250	250
FOR 803A4300	300

### Verlengstuk met kniegewricht 1/2" Rallonges à cardan 1/2"

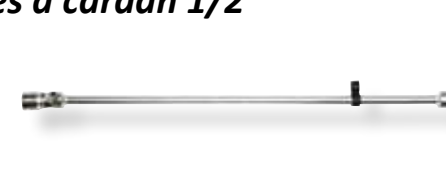

Art.nr	L mm
FOR 784418U	500
FOR 784419U	500

### Adapter Porte-embouts



Art.nr	mm	L mm
FOR 81042	1/2" x 1/4"	38
FOR 81045	1/2" x 5/16"	38
FOR 81047	1/2" x 10 mm	38
FOR 810414	1/2" x 14 mm	38

### Verlengstuk 1/2" Rallonges 1/2"



Art.nr	L mm
FOR 8044050	50
FOR 8044075	75
FOR 8044125	125
FOR 8044250	250
FOR 8044500	500

### Wringstaaf met kniegewricht 1/2" Poignée articulée 1/2"



Art.nr	L mm
FOR 8014380	380
FOR 8014380P	herstelkit kit rep.

### Wringstaaf met kniegewricht 1/2" Poignée articulée 1/2"



Art.nr	L mm
FOR 8014600	600
FOR 8014600P	repair set kit rep.



**Ratel met ronde kop 1/2"**  
**Cliquet 1/2"**



Art.nr	tanden	L mm
FOR 80249	72	270
FOR 80249P	herstelkit	kit rep.

**Ratel met ronde kop 1/2"**  
**Cliquet 1/2"**



Art.nr	tanden	L mm
FOR 802422	72	267
FOR 802422P	herstelkit	kit rep.

**Ratel met kniegewricht 1/2"**  
**Cliquet flexible 1/2"**



Art.nr	tanden	L mm
FOR 802418	36	306
FOR 802418P	herstelkit	

**L hendel 1/2"**  
**Manche "L" 1/2"**



Art.nr	L mm
FOR 815A4315	315

**Ratel 1/2"**  
**Cliquet 1/2"**



Art.nr	L mm
FOR 802433	330

**Ratel knikbaar 1/2"**  
**Cliquet flexible 1/2"**



Art.nr	tanden	L mm
FOR 802423	72	312
FOR 802423P	herstelkit	kit rep.

**Ratel 1/2"**  
**Cliquet 1/2"**



Art.nr	tanden	L mm
FOR 80242	24	275
FOR 80243	24	2
FOR 80242P	herstelkit	kit rep.
FOR 80243P	herstelkit	kit rep.

**Ratel 1/2"**  
**Cliquet 1/2"**



Art.nr	tanden	L mm
FOR 802415	36	255
FOR 802415P	kit rep.	
FOR 80248	72	265
FOR 80248P	kit rep.	

**Aanpasbare hendel 1/2"**  
**Poignée 1/2"**



Art.nr	L mm
FOR 8334300	310

**Ratel 1/2" + aanpasbare hendel**  
**Cliquet 1/2" + poignée**



Art.nr	Normal	L mm
FOR 802434	435 mm	680 mm

**FOR 6201 5**

3/4" Doppenset 20 delig 6 kant in metalen koffer  
3/4" Coffret de 20 pcs douilles 6 pans mm

565 19...50	19-21-22-23-24-26-27-29-30-32-35-36-38-41-46-50
8026500	1 ratel, cliquet 500 mm L
8036450	1 wringstaaf, manche en T 450 mm L
8046100	verlengstuk, rallonge 100 mm
8046200	verlengstuk, rallonge 200 mm

**FOR 6201**

3/4" Doppenset 20 delig 12 kant in metalen koffer  
3/4" Jeu de douilles 20 pcs 12 pans

5695 19...50	19-21-22-23-24-26-27-29-30-32-35-36-38-41-46-50 mm
idem als 6201 5	

**FOR F6213 (10217-10218)**

Doppenset 3/4" 6 kant - 21 delig foam  
Module mousse 21 outils 6 pans 3/4"

565 19...50	19-21-22-23-24-26-27-29-30-32-35-36-38-41-46-50
8046100	verlengstuk, rallonge 100 mm
8046200	verlengstuk, rallonge 200 mm
8026500	ratel, cliquet 500 mm
80968	adapter, adaptateur

**FOR F6342 - Jumbo (10318)**

Kombinatieset 3/4" 34 delig 12 kant FOAM  
Module mousse 34 outils 3/4" 12 pans

364080 14...22	3/4" Inbus dop 14-16-17-19-22mm (80mmL)
366080 60...100	3/4" Torx dop T60-T70-T80-T90-T100 (80mmL)
569 17...50	3/4" 17-19-21-22-23-24-27-30-32-33-34-35-36-38-41-46-50mm
8026500	3/4" Ratel, cliquet
8036500	3/4" Wringstaaf met schuifstuk 500mmL, poignée
8046200	3/4" Verlengstuk 200mmL - rallonge
8046400	3/4" Verlengstuk 400mmL - rallonge
80946	Adapter 1/2" x 3/4"
80986	Adapter 1" x 3/4"
8156450	L hendel 450mmL



Art.nr	mm	L mm
FOR 56519	19	50
FOR 56521	21	50
FOR 56522	22	50
FOR 56523	23	50
FOR 56524	24	51
FOR 56526	26	52
FOR 56527	27	52
FOR 56528	28	52
FOR 56529	29	52
FOR 56530	30	54
FOR 56532	32	56
FOR 56533	33	56
FOR 56534	34	56
FOR 56535	35	58
FOR 56536	36	58
FOR 56538	38	60
FOR 56540	40	62
FOR 56541	41	64
FOR 56546	46	68
FOR 56550	50	72
FOR 56555	55	76
FOR 56560	60	78

### Doppen 6 kant 3/4" Douilles 6 pans 3/4"



Art.nr	mm	L mm
FOR 56919	19	50
FOR 56921	21	50
FOR 56922	22	50
FOR 56923	23	50
FOR 56924	24	51
FOR 56926	26	52
FOR 56927	27	52
FOR 56928	28	52
FOR 56929	29	52
FOR 56930	30	54
FOR 56932	32	56
FOR 56933	33	56
FOR 56934	34	56
FOR 56935	35	58
FOR 56936	36	58
FOR 56938	38	60
FOR 56941	41	64
FOR 56946	46	68
FOR 56950	50	72
FOR 56955	55	76
FOR 56960	60	78
FOR 56965	65	82

### Doppen 12 kant 3/4" Douilles 12 pans 3/4"



Art.nr	mm	L mm
FOR 36408017	17	80
FOR 36408019	19	80

### Doppen inbus 3/4" Douilles hex 3/4"



Art.nr	L mm	gewicht/poids
FOR 8046100	100	417gr
FOR 8046200	200	740gr
FOR 8046400	400	1358gr

### Verlengstuk 3/4" Rallonge 3/4"



Art.nr	L mm	gewicht/poids
FOR 8036450	450	1388gr
FOR 8036500	500	1514gr

### Wringstaaf 3/4" Poignée coulisante 3/4"



Art.nr	L mm	gewicht/poids
FOR 8016475	475 mm	1900gr
FOR 80161000	1000 mm	3670gr

### Wringstaaf met kniegewricht 3/4" Poignée articulée 3/4"



Art.nr	L mm	gewicht/poids
FOR 8026500	500	1970gr

### Ratel 3/4" - cliquet



Art.nr		L mm
FOR 80964	3/4" x 1/2"	58
FOR 80968	3/4" x 1"	68

### Verloopstuk 3/4" Adaptateur 3/4"



Art.nr	L mm	gewicht/poids
FOR 80561	109	625gr

### Kniegewricht 3/4" cardan universel 3/4"





**FOR 8141**

1" Doppenset 14 delig 12 kant in metalen koffer  
1"Jeu de douilles 14 pcs 12 pans



589 36...80	36-41-46-50-55-60-65-70-75-80 mm
8028650	1 ratel, cliquet 650 mm L
8038550	1 wringstaaf, poignée coulissante 550 mm L
8048200	verlengstuk, rallonge 200 mm
8048400	verlengstuk, rallonge 400 mm

Art.nr	mm	L mm
FOR 58936	36	65
FOR 58941	41	70
FOR 58946	46	75
FOR 58950	50	75
FOR 58955	55	80
FOR 58960	60	84
FOR 58965	65	87
FOR 58970	70	93
FOR 58975	75	97
FOR 58980	80	103
FOR 58985	85	103
FOR 58985	85	106

**Doppen 12 kant 1"**  
**Douilles 12 pans 1"**



Art.nr	L mm	gewicht/poids
FOR 8048200	200	1330gr
FOR 8048400	400	2290gr

**Verlengstuk 1"**  
**Rallonges 1"**



Art.nr	L mm	gewicht/poids
FOR 8038550	550	3288gr

**Wringstaaf 1"**  
**Poignée coulissante 1"**



Art.nr	L mm	gewicht/poids
FOR 8018650	650	4122gr
FOR 80181000	1000	3785gr

**Wringstaaf met kniegewricht 1"**  
**Poignée articulée 1"**



Art.nr	L mm	gewicht/poids
FOR 8028650	650	4424gr

**Ratel 1" - cliquet 24 t**



Art.nr	mm	L mm
FOR 80986	1" x 3/4"	74

**Verloopstuk 1"**  
**Adaptateur 1"**



Art.nr	L mm	gewicht/poids
FOR 80581	143	1237gr

**Kniegewricht 1"**  
**Cardan universel 1"**





**FORCE**  
I M P A C T T O O L S

	Slagdoppen - Douilles à choc 1/2"	139
	Lange slagdoppen - Douilles à choc longues 1/2"	138
	Torx - inbus slagdoppen - douilles à choc torx - hex	140
	Lange slagdoppen voor alu velgen	142
	Adapters - Adaptateurs	143
	Slagdoppensets - Jeu de douilles à choc 3/4"	138
	Slagdoppen - Douilles à choc 3/4"	145
	Slagdoppensets - Jeu de douilles à choc 1"	148
	Slagdoppen - Douilles à choc 1"	148
	Slagdop - Douille à choc 1 1/2"	149
	Accessoires	150

**FOR T4193**

TC module 19 slagdoppen 6 kant 1/2"  
TC module 19 douilles à choc 6 pans 1/2"

445 10...32	10-11-12-13-14-15-16-17-18-19-21-22-23-24-26-27-30-32 mm
8044125MPB	verlengstuk, rallonge 125 mm



Art.nr	mm	L mm
FOR 44508	8 mm	38
FOR 44509	9 mm	38
FOR 44510	10 mm	38
FOR 44511	11 mm	38
FOR 44512	12 mm	38
FOR 44513	13 mm	38
FOR 44514	14 mm	38
FOR 44515	15 mm	38
FOR 44516	16 mm	38
FOR 44517	17 mm	38
FOR 44518	18 mm	38
FOR 44519	19 mm	38
FOR 44520	20 mm	38
FOR 44521	21 mm	38
FOR 44522	22 mm	43
FOR 44523	23 mm	43
FOR 44524	24 mm	43
FOR 44525	25 mm	43
FOR 44526	26 mm	43
FOR 44527	27 mm	43
FOR 44528	28 mm	45
FOR 44529	29 mm	45
FOR 44530	30 mm	45
FOR 44531	31 mm	45
FOR 44532	32 mm	45
FOR 44536	36 mm	45

Art.nr	mm	L mm
FOR 44819	19	38
FOR 44824	24	43

Art.nr	mm	L mm
FOR 8043075MPP	3/8"	75
FOR 8043150MPP	3/8"	150
FOR 8044125MPP	1/2"	125
FOR 8044125MPB	1/2"	125
FOR 8044250MPP	1/2"	250

**Slagdoppen 6 kant 1/2"**  
**Douilles à choc 6 pans 1/2"**



**Slagdoppen 12 kant 1/2"**  
**Douilles à choc 12 pans 1/2"**

**Verlengstukken**  
**Rallonges**



MPP = pin type  
MPB = ball type





**FOR 4107**

1/2" Lange slagdoppenset 6k 10 delig  
Jeu de 10 douilles à choc longues 6 pans



44585 11...24	11-12-13-14-16-17-19-21-22-24 mm
---------------	----------------------------------

**FOR T4119**

TC module 11 lange slagdoppen 6 kant 1/2"  
TC module 11 douilles à choc longues 6 pans 1/2"



44585 12...32	12-14-17-19-21-22-23-24-27-30-32 mm
---------------	-------------------------------------

**FOR T40813**

TC module 11 lange slagdoppen 12 kant 1/2"  
TC module 11 douilles à choc longues 12 pans 1/2"



44885 19...41	19-22-24-27-30-32-36-41 mm
---------------	----------------------------

Art.nr	mm	L mm
FOR 4458508	8 mm	85
FOR 4458509	9 mm	85
FOR 4458510	10 mm	85
FOR 4458511	11 mm	85
FOR 4458512	12 mm	85
FOR 4458513	13 mm	85
FOR 4458514	14 mm	85
FOR 4458515	15 mm	85
FOR 4458516	16 mm	85
FOR 4458517	17 mm	85
FOR 4458518	18 mm	85
FOR 4458519	19 mm	85
FOR 4458520	20 mm	85
FOR 4458521	21 mm	85
FOR 4458522	22 mm	85
FOR 4458523	23 mm	85
FOR 4458524	24 mm	85
FOR 4458525	25 mm	85
FOR 4458527	27 mm	85
FOR 4458528	28 mm	85
FOR 4458529	29 mm	85
FOR 4458530	30 mm	85
FOR 4458531	31 mm	85
FOR 4458532	32 mm	85
FOR 4458533	33 mm	85
FOR 4458534	34 mm	85
FOR 4458535	35 mm	85
FOR 4458536	36 mm	85

Art.nr	mm	L mm
FOR 4488524	24mm	85
FOR 4488532	32 mm	85
FOR 4488534	34 mm	85
FOR 4488536	36 mm	85
FOR 4488541	41 mm	85

Lange slagdoppen 6 kant 1/2"  
Douilles à choc longues 6 pans 1/2"



Lange slagdoppen 12 kant 1/2"  
Douilles à choc longues 12 pans 1/2"



**FOR 41012**

1/2" Inbus slagdoppenset 10 delig  
Douilles à choc hexagonales 10 pcs 1/2"

244060 04...19	4-5-6-7-8-10-12-14-17-19 mm (60 mm L)
----------------	---------------------------------------



**FOR 41013**

1/2" Torx slagdoppenset 10 delig  
Douilles à choc torx 10 pcs 1/2"

2460 60 20...70	T20-T25-T27-T30-T40-T45-T50-T55-T60-T70
-----------------	---



**FOR 40713**



1/2" XZN slagdoppenset 7 delig  
Douilles à choc XZN 7 pcs 1/2"

2480 60 08...12	M8-M10-M12 (60mmL)
248060 12...18	M12-M14-M16-M18 (78mmL)



**FOR T4205**

TC module 1/2" Torx- inbus slagdoppenset 20 delig  
TC module 20 douilles à choc T orx- hex 1/2"

2460 60 20...70	T20-T25-T27-T30-T40-T45-T50-T55-T60-T70
2440 60 04...19	4-5-6-7-8-10-12-14-17-19 mm



**FOR 4256**

1/2" Torx- XZN slagdoppenset 25 delig  
25 douilles à choc Torx- XZN 1/2"

2460 60 30...70	T30-T40-T45-T50-T55-T60-T70 (60mmL)
2480 60 08...12	M8-M10-M12 XZN (60mmL)
2480 78 14...18	M14-M16-M18 XZN (78mmL)
446 06...24	E6-E7-E8-E10-E11-E12-E14-E16-E18-E20-E22-E24



**FOR 4117**

1/2" Inwendige torx slagdoppenset 11 delig  
Douilles à choc torx 10 pcs 1/2"

446 06...24	E6-E7-E8-E10-E12-E14-E16-E18-E20-E22-E24
-------------	--



**FOR 4267**



1/2" Inbus - torx- XZN slagdoppenset 26 delig  
26 Douilles à choc torx- hex - XZN 1/2"

2460 60 30...70	T20-T25-T27-T30-T40-T45-T50-T55-T60-T70 (60mmL)
2480 60 08...12	M8-M10-M12 XZN (60mmL)
2480 78 14...18	M14-M16-M18 XZN (78mmL)
2440 60 04...19	4-5-6-7-8-10-12-14-17-19mm



**Slagdoppen inbus 1/2"**  
**Douilles à choc hexagonales 1/2"**



Art.nr	mm	L mm
24406004	4	60
24406005	5	60
24406006	6	60
24406007	7	60
24406008	8	60
24406010	10	60
24406012	12	60
24406014	14	60
24406017	17	60
24406019	19	60

**Slagdoppen torx 1/2"**  
**Douilles à choc torx 1/2"**



Art.nr	mm	L mm
24606020	T20	60
24606025	T25	60
24606027	T27	60
24606030	T30	60
24606040	T40	60
24606045	T45	60
24606050	T50	60
24606055	T55	60
24606060	T60	60
24606070	T70	60

**Slagdoppen XZN spline 1/2"**  
**Douilles à choc XZN spline 1/2"**

Art.nr	mm	L mm
24806008	M8	60
24806010	M10	60
24806012	M12	60
24807812	M12	78
24807814	M14	78
24807816	M16	78
24807518	M18	78





**FOR 4032**

1/2" Slagdoppenset 3 delig voor alu velgen 6k  
 Douilles à choc pour jantes en alu 3 pcs 1/2"

4458517C	17 mm (85 mm L)
4458519C	19 mm (85 mm L)
4458521C	21 mm (85 mm L)



**FOR 4033**

1/2" Lange slagdoppenset 3 delig voor alu velgen 6k  
 Douilles à choc longues pour jantes en alu 3 pcs 1/2"

44515017C	17 mm (150 mm L)
44515019C	19 mm (150 mm L)
44515021C	21 mm (150 mm L)



**FOR 4032TH**

1/2" Slagdoppenset 3 delig dunwandig 6k  
 Douilles à choc convexe à paroi fine 3 pcs 6p 1/2"

4458517TH	17 mm (85 mm L)
4458519TH	19 mm (85 mm L)
4458521TH	21 mm (85 mm L)



**FOR 4035**

1/2" Lange torsie slagdoppenset 3 delig voor alu velgen 6k  
 Douilles à choc torsion pour jantes en alu 3 pcs 6p 1/2"

	17 mm
	19 mm
	21 mm



Art.nr	mm	L mm
FOR 4458517C	17 mm	85
FOR 4458519C	19 mm	85
FOR 4458521C	21 mm	85
FOR 44515017C	17 mm	105
FOR 44515019C	19 mm	105
FOR 44515021C	21 mm	105

Lange slagdoppen 6k alu velg 1/2"  
 Douilles à choc 6p gantes alu 1/2"



**FOR K4079**

Slagmoer adapter set 7 delig (ball type)  
 Adaptateur à choc 7 pcs (avec bille)

80932MPB	3/8" x 1/4"
80934MPB	3/8" x 1/2"
80943MPB	1/2" x 3/8"
80946MPB	1/2" x 3/4"
80964MPB	3/4" x 1/2"
80968MPB	3/4" x 1"
80986MPB	1" x 3/4"



**FOR T8151**

Slagmoer adapter set 15 delig (ball type)  
 Adaptateur à choc 15 pcs (avec bille)

80923MPB 86MPB	1/4"x3/8" - 3/8"x1/4" - 3/8"x1/2" - 1/2"x3/8" - 1/2"x3/4" - 3/4"x1/2" - 3/4"x1" - 1"x3/4"
80531 MPB 61MPB	kniegewricht 3/8",1/2",3/4"
81032MPB 45MPB	impact bit holder 3/8"x1/4" - 3/8"x5/16" - 1/2"x1/4" - 1/2"x5/16"



Art.nr	mm	
FOR 80932MPB	3/8" x 1/4"	ball type
FOR 80934MPB	3/8" x 1/2"	ball type
FOR 80943MPB	1/2" x 3/8"	ball type
FOR 80946MPP	1/2" x 3/4"	pin type
FOR 80946MPB	1/2" 3/4"	ball type
FOR 80964MPB	3/4" x 1/2"	ball type
FOR 80968MPB	3/4" x 1"	ball type
FOR 80986MPP	1" x 3/4"	pin type
FOR 80986MPB	1" x 3/4"	ball type
FOR 809128MPP	1-1/2" x 1"	pin type

Verloopstukken  
 Adaptateurs



Art.nr	mm	type
FOR 80541MPP	1/2"	pin type
FOR 80541MPB	1/2"	ball type
FOR 80561MPB	3/4"	ball type

Kniegewricht  
 Cardan universel



**FOR 6081**

3/4" Slagdoppenset 8 delig in metalen koffer  
Jeu de douilles à choc 8 pcs 3/4"

46526	26 mm
46527	27 mm
46529	29 mm
46530	30 mm
46532	32 mm
46535	35 mm
46536	36 mm
46538	38 mm



**FOR 6083**

3/4" Slagdoppenset 8 delig in metalen koffer  
Jeu de douilles à choc 8 pcs 3/4"

46519	19 mm
46522	22 mm
46524	24 mm
46527	27 mm
46530	30 mm
46532	32 mm
46536	36 mm
46541	41 mm



**FOR T6121**

TC module 12 slagdoppen 6kant 3/4"  
Module 12 douilles à choc 3/4"

465 17... 41	17-19-21-22-24-27-30-32-34-36-38-41 mm
--------------	--



**FOR 6091**

3/4" Slagdoppenset inbus 6kant 9 dlg  
Coffret 3/4" douilles à chocs hex 9pcs

26490 14.....32	14-16-17-19-22-24-27-30-32 mm
-----------------	-------------------------------



Art.nr	mm	L mm
FOR 46519	19	50
FOR 46521	21	50
FOR 46522	22	50
FOR 46524	24	50
FOR 46526	26	50
FOR 46527	27	54
FOR 46528	28	54
FOR 46529	29	54
FOR 46530	30	54
FOR 46532	32	57
FOR 46533	33	57
FOR 46534	34	57
FOR 46535	35	57
FOR 46536	36	57
FOR 46538	38	57
FOR 46541	41	57
FOR 46542	42	57
FOR 46546	46	63
FOR 46550	50	68
FOR 46552	52	70
FOR 46555	55	72
FOR 46560	60	75
FOR 46570	70	85

Art.nr	mm	L mm
FOR 46817	17	50
FOR 46819	19	50
FOR 46824	24	50

Art.nr	mm	L mm
FOR 2649014	14	90
FOR 2649016	16	90
FOR 2649017	17	90
FOR 2649019	19	90
FOR 2649022	22	90
FOR 2649024	24	90
FOR 2649027	27	90
FOR 2649030	30	90
FOR 2649032	32	90

**Slagdoppen 6 kant 3/4"**  
**Douilles à choc 6 pans 3/4"**



**Slagdoppen 12 kant 3/4"**  
**Douilles à choc 12 pans 3/4"**

**Slagdoppen inbus 6 kant 3/4"**  
**Douilles à choc hex 6 pans 3/4"**





**FOR 6081D**

3/4" Lange slagdoppenset 6k 8 delig in metalen koffer  
Jeu de douilles à choc longues 6p 8 pcs 3/4"

46510026	26 mm
46510027	27 mm
46510029	29 mm
46510030	30 mm
46510032	32 mm
46510035	35 mm
46510036	36 mm
46510038	38 mm



**FOR 6083D**

3/4" Lange slagdoppenset 6k 8 delig in metalen koffer  
Jeu de douilles à choc longues 6p 8 pcs 3/4"

46510019	19 mm
46510022	22 mm
46510024	24 mm
46510027	27 mm
46510030	30 mm
46510032	32 mm
46510036	36 mm
46510041	41 mm



**FOR T6085**

TC module 8 lange slagdoppen 6kant 3/4"  
Module 8 douilles longues à choc 6p 3/4"

465100 19 41	19-22-24-27-30-32-36-41 mm
--------------	----------------------------



Art.nr	mm	L mm
FOR 46510017	17	100
FOR 46510019	19	100
FOR 46510020	20	100
FOR 46510021	21	100
FOR 46510022	22	100
FOR 46510023	23	100
FOR 46510024	24	100
FOR 46510026	26	100
FOR 46510027	27	100
FOR 46510028	28	100
FOR 46510029	29	100
FOR 46510030	30	100
FOR 46510032	32	100
FOR 46510033	33	100
FOR 46510034	34	100
FOR 46510035	35	100
FOR 46510036	36	100
FOR 46510038	38	100
FOR 46510041	41	100
FOR 46510046	46	100
FOR 46510048	48	100
FOR 46510050	50	100

Lange slagdoppen 6 kant 3/4"  
Douilles à choc longues 6 pans 3/4"



**FOR 8081**

1" Slagdoppenset 8 delig metalen koffer  
 Jeu de douilles à choc 8 pcs 1"



48524	24 mm
48527	27 mm
48530	30 mm
48532	32 mm
48533	33 mm
48536	36 mm
48538	38 mm
48541	41 mm

**FOR 8081D**

1" Lange slagdoppenset 8 delig metalen koffer  
 Jeu de douilles à choc longues 8 pcs 1"



FOR 48510024	24 mm
FOR 48510027	27 mm
FOR 48510030	30 mm
FOR 48510032	32 mm
FOR 48510033	33 mm
FOR 48510036	36 mm
FOR 48510038	38 mm
FOR 48510041	41 mm

**FOR 8071**

1" Slagdoppenset 7 delig pvc koffer met foam  
 Jeu de douilles à choc 7 pcs 1" en coffre PVC avec foam



48546	46 mm
48550	50 mm
48555	55 mm
48560	60 mm
48565	65 mm
48570	70 mm
48575	75 mm

Art.nr	mm	L mm
FOR 48524	24	60
FOR 48527	27	60
FOR 48530	30	60
FOR 48532	32	60
FOR 48533	33	60
FOR 48535	35	62
FOR 48536	36	65
FOR 48538	38	65
FOR 48541	41	67
FOR 48542	42	70
FOR 48546	46	75
FOR 48550	50	75
FOR 48555	55	80
FOR 48558	58	85
FOR 48560	60	85
FOR 48565	65	90
FOR 48570	70	95
FOR 48575	75	95
FOR 48580	80	100
FOR 48585	85	105
FOR 48590	90	105
FOR 48595	95	105

**Slagdoppen 6 kant 1"**  
**Douilles à choc 6 pans 1"**



Art.nr	mm	L mm
FOR 48510024	24	100
FOR 48510026	26	100
FOR 48510027	27	100
FOR 48510030	30	100
FOR 48510032	32	100
FOR 48510033	33	100
FOR 48510034	34	100
FOR 48510035	35	100
FOR 48510036	36	100
FOR 48510038	38	100
FOR 48510041	41	100
FOR 48510046	46	100
FOR 48510050	50	100

**Lange slagdoppen 6 kant 1"**  
**Douilles à choc longues 6 pans 1"**



Art.nr	mm	L mm	kg
FOR 4125105	105	120	11kg

**Slagdrop 6 kant 1-1/2"**  
**Douille à choc 6 pans 1-1/2"**





Art.nr	mm	L mm
FOR 8043075MPP	3/8"	75
FOR 8043150MPP	3/8"	150
FOR 8044125MPP	1/2"	125
FOR 8044250MPP	1/2"	250
FOR 8046100MPP	3/4"	100
FOR 8046175MPP	3/4"	175
FOR 8046250MPP	3/4"	250
FOR 8046330MPP	3/4"	330
FOR 8048250MPP	1"	250
FOR 8048330MPP	1"	330

### Verlengstukken Rallonges



MPP = pin type  
MPB = ball type

Art.nr	mm	type
FOR R1935	1/2"	O ring 19-3.5
FOR P2030	1/2"	pin 20L dia 3.0
FOR R2435	1/2"	O ring 24-3.5
FOR P2530	1/2"	pin 25L dia 3.0

### O ring & pin Bague en caoutchouc + goupille de sécurité



FOR R3355	3/4"	O ring 33-5.5
FOR P3040	3/4"	pin 35L dia 4.0
FOR R3755	3/4"	O ring 37-5.5
FOR P3540	3/4"	pin35L dia 4.0
FOR R4455	3/4"-1"	O ring 44-5.5
FOR P4540	3/4"-1"	pin 45L dia 4.0

FOR R7555	1"	O ring 75-5.5
FOR P7550	1"	pin 75L dia 5.0

Minimale afname 5 st  
Commande min. 5 pcs

### ZA 3428

1/2" Inbus slagdoppenset 7 delig  
- 4-5-6-8-10-13-14 mm  
Douilles à choc hexagonales 7 pcs 1/2"



### ZA 3427

1/2" Torx slagdoppenset 7 delig  
- T25-T30-T40-T45-T50-T55-T60  
Douilles à choc torx 7 pcs 1/2"



## ZA TSM168

### Alu gereedschapskoffer 168 delig 46x36x15.5cm

- netto gewicht 13kg

#### Assortiment d'outils 168 pcs

- valise porte-outils en alu

1/2" doppen 6 kant	12-13-14-15-16-17-18-19-21-24-27-30-32 mm
1/2" bougiedoppen	douilles pour bougie 16-21 mm
1/2" verlengstukken	rallonge 125-250 mm
1/2" wringstaaf / 1/2" ratel, cliquet / kniegewricht, cardan universel	
1/4" doppen 6 kant	4-4.5-5-5.5-6-7-8-9-10-11-12-13-14 mm
1/4" ratel / 1/4" wringstaaf/kniegewricht	
1/4" verlengstukken	rallonge 50-100 mm
1-Calliper	
1-hamer	marteau 300gr
1- meter	mètre à ruban 5m
1-half ronde vijl	200 mm
steekringsleutels	6-10-11-12-13-14-17-19-22 mm
9-inbussleutel	1.5-2-2.5-3-4-5-6-8-10 mm bolkop
verstelbare moersleutel, clé à molette 250 mm	
kombinatietang	pince universelle 175 mm
waterpomptang	pince multiprise 225 mm
1-kniptang	pince coupante 150 mm
1-lange bektang	pince à becs long 150 mm
carpenter tang	150 mm
1-auto tester	220-250v
1-schaar	ciseau
4-schroevendraaiers	plat: 5x75 mm L, plat: 6x100 mm L
4 tournevis	PH#2x100 mm L, PH#1x75 mm L
4 in 1 circlipstang	pince circlips kombinatie circlipstang
5-precisiechroevendr	plat: 2-3-4 mm, PH00-PH0-PH1 5 beitel & doorslagenset
1-striptang	200 mm
1-alu waterpas	250 mm
1-flashlamp	
1-cuttermes	3 reservemesjes
1-minizaag	+ 5 zaagbladen
1-Terminal	
1-bit houder	porte embout
30 delig bitset	jeu d'embouts 30 pcs



## ZA 104855

### Gevulde gereedschapskoffer 85 delig

- L468 mm x B218 mm x H203 mm

- 12.50kg

#### Coffre d'outils 85 pcs

- L468 mm x B218 mm x H203 mm

- 12.50kg

1/2" doppen, douilles	10-11-12-13-14-15-16-17-18-19-20-21-22-23-24-27-30-32 mm
1/2" ratel, cliquet	
1/2" verlengstuk	rallonge 125 mm
1/2" wringstaaf	manche en T
1/2" kniegewricht	cardan universel
1/4" doppen, douilles	4-4.5-5-5.5-6-7-8-9-10-11-12-13 mm
1/4" ratel	cliquet
1/4" verlengstuk	rallonge 75 mm
1/4" bits - 6	embouts schroevendraaier handvat, manche tournevis
1- meter 3m	mètre à ruban
12 steekringsleutels	6-8-9-10-11-12-13-14-15-16-17-19 mm
9-inbussleutel	1.5-2-2.5-3-4-5-6-8-10 mm
waterpomptang	pince multiprise
1-lange bektang	pince à becs long
4-schroevendraaiers	plat: 5x75 mm L, plat: 6x100 mm L, 6.5x150 mm L PH#2x100 mm L, PH#1x75 mm L
1-mes	10 reservemesjes
1 vise grip tang	pince grip







	Steekringsleutels mm - clés mixtes	152	
	Steekringsleutels inch - clés mixtes en pouces	157	
	Steekring met ratel - clés mixte à cliquet	158	
	Steeksleutels - clés à fourches	162	
	Ringsleutels - clés polygonales	163	
	Pijpsleutels - clés à pipe	167	
	Open ringsleutels - clés à tuyauter	168	
	Kniesleutels - clés à douille articulée	169	
	Dopsleutels - clés à douilles	170	
	Verstelbare moersleutels - clés à molettes	172	
	Momentsleutels - clés dynamométrique	175	

### Steekring metrisch

Art.nr	mm	L mm	gewicht/poids gr
FOR 75504	4	96	13
FOR 75505	5	96	13
FOR 75506	6	100	16
FOR 75507	7	110	21
FOR 75508	8	120	26
FOR 75509	9	130	33
FOR 75510	10	140	38
FOR 75511	11	150	48
FOR 75512	12	160	56
FOR 75513	13	170	73
FOR 75514	14	180	85
FOR 75515	15	190	99
FOR 75516	16	200	117
FOR 75517	17	210	136
FOR 75518	18	220	158
FOR 75519	19	230	175
FOR 75520	20	240	216
FOR 75521	21	250	227
FOR 75522	22	260	258
FOR 75523	23	270	285
FOR 75524	24	280	309
FOR 75525	25	290	330
FOR 75526	26	300	377
FOR 75527	27	310	403
FOR 75528	28	320	448
FOR 75529	29	330	499
FOR 75530	30	340	536
FOR 75532	32	360	637
FOR 75533	33	385	616
FOR 75534	34	385	603
FOR 75535	35	410	850
FOR 75536	36	410	840
FOR 75538	38	435	998
FOR 75541	41	460	1281
FOR 75542	42	460	1258
FOR 75544	44	500	1712
FOR 75546	46	500	1679
FOR 75548	48	540	2170
FOR 75550	50	540	2130
FOR 75555	55	560	3054
FOR 75560	60	600	3850
FOR 75565	65	680	5826
FOR 75570	70	680	5625



### FOR 51313

Steekringsleutelset extra lang 13 delig  
Jeu de 13 clés mixtes longues

Art.nr	mm	L mm
FOR 75508L	8	148
FOR 75510L	10	167
FOR 75511L	11	186
FOR 75512L	12	196
FOR 75513L	13	205
FOR 75514L	14	223
FOR 75515L	15	233
FOR 75516L	16	243
FOR 75517L	17	262
FOR 75518L	18	272
FOR 75519L	19	281
FOR 75522L	22	319
FOR 75524L	24	339



### FOR 5121

Steekringsleutelset 12 delig in hoes  
Jeu de clés mixtes 12 pcs en trousse

755 08...23 8-10-11-12-13-14-15-16-17-19-22-23 mm

### FOR 5141C

Steekringsleutelset 14 delig in hoes  
Jeu de clés mixtes 14 pcs en trousse

755 10...32 10-11-12-13-14-17-19-21-22-23-24-27-30-32 mm



### FOR 5261C

Steekringsleutelset 26 delig in hoes  
Jeu de clés mixtes 26 pcs en trousse

755 06...32 6-7-8-9-10-11-12-13-14-15-16-17-18-19-20- 22 23-24-25-26-27-28-29-30-32 mm

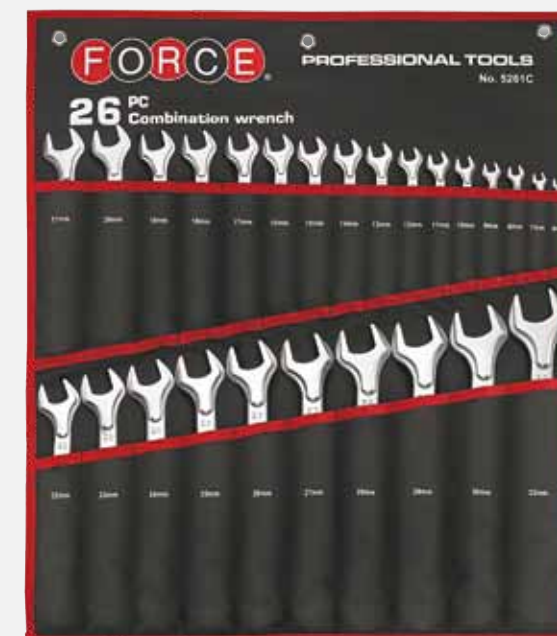

### FOR 50651

Steekringsleutelset 6 delig in hoes  
Jeu de clés mixtes 6 pcs en trousse

755 32... 46 32-34-36-38-41-46 mm







**FOR T5161**

TC module 16 steekringsleutels  
TC module 16 clés mixtes

755 06...24 6-7-8-9-10-11-12-13-14-15-16-17-18-19-22-24 mm



**FOR T5181**

TC module 18 steekringsleutels  
TC module 18 clés mixtes

755 06...24 6-7-8-9-10-11-12-13-14-15-16-17-18-19-21-22-23-24 mm



**FOR T5052**

TC module 5 steekringsleutels  
TC module 5 clés mixtes

755 26...32 26-27-28-30-32 mm



**FOR T5089**

TC module 8 steekringsleutels  
TC module 8 clés mixtes

755 24...32 24-25-26-27-28-29-30-32 mm



**FOR 5086**

Set 8 steekringsleutels op houder  
Jeu de 8 clés mixte

755 10...22 10-11-12-13-14-17-19-22 mm



**FOR T51214**

TC module mini steekringsleutelset 12 delig  
TC module 12 clés mixtes mini

755S 08...19 8-9-10-11-12-13-14-15-16-17-18-19 mm



**Steekringsleutel kort**  
**Clés mixte mini**



Art.nr	mm	L mm
FOR 755S08	8	91
FOR 755S09	9	97
FOR 755S10	10	97
FOR 755S11	11	100
FOR 755S12	12	105
FOR 755S13	13	108
FOR 755S14	14	115
FOR 755S15	15	118
FOR 755S16	16	122
FOR 755S17	17	130
FOR 755S18	18	133
FOR 755S19	19	138

**Clés mixtes en pouces**

Art.nr	inch	L mm
FOR 7551.4	1/4"	100
FOR 7555.16	5/16"	120
FOR 7553.8	3/8"	140
FOR 7557.16	7/16"	150
FOR 7551.2	1/2"	170
FOR 7559.16	9/16"	180
FOR 755.8	5/8"	200
FOR 75511.16	11/16"	210
FOR 7553.4	3/4"	230
FOR 75513.16	13/16"	250
FOR 7557.8	7/8"	260
FOR 75515.16	15/16"	280
FOR 7551.0	1"	300
FOR 7551.16	1 1/16"	310
FOR 7551.8	1 1/8"	340
FOR 7551.4	1 1/4"	360
FOR 7551.5.16	1 5/16"	385
FOR 7551.3.8	1 3/8"	410
FOR 7551.7.16	1 7/16"	435
FOR 7551.1.2	1 1/2"	435
FOR 7551.5.8	1 5/8"	460
FOR 7551.11.16	1 11/16"	460
FOR 7551.3.4	1 3/4"	500

**FOR T5134**

TC module 13 steekringsleutels inch maten  
TC module 13 clés mixtes en pouce

1/4"-5/16"-3/8"-7/16"-1/2"-9/16"-5/8"-11/16"-3/4"-13/16"-7/8"-15/16"-1"



**FOR 5121S**

Steekringsleutelset 12 delig in hoes  
Jeu de 12 clés mixtes en trousse

755 1/4".... 75515.16" 1/4"-5/16"-3/8"-7/16"-1/2"-9/16"-5/8"-11/16"-3/4"-13/16"-7/8"-15/16"



**FOR 5141S**

Steekringsleutelset 14 delig in hoes  
Jeu de 14 clés mixtes en trousse

755 5/16 .....1.1/4 5/16"-3/8"-7/16"-1/2"-9/16"-5/8"-11/16"-3/4"-13/16" 7/8"-15/16"-1"-1-1/8"-1-1/4"

**FOR K5122S**

Flexibel ratelsleutelset 12 delig (foam met deksel)  
Clés mixtes à cliquet flexible 12 pcs (foam)

757 5.16F...1.0F 5/16"-3/8"-7/16"-1/2"-9/16"-5/8"-11/16"-3/4"-13/16"-7/8"-15/16"-1"



Art.nr	mm	L mm
FOR 75708	8	140
FOR 75709	9	150
FOR 75710	10	160
FOR 75711	11	165
FOR 75712	12	170
FOR 75713	13	180
FOR 75714	14	190
FOR 75715	15	200
FOR 75716	16	210
FOR 75717	17	223
FOR 75718	18	233
FOR 75719	19	244
FOR 75720	20	275
FOR 75721	21	275
FOR 75722	22	290
FOR 75724	24	290

**Steekringsleutel met ratel**  
*Clés mixte à cliquet*



Art.nr	mm	L mm
FOR 75708R	8	140
FOR 75709R	9	150
FOR 75710R	10	160
FOR 75711R	11	165
FOR 75712R	12	170
FOR 75713R	13	180
FOR 75714R	14	190
FOR 75715R	15	200
FOR 75716R	16	210
FOR 75717R	17	223
FOR 75718R	18	233
FOR 75719R	19	244
FOR 75724R	24	290

**Steekringsleutel met omkeerbare ratelsleutel**  
*Clés mixtes à cliquet reversible*



Art.nr	mm	L mm
FOR 75708F	8	130
FOR 75709F	9	155
FOR 75710F	10	155
FOR 75711F	11	173
FOR 75712F	12	173
FOR 75713F	13	185
FOR 75714F	14	191
FOR 75715F	15	215
FOR 75716F	16	215
FOR 75717F	17	230
FOR 75718F	18	248
FOR 75719F	19	248

**Steekringsleutel met flexibele ratel**  
*Clés mixtes à cliquet resersible flexible*



**FOR K51210F**

Flexibel ratelsleutelset 12 delig (foam met deksel)  
*Module mousse 12 clés mixtes à cliquet flexible*

757 08F...19F	8-9-10-11-12-13-14-15-16-17-18-19 mm
---------------	--------------------------------------



**FOR T51211**

TC module omkeerbare steekratel sleutelset 12 delig  
*TC module 12 clés mixtes à cliquet*

757 08R...19R	8-9-10-11-12-13-14-15-16-17-18-19 mm
---------------	--------------------------------------



**FOR T51210**

TC module platte ratelsleutelset 12 delig  
*TC module 12 clés mixtes à cliquet*

757 08...19	8-9-10-11-12-13-14-15-16-17-18-19 mm
-------------	--------------------------------------



**FOR T5164R**

TC module omkeerbare ratelsleutelset 16 delig  
*TC module 16 clés mixtes à cliquet*

757 08R...19R	8-9-10-11-12-13-14-15-16-17-18-19 mm
831 210...419	1/4" (10 mm) 3/8" (13 mm-) 1/2" (19 mm)
831H210	1/4" inbus 10 mm bithouder

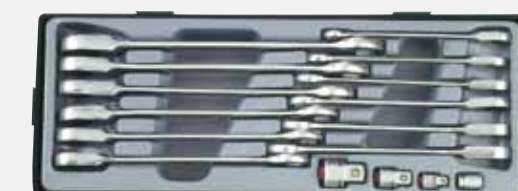

**FOR T51115**

TC module platte ratelsleutelset 11 delig  
*TC module 11 clés mixtes à cliquet*

757 08...19	8-10-12-13-14-17-19 mm
828 0608 2024	Torx E6xE8-E10xE12-E14xE18-E20xE24

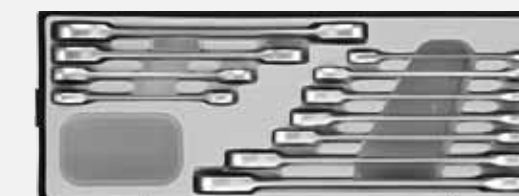





Art.nr	mm	L mm
FOR 7540607	6x7	123
FOR 7540809	8x9	141
FOR 7541011	10x11	157
FOR 7541213	12x13	172
FOR 7541415	14x15	190
FOR 7541617	16x17	205
FOR 7541819	18x19	220
FOR 7542022	20x22	236
FOR 7542123	21x23	246
FOR 7542224	22x24	246
FOR 7542427	24x27	259
FOR 7542528	25x28	279
FOR 7543032	30x32	297
FOR 7543236	32x36	350
FOR 7543436	34x36	350
FOR 7543641	36x41	380
FOR 7544146	41x46	415
FOR 7544650	46x50	465



Art.nr	mm	L mm
FOR 7540608S	1/4"x5/16"	123
FOR 7540810S	5/16"x3/8"	141
FOR 7541011S	3/8"x7/16"	157
FOR 7541314S	1/2"x9/16"	180
FOR 7541416S	9/16"x5/8"	190
FOR 7541617S	5/8"x11/16"	195
FOR 7541719S	11/16"x3/4"	220
FOR 7542122S	13/16"x7/8"	236
FOR 7542425S	15/16"x1"	255
FOR 7542427S	15/16"x1 1/16"	259
FOR 7542932S	1 1/8"x1 1/4"	297



Art.nr	mm	L mm
FOR 7590607	6x7	175
FOR 7590809	8x9	190
FOR 7591011	10x11	205
FOR 7591213	12x13	220
FOR 7591415	14x15	245
FOR 7591617	16x17	270
FOR 7591819	18x19	300
FOR 7592022	20x22	325
FOR 7592122	21x22	325
FOR 7592123	21x23	335
FOR 7592224	22x24	335
FOR 7592326	23x26	345
FOR 7592427	24x27	345
FOR 7592528	25x28	355
FOR 7592628	26x28	355
FOR 7593032	30x32	370



Art.nr	mm	L mm
FOR 7590608S	1.4"x5/16"	175
FOR 7591011S	3/8"x7/16"	205
FOR 7591314S	1/2"x9/16"	220
FOR 7591617S	5/8"x11/16"	270
FOR 7591719S	11/16"x3/4"	300
FOR 7591922S	3/4"x7/8"	325
FOR 7592122S	13/16"x7/8"	325
FOR 7592425S	15/16"x1"	345

### FOR T5111

TC module 11 steeksleutels  
TC module 11 clés à fourches

6x7-8x9-10x11-12x13-14x15-16x17-18x19- 20x22-21x23-24x27-25x28-30x32



### FOR T5111S

TC module 11 steeksleutels SAE  
TC module 11 clés à fourches SAE



1/4"x5/16" - 5/16"x3/8" - 3/8"x7/16" - 1/2"x9/16"-9/16"x 5/8" - 5/8"x11/16" - 11/16"x3/4" - 13/16"x7/8" - 15/16"x1" - 15/16"x1 1/16" 1 1/8"x1 1/4"



### FOR T5081

TC module 8 gebogen ringsleutels 75°  
Tc module 8 clés polygonales coudées 75°

6x7-8x9-10x11-12x13-14x15-16x17-18x19-21x23 mm



### FOR T5044

TC module 4 gebogen ringsleutels 75°  
TC module 4 clés polygonales 75°

23x26-24x27-25x28-30x32 mm



### FOR 5128C

Steeksleutelset 12 delig in hoes  
Jeu de 12 clés à fourche en trousse

6x7-8x9-10x11-12x13-14x15-16x17-18x19 - 20x22-21x23-24x27-25x28-30x32



### FOR T5085

TC module 8 gebogen ringsleutels 45°  
Tc module 8 clés polygonales coudées 45°

8x9-10x11-12x13-14x15-16x17-18x19-21x23 mm-22x24 mm



**FOR 51213C**

Gebogen ringsleutelset 75° 12 delig in hoës  
12 Clés polygonales 75° en trousse

759 0607....3032 6x7-8x9-10x11-12x13-14x15-16x17-18x19 - 20x22-21x23-24x27-25x28-30x32 mm

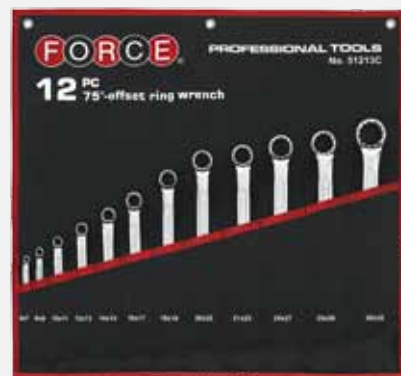
**FOR 5041**

Torx ringsleutelset 4 delig  
Clés torx 4 pcs

756 0608....2024 E6xE8 - E10xE12 - E14xE18 - E20xE24

Art.nr	mm	L mm
FOR 7560608	6X8	112
FOR 7560711	7X11	125
FOR 7561012	10X12	140
FOR 7561418	14X18	180
FOR 7561622	16x22	200
FOR 7562024	20X24	224

**FOR T5085S**

TC module 8 gebogen ringsleutels 45° inch maten  
TC module 8 clés polygonales 45° en pouces



758 0608S....2425S 1/4" x 5/16" - 3/8" x 7/16" - 7/16" x 1/2"  
1/2" x 9/16" - 5/8" x 11/16" - 11/16" x 3/4" -  
13/16" x 7/8" - 7/8" x 15/16"

**FOR T5079S**

TC module 7 gebogen ringsleutels 75° inch maten  
TC module 7 clés polygonales en pouces



759 0608S....2425S 1/4" x 5/16" - 3/8" x 7/16"  
1/2" x 9/16" - 5/8" x 11/16" - 3/4" x 7/8" -  
13/16" x 7/8" - 15/16" x 1"

**FOR T51226**

TC module 12 platte ringsleutels  
TC module 12 clés polygonales à fourches

760M 0607....3032 6x7-8x9-10x11-12x13-14x15-16x17-18x19  
20x22-21x23-22x24-26x28-30x32 mm

**FOR T51226A**

TC module 12 platte ringsleutels 15°  
TC module 12 clés polygonales à fourches 15°

760 0607A....3032A 6x7-8x9-10x11-12x13-14x15-16x17-18x19  
20x22-21x23-22x24-26x28-30x32 mm

**FOR 50911**

Halvemaan sleutelset 9 delig  
Clés demi-lune 9 pcs

761 0810....1922 8x10 - 10x11 - 10x12 - 11x13 - 12x14 - 13x15 - 14x17 - 16x18  
-17x19 - 19x22 mm

Art.nr	mm	L mm
FOR 7610810	8x10	138
FOR 7611012	10x12	141
FOR 7611113	11x13	165
FOR 7611214	12x14	165
FOR 7611315	13x15	190
FOR 7611417	14x17	190
FOR 7611618	16x18	220
FOR 7611719	17x19	220
FOR 7611922	19x22	255
FOR 7612224	22x24	285

**FOR 50622**

Rechte ringsleutels extra lang 6 delig  
6 Clés polygonales droite extra longues

Art.nr	mm	L mm
FOR 7601012	10x12	290
FOR 7601214	12x14	330
FOR 7601315	13x15	360
FOR 7601417	14x17	370
FOR 7601618	16x18	405
FOR 7601719	17x19	405





**FOR T50810**

TC module ratel-ringsleutelset plat 8 delig  
TC module 8 clés plates à cliquet

824 0607....2122 6x7-8x9-10x11-12x13-14x15-16x18-17x19-21x22 mm

**FOR T50811**

TC module rechte ratel-ringsleutelset gebogen 8 delig  
Tc module 8 clés polygonales à cliquet

825 0607....2122 6x7-8x9-10x11-12x13-14x15-16x18-17x19-21x22 mm

**FOR T50617**

TC module ratel-ringsleutelset torx 6 delig  
Tc module 6 clés polygonales à cliquet torx

826 0607....2224 E6xE7 - E8xE10 - E11xE12 - E14xE16 - E18xE20 - E22xE24

**Montagesleutels**

Art.nr	mm	L mm
FOR 8221719	17x19	315
FOR 8221922	19x22	315
FOR 8221924	19x24	315
FOR 8222224	22x24	315



Art.nr	mm	L mm kort	L mm lang
FOR 75306	6	26	94
FOR 75307	7	28	98
FOR 75308	8	32	114
FOR 75309	9	34	122
FOR 75310	10	37	129
FOR 75311	11	40	140
FOR 75312	12	43	147
FOR 75313	13	45	157
FOR 75314	14	47	164
FOR 75315	15	49	172
FOR 75316	16	53	186
FOR 75317	17	55	194
FOR 75318	18	58	197
FOR 75319	19	63	209
FOR 75322	22	69	231

Pijpsleutel gebogen 6 kant  
Clés à pipe débouchée 6 pans

**FOR T5114**

TC module 11 gebogen pijpsleutels 6 kant  
Tc module 11 clés à pipe débouchées 6 pans

753 08....19 8-10-11-12-13-14-15-16-17-18-19 mm



Art.nr	mm	L mm
FOR 7620607	6x7	127
FOR 7620809	8x9	132
FOR 7621011	10x11	132
FOR 7621213	12x13	144
FOR 7621415	14x15	153
FOR 7621617	16x17	162
FOR 7621819	18x19	175

Rechte pijpsleutel 6 kant  
Clés en tube 6 pans

**FOR T50817**

TC module 8 rechte pijpsleutels 6 kant  
TC module 8 clés en tube 6 pans

762 0607....1819 6x7-8x9-10x11-12x13-14x15-16x17-18x19  
762220 1 wringbar, broche 220 mm L



### Open ringsleutels 12 kant/12 pans



Art.nr	mm	L mm
FOR 7510810	8x10	130
FOR 7510910	9x10	130
FOR 7511011	10x11	152
FOR 7511012	10x12	152
FOR 7511113	11x13	165
FOR 7511214	12x14	178
FOR 7511314	13x14	178
FOR 7511417	14x17	194
FOR 7511618	16x18	215
FOR 7511719	17x19	215
FOR 7511922	19x22	235
FOR 7512427	24x27	265
FOR 7513032	30x32	285



Art.nr	inch	L mm
FOR 7510810S	5/16"x3/8"	130
FOR 7511011S	3/8"x7/16"	152
FOR 7511112S	7/16"x1/2"	165
FOR 7511214S	1/2"x9/16"	178
FOR 7511619S	5/8"x3/4"	215
FOR 7511719S	11/16"x3/4"	215
FOR 7511922S	3/4"x7/8"	235



Art.nr	mm	L mm
FOR 7520607	6x7	198
FOR 7520809	8x9	198
FOR 7521011	10x11	215
FOR 7521213	12x13	227
FOR 7521415	14x15	244
FOR 7521617	16x17	255
FOR 7521819	18x19	274
FOR 7522022	20x22	295
FOR 7522123	21x23	295
FOR 7522427	24x27	323



Art.nr	inch	L mm
FOR 7521011S	3/8"x7/16"	215
FOR 7521314S	1/2"x9/16"	232
FOR 7521617S	5/8"x11/16"	255
FOR 7521922S	3/4"x7/8"	290
FOR 7522122S	13/16"x7/8"	295
FOR 7522425S	15/16"x1"	323

#### FOR 5066

Open ringsleutelset 6 delig  
Jeu de clés à tuyauter 6 pcs

751 0810....1719	8x10 - 10x11 - 10x12 - 11x13 - 12x14 - 17x19
------------------	--



#### FOR T5082

TC module 8 open ringsleutels  
TC module 8 clés à tuyauter

751 0810....3032	8x10 - 11x13 - 12x14 - 16x18 - 17x19 - 19x22 24x27 - 30x32 mm
------------------	---



#### FOR T5074

TC module 7 kniesleutels  
TC module 7 clés à douille articulées

752 0607...1819	6x7-8x9-10x11-12x13-14x15-16x17-18x19
-----------------	---------------------------------------



#### FOR T5033

TC module 3 kniesleutels  
TC module 3 clés à douille articulées

752 2022....2427	20x22 - 21x23 - 24x27 mm
------------------	--------------------------



#### FOR T50710

TC module 7 open ringsleutels  
TC module 7 clés à tuyauter



751 0810S....1922S	5/16"x3/8" - 3/8"x7/16" - 7/16"x1/2" - 1/2"x9/16" - 5/8"x3/4" - 11/16"x3/4" - 3/4"x7/8"
--------------------	---



#### FOR T5172

TC module kraaienpoot ringsleutelset 12k 17 delig  
TC module 17 clés pièd à cornaille 12 pans

7513 10....22	3/8" 10-11-12-13-14-15-16-17-18-19-21-22 mm
7514 23....26	1/2" 23-24-26 mm
808306	3/8" verlenstuk, rallonge 150 mm L
808405	1/2" verlenstuk, rallonge 125 mm L



#### FOR T50616S

TC module 6 kniesleutels  
TC module 6 clés à douille articulées



752 1011S....2425S	3/8"x7/16"-1/2"x9/16"-5/8"x11/16"-3/4"x7/8"-13/16"x7/8"-15/16"x1"
--------------------	---



#### FOR 50816

Universeel kniegewrichtset 8 delig  
Module de cardan universelle 8 pcs

784 307U...419U	7-8-10-12-13-14-17-19
-----------------	-----------------------

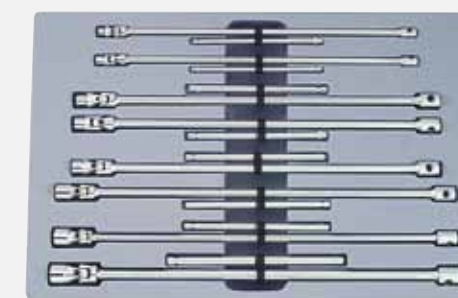



Art.nr	mm	L mm	Totale L mm
FOR 77430004	4 mm	260mm	300
FOR 77430005	5 mm	260mm	300
FOR 774300055	5.5 mm	260mm	300
FOR 77430006	6 mm	260mm	300
FOR 77430007	7 mm	260mm	300
FOR 77430008	8 mm	260mm	300
FOR 77430009	9 mm	260mm	300
FOR 77430010	10 mm	260mm	300
FOR 77430011	11 mm	260mm	300
FOR 77430012	12 mm	260mm	300
FOR 77430013	13 mm	260mm	300
FOR 77430014	14 mm	260mm	300
FOR 77430017	17 mm	260mm	300



### FOR 2095

Dop op T handvat 9 delig  
Jeu de 9 douilles à poignée en "T"

774300 05...13	5-6-7-8-9-10-11-12-13 mm
----------------	--------------------------



### FOR 2095S

Dop op T handvat inch maten 9 delig  
Jeu de 9 douilles à poignée en "T" en pouces

Art.nr	inch	L mm	Totale L mm
FOR 774003.16	3/16"	260	300
FOR 7743001.4	1/4"	260	300
FOR 7743009.32	9/32"	260	300
FOR 7743005.16	5/16"	260	300
FOR 77430011.32	11/32"	260	300
FOR 7743003.8	3/8"	260	300
FOR 7743007.16	7/16"	260	300
FOR 7743001.2	1/2"	260	300
FOR 7743009.16	9/16"	260	300



### FOR 2096

Torx dop op T handvat 9 delig  
Jeu de 9 douilles torx à poignée "T"

Art.nr	mm	L mm	Totale L mm
FOR 77604	E4	260mm	300
FOR 77605	E5	260mm	300
FOR 77606	E6	260mm	300
FOR 77607	E7	260mm	300
FOR 77608	E8	260mm	300
FOR 77610	E10	260mm	300
FOR 77612	E12	260mm	300
FOR 77614	E14	260mm	300
FOR 77616	E16	260mm	300



### FOR 2134

Dop op schroevendraaier 13 delig  
Jeu de 13 tournevis - douilles

Art.nr	mm	L mm	Totale L mm
FOR 74425004	4 mm	135mm	250
FOR 74425005	5 mm	135mm	250
FOR 74425055	5.5 mm	135mm	250
FOR 7442506	6 mm	135mm	250
FOR 7442507	7 mm	135mm	250
FOR 7442508	8 mm	135mm	250
FOR 7442509	9 mm	135mm	250
FOR 7442510	10 mm	135mm	250
FOR 7442511	11 mm	135mm	250
FOR 7442512	12 mm	135mm	250
FOR 7442513	13 mm	135mm	250
FOR 7442514	14 mm	135mm	250



### FOR T20612

Tc module 6 dop op schroevendraaier  
Module de 6 tournevis sur douilles

774300 05...13	6-7-8-10-12-13 mm
----------------	-------------------



Art.nr	mm	L mm	Gewicht/poids gr
FOR 649200	24 mm	200	242gr
FOR 649250	29 mm	250	397gr
FOR 649300	33 mm	300	605gr
FOR 649375	46 mm	375	1140gr
FOR 649450	60 mm	450	1610gr
FOR 649600	70 mm	600	3280gr

**Sleutel met karterwiel, gefosfateerd**  
**Clés à molette phosphatée**



**FOR T5036**

TC module verstelbare moersleutels 3 delig  
TC module 3 clés à molette

649200	moersleutel 200 mm	24 mm
649250	moersleutel 250 mm	29 mm
649300	moersleutel 300 mm	33 mm



**Sleutel met karterwiel, bekleed handvat**  
**Clés à molette chromées gainées**

Art.nr	mm	L mm	Gewicht/poids gr
FOR 649250A	33 mm	250	440gr
FOR 649375A	46 mm	375	1250gr



**FOR T5023**

TC module verstelbare moersleutels 2 delig  
TC module 2 clés à molette

649200E	moersleutel 200 mm	24 mm
649300E	moersleutel 300 mm	33 mm



Art.nr	mm	L mm	Gewicht/poids gr
FOR 649200C	38 mm	200	280gr

Art.nr	mm	L mm	Gewicht/poids gr
FOR 649200E	24mm	200	290gr
FOR 649250E	29 mm	250	500gr
FOR 649300E	33 mm	300	765gr



**FOR 9U0701**

Aanpasbare spansleutel 1/2" tot 2-3/4"  
Clés à ergots 1/2" - 2 3/4"







# FORCE

*Power you on*



Art.nr	NM	mm	L mm	nw
FOR 6472270	5-25Nw	1/4"	270	770gr
FOR 6473270	5-25Nw	3/8"	270	775gr
FOR 6473365	19-110Nw	3/8"	365	1075gr
FOR 6474470	42-210Nw	1/2"	470	1650gr
FOR 64761030	140-700Nw	3/4"	1030	7575gr
FOR 6472270P	repair kit	1/4		
FOR 6473270P	repair kit	3/8		
FOR 6473365P	repair kit	3/8		
FOR 6474470P	repair kit	1/2		

Art.nr	NM	mm	L mm	
FOR 6474535	40-210Nw	1/2"	535	2100gr
FOR 6474660	70-350nW	1/2"	660	2980gr

Art.nr	NM	mm	L mm	
FOR 6473365S	15-80nw	3/8"	383	1050gr

Art.nr	NM	mm	L mm	
FOR 6472300W	6-30Nw	1/4"	300	800gr
FOR 6474530W	40-200nW	1/2"	530	1600gr
FOR 6472300WP	repair set			

Art.nr	NM	mm	L mm	
FOR 6473385	19-110Nw	3/8"	383	960gr
FOR 6474536	40-210Nw	1/2"	535	1070gr

Alle momentsleutels worden geleverd in pvc box

Art.nr	NM	mm	L mm	
FOR 647G2360	3-30Nw	1/4"	360	1012gr
FOR 647G3440	10-100Nw	3/8"	440	1204gr
FOR 647G4640	35-350Nw	1/2"	640	2160gr
FOR 647G4075	adapter	1/2"	76	
FOR 647G2360A	3-30Nw	1/4"	360	1012gr
FOR 647G3440A	10-100NW	3/8"	440	1204gr
FOR 647G4640A	35-350NW	1/2"	640	2160gr

- Zoemer en LED indicator
- Piek & Volgend modes
- RS-232 data
- Links en rechtsom draaiend
- Gaat automatisch na 120 seconden in slaapstand
- Nauwkeurigheid van ±1%
- Slaat tot 10 metingen op
- Keuze uit: Nm / Ft-lb / In-lb / Kg-m
- Batterij: 1.5V AA batterijen 3x

## Eénrichtings sleutels



## Te gebruiken in beide richtingen L & R



## Digitale momentsleutels met ratel Clés dynamométrique digital







## FOR T2085A

TC module schroevendraaierset 8 delig  
TC module 8 tournevis

713055S	Plat 5,5 mm (25 mm L)
713065S	Plat 6,5 mm (38 mm L)
7110	Philips PH,0 (60 mm L)
7111S	PH,1 (25 mm L)
7120	PZ,0 (60 mm L)
7121	PZ,1 (80 mm L)
7121S	PZ,1 (25 mm L)
7122	PZ,2 (100 mm L)

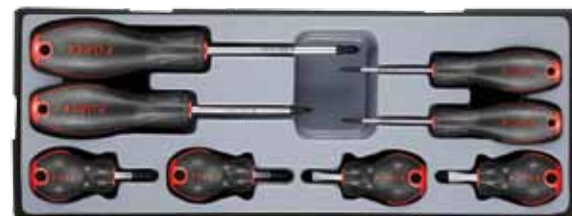

## FOR 20915

Schroevendraaierset 9 delig  
Jeu de 9 tournevis

713 03...065	3 mm (75 mm L), 4 mm (100 mm L), 5,5 mm (125 mm L) 6,5 mm (150 mm L)
713055S	5,5 mm (25 mm L)
7111-7112	PH1 (80 mm L) PH2 (80 mm L)
7111S-7112S	PH1 (25 mm L) PH2 (25 mm L)



## FOR 2142A

Schroevendraaierset 14 delig  
Jeu de 14 tournevis

71303	3 mm (75 mm L)
713035	3,5 mm (100 mm L)
71304	4 mm (100 mm L)
713055	5,5 mm (125 mm L)
713065	6,5 mm (150 mm L)
71308	8 mm (175 mm L)
713055S, 713065S	5,5 mm (25 mm L) 6,5 mm (125 mm L)
7110, 7111	PH 0 (60 mm L) PH 1 (80 mm L)
7112, 7113	PH 2 (100 mm L) PH 3(150 mm L)
7111S, 7112S	PH 1 (25 mm L) PH 2 (25 mm L)

**Platte  
plat**

Art.nr	mm	schacht L mm	Totale lengte
FOR 713055AS	1.0 x 5.5	25 mm	75mm
FOR 713065AS	1.2 x 6.5	25 mm	75mm
FOR 71303A	0.5 x 3	75 mm	160mm
FOR 713035A	0.5 x 3.5	100 mm	185mm
FOR 71304A	0.8 x 4	100 mm	205mm
FOR 713055A	1.0 x 5.5	125 mm	230mm
FOR 713065A	1.2 x 6.5	150 mm	265mm
FOR 71308A	1.2 x 8	175 mm	300mm
FOR 655304	4	300 mm	400mm
FOR 655305	5	300 mm	400mm
FOR 655306	6	300 mm	400mm
FOR 655308	8	300 mm	400mm

**Philips**

Art.nr	mm	L mm	Totale lengte
FOR 7111AS	PH1	25 mm	75mm
FOR 7112AS	PH2	25 mm	75mm
FOR 7110A	PH0	60 mm	145mm
FOR 7111A	PH1	80 mm	185mm
FOR 7112A	PH2	100 mm	215mm
FOR 7113A	PH3	150 mm	275mm
FOR 65511	PH1	350 mm	450mm
FOR 65512	PH2	350 mm	450mm

**Pozidriv**

Art.nr	mm	L mm	Totale lengte
FOR 7121AS	PZ1	25 mm	75mm
FOR 7122AS	PZ2	25 mm	75mm
FOR 7120A	PZ0	60 mm	145mm
FOR 7121A	PZ1	80 mm	185mm
FOR 7122A	PZ2	100 mm	215mm
FOR 7123A	PZ3	150 mm	278mm



**FOR T2086A**

TC module schroevendraaierset torx 8 delig

TC module 8 tournevis torx



71608	T8
71610	T10
71615	T15
71620	T20
71625	T25
71627	T27
71630	T30
71640	T40

**FOR 2137A**

Torx schroevendraaierset 13 delig

Jeu de 13 tournevis torx



71605	T5
71606	T6
71608	T8
71610	T10
71615	T15
71620	T20
71625	T25
71630	T30
71640	T40
71645	T45

**FOR 20719**

Torx schroevendraaierset 7 delig 300 mm L

Jeu de 7 tournevis torx 300 mm L



71630010	T10	300 mm L
71630015	T15	300 mm L
71630020	T20	300 mm L
71630025	T25	300 mm L
71630027	T27	300 mm L
71630030	T30	300 mm L
71630040	T40	300 mm L

**FOR 2119T**

Resistorx schroevendraaierset 11 delig

Jeu de 11 tournevis resistorx



717 06...40	T6-T7-T8-T9-T10-T15-T20-T25-T27--T30-T40
-------------	--



Art. nr.	mm	L mm	Totale lengte
FOR 71605A	T5	75	145mm
FOR 71606A	T6	75	145mm
FOR 71607A	T7	75	145mm
FOR 71608A	T8	75	145mm
FOR 71609A	T9	75	145mm
FOR 71610A	T10	100	185mm
FOR 71615A	T15	100	185mm
FOR 71620A	T20	100	205mm
FOR 71625A	T25	100	205mm
FOR 71627A	T27	100	230mm
FOR 71630A	T30	100	230mm
FOR 71640A	T40	100	245mm
FOR 71645A	T45	100	255mm
FOR 71630010	T10	300	405mm
FOR 71630015	T15	300	405mm
FOR 71630020	T20	300	405mm
FOR 71630025	T25	300	405mm
FOR 71630027	T27	300	415mm
FOR 71630030	T30	300	415mm
FOR 71630040	T40	300	415mm
FOR 71630045	T45	300	427mm



Art.nr	mm	L mm	Totale lengte
FOR 71706A	T6H	60	145mm
FOR 71707A	T7H	60	145mm
FOR 71708A	T8H	60	145mm
FOR 71710A	T10H	80	185mm
FOR 71715A	T15H	80	185mm
FOR 71720A	T20H	100	205mm
FOR 71725A	T25H	100	205mm
FOR 71727A	T27H	115	230mm
FOR 71730A	T30H	115	230mm
FOR 71740A	T40H	130	245mm
FOR 71745A	T45H	130	245mm



Art.nr	mm	L mm	Totale lengte
FOR 71F10	TS10	150	255mm
FOR 71F15	TS15	150	255mm
FOR 71F20	TS20	150	255mm
FOR 71F25	TS25	150	255mm
FOR 71F27	TS27	150	270mm
FOR 71F30	TS30	150	270mm
FOR 71F40	TS40	150	280mm

**Resistorx 5 kant**



**FOR 2108**

Schroevendraaierset 10 delig met stalen kop  
Jeu de 10 tournevis à frapper

713055M	5,5 (125 mm L)
713065M	6.5 (150 mm L)
71308M-71310M	8 (150 mm L) 10 (200 mm L)
71312M-71314M	12 (200 mm L) 14 (250 mm L)
7111M-7112M	PH1 (80 mm L) PH2 (100 mm L)
7113M-7114M	PH3 (150 mm L) PH4 (200 mm L)



**FOR 2109**

Schroevendraaierset 10 delig met stalen kop  
Jeu de 10 tournevis à frapper

713055M	5,5 (125 mm L)
713065M	6.5 (150 mm L)
71308M-71310M	8 (150 mm L) 10 (200 mm L)
71312M-71314M	12 (200 mm L) 14 (250 mm L)
7121M-7122M	PZ1 (80 mm L) PZ2 (100 mm L)
7123M-7124M	PZ3 (150 mm L) PZ4 (200 mm L)



**FOR 20610**

Schroevendraaierset 9 delig met stalen kop  
Jeu de 9 tournevis à frapper

713055M A	5,5 (125 mm L)
713065M A	6.5 (150 mm L)
71310M A	10 (200 mm L)
71314M A	12 (200 mm L)
7122M A-7123M A	PH2 (100 mm L) PH3 (150 mm L)



Stalen kop  
Tournevis à frapper



Art.nr	mm	L mm	Totale lengte
FOR 713055M	5.5 mm	125	230mm
FOR 713065M	6.5 mm	150	265mm
FOR 71308M	8 mm	150	275mm
FOR 71310M	10 mm	200	325mm
FOR 71312M	12 mm	200	325mm
FOR 71314M	14 mm	250	375mm
FOR 7111M	PH1	80	185mm
FOR 7112M	PH2	100	215mm
FOR 7113M	PH3	150	275mm
FOR 7114M	PH4	200	325mm
FOR 7121M	PZ1	80	185mm
FOR 7122M	PZ2	100	215mm
FOR 7123M	PZ3	150	275mm
FOR 7124M	PZ4	200	325mm

**FOR T2173**

TC module precisie schroevendraaierset 17 delig  
TC module 8 tournevis mini 17 pcs

731040 000... 00	PH000 PH 00 40 mm L
733040 01 ...024	plat 1-1.2-1.5-1.8-2.0-2.5 mm 40 mm L
734040 009...15	hex 0.9-1.3-1.5 mm
73640 05 ...08	T5-T6-T7-T8
2161.1	pincet
88601	demagnetiseur

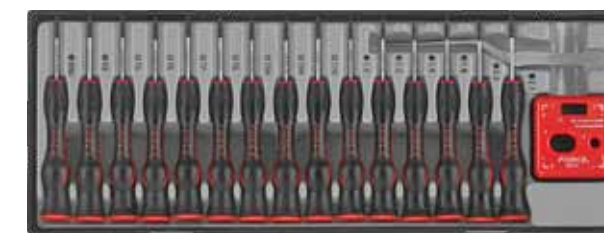

**FOR 2087**

Mini precisie schroevendraaierset 8 delig  
Jeu de 8 tournevis mini

731075 00... 1	PH 00 PH0 PH 1 (75mm L)
733040 02 ...04	plat 2-2.5-3.0 3.5 4.0 75 mm L



**FOR 2088**

Mini precisie schroevendraaierset 8 delig  
Jeu de 8 tournevis mini

736040 05...08	T5-T6-T7-T8mm (40mmL)
736075 09 ...20	T9-T10-T15-T20 mm (75mmL)

**FOR 5171**

Slagschroevendraaiër 17 delig  
Jeu de tournevis à frapper 17 pcs

8174	Slagschroevendraaiër
151362.....3	5/16" Philips PH,2 - PH,3 (36 mm L)
152362.....3	5/16" Pozidriv PZ,2 - PZ3 (36 mm L)
1533609.....11	5/16" Plat 9-11 mm (36 mm L)
1563525.....50	5/16" Torx T25-T30-T40-T45-T50 (35 mm L)
1543606.....10	5/16" Hex 6-8-10 mm (36 mm L)
8095330	1 bit adapter 5/16" hex 3/8"
81045A	impact adapter houder 1/2"-5/16"



Flexibele dopschroevendraaiër 6 kant  
Tournevis flexible 6pans

Art. nr.	mm	mm	Totale lengte
FOR 64806	6mm	160mm	270mm
FOR 64807	7mm	160mm	270mm
FOR 64808	8mm	160mm	270mm



Art.nr	mm	L mm
FOR 151301	PH.1	30 mm
FOR 151302	PH.2	30 mm
FOR 151303	PH.3	30 mm
FOR 151304	PH.4	30 mm
FOR 151361	PH.1	36 mm
FOR 151362	PH.2	36 mm
FOR 151363	PH.3	36 mm
FOR 151364	PH.4	36 mm
FOR 151384	PH.4	38 mm

5/16" Philips bit



Art.nr	mm	L mm
FOR 152301	PZ.1	30 mm
FOR 152302	PZ.2	30 mm
FOR 152303	PZ.3	30 mm
FOR 152362	PZ.2	36 mm
FOR 152363	PZ.3	36 mm

5/16" Pozidriv bit



Art.nr	mm	L mm
FOR 1533008	1.2x8	30 mm
FOR 1533010	1.6x10	30 mm
FOR 1533609	1.6x9	36 mm
FOR 1533611	1.8x11	36 mm

5/16" Platte bit



Art.nr	mm	L mm
FOR 1543005	5	30 mm
FOR 1543006	6	30 mm
FOR 1543007	7	30 mm
FOR 1543008	8	30 mm
FOR 1543010	10	30 mm
FOR 1543012	12	30 mm
FOR 1543014	14	30 mm

5/16" Inbus bit



Art.nr	mm	L mm
FOR 1563010	T10	30 mm
FOR 1563015	T15	30 mm
FOR 1563020	T20	30 mm
FOR 1563025	T25	30 mm
FOR 1563027	T27	30 mm
FOR 1563030	T30	30 mm
FOR 1563040	T40	30 mm
FOR 1563045	T45	30 mm
FOR 1563050	T50	30 mm
FOR 1563055	T55	30 mm
FOR 1563060	T60	30 mm
FOR 1563530	T30	35 mm
FOR 1563540	T40	35 mm
FOR 1567020	T20	70 mm
FOR 1567025	T25	70 mm
FOR 1567030	T30	70 mm
FOR 1567040	T40	70 mm
FOR 1567045	T45	70 mm
FOR 1567050	T50	70 mm
FOR 1567055	T55	70 mm
FOR 1567060	T60	70 mm

5/16" Torx bit (156)



5/16" Resistorx bit (157)



**FORCE**<sup>®</sup>  
PROFESSIONAL TOOLS





**FOR 2125****FOR 2126 pozidriv**

Geïsoleerde schroevendraaierset 12 delig

*Jeu de 12 tournevis 1000v*

713N025, 713N03	2,5 (75 mm L) 3 (100 mm L)
713N035, 713N04	3,5 (100 mm L) 4 (100 mm L)
713N055, 713N065	5,5 (125 mm L) 6,5 (150 mm L)
713N08	8 (175 mm L)
711N0, 711N1	PH0 (60 mm L) PH1 (80 mm L)
711N2, 711N3	PH2 (100 mm L) PH3 (150 mm L)
2125P1	circuit tester

**FOR T20712**

TC module geïsoleerde schroevendraaierset 7 delig

*TC module 7 tournevis 1000v*

711N1, 711N2	PH1 (80 mm L) PH2 (100 mm L)
713N03	3 mm (100 mm L)
713N04	4 mm (100 mm L)
713N055	5.5 mm (125 mm L)
713N065	6.5 mm (150 mm L)
2125P1	circuit tester

**FOR 20916**

Geïsoleerde schroevendraaierset 9 delig

*Jeu de 9 tournevis 1000v*

713N025, 713N03	2,4 (75 mm L) 3 (100 mm L)
713N035, 713N04	3,5 (100 mm L) 4 (100 mm L)
713N055, 713N065	5,5 (125 mm L) 6,5 (150 mm L)
711N1, 711N2	PH1 (80 mm L) PH2 (100 mm L)
88401	circuit tester

**FOR K20911**

Geïsoleerde schroevendraaierset 9 delig foam

*Jeu de 9 tournevis 1000v foam*

71303N, 71304N	3 (100 mm L) 4 (100 mm L)
713055N, 713065N	5.5 (125 mm L) 6.5 (150 mm L)
71308N	8 (175 mm L)
7110N, 7111N, 7112N	PH0 (60 mm L) PH1 (80 mm L) PH2 (100 mm L)
88403	tester 110-250v AC

**1000v**

Art.nr	mm	L mm schacht	Totale lengte
FOR 713N025	2.5 mm	75	160mm
FOR 713N03	3 mm	100	185mm
FOR 713N035	3.5 mm	100	185mm
FOR 713N04	4 mm	100	210mm
FOR 713N055	5.5 mm	125	235mm
FOR 713N065	6.5 mm	150	270mm
FOR 713N08	8 mm	175	305mm
FOR 711N0	PH0	60	145mm
FOR 711N1	PH1	80	190mm
FOR 711N2	PH2	100	220mm
FOR 711N3	PH3	150	280mm
FOR 712N0	PZ0	60	145mm
FOR 712N1	PZ1	80	190mm
FOR 712N2	PZ2	100	220mm
FOR 712N3	PZ3	150	280mm

**FOR 2125P1**

Stroomtester

*Testeur de circuit***FOR 88601**

Magnetiseur

*Demagnetiseur*

**FOR 2081C**

Bitset 1/4" 8 delig  
Jeu d'embouts 1/4" 8 pcs

12130 1G...3G	PH1-PH2-PH3 (30 mm L)
12230 1G...3G	PZ1-PZ2-PZ3 (30 mm L)
1233007G	platte bit 7 mm (30 mm L)
8152105	bit houder sleutel/porte embout



**FOR 2081**

Bitset resistorx 1/4" 8 delig  
Jeu d'embouts resistorx 1/4" 8 pcs

12730 10...40	T10H-T15H-T20H-T25H-T27H-T30H-T40H (30mmL)
8152105	bit houder sleutel/porte embout (110mmL)

**FOR 21111**

Bitset 1/4" 11 delig  
Jeu d'embouts 1/4" 11 pcs

12125 0...3	PH0-PH1-PH2-PH3 (25 mm L)
12225 0...3	PZ0-PZ1-PZ2-PZ3 (25 mm L)
12325 055...065	plat 5.5 mm-6.5 mm (25 mm L)
81260Q	magnetische bit houder/porte embout magnétique



**FOR 2331**

Veiligheidsbitset 1/4" 33 delig  
Jeu d'embouts 1/4" 33 pcs

81260	magnetische bithouder (60 mm L)
121S25 06...10	6-8-10
122S25 01...04	Tri wing 1-2-3-4
123S25 04...10	spanner 4-6-8-10
124S25 02...06	inbus 2-2.5-3-4-5-6 mm
124S25 5.32...5.64	5/32"-9/64"-1/8"-7/64"-3/32"-5/64"
12725 08...40	resistorx T8H-T10H-T15H-T20H-T25T-T27H-T30H-T35H-T40H

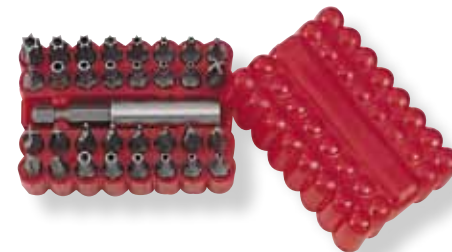

**FOR 21022**

Bitset 1/4" 102 delig  
Jeu d'embouts 1/4" 102 pcs

12125 1...3	PH1-PH2-PH3 (25 mm L)
12225 1...3	PZ1-PZ2-PZ3 (25 mm L)
12325 04...065	plat 4-5.5-6.5 (25 mm L)
12425 02...06	inbus 2-3-4-5-6 mm (25 mm L)
12625 06...40	torx T6-T8-T10-T15-T20-T25-T27-T30-T40
12725 06...40	resistorx T6H-T8H-T10H-T15H-T20H-T25H-T27H-T30H-T40H
81260Q	magnetische bithouder, porte embout
81260	magnetisch bithouder (60 mm L)



**FOR 21012**

Torxset 1/4" 10 delig  
Jeu de torx 1/4" 10 pcs

12625 07...40	T7-T8-T9-T10-T15-T20-T25-T27-T30-T40
---------------	--------------------------------------



**FOR 21013**

Resistorxset 5 kant 1/4" 10 delig  
Resistorx 5 pans 1/4" 10 pcs

12F25 08...50	TS08-TS10-TS15-TS20-TS25-TS27-TS30-TS45-TS50 25 mm L
---------------	--



**FOR 2311**

Bitset 1/4" 31 delig  
Jeu d'embouts 1/4" 31 pcs

81260Q	bithouder magnetisch 60 mm L
12125 0...3	PH0-PH1-PH2-PH3
12225 0...3	PZ0-PZ1-PZ2-PZ3
12325 03 ...065	plat 3-4-5-6.5 mm
12425 02...06	inbus 2-2.5-3-4-5-6 mm
12725 10...40	T10H-T15H-T20H-T25H-T27H-T30H-T35H-T40H



**FOR 20918**



Bitset 1/4" 9 dlg  
Jeu d'embouts 1/4" 9 pcs

	1/4" PH1-PH2 (165mmL)
	1/4" PZ1-PZ2 (165mmL)
	1/4" 3x4mm - 5.5x7mm (165mmL)
	1/4" T8xT10-T15xT20-T25xT27-T30xT40
8152	1/4" inhex 125mm



**ZA BT122**

Bitset 122 dlg  
Jeu d'embouts 122 pcs





Art.nr	mm	L mm
FOR 121250	PH.0	25 mm
FOR 121251	PH.1	25 mm
FOR 121252	PH.2	25 mm
FOR 121253	PH.3	25 mm



**1/4" Philips bit**



Art.nr	mm	L mm
FOR 122250	PZ.0	25 mm
FOR 122251	PZ.1	25 mm
FOR 122252	PZ.2	25 mm
FOR 122253	PZ.3	25 mm



**1/4" Pozidriv bit**



Art.nr	mm	L mm
FOR 1232503	0.5x3	25 mm
FOR 1232504	0.8x4	25 mm
FOR 1232505	0.8x5	25 mm
FOR 12325055	1.0x5.5	25 mm
FOR 12325065	1.2x6.5	25 mm



**1/4" Platte bit**



Art.nr	mm	L mm
FOR 1242503	3	25 mm
FOR 1242504	4	25 mm
FOR 1242505	5	25 mm
FOR 1242506	6	25 mm



**1/4" Inbus bit**



Art.nr	mm	L mm
FOR 1262504	T4	25 mm
FOR 1262505	T5	25 mm
FOR 1262506	T6	25 mm
FOR 1262507	T7	25 mm
FOR 1262508	T8	25 mm
FOR 1262509	T9	25 mm
FOR 1262510	T10	25 mm
FOR 1262515	T15	25 mm
FOR 1262520	T20	25 mm
FOR 1262525	T25	25 mm
FOR 1262527	T27	25 mm
FOR 1262530	T30	25 mm
FOR 1262540	T40	25 mm
FOR 1263008	T8	30 mm
FOR 1263009	T9	30 mm
FOR 1263010	T10	30 mm
FOR 1263015	T15	30 mm
FOR 1263020	T20	30 mm
FOR 1263030	T30	30 mm
FOR 1263040	T40	30 mm



**1/4" Torx bit**



Art.nr	mm	L mm
FOR 1272508	T8	25 mm
FOR 1272509	T9	25 mm
FOR 1272510	T10	25 mm
FOR 1272515	T15	25 mm
FOR 1272520	T20	25 mm
FOR 1272525	T25	25 mm
FOR 1272527	T27	25 mm
FOR 1272530	T30	25 mm
FOR 1272535	T35	25 mm
FOR 1272540	T40	25 mm



**1/4" Resistorx bit**



Art.nr	L mm	
FOR 81225	25 mm	1/4"

**Magneet dop 1/4"**  
*Porte-embouts magnétique 1/4"*



Art.nr	L mm	
FOR 81022	25 mm	1/4" x 1/4"

**Bithouder 1/4"**  
*Porte embout 1/4"*



Art.nr	L mm	
FOR 8092230	30 mm	1/4" x 1/4"
FOR 8092250	50 mm	1/4" x 1/4"
FOR 8095330	30 mm	5/16"x3/8"



Art.nr	L mm	
FOR 81260	60 mm	1/4" x 1/4"
FOR 81280Q	75 mm	1/4" x 1/4"



Art.nr	L mm	
FOR 81260Q	60 mm	1/4" x 1/4"



Art.nr	L mm	
FOR 812M08	65mm	8mm
FOR 812M10	65mm	10mm
FOR 812M13	65mm	13mm



**Steekhecht 1/4"**  
*Manche tournevis 1/4"*



Art.nr	L mm
FOR 8145	150 mm

Art.nr	L mm
FOR 8143	150 mm



**FOR 4155**

10 mm inbus bit set 15 delig  
Jeu d'embouts 10 mm 15 pcs



17430 04...12	4-5-6-7-8-10-12 mm (30 mm L)
17475 04...12	4-5-6-7-8-10-12 mm (75 mm L)
81047	bit houder 1/2" x 10 mm



**FOR 4156**

10 mm torx bit set 15 delig  
10 mm 15 embouts torx



17630 20..55	T20-T25T-30T-T40-T45-T50-T55 (30 mm L)
17675 20..55	T20-T25T-30T-T40-T45-T50-T55 (75 mm L)
81047	bit houder 1/2"x10 mm, porte embout



**FOR 4283**

10 mm bit set 28 delig  
10 mm jeu de 28 embouts

17430 04..12	Inbus bit 4-5-6-7-8-10-12 mm (30 mm L)
17475 05..10	5-6-8-10 mm (75 mm L)
17830 05..10	Spline M5-M6-M8-M10 (30 mm L)
17875 06..12	M6-M8-M10-M12 (75 mm L)
17630 20..55	torx T20-T25-T30-T40-T45-T50-T55 (30 mm L)
81037	bit houder 3/8"x10 mm
81047	bithouder 1/2"x10 mm



**FOR 4112**

10 mm bit set XZN 11 delig  
10 mm 11 embouts XZN

17830 05...12	M5-M6-M8-M10-M12 (30 mm L)
17875 05...12	M5-M6-M8-M10-M12 (75 mm L)
81047	bit houder 1/2"x10 mm, porte embout



**FOR 4401/FOR 4401T**

Bitset 10mm 40 delig - metalen koffer  
Jeu de 40 embouts - coffre métal

17430 04 ... 12	Inbus 4-5-6-7-8-10-12 mm (30 mm L)
17475 04 ... 12	4-5-6-7-8-10-12 mm (75 mm L)
17630 20 ... 55	Torx T20-T25T-30T-40-T45-T50-T55 (30 mm L)
17675 20 ... 55	T20-T25-T30-T40-T45-T50-T55 (75 mm L)
17830 05...12	XZN M5-M6-M8-M10-M12 (30 mm L)
17875 05...12	XZN M5-M6-M8-M10-M12 (75 mm L)
810 37..47	bit houder 3/8"x10 mm - 1/2"x10 mm
	4401T idem maar resistorx



**FOR 4401C**

Bitset 40 delig - plastic koffer  
Jeu de 40 embouts - coffre plastic

17430 04 tot 12	Inbus 4-5-6-7-8-10-12 mm (30 mm L)
17475 04 tot 12	4-5-6-7-8-10-12 mm (75 mm L)
17630 20 tot 55	Torx T20-T25T-30T-40-T45-T50-T55 mm (30 mm L)
17675 20 tot 55	T20-T25-T30-T40-T45-T50-T55 (75 mm L)
17830 05..12	XZN M5-M6-M8-M10-M12 (30 mm L)
17875 05..12	XZN M5-M6-M8-M10-M12 (75 mm L)
810 37..47	bit houder 3/8"x10 mm - 1/2"x10 mm



**FOR T4583**

TC module 58 dlj bit-torx set  
Module 58 pcs embouts - douilles torx

17430 04 tot 12	Inbus 4-5-6-7-8-10-12 mm (30 mm L)
17475 04 tot 12	Inbus 4-5-6-7-8-10-12 mm (75 mm L)
17630 20 tot 55	Torx T20-T25T-30T-40-T45-T50-T55 mm (30 mm L)
17675 20 tot 55	Torx T20-T25-T30-T40-T45-T50-T55 (75 mm L)
17830 05..12	XZN M5-M6-M8-M10-M12 (30 mm L)
17875 05..12	XZN M5-M6-M8-M10-M12 (75 mm L)
810 37-81047	bit houder 3/8"x10 mm - 1/2"x10 mm
torx doppen	E8-E10-E11-E12-E14-E16-E18-E20-E22-E24





Art.nr	mm	L mm
FOR 1743004	4	30
FOR 1743005	5	30
FOR 1743006	6	30
FOR 1743007	7	30
FOR 1743008	8	30
FOR 1743010	10	30
FOR 1743012	12	30
FOR 1743014	14	30
FOR 1747504	4	75
FOR 1747505	5	75
FOR 1747506	6	75
FOR 1747507	7	75
FOR 1747508	8	75
FOR 1747510	10	75
FOR 1747512	12	75

**Inbus**



Art.nr	mm	L mm
FOR 1763020	T20	30
FOR 1763025	T25	30
FOR 1763027	T27	30
FOR 1763030	T30	30
FOR 1763040	T40	30
FOR 1763045	T45	30
FOR 1763050	T50	30
FOR 1763055	T55	30
FOR 1763060	T60	30
FOR 1767520	T20	75
FOR 1767525	T25	75
FOR 1767527	T27	75
FOR 1767530	T30	75
FOR 1767540	T40	75
FOR 1767545	T45	75
FOR 1767550	T50	75
FOR 1767555	T55	75
FOR 1767560	T60	75
FOR 17611555	T55	115
FOR 17612040	T40	120
FOR 17612050	T50	120
FOR 17612055	T55	120

**Torx**



Art.nr	mm	L mm
FOR 1967560	T60	75
FOR 1967570	T70	75

**Torx bits 14 mm  
Embouts 14 mm**



Art.nr	mm	L mm
FOR 1773010	T10H	30
FOR 1773015	T15H	30
FOR 1773020	T20H	30
FOR 1773025	T25H	30
FOR 1773027	T27H	30
FOR 1773030	T30H	30
FOR 1773040	T40H	30
FOR 1773045	T45H	30
FOR 1773050	T50H	30
FOR 1773055	T55H	30
FOR 1773060	T60H	30
FOR 1777510	T10H	75
FOR 1777515	T15H	75
FOR 1777520	T20H	75
FOR 1777525	T25H	75
FOR 1777530	T30H	75
FOR 1777540	T40H	75
FOR 1777545	T45H	75
FOR 1777550	T50H	75
FOR 1777555	T55H	75
FOR 1777560	T60H	75

**Resistorx**



Art.nr	mm	L mm
FOR 1783005	M5	30
FOR 1783006	M6	30
FOR 1783008	M8	30
FOR 1783010	M10	30
FOR 1783012	M12	30
FOR 1783014	M14	30
FOR 1787505	M5	75
FOR 1787506	M6	75
FOR 1787508	M8	75
FOR 1787510	M10	75
FOR 1787512	M12	75

**XZN**



Art.nr	mm	L mm
FOR 81037	3/8" x 10 mm	
FOR 81042	1/2" x 1/4"	38
FOR 81045	1/2" x 5/16	38
FOR 81047	1/2" x 10 mm	38
FOR 810414	1/2" x 14 mm	38

**Bit houder  
Porte-embouts**





	Inbus L sleutels- clés mâles	198	
	Inbus L sleutels met bolkop clés mâles à tête sphérique	200	
	Torx L sleutels - clés mâles torx	202	
	Inbus L handvat - clés mâles à poignée L	204	
	Inbus op T handvat - clés mâles à poignée L	205	
	Torx op T handvat - clés à poignée T en torx	205	
	Resistorx L handvat - clés à poignée L resistorx	207	







Art.nr	mm	L mm	L mm
FOR 7640127	1,27mm	13	41
FOR 764015	1,5 mm	14	45
FOR 76402	2 mm	16	50
FOR 764025	2,5 mm	18	56
FOR 76403	3 mm	20	63
FOR 76404	4 mm	25	70
FOR 76405	5 mm	28	80
FOR 76406	6 mm	32	90
FOR 76407	7 mm	34	95
FOR 76408	8 mm	36	100
FOR 76410	10 mm	40	112
FOR 76411	11 mm	45	125
FOR 76412	12 mm	45	125
FOR 76413	13 mm	50	132
FOR 76414	14 mm	56	140
FOR 76417	17 mm	63	160
FOR 76419	19 mm	70	180
FOR 76422	22 mm	80	200

### Haakse inbusleutel Clés mâles 6 pans



Art.nr	mm	L mm	L mm
FOR 764015L	1,5 mm	15	74
FOR 76402L	2 mm	16	80
FOR 764025L	2,5 mm	18	87
FOR 76403L	3 mm	20	96
FOR 76404L	4 mm	24	107
FOR 76405L	5 mm	28	120
FOR 76406L	6 mm	32	136
FOR 76407L	7 mm	34	145
FOR 76408L	8 mm	36	154
FOR 76410L	10 mm	40	172

### Haakse inbusleutel lang Clés mâles longues 6 pans



Art.nr	mm	L mm	L mm
FOR 7640127XL	1,27 mm	12	80
FOR 764015XL	1,5 mm	14	90
FOR 76402XL	2 mm	16	100
FOR 764025XL	2,5 mm	18	112
FOR 76403XL	3 mm	20	126
FOR 76404XL	4 mm	25	140
FOR 76405XL	5 mm	28	160
FOR 76406XL	6 mm	32	180
FOR 76407XL	7 mm	34	190
FOR 76408XL	8 mm	36	200
FOR 76410XL	10 mm	40	224
FOR 76412XL	12 mm	45	250
FOR 76413XL	13 mm	50	260
FOR 76414XL	14 mm	56	280
FOR 76417XL	17 mm	63	320
FOR 76419XL	19 mm	70	360
FOR 76422XL	22 mm	80	200

### Haakse inbusleutel extra lang Clés mâles extra longues 6 pans



#### FOR 5102

Inbusleutelset kort 10 delig plastic houder  
Jeu de 10 clés mâles 6 pans

764 0127...10	1,27-1,5-2-2,5-3-4-5-6-8-10 mm
---------------	--------------------------------



#### FOR 5072XL

Inbusleutelset lang 7 delig plastic houder  
Jeu de 7 clés mâles longues 6 pans

764 025XL...10XL	2,5-3-4-5-6-8-10 mm
------------------	---------------------



#### FOR 5093XL

Inbusleutelset lang 9 delig plastic houder  
Jeu de 9 clés mâles longues 6 pans

764 015XL...10XL	1,5-2-2,5-3-4-5-6-8-10 mm
------------------	---------------------------



#### FOR 5102XL

Inbusleutelset lang 10 delig plastic houder  
Jeu de 10 clés mâles longues 6 pans

764 0127XL...10XL	1,27-1,5-2-2,5-3-4-5-6-8-10 mm
-------------------	--------------------------------



#### FOR 5137XL

Inbusleutelset lange 13 delig plastic houder  
Jeu de 13 clés mâles longues 6 pans

764 02XL...19XL	2-2,5-3-4-5-6-7-8-10-12-14-17-19 mm
-----------------	-------------------------------------



#### FOR 5137XLS

Inbusleutelset lange 13 delig plastic houder  
Jeu de 13 clés mâles longues 6 pans



764 1.16XL...3.4XL	1/16"-5/64"-3/32"-1/8"-5/32"-3/16"-1/4"-5/16"-3/8"-1/2"-9/16"-5/8"-3/4"
--------------------	---

#### FOR 5137S

Inbusleutelset 13 delig plastic houder  
Jeu de 13 clés mâles 6 pans



764 1.16...3.4	1/16"-5/64"-3/32"-1/8"-5/32"-3/16"-1/4"-5/16"-3/8"-1/2"-9/16"-5/8"-3/4"
----------------	---





Art.nr	mm	L mm	L mm
FOR 765012L	1.27 mm	14	68
FOR 765015L	1.5 mm	15	74
FOR 76502L	2 mm	16	80
FOR 765025L	2.5 mm	18	87
FOR 76503L	3 mm	20	96
FOR 76504L	4 mm	24	107
FOR 76505L	5 mm	28	120
FOR 76506L	6 mm	32	136
FOR 76507L	7 mm	34	145
FOR 76508L	8 mm	36	154
FOR 76510L	10 mm	40	172
FOR 76512L	12 mm	45	190

**Haakse inbussleutel met kogelkop**  
*Clés mâles avec tête sphérique 6 pans*



Art.nr	mm	L mm	L mm
FOR 7650127XL	1.27 mm	12	80
FOR 765015XL	1.5 mm	14	90
FOR 76502XL	2 mm	16	100
FOR 765025XL	2.5 mm	18	112
FOR 76503XL	3 mm	20	126
FOR 76504XL	4 mm	25	140
FOR 76505XL	5 mm	28	160
FOR 76506XL	6 mm	32	180
FOR 76508XL	8 mm	36	200
FOR 76510XL	10 mm	40	224

**Haakse inbussleutel met kogelkop**  
*Clés mâles avec tête sphérique 6 pans*



**FOR 5102LB**

Inbussleutelset kogelkop 10 delig  
*Jeu de 10 clés mâles tête sphérique*

765 0127L.....10L	1.27-1.5-2-2.5-3-4-5-6-8-10 mm
-------------------	--------------------------------



**FOR 5072LB**

Inbussleutelset lang kogelkop 7 delig  
*Jeu de 7 clés mâles longues tête sphérique*

765 025L.....10L	2.5-3 -4-5-6-8-10 mm
------------------	----------------------



**FOR 5072XLB**

Inbussleutelset extra lang kogelkop 7 delig  
*Jeu de 7 clés mâles extra longues tête sphérique*

765 025XL.....10XL	2.5-3-4-5-6-8-10 mm
--------------------	---------------------



**FOR 5072XLB5**

Inbussleutelset kogelkop 7 delig  
*Jeu de 7 clés mâles longues tête sphérique*



765 3.32XL.....3.8XL	3/32"-1/8"-5/32"-3/16"-1/4"-5/16"-3/8"
----------------------	--



**FOR 5093LB**

Inbussleutelset kogelkop lang 9 delig plastic houder  
*Jeu de 9 clés mâles longues tête sphérique*

765 015XL.....10XL	1.5-2-2.5-3-4-5-6-8-10 mm
--------------------	---------------------------



**FOR 5093LB5**

Inbussleutelset kogelkop 9 delig extra lang  
*Jeu de 9 clés mâles longues tête sphérique longues*



765 1.16L.....3.8L	1/16"-5/64"-3/32"-1/8"-5/32"-3/16"-1/4"-5/16"-3/8"
--------------------	--



**FOR 5093XLB5**

Inbussleutelset kogelkop 9 delig extra lang  
*Jeu de 9 clés mâles longues tête sphérique longues*



765 1.16XL.....3.8XL	1/16"-5/64"-3/32"-1/8"-5/32"-3/16"-1/4"-5/16"-3/8"
----------------------	--

**FOR 5102XLB**

Inbussleutelset kogelkop lang 10 delig plastic houder  
*Jeu de 10 clés mâles longues tête sphérique*

765 0127XL.....10XL	1.27-1.5-2-2.5-3-4-5-6-8-10 mm
---------------------	--------------------------------



**FOR 5116LB**

Inbussleutelset kogelkop 11 delig  
*Jeu de 11 clés mâles longues à tête sphérique*

765 015L.....12L	1.5-2-2.5-3-4-5-6-7-8-10-12 mm
------------------	--------------------------------







Art.nr	mm	L mm	L mm
FOR 76606	T6	18	64
FOR 76607	T7	19	70
FOR 76608	T8	20	72
FOR 76609	T9	21	75
FOR 76610	T10	21	81
FOR 76615	T15	23	85
FOR 76620	T20	24	89
FOR 76625	T25	24	95
FOR 76627	T27	25	100
FOR 76630	T30	28	112.5
FOR 76640	T40	30	119
FOR 76645	T45	31	128
FOR 76650	T50	34	148
FOR 76655	T55	37	168
FOR 76660	T60	39	185
FOR 76670	T70	43	200
FOR 76680	T80	45	213

## Haakse torx sleutel Clés mâles pour vis Torx



## Haakse Resistorx sleutel Clés mâles pour vis Resistorx

Art.nr	mm	L mm	L mm
FOR 76606L	T6	18	68
FOR 76607L	T7	18	73
FOR 76608L	T8	18	77
FOR 76609L	T9	18	82
FOR 76610L	T10	19	86
FOR 76615L	T15	21	90
FOR 76620L	T20	23	95
FOR 76625L	T25	25	98
FOR 76627L	T27	26	105
FOR 76630L	T30	29	115
FOR 76640L	T40	33	1122
FOR 76645L	T45	36	138
FOR 76650L	T50	40	155
FOR 76655L	T55	45	172
FOR 76660L	T60	52	200

Art.nr	mm	L mm	L mm
FOR 76706L	T6H	21	68
FOR 76707L	T7H	21	73
FOR 76708L	T8H	23	76
FOR 76709L	T9H	23	79
FOR 76710L	T10H	24	85
FOR 76715L	T15H	28	88
FOR 76720L	T20H	29	94
FOR 76725L	T25H	32	98
FOR 76727L	T27H	33	104
FOR 76730L	T30H	32	118
FOR 76740L	T40H	38	126
FOR 76745L	T45H	38	138
FOR 76750L	T50H	42	160
FOR 76755L	T55H	51	178
FOR 76760L	T60H	57	197

## FOR 5083F

Torx sleutelset in boekvorm 8 delig  
Jeu de 8 clés torx

766 10...40 T9-T10-T15-T20-T25-T27-T30-T40



## FOR 5098LB

L torx + torx met bolkop 9 delig  
Jeu de 9 clés pour vis torx + avec tête sphérique

766 10BL...50BL T10-T15-T20-T25-T27-T30-T40-T45-T50



## FOR 5151

L torx sleutelset 15 delig  
Jeu de 15 clés mâles pour vis torx

766 06...60 T6-T7-T8-T9-T10-T15-T20-T25-T27-T30-T40-T45-T50-T55-T60



## FOR 5151L

L torx sleutelset lang 15 delig  
Jeu de 15 clés pour vis torx longues

766 06L...60L T6-T7-T8-T9-T10-T15-T20-T25-T27-T30-T40-T45-T50-T55-T60



## FOR 5098LT

L Resistorx sleutelset lang 9 delig  
Jeu de 9 clés pour vis resistorx longues

767 10H...50H T10H-T15H-T20H-T25H-T27H-T30H-T40H-T45H-T50H



## FOR 5151LT

L Resistorx sleutelset lang 15 delig  
Jeu de 15 clés pour vis resistorx longues

767 06H...60H T8H-T7H-T8H-T9H-T10H-T15H-T20H-T25H-T27H-T30H-T40H-T45H-T50H-T55H-T60H



## FOR 5071

L torx sleutelset 7 delig  
Jeu de 7 clés pour vis torx

766 10...40 T10-T15-T20-T25-T27-T30-T40



Art.nr	mm	L mm kort	L mm lang
FOR 76502G	2 mm	53	126 mm
FOR 765025G	2.5 mm	53	126 mm
FOR 76503G	3 mm	53	126 mm
FOR 76504G	4 mm	68	183 mm
FOR 76505G	5 mm	68	183 mm
FOR 76506G	6 mm	82	240 mm
FOR 76507G	7 mm	82	240 mm
FOR 76508G	8 mm	82	240 mm
FOR 76510G	10 mm	82	240 mm
FOR 76512G	12 mm	82	240 mm
FOR 7655.64G	5/64"	53	126 mm
FOR 7653.32G	3/32"	53	126 mm
FOR 7651.8G	1/8"	68	183 mm
FOR 7655.32G	5/32"	68	183 mm
FOR 7653.16G	3/16"	82	240 mm
FOR 7651.4G	1/4"	82	240 mm
FOR 7655.16G	5/16"	82	240 mm
FOR 7653.8G	3/8"	82	240 mm
FOR 7651.2G	1/2"	82	240 mm

Inbus met kogelkop  
en L grip hendel  
Clés à poignée en "L"  
6 pans tête sphérique



**FOR 5106B**

Inbus + ball point op Lhandvat 10 delig  
Jeu de 10 clés 6 pans à tête sphérique



765 2....12G	2-2.5-3-4-5-6-7-8-10-12 mm
--------------	----------------------------

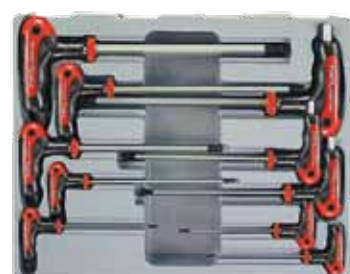

**FOR 50910BS**

Inbus + ball point op L handvat 9 delig  
Jeu de 9 clés 6 pans à tête sphérique



765 5.64.....1.2	5/64"-3/32"-1/8"-5/32"-3/16"-1/4"-5/16"-3/8"-1/2"
------------------	---

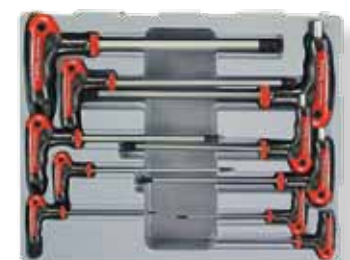

**FOR T50637**

Module Inbus op L handvat 6 delig  
Module de 6 clés 6 pans



765 2....12G	2-3-4-5-6-8 mm
--------------	----------------



**FOR 50912**

T sleutelset inbus 9 delig  
Jeu de 9 clés 6 pans - poignée en T



Art.nr	mm	L mm	L mm breedte
FOR 76402T	2 mm	125 mm	62
FOR 764025T	2.5 mm	125 mm	62
FOR 76403T	3 mm	150 mm	75
FOR 76404T	4 mm	180 mm	90
FOR 76405T	5 mm	180 mm	90
FOR 76406T	6 mm	210 mm	105
FOR 76407T	7 mm	210 mm	105
FOR 76408T	8 mm	250 mm	125
FOR 76410T	10 mm	300 mm	150

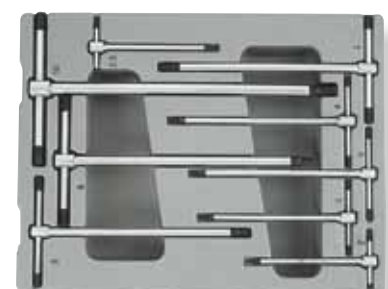

Art.nr	mm	L mm	Totale L mm
FOR 72402	2 mm	100mm	130 mm
FOR 724025	2.5 mm	100mm	130 mm
FOR 72403	3 mm	100mm	130 mm
FOR 72404	4 mm	150mm	185 mm
FOR 72405	5 mm	150mm	185 mm
FOR 72406	6 mm	200mm	240 mm
FOR 72407	7 mm	200mm	240 mm
FOR 72408	8 mm	200mm	240 mm
FOR 72410	10 mm	200mm	240 mm
FOR 72502	2 mm	100mm	130 mm
FOR 725025	2.5 mm	100mm	130 mm
FOR 72503	3 mm	100mm	130 mm
FOR 72504	4 mm	150mm	185 mm
FOR 72505	5 mm	150mm	185 mm
FOR 72506	6 mm	200mm	240 mm
FOR 72507	7 mm	200mm	240 mm
FOR 72508	8 mm	200mm	240 mm
FOR 72510	10 mm	200mm	240 mm

Inbus T grip hendel  
Clés à poignée en "T"  
6 pans



Inbus met kogelkop  
en T grip hendel  
Clés à poignée en "T"  
6 pans tête sphérique

**FOR 2097**

Inbussleutelset op T handvat 9 delig  
Jeu de 9 clés 6 pans - poignée en "T"



724 02....10	2-2.5-3-4-5-6-7-8-10 mm
--------------	-------------------------



**FOR 2097B**

Inbussleutelset met kogelkop T handvat 9 delig  
Jeu de 9 clés 6 pans à tête sphérique



725 02....10	2-2.5-3-4-5-6-7-8-10 mm
--------------	-------------------------



**FOR 2097S**

Inbussleutelset engele maten T handvat 9 delig  
Jeu de 9 clés 6 pans



724 3.32.....3.8	3/32"-7/64"-1/8"-5/32"-3/16"-7/32"-1/4"-5/16"-3/8"
------------------	--





Art.nr	mm	L mm	Totale L mm
FOR 72606	T6	100 mm	130mm
FOR 72607	T7	100 mm	130mm
FOR 72608	T8	100 mm	130mm
FOR 72609	T9	100 mm	130mm
FOR 72610	T10	100 mm	130mm
FOR 72615	T15	100 mm	130mm
FOR 72620	T20	100 mm	135mm
FOR 72625	T25	100 mm	135mm
FOR 72627	T27	200 mm	240mm
FOR 72630	T30	200 mm	240mm
FOR 72640	T40	200 mm	240mm
FOR 72645	T45	200 mm	240mm
FOR 72650	T50	200 mm	240mm
FOR 72655	T55	200 mm	240mm

Art.nr	mm	L mm	Totale L mm
FOR 72706	T6H	100 mm	130mm
FOR 72707	T7H	100 mm	130mm
FOR 72708	T8H	100 mm	130mm
FOR 72709	T9H	100 mm	130mm
FOR 72710	T10H	100 mm	130mm
FOR 72715	T15H	100 mm	130mm
FOR 72720	T20H	100 mm	135mm
FOR 72725	T25H	100 mm	135mm
FOR 72727	T27H	200 mm	240mm
FOR 72730	T30H	200 mm	240mm
FOR 72740	T40H	200 mm	240mm
FOR 72745	T45H	200 mm	240mm
FOR 72750	T50H	200 mm	240mm

### Torx T hendel

#### Clés à poignée "T" torx



### Resistorx T hendel

#### Clés à poignée "T" resistorx



Art.nr	mm	L mm	L mm
FOR 76710G	T10xT10H	53	126
FOR 76715G	T15xT15H	53	126
FOR 76720G	T20xT20H	68	126
FOR 76725G	T25xT25H	68	133
FOR 76727G	T27xT27H	68	133
FOR 76730G	T30xT30H	82	190
FOR 76740G	T40xT40H	82	190
FOR 76745G	T45xT45H	82	190
FOR 76750G	T50xT50H	82	190
FOR 76755G	T55xT55H	82	190

### Torx - Resistorx L hendel

#### Clés à poignée "L" torx - resistorx



## FOR 2141

## FOR 2141T

T hendel torx set 14 delig  
Jeu de 14 clés torx à poignée "T"

726 06...55	T6-T7-T8-T9-T10-T15-T20-T25-T27-T30-T40-T45-T50-T55
2141T	idem maar resistorx



## FOR 51010T

L hendel resistorx set 10 delig  
Jeu de 10 clés resistorx à poignée "T"



767 10G...55G	T10H-T15H-T20H-T25H-T27H-T30H-T40H-T45H-T50H-T55H
---------------	---







**Lange bektang**  
*Pince à becs long*



Art. nr.		mm
FOR 6904160	1000v	160
FOR 6904200	1000v	200

**Kniptang**  
*Pince coupante*



Art. nr.		mm
FOR 6905160	1000v	160 mm
FOR 6911200	1000V	200 mm

**Inwendige borgveertang met rechte bekken**  
*Pince circlips intérieur*



Art. nr.	mm	min-max	
FOR 609ASO	1.8	19-60 mm	150gr
FOR 60909ASO	1.8	40-100 mm	300gr

**Inwendige borgveertang met rechte bekken**  
*Pince circlips intérieur*



Art. nr.	mm	min-max	
FOR 609ASC	1.8	19.60 mm	150gr
FOR 60909ASC	1.8	40.100 mm	300gr

**Universele tang**  
*Pince universelle*

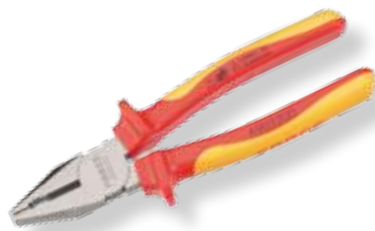

Art. nr.		mm
FOR 6903180	1000v	180 mm

**Striptang**  
*Pince à dénuder*



Art. nr.		mm
FOR 6912160	1000v	160 mm

**Uitwendige borgveertang met 90° bek**  
*Pince circlips extérieur coudé à 90°*



Art. nr.	mm	min-max	
FOR 609ABO	1.8	19.60 mm	150gr
FOR 60909ABO	1.8	40-100 mm	300gr

**Uitwendige borgveertang met 90° bek**  
*Pince circlips extérieur coudé a 90°*



Art. nr.	mm	min-max	
FOR 609ABC	1.8	19.60 mm	150gr
FOR 60909ABC	1.8	40-100 mm	300gr

**Buigtang ronde bekken**  
*Pince à becs ronds*



Art. nr.		mm
FOR 6908160	1000v	160 mm

**Waterpomptang**  
*Pince multiprise*



Art. nr.		mm
FOR 6907250	1000v	250 mm

**FOR T5043A**

TC module 4 borgveertangen  
*TC module 4 pinces circlips*

609ASO	buitenborgveertang met rechte bekken
609ASC	binnenborgveertang met rechte bekken
609ABO	buitenborgveertang met gebogen bekken
609ABC	binnenborgveertang met gebogen bekken

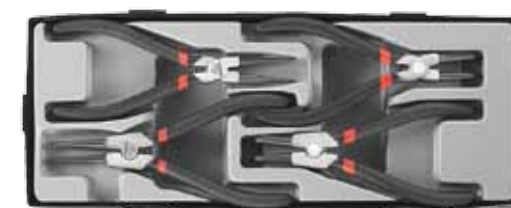

**FOR 920U2**

Borgveertangenset 20 delig  
*Set de pinces circlips 20 pcs*



**Grip tang ronde bek**  
*Pince grip*

Art. nr.	mm		
FOR 614125	125 mm		190gr
FOR 614175	175 mm		370gr
FOR 614250	250 mm		550gr

**Grip tang lange bekken**  
*Pince grip*

Art. nr.	mm		
FOR 615150	150 mm		220gr

**Lange rechte bektang**  
*Pince à becs longues*

Art. nr.	mm		
FOR 5047P1	280		330gr



Art. nr.	mm		
FOR 5047P4	280	4 punts	330gr

**Lange gebogen bektang**  
*Pince à becs longues coudé*

Art. nr.	mm		
FOR 5047P2	280	45°	330gr



Art. nr.	mm		
FOR 5047P3	280	90°	330gr

**C grip tang**  
*Pince-étaux longue portée*

Onmisbaar bij laswerkzaamheden aan wielkasten en vloerplaten

Art. nr.	mm		
FOR 66011			750gr

**Waterpomptang**  
*Pince multiprise*

Art. nr.	mm		
FOR 613B250	250 mm		410gr

**Riveteertang**  
*Pince à riveter*

Art. nr.	mm L		
FOR 67801	180		785gr

**4 in 1 electriciens tang**  
*Pince electriciens*

Art. nr.	mm		
FOR 6921160	160		160gr

**Waterpomptang**  
*Pince multiprise*



Art. nr.	mm		
FOR 613A500	500 mm		1700gr

**Waterpomptang**  
*Pince multiprise*

Art. nr.	mm		
FOR 613410	410 mm		1300gr

**Slangklemtang**  
*Pince pour colliers de serrage*

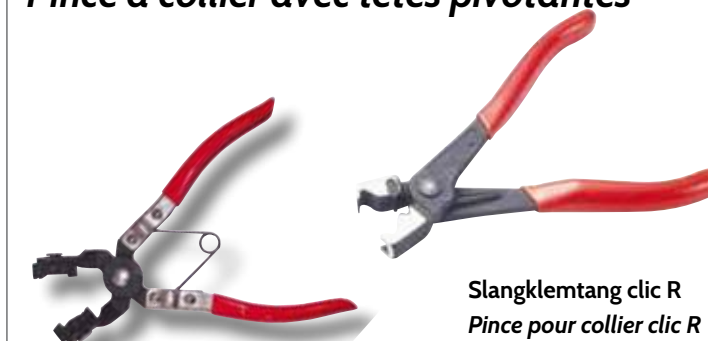
Art. nr.	mm		
FOR 9G0201			

**Gebogen slangklemtang met draibare koppen**  
*Pince à collier avec têtes pivotantes*

Art. nr.			
FOR 9G0109		FOR 9G0104	

Slangklemtang clic R  
*Pince pour collier clic R*



### FOR T5046

TC module 4 tangen  
TC module 4 pincas

610B200	lange bektang, pince à becs long 200 mm
610B200B	gebogen bektang, pince à becs long coudé 200 mm
611B175	universele tang, pince universelle 175 mm
612B175	kniptang, pince coupante 175 mm



### FOR T50814

TC module 8 mini tangen  
TC module 8 pincas mini

50814P1	buigtang ronde bek, becs ronds 125 mm
50814P2	telefoontang, pince à becs longues 125 mm
50814P3	universele tang, pince universelle 125 mm
50814P4	platte bektang, becs plat 125 mm
50814P5	halfronde bektang 150 mm
50814P6	lange gebogen bektang 150 mm
50814P7	kopkniptang, pince coupante 150 mm
50814P8	zijkniptang, pince coupante 150 mm

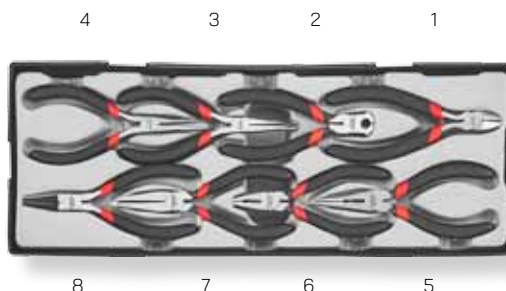

### FOR T5047

TC module 4 lange tangen  
TC module 4 pincas à becs longs

5047P1	extra lange platte bektang 280 mm
5047P2	extra lange platte bektang 45° 280 mm
5047P3	extra lange bektang 90° 280 mm
5047P4	extra lange 4 punts tang 280 mm



### FOR T50410

TC module 4 tangen 1000v  
TC module 4 pincas 1000v

6903180	universele tang, pince universelles 180 mm
6904160	lange bektang, pince à becs long 160 mm
6911200	zijkniptang, pince coupante 200 mm
6912160	striptang, pince à dénuder 160 mm



### FOR T5043A

TC module 4 borgveertangen  
TC module 4 pincas circlips

609ASO	binnenborgveertang met rechte bekken
609ASC	buitenborgveertang met rechte bekken
609ABO	binnenborgveertang met gebogen bekken
609ABC	buitenborgveertang met gebogen bekken



### FOR T5038

TC module met 3 tangen  
TC module 3 pincas

649250B	verstelbare moersleutel, clé à molette 250 mm
613B250	waterpomptang, pince multiprise 250 mm
614250	griptang, pince grip 250 mm



### FOR T51811

TC module riveteertang 181 pcs  
TC module pince à riveter 181 pcs

67801	riveteertang, pince à riveter
51811-1	alu rivetten 4x8
51811-2	alu rivetten 4x10
51811-3	alu rivetten 4.8x8
51811-4	alu rivetten 4.8x10
51811-5	stalen rivetten 4x7
51811-6	stalen rivetten 4x10



### FOR T5057

TC module 5 tangen multi grip  
TC module 5 pincas etau pour carrossier

67901	platte bektang, mâchoir large et plat
67902	dubbele griptang, double courbe
67903	mâchoir large et courbe
67904	rechthoekige bek, mâchoir à becs
67905	rechte bektang, mâchoir droite



### FOR 909G3

Slangklem tangenset 9 delig  
Set de pincas 9 pcs

- 1 x Slangklemtang Bowden, op afstand bedienbaar met Bowdenkabel voor verende slangklemmen van 18-54 mm
- 1 x Slangklemtang met "+" bek
- 1 x Slangklemtang met "U" bek
- 1 x Slangklemtang voor draadveerklemmen
- 1 x Slangklemtang gebogen voor draadveerklemmen
- 1 x Slangklemtang CLIC-R
- 1 x Slangklemtang voor ashoes slangklemmen



**Hamers - zagen - boren - knippen - Scie - marteau -**

	Beitel-doorslagen sets - jeu de burins & chase-goupilles	216
	Pendrijvers - chasse goupilles	216
	Beitels - burins	216
	Doorslagen - burins pointeau	216
	Hamers - marteaux	219
	Tappensets jeu de tarauds	220
	Boren - mèches	221
	Meetgereedschap - mesurer	222
	Snijgereedschap - couper	224
	Vijlen - limes	225
	Knippen - pince coupe	226
	Pijptangen - clés serre tube	227

**FOR 5054**
**Beitel pendrijvers set 5 delig**  
*Jeu de burins 5pcs*

60212150	beitel 12 (150mmL)
603150	kapbeitel (150mmL)
6044190	pendrijver 4 (190mmL)
6063185	doorslag 3 (185mmL)
6074185	centerpunt 4 (185mmL)

**FOR 50613**
**Pendrijvers 6 delig**  
*Jeu de 6 chasse-goupilles*

604 2140	2 mm (140 mm L)
604 3150	3 mm (150 mm L)
604 4190	4 mm (190 mm L)
604 5200	5 mm (200 mm L)
604 6210	6 mm (210 mm L)
604 8215	8 mm (215 mm L)

**FOR 50511**
**Centerpuntset 5 delig**  
*Jeu de 5 pointeaus*

60725185	2,5 (185mm L)
6074185	4 (185mm L)
6076185	6 (185mm L)
6078185	8 (185mm L)
60710185	10 (185mm L)

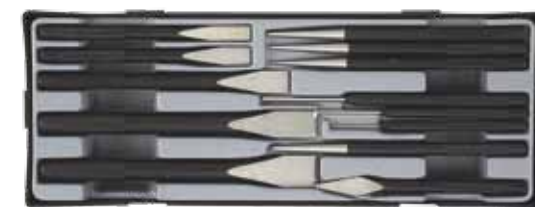

**Beitels-doorslag - Burins**
**FOR T5131**
**TC module 13 beitels & doorslagen**  
*TC module 13 burins chasse-goupilles*

602 10150	beitel, burin 10 (150 mm L)
602 12150	beitel, burin 12 (150 mm L)
602 15180	beitel, burin 15 (180 mm L)
602 19200	beitel, burin 19 (200 mm L)
602 22200	beitel, burin 22 (200 mm L)
603150	kapbeitel, bedane150 mm L
604 2140 - 6043150	doorslag, chasse -goupille 2 (140 mm L) 3 (150 mm L)
604 4190	doorslag, chasse-goupille 4 (190 mm L)
606 2185 - 6063185	beitel plat, burin plat 2 (185 mm L) 3 (185 mm L)
606 4185	beitel plat, burin plat 4 (185 mm L)
6074185	puntslag 4 (185 mm L) pointeau

**FOR T51229**

**TC module 19 beitels & doorslagen**  
*TC module 19 burins chasse-goupilles*

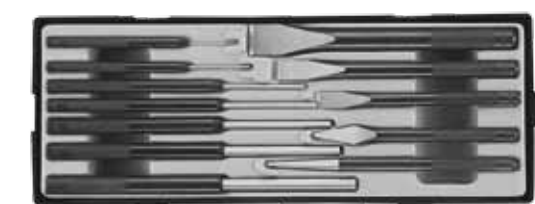
602 12150	beitel, burin 12 (150 mm L)
602 15180	beitel, burin 15 (180 mm L)
602 22200	beitel, burin 22 (200 mm L)
603150	kapbeitel, bedane150 mm L
604 2140 - 6043150	pendrijver, chasse -goupille 2 (140 mm L) 3 (150 mm L)
604 4190 - 6045200	doorslag, chasse-goupille 4 (190 mm L) 5 (200mmL)
6046210-6048215	pendrijver 6 (210mmL) - 8 (215mmL)
60410230	pendrijver 10 (230mmL)
6074185	puntslag 4 (185 mm L) pointeau

**FOR T5053**
**TC module beitel & hamers 5 delig**  
*TC module burins-marteaux 5 pcs*

616300	hamer, marteau 300 gr
616400	rubber hamer, marteau chaoutchouc 400 gr
60215180	beitel, burin 15 (180 mm L)
60219180	beitel, burin 19 (180 mm L)
60225220	beitel, burin 25 (220 mm L)

**FOR 5138**
**Beitel-penuitdrijverset bekleed 13 delig**  
*Burins-chasse goupilles 13 pcs avec protection*

604 2140Q	doorslag, chasse-goupilles 2 (140 mm L)
604 3150Q	doorslag, chasse-goupilles 3 (150 mm L)
604 4190Q	doorslag, chasse-goupilles 4 (190 mm L)
604 5200Q	doorslag, chasse-goupilles 5 (200 mm L)
604 6210Q	doorslag, chasse-goupilles 6 (2 10 mm L)
604 8215Q	doorslag, chasse-goupilles 8 (215 mm L)
604 10230Q	doorslag, chasse-goupilles 10 (230 mm L)
604 12280Q	doorslag, chasse-goupilles 12 (280 mm L)
604 14290Q	doorslag, chasse-goupilles14 (290 mm L)
606 4185Q	drevel, pointeau 4 (185 mm L)
606 5185Q	drevel, pointeau 5 (185 mm L)
606 6185Q	drevel, pointeau 6 (185 mm L)
6076185Q	center punt, chasse-goupilles centre 6 (185 mm L)





**Pendrijvers**  
*Chasse-goupilles*



Art. nr.		Lmm
FOR 6042140	2 mm	140 mm
FOR 6043150	3 mm	150 mm
FOR 6044190	4 mm	190 mm
FOR 6045200	5 mm	200 mm
FOR 6046210	6 mm	210 mm
FOR 6048215	8 mm	215 mm
FOR 60410230	10 mm	230 mm
FOR 60412280	12 mm	280 mm
FOR 60414290	14 mm	290 mm
FOR 60416310	16 mm	310 mm

**Pendrijvers bekleed**  
*Chasse-goupilles gainés*



Art. nr.		Lmm
FOR 6042140Q	2 mm	140 mm
FOR 6043150Q	3 mm	150 mm
FOR 6044190Q	4 mm	190 mm
FOR 6045200Q	5 mm	200 mm
FOR 6046210Q	6 mm	210 mm
FOR 6048215Q	8 mm	215 mm
FOR 60410230Q	10 mm	230 mm
FOR 60412280Q	12 mm	280 mm
FOR 60414290Q	14 mm	290 mm

**Beitels**  
*Burins*



Art. nr.		Lmm
FOR 60210150	10	150 mm
FOR 60212150	12	150 mm
FOR 60215180	15	180 mm
FOR 60219200	19	200 mm
FOR 60222200	22	200 mm
FOR 60225220	25	220 mm

**Beitels bekleed**  
*Burins gainés*



Art. nr.		Lmm
FOR60212150Q	12	150 mm
FOR 60215180Q	15	180 mm
FOR 60219200Q	19	200 mm
FOR 60222200Q	22	220 mm

**Doorslag**  
*Burins pointeau*



Art. nr.		Lmm
FOR 6062185	2	185 mm
FOR 6063185	3	185 mm
FOR 6064185	4	185 mm
FOR 6065185	5	185 mm
FOR 6066185	6	185 mm

**Doorslag bekleed**  
*Burins pointeau gainés*



Art. nr.		Lmm
FOR 6064185Q	4	185 mm
FOR 6065185Q	5	185 mm
FOR 6066185Q	6	185 mm

**Kapbeitel**  
*Bédane*



Art. nr.		Lmm
FOR 603150		150 mm

**Centerpunt**  
*Pointeau*



Art. nr.	mm	L mm
FOR 60725185	2.5	185 mm
FOR 6074185	4	185 mm
FOR 6076185	6	185 mm
FOR 6076185Q	6	185 mm

**Bankhamer met houten steel**  
*Marteaux de mécanicien manche en bois*



Art. nr.		
FOR 616300	300 gr	
FOR 616500	500 gr	
FOR 6161000	1000 gr	
FOR 6161500	1500 gr	

**Blokkhamer met houten steel**  
*Massette manche en bois*



Art. nr.		mm L
FOR 616G1250	1250 gr	260
FOR 616G1500	1500 gr	280

**Rubber hamer**  
*Maillets anti-rebond*



Art. nr.		mm L	totaal gewicht
616400	400 gr	280	520gr
616580	580 gr	300	690gr
616800	810 gr	300	940gr

**Kunststof hamer met verwisselbare hamerdoppen**  
*Massettes à embouts interchangeables*



Art. nr.		mm
FOR 616A035	505gr	35 mm

**Kunststof hamer houten steel**  
*Marteaux*



Art. nr.		
FOR 616A400		400gr



### ZA T110 1

Tap- en kussenset metric 110 delig  
Jeu de tarauds et de filières 110 pcs

M2x0.4	M10x0.75	M14x1.0
M3x0.5	M10x1.0	M14x1.25
M4x0.7	M10x1.25	M14x1.5
M5x0.8	M10x1.5	M14x2.0
M6X0.75	M11x0.75	M16x1.0
M6x1.0	M11x1.0	M16x1.5
M7X0.75	M11x1.25	M16x2.0
M7x1.0	M11x1.5	M18x1.5
M8x1.0	M12x0.75	2 kussen wringijzer, porte filère
M8x1.25	M12x1.0	2 tappen wringijzer
M9x0.75	M12x1.25	1 T tapkrukatel
M9x1.0	M12x1.5	
M9x1.25	M12x1.75	



Wringijzer voor tappen verstelbaar  
Tourne à gauche pour tarauds



Wringijzer voor snijkussens  
Porte-filières



Art. nr.		lengte
FOR 881A13	M5-M13	275mmL
ZA ET110W1	M6-M20	380mmL
ZA ET110W1 2	M8-M25	480mmL
ZA ETN1	Tourne à gauche	T

Art. nr.		lengte	
ZA ET110W25	25x9		
ZA ET110W38	38x14		

### FOR 63005

Linkse tappenset 5 dlg  
Extracteurs de vis en jeux 5pcs

1/8" (M3) tot 1/4" (M6)
1/4" (M6 tot 5/16" (M8)
5/16" (M8) tot 7/16" (M11)
7/16" (M11) tot 9/16" (M14)
9/16" (M14) tot 3/4" (M18)



### ZA COBALT 19

Cobalt borensset 1-13 mm 25 delig  
Jeu de mèches cobalt 1-13 mm 25 pcs



### ZA HSS170

Borensset 170 delig  
Jeu de mèches 170 pcs



### ZA STI

V coil schroefdraad reparatieset  
Jeu de réparations de filets C-coil  
- M5-M12





## FOR T5096

TC module meet en aftekeningereedschap 9 delig  
TC module 9 outils de mesure et traçage

FOR 5096P1	universele schuifmaat, pied à coulisse
FOR 5096P2	center punt, pointeau
FOR 5096P3	liniaal 30 cm, règle métal 30cm
FOR 5096P4	hoek meter, rapporteur inox
FOR 5096P5	voelermaatjes 0.25-6, jauge d'épaisseur
FOR 5096P6	voelermaatjes 4-62 SAE, jauge d'épaisseur
FOR 61802	voelermaatjes SAE-metric, jauge d'épaisseur
FOR 5096P7	stalen kraspen, pointe à tracer
FOR 5096P8	meter 5m, mètre à ruban



## FOR 5096P1

Universele schuifmaat metaal  
Pied à coulisse



## FOR 5096P2

Center punt  
Pointeau



## FOR 5096P3

Liniaal 30cm  
Rèfle métal 30cm



## FOR 5096P4

Metalen hoekmeter  
Rapporteur inox



## FOR 5096P5

Voelermaatjes 0.25-6 mm  
Jauge d'épaisseur

## FOR 5096P6

Voelermaatjes 4-62 SAE  
Jauge d'épaisseur



## FOR 618

Voelermaatjes 0.05mm tot 1.00mm  
Jauge d'épaisseur

## FOR 61802

Voelermaatjes 0.04mm tot 0.63mm  
Jauge d'épaisseur



## FOR 5096P7

Stalen kraspen  
Pointe à tracer



## FOR 5096P803

Rolmeter 3 meter in ABS huis  
- met blokkering  
Mètre à ruban 3m  
- avec blocage



## FOR 5096P8

Rolmeter 5 meter in ABS huis  
- met blokkering  
Mètre à ruban 5m



## FOR 5096A805

Rolmeter 5 meter in ABS huis  
- met blokkering  
Mètre à ruban 5m boîtier ABS  
- antichoc bi-matières ruban en acier



## FOR T5055

TC module 5 delig snijgereedschap  
TC module 5 d'outils à couper

FOR 5055P1	schaar, ciseau
FOR 66302	mini hakzaag, scie mini
FOR 5055P3	2 zaagbladen, lame de reserve
FOR 5055P4	cuttermes, couteau



## FOR 5055P4

Universeel veiligheidsmes  
Cutter à lames

## FOR 5055P4P

Reserve mesjes (5 stuks)  
Lames (5 pcs)



## FOR 66302

Mini zaagbeugel  
Scie mini

Gemaakt van lichtgewicht, sterk aluminium met zacht kunststof handgreep. Het zaagblad is verstelbaar onder 6 hoeken. Eenvoudige zaagblad wisseling. Op deze ijzerzaag passen standaard zaagbladen. Geschikt voor metaal, hout en plastic. Zaagbladlengte 150 mm.



## FOR 5055P3

Reservezaagje  
Lame

## FOR 66301

Zaagbeugel metaalzaag  
Monture de scie à métaux

Geschikt voor metaal, hout en plastic, met ergonomische handgreep en snelwissel-systeem.



## FOR 66303

Zaagbeugel metaalzaag 135mm  
Scie 135mm

Kleine, compacte metaalzaag voor werkzaamheden op moeilijk bereikbare plaatsen (bv. glad afzagen van pijpen, schroeven, enz.) Aluminium frame met 2-componenten-handgreep.



## FOR 5055P1

Metaalschaar 51mm  
Cisaille pour metal

"Heavy-Duty" metaalschaar met gehard stalen bladen en een kniplengte van 51 mm. Geschikt voor het knippen van dun ferro en non-ferro plaatstaal. Dubbel gedompelde zachte grip. Lengte schaar 254 mm.



## FOR 6982

Beklede electricien schaar  
Ciseaux universel d'atelier

Elektricien schaar met zacht TPR rubberen handgrepen en een smalle inkeping in het blad voor draadstrippen. Precies geslepen om zuiver en zonder te slippen te snijden.



## FOR T5056

TC module 5 vijlen  
TC module 5 limes

FOR 5056P1	platte vijl, lime plat
FOR 5056P2	half ronde vijl, lime demi ronde
FOR 5056P3	ronde vijl, lime ronde
FOR 5056P4	vierkante vijl, lime carré
FOR 5056P5	driehoek vijl, lime triangulaire





## Boutenschaar Coupe boulon bras forgé

Art. nr.		mm	
FOR 9U050118	18"	455 mm L	1613gr
FOR 9U050124	24"	610 mm L	2375gr
FOR 9U050136	36"	863 mm L	6080gr



### FOR 6923160

#### Kabel kniptang 160mmL

##### Pince coupe-câbles

Robuuste kabelschaar voor dagelijks gebruik door de professionele gebruiker. De schaar knipt kabels eenvoudig en zuiver door zonder de kabel te vervormen. Geschikt voor o.a. kabelstrengen van gevlochten 2/0 koperdraad en gevlochten 4/0 aluminium draad. Niet geschikt voor gewapende kabelbundels (ACSR) en niet voor staal.



### FOR 6924250

#### Kabel kniptang 250mmL

##### Pince coupe-câbles

### FOR 65607

#### Kunststof leidingschaar 42 mm

##### Coupe-tube PVC à cliquet pour tubes plastiques



### FOR 65601

#### Telescopische pijpsnijder 3-29 mm

##### Coupe-tubes 3-29 mm



### FOR 65602

#### Mini telescopische pijpsnijder 3-22 mm

##### Coupe-tubes mini 3-22 mm



## Pijptangen - alu Clés serre-tubes

Art. nr.			
ZA GD-113-18		450 mm	1500gr



## Pijptangen model Stillson Clés serre-tubes modèle Stillson

Art. nr.	cap	L mm	gewicht/poids
FOR 68414	0 - 60mm	355mm	1340gr
FOR 68424	0 - 89mm	610mm	3670gr
FOR 68436	0 - 140mm	863mm	8340gr
FOR 68448	0 - 165mm	1220 mm	12000gr



Bijzonder robuuste pijptang van gietijzer model "Stillson" met geharde vertanding. Klemt goed vast door nauwkeurige afwerking van schroefdraad en rol, ligt goed in de hand

### FOR 684C17

#### Pijpsleutel 440mmL 1 1/2"

##### Clé serre-tubes 440mmL 1 1/2"

Verstelbare pijptang gemaakt van Chroom Vanadium staal, gesmeed en gehard en bevat inductie geharde tanden. De S-bek zorgt voor klemming op drie punten en een betere krachtoverbrenging. Uitgerust met klembeveiliging.

Force clé serre-tube suédoises forme S en acier Chrome Vanadium forgée en renforcée avec denture trempée par induction. Mâchoires parallèles étroites et biseautées pour l'accroche idéale des différents tubes et pièces. Denture orientée dans le sens inverse de la rotation. Serrage sur trois points sur le tube, autobloquante. Bague de fixation imperdable. Laquage électrostatique rouge, mâchoires polies.



### FOR 6957240

#### Griptang 240mmL

##### Pince grip 240mmL





Hoe werkt een assteun:

Eerst lift u uw auto omhoog door middel van een autokrik. Eenmaal op juiste hoogte plaatst u de assteun onder de auto, hierdoor rust de auto nu op de assteun in plaats van de krik. De volgende stap is om de assteun, door middel van het blokkeersysteem, extra te beveiligen. De autokrik rolt u vervolgens onder de auto vandaan en klaar! Het is nu tijd om uw schoonmaak- en of reparatiewerkzaamheden uit te voeren.

Let op: U gebruikt uw assteunen niet om uw voertuig te liften, dit doet u met een autokrik. De assteunen dienen puur ter ondersteuning, dit zorgt voor meer veiligheid en zekerheid.

### TRI T42001C

Verstelbare assteunen 2 ton (per paar) met veiligheidspin  
Set de 2 chandelles 2 ton

	hoogte/haut	gewicht/poids
Min	278 mm	
Max	420 mm	5.5 kg



### TRI T43001C

Verstelbare assteunen 3 ton (per paar) met veiligheidspin  
Set de chandelles 3 ton

	hoogte/haut	gewicht/poids
Min	288 mm	
Max	425 mm	7 kg



### TRI T46001C

Verstelbare assteunen 6 ton met veiligheidspin (per paar)  
Set de chandelles 6 ton

	hoogte/haut	gewicht/poids
Min	395 mm	
Max	605 mm	13.2 kg



### TRI T90504

Fleskrik 5 ton  
Cric bouteille 5 ton

### TRI BJ1001

Fleskrik 10 ton  
Cric bouteille 10 ton

### TRI TL3420E

Fleskrik 20 ton  
Cric bouteille 20 ton

	Min hoogte/haut.	Max
TRI T90504	210 mm	415 mm
TRI BJ1001	230 mm	
TRI TL3420E	242 mm	452 mm



	Werkplaatsinrichting - garage equipment	229
	Vervangen filters - huile	236
	Ontsteking brandstof - allumage carburant	244
	Blokkeergereedschap - outils de calage	248
	Motor - moteur	258
	Remmen - freins	264
	Wielen - roues	270
	Trekkers - extracteurs	276
	Carrosserie	284
	Allerlei - magneten - aimant	288
	Koevoeten - leviers	287
	Electriciteit	291
	Led lampen - lampes led	298
	Omvormers - converteurs	299
	Boosters	300





### TRI 60205

Garagekrik 2 ton met garage stand & wielblokkeerset  
Cric rouleurs 2 ton avec chandelles & arrêts

	hoogte/haut	gewicht/poids
<b>Min</b>	140 mm	
<b>Max</b>	340 mm	8.7 kg



### TRI T82000D

Garagekrik 2 ton  
Cric rouleurs 2 ton

	hoogte/haut	gewicht/poids
<b>Min</b>	130 mm	
<b>Max</b>	340 mm	9.1 kg



### TRI T82007

Garagekrik 2 ton  
Cric rouleurs 2 ton

	hoogte/haut	gewicht/poids
<b>Min</b>	130 mm	
<b>Max</b>	350 mm	11 kg



### TRI TL1531B

Garage krik 3 ton met quick lift dubbele pomp  
Cric rouleurs 3 ton avec pédale "quick lift" pompe double

	hoogte/haut	gewicht/poids
<b>Min</b>	140 mm	
<b>Max</b>	490 mm	33 kg



### TRI TL1537

Garagekrik 3 "low profile" quick lift met dubbele pomp  
Cric rouleurs 3 ton extra bas pompe double

	hoogte/haut	gewicht/poids
<b>Min</b>	90 mm	
<b>Max</b>	460 mm	35.5kg



### TRI TLA2022

Garagekrik pneumatisch 22 ton air pressure 0.7-1.0  
Cric hydropneumatique 22 ton

	hoogte/haut	gewicht/poids
<b>Min</b>	210	45kg
<b>Max</b>	525	



**TRI T24541**

Motorsteun 500 kg  
Support moteur sur roues pivotant 500 kg

	Cap.	gewicht/poids
	500kg	21 kg

**TRI TR4056**

Transmissiekrik 500 kg met voetbediening  
Vérin de fosse 500 kg

	hoogte/haut	gewicht/poids
<b>Min</b>	1140 mm	
<b>Max</b>	1925 mm	32 kg

**TRI TL9320**

Werkplaatskraan 2 ton plooibaar  
Grue d'atelier pliable 2 ton pliable

	hoogte	gewicht/poids
<b>Lifting</b>	100-2200 mm	83 kg

**TRI TL9901**

Motorhanger 680 kg voor het uitbalanceren van lasten op takels en kranen  
Palonnier pour moteur basculante 680 kg

	Afm.	gewicht/poids
	445x64x190 mm	5.5 kg

**TRI TW05001**

Motorhouder 500 kg  
Support moteur 500 kg

		gewicht/poids
<b>Lengte</b>	1500 mm	22 kg
<b>Afm</b>	1540x150x110 mm	

**TRI TR8485**

Keldervijzel 48"  
Cric mécanique 48"

	hoogte	gewicht/poids
<b>Min</b>	154 mm	
<b>Max</b>	1070 mm	14 kg

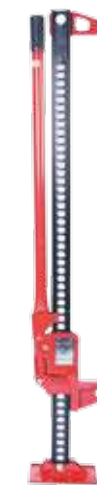
**TRI TA1502**

Buizenplooiër 15 ton  
Pliëur pour tubes 15 ton  
- 1/2"-3/4"-1"-1 1/4"-1 1/2"-2"-2 1/2"-3"  
- 238 mm (9-3/8")

		gewicht/poids
<b>Afm.</b>	800x640x210 mm	57.5 kg

**TRI TRA9012L**

Hydraulische autoverplaatser alu  
Positionneur de véhicule hydraulique alu

		gewicht/poids
<b>Cap</b>	680kg	19.5 kg

**TRI TRF0322**

Autoverplaatser (per paar)  
Positionneur de véhicule (par paire)

		gewicht/poids
<b>Cap</b>	450kg	18kg





### TRI TR6458

Ligbed opplooibaar  
*Courette d'atelier*

		gewicht/poids
1030x407x116 mm		8.4 kg



### TRI TRH6802-3

Ligbed magnetic tray met hoofdkussen  
*Courette d'atelier en plastique*

		gewicht/poids
1010x4475x130 mm		5.4kg



### TRI TR6100

Montagekruk  
*Tabouret de montage*  
108x32.5x49.5cm



### TRI TRT7502

Oprijplaat alu plooibaar 340 kg (per paar)  
*Rampes en alu pliable 340kg (par paire)*

- 226 cm x 29.5 cm
- opgeplooid : 116 cm
- plooibaar, pliable
- gewicht/poids : 7.2kg



### TRI SR801

Aluminium werktrap 200kg  
*Escabeau de travail en alu 200kg*

Afm.	108x32.5x49.5cm
Afm. dicht	80x37.5x15.5cm
gewicht/poids	3.5g
Verpakking	2 ctn
Draagkracht	150kg



### TRI TRT5001

Rubberen wielblok  
*Calle de roue en caoutchouc*



### TRI TD2001G

Set van 2 minibruggen 2 ton  
*Set de 2 rampes 2 ton*

- max band br 185mm

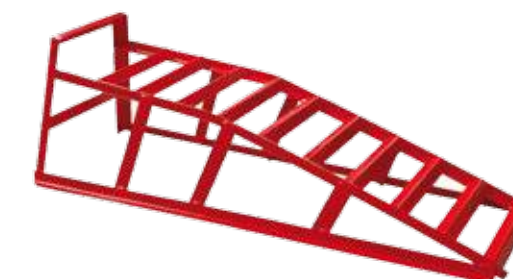

### TRI TRD2005

Mini brug 900x295x220 mm per paar  
*Rampe, plastic par paire*

		gewicht/poids
Cap	1.5 ton	8 kg



**FOR 61904**

**Regelbare oliefiltersleutel**

- Demontage van filters 65 mm - 110 mm

**Clé auto-serrante à 3 bras pour filtre à huile**

Aandrijving met zowel 3/8" als 1/2" ratel of steeksleutel (21 mm) mogelijk.



**FOR 61913**

**Regelbare oliefiltersleutel**

- Demontage van filters 75 mm - 130 mm

**Clé filtre à huile auto-régable**



**FOR 9B0704**

**Oliefiltersleutel 1/2" camion**

- Demontage van filters 95 mm - 165 mm

**Clé filtre à huile camion 1/2"**



**FOR 619**

**Oliefiltersleutel met nylon band**

**Clé à sangle pour filtres à huile**

- Oliefiltersleutel op basis van een kunststof spanband.
- Heeft een sterke hevelwerking en is ideaal als u de omliggende motordelen niet wilt krassen, of als u weinig werkruimte heeft.



**FOR 61908**

**Oliefiltersleutel met rubber band**

- lengte band 500 mm
- cap 160 mm dia

**Clé à sangle pour filtres à huile**



**FOR 61912**



**Oliefiltersleutel met nylon band**

- lengte band 850mm
- lengte handvat 300mm

**Clé à sangle pour filtres à huile nylon**



**FOR 61911**

**Oliefiltersleutel kettingmodel**

- cap 40-120 mm

**Clé à chaîne pour filtres à huile**

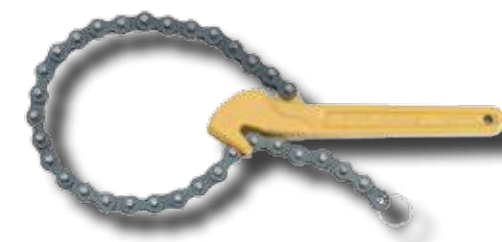

**FOR 61901**

**Oliefiltersleutel kettingmodel**

**Clé à chaîne pour filtres à huile**

- Oliefiltersleutel voor het aan- en afschroeven van oliefilters tot een diameter van 120 mm.
- Met ketting en 1/2" vierkant aansluiting.



**FOR 61910**

**Oliefiltersleutel**

- Demontage van filters 65 mm - 110 mm
- eenhandsbediening
- ook voor moeilijk bereikbare oliefilterbehuizing
- verstellen door draaiknop
- staalband vervangbaar

**Clé filtre à huile**

- demontage filtre 65 mm -110 mm



**FOR 61910L**

**Oliefiltersleutel**

- Demontage van filters 110 mm - 155 mm

**Clé filtre à huile**

**FOR 639250**

**Oliefiltertang 60-90 mm**

**Pince réglable pour filtre à huile 60-90 mm**

**FOR 639300**

**Oliefiltertang 85-115 mm**

**Pince réglable pour filtre à huile 85-115 mm**



**FOR 639365**

**Oliefiltertang 100-140 mm**

**Pince réglable pour filtre à huile 100-140 mm**



### FOR 639230

#### Oliefiltetang

- Demontage van filters 53 mm - 118 mm
- lente : 230 mm

*Pince étau pour filtre à huile*



### FOR 61933

#### Magnetische carterplug sleutel

*Clé magnétique pour bouchon de vidange*

- Met dit handige gereedschap kunt u de carterplug verwijderen zonder de plug of de hete olie met uw handen aan te raken
- Nooit meer olie doordrenkte handschoenen of het laten vallen van de carterplug in de hete olie, eenvoudig de magneet bevestigen aan de vooraf losgedraaide carterplug en draaien om te verwijderen

Geen vieze en verbrande handen meer!



### FOR 61920

#### Oliefilter dopenset 3 dlg 3/8"

*Jeu de 3 clés filtre à huile type choche 3/8"*

- 27 mm, 32 mm, 36 mm
- Mercedes, Vauxhall, Opel, BMW, Ford

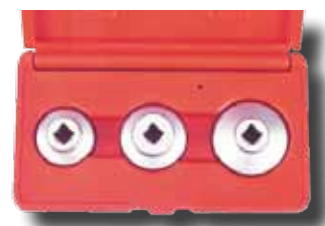

### FOR 61920B

#### Oliefilterdopenset 5 dlg 3/8"

*Jeu de 5 clés à huile tatype choche 3/8"*

- 24 mm, 27 mm, 32 mm, 36 mm, 38 mm
- Cadillac, Mercedes, Vauxhall, Opel, BMW, Ford



### FOR 61936



#### Oliefiltersleutelset 10 delig

*Set clés filtre à huile type cloche 10 pcs*

Geschikt voor montage van oliefilters bij Mercedes, BMW, Volvo, VW, Fiat, Renault, Honda, Mazda, Nissan, Toyota etc.

Inhoud:

- Adapter 1/2" (F) x 3/8" (M)
- Adapter 3/8" (F) x 1/2" (M)
- Oliefilter dop 27mm/6 kant
- Oliefilter dop 32mm/6 kant
- Oliefilter dop 36mm/6 kant
- Oliefilter dop 74mm/14 kant
- Oliefilter dop 76mm/14 kant
- Oliefilter dop 76mm/12 kant
- Oliefilter dop 86mm/16 kant
- Oliefilter dop 93mm/15 kant



### FOR 61915

#### Oliefiltersleutelset 15 delig

- voor losdraaien en vastzetten van oliefilterhuisdeksels
- voor Europese en japanse auto's

*Set clés filtre à huile type cloche 15 pcs*

- voitures Européen et Japonaises



### FOR 61917

#### Oliefiltersleutelset 30 delig

- voor Europese en japanse auto's
- in kunststof koffer

*Set clés filtre à huile type cloche 30 pcs*

- voitures Européen et Japonaises

61915	61917	SW	vlakken
*	*	66 mm	6
*	*	65 mm	4
*	*	65-67 mm	14
*	*	68 mm	14
*	*	73 mm	14
*	*	74 mm	15
*	*	74-76 mm	15
*	*	75-77 mm	15
*	*	76 mm	12
*	*	76 mm	14
*	*	76m	30
*	*	76 mm	8
*	*	78 mm	15
*	*	80 mm	16
*	*	80-32 mm	15
*	*	86 mm	16
*	*	86 mm	18
*	*	90 mm	15
*	*	92 mm	10
*	*	93 mm	15
*	*	93 mm	36
*	*	93 mm	45
*	*	95 mm	15
*	*	96 mm	18
*	*	100 mm	15
*	*	106 mm	15
*	*	108 mm	15
*	*	108 mm	18
*	*	olie filtersleutel	
*	*	adapter	



### FOR 9U0706

**Carterplugsleutel 8 x 10 mm**  
**Clé de vidange 8x10 mm**

- Voor Peugeot, Renault en Volvo carterpluggen in oliecarter en versnellingsbak.
- Ook voor achterassen.



### FOR 5061

**Carterpluggen set 6 delig**  
**Jeu de douilles pour carter 6 pcs**

- 5/16" hex x 3/8" hex, 8 mmSq x 3/8" Sq, 11 mmSq x 12 mmSq, 13 mmSq x 14 mmSq, 17 mmSq x 1/5" HEX, 8 mmHex x 10 mmHex



### FOR T5122

**TC module olie service set 12 delig**  
**TC module de 12 d'outils de graissage**

617	magneet met spiege, miroir
618	voelmaatjes, jauges d'épaisseur 0.05 mm tot 1 mm
619	oliefilter sleutel, clé de filtre d'huile
807416M-807420.6	bougiedop 16 mm & 20.6 mm, douille pour bougie
810421	sleutelhouder 21 mm
carterpluggen	5/16" Hex3/8"Hex, 8 mmx3/8", 11x12 mm 13x14 mm, 17 mmx1/2"H, 8 mm x10 mm



### FOR 964G1

**Herstelkit oliecarterplug 64 delig**  
**Set de révision pour filtrage 64 pcs**

Voor het snel en doeltreffend repareren van ernstig beschadigde olie carter schroefdraad in aluminium oliecarter pannen. Regelmatig komt het voor dat de oorspronkelijke schroefdraad van het olie carter zo ernstig beschadigd is, dat alleen volledig vernieuwen de enige goede oplossing is.

- Draadtap M13 x 1.5 met 5 Carterpluggen en aluminium afdichtringen M13 x 1.5
- Draadtap M15 x 1.5 met 5 Carterpluggen en aluminium afdichtringen M15 x 1.5
- Draadtap M17 x 1.5 met 5 Carterpluggen en aluminium afdichtringen M17 x 1.5
- Draadtap M20 x 1.5 met 5 Carterpluggen en aluminium afdichtringen M20 x 1.5

Geschikt voor Audi, BMW, Citroen, Mercedes-Benz, Ford, Fiat, Honda, Mazda, Mitsubishi, Nissan, Opel, Peugeot, Porsche, Renault, Saab, Seat, Skoda, Toyota, Volvo en VW.



### 1/2" Doppen XZN douilles

FOR 34805514T	- M16 55 mm L	- magnetisch
FOR 34805516T	- M16 55 mm L	- magnetisch
FOR 34810016T	- m16 100 mmL	- magnetisch

- Spline dopsleutel met gat speciaal voor de oliecarterplug op de versnellingsbakken van Audi, Volkswagen, Skoda en Ford.
- Maat: Spline/Veeltand M16 met gat.
- Aansluiting 1/2", lengte 100 mm.

Toepassing:

- Audi A2, A3, A4, A6
- Volkswagen Golf IV, Passat B5, T4, T5 en LT4
- Skoda Fabia, Octavia en Superb, Ford Galaxy 1.9 TDI

FOR 34880008	M8	800 mmL
FOR 34880010	M10	800 mmL

- Extra lange spline dopsleutel voor montage van aandrijfasschroeven vanaf de buitenzijde door de wielkast bij VW en Audi
- Spaart kostbare tijd en geen zware verlengstukken meer nodig



Art.nr	mm	L mm
FOR 807314	14	63
FOR 807316	16	63
FOR 807318	18	63
FOR 807320.6	20.6	63
FOR 807314M	14	70
FOR 807316M	16Mag	70
FOR 807318M	18Mag	70
FOR 807320.6M	20.6Mag	70

Art.nr	mm	L mm
FOR 807325014M	14	250
FOR 807325016M	16	250

Art.nr	mm	L mm
FOR 807416	16	63
FOR 807418	18	63
FOR 807420.6	20.6	63
FOR 807416M	16	70
FOR 807418M	18	70
FOR 807420.6M	20.6	70

### Bougiedop 6 kant 3/8"

**Douilles pour bougies 6 pans 3/8"**



### Bougiedop 6 kant 1/2"

**Douilles pour bougies 1/2"**

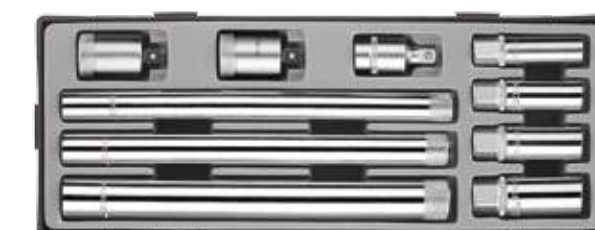

### FOR T31010

**TC module 3/8" bougiedoppenset 10 dlg**  
**TC module 3/8" douilles pour bougies 10pcs**

- 3/8" Magnetische bougiedop 14 mm
- 3/8" Magnetische bougiedop 16 mm
- 3/8" Magnetische bougiedop 18 mm
- 3/8" Magnetische bougiedop 20.6 mm
- 3/8" Magnetische bougiedop lang (250 mm) 14 mm
- 3/8" Magnetische bougiedop lang (250 mm) 16 mm
- 3/8" Magnetische bougiedop lang (250 mm) 20.6 mm
- 3/8" Adapter met kogelgewricht
- 3/8" Adapter met draaimoment 18 Nm
- 3/8" Adapter met draaimoment 24 Nm





**FOR 88704H9**

Vetpomp 400 mL met vulnippel

*Pompe à graisse manuel avec embouts pour graisseurs*

- pour cartouches de graisse standard 400 mL

**FOR 887A500**

Cardanspuit 500 mL

*Seringue aspirante refulante 500 mL*

- Enkelwerkende cardanspuit.
- Geschikt voor vullen en afzuigen van vloeistoffen.
- Verzinkt staal met zinken deksel.
- Geleverd met 300 mm transparante, flexibele slang.
- Inhoud 0,5 liter.

**FOR 887C02**

Oliekan metaal met flexibel 350 mL

*Burette à huile à bec flexible 350 mL*

**FOR 887D01**

Metalen trechter

*Entonnoir en métal*

Lengte 370mm

**FOR 61928**

Olie trechter

*Entonnoir pour huile*

Lexus, Toyota, VW, Audi, BMW, Mercedes-Benz, Chevrolet, Volvo

**FOR 887P01**

Vatpomp telescopisch

*Pompe pour fût telescopic*

- voor niet corrosieve vloeistoffen voor 60L tot 200L vat
- pour fluides non-corrosive

**FOR 908T9**

Transmissie vulpomp incl adapters

*Système de remplissage de boîte de vitesse*

- Compleet systeem voor onderhoud van gesloten automatische transmissies van o.a. Ford, Toyota, BMW, Honda, Nissan, VW, Audi, Mercedes en Volvo (ook voor DSG en CVT versnellingsbak.)
- Groot 7,5-liter reservoir met geïntegreerde handpomp, manometer en overdruk ventiel.
- Pour le remplissage des boîtes de vitesse et des différentiels, comprend un kit d'adaptation avec différents angles de sortie. Pratique pour les zones difficilement accessibles.



### FOR 916G3

#### Set voor verwijderen van gebroken gloeibougies

#### Set de réparation de filets pour bougies de préchauffage

16-delige set voor het verwijderen van beschadigde of moeilijk te demonteren gloeibougies uit de cilinderkop en tevens professionele reparatie van beschadigde schroefdraad.

#### Inhoud:

- Trekker voor vastzittende gloeibougies
- Stappenboren voor het uitboren van afgebroken gloeibougies in 7 x 5,5 mm en 9 x 5,5 mm
- Schroefdraadtappen M8 x 1,0, / M10 x 1,0 / 6,3 (1/4")-28UNF om nieuw schroefdraad te tappen
- Houder voor schroefdraadtappen met ratelfunctie
- E10 dop



### FOR 933G1

#### Gloeibougie schroefdraad herstellings set

#### Kit réparation de filetage bougie de prechauffage

31 Delige set voor het reparereren van 8 mm, 10 mm en 12 mm gloeibougie schroefdraad in aluminium cilinderkoppen bij dieselveertuigen.

#### Inhoud:

- Schroefdraadtap M8 x 1,0
- Schroefdraadtap M10 x 1,0
- Schroefdraadtap M10 x 1,25
- Schroefdraadtap M12 x 1,0
- Schroefdraadtap M12 x 1,25
- Schroefdraadtap M14 x 1,25
- 5 Draadbussen M8 x 1,0 (binnendraad)
- 5 Draadbussen M10 x 1,0 (binnendraad)
- 5 Draadbussen M10 x 1,25 (binnendraad)
- 5 Draadbussen M12 x 1,25 (binnendraad)
- Draadbus montagegereedschap M8 x 1,0 / M10 x 1,0
- Draadbus montagegereedschap M10 x 1,25 / M12 x 1,25
- Handvat
- Montagestang voor draadbussen
- 3 Bougie-eindafsluiters



### FOR 909G6

#### Pneumatische trildoppenset met laag koppel die speciaal ontwikkeld is om vastzittende gloeibougies van dieselmotoren los te draaien.

#### Extracteur réversible à percussion à couple réglable pour bougies de préchauffage

- Door het gecontroleerde koppel in combinatie met de trilfunctie kunnen gloeibougies veilig losgedraaid worden en verkleint u de kans op afbreken van de gloeibougie.
- De pneumatische slagsleutel heeft vier vast ingestelde koppels en de draairichting is omkeerbaar.
- Het set bevat vijf 1/4" trildoppen van chroom-molybdeen staal (8-9-10-11-12 mm), 2 verlengstukken en een kogelgewricht adapter voor gebruik in kleine ruimtes. Het gereedschap kan ook met andere doppen worden gebruikt om verbindingen los te draaien die bijvoorbeeld door corrosie of koolafzetting vastzitten.



### FOR 904G12

#### Stoppenset voor rem & brandstofleidingen

#### Jeu de 4 pinces d'obturation pour tuyaux et raccords

- Deze verende stoppers zijn geschikt om losgekoppelde stalen remolie- en brandstofleidingen af te stoppen om te voorkomen dat vloeistof uit de leiding weglekt.
- Voorkomt weglekken van bijv. remolie of brandstof en verontreiniging van de werkvloer
- Perfect voor het werkzaamheden aan remleidingen en brandstofleidingen
- Verend voor instant on/off
- Maten: Banjo, 3/8", 5/16", 1/2"
- Geschikt voor alle automotive vloeistoffen



### FOR 9G0715

#### Tang voor brandstofleidingen Pince pour raccords carburant



### FOR 9G0716

#### Tang voor brandstofleidingen Pince pour raccords carburant



### FOR 9G0104

#### Brandstof klemtang clic R Pince pour collier clic R



### FOR 9G0109

#### Slangklemtang clic clic R Pince pour collier clic R

### FOR 9G1001

#### Gloeibougie stekker tang Pince droite pour bougies de préchauffage

- Ontworpen om op moeilijk bereikbare plaatsen, zonder schade aan te richten de gloeibougie stekkers te verwijderen. Recht model met soft grip handvat en voorzien van duim uitsparingen voor makkelijk gebruik en extra kracht te zetten.
- Geschikt voor dieslmodellen van Audi, BMW, Mercedes, Opel en Volkswagen





### FOR 9G0123

Dop voor brandstoffilter 1/2" 27 mm  
1/2" Douille pour filtre de carburant 27 mm

- Citroën C4 2.0 HDi 16v, C4 Picasso 2.0/2.2 HDi, C5/C8
- 2.0/2.2 HDi 16v Jumpy 2.0/2.2 HDi
- Fiat : Scudo/Ulysse Mk 2.0 JTD 16v
- Ford : Focus - C Max - Galaxy - Kuga - S Max 2.0 TDCi
- Peugeot : 307-308-407-607-807-Expert 2.0 HDi 16v
- Volvo : C30-C70-S40 mK ii/v50 2.0 DIESEL (136HP)



### FOR 904G10

Set koppelingen met veersluiting 4 delig  
Jeu d'acouplements de verrou à ressort 4pcs

- Pour conduites d'airco 3/8"-1/2"-5/8"-3/4"
- voor airco leidingen

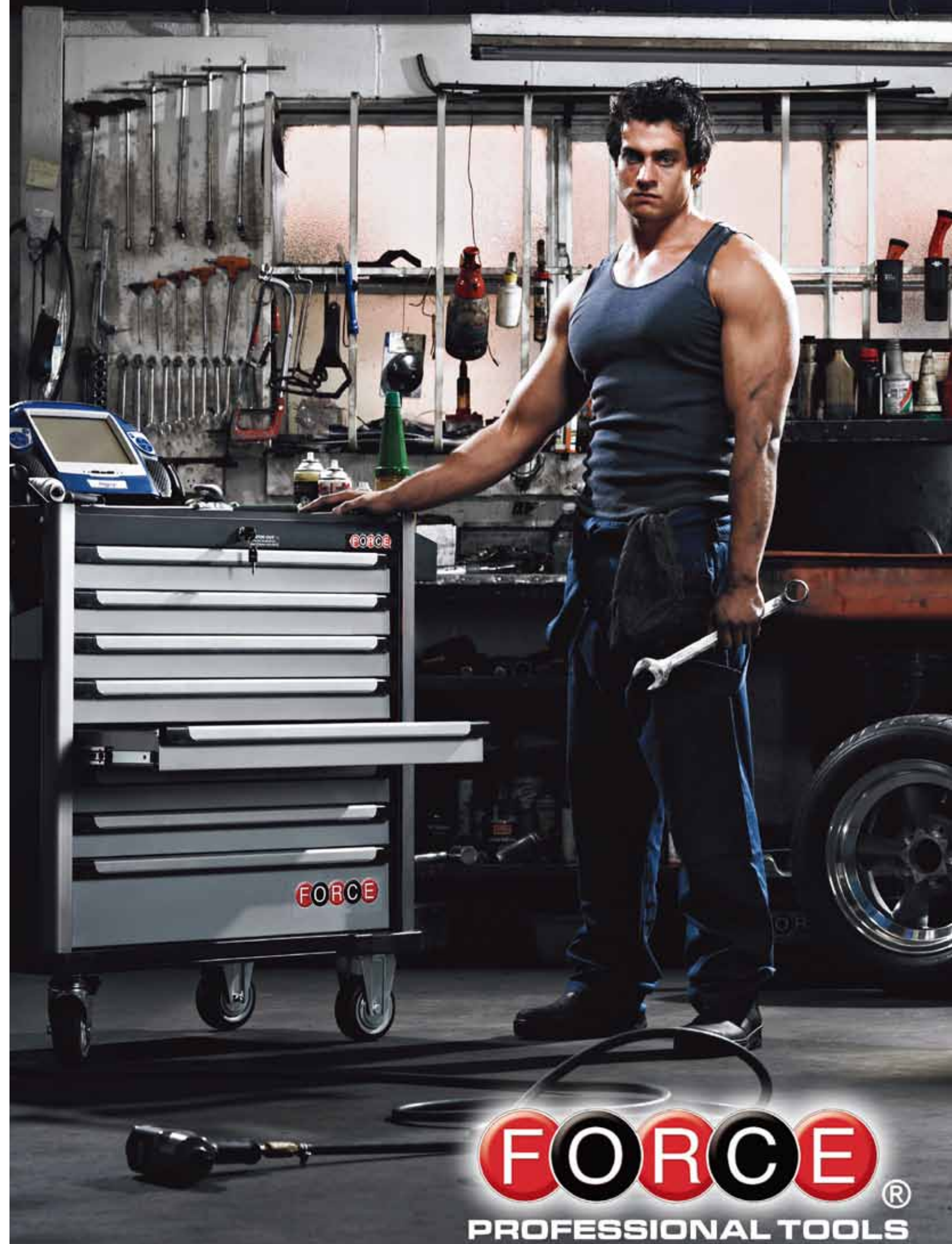
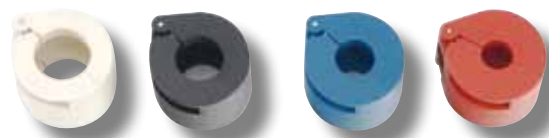

### FOR 9G0605

Vliegwiel blokkeergereedschap  
Outil de calage volant moteur



### FOR 9G0606

Universele nokkenas tegenhouder

- Alfa Romeo, Audi, Citroën, Fiat, Ford, Opel, Renault, Rover, Skoda, VW, Volvo
- voor het draaien en op plaats houden van de poelies van nokkenas en de injectiepomp

Outils universel pour retenir l'arbre à came



### FOR 9G0617

Universele nokkenas blokkeersleutel

Outils universel pour retenir l'arbre à came

- Universeel inzetbaar voor het verdraaien van tandwielen of voor het blokkeren van de nokkenas om de nokkenas bout los te draaien.
- Geschikt voor het verdraaien en fixeren van het nokkenafstandwiel
- instelbare opening van 50-150 mm



### FOR 908G4

Time toolset universeel 8 delig  
Jeu d'outils de réglage universels 8 pcs



### FOR 919G1

Blokkeergereedschap voor nokkenas en krukas 19 delig  
Outil de calage pour arbre à cams et vilebrequin 19 pcs



### FOR 913G3

Blokkeergereedschap voor diesel en benzinemotoren 13 delig

Outils de calage pour moteurs diesel et essence 13 pcs

- Audi, Citroën, Fiat, Peugeot, VW, Volvo

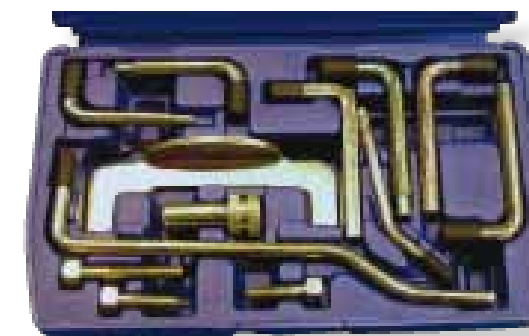

### FOR 9G0121

1/2" Dop voor injectiepomp 33k spline x 56 mmL

Douille spéciale 33 pans pour pompe à injection

- Mercedes

- Voor demontage van de drukventielhouders aan MRSF-ERE brandstof injectiepomp bij Mercedes Benz 601, 602, 603, 605, 606, 615, 616 en 617 diesel modellen.



### FOR 9G0122

1/2" Dop XZN voor voorkamer Mercedes 58t

1/2" Douille spline pour pré-chambre Mercedes

- diesel motoren Mercedes Benz 601, 602, 602.91, 603, 604, 605, 606, 661, 662



### FOR 903G20

Montagehulp voor elastische riemen

Jeu d'outils pour courroies Elastiques Uni-Flex

- Geschikt voor elastische riemen zoals bij Alfa-Romeo, BMW, Citroën, Chrysler, Dacia, Fiat, Ford, Mazda, Opel, Peugeot, Renault, Seat, Skoda, Smart, VW en Volvo.





### FOR 905G1

Tijdafstelset BMW M52,M54,M56  
Coffret calage de distribution BMW M52, M54, M56

- Tijdafstelset voor BMW 6-cilinder dubbele Vanos benzine motoren (M52TU, M54, M56) vanaf 1998.
- Geschikt voor BMW 6-cilinder benzine motoren: M52TU (1998-2000), M54 (2001-2004) en M56 (vanaf 2003.)



### FOR 904G11

Tijdafstelset BMW N47, N47S  
Coffret calage de distribution BMW N47, N47S

- Geschikt voor met ketting aangedreven 1.6l, 1.8l, 2.0l, 2.3l, 2.5l
- dieselmotoren van BMW met motorcodes N47, N47S, N57 en N57S.



### FOR 913G6

Tijdafstelset BMW M41, M51, M47, M57  
Coffret calage de distribution BMW M41, M51, M47, M57

- Geschikt voor werkzaamheden aan dieselmotoren van BMW, Rover en Opel.



### FOR 905G12

Tijdafstelset BMW, Mini, Citroën, Peugeot  
Coffret calage de distribution BMW, Mini, Citroën, Peugeot

- Geschikt voor een groot aantal ketting-aangedreven benzinemotoren van BMW, Mini, Citroën en Peugeot.
- Het gereedschap is specifiek ontworpen om de nokkenas en krukas op hun plaats te vergrendelen zodat de nokkenas distributie correct kan worden gecontroleerd en ingesteld.



### FOR 908G9

Tijdafstelset BMW N42,N46, N64T  
Coffret calage de distribution BMW N42, N46, N46T

- Geschikt voor met ketting aangedreven 1.8 & 2.0 liter benzinemotoren van BMW voorzien van Vanos technologie.

**Modellen:**

- BMW: 118/120 E81, E82, E87 (2004-2009)
- BMW: 318/320 E90, E91, E93 (2005-2009)
- BMW: Z4 E85, E86 (2004-2009)
- BMW: X3 E83 (2005-2009)
- BMW: 316/COMPACT E46 (2001-2005)
- BMW: 318/COMPACT E46 (2001-2007)

**Motor codes:**

- N42 / N46 / N46T B18, B18A, B20, B20A, B20B



### FOR 907G3

Blokkeersleutelset voor Mercedes & BMW  
Coffret clés visco embrayage couplage ventil refroidissement

- Voor het blokkeren van de Visco koppeling bij BMW, Mercedes en Ford.
- Stelt u in staat om de poelie van de waterpomp in de juiste positie te zetten terwijl tegelijkertijd de ventilator gedemonteerd wordt.
- 7 clés pour le démontage ou le maintien du ventilateur de refroidissement, de l'arbre d'entraînement de Visco Embrayage Ford, Mercedes et BMW.
- Permet le tenir la poulie de la pompe à eau en place.



## FOR 904G15

### Tijdafstelset VW Coffret calage de distribution VW

- Voor de vergrendeling van beide nokkenassen en krukas bij VAG 1.2 liter 3-cilinder 6V en 12V benzine motoren.
- Nokkenas uitlijngereedschap 6V
- Nokkenas uitlijngereedschap 12V (2)
- Krukasborggereedschap 6V & 12V

#### Toepassing:

- Volkswagen Polo, Lupo en Fox 1.2 liter, 3-cilinder 6V en 12V (vanaf 2002)
- Seat Cordoba en Ibiza 1.2 liter, 3-cilinder 6V (2002-2009)
- Skoda Fabia en Roomster 1.2 liter, 3-cilinder 6V en 12V (2002-2010)



## FOR 902G2

### Blokeergereedschap Vw, Audi, Seat, Skoda Outils de calage moteur VW, Audi



## FOR 906G4

### Blokeergereedschapset voor VAG TDI Outils de calage moteur VAG TDI

Geschikt voor VAG 2.0L TDi PD DOHC motoren zoals in de Audi A2/A3/A4/A5/A6, Skoda Octavia II, Seat Leon, Volkswagen Golf en meer.  
Tevens geschikt voor de VAG ASZ en ASZ1 motoren in de Ford Galaxy.

#### Inhoud:

- Krukas borggereedschap voor ovale krukas (tot 2004)
- Krukas borggereedschap voor ronde krukas
- Injectiepomp borgpen (2)
- Distributieriemspanner borgpen
- Spanpoelie borgpen

(OEM: 310 085/T10050, T10100, 3359/T20102, T10115, T10060/A)



## FOR 9G1206

### Nokkenas blokkeergereedschap VAG Outil de blocage pour arbre à cames VAG

Blokkage gereedschap voor het blokkeren van de nokkenas bij het vervangen van de tandriem.

Te gebruiken bij 4 cilinder 16V injectiemotoren van Audi, Seat, Skoda en VW.

OEM: T10016 / T10074.

#### Toepassingen:

- Audi A2 1.4 (2000-2006)
- Seat Arosa 1.4 (1999-2005), Cordoba 1.4 (1999-2008), Ibiza 1.4 (1999-2008), Inca 1.4 (2000-2004), Leon 1.4, 1.6 (1999-2005), Toledo 1.4, 1.6 (1999-2005)
- Skoda Fabia 1.4 (1999-2005), Octavia 1.4 (1999-2005)
- VW Beetle 1.4, 1.6 (2001-2008), Bora 1.4, 1.6 (1997-2008), Caddy 1.4, 1.6 (1999-2008), Golf 1.4, 1.6 (1997-2008), Lupo 1.4, 1.6 (1998-2005), Polo 1.4, 1.6 (1998-2007)

#### Motor codes:

- Audi: AFK, AHW, AKQ, APE, ARR, AQQ, AUA, AUB, AXP, BBY, BBZ, BCA, BKY
- Seat: AFK, AHW, APE, AQQ, AUA, AUB, AUS, AXP, AZD, BBY, BBZ, BCA, BCB, BKY, BXW
- Skoda: AUA, AUB, AXP, BBY, BBZ, BCA, BKY, BUD, BXW
- VW: AFK, AHW, AJV, AKQ, APE, AQQ, ARC, ARR, AUA, AUB, ATN, AUS, AVY, AXP, AZD, BBY, BBZ, BCA



## FOR 904G17

### Tijdafstelset Bosch 3 in 1 VW Coffret calage de distribution VW Bosch 3 in 1

Past op Bosch VE injectie pompen

Gebruiken in combinatie met een meetklokje

- M8 adapter
- M10 adapter
- M12 adapter

#### Geschikt voor:

- Bosch VE injectie pomp
- Diesel kiki
- Nippondenso pompen



## FOR 9G1208

### Krukas borggereedschap Outils de calage moteur

- Volkswagen, Audi, Seat, Skoda, 2.0 Tdi

Voor het blokkeren van de krukas tandwiel van VAG 1.9 en 2.0 TDI diesel-motoren met pompverstuiver, inclusief DOHC.

Geschikt voor de 1.9 en 2.0 TDI motoren met een ovale profiel vertanding. OEM T10100

#### Toepassingen:

- Audi: A3, A4, A6
- Seat: Altea, Alhambra, Leon, Toledo
- Skoda: Fabia, Octavia 2
- Volkswagen: Beetle, Bora, Caddy, Fox, Golf, Golf Plus, Jetta, Lupo, Passat, Sharan, Touran

#### Motor codes:

- AZV, BKD, BMN, BMP





## FOR 928G1

### Tijdafstelset VW, Audi, Seat & Skoda Coffret calage de distribution VAG

- Tijdafstel borgset voor benzine en diesel motoren van de VAG groep (Audi / Seat / Skoda / VW) vanaf 1976.
- Tevens geschikt voor een aantal modellen van Volvo en Ford waar een VAG motor in ligt.

#### Benzine motoren:

- 1.2 6V - 1.2 12V - 1.4 - 1.6 - 1.8 - 1.8T - 2.0 16V
- Audi: 80 - A2 - A3 - S3 - A4 - A6 - TT
- Seat: Alhambra , Arosa, Cordoba, Ibiza, Inca, Leon, Toledo
- Skoda: Fabia, Octavia (vanaf 1996)
- VW: Bora, Caddy, Fox, Golf, Lupo, nieuwe Kever, Passat, Polo, Sharan, Touran

#### Diesel motoren:

- 1.2, 1.4, 1.9, 2.0 TDI PD
- 1.7, 1.9 D / TD / SDI / TDI
- 2.5 V6 TDI
- Audi: 80, A2, A3, A4, A6, Cabrio (1995-2000)
- Seat: Alhambra , Arosa, Altea, Cordoba, Ibiza, Inca, Leon, Toledo
- Skoda: Fabia, Felicia, Octavia (1993-2005)
- VW: Bora, Caddy, Golf, Lupo, nieuwe Kever, Passat, Polo, Sharan, Transporter, Touran



## FOR 907G13

### Tijdafstelset VAG 2.0 FSI & 2.0 FSI Turbo Coffret calage de distribution VAG 2.0 FSI & 2.0 FSI Turbo

- Speciaal gereedschap voor het blokkeren van de nokkenas en krukas.
- Geschikt voor 2.0 liter FSI motoren.

#### Toepassingen:

- Audi A3, VW Golf / Touran (vanaf 2004)
- Motorcodes:
- AWA / AXW / BHD / BMB / BGB / BPJ / BPY



## FOR 906G6

### Tijdafstelset VW Coffret calage de distribution VW

- VW Transporter, LT, Crafter 2.4D, 2.5DI, 2.5TDI, 2.5TDI common rail



## FOR 904G16

### Tijdafstelset VAG 1.4 & 1.6 FSI Coffret calage de distribution VAG 1.4 & 1.6 FSI

- Speciaal gereedschap voor o.a. distributieriem vervanging bij
- VAG 1.4 & 1.6 FSI

#### Toepassingen:

- Audi A3 (2003-2007)
- Skoda Octavia (2004-2009)
- VW Polo (2002-2008), Golf (2003-2009), Golf Plus (2005-2009), Jeta (2006-2009), Passat (2005-2009), Touran (2003-2009)



## FOR 914G5

### Tijdafstelset VAG 2.7 & 3.0 V6 TDI Coffret calage de distribution VAG 2.7 & 3.0 V6 TDI

- Dit set is geschikt voor 2.7 en 3.0 V6 modellen van Audi (A4, A5, A6, AB, Q5, Q7) en VW (Touareg, Phaeton.)
- Bevat speciale adapters voor het draaien en positioneren van de krukas ten opzichte van de cilinderkop.

#### Inhoud:

- Krukas TDC Borgschroef
- Injectiepompborgpen
- Krukasdraaigereedschap Type 1
- Krukasdraaigereedschap Type 2
- Nokkenasborgpennen (2 stuks)
- Nokkenasuitlijnings-/borggereedschap
- Nokkenastandhoudgereedschap
- Spannerborgpennen 3.3 mm (2 stuks)



### FOR 903G17

#### Kit verstuivertrekkers

##### Kit extracteurs d'injecteurs

- Mercedes, C class, E-class, Sprinter



### FOR 904G3

#### Kit verstuivertrekkers 4 delig 1/2"

##### Kit extracteurs d'injecteurs 4 pcs 1/2"

- 22 mm 6p 110 mm L
- 22 mm 12p 75 mm L
- 27 mm 12p 78 mm L
- 28 mm 12p 78 mm L



### FOR 907G7

#### Set frezen voor diesel verstuiverzitting

##### Nettoyeur siège injecteur

- 15 mm plat - universeel
- 17 mm plat Delphi, Bosch injectors BMW, PSA, Renault, Ford
- 19 mm plat Bosch injectors, Mercedes CRD
- 19 mm konisch Fiat, Iveco
- T hendel



### FOR 921G3



#### Diesel verstuiver demontageset

##### Coffret extracteur d'injecteur diesel universel

- Balhoofd bout M18 x 1.5 voor aansluiting van de adapters aan een slagtrekker
- Speciale inbus dopsleutel 10 mm x Ø 7.6 (1/2" aansluiting; voor het losdraaien van de bevestigingsring zoals bijvoorbeeld bij Bosch injectoren van Mercedes Benz CDI en PSA HDI)
- Speciale Inbus dopsleutel 10 mm x Ø 6.6: (1/2" aansluiting; voor het losdraaien van de interne schroef van CR-injectoren)
- Adapter IT M16 x 1.0 voor Denso (Toyota 2.2D)
- Adapter IT M17 x 1.0 voor Bosch injectoren, Alfa, BMW, Fiat, Mercedes Benz, PSA en Renault
- Adapter IT M20 x 1.0 voor Denso
- Adapter IT M25 x 1.0 voor Siemens injectoren, PSA (DW10)
- Adapter IT M27 x 1.0 voor Siemens injectoren, PSA (DW10)
- Adapter OT M16 x 1.5 trek adapters voor M16 x 1.5 draad
- Adapter OT M14 x 1.5 voor binnendraad voor Bosch/ Delphi injectoren, Mercedes Benz (OM 629/642/646), PSA (DV4 / DW12), VW (CBD), BMW (M47)
- Adapter OT M25 x 0.5 voor Denso
- Adapter OT M25 x 0.75 voor Denso
- Adapter OT M27 x 1.0 voor Siemens, Citroën C5, Citroën Jumpy/Xsara, Fiat Ducato JTD, Peugeot 206 / 307 / 406 / Boxer (2.0 / 2.2 / 2.3 HDI), Mercedes-Benz CDI (behalve A-Class, Sprinter en Vito)
- Verstuiverdop (open dop) 25 mm voor Siemens Injectoren – 2.0 HDI (DW Series), PSA, Ford, Toyota etc.
- Verstuiverdop (open dop) 27 mm voor Siemens Piezo Injectoren – 2.0 HDI Piezo (DW Series), PSA etc.
- Verstuiverdop (open dop) 29 mm voor Bosch type injectoren – Bosch CDI / HDI motoren
- Verstuiverdop (open dop) 30 mm voor Bosch Type injectoren – Bosch Renault / Nissan 1.9DCI
- Trekbeugel 12 mm voor Mercedes-Benz motoren (behalve Sprinter, Vito en A-Class)
- Trekbeugel 13.5 mm voor Opel, Nissan en Renault F9Q
- Trekbeugel 16 mm voor Fiat Ducato JTD, Citroën C5, Citroën Xsara, Citroën Jumpy en Jumper HDI en Peugeot 206 / 307 / 406 / Boxer HDI (2.0, 2.2, 2.3i)
- Trekbeugel 26 mm voor Opel Z19DT, Z19DTH / Z19DTL motoren, A20DTH (LBS) / A20DTR (LBY) / A20DTJ (LBX) / A20DTC (LCD) en Fiat 1.9 JTD



### FOR 904G9

#### Diesel injectiepomp verstuiver trekkers

##### Delphi & Bosch

##### Set adaptateurs pour extracteurs d'injecteurs



### FOR 912G6

#### Kit pompverstuivertrekkers VAG TDI 1 FSI

##### Kit extracteurs d'injecteurs pompe

- Speciaal ontworpen voor het professioneel (de)monteren van FSI injectoren en diesel pompverstuivers.
- Geschikt voor Volkswagen, Audi, Seat en Skoda met direct ingespoten benzinemotoren en Common-Rail dieselmotoren.

#### Inhoud:

- Slagtrekker
- Trek adapter voor demontage van FSI injectoren
- Trek adapter met klauw voor demontage van FSI injectoren
- Trek adapter voor demontage van diesel pompverstuivers
- Montagekegel voor het monteren van de verbrandingskamer afdichtingen
- 3 Kalibratiehulpstukken voor het monteren van de verbrandingskamer afdichtingen
- Montagedrevel voor het opnieuw monteren van de FSI injectoren



### FOR 904G7

#### Diesel injectiepomp trekker BMW

##### Extracteur pompe injection diesel BMW

Brandstof injectiepomp trekker en distributieketting spanner set voor BMW, Land Rover en Opel.  
(OEM: 135120, 135190, 135191, 135192)

Voor BMW met M47, M47T2, M47TU, M57, M57TU, M57D2 motor op BMW 318D, 320D (E46) 1988-2005 en 318TD, 320TD, 525D 530D, 530, 535 (E60-E61) 2000-2006 en Land Rover TD4 M47 2.0.  
Tevens geschikt voor Opel Omega B, Land Rover Freelander en Rover 75.





### FOR 904G10

**Set koppelingen met veersluiting 4 delig**  
- voor airco leidingen

**Jeu d'acouplements de verrou à ressort 4 pcs**  
- Pour conduites d'airco 3/8"-1/2"-5/8"-3/4"

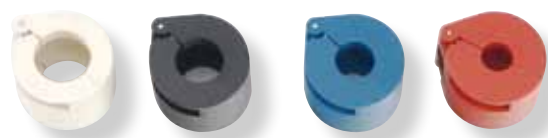

### FOR 62104

**Klep veer spanner**  
**Tendeur de ressort de soupape**

- Spanbereik 35 - 200 mm
- Met omzetbare klepspie adapters Ø 25 mm en 30 mm
- Universele klepverentang, inzetbaar op 95% van het wagenpark
- Voor zowel benzine- en dieselmotoren met moeilijk bereikbare en diep zittende kleppen

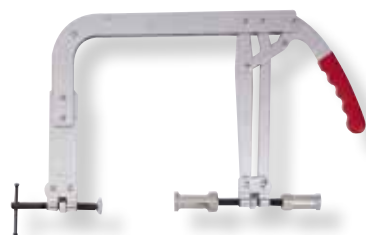

### FOR 62110

**Universele kleppenlichter**

**Compresseur de ressorts de soupapes universel**

- Heavy Duty stalen beugel
- 5 Uitwisselbare drukstiften; Ø 16, 19, 23, 25 en 30 mm
- 3 Spanschroeven; 70 mmL / 110 mmL / 120 mmL



### FOR 9G0609

**Universeel spanningstester voor motorriem**  
**Mesures tension courroi moteur**



### FOR 9G0804

**Distributieriem spanning meter**

- controleer de distributie spanning in 10 sec

**Tensiomètre courroie distribution**

- contrôle tension courroie distribution en 10 sec



### FOR 922G3

**Universele kit voor alternator 22 delig**  
**Kit universel pour alternateur 22 pcs**

- VW, Audi, Seat, Mercedes, Renault, MBW, Ford, Fiat etc
- Voor het monteren en demonteren van dynamo vrijloop poelie  
Bij werkzaamheden aan de dynamo poelie bij moet de as geblokkeerd worden met spline of torx en een adapter waar doorheen de dopsleutel past in de vrijlopende poelie



### FOR 67402

**Spanrol alternator 33 tands VAG, volvo**  
**Outils pour courroie multi VW, Audi**



### FOR 678

**T50 Alternator tools**

- 1/2" torx dop bit T50 x110 mm L
- voor Mercedes A klasse



### FOR 674

**T50 Alternator tools**

- 1/2" spline XNZ dop bit T50 x110 mm L
- voor VW, Audi, Skoda,
- Porsche, BMW, Ford, Mercedes



### FOR 6203125

**Zuigveerklem 53-125 mm**  
**Compresseur de segments 53-125 mm**



### FOR 6206175

**Zuigveerklem 90-175 mm**  
**Compresseur de segments 90-175 mm**



### FOR 618

**Voelmaatjes 20 delig**  
**Jauge d'épaisseur 20 pcs**

- metric 0.05 mm-1.00 mm

### FOR 61802

**Voelmaatjes 26 delig**  
**Jauge d'épaisseur 26 pcs**

- 0.04 mm - 0.63 mm



### FOR 906G2

Kit voor bijvullen en ontluichten van koelingsysteem  
*Kit pour purger et remplir le système de refroidissement*



### FOR 908G1

Benzine compressiemeter set 8 delig  
*Set compressiomètre essence 8 pcs*  
 - 0-20 bar adapters M10\*1.0 - M12\*1.25 - M14\*1.25 - M18\*1.5



### FOR 913G1

Diesel compressiemeter  
*Set compressiomètre diesel*  
 - 0-70 bar



### FOR 938G1

Diesel lekkage cylinder test kit  
*Compressiomètre diesel masterkit*

- Geschikt om auto en vrachtwagen motoren te testen via de verstuiver, de gloeibougje of de injectoren (TDI/CDI.)
- Voor diesel compressie druk 0-1000 Psi en 0-70 Bar.
- Met goed leesbare schaalverdeling en snel-ontluchtingsventiel.
- Rubberslang met snelkoppeling, adapters met M20- M22 M24 & Ford aansluiting, standadyne du mmy adapters, 90 graden omgezette aansluitadapter en klemplaat.



### FOR 902G9

Montage hulp voor elastische riemen  
*Coffret d'outils pour courroie flexible multi V*

- Elastische riemen zijn op steeds meer moderne motoren te vinden.
- Dankzij de elastische eigenschappen van de riem is gebruik van een spanrol niet meer nodig. Bij het vervangen van de de riem is voorzichtigheid geboden, omdat de riem bij verkeerde montage eenvoudig schade kan oplopen.
- Met deze montagehulp kan de elastische riem gemakkelijk en zonder schade van de poelie verwijderd worden en er weer terug opgelegd worden.
- Geschikt voor elastische riemen zoals bij PSA en Ford motoren bv Ford
- Fiesta 1.4L/1.6L Focus 1.6L Citroën C4, Peugeot 307, Fiat Doblo , Dacia Logan



### FOR 906G11

EGT sensoren demontage set 6dlg  
*Demontage capteur EGT*

- Speciale doppen set voor het demonteren van de EGT sensoren ( uitlaatgas temperatuur sensoren ). Geschikt voor o.a. auto's, vrachtwagens & bedrijfsvoertuigen.
- Rechte dop 13, Rechte dop 14, Rechte dop 17
- Haakse dop 13, Haakse dop 14, Haakse dop 17



### FOR 902G11

Electronische motor stethoscoop  
*Stethoscope électronique*

- Voor het eenvoudig definiëren en lokaliseren van bijgeluiden - aan motor, aandrijving etc.
- Instelbaar volume
- Gehard stalen probe
- Koptelefoon met oorpads om achtergrond geluiden af te sluiten



### FOR 907G2

Lambdasonde set 7 delig  
*Kit d'éblèvements de sondes lambda 7 pcs*

- Voor het monteren en demonteren van lambdasondes of dieselinjectoren zonder kabels of leidingen te beschadigen
- Speciaal voor lambdasondes op moeilijk bereikbare plaatsen
- Geschikt voor montage van dieselinjectoren van BMW, Ford, Mercedes, Opel, Rover, Seat, VAG, Volvo etc.
- 22 mm 1/2" x 7/8" x 50 mmL
- 22 mm 3/8" x 7/8" x 30 mmL
- 22 mm 3/8" x 7/8" 6kant 80 mmL
- 22 mm 3/8" x 7/8" 6kant 90 mmL
- 5- 3/8" x 1" x 1-1/16" x 74 mmL
- 6 1/2" x 29 mm 6kant 90 mmL



### FOR 44315022

Lambdasonde dop  
*Douille pour montage-démontage sondes lambda*  
 - 1/2" 22 mm 6k 150 mm L



### FOR 9U0401

Infrarood thermometer  
*Thermomètre infrarouge*

- Voor nauwkeurige contactloze temperatuurmeting
- Te gebruiken voor het snel meten van temperatuur van bijvoorbeeld koelsysteem, remmen, airco, motor en uitlaatdelen.
- Met laser markering.
- Bereik -20°C tot 500°C.
- Nauwkeurigheid ± 2°C bij -20°C tot 100°C en ± 2% bij 100°C tot 500°C.



### FOR 9G0901

Cylinderruimer  
*Tête de pierrage pour cylindre moteur*

- 3 stenen 100 x 10 x 8 mm
- geschikt voor cilinder diameter van 50-178 mm
- Voor het snel en effectief honen van cilinders, remcilinders, koppelingcilinders, reinigt en verwijdert koolstof afzetting.





## FOR 9G0201

### Slangklemtang

#### Pince à cable pour colliers auto serrants

- Capaciteit 0 - 100 mm
- Lengte Bowdenslang 630 mm
- Geschikt voor CTC slangklemmen

Geschikt voor o.a. Audi, Citroen, Peugeot, Porsche, Renault, Seat, Skoda, Toyota, Volkswagen.



## FOR 9G0109

### Slangklemtang met draaibare koppen

#### Pince à colliers avec têtes pivotantes



## FOR 9G0104

### Clic en Clic-R slangklemtang

#### Pince pour colliers Clic en Clic R

Speciale tang voor het vakkundig openen en hersluiten van herplaatsbare Clic en Clic-R slangklemmen. Clic en Clic-R slangklemmen worden meest gebruikt op brandstofleidingen.

Bekken met speciaal profiel en comfortabel kunststof handvat.



## FOR 62518

### Slangklemtang

#### Pince à collier de durite



## FOR 909G3

### Slangklem tangenset 9 delig

#### Set de pinces 9 pcs

- 1 x Slangklemtang Bowden, op afstand bedienbaar met Bowdenkabel voor verende slangklemmen van 18-54 mm
- 1 x Slangklemtang met "+" bek
- 1 x Slangklemtang met "U" bek
- 1 x Slangklemtang voor draadveerklemmen
- 1 x Slangklemtang gebogen voor draadveerklemmen
- 1 x Slangklemtang CLIC-R
- 1 x Slangklemtang voor ashoes slangklemmen



## FOR 904U4

### Haak & priemset 4 dlg

#### Jeu de 4 crochets

- Mini uitvoering, handig voor het verwijderen van bijv. o-ringen, keerringen, stofringen en bussen voor verschillende toepassingen.
- Elk gereedschap is voorzien van een RVS haak en een duurzaam kunststof handvat met softgrip.
- Mini priem (150mm)
- Mini ronde haak (150mm)
- Mini 45° haak (150mm)
- Mini 90° haak (150mm)



## FOR 4285

### 1/2" XZN doppenset 28 delig in koffer

#### 1/2" Jeu de 28 douilles XZN

348055 05...16	M5-M6-M8-M9-M10-M12-M14-M16 (55 mm L)
348100 05...18	M5-M6-M8-M9-M9,5-M10-M12-M14-M16-M18 (100 mm L)
348140 08...14	M8-M9-M10-M12-M14
348055 14T...16T	M14-M16 (55 mm L) veiligheidsbit
34810016T	M16 100 mm L veiligheidsbit
678	M10 alternator tools M10x110 mm L



## FOR 4266

### 1/2" Special doppenset 26 delig in koffer

#### 1/2" Jeu de douilles special 26 pcs

34410011	inbus 11 mm (100 mm L)	34814008...12	Spline M8-M9-M10-M12 (140 mm L)
34410013	inbus 13 mm (100 mm L)	34805516T	Spline M16 55 mm L veiligheidsbit
34414010	inbus 10 mm (140 mm L)	34810016T	Spline M16 (100 mm L)
34614060	Torx T60 (140 mm L)	34910013	Ribe M13 (100 mm L)
34710055	Resistorx T55 (100 mm L)	34912012	Ribe M12 (120 mm L)
34710570	Resistorx T70 (105 mm L)	34914009	Ribe M9 (140 mm L)
34713030	Resistorx T30 (130 mm L)	34914010	Ribe M10 (140 mm L)
34714080	Resistorx T80 (140 mm L)	674	M10 alternator tools
34810014	Spline 14 (100 mm L)	678	T50 x 110 mm L
34812009	Spline 9 (120 mm L)		



### FOR 903G12

Set van 3 tangen voor flexibele slangen  
*Set de 3 pinces pour tuyaux flexibles*  
 - 10 mm-15 mm-24 mm

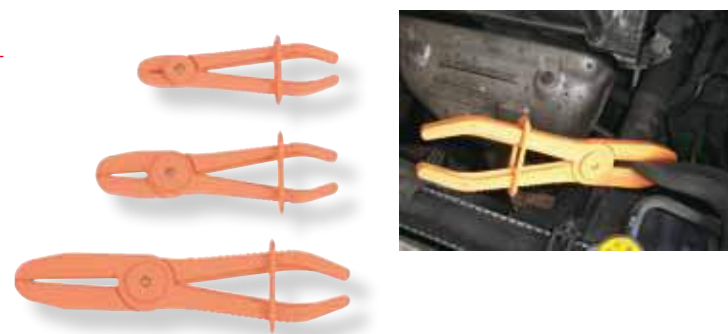

### FOR 903G18

Slang klemtangenset 90° gebogen  
*Jeu de 3 pinces coudées à clamer les durites*

- 3 Hittebestendige klemtangen voor het afklemmen van bijv. koelvloeistof-, brandstof- of vacuümslangen.
- Met afgeronde bekken om beschadiging aan de slang te voorkomen.
- Verstelbaar middels houderring en eenvoudig met 1 hand te bedienen.
- Geschikt voor slangen met een diameter van 15 mm tot 60 mm.
- Slang klemtang 90° gebogen 225 mm
- Slang klemtang 90° gebogen 165 mm
- Slang klemtang 90° gebogen 155 mm



### FOR 904G8

Set van 4 klemmen voor flexibele slangen  
*Set de 4 pinces pour tuyaux flexibles*



### FOR 9T0108

Remschijf demontage gereedschap  
 170-400mm  
*Demontage disc à frein*  
 170-400mm



### FOR 9G0111

Gereedschap voor flexibele slangen  
*Outil pour tuyaux flexibles*

Afsluitklem voor het eenvoudig en effectief afsluiten van radiatorslangen, remleidingen en brandstofleidingen.  
 De schroefactie zorgt ervoor dat de slang echt helemaal dicht is. Door de ronde vorm wordt de slang/leiding niet beschadigd.  
 Geheel metalen uitvoering.



### FOR 9B0101

Tang voor remveren  
 - voor het verwijderen van de terugtrekveren van de remschoenen  
*Pince à ressort de frein*



### FOR 9B0102

Tang voor remveren  
 - voor het verwijderen van de terugtrekveren van de remschoenen  
*Pince à ressort de frein*



### FOR 9T0203

Remveerplaatser  
 - om de aandrukveren van trommelremmen te spannen  
*Outil pour pose et dépose des ressorts de frein*



### FOR 9U3003

Staalborstel 200 mmL  
*Brosse acier 200 mmL*





**FOR 88501**

Remvloeistof tester  
*Testeur de liquide de frein*

**FOR 88502**

Remvloeistofmeter led display  
*Testeur de liquide de frein*

**FOR 9G0902**

Cylinderruimer  
*Tête de pierrage pour cylindre de frein*  
 - 3 stenen 28.5 x 5  
 - geschikt voor cilinder diameter 19-63 mm

**FOR 65803**

Terugstelset remzadelzuigers 3 delig  
*Repousse piston de freins 3 pcs*

- Ford, Honda, Jaguar, Mazda, Mitsubischi, Nissan, Rover, Subaru, Toyota met ABS

**FOR 65802**

Remzuigerterugstelgereedschap 13 delig  
 - Universeel remzuigerterugstelgereedschap voor linksom en rechtsom terugstellen. Voor diverse automerken.

*Set d'outils repousse piston de freins 13 pcs*  
 - gauche-droite

**FOR 65805**

Remzuigerterugstelgereedschap 18 delig  
 - Universeel remzuigerterugstelgereedschap voor linksom en rechtsom terugstellen. Voor diverse automerken.  
 - 15 adapters en 2 trekkers

*Set d'outils repousse piston de freins 18 pcs*

**FOR 65815**

Terugstelset remzadelzuigers pneumatisch links-rechts 16 delig  
*Set d'outils pneumatique pour repousser pistons de freins gauche-droite 16 pcs*

- Met deze set draait u de remzuiger met luchtdruk in enkele seconden terug zijn ruststand.
- Nooit meer remklauwen demonteren om te zuiger terug te kunnen draaien. Geleverd met 15 adapters, geschikt voor Audi, Fiat, Ford, Isuzu, Honda, Jaguar, BMW, Nissan, Mitsubischi, VW, Saab, Mazda, Toyota enz



### FOR 904B1

#### Borgklemmen voor remcilinder

#### *Jeu de 4 pinces garniture de frein à tambour*

- Set van 4 klemmen om de zuigers van remcilinders in trommelremmen te borgen.
- Voorkomt lekkage van remvloeistof langs de zuigers bij het vervangen van de remblokken.



### FOR 904G12

#### Stoppenset voor rem & brandstofleidingen

#### *Jeu de 4 pinces d'obturation pour tuyaux et raccords*

- Verend voor instant on/off
- Maten: Banjo, 3/8", 5/16", 1/2"
- Geschikt voor alle automotieve vloeistoffen



### FOR 9T0106

#### Schuifmaat voor remschijven

#### *Piede à coulisse pour disques de frein*

- Kleine handige schuifmaat om de dikte van remschijven te meten en tevens geschikt als bandenprofielmeter.
- Meetbereik: 0-60 mm
- Materiaal: aluminium
- Afmeting: 182 x 115 x 13 mm



### FOR 4036

#### 1/2" 5kant doppen en bitdop voor remmen 3 dlg

#### *1/2" Douilles et embout sur douille 5pans pour freins 3pcs*

- douille embout 10 mm 55 mmL Girling
- douille 14 mm : Smart-Astra G-Zafira
- douille 19 mm : Bendix-Citroën-Peugeot-Renault



### FOR 908G8

#### Kit druk- en onderdrukpomp

- Druk en onder druk
- geschikt voor lucht en vloeistof

#### *Kit pompe pression/dépression*

- Permet de nombreuses applications techniques : contrôle de l'avance à dépression, des capsules à dépression, du turbo etc



### FOR 656

#### Kit felgereedschap voor remleiding 8 dlg

#### *Kit evasement de tuyau de frein*

- Geschikt voor enkele en dubbele felskragen op koperen en zachtstalen leidingen met een wanddikte tot 1 mm.
- Remleiding moet dubbel gefelst worden.
- Wordt geleverd met 7 adapters in de inch maten: 3/16" - 1/4" - 5/16" - 3/8" - 7/16" - 1/2" en 5/8"



### FOR 656M

- Geschikt voor leidingen van Ø 4 - 5 - 6 - 8 - 10 - 12 en 14 mm.

### FOR 65601

#### Telescopische pijpsnijder 3-29 mm

#### *Coupe-tubes 3-29 mm*



### FOR 65602

#### Mini telescopische pijpsnijder 3-22 mm

#### *Coupe-tubes mini 3-22 mm*



### FOR 9B0109

#### Veerplatentang voor trommelremmen

#### *Pince pour ressorts garnitures de freins*

- Mercedes A klasse, Citroen, Renault, Peugeot, Land Rover, Ford Honda etc





**FOR 681B400**

**Versterkte kruissleutel 17-19-21-22**  
- 1/2" met adapter (400 mm L)  
**Clé en croix renforcée 17-19-21-22**



**FOR 681600**

**Kruissleutel 24-27-32 mm**  
- 3/4" met adapter (600 mm L)  
**Clé croix pliable 24-27-32 mm**  
- 3/4" avec adaptateur (600 mmL)



**FOR 4032**

**Set 3 lange slagdoppen voor alu velgen**  
**Jeu de 3 douilles longues à choc 1/2"**  
- 17-19-21 mm 1/2"



**FOR 4033**

**Set 3 lange slagdoppen voor alu velgen**  
**Jeu de 3 douilles longues à choc 1/2"**  
- 17-19-21 mm 1/2" (150 mmL)



**FOR 4032TH**

**Set 3 lange dunwandige slagdoppen**  
**Jeu de 3 douilles longues à choc 1/2"**  
- 17-19-21 mm 1/2"



**FOR 4035**

**Set 3 torsie slagdoppen**  
**Jeu de 3 douilles longues à choc torsion**  
- 17-19-21 mm 1/2"  
- Deze doppen zijn voorzien van een koppelbegrenzer (115 Nm) waardoor de wielbout nooit te vast kan worden aangedraaid.



**FOR 40710**

**Wielsleutelset 7 delig**  
- 17-19-21-23 mm 1/2" lange slagdoppen voor alu velgen  
- telescopische wielsleutel met aanpasbaar handvat  
- wringijzer 300 mm L  
**Jeu de clés de roue 7 pcs**  
17-19-21-23mm



**FOR 912U3**

**12 delig twist doppenset 3/8" & 1/2"**  
**voor beschadigde of afgeronde bouten, wielmoeren....**  
- 3/8" 8-10-12-13 mm  
- 1/2" 14-15-16-17-19-21 mm  
**Set de 12 douilles twist**  
- kit pour les vis, écrous de roue, boulons etc  
- 3/8" 8-10-12-13 mm  
- 1/2" 14-15-16-17-19-21 mm



**FOR 907U5**

**1/2" Anti-diefstal wielbout verwijderaar set 7 dlg**  
**1/2" Extracteurs de boulons de roues anti vol 7pcs**  
- 17-18.5-20-21.5-23-24.5-26mm



**FOR 906T5**

**Wielbouten schroefdraad herstellingskit**  
**Kit de réparation des filets de boulons de roues**  
M12 x 1.25  
M12 x 1.5  
M14x 1.5

Speciale set voor het herstellen van de wielbouten schroefdraad. Door het verkeerd aandraaien van de wielbouten kan de schroefdraad beschadigd raken. Met deze speciale tappen kan de schroefdraad op relatief eenvoudige wijze worden hersteld. De tappen kunnen door het gespleten ontwerp op het onbeschadigde gedeelte van de schroefdraad worden geplaatst, dit is meestal het aan de basis van de bout. Vervolgens kan de tap met de meegeleverde dop worden terug gedraaid.



**FOR 9T0206**

**Krachtdop voor wielbouten Mercedes 17 mm 1/2"**  
**Douille speciale écrous de roues pour Mercedes**  
- C-klasse, GLK (W204), E klasse (W211, W212, W207), SLK (W172)  
- M-klasse (W164, W166) CL-klasse (W216),  
S klasse (W221, W222) en Maybach



**FOR 62701**

**Spiraalveerspanner**  
*Compresseurs de ressorts*



**FOR 627270**

**Spiraalveerspanner 270 mm L per paar**  
*Compresseurs de ressorts 270 mm L*



**FOR 627370**

**Spiraalveerspanner 370 mm L per paar**  
*Compresseurs de ressorts 370 mm L*



**FOR 62521**

**Ashoes klemband spanner en knipper**  
*Pince et ajusteur pour les colliers de soufflet de cardan*

- Voor het bevestigen van bandstaal klembanden bij ashoezen, met opspan en afknip mechanisme.
- Trek de klemband door de geleidings sleuf aan de voorkant en schuif het door de sleuf in de middelste draaihandel. Met de middelste draaihandel klemt u de spanband vast over de aandrijfhoes. Dan knipt u het af met het roterende mes aan de voorkant.

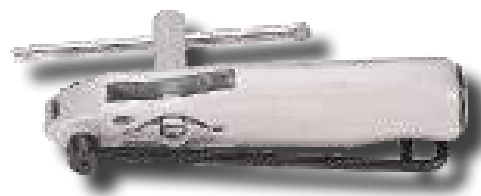

**FOR 62527**

**Ashoes klemtang met aanhaalmoment**  
*Pince de serrage pour soufflet de cardan*

Een defecte ashoes vervangen is een klus die de nodige aandacht vraagt. Aan de ene kant is het belangrijk dat de ashoes bij de montage niet beschadigd raakt, aan de andere kant is het belangrijk dat de hoes op de juiste manier wordt vastgezet. Deze klemtang met aanhaalmoment biedt hierbij uitkomst. Dit handige gereedschap is niet alleen ontwikkeld voor de probleemloze montage van ashoezen van het materiaal hytrel, maar ook voor het met het juiste moment monteren van de klemband. Hiervoor kan een 3/8" momentsleutel op de klemtang worden gebruikt. Geschikt voor onder andere VW, Audi, Seat, Skoda, Opel en Ford.

- Met 3/8" aandrijving, maakt gebruik van momentsleutel mogelijk
- Geschikt voor het vastzetten van klembanden op de ashoezen
- Voor gebruik bij RVS klembanden van de ashoezen
- Lengte 255 mm



**FOR 62520**

**Ashoes klemtang**  
*Pince pour colliers de serrage*

Voor (de)montage van click slangklemmen op ashoezen, koel- en brandstofleidingen van o.a: VW, Audi, Opel, BMW, Mercedes Benz, Honda, Nissan en Mazda.

- Geen beschadigen van klem bij het knijpen
- Gelijkmatic samenknijpen van de klem vergrendeling
- Geen beschadiging aan de ashoes



**FOR 681D515**

**Kracht wielmoersleutel**  
*Démultiplicateur de force pour boulons de roues*

Verwijderd vastzittende moeren vlug en gemakkelijk  
- lengte : 515 mm



**FOR 750200**

**Bandenlichter 200 mm**  
*Outil pour pneu 200 mm*

**FOR 750380**

**Bandenlichter 380 mm**  
*Outil pour pneu 380 mm*

**FOR 750500**

**Bandenlichter 500 mm**  
*Outil pour pneu 500 mm*



**FOR 9B0302**

**Ventiel inzetsleutel**  
*Clé valve du pneu*



**FOR 904T4**

**Banden repair kit set 4 delig**  
*Kit de réparation pour pneus 4 pcs*





## FOR 40912

### 1/2" Aandrijfas doppen set 9 dlg 1/2" Jeu de 9 douilles pour cardan

Doppenset voor het demonteren van de 12-kant moeren op de aandrijfas en het inbusprofiel in de cardanas zoals bijv. bij Golf IV, Polo, Seat, Skoda, Audi, BMW, Mercedes etc.

- Inhoud:
- 1/2" Krachtdop Inbus 14 mm: VW Passat (1996-2001), Audi A4 vóór- en achteras (AWD)
- 1/2" Krachtdop Inbus 17 mm: VW Passat (1998-2005), Audi A6 (1999-2004) / Audi A4 (2002-2005) vóór- en achteras (AWD)
- 1/2" Krachtdop Inbus 19 mm: VW T4 / T5, Skoda Fabia
- 1/2" Krachtdop 12-kant 27 mm: Ford Powerstroke, Volvo 480
- 1/2" Krachtdop 12-kant 30 mm: BMW E36 / E46, Citroen Saxo, Ford Galaxy, Mercedes W123 / W124 / W126 / W129 / W201 / W203 / W211, Opel Astra F / Astra G, Renault Scenic / Clio / Kangoo, Toyota Avensis / Picnic, VW Golf III / Golf IV / Lupo / Touareg / T5
- 1/2" Krachtdop 12-kant 32 mm: Fiat Punto, Ford Escort / Mondeo, Mercedes W140, Nissan Almera, Opel Astra H / Vivaro, Subaru Outback
- 1/2" Krachtdop 12-kant 34 mm: GM Motors
- 1/2" Krachtdop 12-kant 35 mm: Mazda
- 1/2" Krachtdop 12-kant 36 mm: Audi, BMW E36 / E39 / X5, Ford Transit / Seat Ibiza / Cordoba, Nissan Primera, VW Polo / Golf V / Touareg



## FOR 9T1481

### Naafmoersleutel VW/Audi Clé moyeu pour VW/Audi

- 22 mm



## FOR 9T0205

### Aandrijfas dop voor VAG 4WD Douille écrou d'arbre d'entraînement

Geschikt voor de aandrijfasmoer van de VAG 4WD/Quattro 6-versnellingsbak (0A3)

- Bijvoorbeeld zoals bij de Audi A4 (vanaf 2001) of de Audi A6 (vanaf 2005)
- 12-kant
- Aansluiting: 3/4"
- Lengte: 124 mm



## FOR 904T1

### Schokbrekersleutels VW/Audi Jeu de outils ecrou amortisseur autos Allemande

Passend op de zuigerstangmoer van de schokdemper.

- No.1: 10.5 mm VW Golf
- No.2: 12.5 mm VW Polo
- No.3: 14.5 mm Polo, Golf, Passat, Audi 80
- No.3: 14.5 mm Austin Maestro



## FOR 902T1

### Uitlaat rubber trekkers Crochets de traction 2 pcs

Geschikt voor verwijderen en plaatsen van uitlaatrubbers op de ophanghaken van de uitlaat.  
Voorzien van afgeronde haken en met kunststof overtrokken handgreep.

*Facilite la mise en place des anneaux caoutchouc lors d'un échange d'échappement.*

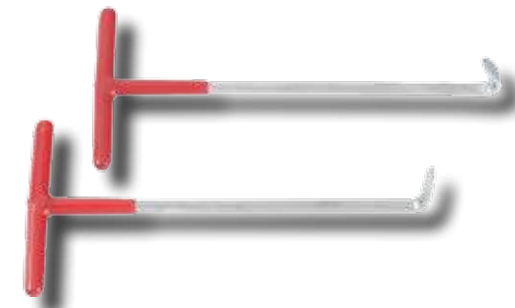

## FOR 9T0316

### Tang voor uitlaat rubbers Pince pour caoutchoucs d'échappement

Speciale tang voor het eenvoudig met één hand verwijderen van uitlaat draag- en ophangrubbers.

Deze speciale tang heeft een openingshoek van 25° en is daardoor in vele posities te gebruiken.

Een stevige solide tang die is voorzien van een rubber coating handvat voor extra grip.

Lengte: 360 mm.



## FOR 907G5

### Airbag demontage set Kit outils special airbag

Universele set voor vlotte en veilige demontage van airbags bij de meest gangbare automerken.

*La longueur des clés permet d'atteindre facilement les vis de fixation des airbag (coussin gonflable).*

- 1999-04 VW Passat, Jetta, Golf and Beetle
- Mercedes, BMW



## FOR 911T1

### Gereedschapset voor TPMS Coffret d'outils pour SSPP

Dit uitgebreide set bevat alle gereedschappen die nodig zijn om een TPMS-sensor juist in de velg te monteren.

- 1/4" Momenleutel 1-5Nm
- 1/4" momentsleutel 3.-15Nm
- verlengstuk 50 mm
- 1/4" lange doppen 11 mm-12 mm
- 1/4 Torx bits T10-T15-T20
- binnenventieldraaier rood 0.25Nm-zwart 0.45Nm



### FOR 664

Slaggewicht + trekkers 17 delig  
Set marteau à inertie + arraches 17 pcs



### FOR 664P

Trekkingset universeel  
Set marteau à inertie

Universeel lager- en polietrekkingset met zelfklemmende en centrerende armen. Door de overlappende maatvoering te gebruiken voor bijna alles wat u tegen mocht komen. De trekkingarmen zijn onderling uit te wisselen voor de meest uiteenlopende klussen. Geschikt voor zowel inwendig als uitwendig gebruik.

Inhoud:

- Houder voor 2 armen
- Houder voor 3 armen
- 3 armen van 32mm
- 3 armen van 47mm
- 3 armen van 123mm
- 1 spindel met buitenspindel
- 3 bout en moer om armen vast te zetten in houder
- Zelfklem en centreer plaat



### FOR 66603

Montagekit dichtingen 10 delig  
Kit de montage 10 pcs



### FOR 66601

Set kogellagertrekkers  
Coffret decolleurs de roulement avec potences



### FOR 66610

Set kogellagertrekkers  
Coffret decolleurs de roulements avec potences

Bijzonder geschikt om lagers, binnenringen en andere hecht vastzittende onderdelen los te maken. Door de schotels samen te trekken, grijpen de scherpe, wigvormige bekken van de schotels achter het los te maken onderdeel.

- Capaciteit schotels 30 mm - 50 mm en 50 mm - 75 mm.
- Incl. verlengstangen en spindels.



### FOR 917T1

Trekkingset 10-42 mm  
Coffret decolleurs



### FOR 906T3

Fusee stuurkogel trekking  
Coffret d'extracteurs de rotule

Dit set is geschikt voor personen- en bedrijfswagens. Hiermee kunt u moeiteloos stuurkogels, fuseekogels, stabilisatorstangen, draagarmen, geleidearmen en spoorstangarmen lospersen. De trekkers in dit set kunnen in verschillende posities worden versteld, hierdoor is het set universeel en geschikt voor alle merken auto's en lichte vrachtwagens.

- Kogelgewricht trekking, bereik ca. 35-64 mm, opening 20-22 mm, diepte 20-22 mm
- Stuurkogel trekking, opening 18 mm, breedte 38 mm, hoogte 36 mm
- Trekking, opening 35 mm, diepte 75 mm
- Trekking, opening 28 mm, diepte 60 mm
- Trekking 2-armig, opening 0-250 mm, diepte 170 mm, armlengte 120 mm



### FOR 62801

Stuurkogel trekking 19 mm  
Extracteur pour billes 19 mm



### FOR 62806

Stuurkogel trekking  
Extracteur de rotules à 2 positions XL

Extra grote stuurkogel trekking met een maximaal spanbereik van 80 mm voor lichte bestel- en transportvoertuigen van o.a. Audi, BMW, Ford, Honda, Mercedes-Benz, Nissan, Opel, Renault, Seat, Skoda, Toyota, Volkswagen en Volvo. Belastbaar tot 45Nm, de druk op de kogel is dan 3 ton, ideaal bij ernstig vastgeroeste kogels.

- Opening bek: 22 mm
- Met 2 werkposities door het verstelbare scharnier, met een maximaal spanbereik van 50 mm en van 80 mm



### FOR 62817

Stuurkogel trekking  
Arrache rotule

Handig gereedschap voor stuurkogels, reactiestangen en andere kogelgewrichten. Deze gewrichten zijn meestal conisch van vorm en zitten daarmee vaak erg stevig vast. Geschikt voor kleine auto's.

- Opening bek 18 mm
- Spanbereik 15 - 40 mm
- Maximaal aanhaalmoment 20 Nm





**FOR 628300**

Demontage vork 300mmL 15/16"  
Fourche pour rotule de direction 15/16"

**FOR 628400**

Demontage vork 400mmL 21/32"  
Fourche pour rotule de direction 21/32"

**FOR 904T5**

Bougietrekset 4 delig  
Set extracteurs de bobines 4 pcs  
- VW, Audi

**FOR 9T0204**

Universele stuurstang montage- en demontagesleutel  
Clé universelle de montage et démontage de bieltes de direction

- 400 mm L
- 35-45 mm

**FOR 66617**

Microlagertrekker  
Arache roulements

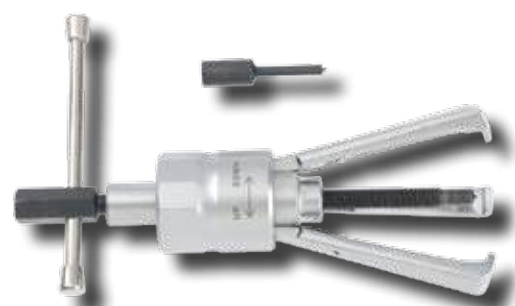
**FOR 917T3**

Set lagertrekking VW-T5 dia 85 mm  
Coffret outils pour roulements de roues Ø 85 mm

Speciaal voor het monteren en demonteren van HBU 2.1 wielnaaf lagereenheden (wiellagers) met een diameter van 85 mm. De demontage en montage kan direct aan het voertuig uitgevoerd worden zonder de anders noodzakelijke demontage van de wielophanging.

- Geschikt voor:
- VW T5 en VW Touareg met 16-inch chassis.
- Inhoud:
- Drukplaat
- Trekspindel & moer
- 2 Druk/pers schijven
- 5 Drukstukken
- 2 Steunringen
- 2 Cilinder schroeven

**FOR 933T1**

Universele silentlager druk en trekhulzenet  
Coffret outils de montage silentbloc

Universele gereedschapset voor het uittrekken en indrijven van: silentlagers, hydrolagers, bussen, kogellagers, simmerringen, rubber lagers enz.

Absoluut veelzijdig inzetbaar zowel voor personenauto's als voor vrachtwagens.

- Inhoud:
- Geharde en gelagerde trekspillen 450 mm
- Drukmoeren: M10 - M12 - M14 - M16
- 20 x drukhulzen:
- Binnen Ø: 44, 46, 48, 50, 52, 54, 56, 58, 60, 62, 64, 66, 68, 70, 72, 74, 76, 78, 80, 82 mm
- Buiten Ø: 34, 36, 38, 40, 42, 44, 46, 48, 50, 52, 54, 56, 58, 60, 62, 64, 66, 68, 70, 72 mm

**FOR 905T4**

Kit voor vervangen van silentrubbers achteraan VW, Audi  
Kit pour remplacer les silentblocs axe arrière VW-Audi  
- Golf IV, Bora, Audi, 1.4-1.6-1.8-2.0-1.9D

**FOR 905T10**

Fuseekogel demontage set Mercedes  
Coffret de démontage de rotule inférieure Mercedes

- Geschikt voor montage en demontage van onderste fuseekogels bij
- Mercedes Benz zonder uitbouw van de draagarm.
- Mercedes 220 S (1998-2005)
- Mercedes 211E (2002-2009)
- Mercedes 230SL (2001 - heden)



## FOR 666150

### Kogellagertrekker 105-150 mm

- voor het lostrekken van rollagers waar de klauen van een trekker niet kunnen komen

Decolleurs de roulements 105-150 mm



## Twee armige zelfklemmende trekkers

### Extracteur à 2 bras

Art. Nr.	
FOR 6590103	75 mm
FOR 6590104	100 mm
FOR 6590106	150 mm
FOR 6590108	200 mm



## Twee armige trekkers

### Extracteurs à 2 bras

Art. nr.	
FOR 65909090	90 mm
FOR 65909130	130 mm



## Drie armige trekkers

### Extracteurs à 3 bras

Art. nr	
FOR 6590203	75 mm
FOR 6590206	150 mm
FOR 6590208	200 mm



## FOR 672

### Moerensplijterset 4 delig

#### Casse écrous en set

- pour fendre et extraire les écrous grippés ou roullés

Art. nr	
FOR 6720912	9-12 mm
FOR 6721216	12-16 mm
FOR 6721611	16-22 mm
FOR 6722227	22-27 mm



## FOR 65113L

### Krachtvermeerderaar 3/4" x 1" 2500Nm

- Compleet met reactievoet en stang 90°

Multiplicateur de couple, pour serrage droite/gauche



## FOR T5331

### TC module repair tool set 33 delig

Tc module demontage/réparation extraction

8174	slagschroevendraaier, tournevis à frapper
15136 2...3	philips bit PH2-PH3 (36 mm L)
15236 2...3	pozidriv bit PZ2-PZ3 (36 mm L)
15336 09...11	platte bit 9-11 mm (36 mm L)
15436 06...10	inbus bit 6-8-10 mm (36 mm L)
15635 25...50	torx bit T25-T30-T40-T45-T50 (35 mm L)
15180 2...3	philips bit PH2-PH3 (80 mm L)
15380 09...11	platte bit 9-11 mm (80 mm L)
8095330	adapter 3/8" * 5/16" inbus
81045A	bit houder 1/2" x 5/16"
818 06...12	tapuiteindehalers 6-8-10-12 mm
6720912	moersplijter 9-12 mm
6721216	moersplijter 12-16 mm
6721622	moersplijter 16-22 mm
63005	linkse tappenset - extracteurs de vis



## FOR 63005

### Linkse tappenset 5 delig

Extracteurs de vis en jeux 5 pcs

- 1/8" - 1/4" (M3 - M6)
- 1/4" - 5/16" (M6 - M8)
- 5/16" - 7/16" (M8 - M11)
- 7/16" - 9/16" (M11 - M14)
- 9/16" - 3/4" (M14 - M18)



## FOR 5042

### Set van 4 tapeindeuithalers

Set de 4 extracteurs de goujons

FOR 81806	6 mm
FOR 81808	8 mm
FOR 81810	10 mm
FOR 81812	12 mm



## FOR 818B

### Kracht tapeindverwijderaar

Extracteur de goujons universel

Voor het uitdraaien van beschadigde, verroeste of gebroken tapeinden. Geschikt voor slagmoersleutels. Traploos verstelbaar van Ø 6 - 12 mm

FOR 818B01	3/8"
FOR 818B02	1/2"



NEW



**FOR 681600**
**Kruissleutel 24-27-32 mm**

- 3/4" met adapter (600 mm L)

**Clé de roue 24-27-32 mm**

- 3/4" avec adaptateur (600 mmL)

**FOR 9B0103**
**Tang voor remveren trucks**

- voor het verwijderen van de terugtrekken van de remschoenen

**Pince à ressort de frein**

**FOR 6281832**
**Impact kogelgewricht trekker**
**Extracteur de rotule impact**

- 32 mm

**FOR 9B0704**
**Oliefiltersleutel 1/2" camion**

- Demontage van filters 95 mm - 165 mm

**Clé filtre à huile auto 1/2"**

Clé filtre à huile à griffe permet de desserrer des filtres d'un diamètre de 95 mm jusqu'à 165 mm.

Les 3 griffes sont striées et permettent un excellent serrage du filtre. Sur le dessus de la clé à filtre, vous pouvez utiliser un cliquet 1/2".

**FOR 9T3711**
**Olie lekbak voor truck**
**Jeu de cartes d'huile pour essieux pour camions**

- 3 liter

**FOR 909T3**
**Dopsleutelset voor kroonmoeren van kogellagers uitwendig**
**Coffret de clés à douilles pour écrous KM, embouts à l'extérieur**

- 1/2" KM 4-5-6-7

- 3/4" KM 8-9-10-11-12

Permet une intervention aisée sur les écrous à encoches de type locknut pour roulements.

**FOR 909K1**
**Center sleeve pin set**
**Jeu d'outils de centrage d'embrayage universel**

- M18 x 1.5 - Daf, Iveco, Man, Renault, Volvo

- M20 x 1.5 - Daf, Ford, Man, Renault, Volvo, Mercedes, Scania

- M22 x 1.5 - Man, Mercedes

Ontworpen om de wielen te beschermen tegen beschadigingen als je de wiel gaat demonteren.

*A fin de ne pas abimer mes goujons quand on remplace les jantes*



**FOR 905M1**

Clipverwijderaars 5 delig  
Set enlève clips nylon 5 pcs

**FOR 904M3**

Interieurbekleding-verwijderset 4 dlg  
Set enlève clips 4 pcs

Set van 5 hulpstukken geschikt voor (de)montage werkzaamheden aan interieur, dashboard en sierlijsten.  
Vervaardigd van speciaal hard plastic/nylon.

**FOR 904M6**

Kunststof steekbeitels 4 dlg  
Jeu de grattoirs plastique 4 pcs

Uitermate geschikt voor het verwijderen van onderdelen, uitsteken van siliconen voegen en verwijderen van plaklood op aluminium velgen zonder de onderdelen te beschadigen.  
Gebruik van een hamer is toegestaan bij deze beitels.  
Door het slijpen van het snijvlak met een vijl kan het gereedschap altijd optimaal gebruikt blijven worden.  
Snijkanten op 3 zijden voor veelzijdig gebruik.

**FOR 904U1**

Schraper set 4 delig  
Set grattoirs 4 pcs

**FOR T905M2**

TC module haken, schraper & clipsverwijderaar 5 delig  
Tc module 5 grattoirs et crochets



FOR905M2P1	vork voor deurbekleding, pour clips de porte
FOR 905M2P2	priem smal
FOR 905M2P3	priem
FOR 905M2P4	priem gebogen haak, gratoir
FOR 905M2P5	haak voor algemeen gebruik, usage universel

**FOR 9M0101**

Tang voor verwijderen van clips om nietjes, clips, deurpanelen bekledingshouders enz. snel en zonder schade te verwijderen  
Pince enlève clips

**FOR 665B**

Uitdeukset 11 delig  
Kit de débosselage 11 pcs

Uitdeukset met een slagtrekker van 4 kg en verschillende adapters voor de meest gangbare carrosseriewerkzaamheden.  
Met adapters (haak, ketting hendel...) voor de diverse soorten deuken en overige toepassingen.

- Inhoud:
- Slagtrekker 4 kg
- Handvat
- Trekhaak 90° / 10 mm
- Trekhaak 90° / 22 mm
- Trekhaak 135° / 35 mm
- Trekhaak 135° / 65 mm
- Fixeerbout met schroef 70 mm
- Platte buis 95 mm
- Platte haak 190 mm
- Dubbel verloopstuk
- Bevestigingshaak met ketting 440 mm

**FOR 50713**

Uitdeukset 7 delig  
Kit de débosselage 7 pcs

FOR 62602	uitdeukhamer, marteau postillon
FOR 62603	uitdeukhamer, marteau à panne droite et tête ronde plat
FOR 62604	uitdeukhamer, marteau à rétreindre
FOR 68301	handtas universeel, tas virgule
FOR 68302	handtas in hakvorm, tas talon
FOR 68303	handtas hielvorm, tas tampon
FOR 68304	handtas in wigvorm, tas à courbure

**FOR 911M1**

Plaatwerk set 11 dlg  
Mallette marteau de carrossier a embouts interchangeable

Perfect om mee uit de deuken of diepe krassen omhoog te werken.  
Set bestaat uit een hamer met 9 uitwisselbare stempels en een aambeeld 3 in 1.





**FOR 9M0106**

**Verzet- ponstang**  
*Pince à soyer et poinçonner (tête rotative)*

Gecombineerde tang voor het omzetten van de randen van metaalplaten en voor het ponsen van dunne plaat t.b.v. gat-puntlassen. Tang met geharde bekken waarmee u een overlaping kan maken in plaat tot 1 mm dikte, ook kunnen er gaatjes van 6 mm mee geponst worden. Dit is een perfect stuk gereedschap voor de auto restauratie.

- Met de tang kunt u een klein verzet plooiën en een gat ponsen.
- Deze plaat schuift u dan onder de bestaande plaat.
- U last het gat terug toe waardoor beide platen mooi aan elkaar hangen

**FOR 904M5**

**Ruit demontage set**  
*Set outils pour pare-brise*

Gereedschapset waarmee op een professionele wijze voertuigruiten kunnen worden gedemonteerd.

De set bestaat uit een hoogwaardig metalen doorvoerpen die voorzien is van een ergonomisch gevormd kunststof handvat. Daarnaast heeft de doorvoeren een speciaal gevormde inkeping die ervoor zorgt dat de RVS snijdraad op zijn plaats blijft als deze door de kit gevoerd wordt. Naast de doorvoeren bestaat de set uit een tweetal handvaten die vervaardigd zijn uit een zeer hoogwaardig kunststof. Met deze handvaten is het mogelijk om de meegeleverde RVS snijdraad (21 meter) met weinig kracht en zeer vloeiend door de kit te trekken waardoor de voertuigruit op zeer eenvoudige manier kan worden gedemonteerd.

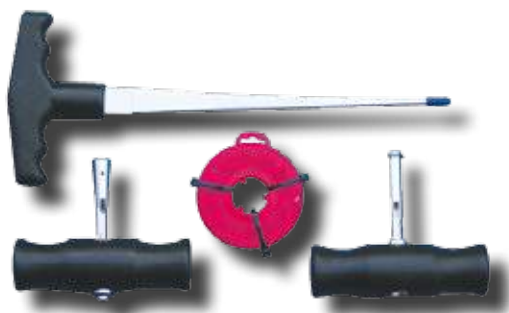
**FOR 905M5**

**Ruitenwisserarm demonteerset 5dlg**  
*Coffret d'extracteur bras d'essuie-glace*

Onmisbaar voor snelle en zorgvuldige demontage van alle gangbare ruitenwisserarmen.

Ideaal bij gecorrodeerde en vastzittende ruitenwisserarmen.

- Universeel inzetbaar
- Met slagtrekker en uitdruk adapter
- Alternatieve demontage mogelijk middels 2 armige trekker

**FOR 65701**

**Houder voor carrosserievijl verstelbaar**  
- voor vijlenbladen van 350 mm  
*Support pour lime de carrosserie*

**FOR 6571409**

**Carrosserie vijl 12 tanden per inch**  
*Lime de carrosserie*

**FOR 687400H**

**Koevoet -breekijzer met gebogen bek & punt**  
*Levier 400 mmL*

Koevoet voor het oplichten van cilinderkoppen, afnemen van tandwielen, losmaken van vastgeroeste delen, in- en uitbouw van kogellagers, .

**FOR 904U5**

**Hevel en koevoetset 4 delig**  
*Set de leviers 4 pcs*

- 200 - 300 - 450 - 600 mm

**FOR 904U6**

**Koevoetset 4 delig**  
*Set de 4 leviers*

- 150 - 300 - 400 - 500 mm

**FOR 904U2**

**Hevel en koevoetset heavy duty 4 delig**  
*Set de 4 leviers à lame traversante*

- 930 mm recht
- 930 mm 30°
- 690 mm 75°
- 690 mm 90°

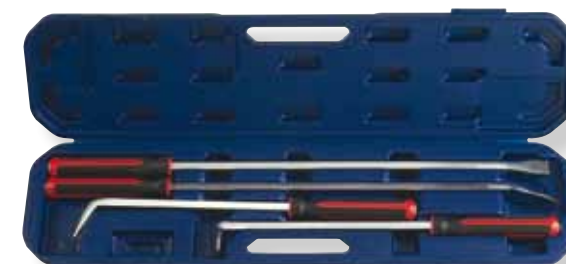
**FOR 68755**

**Draaibare rolkop breekijzer 13 mm hex**  
*Levier 13 mm hex*

- 
- Min lengte : 42 cm
- Max lengte : 55,5cm
- moment : 35

**FOR 68790**

**Draaibare rolkop breekijzer 16 mm hex**  
*Levier 16 mm hex*

- 
- Min lengte : 65,5 cm
- Max lengte : 90,5cm
- moment : 50







**FOR 3313**

Assortiment 3/8" 1000v  
Assortiment 1000v 3/8"

6903180	universele tang, pince universelles 180 mm
6904160	lange bektang, pince à becs long 160 mm
6905160	zijknijptang, pince coupante 160 mm
713024N	platte schroevendraaier 2.4 mm
71304N	platte schroevendraaier 4 mm
713055N	platte schroevendraaier 5.5 mm
7112N	PH2
7111N	PH1
88401	testlamp
82907	steekring 7 mm - clé mixte
82908	steekring 8 mm - clé mixte
82910	steekring 10 mm - clé mixte
82912	steekring 12 mm - clé mixte
82914	steekring 14 mm - clé mixte
8043150n	verlengstuk 150 mm - rallonge
8043250N	verlengstuk 250 mm rallonge
802320n	ratel 3/8 - cliquet
53906N tot 53919N	doppen 6 tot 19 mm



**FOR F2182**

Foam 10217 serie assortiment 1000v  
Assortiment 1000v foam

711N0	ph0 (60 mm L)
711N1	ph1 (80 mm L)
711N2	ph2 (100 mm L)
711N3	ph3 (150 mm L)
713N025	2.5 mm (75 mm L)
713N03	3 mm (100 mm L)
713N035	3.5 mm (100 mm L)
713N04	4 mm (100 mm L)
713N055	5.5 mm (125 mm L)
713N065	6.5 mm (150 mm L)
713N08	8 mm (175 mm L)
6903180	kombinatietang 180 mm L, pince universelle
6904200	lange bektang 200 mm L, pince à becs long
6911200	knijptang 200 mm L, pince coupante
6912160	striptang 160 mm L, pince à sertir
6909250	kabel snijder 250 mm
6806	striptang, pince a sertir
88408	Voltage tester 6-400v ac



**FORCE**®  
PROFESSIONAL TOOLS



### FOR T50410

TC module 4 tangen 1000v

TC module 4 pinces 1000v

6903180	universele tang, pince universelles 180 mm
6904160	lange bektang, pince à becs long 160 mm
6911200	zijkniptang, pince coupante 200 mm
6912160	striptang, pince à dénuder 160 mm



### FOR 2125

#### FOR 2126 pozidriv

Geïsoleerde schroevendraaierset 12 delig

Jeu de 12 tournevis 1000v

713N024, 713N03	2,4 (75 mm L) 3 (100 mm L)
713N035, 713N04	3,5 (100 mm L) 4 (100 mm L)
713N055, 713N065	5,5 (125 mm L) 6,5 (150 mm L)
713N08	8 (175 mm L)
711N0, 711N1	PH0 (60 mm L) PH1 (80 mm L)
711N2, 711N3	PH2 (100 mm L) PH3 (150 mm L)
2125P1	circuit tester



### FOR T20712

TC module geïsoleerde schroevendraaierset 7 delig

TC module 7 tournevis 1000v

711N1, 711N2	PH1 (80 mm L) PH2 (100 mm L)
713N03	3 mm (100 mm L)
713N04	4 mm (100 mm L)
713N055	5,5 mm (125 mm L)
713N065	6,5 mm (150 mm L)
2125	circuit tester



### FOR 20916

Geïsoleerde schroevendraaierset 9 delig

Jeu de 9 tournevis 1000v

713N024, 713N03	2,4 (75 mm L) 3 (100 mm L)
713N035, 713N04	3,5 (100 mm L) 4 (100 mm L)
713N055, 713N065	5,5 (125 mm L) 6,5 (150 mm L)
711N1, 711N2	PH1 (80 mm L) PH2 (100 mm L)
88401	circuit tester



Art.nr	mm	L mm
FOR 713N025	2.4 mm	75
FOR 713N03	3 mm	100
FOR 713N035	3.5 mm	100
FOR 713N04	4 mm	100
FOR 713N055	5.5 mm	125
FOR 713N065	6.5 mm	150
FOR 713N08	8 mm	175
FOR 711N0	PH0	60
FOR 711N1	PH1	80
FOR 711N2	PH2	100
FOR 711N3	PH3	150
FOR 712N0	PZ0	60
FOR 712N1	PZ1	80
FOR 712N2	PZ2	100
FOR 712N3	PZ3	150



1000v



### FOR 5048

Module 4 kabelschoentangen

Module 4 pinces à sertir

6801	kabelschoentang vr geïsoleerde kabelschoenen
6802	niet geïsoleerde kabelschoenen
6803	niet geïsoleerde kabelschoenen
6804	striptang, pince à dénuder



### FOR 68013

Ratel kabelschoenkrimptang 7 dlg

Set pince à sertir automatique 7pcs

- Kabelschoentang
- 4x Losse mondstuk
- Draad stripper
- Inbusleutel
- 6x Plastic bakje



### FOR 54111

Module 411 delig bindtang met kabelbinders

Module 411 pcs pince à dénuder incl strips





**Lange bektang**  
*Pince à becs long*



Art. nr.		mm
FOR 6904160	1000v	160
FOR 6904200	1000v	200

**Kniptang**  
*Pince coupante*



Art. nr.		mm
FOR 6905160	1000v	160 mm
FOR 6911200	1000V	200 mm

**Kabelschroentang, voor geïsoleerde kabelschoenen**  
*Pince à sertir, pour cosses isolées*

Bereik: 22-10 AWG (0,5-6 mm<sup>2</sup> DIN)



Art. nr.	mm	mm
FOR 6801	22-10AWG 0,5-6mm DIN	233 mm

**Kabelschroentang voor niet geïsoleerde kabelschoenen**  
*Pince à sertir, pour cosses non-isolées*



Art. nr.		mm
FOR 6802	0,5,0,75,1,0,1,5,2,5,4	233 mm

**Universele tang**  
*Pince universelle*

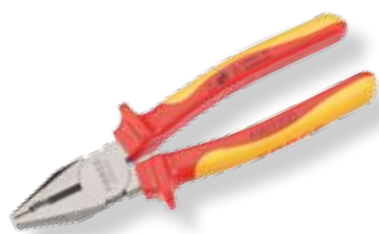

Art. nr.		mm
FOR 6903180	1000v	180 mm

**Striptang**  
*Pince à dénuder*



Art. nr.		mm
FOR 6912160	1000v	160 mm

**Kabelschroentang voor niet geïsoleerde kabelschoenen**  
*Pince à sertir pour cosses non-isolées*



Art. nr.	mm	mm
FOR 6803	0,5-1,1-2,5,4-6	233

**Striptang**  
*Pince à dénuder frontale autorégable*



Art. nr.	mm	mm
FOR 6804	0,2 tot 3,5 mm	178 mm

**Buigtang ronde bekken**  
*Pince à becs ronds*



Art. nr.		mm
FOR 6908160	1000v	160 mm

**Waterpomptang**  
*Pince multiprise*



Art. nr.		mm
FOR 6907250	1000v	250 mm

**Automatische striptang**  
*Pince à dénuder*



Art. nr.	mm	mm
FOR 6805A		210L

**Kabelschroentang**  
*Pince à sertir*



Art. nr.	mm	mm
FOR 6806		245L



**FOR 2125P1**

Spanningszoeker contactloos AC100 - 600V  
*Testeur de circuit*

**FOR 88401**

Stroomtester 110 -250V AC  
*Testeur de circuit*

**FOR 88422**

Stroomtester 6-24v  
*Testeur de circuit 6-24v*

**FOR 88425**

Stroomtester 3.28V  
*Testeur de circuit 3-28v*

**FOR 88431**

Stroomtester 6-12-24v  
*Testeur de circuit 6-12-24v*

**FOR 88408**

Universele elektronische tweepolige spannings tester  
 6-400V AC/DC met 7traps LED 6V-12V-24V-50V-120V-220V-  
 400V  
*Testeur de tension 6-400v AC/DC*

**FOR 88426**

Multi tester , alternator controle , startcontrole en accutestester 12v  
 met magneet  
*Testeur simple pour batteries 12v et alternateurs avec aimant*

**FOR 88443**

Digitale stroomtester 12-24volt  
*Testeur de circuit digital professionnel 12-24 volt*

**FOR 918C1**

Radio verwijderset 18 delig  
*Set de demontage pour le radio 18 pcs*

**FOR 912C1**

Stekker trekker 12 delig  
*Set de déconnecteurs de fiche 12 pcs*

- Ford, BMW, Mercedes, Opel, VW, Fiat, MAN, Saab, Renault, Porsche, PSA, Skoda, Audi, Mazda, Toyota

**FOR 990C1**

Automotive kabeltestset  
*Kit de sondes de test automobile*

Uitgebreide set meetsnoeren en onderdelen geschikt voor het testen, opsporing en onderzoek van automotieve elektronische schakelingen. Set bevat standaard 4 mm stekkers, geschikt voor gebruik met de meeste diagnostische multimeters en testapparatuur. Geleverd in een overzichtelijke koffer voor snelle locatie van de benodigde onderdelen.

**FOR 902C1**

Doorsteekpennen  
*Paire de pique-fils pour prive de tension*





### FOR 68611

- Ultra dunne COB LED lamp voor inspectie van krappe ruimtes of verlichting van een werkgebied zoals motorruim of een wielkast.
- Deze krachtige COB LED lamp geeft enorm veel licht tot 935 Lumen en is voorzien van een sterke magneet onder aan de handgreep.
- De magneet is gemonteerd in een vastelbaar kogelgewricht waardoor de lamp 360° draaibaar is.
- Handig om te bevestigen aan bv de binnenzijde van de motorkap of elders aan de carrosserie.
- De lichtintensiteit kan traploos worden ingesteld door een draaiknop aan de handgreep.
- De lamp is oplaadbaar via de meegeleverde 220v adapter of via de 12v USB aansluiting.
- Li-on batterij 3.7v - 2200mAh (3.5uur laden voor 2.5 uur verlichting)



### FOR 68612

#### COB LED Pen licht 5w

- Lamp type: COB LED
- Magneet: Ja
- Lichtintensiteit: 100 Lumen
- Afm. 165x25x35 mm
- Batterij type: 3 x 1.5 V AAA (meegeleverd)

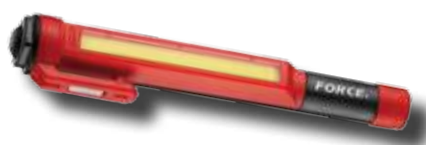

### FOR 68603

#### LED magnetische hoofdlamp



### LED ST-3463

#### LED werklucht met zoekfunctie

- 3 leds
- telescopische lengte 0.5m
- flexibele hals
- magnetisch
- 12p ctn/48

#### LED lampe stylo

- 3 leds
- telescopique longueur 0.5m
- magnetique



### LED 9150

#### LED werklucht

- 30 + 6 leds
- 12v lader AC DC
- magnetisch handvat draaibaar
- 6p ctn/12

#### Baladeuse



### LED 10-113

#### LED werklucht

- 24 leds
- display box 12 pcs
- met magneet



### Omvormer AC DC

Art. Nr.	
INV 150	150 watt 12v/230v 50Hz
INV 300	300 watt 12v
INV 600	600 watt 12v
INV 1000	1000 watt 12v



### CAR MS01

#### Memory saver

#### Convertisseur

- protégé contre perte d'information électronique
- 9v/12v batterie
- 2 cable 2m
- chargeur allume cigare



### TRI TRTH20A

#### Mini compressor 12v

- 12volt
- 10 bar
- 35L/min

#### Compresseur mini 12 volt



### FOR 9C2005

#### Accudrager

#### Poignée porte batterie automobile

- Het zelfklemmend mechanisme en de rubberen pads zorgen voor de benodigde grip en een veilige lift.
- De ideale hulp voor het gemakkelijk van bovenaf verwijderen van accu's
- Met 1 hand te bedienen



### CAR SB016

Startbooster 12 volt  
Demarreur 12 volt

Voltage	12v
Boost rate	3500A
Internal battery - tension batterie	12V-23Ah
Startstroomsterkte-courage de démarrage	1150A
Netto gewicht - poids net	9.2kg
Electronische automatische oplader	12V 1.5A
Automatische oplader	ja
lengte kabels - câble	90cm
koper kabels - câbles	28 mm <sup>2</sup>



### CAR C18-960

Startbooster met condensatoren 12 volt  
Demarreur à condensateurs 12 volt

Voltage	12V
Max kort Piek intensiteit/intensité de pointe	8000A
Startintensiteit/intensité de démarrage	1400A
cap	160F
laadtijd met batterij/temps de charge	2 min max
laadtijd met oplader	5 uur max
Netto gewicht	3.5 kg
voltage	15v
oplaad voltage	DC 12v & AC 220v 50Hz
werk temperatuur	-40° + 50°
levensduur	1000000 cycles



### CAR C16-3000

Professional Start booster met condensator 12v  
Demarreur à condensateur 12volt

Voltage	12V
Piekintensiteit/intensité de pointe	9000A
Startintensiteit/intensité de démarrage	1800A
veiligheidszekering	500A
laadtijd met batterij/temps de charge	10 sec tot 2 min. bij draaiende motor
laadtijd met oplader	6-7 uur met adapter
Netto gewicht	9.5kg
oplader	12V 50 Hz
Alarm buzzer	ja
automatische acculader	ja
12v accesoire aansluiting	ja
aan/uit schakelaar	ja
lengte kabels	160cm
dikte kabels	50mm <sup>2</sup>



### CAR SB076 1224

Start truck 12/24v  
Demarreur 12/24v pour les poids lourds

Voltage	12V/24V
Piekvermogen - courant de crête	7000/3500A
Startvermogen - courant de démarrage	2300/1150A
Internal battery - tension batterie	12V-46Ah/24V-23Ah
Netto gewicht	28kg
Electronische automatische oplader	12V 4A
Automatische oplader	ja
automatische acculader	ja
12v accesoire aansluiting	ja
aan/uit schakelaar	ja
lengte kabels - longueur câbles	182cm
koper kabels	50 mm <sup>2</sup>
trolley avec 2 roues et une poignée	ja



### CAR SB077 24

Start truck 24v  
Demarreur 24v

Voltage	24V
Piekvermogen	3700 Amp
Startvermogen	1450 Amp
Internal battery	24v-31Ah
Netto gewicht/ poids net	32kg
Electronische automatische oplader	24V - 2A
Automatische oplader	ja
lengte kabels	182cm
koper kabels	50 mm <sup>2</sup>
trolley	ja

### CAR CB50S

Batterijlader  
- Rated input : 230

Ref. cap. Ah15h : 120/320

- gewicht : 15  
- 370x250x250

Rated cap. 480/730

- Voltage : 12/24  
- Rated current : 25  
- Boost current : 30



### CAR LEM61220

Acculader druppellader 6/12v 2.0A  
3 adapters



### CAR LEM1238

Acculader druppellader 12v 3.8A  
3 adapters



### CAR LEM122470

Acculader druppellader 12/24V 7.0A  
3 adapters



### VERF FR107 1.4

Verfspuit met plastic bovenbeker 1.4 mm 600cc  
Pistolet à godet supérieur 1.4 mm 600cc

### VERF FR107 1.7

Verfspuit met plastic bovenbeker 1.7 mm 600cc  
Pistolet à godet supérieur 1.7 mm 600cc

### VERF FR107 2.0

Verfspuit met plastic bovenbeker 2.0 mm 600cc  
Pistolet à godet supérieur 2.0 mm 600cc

### VERF FR107 2.5

Verfspuit met bovenbeker 2.5 mm 600cc  
Pistolet à godet supérieur 2.5 mm 600cc

- Werkdruk : 2-5 bar
- Luchtverbruik : 160-300L/min
- Gewicht : 750gr

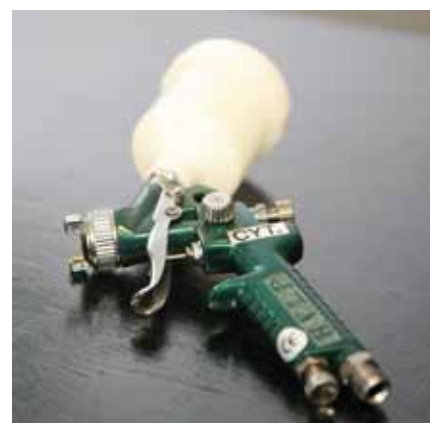

### VERF CY-1827T

Verfspuit met bovenbeker 1.7 mm  
Pistolet à godet supérieur 1.7 mm

- kunststof beker 600cc
- werkdruk : 4bar
- Luchtdrukverbruik : 400L/min
- gewicht : 600gr



### VERF SJ101A

Star verfspuit met onderbeker  
- luchtverbruik 175-300 l/m druk 3 kg  
- luchtregeling 1.8 mm - tête 1.8 mm

Star pistolet de peinture à godet inférieure

Art. Nr.	
VERF ON SJ101K	Naald sproeierset 1.8 mm
VERF ON SJ101AR	O ringen set



### VERF FR206 0.8

Bovenbeker HVLP 250cc  
- spuitopening 0.8 mm - tête 0.8 mm  
Pistolet à godet supérieur HVLP 250cc

### VERF FR206 1

Bovenbeker HVLP 250cc  
- spuitopening 1.0 mm - tête 1.0 mm  
Pistolet à godet supérieur HVLP 250cc

- Professioneel verfspuitpistool voor perfecte lakresultaten in de automobielsector.
- Precies, gelijkmatig en optimaal verf aanbrengen.
- Met lucht- en verfhoeveelheidsregeling.
- Met High Volume Low Pressure: lage verstuivingsdruk vermindert de verspreiding van de spuitnevel: aanbrengen van meer materiaal bij minder lakverbruik.
- Traploos instelbaar voor ronde en brede straal.
- Werkdruk : 2-3 Bar
- Luchtverbruik : 100-170 l/min
- Kunststof voorraadbeker 600 ml
- Roestvrij stalen naald



### VERF FR906 1.4

Verfspuit HVLP bovenbeker 1.4 mm 600cc  
Pistolet à godet supérieur 1.4 mm 600cc

### VERF FR906 1.7

Verfspuit HVLP bovenbeker 1.7 mm 600cc

### VERF FR906 2.0

Verfspuit HVLP bovenbeker 2 mm 600cc



### Onderdelen - Assecoires

Art. Nr.	
VERF ON FR107 1.4	Naald sproeierset 1.4 mm
VERF ON FR107 1.7	Naald sproeierset 1.7 mm
VERF ON FR107 2.5	Naald sproeierset 2.5 mm
VERF ON FR906 1.4	Naald sproeierset 1.4 mm
VERF ON FR906 1.7	Naald sproeierset 1.7 mm
VERF ON H827W R	o ringen set
VERF ON FR107 28	bovenbeker 600cc



### FOR 9U0202

Blaaspistool 150 mm  
Soufflette 150 mm



### PNE L300

Blaaspistool 300 mm  
Soufflette 300 mm



### FOR 825411

Korte slagmoersleutel 1/2"  
- 9000tm 677Nm  
- gewicht 1,3kg  
- lengte : 109 mm  
1/2" Clé à chocs réversible compacte



### PNE CY2855

Slagmoersleutel 1/2"  
- 7000 t/m 678nw  
Clé à chocs 1/2"



### PNE CY3260

Slagmoersleutel 1/2" composite  
- Max torq 1350 Nw  
- Working torque 70-1100 Nw  
- dubbele hamer  
Clé à chocs réversible 1/2" en matériau composite



### PNE CY222

Slagmoersleutel 3/4"  
- 6500 t/m 750 ft/lbs  
Clé à chocs 3/4"



### PNE CY3266

Slagmoersleutel 3/4" composite  
- Max torq 1450Nw  
- working torque 70-1200 Nw  
- dubbele hamer  
3/4" Clé à chocs réversible en matériau composite



### FOR 9U0201

Persluchthaspel 15 meter  
Enrouler à air 15 mètre

- 8mm x12.0 mm
- max 20 bar
- afm 330x150x410 mm



### FOR 9U0201A

Persluchthaspel 12 meter  
Enrouler à air 12 mètre

- 10mmx13.5 mm
- max 20 bar
- afm 330x150x410 mm



### KOM 252504

Kompressor 25L  
- 220 L/min aangezogen/min aspiré  
- 8 bar  
- 2pk monofasig 230V/2cv monophasé  
- 1 cyl kop 2800tr /min / Tête 1 cyl  
- 25 L ketelinhoud / 25 L de réservoir  
- L 610 x B270 x H590 - 25kg 76dB



### KOM 050240

Kompressor 50L  
- 240 L/min aangezogen / min aspiré  
- 8 bar  
- 2pk monofasig 230V/ 2cv monophasé  
- 1 cil kop 900 tr/min / Tête 1cyl  
- 50 L ketelinhoud / 50 L de réservoir  
- L 850 x B400 x H740 - 54kg 72dB



### KOM 100400

Kompressor 100L  
- 400 L/min aangezogen / min aspiré  
- 8 bar  
- 3pk monofasig 230V/ 3cv monophasé  
- 2 cil kop 800 tr/min / Tête 2 cyl  
- 100 L ketelinhoud / 100 L de réservoir  
- L 1200 x B450 x H830 - 65kg 72dB





**BAG 2500 25**

Bagagespanner 25 mm 6.5 meter 800kg  
- dubbele S haken  
*Sangle d'arrimage 25 mm 6.5m 800kg*



**BAG 3500 38**

Bagagespanner 38 mm 6.5 meter 2,5 ton  
- dubbele S haken  
*Sangle d'arrimage 38 mm 6.5 m 2.5 ton*

**BAG 5000 50**

Bagagespanner 50 mm 9 meter 5 ton  
- dubbele S haken  
*Sangle d'arrimage 50 mm 9m 5 ton*



**BAG 10000**

Bagagespanner 100 mm 10 meter 10 ton  
*Sangle d'arrimage 100 mm 10m 10 ton*

**HAN D251**

Driver handschoen wit + blauw schaapsnappa leder + katoenen rug  
- Verpakking :10/200 per karton  
- maat 9 of 10  
*Gants driver blanc + blue (cuir de chèvre)*



**HAN 3-1260**

Latex werkhandschoen, rode polyester met zwarte latex foamcoating op de handpalm  
*Gants latex*



**FOR 6540204A**

Bankschroef 100 mm  
*Etau 100 mm*

**FOR 6540205A**

Bankschroef 125 mm  
*Etau 125 mm*

**FOR 6540206A**

Bankschroef 150 mm  
*Etau 150 mm*

**FOR 6540208A**

Bankschroef 200 mm  
*Etau 200 mm*



### TRI TR90051

Handtakel 500 kg  
- Lift hoogte : 295 mm  
*Palan 500kg*



### TRI TR90101

Handtakel 1000 kg  
- Lift hoogte : 330 mm  
*Palan 1000kg*

### TRI TR9405

Rolkat 500 kg  
- Lengte ketting : 3 m  
*Chariot pour palans 500kg*



### TRI TR9410

Rolkat 1000 kg  
- Lengte ketting : 3 m  
*Chariot pour palans 1000kg*

### TRI HGS 250-500

Electrische takel 250-500 kg  
*Trueil électrique 250-250kg*



### WIN 702016

Winch met stalen kabel 900kg 10m  
*Trueil manuel 900kg 10m*



### WIN KEW2000

Electrische winch 950 kg  
- Motor 0.7kw/0.9hp (12v)  
- kabel : 4 mm x 15m  
*Trueil électrique 950kg*



### TRI TRTH20A

Mini compressor 12v  
- 12volt  
- 10 bar  
- 35L/min  
*Compresseur mini 12 volt*





**FOR G11**

Petje Force  
Casquette

**FOR G16**

Polo Force  
maten S-M-L-XL

**FOR FLEECE**

Fleece Force  
Maten L-XL

**Stickers - Autocollants**

Art. Nr.	
FOR LOGO12	12 cm lang
FOR LOGO30	30 cm lang
FOR LOGO50	50 cm lang

**HANGERS voor doppen - Crochet pour douilles**

Art. Nr.	
FOR 8162	1/4"
FOR 8163	3/8"
FOR 8164	1/2"
FOR 8166	3/4"

**HANGERS voor ratels - Crochet pour cliquets**

Art. Nr.	
FOR PI8022	1/4"
FOR PI8023	3/8"
FOR PI8024	1/2"

**HANGERS voor T hendel - Crochet pour manche**

Art. Nr.	
FOR PI8032	1/4"
FOR PI8033	3/8"
FOR PI8034	1/2"

**FOR 2751**

Schroevendraaierset 75 delig  
Jeu de tournevis 75 pcs

Art. Nr.	
7110-7111-7113	PH0 (60 mm L) PH1 (80 mm L) PH3 (150 mm L)
7111S-7112S	PH1 (25 mm L) PH2 (25 mm L)
713 03...08	3 mm (75 mm L) 3.5 mm (100 mm L) 4 mm (100 mm L) 5.5 mm (125 mm L) 6.5 mm (150 mm L) 8 mm (175 mm L)
713055S-713065S	5.5 mm (25 mm L) 6.5 mm (25 mm L)
	5 schroevendraaiers van ieder
7112	PH2 (100 mm L) 10 stuks

**FOR 2752**

Schroevendraaierset 75 delig  
Jeu de tournevis 75 pcs

Art. Nr.	
7120-7121-7123	PZ0 (60 mm L) PZ1 (80 mm L) PZ3 (150 mm L)
7121S-7122S	PZ1 (25 mm L) PZ2 (25 mm L)
713 03...08	3 mm (75 mm L) 3.5 mm (100 mm L) 4 mm (100 mm L) 5.5 mm (125 mm L) 6.5 mm (150 mm L) 8 mm (175 mm L)
713055S-713065S	5.5 mm (25 mm L) 6.5 mm (25 mm L)
	5 schroevendraaiers van ieder
7122	PZ2 (100 mm L) 10 stuks



### FOR 50121

Doppenkast 3 verdiepingen  
Armoire pour douilles



### FOR 50121A429

Doppenkast 429 delig  
Jeu de douilles 429 pcs

Art. Nr.		1/4"
525 04...14	6 kant - 6 pans 10 st/ pcs	4-4.5-5-5.5-6-7-8-9-10-11-12-13-14 mm
		3/8"
535 08...19	10 stuks / pcs	8-10-12-13-14 mm
	9 stuks/ pcs	17-19 mm
		1/2"
545 08...32	10 stuks	8-10-11-12-13-14-15-16-17-18-19-20-22-23-24 mm
	9 stuks	25-26-27 mm
	8 stuks	28-30-32 mm
	20 stuks	21 mm



### FOR 50121B460

Doppenkast 460 delig torx - inbus  
Jeu de douilles 460 pcs torx - hex

Art. Nr.		1/4"
32432 03...08	10 st/ pcs	3-4-5-6-7-8 mm inbus-hex
32632 08...40	10 st/ pcs	T8-T10-T15-T20-T25-T27-T30-T40 torx
		1/2" inbus-hex
344055 07...12	10 st/ pcs	7-8-10-12 mm inbus-hex
34406514	10 st/ pcs	14 mm (65 mm L) inbus-hex
344070 17...19	10 st/ pcs	17-19 mm (70 mm L) inbus
344100 06...10	10 st/ pcs	6-8-10 (100 mm L) inbus
34410012	9 st/ pcs	12 mm (100 mm L)
346055 45...70	10st/ pcs	T45-T50-T55-T60-T70
		1/2" Torx
34607080	10st/ pcs	T80 (70 mm L)
346100 40	10st/ pcs	T40 (100 mm L)
346100 60...70	9st/ pcs	T60-T70 (100 mm L)
348055 06...14	10st/ pcs	M6-M8-M10-M12-M14
34810016T	10st/ pcs	M16 (100 mm L) magnetisch
348100 08...10	10st/ pcs	M8-M9-M10 (100 mm L)
348100 12...14	9st/ pcs	M12-M14 (100 mm L)
34810018	7st/ pcs	M18 (100 mm L)
34810016T	8st/ pcs	M16 (100 mm L) magnetisch



### FOR 50121E275

Doppenkast 275 delig slagdoppen  
Jeu de douilles à choc 275 pcs

Art. Nr.		1/2"
445 10...41	10 stuks/ pcs	10-12-13-14-15-16-17-18-19-21-22 mm
	9 stuks/ pcs	24 mm
	8 stuks/ pcs	27 mm
	7 stuks/ pcs	30-32 mm
	6 stuks/ pcs	36 mm
	5 stuks/ pcs	41 mm
44585 10 ...36	10 stuks/ pcs	10-12-13-14-15-16 mm
	8 stuks/ pcs	17-18-19 mm
	7 stuks/ pcs	21-22 mm
	6 stuks/ pcs	24 mm
	5 stuks/ pcs	27-30-32 mm
	4 stuks/ pcs	36 mm





**FOR 50217BBS A**

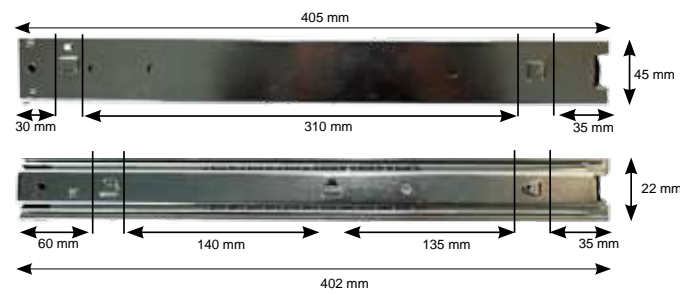

**FOR 50217BBS B**

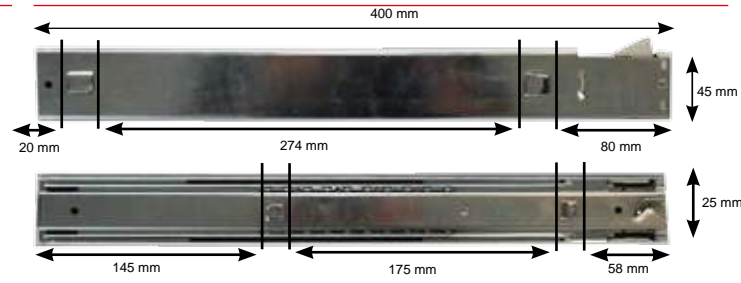

**FOR 50217BBS C**

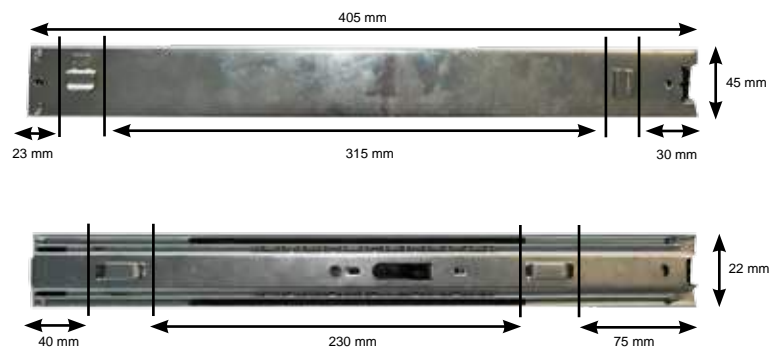

**FOR 10217BBS E**

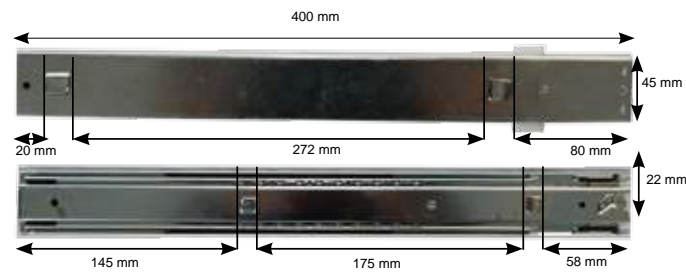

**FOR 10318BBS F**



**ZA CAT 2019-2020**

Algemene catalogus Zasco  
*Catalogue générale Zasco*



**FOR CAT V9**

Algemene catalogus Force  
*Catalogue générale Force*



**FOR CAT V5**

Catalogus Force Tool Storage V5



**FOR CAT V5**

Catalogus Force Auto Special Tools



**B**

BAG 10000	306
BAG 2500 25	306
BAG 3500 38	306
BAG 5000 50	306

**C**

CAR C16-3000	300
CAR C18-960	300
CAR CB50S	301
CAR LEM122470	301
CAR LEM1238	301
CAR LEM61220	301
CAR MS01	299
CAR SB016	300
CAR SB076 1224	301
CAR SB077 24	301

**FOR 1000**

FOR 1013-562	41
FOR 1013R562	41
FOR 102101R/102101C	24
FOR 102102R/102102C	24
FOR 102103	24
FOR 102104R/102104C	24
FOR 102105R/102105C	24
FOR 102106B/102106A	24
FOR 102106R/102106	24
FOR 10210H1	28
FOR 10210H2	28
FOR 10210H3	28
FOR 10210H4	28
FOR 10217 SL	25
FOR 102170BBS E	25
FOR 102170C	25
FOR 102170CB	25
FOR 102170DL	25
FOR 102170DS	25
FOR 102170LK	25
FOR 102170LK	27
FOR 10217B286	36
FOR 10217B306	37
FOR 10217BBS E	314
FOR 10217C198	42
FOR 10217C259	42
FOR 10217C308	43
FOR 10217C361	38
FOR 10217R	23
FOR 10217R219	34
FOR 10217R245	35
FOR 10217R361	38
FOR 10218B	23
FOR 10218B376	38
FOR 10218C376	38
FOR 10218R	23
FOR 10218R376	38
FOR 10225C	10
FOR 10225C181	21
FOR 10225C247	20
FOR 10225R	10
FOR 10225R181	21
FOR 10225R247	20
FOR 103106	27
FOR 103106R	27
FOR 103180C	27
FOR 103180CB	27
FOR 103180DL	27
FOR 103180DS	27
FOR 10318B	26
FOR 10318BBS	27
FOR 10318BBS F	314
FOR 10318C	26
FOR 10318C298	44
FOR 10318C431	40
FOR 10318C437	39
FOR 10318C509	46
FOR 10318C607	47
FOR 10318C610	45
FOR 10318R	26
FOR 10318R437	39
FOR 10318R509	46
FOR 10323C	11
FOR 10323R	11

FOR 10517	29
FOR 1543005	184
FOR 1543006	184
FOR 1543007	184
FOR 1543008	184
FOR 1543010	184
FOR 1543012	184
FOR 1543014	184
FOR 1563010	184
FOR 1563015	184
FOR 1563020	184
FOR 1563025	184
FOR 1563027	184
FOR 1563030	184
FOR 1563040	184
FOR 1563045	184
FOR 1563050	184
FOR 1563055	184
FOR 1563060	184
FOR 1563530	184
FOR 1563540	184
FOR 1567020	184
FOR 1567025	184
FOR 1567030	184
FOR 1567040	184
FOR 1567045	184
FOR 1567050	184
FOR 1567055	184
FOR 1567060	184
FOR 1743004	194
FOR 1743005	194
FOR 1743006	194
FOR 1743007	194
FOR 1743008	194
FOR 1743010	194
FOR 1743012	194
FOR 1743014	194
FOR 1747504	194
FOR 1747505	194
FOR 1747506	194
FOR 1747507	194
FOR 1747508	194
FOR 1747510	194
FOR 1747512	194
FOR 17611555	194
FOR 17612040	194
FOR 17612050	194
FOR 17612055	194
FOR 1763020	194
FOR 1763025	194
FOR 1763027	194
FOR 1763030	194
FOR 1763040	194
FOR 1763045	194
FOR 1763050	194
FOR 1763055	194
FOR 1763060	194
FOR 1767520	194
FOR 1767525	194
FOR 1767527	194
FOR 1767530	194
FOR 1767540	194
FOR 1767545	194
FOR 1767550	194
FOR 1767555	194
FOR 1767560	194
FOR 1773010	195
FOR 1773015	195
FOR 1773020	195
FOR 1773025	195
FOR 1773027	195
FOR 1773030	195
FOR 1773040	195
FOR 1773045	195
FOR 1773050	195
FOR 1773055	195
FOR 1773060	195
FOR 1777510	195
FOR 1777515	195
FOR 1777520	195
FOR 1777525	195
FOR 1777530	195
FOR 1777540	195
FOR 1777545	195

FOR 1777550	195
FOR 1777555	195
FOR 1777560	195
FOR 1783005	195
FOR 1783006	195
FOR 1783008	195
FOR 1783010	195
FOR 1783012	195
FOR 1783014	195
FOR 1787505	195
FOR 1787506	195
FOR 1787508	195
FOR 1787510	195
FOR 1787512	195
FOR 1967560	194
FOR 1967570	194

**FOR 2000**

FOR 20610	182
FOR 20611	177
FOR 2068	177
FOR 20711	89
FOR 20719	180
FOR 2073	89
FOR 2073S	89
FOR 2081	188
FOR 20812	89
FOR 2081C	188
FOR 2087	183
FOR 2088	183
FOR 20915	178
FOR 20916	186
FOR 20916	292
FOR 20918	189
FOR 2095	60
FOR 2095	170
FOR 2095S	60
FOR 2095S	170
FOR 2096	61
FOR 2096	171
FOR 2097	60
FOR 2097	205
FOR 2097B	60
FOR 2097B	205
FOR 2097S	60
FOR 2097S	205
FOR 21012	189
FOR 21013	189
FOR 21014	88
FOR 21016	88
FOR 21022	188
FOR 2108	59
FOR 2108	182
FOR 2109	59
FOR 2109	182
FOR 2110-5	88
FOR 21111	188
FOR 21115	88
FOR 21111	89
FOR 21121	89
FOR 2119T	180
FOR 2125	59
FOR 2125	186
FOR 2125	292
FOR 2125P1	187
FOR 2125P1	296
FOR 2126	59
FOR 2126 pozidriv	186
FOR 2126 pozidriv	292
FOR 2133	88
FOR 2133-5	88
FOR 2134	61
FOR 2134	171
FOR 2137A	59
FOR 2137A	180
FOR 2141	61
FOR 2141	206
FOR 2141T	61
FOR 2141T	206
FOR 2142A	59
FOR 2142A	178
FOR 2222	90
FOR 2292	90
FOR 2311	189

**FOR 3000**

FOR 3039	101
FOR 3065	100
FOR 3082	100
FOR 3086	100
FOR 30911	101
FOR 30912	101
FOR 3093	100
FOR 3093S	104
FOR 3095	100
FOR 3099	100
FOR 321320	97
FOR 321321	97
FOR 321322	97
FOR 321323	97
FOR 322320	97
FOR 322321	97
FOR 322322	97
FOR 322323	97
FOR 3233204	97
FOR 32332055	97
FOR 32332065	97
FOR 3233207	97
FOR 3243203	96
FOR 3243204	96
FOR 3243205	96
FOR 3243206	96
FOR 3243207	96
FOR 3243208	96
FOR 3243210	96
FOR 3261	103
FOR 3263208	96
FOR 3263210	96
FOR 3263215	96
FOR 3263220	96
FOR 3263225	96
FOR 3263227	96
FOR 3263230	96
FOR 3263230	96
FOR 3263235	96
FOR 3273240	96
FOR 3273210	96
FOR 3273215	96
FOR 3273220	96
FOR 3273225	96
FOR 3273227	96
FOR 3273230	96
FOR 3273235	96
FOR 3273240	96
FOR 32F3210	96
FOR 32F3215	96
FOR 32F3220	96
FOR 32F3225	96
FOR 32F3227	96
FOR 32F3230	96
FOR 32F3240	96
FOR 3313	291
FOR 33405003	107
FOR 33405004	107
FOR 33405005	107
FOR 33405006	107
FOR 33405007	107
FOR 33405008	107
FOR 33405009	107
FOR 33405010	107
FOR 33405012	107
FOR 33405055	107
FOR 3365008	107

FOR 2312	91
FOR 2312-5	91
FOR 2331	188
FOR 2402	91
FOR 2421	90
FOR 2649014	145
FOR 2649016	145
FOR 2649017	145
FOR 2649019	145
FOR 2649022	145
FOR 2649024	145
FOR 2649027	145
FOR 2649030	145
FOR 2649032	145
FOR 2751	311
FOR 2752	311

FOR 3365010	107
FOR 3365015	107
FOR 3365020	107
FOR 3365025	107
FOR 3365027	107
FOR 3365030	107
FOR 3365040	107
FOR 3365045	107
FOR 3365050	107
FOR 3365055	107
FOR 3365060	107
FOR 3375008	107
FOR 3375010	107
FOR 3375015	107
FOR 3375020	107
FOR 3375025	107
FOR 3375027	107
FOR 3375030	107
FOR 3375040	107
FOR 3375045	107
FOR 3375050	107
FOR 3375055	107
FOR 3375060	107
FOR 3385005	107
FOR 3385006	107
FOR 3385008	107
FOR 3385009	107
FOR 3385010	107
FOR 3385012	107
FOR 33909006	107
FOR 33909007	107
FOR 33909008	107
FOR 34405504	127
FOR 34405505	127
FOR 34405506	127
FOR 34405507	127
FOR 34405508	127
FOR 34405509	127
FOR 34405510	127
FOR 34405512	127
FOR 34406514	127
FOR 34407017	127
FOR 34407019	127
FOR 34410005	127
FOR 34410006	127
FOR 34410008	127
FOR 34410009	127
FOR 34410010	127
FOR 34410011	127
FOR 34410012	127
FOR 34411005	127
FOR 34411006	127
FOR 34411007	127
FOR 34411008	127
FOR 34411010	127
FOR 34411012	127
FOR 34411014	127
FOR 34411017	127
FOR 34411019	127
FOR 34412008	127
FOR 34414006	127
FOR 34414008	127
FOR 34414010	127
FOR 34416006	127
FOR 34418005	127
FOR 34422006	127
FOR 34605520	125
FOR 34605525	125
FOR 34605527	125
FOR 34605530	125
FOR 34605535	125
FOR 34605540	125
FOR 34605545	125
FOR 34605547	125
FOR 34605550	125
FOR 34605555	125
FOR 34605560	125
FOR 34605570	125
FOR 34607080	125
FOR 346100100	125
FOR 34610020	125
FOR 34610025	125
FOR 34610027	125

FOR 34610030	125
FOR 34610040	125
FOR 34610045	125
FOR 34610050	125
FOR 34610055	125
FOR 34610060	125
FOR 34610070	125
FOR 34612040	125
FOR 34612045	125
FOR 346140100	125
FOR 34614045	125
FOR 34614050	125
FOR 34614055	125
FOR 34614060	125
FOR 34614070	125
FOR 34705520	126
FOR 34705527	126
FOR 34705530	126
FOR 34705540	126
FOR 34705545	126
FOR 34705550	126
FOR 34705555	126
FOR 34705560	126
FOR 34705570	126
FOR 34707080	126
FOR 347100100	126
FOR 34710030	126
FOR 34710040	126



FOR 46560	145	FOR 5055P4	224	FOR 52514	94	FOR 5356311	105	FOR 5453.8	123	FOR 54932	122	FOR 6081D	146	FOR 656M	269
FOR 46570	145	FOR 5055P4	224	FOR 5255004	94	FOR 5356311.16	105	FOR 54530	122	FOR 5497708	124	FOR 6083	144	FOR 65701	286
FOR 46817	145	FOR 5055P4P	224	FOR 5255005	94	FOR 5356312	105	FOR 54532	122	FOR 5497709	124	FOR 6083D	146	FOR 6571409	286
FOR 46819	145	FOR 5056P1	225	FOR 52550055	94	FOR 5356313	105	FOR 54534	122	FOR 5497710	124	FOR 6091	144	FOR 65802	267
FOR 46824	145	FOR 5056P2	225	FOR 5255006	94	FOR 5356314	105	FOR 54536	122	FOR 5497711	124	FOR 617	288	FOR 65803	266
FOR 48510024	149	FOR 5056P3	225	FOR 5255007	94	FOR 5356315	105	FOR 5455.8	123	FOR 5497712	124	FOR 61701	288	FOR 65805	267
FOR 48510024	149	FOR 5056P4	225	FOR 5255008	94	FOR 5356316	105	FOR 5457.16	123	FOR 5497713	124	FOR 61702	288	FOR 65815	267
FOR 48510026	149	FOR 5056P5	225	FOR 5255009	94	FOR 5356317	105	FOR 5457.8	123	FOR 5497714	124	FOR 617L	288	FOR 6590103	280
FOR 48510027	149	FOR 5061	240	FOR 5255010	94	FOR 5356318	105	FOR 5457708	124	FOR 5497715	124	FOR 618	223	FOR 6590104	280
FOR 48510027	149	FOR 50613	216	FOR 5255011	94	FOR 5356319	105	FOR 5457709	124	FOR 5497716	124	FOR 618	259	FOR 6590106	280
FOR 48510030	149	FOR 50622	165	FOR 5255012	94	FOR 5356320	105	FOR 545771.0	123	FOR 5497717	124	FOR 61802	223	FOR 6590108	280
FOR 48510030	149	FOR 50651	157	FOR 5255013	94	FOR 5356321	105	FOR 545771.1.16	123	FOR 5497718	124	FOR 61802	259	FOR 6590203	280
FOR 48510032	149	FOR 5066	168	FOR 5255014	94	FOR 5356322	105	FOR 5457714	124	FOR 5497719	124	FOR 619	236	FOR 6590206	280
FOR 48510032	149	FOR 5071	203	FOR 52604	95	FOR 535633.4	105	FOR 5457711	124	FOR 5497720	124	FOR 61901	237	FOR 6590208	280
FOR 48510033	149	FOR 50713	62	FOR 52605	95	FOR 535633.8	105	FOR 5457711.16	123	FOR 5497721	124	FOR 61904	236	FOR 6590909	280
FOR 48510034	149	FOR 50713	285	FOR 52606	95	FOR 535633.16	105	FOR 5457712	124	FOR 5497722	124	FOR 61908	236	FOR 65909130	280
FOR 48510035	149	FOR 5072LB	200	FOR 52607	95	FOR 535635.8	105	FOR 5457713	124	FOR 5497723	124	FOR 61910	237	FOR 66301	224
FOR 48510036	149	FOR 5072XL	199	FOR 52608	95	FOR 535637.16	105	FOR 5457713.16	123	FOR 5497724	124	FOR 61910L	237	FOR 66302	224
FOR 48510038	149	FOR 5072XLB	201	FOR 52610	95	FOR 535639.16	105	FOR 5457714	124	FOR 5497725	124	FOR 61911	237	FOR 66303	225
FOR 48510038	149	FOR 5072XLBS	201	FOR 52611	95	FOR 5357.16	105	FOR 5457715	124	FOR 5497726	124	FOR 61912	236	FOR 664	276
FOR 48510041	149	FOR 50816	62	FOR 52612	95	FOR 5357.8	105	FOR 5457715.16	123	FOR 5497727	124	FOR 61913	236	FOR 664P	276
FOR 48510046	149	FOR 50816	169	FOR 52614	95	FOR 5359.16	105	FOR 5457716	124	FOR 5497728	124	FOR 61915	239	FOR 665B	285
FOR 48510050	149	FOR 5083F	202	FOR 52616	95	FOR 53604	106	FOR 5457717	124	FOR 5497729	124	FOR 61917	239	FOR 66601	276
FOR 48524	148	FOR 5086	158	FOR 5261C	157	FOR 53605	106	FOR 5457718	124	FOR 5497730	124	FOR 61920	238	FOR 66603	276
FOR 48527	148	FOR 50910BS	60	FOR 5265004	95	FOR 53606	106	FOR 5457719	124	FOR 5497732	124	FOR 61920B	238	FOR 66610	276
FOR 48530	148	FOR 50910BS	204	FOR 5265005	95	FOR 53607	106	FOR 5457720	124	FOR 56519	132	FOR 61928	242	FOR 666150	280
FOR 48532	148	FOR 50911	62	FOR 5265006	95	FOR 53608	106	FOR 5457721	124	FOR 56521	132	FOR 61933	238	FOR 66617	278
FOR 48533	148	FOR 50911	165	FOR 5265007	95	FOR 53610	106	FOR 5457722	124	FOR 56522	132	FOR 61936	238	FOR 672	280
FOR 48535	148	FOR 50912	60	FOR 5265008	95	FOR 53611	106	FOR 5457723	124	FOR 56523	132	FOR 6201	131	FOR 6720912	280
FOR 48536	148	FOR 50912	204	FOR 5265010	95	FOR 53612	106	FOR 5457724	124	FOR 56524	132	FOR 6201 5	131	FOR 6721216	280
FOR 48538	148	FOR 5093LB	201	FOR 5290045	94	FOR 53614	106	FOR 5457725	124	FOR 56526	132	FOR 6203125	259	FOR 6721611	280
FOR 48541	148	FOR 5093LBS	201	FOR 52904	94	FOR 53616	106	FOR 5457726	124	FOR 56527	132	FOR 6206175	259	FOR 6722227	280
FOR 48542	148	FOR 5093XL	199	FOR 52905	94	FOR 53618	106	FOR 5457727	124	FOR 56528	132	FOR 62104	258	FOR 674	259
FOR 48546	148	FOR 5093XLBS	201	FOR 52906	94	FOR 53620	106	FOR 5457728	124	FOR 56529	132	FOR 62110	258	FOR 67402	259
FOR 48550	148	FOR 5096A805	223	FOR 52907	94	FOR 5365504	106	FOR 5457729	124	FOR 56530	132	FOR 62518	262	FOR 678	259
FOR 48555	148	FOR 5096P1	222	FOR 52908	94	FOR 5365505	106	FOR 545773.4	123	FOR 56532	132	FOR 62520	273	FOR 68013	293
FOR 48558	148	FOR 5096P2	222	FOR 52909	94	FOR 5365506	106	FOR 545773.8	123	FOR 56533	132	FOR 62521	272	FOR 6805A	295
FOR 48560	148	FOR 5096P3	222	FOR 52910	94	FOR 5365507	106	FOR 5457730	124	FOR 56534	132	FOR 62527	272	FOR 6806	295
FOR 48565	148	FOR 5096P4	222	FOR 52911	94	FOR 5366308	106	FOR 5457732	124	FOR 56535	132	FOR 62602	285	FOR 681600	270
FOR 48570	148	FOR 5096P5	223	FOR 52912	94	FOR 5366310	106	FOR 545773.8	123	FOR 56536	132	FOR 62603	285	FOR 681600	282
FOR 48575	148	FOR 5096P6	223	FOR 52913	94	FOR 5366311	106	FOR 545777.16	123	FOR 56538	132	FOR 62604	285	FOR 681B400	270
FOR 48580	148	FOR 5096P7	223	FOR 52914	94	FOR 5366312	106	FOR 545777.8	123	FOR 56540	132	FOR 62701	272	FOR 681D515	273
FOR 48585	148	FOR 5096P8	223	FOR 5295005	94	FOR 5366314	106	FOR 545779.16	123	FOR 56541	132	FOR 627270	272	FOR 68301	285
FOR 48590	148	FOR 5096P803	223	FOR 52950055	94	FOR 5366316	106	FOR 5459.16	123	FOR 56546	132	FOR 627370	272	FOR 68302	285
FOR 48595	148	FOR 5098LB	202	FOR 5295006	94	FOR 5366318	106	FOR 54608	125	FOR 56550	132	FOR 62801	277	FOR 68303	285
FOR 4941-5	114	FOR 5098LT	203	FOR 5295007	94	FOR 54111	62	FOR 54610	125	FOR 56555	132	FOR 62806	277	FOR 68304	285
		FOR 51010T	61	FOR 5295008	94	FOR 54111	293	FOR 54611	125	FOR 56560	132	FOR 62817	277	FOR 684C17	227
		FOR 51010T	207	FOR 5295009	94	FOR 544771.2	123	FOR 54612	125	FOR 56919	132	FOR 6281832	282	FOR 68603	298
		FOR 5102	199	FOR 5295010	94	FOR 545.16	123	FOR 54614	125	FOR 56921	132	FOR 628300	278	FOR 68611	298
		FOR 5102LB	200	FOR 5295011	94	FOR 54508	122	FOR 54616	125	FOR 56922	132	FOR 628400	278	FOR 68612	298
		FOR 5102XL	199	FOR 5295012	94	FOR 54509	122	FOR 54618	125	FOR 56923	132	FOR 63005	220	FOR 687400H	287
		FOR 5102XLB	201	FOR 5295013	94	FOR 5451.0	123	FOR 54620	125	FOR 56924	132	FOR 63005	281	FOR 68755	287
		FOR 5106B	60	FOR 53506	105	FOR 5451.1.16	123	FOR 54622	125	FOR 56926	132	FOR 63201	289	FOR 68790	287
		FOR 5106B	204	FOR 53507	105	FOR 5451.1.4	123	FOR 54624	125	FOR 56927	132	FOR 639230	238	FOR 6904160	210
		FOR 5116LB	201	FOR 53508	105	FOR 5451.1.8	123	FOR 5467710	125	FOR 56928	132	FOR 639250	237	FOR 6904200	210
		FOR 5121	157	FOR 53509	105	FOR 5451.2	123	FOR 5467711	125	FOR 56929	132	FOR 639300	237	FOR 6905160	210
		FOR 51213C	164	FOR 5351.2	105	FOR 5451.3.16	123	FOR 5467712	125	FOR 56930	132	FOR 639365	237	FOR 6905160	294
		FOR 5121S	159	FOR 5351.4	105	FOR 54510	122	FOR 5467714	125	FOR 56932	132	FOR 6472300W	175	FOR 6911200	210
		FOR 5128C	162	FOR 53510	105	FOR 54511	122	FOR 5467716	125	FOR 56933	132	FOR 6472300WP	175	FOR 6911200	294
		FOR 51313	156	FOR 53511	105	FOR 54511.16	123	FOR 5467718	125	FOR 56934	132	FOR 6473365S	175	FOR 6923160	226
		FOR 5137S	199	FOR 53511.16	105	FOR 54512	122	FOR 5467720	125	FOR 56935	132	FOR 6473385	175	FOR 6924250	226
		FOR 5137XL	199	FOR 53512	105	FOR 54513	122	FOR 5467724	125	FOR 56936	132	FOR 6474530W	175	FOR 6957240	227
		FOR 5137XLS	199	FOR 53513	105	FOR 54513.16	123	FOR 54908	122	FOR 56938	132	FOR 6474536	175	FOR 6982	225
		FOR 5138	62	FOR 53513.16	105	FOR 54514	122	FOR 54910	122	FOR 56941	132	FOR 647G2360	175		
		FOR 5138	217	FOR 53514	105	FOR 54515	122	FOR 54911	122	FOR 56946	132	FOR 647G2360A	175		
		FOR 5141C	157	FOR 53515	105	FOR 54515.16	123	FOR 54912	122	FOR 56946	132	FOR 647G3440	175		
		FOR 5141S	159	FOR 53516	105	FOR 54515.32	123	FOR 54913	122	FOR 56950	132	FOR 647G3440A	175		
		FOR 5151	203	FOR 53517	105	FOR 54516	122	FOR 54914	122	FOR 56955	132	FOR 647G4075	175		
		FOR 5151L	203	FOR 53518	105	FOR 54517	122	FOR 54915	122	FOR 56960	132	FOR 647G4640	175		
		FOR 5151LT	203	FOR 53519	105	FOR 54518	122	FOR 54916	122	FOR 56965	132	FOR 647G4640A	175		
		FOR 5171	183	FOR 53520	105	FOR 54519	122	FOR 54917	122	FOR 56965	134	FOR 649200E	172		
		FOR 5250045	94	FOR 53521	105	FOR 54519.32	123	FOR 54918	122	FOR 56965	134	FOR 649250E	172		
		FOR 52504	94	FOR 53522	105	FOR 54520	122	FOR 54919	122	FOR 56965	134	FOR 649300E	172		
		FOR 525045	94	FOR 53524	105	FOR 54521	122	FOR 54920	122	FOR 56965	134	FOR 65113L	280		
		FOR 52505	94	FOR 5353.4	105	FOR 54522	122	FOR 54921	122	FOR 5					

FOR 7442507	171	FOR 75714	160	FOR 802318	109	FOR 807318M	106	FOR 88704H9	242	FOR 916G3	244	FOR F2262	64	FOR T20612	171
FOR 7442508	171	FOR 75714F	160	FOR 802318P	109	FOR 807318MTH	106	FOR 887A500	242	FOR 917T1	277	FOR F2335 - Jumbo	73	FOR T20712	48
FOR 7442509	171	FOR 75714R	160	FOR 802319	109	FOR 807320.6	106	FOR 887C02	242	FOR 917T3	279	FOR F2412	64	FOR T20712	186
FOR 7442510	171	FOR 75715	160	FOR 802319P	109	FOR 807320.6M	106	FOR 887D01	242	FOR 918C1	297	FOR F2452 - Jumbo	73	FOR T20712	292
FOR 7442511	171	FOR 75715F	160	FOR 80232	109	FOR 807320.6MTH	106	FOR 887P01	243	FOR 919G1	248	FOR F2592 - Jumbo	73	FOR T2084A	48
FOR 7442512	171	FOR 75715R	160	FOR 802322	109	FOR 807325014M	106	FOR 88801	289	FOR 920U2	211	FOR F31351	67	FOR T2084A	177
FOR 7442513	171	FOR 75716	160	FOR 802322P	109	FOR 807325016M	106	FOR 88902	288	FOR 921G3	256	FOR F31921 - Jumbo	76	FOR T2085A	48
FOR 7442514	171	FOR 75716F	160	FOR 802323	109	FOR 807416	128			FOR 922G3	258	FOR F32031 - Jumbo	75	FOR T2085A	178
FOR 750200	273	FOR 75716R	160	FOR 802323P	109	FOR 807416M	128	<b>FOR 9000</b>		FOR 928G1	254	FOR F41001 - Jumbo	81	FOR T2086A	48
FOR 750380	273	FOR 75717	160	FOR 80232P	109	FOR 807418	128	FOR 902C1	297	FOR 933G1	244	FOR F41041	69	FOR T2086A	180
FOR 750500	273	FOR 75717F	160	FOR 80238	109	FOR 807418M	128	FOR 902G11	261	FOR 933T1	279	FOR F41062 - Jumbo	78	FOR T2173	48
FOR 7510810	168	FOR 75717R	160	FOR 80238P	109	FOR 807420.6	128	FOR 902G2	252	FOR 938G1	260	FOR F41083	67	FOR T2173	183
FOR 7510810S	168	FOR 75718	160	FOR 80239	109	FOR 807420.6M	128	FOR 902G9	260	FOR 964G1	240	FOR F41162 - Jumbo	79	FOR T2641	49
FOR 7510910	168	FOR 75718F	160	FOR 80239P	109	FOR 8081	148	FOR 902T1	275	FOR 990C1	297	FOR F41491 - Jumbo	79	FOR T2641	93
FOR 7511011	168	FOR 75718R	160	FOR 802415	130	FOR 8081D	149	FOR 903G12	264	FOR 9B0101	265	FOR F41621 - Jumbo	77	FOR T2741	49
FOR 7511011S	168	FOR 75719	160	FOR 802415P	130	FOR 809128MPP	143	FOR 903G17	256	FOR 9B0102	265	FOR F4175	72	FOR T2741	92
FOR 7511012	168	FOR 75719F	160	FOR 802418	130	FOR 80923	99	FOR 903G18	264	FOR 9B0103	282	FOR F4451	68	FOR T2742	49
FOR 7511112S	168	FOR 75719R	160	FOR 802418P	130	FOR 80932	108	FOR 903G20	249	FOR 9B0109	269	FOR F4491 - Jumbo	80	FOR T2742	92
FOR 7511113	168	FOR 75720	160	FOR 80242	130	FOR 80932MPB	143	FOR 904B1	268	FOR 9B0302	273	FOR F4721	18	FOR T30711	50
FOR 7511214	168	FOR 75721	160	FOR 802422	130	FOR 80934	108	FOR 904G10	246	FOR 9B0704	236	FOR F4721 5	19	FOR T30712	50
FOR 7511214S	168	FOR 75722	160	FOR 802422P	130	FOR 80934MPB	143	FOR 904G10	258	FOR 9B0704	282	FOR F4882	68	FOR T30712	101
FOR 7511314	168	FOR 75724	160	FOR 802423	130	FOR 80943	129	FOR 904G11	251	FOR 9C2005	299	FOR F4891 - Jumbo	80	FOR T31010	51
FOR 7511417	168	FOR 75724R	160	FOR 802423P	130	FOR 80943MPB	143	FOR 904G12	245	FOR 9G0104	245	FOR F51012	18	FOR T31010	103
FOR 7511618	168	FOR 7620607	167	FOR 80242P	130	FOR 80946	129	FOR 904G12	268	FOR 9G0104	262	FOR F51012	19	FOR T31010	241
FOR 7511619S	168	FOR 7620809	167	FOR 80243	130	FOR 80946MPB	143	FOR 904G15	252	FOR 9G0109	245	FOR F5117	65	FOR T3121	50
FOR 7511719	168	FOR 7621011	167	FOR 802433	130	FOR 80946MPP	143	FOR 904G16	255	FOR 9G0109	262	FOR F51210FV	18	FOR T3121	102
FOR 7511719S	168	FOR 7621213	167	FOR 802434	130	FOR 80964	133	FOR 904G17	253	FOR 9G0111	265	FOR F51217	65	FOR T3193	50
FOR 7511922	168	FOR 7621415	167	FOR 80243P	130	FOR 80964MPB	143	FOR 904G3	256	FOR 9G0121	249	FOR F5155	66	FOR T3193	104
FOR 7511922S	168	FOR 7621617	167	FOR 80248	130	FOR 80968	133	FOR 904G7	257	FOR 9G0122	249	FOR F5173 - Jumbo	84	FOR T3212	50
FOR 7512427	168	FOR 7621819	167	FOR 80248P	130	FOR 80968MPB	143	FOR 904G8	264	FOR 9G0123	246	FOR F5182	71	FOR T3212	104
FOR 7513032	168	FOR 77604	171	FOR 80249	130	FOR 80986	135	FOR 904G9	257	FOR 9G0201	262	FOR F5186	71	FOR T3251 5	50
FOR 755.8	159	FOR 77605	171	FOR 80249P	130	FOR 80986MPB	143	FOR 904M3	284	FOR 9G0605	248	FOR F5188 - Jumbo	84	FOR T3251 5	101
FOR 7551.0	159	FOR 77606	171	FOR 8026500	133	FOR 80986MPP	143	FOR 904M5	286	FOR 9G0606	248	FOR F5207	66	FOR T3311	50
FOR 7551.1.16	159	FOR 77607	171	FOR 8028650	135	FOR 81022	99	FOR 904M6	284	FOR 9G0609	258	FOR F5242 - Jumbo	85	FOR T3311	102
FOR 7551.1.2	159	FOR 77608	171	FOR 8032115	99	FOR 81022M	99	FOR 904T1	274	FOR 9G0617	248	FOR F5252	19	FOR T3322	50
FOR 7551.1.4	159	FOR 77610	171	FOR 8033165	108	FOR 81037	108	FOR 904T4	273	FOR 9G0715	245	FOR F5272 - Jumbo	85	FOR T3322	104
FOR 7551.1.8	159	FOR 77612	171	FOR 8034250	129	FOR 81037	195	FOR 904T5	278	FOR 9G0716	245	FOR F5292 - Jumbo	85	FOR T3331	50
FOR 7551.11.16	159	FOR 77614	171	FOR 8036450	133	FOR 810414	129	FOR 904U1	284	FOR 9G0804	258	FOR F5296 - Jumbo	84	FOR T3331	102
FOR 7551.2	159	FOR 77616	171	FOR 8036500	133	FOR 810414	195	FOR 904U2	287	FOR 9G0901	261	FOR F5351	70	FOR T3361	51
FOR 7551.3.4	159	FOR 784206U	108	FOR 8038550	135	FOR 81042	129	FOR 904U4	263	FOR 9G0902	266	FOR F5352 - Jumbo	86	FOR T3361	102
FOR 7551.3.8	159	FOR 784207U	108	FOR 803A4300	129	FOR 81042	195	FOR 904U5	287	FOR 9G1001	245	FOR F5361	70	FOR T3381	50
FOR 7551.4	159	FOR 784208U	108	FOR 8042050	99	FOR 81045	129	FOR 904U6	287	FOR 9G1206	253	FOR F5421	70	FOR T3381	102
FOR 7551.5.16	159	FOR 784209U	108	FOR 8042100	99	FOR 81045	195	FOR 905G1	250	FOR 9G1208	253	FOR F5422 - Jumbo	83	FOR T3521	51
FOR 7551.5.8	159	FOR 784310U	108	FOR 8042100W	99	FOR 81047	129	FOR 905G12	251	FOR 9M0101	285	FOR F5461 - Jumbo	82	FOR T3521	103
FOR 7551.7.16	159	FOR 784311U	108	FOR 8042150	99	FOR 81047	195	FOR 905M1	284	FOR 9M0106	286	FOR F5481 - Jumbo	82	FOR T4057	52
FOR 75511.16	159	FOR 784312U	108	FOR 8043044	108	FOR 8111	99	FOR 905M2P1	284	FOR 9T0106	268	FOR F5505 - Jumbo	82	FOR T4057	112
FOR 75513.16	159	FOR 784313U	108	FOR 8043044W	108	FOR 81225	99	FOR 905M2P2	284	FOR 9T0108	264	FOR F5521 - Jumbo	86	FOR T40612	52
FOR 75515.16	159	FOR 784314U	108	FOR 8043075	108	FOR 8141	134	FOR 905M2P3	284	FOR 9T0203	265	FOR F5522 - Jumbo	83	FOR T40612	112
FOR 7553.4	159	FOR 784315U	108	FOR 8043075MPP	137	FOR 8143	99	FOR 905M2P4	284	FOR 9T0204	278	FOR F6213	72	FOR T40813	51
FOR 7553.8	159	FOR 784316U	108	FOR 8043150	108	FOR 8145	99	FOR 905M2P5	284	FOR 9T0205	274	FOR F6213 (10217-10218)	131	FOR T40813	138
FOR 7555.16	159	FOR 784317U	108	FOR 8043150MPP	137	FOR 815A4315	130	FOR 905M5	286	FOR 9T0206	271	FOR F6342 - Jumbo	81	FOR T4116	53
FOR 7557.16	159	FOR 784418U	108	FOR 8043225	108	FOR 8162	310	FOR 905T10	279	FOR 9T0316	275	FOR F6342 - Jumbo (10318)	131	FOR T4116	120
FOR 7557.8	159	FOR 784418U	129	FOR 8043250	108	FOR 8163	310	FOR 905T4	279	FOR 9T1481	274	FOR F6431 - Jumbo	81	FOR T4119	51
FOR 7559.16	159	FOR 784419U	108	FOR 8044050	129	FOR 8164	310	FOR 906G11	261	FOR 9T3711	283	FOR FLEECE	310	FOR T4119	138
FOR 755S08	158	FOR 784419U	129	FOR 8044075	129	FOR 8166	310	FOR 906G2	260	FOR 9U0201	305			FOR T4122	53
FOR 755S09	158			FOR 8044125	129	FOR 81806	281	FOR 906G4	252	FOR 9U0201A	305	<b>FOR G</b>		FOR T4122	119
FOR 755S10	158	<b>FOR 8000</b>		FOR 8044125MPB	137	FOR 81808	281	FOR 906G6	255	FOR 9U0202	304	FOR G11	310	FOR T4143	52
FOR 755S11	158	FOR 8013215	108	FOR 8044125MPP	137	FOR 81810	281	FOR 906T3	277	FOR 9U0401	261	FOR G16	310	FOR T4143	111
FOR 755S12	158	FOR 8014380	129	FOR 8044250	129	FOR 81812	281	FOR 906T5	271	FOR 9U0701	173	FOR G81	289	FOR T4143 9	52
FOR 755S13	158	FOR 8014380P	129	FOR 8044250MPP	137	FOR 818B	281	FOR 907G13	254	FOR 9U0706	240			FOR T4143-9	111
FOR 755S14	158	FOR 8014600	129	FOR 8044500	129	FOR 818B01	281	FOR 907G2	261	FOR 9U3003	265	<b>FOR K</b>		FOR T4165	53
FOR 755S15	158	FOR 8014600P	129	FOR 8046100	133	FOR 818B02	281	FOR 907G3	251			FOR K20911	186	FOR T4165	119
FOR 755S16	158	FOR 80161000	133	FOR 8046200	133	FOR 819210	99	FOR 907G5	275	<b>FOR C</b>		FOR K4079	143	FOR T41710	53
FOR 755S17	158	FOR 8016475	133	FOR 8046400	133	FOR 819313	108	FOR 907G7	256	FOR C20913	13	FOR K4087	112	FOR T41710	117
FOR 755S18	158	FOR 80181000	135	FOR 8048200	135	FOR 819409	128	FOR 907U5	271	FOR C21114	14	FOR K51210F	161	FOR T4179	53
FOR 755S19	158	FOR 8018650	135	FOR 8048400	135	FOR 82023D	28	FOR 908G1	260	FOR C4482	13	FOR K51225	159	FOR T4179	121
FOR 75708	160	FOR 802215	98	FOR 80521	99	FOR 82023S	28	FOR 908G4	248	FOR C4482	14			FOR T4193	51
FOR 75708F	160	FOR 802215P	98	FOR 80531	108	FOR 82026S	28	FOR 908G8	268	FOR C50412	13	<b>FOR P</b>		FOR T4193	137
FOR 75708R	160	FOR 802218	98	FOR 80541	129	FOR 82026U	28	FOR 908G9	250	FOR C51220	13	FOR P18022	310	FOR T4194	52
FOR 75709	160	FOR 802218P	98	FOR 80541MPB	143	FOR 825411	304	FOR 908T9	243	FOR C5142	14	FOR P18023	310	FOR T4194	115
FOR 75709F	160	FOR 802219	98	FOR 80541MPP	143	FOR 8334300	130	FOR 909G3	215	FOR C5153	13	FOR P18024	310	FOR T4203	52
FOR 75709R	160	FOR 802219P	98	FOR 80561	133	FOR 88001	289	FOR 909G6	262	FOR C5153	13	FOR P18032	310	FOR T4203	111
FOR 75710	160	FOR 80222	98	FOR 80561MPB	143	FOR 88011	289	FOR 909G9	244	FOR CAT V5	315	FOR P180			





FOR T4281	53	FOR T5122	58	TC XC90 5SG	32
FOR T4281	120	FOR T5122	240	TC XC90 6SG	32
FOR T4322	53	FOR T51226	56	TC XC90 8SG	32
FOR T4322	119	FOR T51226	164	TC XCDKC	32
FOR T4355	53	FOR T51226A	164	TRI 60205	230
FOR T4355	120	FOR T51229	217	TRI BJ1001	229
FOR T4413	53	FOR T5131	58	TRI HGS 250-500	308
FOR T4413	119	FOR T5131	217	TRI SR801	235
FOR T4583	49	FOR T5134	55	TRI T24541	232
FOR T4583	193	FOR T5134	159	TRI T42001C	229
FOR T5023	54	FOR T5161	55	TRI T43001C	229
FOR T5023	173	FOR T5161	158	TRI T46001C	229
FOR T5033	57	FOR T5164R	57	TRI T82000D	230
FOR T5033	169	FOR T5164R	161	TRI T82007	230
FOR T5036	54	FOR T5172	57	TRI T90504	229
FOR T5036	173	FOR T5172	168	TRI TA1502	233
FOR T5038	54	FOR T5181	55	TRI TD2001G	235
FOR T5038	215	FOR T5181	158	TRI TL1531B	231
FOR T50410	54	FOR T51811	58	TRI TL1537	231
FOR T50410	214	FOR T51811	215	TRI TL3420E	229
FOR T50410	292	FOR T5331	58	TRI TL9320	232
FOR T5043A	54	FOR T5331	281	TRI TL9901	232
FOR T5043A	211	FOR T6085	51	TRI TLA2022	231
FOR T5043A	214	FOR T6085	146	TRI TR4056	232
FOR T5044	56	FOR T6121	51	TRI TR6100	234
FOR T5044	163	FOR T6121	144	TRI TR6458	234
FOR T5046	54	FOR T8151	51	TRI TR8485	233
FOR T5046	214	FOR T8151	143	TRI TR90051	308
FOR T5047	54	FOR T905M2	58	TRI TR90101	308
FOR T5047	214	FOR T905M2	284	TRI TR9405	308
FOR T5052	55	TC TBC123B	9	TRI TR9410	308
FOR T5052	158			TRI TRA9012L	233
FOR T5053	58			TRI TRD2005	235
FOR T5053	217	<b>FOR V</b>		TRI TRF0322	233
FOR T5055	58	FOR VUL 219	34	TRI TRH6802-3	234
FOR T5055	224	FOR VUL 245	35	TRI TRT5001	235
FOR T5056	58	FOR VUL 286	36	TRI TRT7502	235
FOR T5056	225	FOR VUL 306	37	TRI TRTH20A	299
FOR T5057	54	FOR VUL 361	38	TRI TRTH20A	309
FOR T5057	215	FOR VUL 376	38	TRI TW05001	232
FOR T50616S	57	FOR VUL 437	39		
FOR T50616S	169			<b>V</b>	
FOR T50617	57			VERF CY-1827T	302
FOR T50617	166	HAN 3-1260	306	VERF FR107 1.4	302
FOR T50637	48	HAN D251	306	VERF FR107 1.7	302
FOR T50637	204			VERF FR107 2.0	302
FOR T50710	168	<b>I</b>		VERF FR107 2.5	302
FOR T50710S	56	INV 1000	299	VERF FR206 0.8	303
FOR T5074	57	INV 150	299	VERF FR206 1	303
FOR T5074	169	INV 300	299	VERF FR906 1.4	303
FOR T5079S	56	INV 600	299	VERF FR906 1.7	303
FOR T5079S	164			VERF FR906 2.0	303
FOR T5081	56	<b>K</b>		VERF ON FR107 1.4	303
FOR T5081	163	KOM 050240	305	VERF ON FR107 1.7	303
FOR T50810	57	KOM 100400	305	VERF ON FR107 2.5	303
FOR T50810	166	KOM 252504	305	VERF ON FR107 28	303
FOR T50811	57			VERF ON FR906 1.4	303
FOR T50811	166	<b>L</b>		VERF ON FR906 1.7	303
FOR T50814	54	LED 10-113	299	VERF ON H827W R	303
FOR T50814	214	LED 9150	298	VERF ON SJ101AR	302
FOR T50817	56	LED ST-3463	298	VERF ON SJ101K	302
FOR T50817	167			VERF SJ101A	302
FOR T5082	56	<b>P</b>			
FOR T5082	168	PNE CY222	304	<b>W</b>	
FOR T5085	56	PNE CY2855	304	WIN 702016	309
FOR T5085	163	PNE CY3260	304	WIN KEW2000	309
FOR T5085S	56	PNE CY3266	304		
FOR T5085S	164	PNE L300	304	<b>Z</b>	
FOR T5089	55			ZA 104855	153
FOR T5089	158	<b>T</b>		ZA 3427	151
FOR T5096	58	TC XC 150	33	ZA 3428	151
FOR T5096	222	TC XC 150PL	33	ZA BT122	189
FOR T5111	55	TC XC 200	33	ZA CAT 2019-2020	315
FOR T5111	162	TC XC SH11	33	ZA COBALT 19	221
FOR T51115	161	TC XC SH12	33	ZA HSS170	221
FOR T5111S	55	TC XC SH13	33	ZA PH330	288
FOR T5111S	162	TC XC SH21	33	ZA STI	221
FOR T5114	56	TC XC SH22	33	ZA T110 1	220
FOR T5114	167	TC XC SH23	33	ZA TSM168	152
FOR T51210	57	TC XC100	33		
FOR T51210	161	TC XC100PL	33		
FOR T51211	57	TC XC200PL	33		
FOR T51211	161	TC XC75	33		
FOR T51214	55	TC XC75PL	33		
FOR T51214	158	TC XC90 10SG	32		



### Algemene voorwaarden

#### GARANTIES

Op alle gereedschappen is er 1 jaar garantie (of meer indien duidelijk vermeld) tegen fabricatie fouten. Op FORCE gereedschap **onbepaalde** garantie. Garanties die slijtage vertonen of ondeskundig gebruikt werden vallen **NIET** onder garantie.

#### PRIJSZETTING

Al onze prijzen in deze catalogus zijn bruto exclusief BTW, af magazijn en in Euro. Aangezien de prijzen vermeld in deze tarief onderhevig zijn aan schommelingen in kost van materiaal en andere, kunnen er steeds prijswijzigingen oorgevoerd worden. Gelieve ons vooraf te raadplegen. De producten kunnen zonder voorafgaande mededeling aangepast of gewijzigd worden. De afbeeldingen zijn louter indicatief, de producten en kleuren kunnen afwijken van de in de catalogus vermelde afbeeldingen.

#### VERKOOPSVORWAARDEN

Alleen geldig voor leveringen binnen België.

#### LEVERINGSTERMIJN

Behoudens onvoorziene omstandigheden worden de bestellingen verzendingsklaar gemaakt binnen de drie werkdagen na ontvangst of worden door onze chauffeur afgeleverd (mits een kost van € 5 voor bestellingen onder de € 500).

#### LEVERINGSCONDITIES

Franco vanaf € 500 netto in België.  
Bij facturen onder € 20 wordt € 10 administratiekosten aangerekend.

#### TERUGNAMES

Geleverde goederen worden slechts teruggenomen mits uitdrukkelijk akkoord door onze commerciële dienst én mits de goederen zich onbeschadigd en in de originele verpakking bevinden. Bij terugname van goederen wordt er steeds 10% afgetrokken op de aankoopprijs.

#### BETALINGSCONDITIES

Onze facturen zijn betaalbaar contant binnen 8 dagen met 2% disconto, ofwel op 30 dagen netto. De goederen blijven eigendom van Zasco tot alle betalingen volledig voldaan zijn aan Zasco.

### Conditions de vente

#### GARANTIES

Il y a un an de garantie sur tous les outils. Les outils FORCE sont garantis à vie.  
Retours des demande de garanties : les demandes de garanties doivent nous parvenir ou par le représentant ou par notre propre transport. Veuillez noter que nous refuserons tous les demandes de garanties contre remboursements d'un autre transporteur.

#### REMISES ET PRIX

Tous les prix de ce catalogue s'entendent brut et hors TVA. Etant donné que les prix repris dans le tarif dépendent des fluctuations du cours de US dollar, ils sont constamment susceptible d'être modifiés. Veuillez nous consulter à l'avance. Ses remises sont à convenir au cas par cas.

#### CONDITIONS DE VENTE

Uniquement valable pour les livraisons en Belgique.

#### CONDITIONS DE LIVRAISON

Après réception, les commandes sont prêtes pour enlèvement ou livraison par notre chauffeur dans un délai de 3 jours, sauf imprévu. Livraison franco à partir de € 500 - frais de administration 10 € par achat de -20€.

#### REPRISES

Les marchandises livrées ne seront repris qu'après accord formel de la société et si les marchandises sont intact et dans l'emballage originale. Nous déduisons toujours 10 % pour les retours.

#### CONDITIONS DE PAIEMENT

Nos factures sont payables ou comptant endéant les 8 jours avec 2% d'escompte ou à 30 jours net.  
La marchandise reste la propriété de Zasco en attendant le paiement.