

YE-IT22
EUROPE
2021/2022

PDF Version



CUTTING TOOLS



DRAAIEN

YG YG-1 CO., LTD.

VAMATEC

INDEX

Contents		Page	
Turning	External Turning Holder Code	4	
	Internal Turning Holder Code	6	
	Insert ISO Code System	8	
	Grade Naming System	10	
	Turning Grades Map	11	
	Turning Grades	12	
	Turning Chipbreakers	14	
	Application Guide	17	
	Surface Roughness Guide	23	
	Trouble Shooting	24	
	Inserts Overview	27	
	Product	Negative Inserts	28
		Positive Inserts	54
	External Holders Overview		61
Internal Holders Overview		63	
Product	External Holders	65	
	Internal Holders	80	
Parting & Grooving	Parting & Grooving Holders	Parting & Grooving Holders	96
	Overview		102
	Product	Parting & Grooving Inserts	103
Milling	Milling Cutter Code Keys		105
	Insert ISO Code System		106
	Milling Grades and Chipbreakers		108
	Milling Cutter Overview		110
	Milling Inserts Overview		112
	Product	Face Milling Cutters	113
		Face Milling Inserts	119
		Shoulder Milling Cutters	132
		Shoulder Milling Inserts	137
		Profiling Cutters	143
		Profiling Inserts	145
		High Feed Milling Cutters	149
	High Feed Milling Inserts	152	
	Modular Shank	155	
Drilling	Drilling Overview		157
	Product	Drilling Holders	158
		Drilling Inserts	169
Technical Information	ISO 13399 Terms		172
	Hardness Conversion Table		173
	Formulas		174
	Material Groups		175
	Comparison Chart - Turning		192
	Comparison Chart - Milling		194
	ISO ↔ ANSI		195
Search		196	

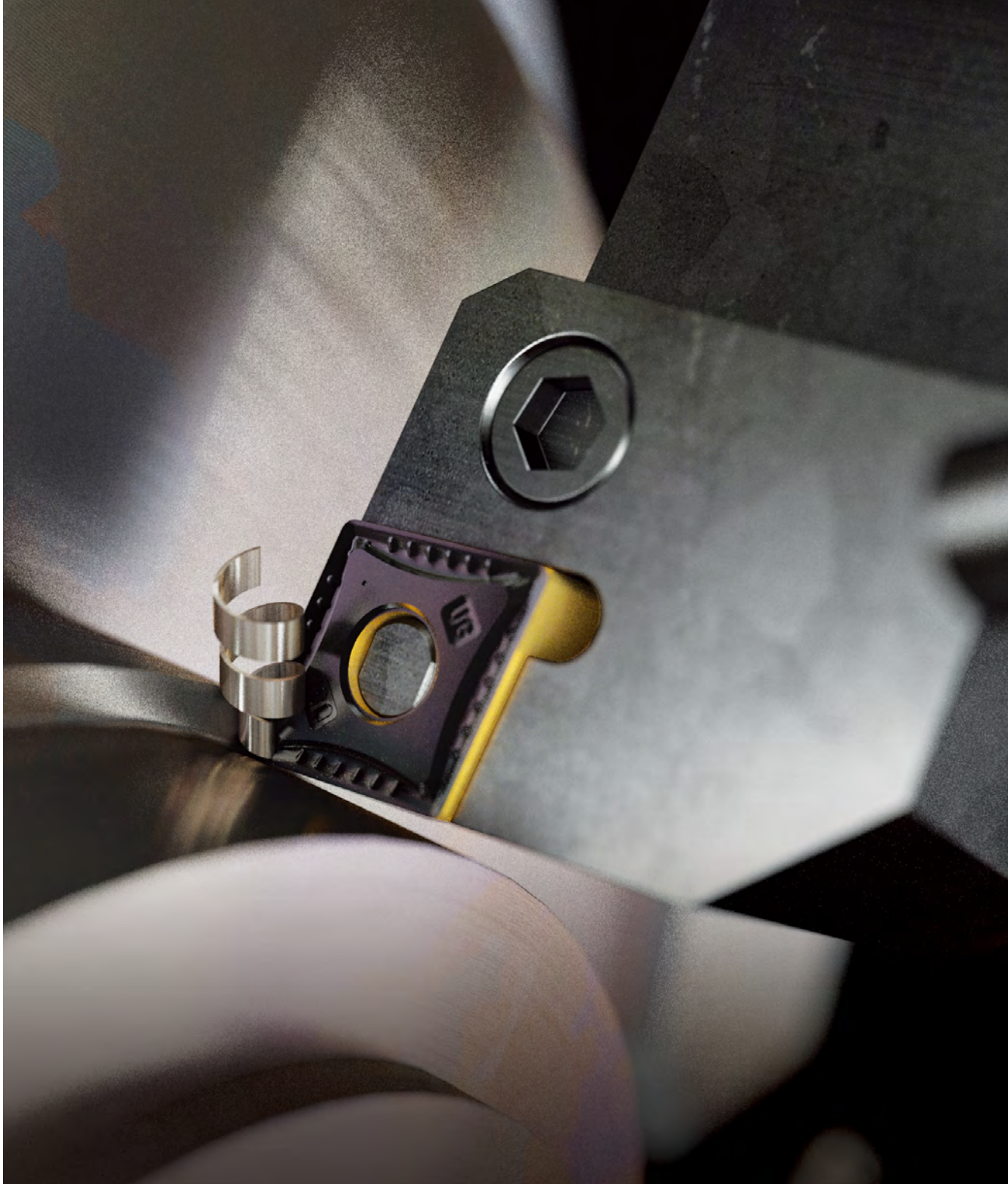

ISO TURNING

Product Overview

Application Guide

Turning Inserts Overview

Turning Inserts

Turning Holders Overview



Turning Holders

External Turning Holder Code (Metric)

*Metric

1	2	3	4	5	6	7	8	9	10
P	C	L	N	R	25	25	M	12	(C)
Clamping System	Insert Shape (1st Letter of Insert)	Tool Style	Insert Clearance (2nd Letter of Insert)	Tool Hand	Shank Height (H)	Shank Width (B)	Length (LF)	Insert Size	(Optional Clamp)

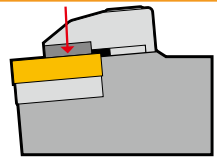
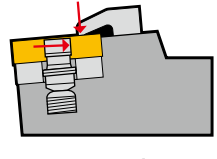
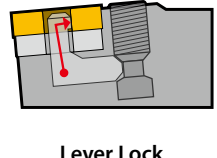
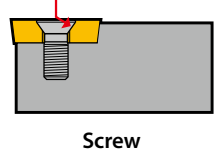
1 - Clamping System













Symbol	System
C	 Top Clamp (No Clamping Hole Insert)
M	 Pin & Top Clamp (Straight Clamping Hole Insert)
P	 Lever Lock (Straight Clamping Hole Insert)
S	 Screw (Screw Clamping Hole Insert)
T (D, A)	 Hole Clamp (Straight Clamping Hole Insert)

2, 4 — Insert Compatibility *



* Related to Insert Designation to check compatibility

3 - Tool Style

Approach Angle (KAPR)	Side Direction		End Direction
	Straight Shank	Offset Shank	
45°	D 	S 	
60°		T 	
63°	N 		
72.5°	V 		
75°	B 		K 
90°	A 	G 	F 
93°		J 	U
95°		L (Both Direction) 	
107.5°		H 	

External Turning Holder Code (Metric)

*Metric

1	2	3	4	5	6	7	8	9
S	D	J	C	R	20	20	K	11
Clamping System	Insert Shape (1st Letter of Insert)	Tool Style	Insert Clearance (2nd Letter of Insert)	Tool Hand	Shank Height (H)	Shank Width (B)	Length (LF)	Insert Size

5 - Hand Direction

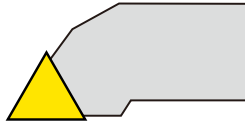
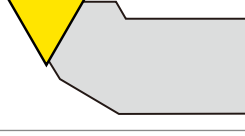
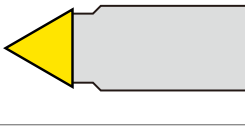
Symbol	Hand Direction
R	Right Hand 
L	Left Hand 
N	Neutral 

6, 7 - Shank Height (H) Shank Width (B)

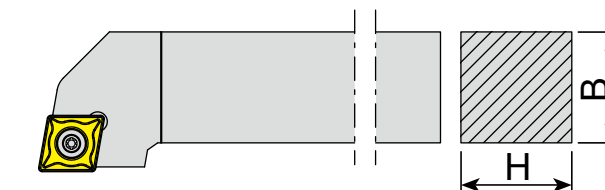

8 - Length (LF)

Symbol	Length (mm)	Symbol	Length (mm)
E	70	Q	180
F	80	R	200
H	100	S	250
K	125	T	300
M	150	U	350
P	170	V	400

9 - Insert Size *

Examples	is Compatible with...
PCLNR 2525M 12	CNMG 120408
SCLCR 2020K 09	CCMT 09T308
TWLNR 2525M 08	WNMG 080408

* Related to Insert Designation to check compatibility

(10 - Optional Clamp)

Symbol	Optional Clamp
C	Included

Internal Turning Holder Code (Metric)

*Metric

1	2	3	4	5	6	7	8	9	10
A	32	S	-	P	L	N	R	12	(C)
Coolant & Material	Shank Diameter (DCON)	Legth (LF)	Clamping System	Insert Shape (1st Letter of Insert)	Tool Style	Insert Clearance (2nd Letter of Insert)	Tool Hand	Insert Size	(Optional Clamp)

1 - Coolant and Tool Material

Symbol	Internal Coolant	Tool Material
A	O	Steel
S	X	
E	O	Carbide

2 - Shank Diameter (DCON)

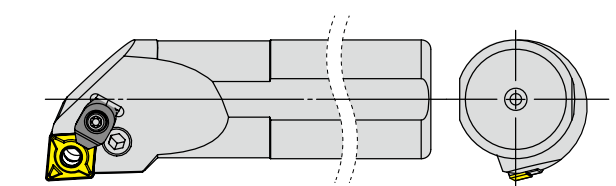

3 - Length (LF)

Symbol	Length (mm)	Symbol	Length (mm)
E	70	Q	180
F	80	R	200
H	100	S	250
K	125	T	300
M	150	U	350
P	170	V	400

4 - Clamping System

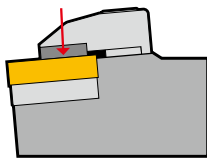
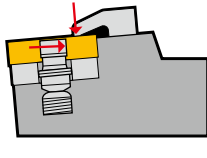
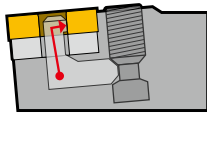
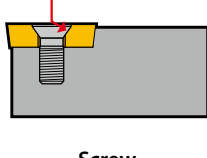
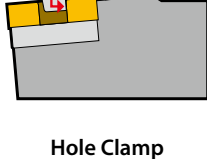
Symbol	System
C	 Top Clamp (No Clamping Hole Insert)
M	 Pin & Top Clamp (Straight Clamping Hole Insert)
P	 Lever Lock (Straight Clamping Hole Insert)
S	 Screw (Screw Clamping Hole Insert)
T (D, A)	 Hole Clamp (Straight Clamping Hole Insert)

Internal Turning Holder Code (Metric)

*Metric

1	2	3	4	5	6	7	8	9	
A	25	R	-	S	C	L	C	R	09
Coolant & Material	Shank Diameter (DCON)	Legth (LF)	Clamping System	Insert Shape (1st Letter of Insert)	Tool Style	Insert Clearance (2nd Letter of Insert)	Tool Hand	Insert Size	

6 - Tool Style

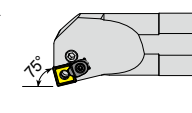
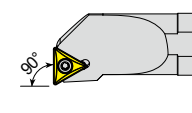
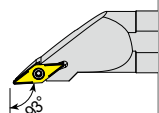
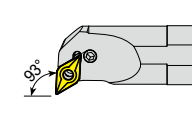
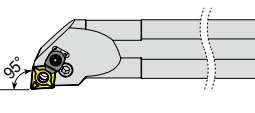
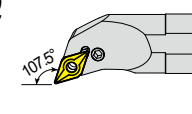
Approach Angle (KAPR)	Side Direction	End Direction
	Offset Shank	
75°		K 
90°		F 
93°	J 	U 
95°	L (Both Direction) 	
107.5°		Q 

8 - Hand Direction

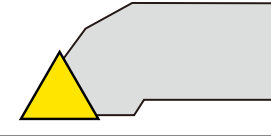
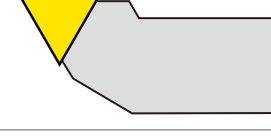
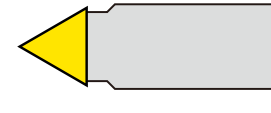
Symbol	Hand Direction
R	Right Hand 
L	Left Hand 
N	Neutral 

9 - Insert Size *

Examples	is Compatible with...
PCLNR 2525M 12	CNMG 120408
SCLCR 2020K 09	CCMT 09T308
TWLNLR 2525M 08	WNMG 080408

* Related to Insert Designation to check compatibility

5, 7 - Insert Compatibility *



* Related to Insert Designation to check compatibility

(10 - Optional Clamp)

Symbol	Optional Clamp
C	Included

Insert ISO Code System

*Metric : According to ISO 1832

1	2	3	4	5	6	7	8	9
C	N	M	G	12	04	08	-UG	YG3020
Shape	Clearance	Tolerance	Clamping & Chipbreaker	Insert Size	Insert Thickness	Corner Radius	Chipbreaker Geometry	Grade

1 - Shape

Symbol	Shape	
H	Hexagonal	
O	Octagonal	
P	Pentagonal	
S	Square	
T	Triangular	
C	Rhombic 80°	
D	Rhombic 55°	
V	Rhombic 35°	
W	Trigon	
L	Rectangular	
K	Parallelogram 55°	
R	Round	

2 - Relief Angle (AN)

Symbol	Relief Angle (AN)	
N	No Relief Angle	
B	Relief 5°	
C	Relief 7°	
P	Relief 11°	
D	Relief 15°	
E	Relief 20°	
F	Relief 25°	
O	Special	

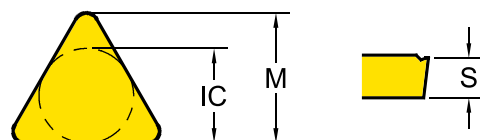

3 - Tolerance Class

Symbol	Inner Circle IC (mm)	Nose Height M (mm)	Thickness S (mm)
C	± 0.025	± 0.013	± 0.025
E	± 0.025	± 0.025	± 0.025
G	± 0.025	± 0.025	± 0.13
H	± 0.013	± 0.013	± 0.025
K*	± 0.05~0.15*	± 0.013	± 0.025
M*	± 0.05~0.15*	± 0.08~0.2*	± 0.13
U*	± 0.08~0.25*	± 0.13~0.38*	± 0.13

*Tolerance is different by insert IC size. Please see ISO 1832

4 - Clamping & Chipbreaker

Symbol	Clamping	Chipbreaker	Figure
N	No clamping hole	X	
R		One Face	
A	Cylindrical Clamping hole	X	
M		One Face	
G		Both Faces	
W	Screw Hole	X	
T		One Face	
U		Both Faces	
X		Special	

Insert ISO Code System

*Inch

1	2	3	4	5	6	7	8	9
C	N	M	G	4	3	2	-UG	YG3020
Shape	Clearance	Tolerance	Clamping & Chipbreaker	Insert Size	Insert Thickness	Corner Radius	Chipbreaker Geometry	Grade

5 - Insert Size

Metric							Inner Circle IC (mm)	Inch
06	11	06	07	11			6.35	2
07							7.94	2.5
09	16	09	11	16	06	09 (00)	9.525	3
12	22	12	15	22	08	12 (00)	12.7	4
15		16					15.875	5
19		19					19.05	6
25		25					25.4	8
						06 (M0)	6	
						08 (M0)	8	
						10 (M0)	10	
						12 (M0)	12	
						16 (M0)	16	

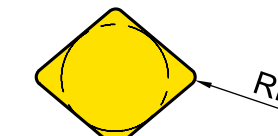
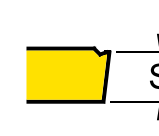

6 - Insert Thickness (S)

Metric	Thickness - S (mm)	Inch
T1	1.98	1.2
02	2.38	1.5
03	3.18	2
T3	3.97	2.5
04	4.76	3
05	5.56	3.5
06	6.35	4
07	7.94	5
09	9.525	6

7 - Corner Radius (RE)

Metric	Corner Radius - RE (mm)	Inch
01	0.1	0
02	0.2	0.5
04	0.4	1
08	0.8	2
12	1.2	3
16	1.6	4
20	2.0	5
24	2.4	6

Grade Naming System

1	2	3	4	5	(6)
YG	3	0	2	0	(G)
YG Brand	Workpiece Material	Grade Version	Application Range (1st Digit)	Application Range (2nd Digit)	Minor Variation
Carbide CVD (4 Digits)	●	●	●	●	YG3020
Carbide PVD (3 Digits)	●	●	●		YG211
Carbide Uncoated (2 Digits)	●	●			YG10

1 - YG Brand

2 - Workpiece Material

Symbol	Workpiece Material	Turning	Milling	Drilling	Parting
1	K Cast Iron or N Non-Ferrous	●			
2	M Stainless Steel	●			
3	P Steel	●			
4	S Superalloys	●			
5	K Cast Iron or N Non-Ferrous		●	●	●
6	M Stainless Steel or Universal		●	●	●
7	P Steel		●	●	●
8	Universal	●			

3 — Grade Version

4 & 5 — Application Range

Symbol	Application Range
05	Stable Wear Resistant Grade Stable Application Continuous Cut Finishing
10	
15	
20	
25	
30	General Balanced Grade High Versatility General Application
35	
40	
45	
45	
45	Unstable Tougher Grade Unstable Application Interrupted Cut Chipping Resistance Roughing

(6) — (Minor Variation)

G — Gold Coated Version

Product Overview

Turning Grades Map

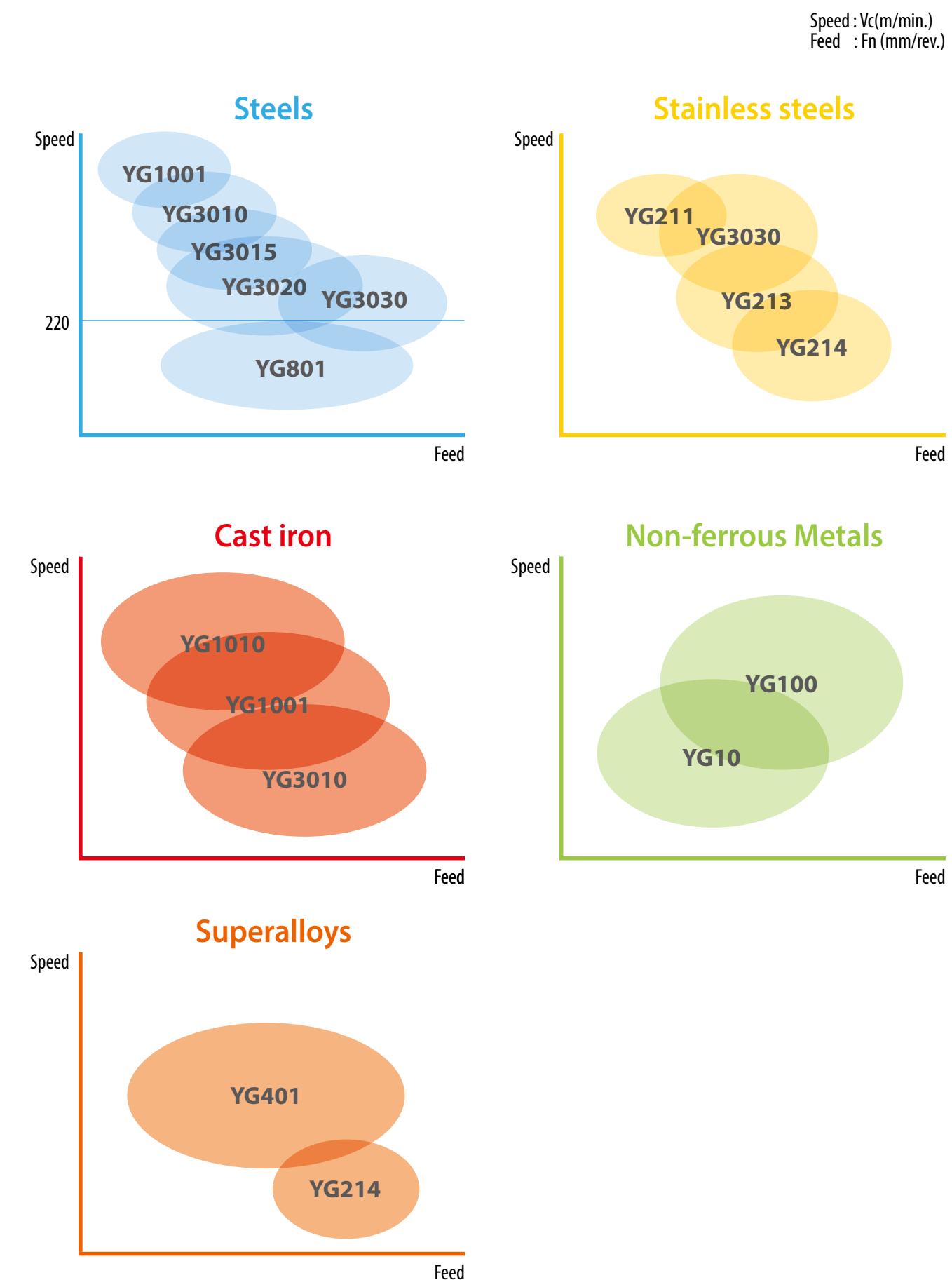

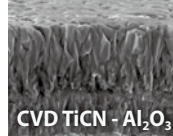
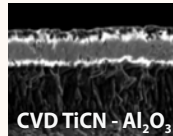
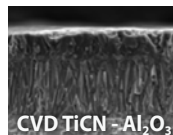
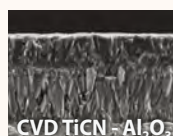

Product Overview
Turning Grades

Turning Grades	P Steel				M Stainless steel			K Cast iron			N Non-ferrous		S Superalloys	
	P10	P20	P30	P40	M10	M20	M30	K10	K20	K30	N10	N20	S10	S20
CVD	YG1010							1010						
	YG1001	1001						1001						
	YG3010		3010						3010					
	YG3015		3015											
	YG3020		3020											
	YG3030		3030			3030								
PVD	YG801		801											
	YG211				211									
	YG213					213								
	YG214						214						214	
	YG401												401	
DLC	YG100										100			
-	YG10										10			

YG1010 K05 - K15		First Choice for Cast Iron • Effective coating structure enables high speed machining • Special post treatment for improved chipping resistance
YG1001 P01 - P10 K10 - K25		First Choice for Stable Machining of Cast Iron • Substrate especially designed for high wear resistance • Thick Al ₂ O ₃ layer ensures good wear resistance at high cutting speeds including dry machining
YG3010 P05 - P20 K15 - K35		First choice for Finishing Steels, and Ductile Cast iron • Finishing and light machining of steel under in stable condition • New Al ₂ O ₃ coating technology and excellent surface smoothness increase wear resistance and chipping resistance
YG3015 P10 - P25		Balanced Productivity for Continuous cut • High wear resistance and improved toughness ensures high productivity with less trouble

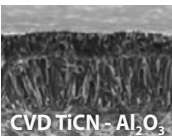
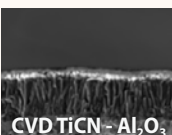
Product Overview
Turning Grades

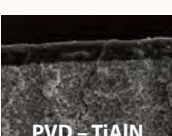
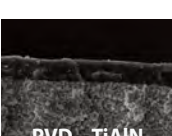
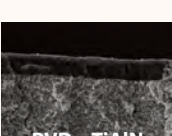
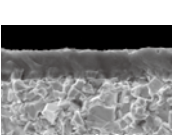
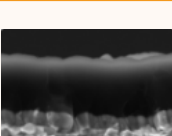
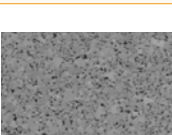
YG3020 P15 - P30		First Choice Grade for General Steel Application • Substrate especially designed for good toughness • Excellent surface smoothness increases wear resistance and reliability
YG3030 P20 - P35 M10 - M30		Interrupted Cutting of Steel and Stainless steel • Substrate for heavy roughing in mild steel and low carbon alloy steel • New Al ₂ O ₃ technology and optimized surface treatment achieves a good balance between wear resistance and chipping resistance
YG801 P10 - P30		for Carbon Steel with Low Cutting Speed • Recommended for mild steel and boring application • Substrate and special PVD coating for excellent wear resistance
YG211 M05 - M25		High wear Resistance Grade for Stainless steel • Finishing Stainless steel
YG213 M20 - M35		First Choice Grade on Low Cutting Speed of Stainless steel • First choice on Stainless steel for Low cutting speed • For Medium to low cutting speed
YG214 M30 - M40 S25 - S30		Heavy Interrupted cut for Stainless steel • For Heavy Interrupted cut on Stainless steel • Minimize risk of Mechanical fracture or Chipping
YG401 S10 - S20		PVD Turning Grade for HRSA • Highly heat-resistant TiAlSiN structure for excellent wear resistance • Greatly improved film coating realizes excellent boundary defect resistance • Top coating layer provides a smooth surface and lubricant effect
YG100 N05 - N25		First Choice Grade for Aluminum with DLC Coating • Submicron carbide for high wear resistance • DLC coating minimizes Built Up Edge tendency. • Improve tool life in sticky non-ferrous alloy
YG10 N05 - N25		Uncoated Grade for General Aluminum • Substrate consisted of submicron carbide for high wear resistance • Shining surface to prevent built up edge

Turning Chipbreakers - Negative

P	M	K	N	S		Feed	Fn (mm/rev.)					
							0	0.1	0.2	0.3	0.4	0.5
P					UF	Finishing						
P					UL	Semi Finishing and sticky materials						
P					UM	For Medium & Unstable conditions						
P					UG	First Choice for Medium (Stable application)						
P		K			UC	Medium Roughing and First choice for Cast iron						
P		K			UR	Roughing and Heavy interrupted cut						
		K			..MA	Cast iron Heavy Roughing						
		K			KR	Cast Iron Heavy Roughing						

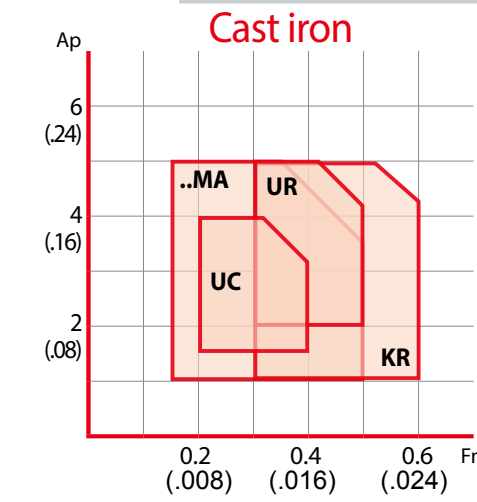
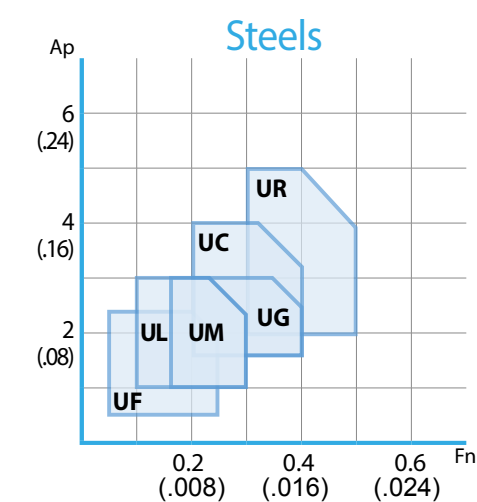

Turning Chipbreakers - Negative

P	M	K	N	S		Feed	Fn (mm/rev.)					
							0	0.1	0.2	0.3	0.4	0.5
	M			S	MF	Stainless steel Finishing						
P	M			S	MM	Stainless steel Medium and Low Carbon Steel						
	M			S	MG	First Choice for Medium for Stainless steel						
	M			S	MR	Roughing for Stainless steel						
				S	SF	HRSA Finishing						
				S	SM	HRSA Medium						
				S	SR	Roughing for HRSA						

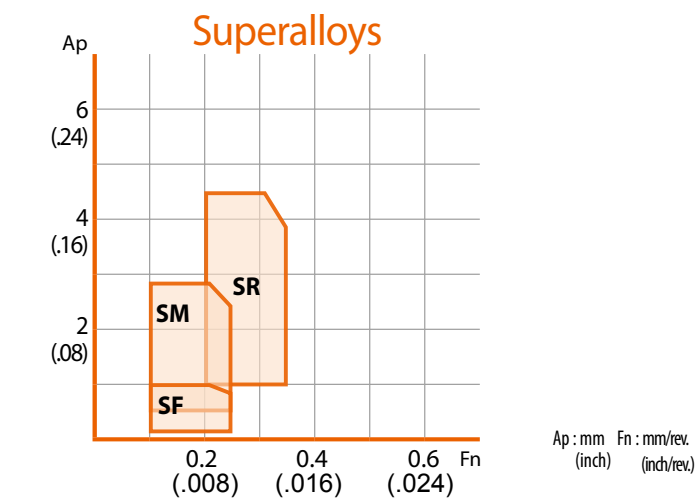
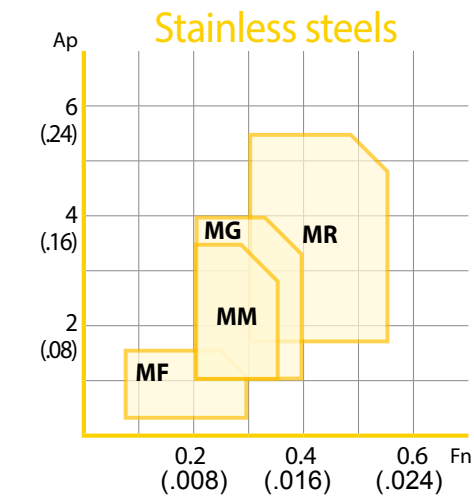

Turning Chipbreakers - Positive

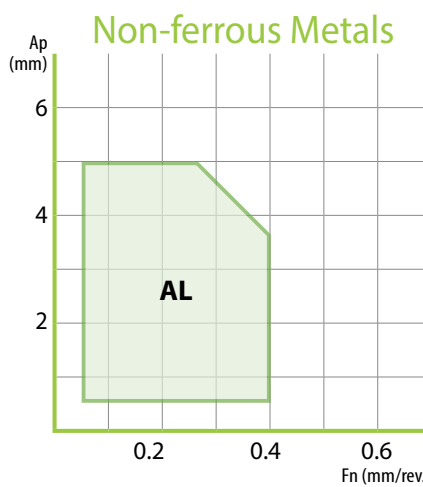
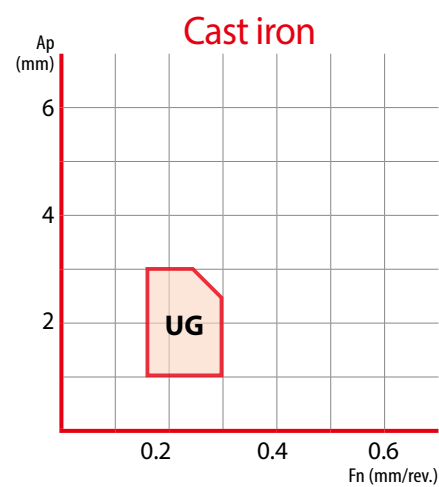
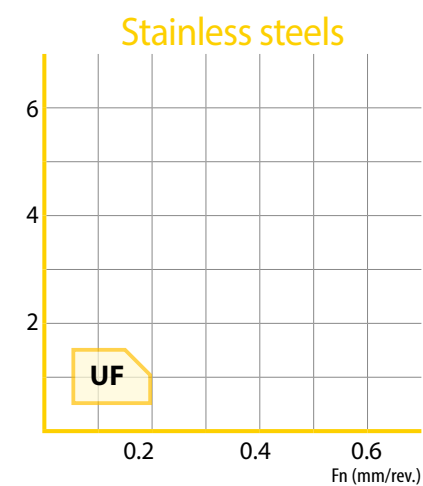
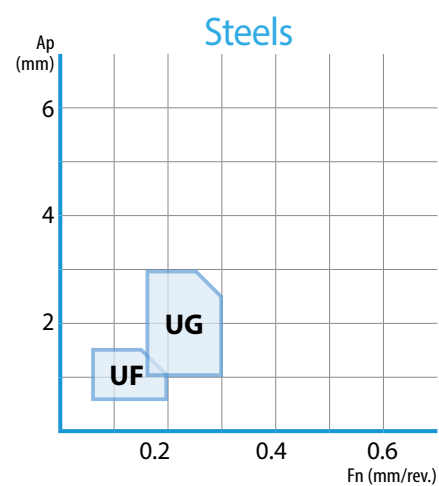
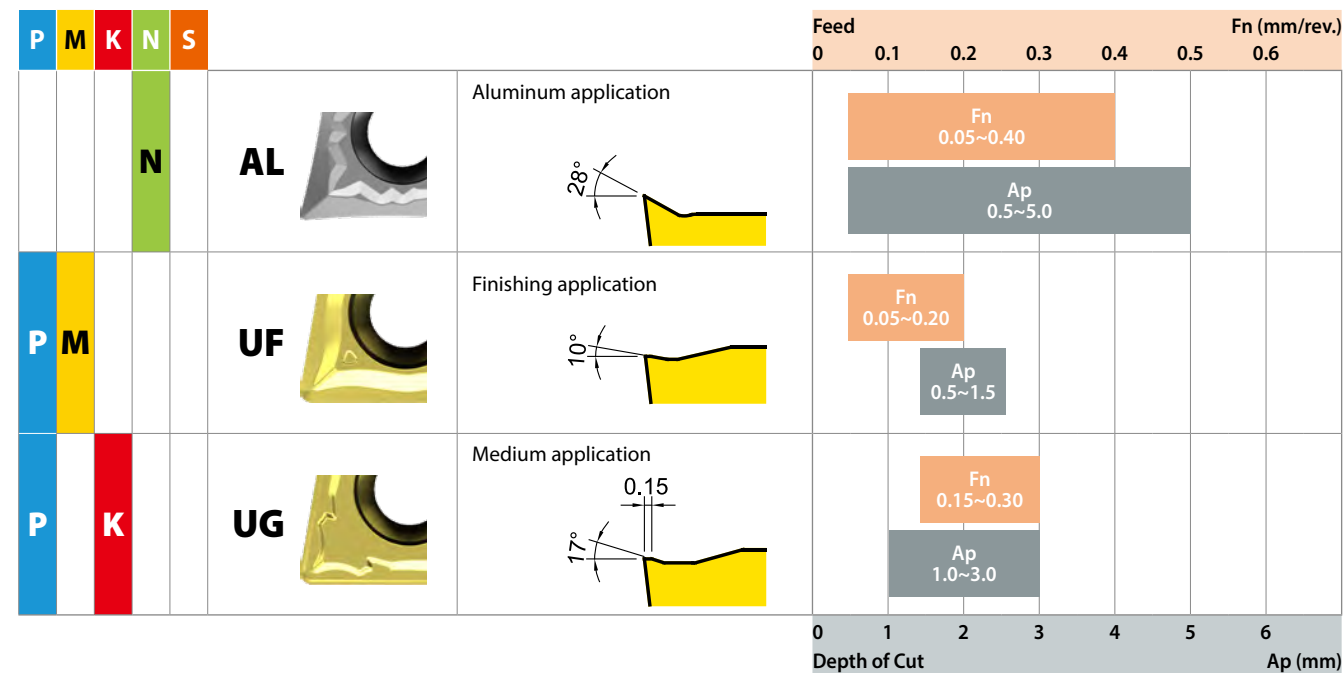

Steel Guide

Grade Recommendation based on Workpiece Material Condition



Chipbreaker, Feed Rate and Depth of Cut

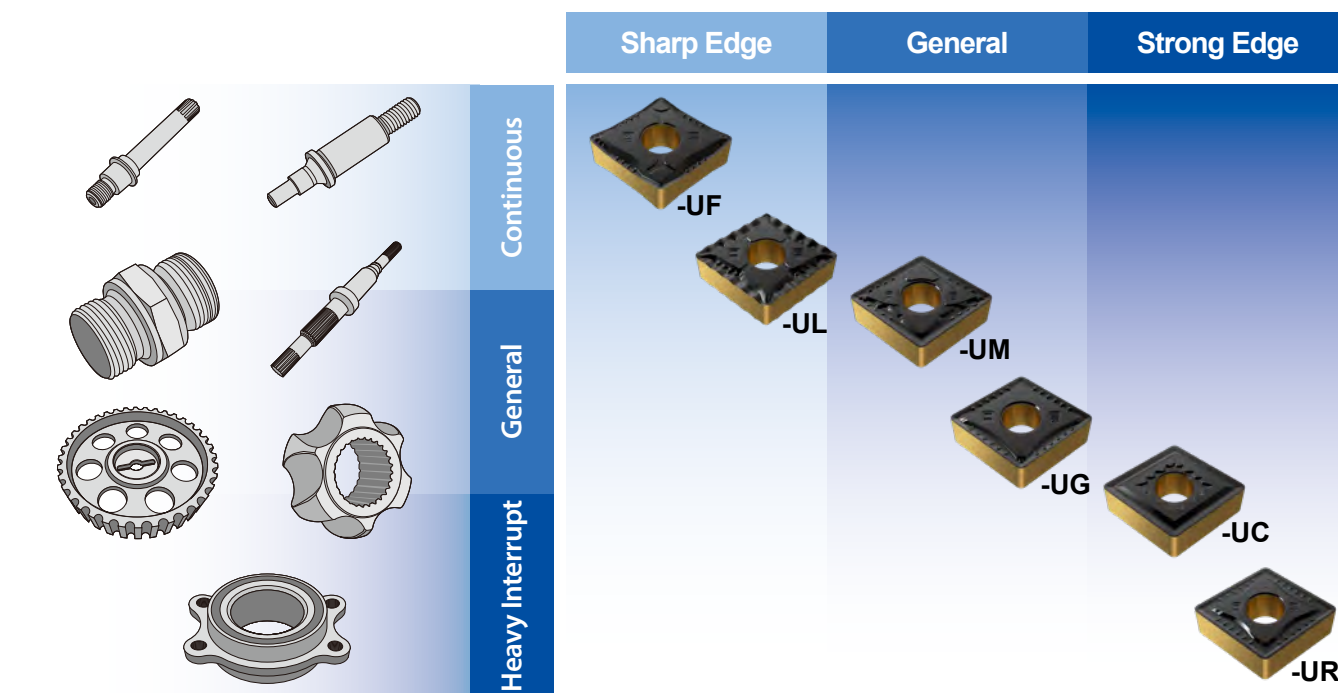

Application Guide
Steel Guide

P Non Alloy Steel, About 0.15% C (Low Carbon Steel)										
VDI	JIS	DIN	Mat'l No.	AISI/ASTM	SS	AFNOR	UNI	UNE	BS	GOST
1	S15C	CK15	1.0401	1015	1350	XC18	C15	F.1110	080M15	15



First Choice Grade and Value
YG3010 - Vc 330m/min (1,080ft/min)
YG801 - Vc 170m/min (560ft/min)

P Non Alloy Steel, About 0.45% C (Medium Carbon Steel)										
VDI	JIS	DIN	Mat'l No.	AISI/ASTM	SS	AFNOR	UNI	UNE	BS	GOST
2-3	S45C	C45	1.0503	1045	1672	XC42H1TS	C45	F.1140	060A47	45



First Choice Grade and Value
YG3010 - Vc 330m/min (1,080ft/min)
YG801 - Vc 170m/min (560ft/min)

Application Guide
Steel Guide

P Low-alloyed Steel										
VDI	JIS	DIN	Mat'l No.	AISI/ASTM	SS	AFNOR	UNI	UNE	BS	GOST
6-9	SCM440	42CrMo4	1.7225	4140	2244	42 CD 4	42CrMo4	F.1252	708M40	38HM

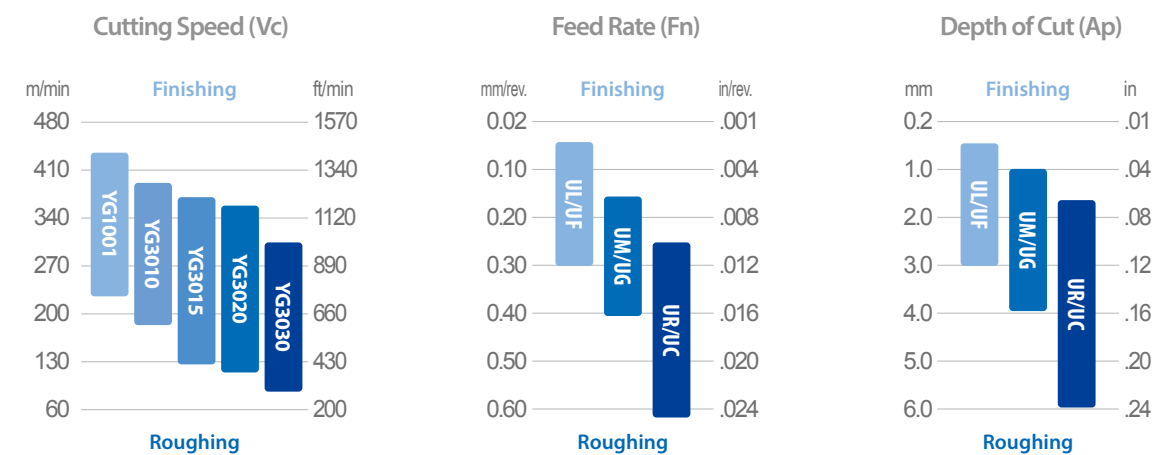

First Choice Grade and Value
YG3020 - Vc 240m/min (790ft/min)

P High Alloyed Steel, and Tool Steel										
VDI	JIS	DIN	Mat'l No.	AISI/ASTM	SS	AFNOR	UNI	UNE	BS	GOST
10-11	SKD11	X155CrVMo121	1.2379	D2	2310	Z160CDV12	X165CrMoW12KU	F.5318	BD2	KH12MF

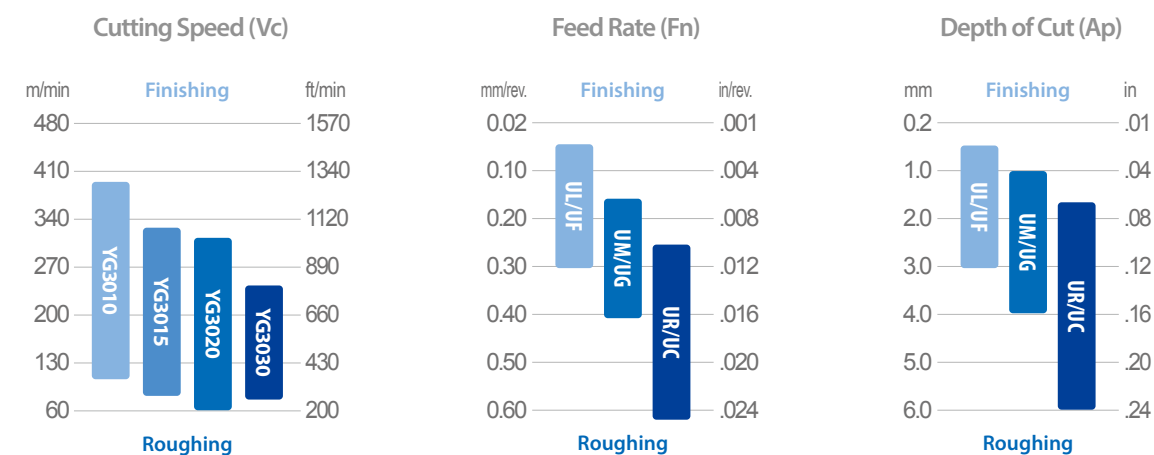

First Choice Grade and Value
YG3020 - Vc 230m/min (750ft/min)

Application Guide Stainless steel Guide

M	Ferritic / Martensitic Stainless									
VDI	JIS	DIN	Mat'l No.	AISI/ASTM	SS	AFNOR	UNI	UNE	BS	GOST
12~13	SUS430	X6Cr17	1.4016	430	2320	Z8C17	Z8C17	F3113	430S15	12C17

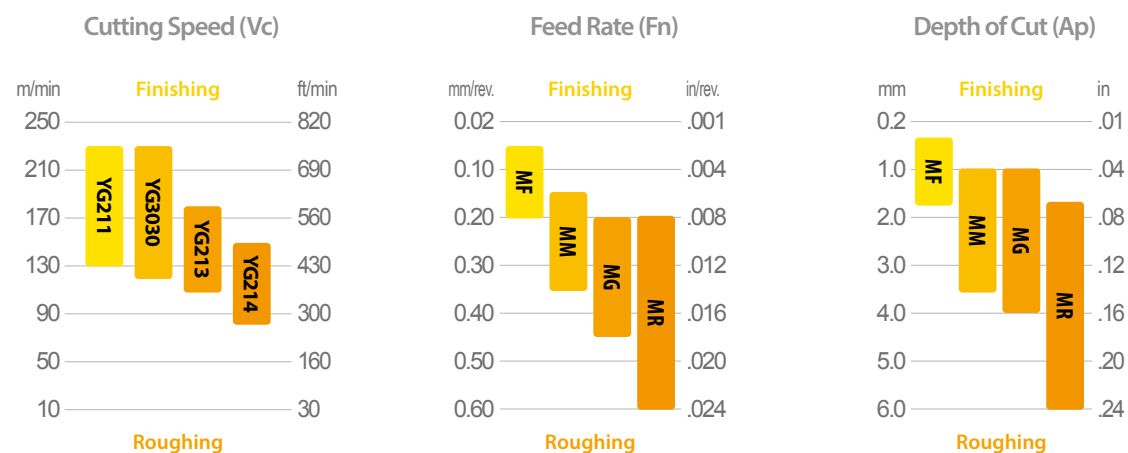

First Choice Grade and Value

Ferritic Stainless steel

YG3030 - Vc 200m/min (660ft/min)
YG213 - Vc 160m/min (520ft/min)

Martensitic

YG3030 - Vc 160m/min (520ft/min)
YG213 - Vc 130m/min (430ft/min)

M	Austenitic Stainless steel									
VDI	JIS	DIN	Mat'l No.	AISI/ASTM	SS	AFNOR	UNI	UNE	BS	GOST
14	SUS304	X5CrNi18 9	1.4350	304	2332	Z6CN18 09	X5CrNi18 10	F3551	304S15	03KH18N11

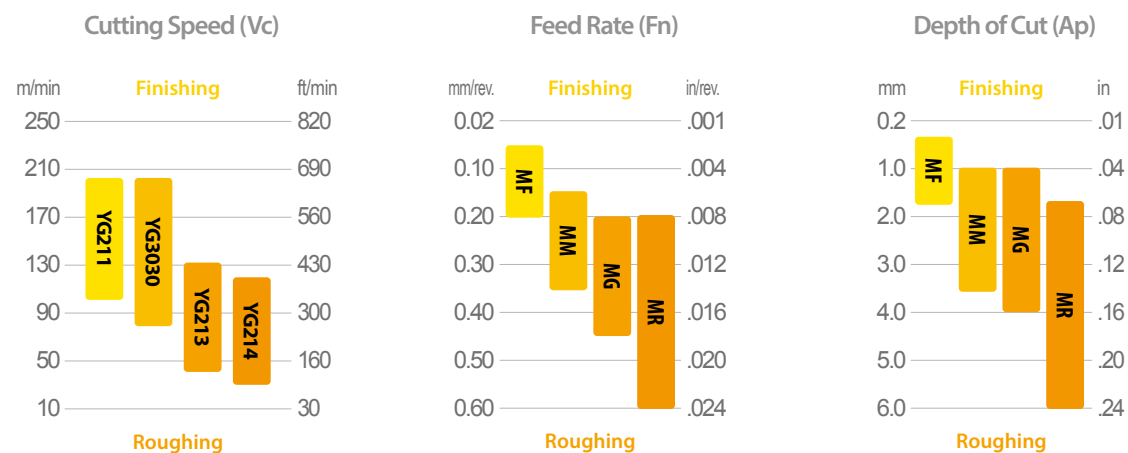

First Choice Grade and Value

YG3030 - Vc 180m/min (590ft/min)
YG213 - Vc 140m/min (460ft/min)

Application Guide Cast iron Guide

K	Grey cast iron									
VDI	JIS	DIN	Mat'l No.	AISI/ASTM	SS	AFNOR	UNI	UNE	BS	GOST
15~16	FC250	GG25	0.6025	A48 40 B	0125	Ft 25 D	G25	FG25	Grade 260	Sc 25

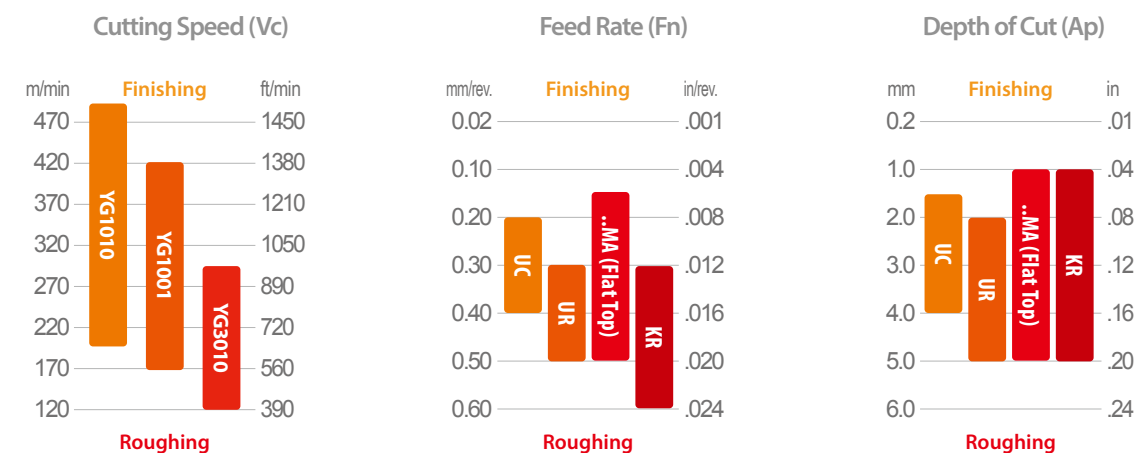

First Choice Grade and Value

YG1010 - Vc 370m/min (1,214ft/min)

K	Nodular cast iron									
VDI	JIS	DIN	Mat'l No.	AISI/ASTM	SS	AFNOR	UNI	UNE	BS	GOST
17~18	FCD500	GGG50	0.7050	80-55-06	0.7050	FGS 500-7	GS 500-7	FGE50-7	SNG 500-7	Vc 50-2

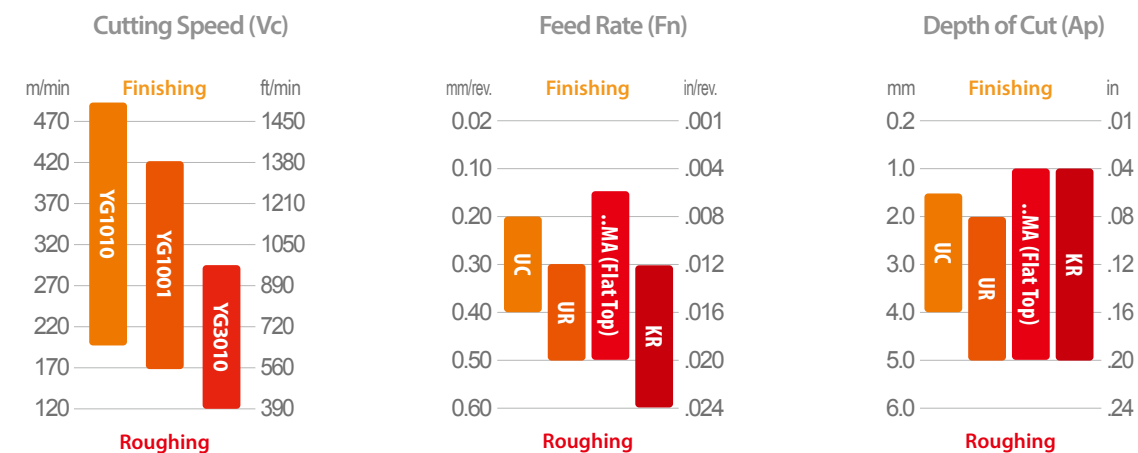

First Choice Grade and Value

YG1010 - Vc 230m/min (755ft/min)

Superalloys & Titanium Alloys											
S	VDI	DIN	Mat'l No.	AISI/ASTM	AFNOR	BS	UNS	Brands	UNE	BS	GOST
31-37	NCr19Fe19NbMo	2.4668	5383	NC19eNB	HR8	N07718	Inconel 718	F3113	430S15	12C17	

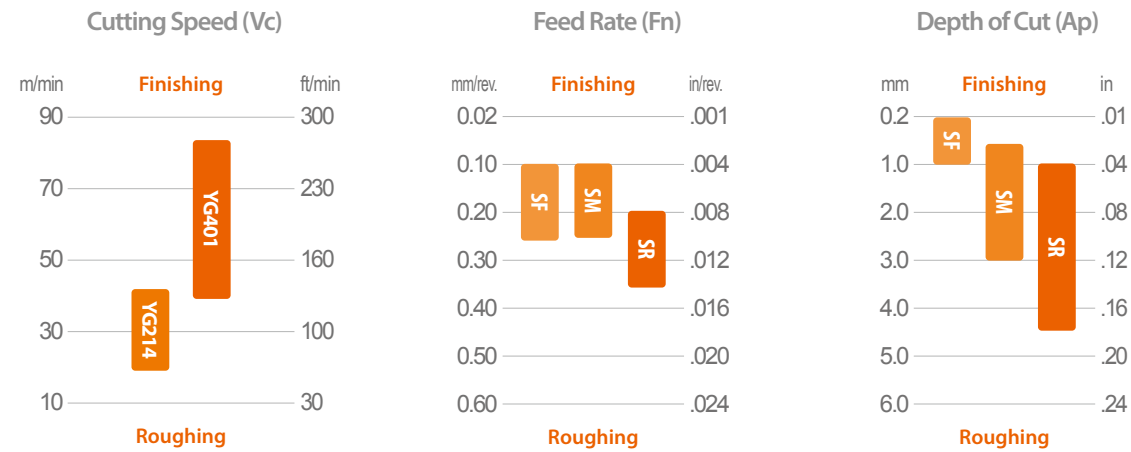

First Choice Grade and Value
YG401 - Vc 50m/min (164ft/min)

Trouble Shooting

Pattern	Reasons	Solutions
<p>Vibration</p> <ul style="list-style-type: none"> - High radial or tangential force - Unstable condition 	<ul style="list-style-type: none"> - Lower depth of cut (ap) - Use sharper chipbreaker - Check stability, and position of tool and workpiece - Reduce the overhang (bigger and shorter tool) 	
<p>Bad Surface</p> <ul style="list-style-type: none"> - Work material is damaged by chips - Feed is too high for corner radius 	<ul style="list-style-type: none"> - Different chipbreaker - Lower depth of cut (ap) - Lower feed - Bigger corner radius 	

Theoretical Surface Roughness

Ra / Rz μ m (μ inch)	Insert Corner Radius Code ISO (ANSI)					
	ISO ANSI					
	02 (0)	04 (1)	08 (2)	12 (3)	16 (4)	24 (6)
	Feed Rate mm/rev (inch/rev)					
0.4 / 1.6 (16 / 64)	0.05 (.002)	0.07 (.003)	0.1 (.004)	0.12 (.005)	0.14 (.006)	0.18 (.007)
1.6 / 6.3 (64 / 256)	0.1 (.004)	0.14 (.006)	0.2 (.008)	0.25 (.010)	0.28 (.011)	0.35 (.014)
3.2 / 12.5 (128 / 512)	0.14 (.006)	0.2 (.008)	0.28 (.011)	0.35 (.014)	0.4 (.016)	0.49 (.019)
6.3 / 25 (250 / 1000)	-	0.28 (.011)	0.4 (.016)	0.49 (.019)	0.57 (.022)	0.69 (.027)
8 / 32 (320 / 1280)	-	-	0.45 (.018)	0.55 (.022)	0.64 (.025)	0.78 (.031)

Trouble Shooting Guide map

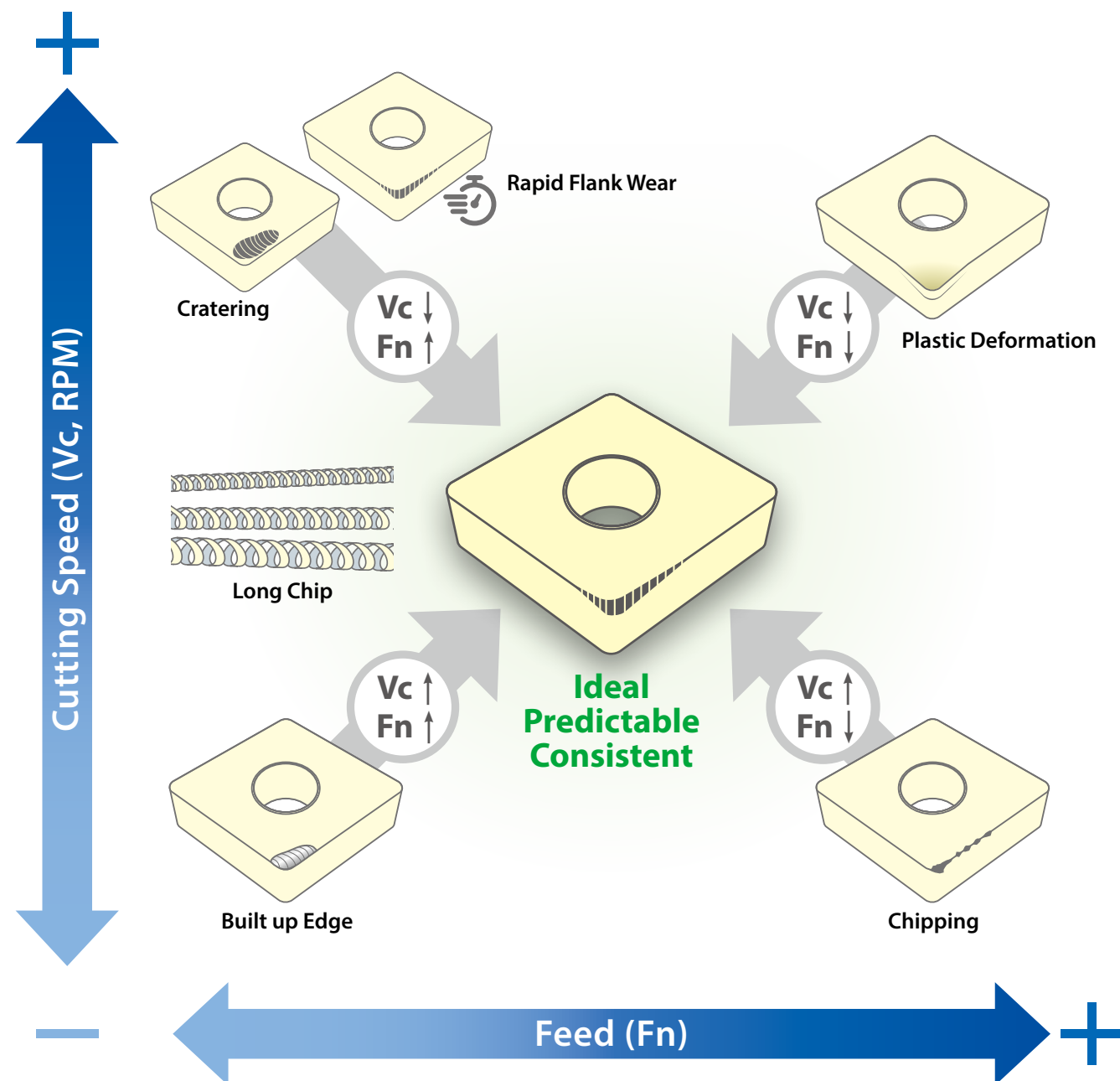

Application Guide
Trouble Shooting

Pattern	Reasons	Solutions
<p>General Flank Wear</p> <p>Flank face near by corner is abraded</p>	<ul style="list-style-type: none"> - The most ideal wear - Consistent and predictable - General wear behavior when machining condition is normal 	
<p>Rapid Flank Wear</p> <p>Looks same as general flank wear, but happens quickly</p>	<p>Grade</p> <ul style="list-style-type: none"> - Not enough wear resistance - Too tough grade <p>Heat</p> <ul style="list-style-type: none"> - Cutting speed is too high - Not enough coolant 	<ul style="list-style-type: none"> - More wear resistant grade - Reduce the cutting speed (Vc, SFM, RPM or SFPM) - Optimize coolant - Increase Feed (Fn) if feed is low
<p>Plastic Deformation</p> <p>Deformed Edge</p>	<ul style="list-style-type: none"> - Excess thermal load - Excess mechanical load 	<ul style="list-style-type: none"> - Reduce cutting temperature - More wear resistant grade - Reduce the cutting speed (Vc, SFM, RPM or SFPM) - Lower feed (Fn) - Lower depth of cut (ap) - Optimize coolant
<p>Built up Edge</p> <p>Workpiece material is welded on the cutting edge</p>	<ul style="list-style-type: none"> - Sticky materials (low carbon steel, Stainless steel, non-ferrous metal, heat resistant super alloys) - Too low cutting speed 	<ul style="list-style-type: none"> - Increase cutting speed - Lower feed rate - Sharper chipbreaker & geometry - Use high pressure coolant - Use PVD grade - Use Positive Insert
<p>Cratering</p>	<p>Heat</p> <ul style="list-style-type: none"> - Cutting speed is too high - Too tough grade 	<ul style="list-style-type: none"> - Reduce cutting temperature - Lower cutting speed (Vc, SFM, RPM or SFPM) - Adjust Feed (Fn) - Harder grade

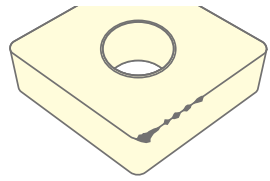
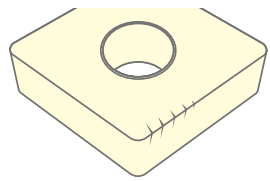
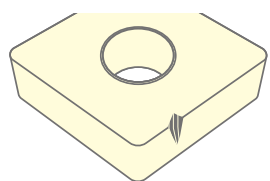
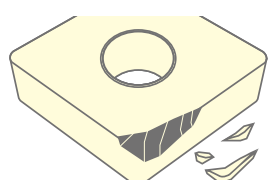
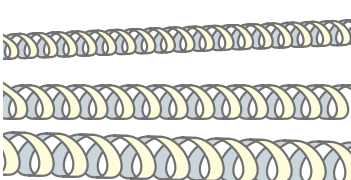
Pattern	Reasons	Solutions
<p>Chipping</p> 	<ul style="list-style-type: none"> - Unstable machining condition (Vibration) - Grade is too hard / brittle - Grade is too sharp 	<ul style="list-style-type: none"> - Focus on stabilizing cutting condition - Reduce overhang (shorter and bigger tool) - Tougher grade - Tougher chipbreaker
<p>Thermal Crack</p> 	<ul style="list-style-type: none"> - Thermal stress due to rapid change of temperature 	<ul style="list-style-type: none"> - Tougher grade - Lower cutting speed (Vc, SFM, RPM or SFPM) - Lower feed (Fn) - Sharper chipbreaker - Change coolant / dry cut
<p>Notching</p> 	<ul style="list-style-type: none"> - Improved edge strength work piece has hardened skin 	<ul style="list-style-type: none"> - More wear resistant grade - Reduce the cutting speed (Vc, SFM, RPM or SFPM) - Adjust Feed (Fn) - Lower depth of cut (ap) - Optimize coolant - Go for tougher chipbreaker
<p>Breakage (Mechanical Fracture)</p> 	<ul style="list-style-type: none"> - Mechanical load is too heavy (feed or depth is too high) - Heavy interrupted cut - Grade is too hard for work material - Unstable machining (vibration) - Cutting speed is too low - Impurities in work material 	<ul style="list-style-type: none"> - Lower feed (Fn) or depth of cut (ap) - Tougher grade - Reduce overhang and check stability of tool and work material - Higher cutting speed (Vc, SFM, RPM or SFPM)
<p>Long Chip</p> 	<ul style="list-style-type: none"> - Feed is too low for chipbreaker - Depth of cut is too shallow for corner radius - Chip area (Fn x Ap) too low 	<ul style="list-style-type: none"> - Higher feed - Sharper chipbreaker - Higher depth of cut - Select a smaller corner radius

Turning Inserts Overview

Negative Inserts

Shape	Series	Size & Thickness				Page
C	CNMA			1204	1606 1906	28
	CNMG	0903 0904		1204	1606 1906	
	CNGG			1204		
D	DNMA			1504 1506		33
	DNMG	1104		1504 1506		
	DNGG			1504 1506		
	DNMX			1504 1506		37
K	KNMX				1604	38
S	SNMA			1204 1506	1906	39
	SNMG			1204		
T	TNMA				1604	43
	TNMG				1604 2204	
	TNMX				1604	47
V	VNMA				1604	48
	VNMG				1604	
W	WNMA	0804				50
	WNMG	0604 0804				
	WNGG	0804				

Positive Inserts

Shape	Series	Size & Thickness				Page
C	CCGT	0602		09T3	1204	54
	CCMT	0602		09T3	1204	
D	DCGT		0702		11T3	55
	DCMT		0702		11T3	
R	RCMT	0602	0803	10T3	1204	56
S	SCGT			09T3		57
	SCMT			09T3	1204	
T	TCGT				1102 16T3	58
	TCMT				1102 16T3	
V	VBMT					1604 59
	VCGT / VCMT				1103	1604 60

Turning Inserts - Negative
CNMG / CNGG / CNMA (80° Negative)

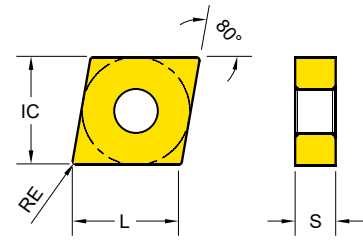

Series	L	IC	S
CN** 0903	8.05	9.530	3.18
CN** 0904	8.05	9.530	4.76
CN** 1204	12.00	12.700	4.76
CN** 1606	16.00	15.875	6.35
CN** 1906	19.00	19.050	6.35

EDP 2200.. ● : Stock item ○ : Order made item

CNMA CNMG	Designation	RE	Fn (mm/rev.)	Ap (mm)	EDP 2200..													
					K10	P05 K20	P10 K30	P15	P20	P30 M20	P20	M15 S10	M30 S20	M40 S30	S10	N20	N20	
					YG1010	YG1001	YG3010	YG3015	YG3020	YG3030	YG801	YG211	YG213	YG214	YG401	YG100	YG10	
..MA Cast iron	CNMA 120404	0.4	0.15~0.50	0.5~5.0	●	●	●											
	CNMA 120408	0.8	0.15~0.50	1.0~5.0	●	●	●											
	CNMA 120412	1.2	0.15~0.50	1.5~5.0	●	●	●											
	CNMA 120416	1.6	0.15~0.50	2.0~5.0	●	●	●											
	CNMA 160612	1.2	0.15~0.50	1.5~5.0	●	●	●											
-UF Finishing	CNMA 160616	1.6	0.15~0.50	2.0~5.0	●	●	●											
	CNMA 190612	1.2	0.15~0.50	1.5~9.0	●	●	●											
	CNMA 190616	1.6	0.15~1.00	3.0~10.0	○	●	●											
	CNMG 120404 - UF	0.4	0.05~0.25	0.5~2.5		●	●	●	●									
	CNMG 120408 - UF	0.8	0.05~0.25	1.0~2.5		●	●	●	●									
CNMG 120412 - UF	1.2	0.05~0.25	1.5~2.5		●	●	●	●										

Turning Inserts - Negative
CNMG / CNGG / CNMA (80° Negative)

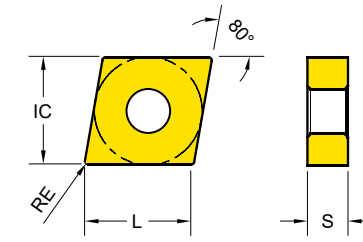

Series	L	IC	S
CN** 0903	8.05	9.530	3.18
CN** 0904	8.05	9.530	4.76
CN** 1204	12.00	12.700	4.76
CN** 1606	16.00	15.875	6.35
CN** 1906	19.00	19.050	6.35

EDP 2200.. ● : Stock item ○ : Order made item

CNMG	Designation	RE	Fn (mm/rev.)	Ap (mm)	EDP 2200..													
					K10	P05 K20	P10 K30	P15	P20	P30 M20	P20	M15 S10	M30 S20	M40 S30	S10	N20	N20	
					YG1010	YG1001	YG3010	YG3015	YG3020	YG3030	YG801	YG211	YG213	YG214	YG401	YG100	YG10	
-UL Light Machining and Sticky Material	CNMG 090308 - UL	0.8	0.10~0.30	1.0~2.5			●	●	●									
	CNMG 090312 - UL	1.2	0.10~0.30	1.5~2.5			●	●	●									
	CNMG 090408 - UL	0.8	0.10~0.30	1.0~2.5			●	●	●									
	CNMG 090412 - UL	1.2	0.10~0.30	1.5~2.5			●	●	●									
	CNMG 120404 - UL	0.4	0.10~0.30	0.5~3.0			●	●	●									
-UM Medium Machining Unstable condition	CNMG 120408 - UL	0.8	0.10~0.30	1.0~3.0			●	●	●									
	CNMG 120412 - UL	1.2	0.10~0.30	1.5~3.0			●	●	●									
	CNMG 120404 - UM	0.4	0.15~0.30	0.5~3.0		●	●	●	●									
	CNMG 120408 - UM	0.8	0.15~0.30	1.0~3.0	●	●	●	●	●									
	CNMG 120412 - UM	1.2	0.15~0.30	1.5~3.0		●	●	●	●									
-UG Medium Machining at stable condition	CNMG 120404 - UG	0.4	0.20~0.40	0.5~3.0	●	●	●	●	●									
	CNMG 120408 - UG	0.8	0.20~0.40	1.0~3.0	●	●	●	●	●						●			
	CNMG 120412 - UG	1.2	0.20~0.40	1.5~3.0	●	●	●	●	●									
	CNMG 160608 - UG	0.8	0.20~0.40	1.0~5.0	●	●	●	●	●									
	CNMG 160612 - UG	1.2	0.20~0.40	1.5~5.0	●	●	●	●	●									
CNMG 160616 - UG	1.6	0.30~0.50	2.0~5.0	●	●	●	●	●										
CNMG 190608 - UG	0.8	0.20~0.60	1.0~6.0	●	●	●	●	●										

Cutting Speed		Vc (m/min.)															
ISO	VDI	Sub Group		YG1010	YG1001	YG3010	YG3015	YG3020	YG3030	YG801	YG211	YG213	YG214	YG401	YG100	YG10	
		Min	Max	Min	Max	Min	Max	Min	Max	Min	Max	Min	Max	Min	Max	Min	Max
P	1~5	-	-	220	480	230	450	200	430	160	380	130	350	120	200	-	-
	6~9	-	-	220	420	180	380	150	350	140	320	130	280	70	200	-	-
	10~11	-	-	-	-	60	200	90	180	60	130	70	110	-	-	-	-
M	12~13	-	-	-	-	-	-	-	-	110	270	120	180	100	150	-	-
	14	-	-	-	-	-	-	-	-	50	150	-	-	150	230	40	160
K	15~16	300	450	250	420	120	300	-	-	-	-	-	-	-	-	-	-
	17~18	120	350	120	300	120	280	-	-	-	-	-	-	-	-	-	-
N	21~30	-	-	-	-	-	-	-	-	-	-	-	-	-	-	250	1200
S	31~37	-	-	-	-	-	-	-	-	-	-	30	100	30	70	30	90
H	38~41	-	-	-	-	-	-	-	-	-	-	-	-	-	-	-	-

Cutting Speed		Vc (m/min.)															
ISO	VDI	Sub Group		YG1010	YG1001	YG3010	YG3015	YG3020	YG3030	YG801	YG211	YG213	YG214	YG401	YG100	YG10	
		Min	Max	Min	Max	Min	Max	Min	Max	Min	Max	Min	Max	Min	Max	Min	Max
P	1~5	-	-	220	480	230	450	200	430	160	380	130	350	120	200	-	-
	6~9	-	-	220	420	180	380	150	350	140	320	130	280	70	200	-	-
	10~11	-	-	-	-	60	200	90	180	60	130	70	110	-	-	-	-
M	12~13	-	-	-	-	-	-	-	-	110	270	120	180	100	150	-	-
	14	-	-	-	-	-	-	-	-	50	150	-	-	150	230	40	160
K	15~16	300	450	250	420	120	300	-	-	-	-	-	-	-	-	-	-
	17~18	120	350	120	300	120	280	-	-	-	-	-	-	-	-	-	-
N	21~30	-	-	-	-	-	-	-	-	-	-	-	-	-	-	250	1200
S	31~37	-	-	-	-	-	-	-	-	-	-	30	100	30	70	30	90
H	38~41	-	-	-	-	-	-	-	-	-	-	-	-	-	-	-	-

Turning Inserts - Negative
DNMG / DNGG / DNMA (55° Negative)

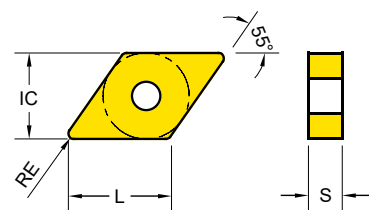

Series	L	IC	S
DN** 1104	9.67	9.53	4.76
DN** 1504	14.00	12.70	4.76
DN** 1506	14.00	12.70	6.35

EDP 2200.. ● : Stock item ○ : Order made item

DNMG	Designation	RE	Fn (mm/rev.)	Ap (mm)	K10	P05	P10	P15	P20	P30	P20	M15	M30	M40	S10	N20	N20
					YG1010	YG1001	YG3010	YG3015	YG3020	YG3030	YG801	YG211	YG213	YG214	YG401	YG100	YG10
-UM Medium Machining Unstable condition	DNMG 150404 -UM	0.4	0.15~0.30	0.50~3.00													
	DNMG 150408 -UM	0.8	0.15~0.30	1.0~3.0													
	DNMG 150412 -UM	1.2	0.15~0.30	1.5~3.0													
	DNMG 150604 -UM	0.4	0.15~0.30	0.5~3.0													
	DNMG 150608 -UM	0.8	0.15~0.30	1.0~3.0													
	DNMG 150612 -UM	1.2	0.15~0.30	1.5~3.0													
-UG Medium Machining at stable condition	DNMG 150404 -UG	0.4	0.20~0.40	0.5~3.0													
	DNMG 150408 -UG	0.8	0.20~0.40	1.0~3.0													
	DNMG 150412 -UG	1.2	0.20~0.40	1.5~3.0													
	DNMG 150604 -UG	0.4	0.20~0.40	0.5~3.0													
	DNMG 150608 -UG	0.8	0.20~0.40	1.0~3.0													
	DNMG 150612 -UG	1.2	0.20~0.40	1.5~3.0													
-UC Cast iron and Medium roughing	DNMG 150408 -UC	0.8	0.20~0.40	1.0~4.0													
	DNMG 150412 -UC	1.2	0.20~0.40	1.5~4.0													
	DNMG 150608 -UC	0.8	0.20~0.40	1.0~4.0													
	DNMG 150612 -UC	1.2	0.20~0.40	1.5~4.0													
-UR Roughing	DNMG 150408 -UR	0.8	0.30~0.50	1.0~5.0													
	DNMG 150412 -UR	1.2	0.30~0.50	1.5~5.0													
	DNMG 150608 -UR	0.8	0.30~0.50	1.0~5.0													
	DNMG 150612 -UR	1.2	0.30~0.50	1.5~5.0													

Cutting Speed		Vc (m/min.)															
ISO	VDI	Sub Group		YG1010	YG1001	YG3010	YG3015	YG3020	YG3030	YG801	YG211	YG213	YG214	YG401	YG100	YG10	
		Min	Max	Min	Max	Min	Max	Min	Max	Min	Max	Min	Max	Min	Max	Min	Max
P	1-5	Non-Alloyed Steel		-	-	220	480	230	450	200	430	160	380	130	350	120	200
	6-9	Low-Alloyed Steel		-	-	220	420	180	380	150	350	140	320	130	280	70	200
	10-11	High-Alloyed Steel		-	-	-	-	60	200	90	180	60	130	70	110	-	-
M	12-13	Ferritic & Martensitic		-	-	-	-	-	-	110	270	120	180	100	150	-	-
	14	Austenitic Stainless Steel		-	-	-	-	-	-	50	150	-	-	150	230	40	160
K	15-16	Grey Cast Iron		300	450	250	420	120	300	-	-	-	-	-	-	-	-
	17-18	Nodular Cast Iron		120	350	120	300	120	280	-	-	-	-	-	-	-	-
N	21-30	Non-Ferrous Metals (Al)		-	-	-	-	-	-	-	-	-	-	-	250	1200	250
S	31-37	Superalloys & Titanium		-	-	-	-	-	-	-	-	-	-	30	100	30	70
H	38-41	Hard Materials		-	-	-	-	-	-	-	-	-	-	-	-	-	-

Turning Inserts - Negative
DNMG / DNGG / DNMA (55° Negative)

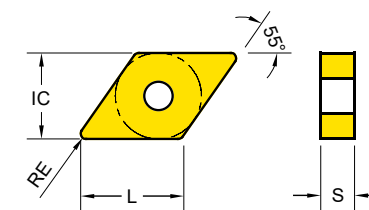

Series	L	IC	S
DN** 1104	9.67	9.53	4.76
DN** 1504	14.00	12.70	4.76
DN** 1506	14.00	12.70	6.35

EDP 2200.. ● : Stock item ○ : Order made item

DNMG	Designation	RE	Fn (mm/rev.)	Ap (mm)	K10	P05	P10	P15	P20	P30	P20	M15	M30	M40	S10	N20	N20
					YG1010	YG1001	YG3010	YG3015	YG3020	YG3030	YG801	YG211	YG213	YG214	YG401	YG100	YG10
-MF Stainless steel Finishing	DNMG 150404 -MF	0.4	0.07~0.30	0.2~1.5													
	DNMG 150408 -MF	0.8	0.07~0.30	0.2~1.5													
	DNMG 150604 -MF	0.4	0.07~0.30	0.2~1.5													
	DNMG 150608 -MF	0.8	0.07~0.30	0.2~1.5													
-MM Stainless steel Medium	DNMG 150404 -MM	0.4	0.20~0.35	0.5~3.5													
	DNMG 150408 -MM	0.8	0.20~0.35	1.0~3.5													
	DNMG 150604 -MM	0.4	0.20~0.35	0.5~3.5													
	DNMG 150608 -MM	0.8	0.20~0.35	1.0~3.5													
-MG Stainless steel Finishing	DNMG 150408 -MG	0.8	0.20~0.40	1.0~4.0													
	DNMG 150608 -MG	0.8	0.20~0.40	1.0~4.0													
-MR Stainless steel Roughing	DNMG 150408 -MR	0.8	0.30~0.55	2.0~5.5													
	DNMG 150412 -MR	1.2	0.30~0.55	2.0~5.5													
	DNMG 150608 -MR	0.8	0.30~0.55	2.0~5.5													
	DNMG 150612 -MR	1.2	0.30~0.55	2.0~5.5													

Cutting Speed		Vc (m/min.)															
ISO	VDI	Sub Group		YG1010	YG1001	YG3010	YG3015	YG3020	YG3030	YG801	YG211	YG213	YG214	YG401	YG100	YG10	
		Min	Max	Min	Max	Min	Max	Min	Max	Min	Max	Min	Max	Min	Max	Min	Max
P	1-5	Non-Alloyed Steel		-	-	220	480	230	450	200	430	160	380	130	350	120	200
	6-9	Low-Alloyed Steel		-	-	220	420	180	380	150	350	140	320	130	280	70	200
	10-11	High-Alloyed Steel		-	-	-	-	60	200	90	180	60	130	70	110	-	-
M	12-13	Ferritic & Martensitic		-	-	-	-	-	-	110	270	120	180	100	150	-	-
	14	Austenitic Stainless Steel		-	-	-	-	-	-	50	150	-	-	150	230	40	160
K	15-16	Grey Cast Iron		300	450	250	420	120	300	-	-	-	-	-	-	-	-
	17-18	Nodular Cast Iron		120	350	120	300	120	280	-	-	-	-	-	-	-	-
N	21-30	Non-Ferrous Metals (Al)		-	-	-	-	-	-	-	-	-	-	-	250	1200	250
S	31-37	Superalloys & Titanium		-	-	-	-	-	-	-	-	-	-	30	100	30	70
H	38-41	Hard Materials		-	-	-	-	-	-	-	-	-	-	-	-	-	-

Turning Inserts - Negative
TNMG / TNMA (60° Negative)

Turning Inserts - Negative
TNMG / TNMA (60° Negative)

TURNING

PARTING & GROOVING

MILLING

DRILLING

TECHNICAL INFORMATION

TURNING

PARTING & GROOVING

MILLING

DRILLING

TECHNICAL INFORMATION

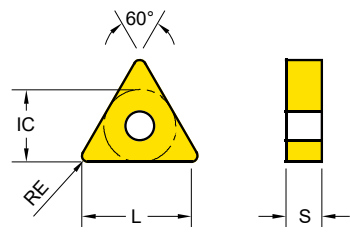

Series	L	IC	S
TN** 1604	15.7	9.525	4.76
TN** 2204	22.0	12.700	4.76

EDP 2200.. ● : Stock item ○ : Order made item

TNMG	Designation	RE	Fn (mm/rev.)	Ap (mm)	EDP 2200..															
					YG1010	YG1001	YG3010	YG3015	YG3020	YG3030	YG801	YG211	YG213	YG214	YG401	YG100	YG10			
-UG Medium Machining at stable condition	TNMG 160404 - UG	0.4	0.20~0.40	0.5~3.0	●	●	●	○	●	●										
	TNMG 160408 - UG	0.8	0.20~0.40	1.0~3.0	●	●	○	●	●	●	●	●								
	TNMG 160412 - UG	1.2	0.20~0.40	1.5~3.0	●	●	○	●	●	●	●	●								
	TNMG 220408 - UG	0.8	0.25~0.60	1.0~6.0	●	●	●	○	●	●	●	●	●							
	TNMG 220412 - UG	1.2	0.25~0.60	1.5~6.0	●	●	○	●	●	●	●	●	●							
	TNMG 220416 - UG	1.6	0.25~0.60	2.0~6.0	●	●	○	●	●	●	●	●	●							
-UC Cast iron and Medium roughing	TNMG 160404 - UC	0.4	0.20~0.40	0.5~4.0	●	●	●	○	●	●	●	●								
	TNMG 160408 - UC	0.8	0.20~0.40	1.0~4.0	●	●	○	●	●	●	●	●	●							
	TNMG 160412 - UC	1.2	0.20~0.40	1.5~4.0	●	●	○	●	●	●	●	●	●							
-UR Roughing	TNMG 160408 - UR	0.8	0.30~0.50	1.0~5.0	●	●	●	○	●	●										
	TNMG 160412 - UR	1.2	0.30~0.50	1.5~5.0	●	●	○	●	●	●	●	●								
	TNMG 220412 - UR	1.2	0.30~0.65	1.5~7.0	●	●	○	●	●	●	●	●	●							
	TNMG 220416 - UR	1.6	0.30~0.65	2.0~7.0	●	●	○	●	●	●	●	●	●							

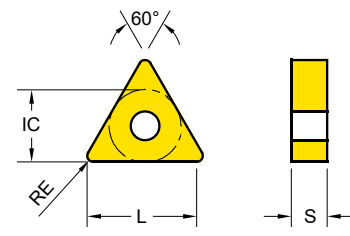

Series	L	IC	S
TN** 1604	15.7	9.525	4.76
TN** 2204	22.0	12.700	4.76

EDP 2200.. ● : Stock item ○ : Order made item

TNMG	Designation	RE	Fn (mm/rev.)	Ap (mm)	EDP 2200..															
					YG1010	YG1001	YG3010	YG3015	YG3020	YG3030	YG801	YG211	YG213	YG214	YG401	YG100	YG10			
-MF Stainless steel Finishing	TNMG 160404 - MF	0.4	0.07~0.3	0.2~1.5															●	●
	TNMG 160408 - MF	0.8	0.07~0.3	0.2~1.5															●	●
-MM Stainless steel Medium	TNMG 160404 - MM	0.4	0.20~0.35	0.5~3.5															●	●
	TNMG 160408 - MM	0.8	0.20~0.35	1.0~3.5															●	●
	TNMG 160412 - MM	1.2	0.20~0.35	1.5~3.5															●	●
-MG Stainless steel General	TNMG 160404 - MG	0.4	0.20~0.40	0.5~4.0															●	●
	TNMG 160408 - MG	0.8	0.20~0.40	1.0~4.0															●	●
-MR Stainless steel Roughing	TNMG 160408 - MR	0.8	0.30~0.55	2.0~5.5															●	●
	TNMG 160412 - MR	1.2	0.30~0.55	2.0~5.5															●	●

Cutting Speed		Vc (m/min.)														
ISO	VDI	Sub Group	YG1010	YG1001	YG3010	YG3015	YG3020	YG3030	YG801	YG211	YG213	YG214	YG401	YG100	YG10	
			Min Max	Min Max	Min Max	Min Max	Min Max	Min Max	Min Max	Min Max	Min Max	Min Max	Min Max	Min Max	Min Max	Min Max
P	1-5	Non-Alloyed Steel	-	-	220 480	230 450	200 430	160 380	130 350	120 200	-	-	-	-	-	-
	6-9	Low-Alloyed Steel	-	-	220 420	180 380	150 350	140 320	130 280	70 200	-	-	-	-	-	-
	10-11	High-Alloyed Steel	-	-	-	60 200	90 180	60 130	70 110	-	-	-	-	-	-	-
M	12-13	Ferritic & Martensitic	-	-	-	-	-	-	110 220	-	-	170 270	120 180	100 150	-	-
	14	Austenitic Stainless Steel	-	-	-	-	-	-	50 150	-	-	150 230	40 160	100 150	-	-
K	15-16	Grey Cast Iron	300 450	250 420	120 300	-	-	-	-	-	-	-	-	-	-	-
	17-18	Nodular Cast Iron	120 350	120 300	120 280	-	-	-	-	-	-	-	-	-	-	-
N	21-30	Non-Ferrous Metals (Al)	-	-	-	-	-	-	-	-	-	-	-	250 1200	250 800	
S	31-37	Superalloys & Titanium	-	-	-	-	-	-	-	30 100	30 70	30 50	30 90	-	-	-
H	38-41	Hard Materials	-	-	-	-	-	-	-	-	-	-	-	-	-	-

Cutting Speed		Vc (m/min.)														
ISO	VDI	Sub Group	YG1010	YG1001	YG3010	YG3015	YG3020	YG3030	YG801	YG211	YG213	YG214	YG401	YG100	YG10	
			Min Max	Min Max	Min Max	Min Max	Min Max	Min Max	Min Max	Min Max	Min Max	Min Max	Min Max	Min Max	Min Max	Min Max
P	1-5	Non-Alloyed Steel	-	-	220 480	230 450	200 430	160 380	130 350	120 200	-	-	-	-	-	-
	6-9	Low-Alloyed Steel	-	-	220 420	180 380	150 350	140 320	130 280	70 200	-	-	-	-	-	-
	10-11	High-Alloyed Steel	-	-	-	60 200	90 180	60 130	70 110	-	-	-	-	-	-	-
M	12-13	Ferritic & Martensitic	-	-	-	-	-	-	110 220	-	-	170 270	120 180	100 150	-	-
	14	Austenitic Stainless Steel	-	-	-	-	-	-	50 150	-	-	150 230	40 160	100 150	-	-
K	15-16	Grey Cast Iron	300 450	250 420	120 300	-	-	-	-	-	-	-	-	-	-	-
	17-18	Nodular Cast Iron	120 350	120 300	120 280	-	-	-	-	-	-	-	-	-	-	-
N	21-30	Non-Ferrous Metals (Al)	-	-	-	-	-	-	-	-	-	-	-	250 1200	250 800	
S	31-37	Superalloys & Titanium	-	-	-	-	-	-	-	30 100	30 70	30 50	30 90	-	-	-
H	38-41	Hard Materials	-	-	-	-	-	-	-	-	-	-	-	-	-	-

Turning Inserts - Negative
TNMG / TNMA (60° Negative)

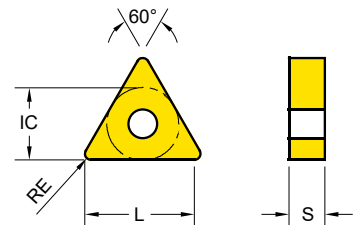

Series	L	IC	S
TN** 1604	15.7	9.525	4.76
TN** 2204	22.0	12.700	4.76

EDP 2200.. ● : Stock item ○ : Order made item

TNMG	Designation	RE	Fn (mm/rev.)	Ap (mm)	EDP 2200..												
					K10	P05 K20	P10 K30	P15	P20	P30 M20	P20	M15 S10	M30 S20	M40 S30	S10	N20	N20
					YG1010	YG1001	YG3010	YG3015	YG3020	YG3030	YG801	YG211	YG213	YG214	YG401	YG100	YG10
-SF	TNMG 160408-SF	0.8	0.10~0.25	0.5~3.0											●		
															1427		
	TNMG 160408-SM	0.8	0.10~0.25	0.5~4.0											●		
	TNMG 160412-SM	1.2	0.10~0.25	0.5~4.0											●		
-SM															1228		
															1508		
	TNMG 160408-SR	0.8	0.10~0.40	0.5~4.0											●		
	TNMG 160412-SR	1.2	0.10~0.40	0.5~4.0											●		
-SR															1307		
															●		
															1306		



TURNING
 PARTING & GROOVING
 MILLING
 DRILLING
 TECHNICAL INFORMATION

Cutting Speed		Vc (m/min.)																											
ISO	VDI	Sub Group	YG1010		YG1001		YG3010		YG3015		YG3020		YG3030		YG801		YG211		YG213		YG214		YG401		YG100		YG10		
			Min	Max	Min	Max	Min	Max	Min	Max	Min	Max	Min	Max	Min	Max	Min	Max	Min	Max	Min	Max	Min	Max	Min	Max	Min	Max	Min
P	1-5	Non-Alloyed Steel	-	-	220	480	230	450	200	430	160	380	130	350	120	200	-	-	-	-	-	-	-	-	-	-	-	-	-
	6-9	Low-Alloyed Steel	-	-	220	420	180	380	150	350	140	320	130	280	70	200	-	-	-	-	-	-	-	-	-	-	-	-	-
	10-11	High-Alloyed Steel	-	-	-	-	60	200	90	180	60	130	70	110	-	-	-	-	-	-	-	-	-	-	-	-	-	-	
M	12-13	Ferritic & Martensitic	-	-	-	-	-	-	-	-	-	110	220	-	-	170	270	120	180	100	150	-	-	-	-	-	-	-	-
	14	Austenitic Stainless Steel	-	-	-	-	-	-	-	-	-	50	150	-	-	150	230	40	160	100	150	-	-	-	-	-	-	-	
K	15-16	Grey Cast Iron	300	450	250	420	120	300	-	-	-	-	-	-	-	-	-	-	-	-	-	-	-	-	-	-	-	-	
	17-18	Nodular Cast Iron	120	350	120	300	120	280	-	-	-	-	-	-	-	-	-	-	-	-	-	-	-	-	-	-	-	-	
N	21-30	Non-Ferrous Metals (Al)	-	-	-	-	-	-	-	-	-	-	-	-	-	-	-	-	-	-	-	-	-	-	-	250	1200	250	800
S	31-37	Superalloys & Titanium	-	-	-	-	-	-	-	-	-	-	-	-	-	30	100	30	70	30	50	30	90	-	-	-	-	-	
H	38-41	Hard Materials	-	-	-	-	-	-	-	-	-	-	-	-	-	-	-	-	-	-	-	-	-	-	-	-	-	-	

Turning Inserts - Negative
TNUX (60° Negative)

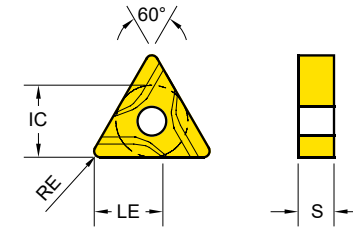

Series	LE	IC	S
TN** 1604	9.4	9.525	4.76

EDP 2200.. ● : Stock item ○ : Order made item

TNUX	Designation	RE	Fn (mm/rev.)	Ap (mm)	EDP 2200..												
					K10	P05 K20	P10 K30	P15	P20	P30 M20	P20	M15 S10	M30 S20	M40 S30	S10	N20	N20
					YG1010	YG1001	YG3010	YG3015	YG3020	YG3030	YG801	YG211	YG213	YG214	YG401	YG100	YG10
..UX Left	TNUX 160404 L	0.4	0.10~0.30	0.5~4.0			●		●	●							
	TNUX 160408 L	0.8	0.10~0.40	1.0~5.0			●		●	●			●				
							0412		0413	1264		0043					
							0414		0415	0675		0045		0731			
..UX Right	TNUX 160404 R	0.4	0.10~0.30	0.5~4.0			●		●	●							
	TNUX 160408 R	0.8	0.10~0.40	1.0~5.0			●		●	●			●				
							0288		0289	0290		0044					
							0291		0292	0293		0046					



TURNING
 PARTING & GROOVING
 MILLING
 DRILLING
 TECHNICAL INFORMATION

Cutting Speed		Vc (m/min.)																										
ISO	VDI	Sub Group	YG1010		YG1001		YG3010		YG3015		YG3020		YG3030		YG801		YG211		YG213		YG214		YG401		YG100		YG10	
			Min	Max	Min	Max	Min	Max	Min	Max	Min	Max	Min	Max	Min	Max	Min	Max	Min	Max	Min	Max	Min	Max	Min	Max	Min	Max
P	1-5	Non-Alloyed Steel	-	-	220	480	230	450	200	430	160	380	130	350	120	200	-	-	-	-	-	-	-	-	-	-	-	-
	6-9	Low-Alloyed Steel	-	-	220	420	180	380	150	350	140	320	130	280	70	200	-	-	-	-	-	-	-	-	-	-	-	
	10-11	High-Alloyed Steel	-	-	-	-	60	200	90	180	60	130	70	110	-	-	-	-	-	-	-	-	-	-	-	-	-	
M	12-13	Ferritic & Martensitic	-	-	-	-	-	-	-	-	-	110	220	-	-	170	270	120	180	100	150	-	-	-	-	-	-	
	14	Austenitic Stainless Steel	-	-	-	-	-	-	-	-	-	50	150	-	-	150	230	40	160	100	150	-	-	-	-	-		
K	15-16	Grey Cast Iron	300	450	250	420	120	300	-	-	-	-	-	-	-	-	-	-	-	-	-	-	-	-	-	-		
	17-18	Nodular Cast Iron	120	350	120	300	120	280	-	-	-	-	-	-	-	-	-	-	-	-	-	-	-	-	-	-		
N	21-30	Non-Ferrous Metals (Al)	-	-	-	-	-	-	-	-	-	-	-	-	-	-	-	-	-	-	-	-	-	-	250	1200	250	800
S	31-37	Superalloys & Titanium	-	-	-	-	-	-	-	-	-	-	-	-	-	30	100	30	70	30	50	30	90	-	-	-		
H	38-41	Hard Materials	-	-	-	-	-	-	-	-	-	-	-	-	-	-	-	-	-	-	-	-	-	-	-	-		

Turning Inserts - Negative VNMG / VNMA (35° Negative)

Turning Inserts - Negative VNMG / VNMA (35° Negative)

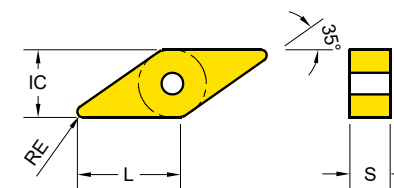
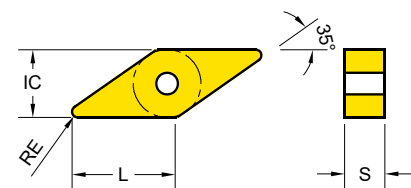

Series	L	IC	S
VN** 1604	15.8	9.525	4.76

Series	L	IC	S
VN** 1604	15.8	9.525	4.76

EDP 2200.. ● : Stock item ○ : Order made item

EDP 2200.. ● : Stock item ○ : Order made item

VNMA VNMG	Designation	RE	Fn (mm/rev.)	Ap (mm)	EDP 2200..													
					K10	P05	P10	P15	P20	P30	P20	M15	M30	M40	S10	N20	N20	
					YG1010	YG1001	YG3010	YG3015	YG3020	YG3030	YG801	YG211	YG213	YG214	YG401	YG100	YG10	
..MA Cast iron	VNMA 160408	0.8	0.15~0.40	1.0~5.0	●	●	●											
	VNMG 160404 - UF	0.4	0.05~0.25	0.5~2.5			●		●	●	●							
-UF Finishing	VNMG 160408 - UF	0.8	0.05~0.25	1.0~2.5			●		●	●								
	VNMG 160404 - UL	0.4	0.10~0.30	0.5~3.0			●		●	●								
-UL Light Machining and Sticky Material	VNMG 160408 - UL	0.8	0.10~0.30	1.0~3.0			●	○	●	●								
	VNMG 160408 - UM	0.8	0.15~0.30	1.0~3.0		●	●		●	●								
-UM Medium Machining Unstable condition	VNMG 160412 - UM	1.2	0.15~0.30	1.5~3.0		●	●	○	●	●								
	VNMG 160404 - UG	0.4	0.20~0.40	0.5~3.0	●	●	●		●	●								
-UG Medium Machining at stable condition	VNMG 160408 - UG	0.8	0.20~0.40	1.0~3.0	●	●	●		●	●		●	●	○				
	VNMG 160412 - UG	1.2	0.20~0.40	1.5~3.0	●	●	●		●	●		●	●					

VNMG	Designation	RE	Fn (mm/rev.)	Ap (mm)	EDP 2200..													
					K10	P05	P10	P15	P20	P30	P20	M15	M30	M40	S10	N20	N20	
					YG1010	YG1001	YG3010	YG3015	YG3020	YG3030	YG801	YG211	YG213	YG214	YG401	YG100	YG10	
-UC Cast iron and Medium roughing	VNMG 160404 - UC	0.4	0.20~0.40	0.5~3.5	●	●	●											
	VNMG 160408 - UC	0.8	0.20~0.40	1.0~3.5	●	●	●		●	●								
	VNMG 160412 - UC	1.2	0.20~0.40	1.5~3.5	●	●	●		●	●								
-UR Roughing	VNMG 160412 - UR	1.2	0.30~0.50	1.5~5.0	●	●	●	○	●	●	●							
	VNMG 160408 - MF	0.8	0.07~0.30	0.2~1.5					●	●				●	●			
-MM Stainless steel Medium	VNMG 160404 - MM	0.4	0.20~0.35	0.5~3.5										●	●	●		
	VNMG 160408 - MM	0.8	0.20~0.35	1.0~3.5										●	●	●		
-MR Stainless steel Roughing	VNMG 160408 - MR	0.8	0.30~0.55	2.0~5.5					●	●								
	VNMG 160408 - SR	0.8	0.10~0.40	0.5~4.0													●	

Cutting Speed		Vc (m/min.)																
ISO	VDI	Sub Group		YG1010	YG1001	YG3010	YG3015	YG3020	YG3030	YG801	YG211	YG213	YG214	YG401	YG100	YG10		
		Min	Max	Min	Max	Min	Max	Min	Max	Min	Max	Min	Max	Min	Max	Min	Max	
P	1~5	-	-	220	480	230	450	200	430	160	380	130	350	120	200	-	-	
	6~9	-	-	220	420	180	380	150	350	140	320	130	280	70	200	-	-	
	10~11	-	-	-	-	60	200	90	180	60	130	70	110	-	-	-	-	
M	12~13	-	-	-	-	-	-	-	-	110	270	120	180	100	150	-	-	
	14	-	-	-	-	-	-	-	-	50	150	-	-	150	230	40	160	
K	15~16	300	450	250	420	120	300	-	-	-	-	-	-	-	-	-	-	
	17~18	120	350	120	300	120	280	-	-	-	-	-	-	-	-	-	-	
N	21~30	-	-	-	-	-	-	-	-	-	-	-	-	-	-	250	1200	
S	31~37	-	-	-	-	-	-	-	-	-	30	100	30	70	30	50	30	90
H	38~41	-	-	-	-	-	-	-	-	-	-	-	-	-	-	-	-	

Cutting Speed		Vc (m/min.)																
ISO	VDI	Sub Group		YG1010	YG1001	YG3010	YG3015	YG3020	YG3030	YG801	YG211	YG213	YG214	YG401	YG100	YG10		
		Min	Max	Min	Max	Min	Max	Min	Max	Min	Max	Min	Max	Min	Max	Min	Max	
P	1~5	-	-	220	480	230	450	200	430	160	380	130	350	120	200	-	-	
	6~9	-	-	220	420	180	380	150	350	140	320	130	280	70	200	-	-	
	10~11	-	-	-	-	60	200	90	180	60	130	70	110	-	-	-	-	
M	12~13	-	-	-	-	-	-	-	-	110	270	120	180	100	150	-	-	
	14	-	-	-	-	-	-	-	-	50	150	-	-	150	230	40	160	
K	15~16	300	450	250	420	120	300	-	-	-	-	-	-	-	-	-	-	
	17~18	120	350	120	300	120	280	-	-	-	-	-	-	-	-	-	-	
N	21~30	-	-	-	-	-	-	-	-	-	-	-	-	-	-	250	1200	
S	31~37	-	-	-	-	-	-	-	-	-	30	100	30	70	30	50	30	90
H	38~41	-	-	-	-	-	-	-	-	-	-	-	-	-	-	-	-	

Turning Inserts - Negative

WNMG / WNGG / WNMA (80° Trigonal Negative)

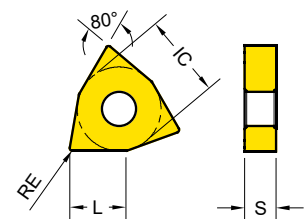

Series	L	IC	S
WN** 0604	5.7	9.525	4.76
WN** 0804	7.8	12.700	4.76

EDP 2200.. ● : Stock item ○ : Order made item

WNMG	Designation	RE	Fn (mm/rev.)	Ap (mm)	K10	P05	P10	P15	P20	P30	P20	M15	M30	M40	S10	N20	N20	
					YG1010	K20	K30	YG3010	YG3015	YG3020	YG3030	YG801	YG211	YG213	YG214	YG401	YG100	YG10
-MF Stainless steel Finishing	WNMG 060404 - MF	0.4	0.07~0.30	0.2~1.5														
	WNMG 060408 - MF	0.8	0.07~0.30	0.2~1.5														
	WNMG 080404 - MF	0.4	0.07~0.30	0.2~1.5														
	WNMG 080408 - MF	0.8	0.07~0.30	0.2~1.5														
-MM Stainless steel Medium	WNMG 080404 - MM	0.4	0.20~0.35	0.5~3.5														
	WNMG 080408 - MM	0.8	0.20~0.35	1.0~3.5														
	WNMG 080412 - MM	1.2	0.20~0.35	1.5~3.5														
-MG Medium Machining at stable condition	WNMG 080408 - MG	0.8	0.20~0.40	1.0~4.0														
	WNMG 080412 - MG	1.2	0.20~0.40	1.5~4.0														
-MR Stainless steel Roughing	WNMG 060412 - MR	1.2	0.30~0.55	1.2~4.0														
	WNMG 080408 - MR	0.8	0.30~0.55	2.0~5.5														
	WNMG 080412 - MR	1.2	0.30~0.55	2.0~5.5														

Turning Inserts - Negative

WNGG / WNGG / WNMA (80° Trigonal Negative)

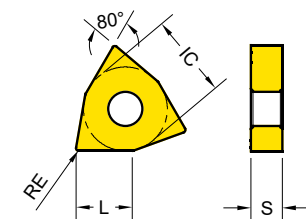

Series	L	IC	S
WN** 0604	5.7	9.525	4.76
WN** 0804	7.8	12.700	4.76

EDP 2200.. ● : Stock item ○ : Order made item

WNGG WNMG	Designation	RE	Fn (mm/rev.)	Ap (mm)	K10	P05	P10	P15	P20	P30	P20	M15	M30	M40	S10	N20	N20	
					YG1010	K20	K30	YG3010	YG3015	YG3020	YG3030	YG801	YG211	YG213	YG214	YG401	YG100	YG10
-SF HRSA Finishing	WNGG 080408 - SF	0.8	0.10~0.25	0.50~3.00														
	WNMG 080408 - SM	0.8	0.10~0.25	0.5~4.0														
-SM HRSA Medium	WNMG 080412 - SM	1.2	0.10~0.25	0.5~4.0														
	WNMG 060412 - SR	1.2	0.10~0.40	0.5~3.0														
-SR HRSA Roughing	WNMG 080408 - SR	0.8	0.10~0.40	0.5~4.0														
	WNMG 080412 - SR	1.2	0.10~0.40	0.5~4.0														

Cutting Speed			Vc (m/min.)															
ISO	VDI	Sub Group	YG1010	YG1001	YG3010	YG3015	YG3020	YG3030	YG801	YG211	YG213	YG214	YG401	YG100	YG10	YG10	YG10	
			Min	Max	Min	Max	Min	Max	Min	Max	Min	Max	Min	Max	Min	Max	Min	Max
P	1~5	Non-Alloyed Steel	-	-	220	480	230	450	200	430	160	380	130	350	120	200	-	-
	6~9	Low-Alloyed Steel	-	-	220	420	180	380	150	350	140	320	130	280	70	200	-	-
	10~11	High-Alloyed Steel	-	-	-	-	60	200	90	180	60	130	70	110	-	-	-	-
M	12~13	Ferritic & Martensitic	-	-	-	-	-	-	-	-	-	-	110	220	-	-	170	270
	14	Austenitic Stainless Steel	-	-	-	-	-	-	-	-	-	-	50	150	-	-	150	230
K	15~16	Grey Cast Iron	300	450	250	420	120	300	-	-	-	-	-	-	-	-	-	-
	17~18	Nodular Cast Iron	120	350	120	300	120	280	-	-	-	-	-	-	-	-	-	-
N	21~30	Non-Ferrous Metals (Al)	-	-	-	-	-	-	-	-	-	-	-	-	-	-	250	1200
S	31~37	Superalloys & Titanium	-	-	-	-	-	-	-	-	-	-	30	100	30	70	30	50
H	38~41	Hard Materials	-	-	-	-	-	-	-	-	-	-	-	-	-	-	-	-

Cutting Speed			Vc (m/min.)															
ISO	VDI	Sub Group	YG1010	YG1001	YG3010	YG3015	YG3020	YG3030	YG801	YG211	YG213	YG214	YG401	YG100	YG10	YG10	YG10	
			Min	Max	Min	Max	Min	Max	Min	Max	Min	Max	Min	Max	Min	Max	Min	Max
P	1~5	Non-Alloyed Steel	-	-	220	480	230	450	200	430	160	380	130	350	120	200	-	-
	6~9	Low-Alloyed Steel	-	-	220	420	180	380	150	350	140	320	130	280	70	200	-	-
	10~11	High-Alloyed Steel	-	-	-	-	60	200	90	180	60	130	70	110	-	-	-	-
M	12~13	Ferritic & Martensitic	-	-	-	-	-	-	-	-	-	-	110	220	-	-	170	270
	14	Austenitic Stainless Steel	-	-	-	-	-	-	-	-	-	-	50	150	-	-	150	230
K	15~16	Grey Cast Iron	300	450	250	420	120	300	-	-	-	-	-	-	-	-	-	-
	17~18	Nodular Cast Iron	120	350	120	300	120	280	-	-	-	-	-	-	-	-	-	-
N	21~30	Non-Ferrous Metals (Al)	-	-	-	-	-	-	-	-	-	-	-	-	-	-	250	1200
S	31~37	Superalloys & Titanium	-	-	-	-	-	-	-	-	-	-	30	100	30	70	30	50
H	38~41	Hard Materials	-	-	-	-	-	-	-	-	-	-	-	-	-	-	-	-

Turning Inserts - Positive
CCMT / CCGT (80° Positive)

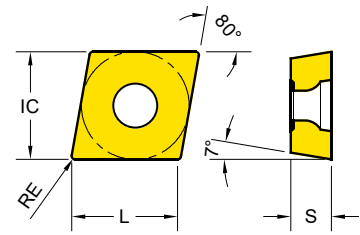

Series	L	IC	S
CC** 0602	6.2	6.350	2.38
CC** 09T3	9.2	9.525	3.97
CC** 1204	12.4	12.700	4.76

EDP 2200.. ● : Stock item ○ : Order made item

CCGT CCMT	Designation	RE	Fn (mm/rev.)	Ap (mm)	K10	P05 K20	P10 K30	P15	P20	P30 M20	P20	M15 S10	M30 S20	M40 S30	S10	N20	N20	
					YG1010	YG1001	YG3010	YG3015	YG3020	YG3030	YG801	YG211	YG213	YG214	YG401	YG100	YG10	
	CCGT 060202 - AL	0.2	0.02~0.15	0.1~2.0														● 1398
	CCGT 060204 - AL	0.4	0.02~0.15	0.5~2.0														● 1320
	CCGT 09T302 - AL	0.2	0.02~0.08	0.5~1.0														● 0340 ● 0339
	CCGT 09T304 - AL	0.4	0.05~0.25	0.5~2.0														● 0330 ● 0081
	CCGT 09T308 - AL	0.8	0.10~0.35	1.0~3.0														● 0331 ● 0082
	CCGT 120402 - AL	0.2	0.04~0.15	0.1~1.0														● 0474 ● 0473
	CCGT 120404 - AL	0.4	0.04~0.20	0.3~1.5														● 0476 ● 0475
	CCGT 120408 - AL	0.8	0.04~0.30	0.6~2.5														● 0478 ● 0477
	CCMT 060204 - UF	0.4	0.05~0.20	0.5~2.0			● 0163 ○ 0866		● 0164	● 0165								
	CCMT 09T304 - UF	0.4	0.05~0.25	0.5~2.0			● 0169		● 0170	● 0171								
	CCMT 09T308 - UF	0.8	0.05~0.25	1.0~2.0			● 0964		● 0951	● 0953								
	CCMT 060204 - UG	0.4	0.10~0.25	0.5~2.0	● 1377		● 0166		● 0167	● 0168	● 0006							
	CCMT 060208 - UG	0.8	0.10~0.25	0.8~2.0	● 1825		● 0479		● 0683	● 0684	● 0009							
	CCMT 09T304 - UG	0.4	0.15~0.30	0.5~2.5	● 1844		● 0172		● 0173	● 0174	● 0007							
	CCMT 09T308 - UG	0.8	0.15~0.30	0.8~2.5	● 1553	● 0445	● 0150		● 0151	● 0152	● 0008							
	CCMT 120404 - UG	0.4	0.15~0.35	0.5~3.0	● 1845		● 0175		● 0176	● 0177								
	CCMT 120408 - UG	0.8	0.15~0.35	0.8~3.0	● 1462		● 0153	○ 0867	● 0154	● 0155	● 0005							
	CCMT 120412 - UG	1.2	0.15~0.35	1.2~3.0	● 1846		● 0483		● 0915	● 1135								

Cutting Speed			Vc (m/min.)															
ISO	VDI	Sub Group	YG1010	YG1001	YG3010	YG3015	YG3020	YG3030	YG801	YG211	YG213	YG214	YG401	YG100	YG10			
			Min	Max	Min	Max	Min	Max	Min	Max	Min	Max	Min	Max	Min	Max	Min	Max
P	1-5	Non-Alloyed Steel	-	-	220	480	230	450	200	430	160	380	130	350	120	200	-	-
	6-9	Low-Alloyed Steel	-	-	220	420	180	380	150	350	140	320	130	280	70	200	-	-
	10-11	High-Alloyed Steel	-	-	-	-	60	200	90	180	60	130	70	110	-	-	-	-
M	12-13	Ferritic & Martensitic	-	-	-	-	-	-	-	-	-	-	110	220	-	-	170	270
	14	Austenitic Stainless Steel	-	-	-	-	-	-	-	-	-	-	50	150	-	-	150	230
K	15-16	Grey Cast Iron	300	450	250	420	120	300	-	-	-	-	-	-	-	-	-	-
	17-18	Nodular Cast Iron	120	350	120	300	120	280	-	-	-	-	-	-	-	-	-	-
N	21-30	Non-Ferrous Metals (Al)	-	-	-	-	-	-	-	-	-	-	-	-	-	-	250	1200
S	31-37	Superalloys & Titanium	-	-	-	-	-	-	-	-	-	-	-	-	-	-	30	100
H	38-41	Hard Materials	-	-	-	-	-	-	-	-	-	-	-	-	-	-	-	-

Turning Inserts - Positive
DCMT / DCGT (55° Positive)

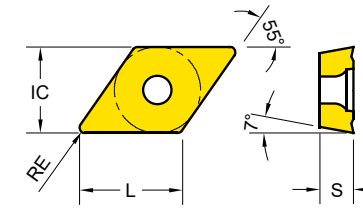

Series	L	IC	S
DC** 0702	7.5	6.350	2.38
DC** 11T3	11.2	9.525	3.97

EDP 2200.. ● : Stock item ○ : Order made item

DCGT DCMT	Designation	RE	Fn (mm/rev.)	Ap (mm)	K10	P05 K20	P10 K30	P15	P20	P30 M20	P20	M15 S10	M30 S20	M40 S30	S10	N20	N20	
					YG1010	YG1001	YG3010	YG3015	YG3020	YG3030	YG801	YG211	YG213	YG214	YG401	YG100	YG10	
	DCGT 070202 - AL	0.2	0.01~0.08	0.05~1.00														● 1399
	DCGT 11T302 - AL	0.2	0.02~0.08	0.5~1.0														● 0342 ● 0341
	DCGT 11T304 - AL	0.4	0.05~0.25	0.5~2.0														● 0332 ● 0083
	DCGT 11T308 - AL	0.8	0.10~0.30	1.0~2.5														● 0333 ● 0084
	DCMT 070204 - UF	0.4	0.05~0.20	0.5~2.0			● 0207		● 0208	● 0209								
	DCMT 11T304 - UF	0.4	0.05~0.25	0.5~2.0			● 0213		● 0214	● 0215								
	DCMT 11T308 - UF	0.8	0.05~0.25	1.0~2.0			● 0219		● 0220	● 0221								
	DCMT 070204 - UG	0.4	0.10~0.25	0.5~2.0	● 1849		● 0210		● 0211	● 0212	● 0013							
	DCMT 070208 - UG	0.8	0.10~0.25	0.8~2.0	● 1850		● 0484		● 0717	● 1136								
	DCMT 11T304 - UG	0.4	0.15~0.30	0.5~2.5	● 1831	● 0677	● 0216		● 0217	● 0218	● 0014							
DCMT 11T308 - UG	0.8	0.15~0.30	0.8~2.5	● 1832	● 0678	● 0222		● 0223	● 0224	● 0015								

Cutting Speed			Vc (m/min.)															
ISO	VDI	Sub Group	YG1010	YG1001	YG3010	YG3015	YG3020	YG3030	YG801	YG211	YG213	YG214	YG401	YG100	YG10			
			Min	Max	Min	Max	Min	Max	Min	Max	Min	Max	Min	Max	Min	Max	Min	Max
P	1-5	Non-Alloyed Steel	-	-	220	480	230	450	200	430	160	380	130	350	120	200	-	-
	6-9	Low-Alloyed Steel	-	-	220	420	180	380	150	350	140	320	130	280	70	200	-	-
	10-11	High-Alloyed Steel	-	-	-	-	60	200	90	180	60	130	70	110	-	-	-	-
M	12-13	Ferritic & Martensitic	-	-	-	-	-	-	-	-	-	-	-	110	220	-	-	170
	14	Austenitic Stainless Steel	-	-	-	-	-	-	-	-	-	-	-	50	150	-	-	150
K	15-16	Grey Cast Iron	300	450	250	420	120	300	-	-	-	-	-	-	-	-	-	-
	17-18	Nodular Cast Iron	120	350	120	300	120	280	-	-	-	-	-	-	-	-	-	-
N	21-30	Non-Ferrous Metals (Al)	-	-	-	-	-	-	-	-	-	-	-	-	-	-	250	1200
S	31-37	Superalloys & Titanium	-	-	-	-	-	-	-	-	-	-	-	-	-	-	30	100
H	38-41	Hard Materials	-	-	-	-	-	-	-	-	-	-	-	-	-	-	-	-

Turning Inserts - Positive
TCMT / TCGT (Triangle Positive)

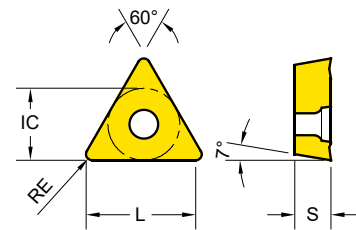

Series	L	IC	S
TC** 1102	10.3	6.350	2.38
TC** 16T3	15.6	9.525	3.97

EDP 2200.. ● : Stock item ○ : Order made item

TCGT TCMT	Designation	RE	Fn (mm/rev.)	Ap (mm)	K10	P05 K20	P10 K30	P15	P20	P30 M20	P20	M15 S10	M30 S20	M40 S30	S10	N20	N20	
					YG1010	YG1001	YG3010	YG3015	YG3020	YG3030	YG801	YG211	YG213	YG214	YG401	YG100	YG10	
-AL Aluminum	TCGT 110204 -AL	0.4	0.03~0.30	0.5~2.0														●
	TCGT 16T302 -AL	0.2	0.02~0.05	0.5~1.0														●
	TCGT 16T304 -AL	0.4	0.05~0.25	0.5~2.0														●
	TCGT 16T308 -AL	0.8	0.10~0.35	1.0~3.0														●
-UF Finishing	TCMT 110204 -UF	0.4	0.05~0.20	0.5~2.0			●		●	●								
	TCMT 16T304 -UF	0.4	0.05~0.25	0.5~2.0			●		●	●	●							
	TCMT 16T308 -UF	0.8	0.05~0.25	0.8~2.0			●		●	●	●							
-UG General	TCMT 110204 -UG	0.4	0.10~0.25	0.5~2.0	●	●	●		●	●	●							
	TCMT 110208 -UG	0.8	0.10~0.25	0.8~2.0	●		●		●	●								
	TCMT 16T304 -UG	0.4	0.15~0.30	0.5~2.5	●	●	●		●	●								
	TCMT 16T308 -UG	0.8	0.15~0.30	0.8~2.5	●	●	●		●	●								

Turning Inserts - Positive
VBMT (35° Positive)

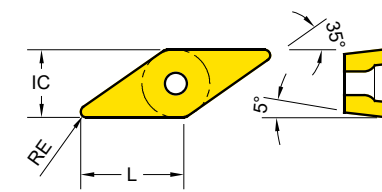

Series	L	IC	S
VB** 1604	15.8	9.525	4.76

EDP 2200.. ● : Stock item ○ : Order made item

VBMT	Designation	RE	Fn (mm/rev.)	Ap (mm)	K10	P05 K20	P10 K30	P15	P20	P30 M20	P20	M15 S10	M30 S20	M40 S30	S10	N20	N20	
					YG1010	YG1001	YG3010	YG3015	YG3020	YG3030	YG801	YG211	YG213	YG214	YG401	YG100	YG10	
-UF Finishing	VBMT 160404 -UF	0.4	0.05~0.25	0.5~2.0			●			●	●							
	VBMT 160408 -UF	0.8	0.05~0.25	0.8~2.0			●			●	●							
-UG General	VBMT 160404 -UG	0.4	0.15~0.30	0.5~2.5	●	●	●		●	●	●							
	VBMT 160408 -UG	0.8	0.15~0.30	0.8~2.5	●	●	●		●	●	●							

Cutting Speed		Vc (m/min.)																
ISO	VDI	Sub Group	YG1010	YG1001	YG3010	YG3015	YG3020	YG3030	YG801	YG211	YG213	YG214	YG401	YG100	YG10			
			Min	Max	Min	Max	Min	Max	Min	Max	Min	Max	Min	Max	Min	Max	Min	Max
P	1-5	Non-Alloyed Steel	-	-	220	480	230	450	200	430	160	380	130	350	120	200	-	-
	6-9	Low-Alloyed Steel	-	-	220	420	180	380	150	350	140	320	130	280	70	200	-	-
	10-11	High-Alloyed Steel	-	-	-	-	60	200	90	180	60	130	70	110	-	-	-	-
M	12-13	Ferritic & Martensitic	-	-	-	-	-	-	-	-	-	-	-	110	220	-	-	
	14	Austenitic Stainless Steel	-	-	-	-	-	-	-	-	-	-	-	50	150	-	-	
K	15-16	Grey Cast Iron	300	450	250	420	120	300	-	-	-	-	-	-	-	-	-	
	17-18	Nodular Cast Iron	120	350	120	300	120	280	-	-	-	-	-	-	-	-	-	
N	21-30	Non-Ferrous Metals (Al)	-	-	-	-	-	-	-	-	-	-	-	-	-	250	1200	
S	31-37	Superalloys & Titanium	-	-	-	-	-	-	-	-	-	-	-	-	-	-	-	
H	38-41	Hard Materials	-	-	-	-	-	-	-	-	-	-	-	-	-	-	-	

Cutting Speed		Vc (m/min.)																
ISO	VDI	Sub Group	YG1010	YG1001	YG3010	YG3015	YG3020	YG3030	YG801	YG211	YG213	YG214	YG401	YG100	YG10			
			Min	Max	Min	Max	Min	Max	Min	Max	Min	Max	Min	Max	Min	Max	Min	Max
P	1-5	Non-Alloyed Steel	-	-	220	480	230	450	200	430	160	380	130	350	120	200	-	-
	6-9	Low-Alloyed Steel	-	-	220	420	180	380	150	350	140	320	130	280	70	200	-	-
	10-11	High-Alloyed Steel	-	-	-	-	60	200	90	180	60	130	70	110	-	-	-	-
M	12-13	Ferritic & Martensitic	-	-	-	-	-	-	-	-	-	-	-	110	220	-	-	
	14	Austenitic Stainless Steel	-	-	-	-	-	-	-	-	-	-	-	50	150	-	-	
K	15-16	Grey Cast Iron	300	450	250	420	120	300	-	-	-	-	-	-	-	-	-	
	17-18	Nodular Cast Iron	120	350	120	300	120	280	-	-	-	-	-	-	-	-	-	
N	21-30	Non-Ferrous Metals (Al)	-	-	-	-	-	-	-	-	-	-	-	-	-	250	1200	
S	31-37	Superalloys & Titanium	-	-	-	-	-	-	-	-	-	-	-	-	-	-	-	
H	38-41	Hard Materials	-	-	-	-	-	-	-	-	-	-	-	-	-	-	-	

Turning Inserts - Positive
VCMT / VCGT (35° Positive)

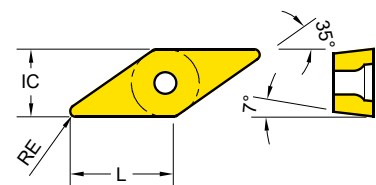

Series	L	IC	S
VC** 1103	10.63	6.350	3.18
VC** 1604	15.80	9.525	4.76

EDP 2200.. ● : Stock item ○ : Order made item

VCMT	Designation	RE	Fn (mm/rev.)	Ap (mm)	K10	P05 K20	P10 K30	P15	P20	P30 M20	P20	M15 S10	M30 S20	M40 S30	S10	N20	N20	
					YG1010	YG1001	YG3010	YG3015	YG3020	YG3030	YG801	YG211	YG213	YG214	YG401	YG100	YG10	
-AL Aluminum	VCMT 110301 -AL	0.1	0.02~0.20	0.2~2.0														● 1041
	VCMT 110302 -AL	0.2	0.02~0.20	0.2~2.0														● 1042
	VCMT 110304 -AL	0.4	0.05~0.25	0.2~3.0														● 1518
	VCMT 160402 -AL	0.2	0.02~0.05	0.5~1.0														● 0418 ● 0417
	VCMT 160404 -AL	0.4	0.05~0.25	0.5~2.0														● 0336 ● 0087
	VCMT 160408 -AL	0.8	0.10~0.35	1.0~3.0														● 0420 ● 0419
-UF Finishing	VCMT 160404 -UF	0.4	0.05~0.25	0.5~2.0			● 0716			● 0421 ● 0955								
	VCMT 160408 -UF	0.8	0.05~0.25	1.0~2.0			● 0557			● 0558								
-UG General	VCMT 160404 -UG	0.4	0.10~0.20	0.3~2.5														● 0060
	VCMT 160408 -UG	0.8	0.15~0.30	0.8~2.5			● 0946		● 0422 ● 0956	● 0061								

Cutting Speed			Vc (m/min.)																				
ISO	VDI	Sub Group	YG1010	YG1001	YG3010	YG3015	YG3020	YG3030	YG801	YG211	YG213	YG214	YG401	YG100	YG10								
			Min	Max	Min	Max	Min	Max	Min	Max	Min	Max	Min	Max	Min	Max	Min	Max	Min	Max	Min	Max	
P	1-5	Non-Alloyed Steel	-	-	220	480	230	450	200	430	160	380	130	350	120	200	-	-	-	-	-	-	
	6-9	Low-Alloyed Steel	-	-	220	420	180	380	150	350	140	320	130	280	70	200	-	-	-	-	-	-	
	10-11	High-Alloyed Steel	-	-	-	-	60	200	90	180	60	130	70	110	-	-	-	-	-	-	-	-	
M	12-13	Ferritic & Martensitic	-	-	-	-	-	-	-	-	-	-	110	220	-	-	170	270	120	180	100	150	
	14	Austenitic Stainless Steel	-	-	-	-	-	-	-	-	-	-	50	150	-	-	150	230	40	160	100	150	
K	15-16	Grey Cast Iron	300	450	250	420	120	300	-	-	-	-	-	-	-	-	-	-	-	-	-	-	
	17-18	Nodular Cast Iron	120	350	120	300	120	280	-	-	-	-	-	-	-	-	-	-	-	-	-	-	
N	21-30	Non-Ferrous Metals (Al)	-	-	-	-	-	-	-	-	-	-	-	-	-	-	-	-	-	250	1200	250	800
S	31-37	Superalloys & Titanium	-	-	-	-	-	-	-	-	-	-	-	-	-	30	100	30	70	30	50	30	90
H	38-41	Hard Materials	-	-	-	-	-	-	-	-	-	-	-	-	-	-	-	-	-	-	-	-	-

Turning - Holder - External
External Holders Overview

Series	Turning Holder
CCGT CCMT	SCACR/L Screw p. 54 SCLCR/L Screw p. 65
CNMA CNMG	PCBNR/L Lever p. 28 PCLNR/L Lever (+Clamp) p. 66 TCLNR/L Hole Clamp p. 66
DCGT DCMT	SDNCN Screw p. 55 SDJCR/L Screw p. 67
DNMA DNMG	TDHNR/L Hole Clamp p. 33 PDNNN Lever (+Clamp) p. 68 TDNNN Hole Clamp p. 68 TDJNR/L Hole Clamp p. 68 PDJNR/L Lever (+Clamp) p. 68
KNUX	CKJNR/L Top Clamp p. 38 p. 69
RCMT	SRGCR/L Screw p. 56 SRDCN Screw p. 70
SCGT SCMT	SSDCN Screw p. 57 SSSCR/L Screw p. 71







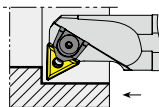
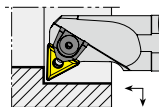
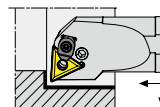
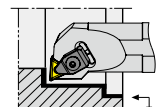

Turning - Holder - External
External Holders Overview

Series	Turning Holder							
SNMA SNMG	PSDNN Lever (+Clamp)	TSDNN Hole Clamp	PSSNR/L Lever (+Clamp)	TSSNR/L Hole Clamp	PSBNR/L Lever (+Clamp)	TSKNR/L Hole Clamp	PSKNR/L Lever (+Clamp)	
p. 39	p. 72	p. 72	p. 72	p. 72	p. 72	p. 72	p. 72	
TCGT TCMT	STFCR/L Screw	STGCR/L Screw	STJCR/L Screw	STUCR/L Screw				
p. 58	p. 73	p. 73	p. 73	p. 73				
TNMA TNMG TNUX	PTTNR/L Lever (+Clamp)	PTFNR/L Lever (+Clamp)	PTGNR/L Lever (+Clamp)	TTGNR/L Hole Clamp	MTJNR/L Pin + Clamp	PTJNR/L Lever (+Clamp)	TTJNR/L Hole Clamp	
p. 43	p. 74	p. 74	p. 74	p. 74	p. 75	p. 75	p. 75	
VBMT	SVHBR/L Screw	SVVBN Screw	SVJBR/L Screw					
p. 59	p. 76	p. 76	p. 76					
VCGT VCMT	SVHCR/L Screw	SVVCN Screw	SVJCR/L Screw					
p. 60	p. 77	p. 77	p. 77					
VNMA VNMG	TVVNN Hole Clamp	TVJNR/L Hole Clamp						
p. 48	p. 78	p. 78						
WNMA WNMG	MWLNR/L Pin + Clamp	PWLNR/L Lever (+Clamp)	TWLNR/L Hole Clamp					
p. 50	p. 79	p. 79	p. 79					

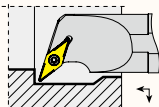
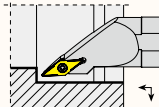
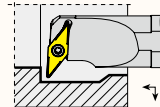
Turning - Holder - Internal
Internal Holders Overview

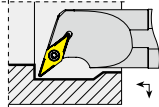
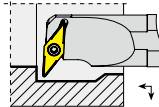
Series	Turning Holder			
CCGT CCMT	..SCFCR/L Screw	..SCLCR/L Screw	E..SCLCR/L Screw	
p. 54	p. 80	p. 81	p. 81	
CNMA CNMG	..PCLNR/L Lever (+Clamp)	..TCLNR/L Hole Clamp		
p. 28	p. 82	p. 82		
DCGT DCMT	..SDQCR/L Screw	..SDUCR/L Screw	E..SDUCR/L Screw	
p. 55	p. 83	p. 84	p. 84	
DNMA DNMG	..PDQNR/L Lever (+Clamp)	..TDQNR/L Hole Clamp	..PDUNR/L Lever (+Clamp)	..TDUNR/L Hole Clamp
p. 33	p. 85	p. 85	p. 85	p. 85
SNMA SNMG	..PSKNR/L Lever (+Clamp)			
p. 39	p. 86			
TCGT TCMT	..STFCR/L Screw	..STUCR/L Screw		
p. 58	p. 87	p. 87		

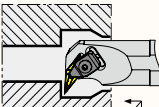
Turning - Holder - Internal
Internal Holders Overview

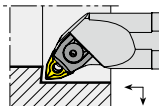
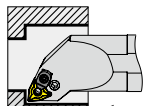
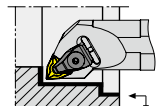
Series	Turning Holder			
 <p>TNMA TNMG TNUX</p>				
	..MTFNR/L Pin + Clamp	..MTUNR/L Pin + Clamp	..PTUNR/L Lever (+Clamp)	..TTUNR/L Hole Clamp
	p. 43	p. 88	p. 88	p. 89
	Unit: mm			
	: p. 54			
 <p>VBMT</p>				
	..SVQBR/L Screw	..SVJBR/L Screw	..SVUBR/L Screw	
	p. 59	p. 90	p. 90	p. 90
	Unit: mm			
 <p>VCGT VCMT</p>				
	..SVQCR/L Screw	..SVUCR/L Screw		
	p. 60	p. 91	p. 91	
 <p>VNMA VNMG</p>				
	..TVUNR/L Hole Clamp			
p. 48	p. 92			
 <p>WNMA WNMG</p>				
	..MWLNR/L Pin + Clamp	..PWLNR/L Lever (+Clamp)	..TWLNR/L Hole Clamp	
	p. 50	p. 93	p. 93	p. 94
	Unit: mm			

Turning - Holder - External
External Holders for CC Insert**

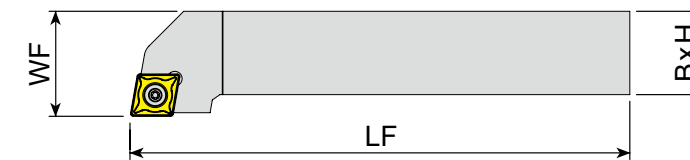

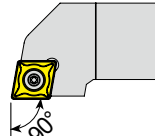
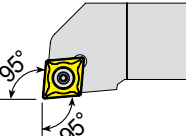
Series	Designation	EDP 2700..		H	B	WF	LF	Insert
		R	L					
 <p>SCACR/L (Screw Type 90°)</p>	SCACR/L 0808E 06	0675	0676	08	08	10	70	CC0602
	SCLCR/L 0808E 06	0689	0690	08	08	10	70	CC0602
	SCLCR/L 1010E 06	0691	-	10	10	12	70	CC0602
 <p>SCLCR/L (Screw Type 95°)</p>	SCLCR/L 1010E 09	0692	0693	10	10	12	70	CC09T3
	SCLCR/L 1212F 09	0089	0090	12	12	16	80	
	SCLCR/L 1616H 09	0091	0092	16	16	20	100	
	SCLCR/L 2020K 09	0093	0094	20	20	25	125	CC1204
	SCLCR/L 2525M 09	0694	0695	25	25	32	150	
	SCLCR/L 1616H 12	0696	-	16	16	20	100	
	SCLCR/L 2020K 12	0095	0096	20	20	25	125	
SCLCR/L 2525M 12	0097	0098	25	25	32	150		

Series	Size	Screw	Shim	Shim Screw	Torx Key
SCACR/L	.06	Y4008-M2.5x6	-	-	Y80-T08
	.06	Y4008-M2.5x6	-	-	Y80-T08
SCLCR/L	.1010..09	Y4015-M3x9	-	-	Y80-T15
	.1212..09	Y4015-M3.5x11	-	-	Y80-T15
	.1616~2525..09	Y4015-M3.5x14	YAACN-2-0001	YAAV-06-M3.5x11	Y80-T15
	.1616..12	Y1020-M5x11	-	-	Y80-T20
	.2020~2525..12	Y1020-M4.5x16	YAACN-2-0003	YAAV-07-M4.5x13	Y80-T20

External Holders for CN Insert**

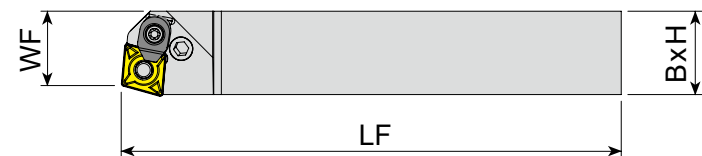

*'C' Letter at Last : Optional Clamp Included

☐: p. 28

Unit:mm

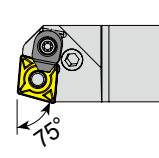
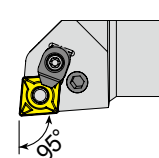
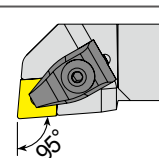
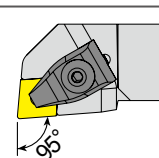
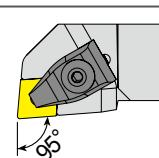
Series	Designation	EDP 2700.. R	L	H	B	WF	LF	Insert	
 PCBNR/L (Lever Type 75°)	PCBNR/L 2525M 16C	0444	0445	25	25	22	150	CN1606	
	PCBNR/L 3232P 16C	0446	0447	32	32	27	170		
	PCBNR/L 3232P 19C	0448	0449	32	32	37	170	CN1906	
	PCBNR/L 4040S 19C	0450	0451	40	40	37	250		
 PCLNR/L (Lever Type 95°)	PCLNR/L 1616H 12	0464	0465	16	16	20	100	CN1204	
	PCLNR/L 2020K 12C	0466	0467	20	20	25	125		
	PCLNR/L 2525M 12C	0468	0469	25	25	32	150		
	PCLNR/L 3232P 12C	0470	0471	32	32	40	170		
	 TCLNR/L (Hole Clamp Type 95°)	PCLNR/L 2525M 16C	0472	0473	25	25	32	150	CN1606
		PCLNR/L 3232P 16C	0474	0475	32	32	40	170	
		PCLNR/L 2525M 19C	0476	0477	25	25	32	150	CN1906
		PCLNR/L 3232P 19C	0478	0479	32	32	40	170	
 TCLNR/L (Hole Clamp Type 95°)		PCLNR/L 4040S 19C	0480	0481	40	40	50	250	CN1906
		TCLNR/L 2020K 12	0482	0483	20	20	25	125	
	TCLNR/L 2525M 12	0484	0485	25	25	32	150	CN1204	
	TCLNR/L 3232P 12	0486	0487	32	32	40	170		
 TCLNR/L (Hole Clamp Type 95°)	TCLNR/L 2525M 16	0492	0493	25	25	32	150	CN1606	
	TCLNR/L 3232P 16	0494	-	32	32	40	170		

Series	Size	Lever	Lever Screw	Clamp	Clamp Screw	Upper Ring	Lower Ring	Shim	Shim Screw	Shim Pin	Allen Key
PCBNR/L	..16C	YAPL-04	YALV-04-M8x22	YACK-09	YAAV-05-M6x15	-	-	YAACN-3-0002	-	YAAV-03	YAAL-03-3
	..19C	YAPL-05	YALV-05-M10x27	YACK-09	YAAV-05-M6x15	-	-	YAACN-3-0003	-	YAAV-04	YAAL-05-4
PCLNR/L	..12	YAPL-02	YALV-03-M8x19	-	-	-	-	YAACN-3-0001	-	YAAV-02	YAAL-03-3
	..2020~3232..12C	YAPL-02	YALV-03-M8x19	YACK-05	Y4015-M4x11	-	-	YAACN-3-0001	-	YAAV-02	YAAL-03-3
	..16C	YAPL-04	YALV-04-M8x22	YACK-09	YAAV-05-M6x15	-	-	YAACN-3-0002	-	YAAV-03	YAAL-03-3
	..19C	YAPL-05	YALV-05-M10x27	YACK-09	YAAV-05-M6x15	-	-	YAACN-3-0003	-	YAAV-04	YAAL-05-4
TCLNR/L	..12	-	-	YATK-02	YAKV-30-M6x22	YABPL-01	YAS-01	YAACN-3-0001	YAAV-02-M5x12	-	YAAL-03-3
	..16	-	-	YATK-04	YAKV-19-M7x25	YABPL-02	-	YAACN-3-0002	YAAV-05-M6x15	-	YAAL-05-4

External Holders for DC Insert**

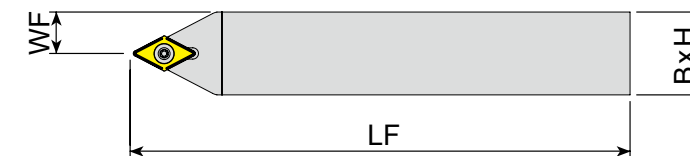

☐: p. 55

Unit:mm

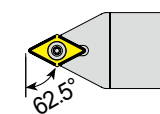
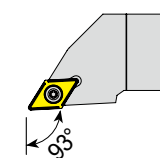
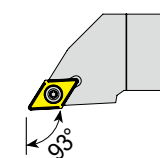
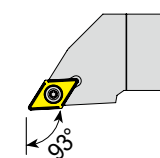
Series	Designation	EDP 2700.. R	L	H	B	WF	LF	Insert	
 SDNCN (Screw Type 62.5°)	SDNCN 0808E 07	0723		08	08	4	70	DC0702	
	SDNCN 1010E 07	0724		10	10	5	70		
	SDNCN 1212F 07	0123		12	12	6	80		
	SDNCN 1616H 07	0725		16	16	8	100		
	 SDJCR/L (Screw Type 93°)	SDNCN 1616H 11	0124		16	16	8	100	DC11T3
		SDNCN 2020K 11	0125		20	20	10	125	
		SDNCN 2525M 11	0126		25	25	12.5	150	
		SDNCN 3232P 11	0726		32	32	16	170	
 SDJCR/L (Screw Type 93°)	SDJCR/L 0808E 07	0713	0714	08	08	10	70	DC0702	
	SDJCR/L 1010E 07	0715	0716	10	10	12	70		
	SDJCR/L 1212F 07	0113	0114	12	12	16	80		
	SDJCR/L 1616H 07	0717	0718	16	16	20	100		
	 SDJCR/L (Screw Type 93°)	SDJCR/L 1616H 11	0117	0118	16	16	20	100	DC11T3
		SDJCR/L 2020K 11	0119	0120	20	20	25	125	
		SDJCR/L 2525M 11	0719	0720	25	25	32	150	
		SDJCR/L 3232P 11	0721	0722	32	32	40	170	

Series	Size	Screw	Shim	Shim Screw	Torx Key
SDNCN	..07	Y4008-M2.5x6	-	-	Y80-T08
	..11	Y4015-M3.5x14	YAADN-2-0001	YAAV-06-M3.5x11	Y80-T15
SDJCR/L	..07	Y4008-M2.5x6	-	-	Y80-T08
	..11	Y4015-M3.5x14	YAADN-2-0001	YAAV-06-M3.5x11	Y80-T15

External Holders for DN Insert**

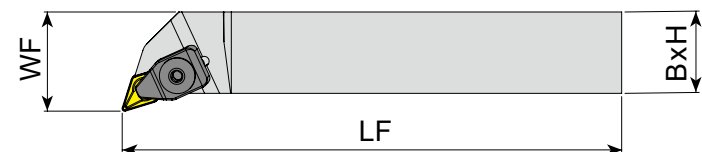

*'C' Letter at Last : Optional Clamp Included

☐: p. 33 Unit:mm

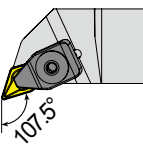
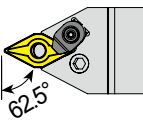
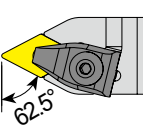
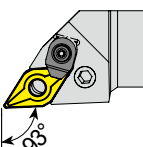
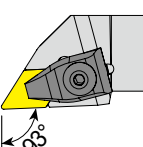
Series	Designation	EDP 2700.. R	L	H	B	WF	LF	Insert
 TDHNR/L (Hole Clamp Type 107.5°)	TDHNR/L 2020K 15	0495	0496	20	20	25	125	DN1506
	TDHNR/L 2525M 15	0497	0498	25	25	32	150	
 PDNNN (Lever Type 62.5°)	PDNNN 2020K 15C	0515		20	20	10	125	DN1506
	PDNNN 2525M 15C	0516		25	25	12.5	150	
	PDNNN 3232P 15C	0517		32	32	16	170	
 TDNNN (Hole Clamp Type 62.5°)	TDNNN 2020K 15	0518		20	20	10	125	DN1506
	TDNNN 2525M 15	0519		25	25	12.5	150	
	TDNNN 3232P 15	0520		32	32	16	170	
 PDJNR/L (Lever Type 93°)	PDJNR/L 2020K 15C	0500	0501	20	20	25	125	DN1506
	PDJNR/L 2525M 15C	0502	0503	25	25	32	150	
	PDJNR/L 3232P 15C	0504	0505	32	32	40	170	
	PDJNR/L 4040S 15C	-	0506	40	40	50	250	
 TDJNR/L (Hole Clamp Type 93°)	TDJNR/L 2020K 15	0507	0508	20	20	25	125	DN1506
	TDJNR/L 2525M 15	0509	0510	25	25	32	150	
	TDJNR/L 3232P 15	0511	0512	32	32	40	170	
	TDJNR/L 4040S 15	0513	0514	40	40	50	250	

Series	Size	Lever	Lever Screw	Clamp	Clamp Screw	Upper Ring	Lower Ring	Shim	Shim Screw	Shim Pin	Allen Key
TDHNR/L	..15	-	-	YATK-02	YAKV-30-M6x22	YABPL-01	YAS-01	YAADN-3-0001	YAAV-02-M5x12	-	YAAL-03-3
PDNNN	..15C	YAPL-03	YALV-03-M8x19	YACK-05	Y4015-M4x11	-	-	YAADN-3-0001	-	YAAY-02	YAAL-03-3
TDNNN	..15	-	-	YATK-02	YAKV-30-M6x22	YABPL-01	YAS-01	YAADN-3-0001	YAAV-02-M5x12	-	YAAL-03-3
PDJNR/L	..15C	YAPL-03	YALV-03-M8x19	YACK-05	Y4015-M4x11	-	-	YAADN-3-0001	-	YAAY-02	YAAL-03-3
TDJNR/L	..15	-	-	YATK-02	YAKV-30-M6x22	YABPL-01	YAS-01	YAADN-3-0001	YAAV-02-M5x12	-	YAAL-03-3

External Holders for KN Insert**

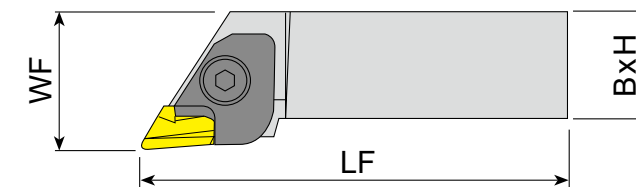

☐: p. 38 Unit:mm

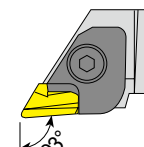
Series	Designation	EDP 2700.. R	L	H	B	WF	LF	Insert
 CKJNR/L (Top Clamp Type 93°)	CKJNR/L 2020K 16	0521	0522	20	20	27.5	125	KNUX1604
	CKJNR/L 2525M 16	0152	0153	25	25	31.5	150	
	CKJNR/L 3232P 16	0154	0155	32	32	40	170	

Series	Size	Clamp	Clamp Screw	Spring	Upper Ring	Shim	Shim Screw	Allen Key
CKJNR	..16	YACK-01-R	YAKV-06-M6x20	YAKY-02	YABPL-01	YAKS-16-R	YAAV-01-M3x10	YAAL-05-4
CKJNL	..16	YACK-01-L	YAKV-06-M6x20	YAKY-02	YABPL-01	YAKS-16-L	YAAV-01-M3x10	YAAL-05-4

External Holders for RC Insert**

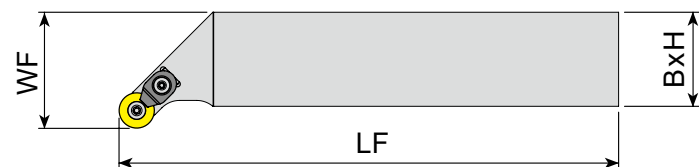

*'C' Letter at Last : Optional Clamp Included

☐: p.56

Unit:mm

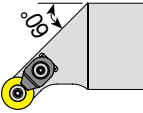
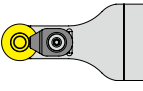
Series	Designation	EDP 2700.. R	L	H	B	WF	LF	Insert
 SRGCR/L (Screw Type 90°)	SRGCR/L 1616H 06	0739	0740	16	16	20	100	RC0602
	SRGCR/L 2020K 06	0741	0742	20	20	25	125	
	SRGCR/L 1616H 08C	0743	0744	16	16	32	100	RC0803
	SRGCR/L 2020K 08C	0745	0746	20	20	25	125	
	SRGCR/L 2525M 08C	0747	0748	25	25	32	150	RC10T3
	SRGCR/L 1616H 10C	0749	0750	16	16	20	100	
	SRGCR/L 2020K 10C	0751	0752	20	20	25	125	RC10T3
	SRGCR/L 2525M 10C	0753	0754	25	25	32	150	
	SRGCR/L 3232P 10C	0755	0756	32	32	40	170	RC1204
	SRGCR/L 2020K 12C	0757	0758	20	20	25	125	
SRGCR/L 2525M 12C	0759	0760	25	25	32	150	RC1204	
SRGCR/L 3232P 12C	0761	0762	32	32	40	170		
 SRDCN (Screw Type 90°)	SRDCN 1616H 06	0162		16	16	8	100	RC0602
	SRDCN 2020K 06	0163		20	20	10	125	
	SRDCN 2525M 06	0164		25	25	12.5	150	RC0803
	SRDCN 1616H 08C	0727		16	16	8	100	
	SRDCN 2020K 08C	0728		20	20	10	125	RC0803
	SRDCN 2525M 08C	0729		25	25	12.5	150	
	SRDCN 1616H 10C	0730		16	16	8	100	RC10T3
	SRDCN 2020K 10C	0731		20	20	10	125	
	SRDCN 2525M 10C	0732		25	25	12.5	150	RC10T3
	SRDCN 3232P 10C	0733		32	32	16	170	
	SRDCN 2020K 12C	0734		20	20	10	125	RC1204
	SRDCN 2525M 12C	0735		25	25	12.5	150	
SRDCN 3232P 12C	0736		32	32	16	170		

Series	Size	Clamp	Clamp Screw	Screw	Torx Key
SRGCR/L	..06	-	-	Y3008-M2.5x6	Y80-T08
	..1616..08C	YACK-15	Y4015-M3.5x11	Y3008-M3x8	Y80-T08
	..10C	YACK-15	Y4015-M3.5x11	Y4015-M3.5x11	Y80-T15
	..12C	YACK-05	Y4015-M4x11	Y4015-M3.5x11	Y80-T15
SRDCN	..06	-	-	Y3008-M2.5x6	Y80-T08
	..08C	YACK-15	Y4015-M3.5x11	Y3008-M3x8	Y80-T08
	..10C	YACK-15	Y4015-M3.5x11	Y4015-M3.5x11	Y80-T15
	..12C	YACK-05	Y4015-M4x11	Y4015-M3.5x11	Y80-T15

External Holders for SC Insert**

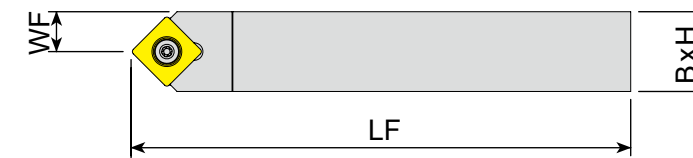

☐: p.57

Unit:mm

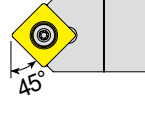
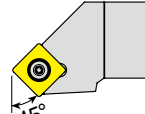
Series	Designation	EDP 2700.. R	L	H	B	WF	LF	Insert
 SSDCN (Screw Type 45°)	SSDCN 1212F 09	0148		12	12	6	80	SC09T3
	SSDCN 1616H 09	0149		16	16	8	100	
	SSDCN 2020K 09	0770		20	20	10	125	SC1204
	SSDCN 1616H 12	0771		16	16	8	100	
	SSDCN 2020K 12	0150		20	20	10	125	SC1204
	SSDCN 2525M 12	0151		25	25	12.5	150	
 SSSCR/L (Screw Type 45°)	SSSCR/L 1212F 09	0772	0773	12	12	16	80	SC09T3
	SSSCR/L 1616H 09	0774	0775	16	16	20	100	
	SSSCR/L 2020K 09	0776	0777	20	20	25	125	SC1204
	SSSCR/L 1616H 12	0778	0779	16	16	20	100	
	SSSCR/L 2020K 12	0780	0781	20	20	25	125	SC1204
	SSSCR/L 2525M 12	0782	0783	25	25	32	150	

Series	Size	Screw	Shim	Shim Screw	Torx Key
SSDCN	..1212..09	Y4015-M3.5x11	-	-	Y80-T15
	..1616~2020..09	Y4015-M3.5x14	YAASN-2-0001	YAAV-06-M3.5x11	Y80-T15
	..1616..12	Y4020-M4.5x12	YAASN-2-0004	YAAV-10-M4.5x8	Y80-T20
	..2020~2525..12	Y1020-M4.5x16	YAASN-2-0004	YAAV-07-M4.5x13	Y80-T20
SSSCR/L	..1212..09	Y4015-M3.5x11	-	-	Y80-T15
	..1616~2020..09	Y4015-M3.5x14	YAASN-2-0001	YAAV-06-M3.5x11	Y80-T15
	..1616..12	Y4020-M4.5x12	YAASN-2-0004	YAAV-10-M4.5x8	Y80-T20
	..2020~2525..12	Y1020-M4.5x16	YAASN-2-0004	YAAV-07-M4.5x13	Y80-T20

External Holders for SN Insert**

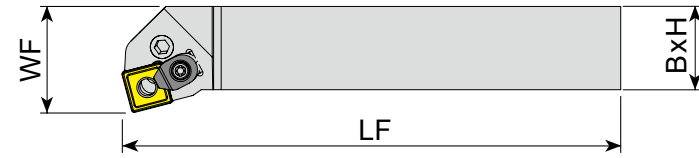

*'C' Letter at Last : Optional Clamp Included

☐: p. 39

Unit:mm

Series	Designation	EDP 2700.. R	L	H	B	WF	LF	Insert
PSDNN (Lever Type 45°)	PSDNN 2020K 12C	0530		20	20	10	125	SN1204
	PSDNN 2525M 12C	0531		25	25	12.5	150	
	PSDNN 3232P 12C	0532		32	32	16	170	
TSDNN (Hole Clamp Type 45°)	TSDNN 1616H 12	0533		16	16	8	100	SN1204
	TSDNN 2020K 12	0534		20	20	10	125	
	TSDNN 2525M 12	0535		25	25	12.5	150	
	TSDNN 3232P 12	0536		32	32	16	170	
PSSNR/L (Lever Type 45°)	PSSNR/L 2020K 12C	0548	0549	20	20	25	125	SN1204
	PSSNR/L 2525M 12C	0550	0551	25	25	32	150	
	PSSNR/L 3232P 12C	0552	0553	32	32	40	170	
TSSNR/L (Hole Clamp Type 45°)	TSSNR/L 2020K 12	0554	0555	20	20	25	125	SN1204
	TSSNR/L 2525M 12	0556	0557	25	25	32	150	
	TSSNR/L 3232P 12	0558	0559	32	32	40	170	
PSBNR/L (Lever Type 75°)	PSBNR/L 2020K 12	0430	0525	20	20	17	125	SN1204
	PSBNR/L 2525M 12C	0526	0527	25	25	22	150	
PSKNR/L (Lever Type 75°)	PSKNR/L 2020K 12C	0537		20	20	25	125	SN1204
	PSKNR/L 2525M 12C	0538	0539	25	25	32	150	
	PSKNR/L 3232P 12C	0540	0541	32	32	40	170	
TSKNR/L (Hole Clamp Type 75°)	TSKNR/L 2020K 12	0542	0543	20	20	25	125	SN1204
	TSKNR/L 2525M 12	0544	0545	25	25	32	150	
	TSKNR/L 3232P 12	0546	0547	32	32	40	170	

Series	Size	Lever	Lever Screw	Clamp	Clamp Screw	Upper Ring	Lower Ring	Shim	Shim Screw	Shim Pin	Allen Key
PSDNN	..12C	YAPL-02	YALV-03-M8x19	YACK-05	Y4015-M4x11	-	-	YAASN-3-0004	-	YAAV-02	YAAL-03-3
TSDNN	..12	-	-	YATK-02	YAKV-30-M6x22	YABPL-01	YAS-01	YAASN-3-0004	YAAV-02-M5x12	-	YAAL-03-3
PSSNR/L	..12C	YAPL-02	YALV-03-M8x19	YACK-05	Y4015-M4x11	-	-	YAASN-3-0004	-	YAAV-02	YAAL-03-3
TSSNR/L	..12	-	-	YATK-02	YAKV-30-M6x22	YABPL-01	YAS-01	YAASN-3-0004	YAAV-02-M5x12	-	YAAL-03-3
PSBNR/L	..12	YAPL-02	YALV-03-M8x19	-	-	-	-	YAASN-3-0004	-	YAAV-02	YAAL-03-3
	..12C	YAPL-02	YALV-03-M8x19	YACK-05	Y4015-M4x11	-	-	YAASN-3-0004	-	YAAV-02	YAAL-03-3
PSKNR/L	..12C	YAPL-02	YALV-03-M8x19	YACK-05	Y4015-M4x11	-	-	YAASN-3-0004	-	YAAV-02	YAAL-03-3
TSKNR/L	..12	-	-	YATK-02	YAKV-30-M6x22	YABPL-01	YAS-01	YAASN-3-0004	YAAV-02-M5x12	-	YAAL-03-3

External Holders for TC Insert**

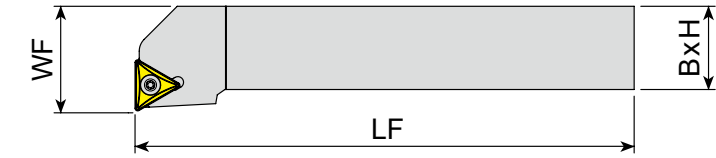

☐: p. 58

Unit:mm

Series	Designation	EDP 2700.. R	L	H	B	WF	LF	Insert
STFCR/L (Screw Type 90°)	STFCR/L 1212F 11	0099	0100	12	12	16	80	TC1102
	STFCR/L 1616H 11	0101	0102	16	16	20	100	
	STFCR/L 1616H 16	0105	0106	16	16	20	100	TC16T3
	STFCR/L 2020K 16	0107	0108	20	20	25	125	
	STFCR/L 2525M 16	0109	0110	25	25	32	150	
STGCR/L (Screw Type 90°)	STGCR/L 1212F 11	0786	0787	12	12	16	80	TC1102
	STGCR/L 1616H 11	0433	0788	16	16	20	100	
	STGCR/L 1616H 16	0789	0790	16	16	20	100	TC16T3
	STGCR/L 2020K 16	0434	0791	20	20	25	125	
	STGCR/L 2525M 16	0792	0793	25	25	32	150	
STJCR/L (Screw Type 93°)	STJCR/L 1212F 11	0796	0797	12	12	16	80	TC1102
	STJCR/L 1616H 11	0798	0799	16	16	20	100	
	STJCR/L 1616H 16	0800	0801	16	16	20	100	TC16T3
	STJCR/L 2020K 16	0802	0803	20	20	25	125	
	STJCR/L 2525M 16	0804	0805	25	25	32	150	
STUCR/L (Screw Type 93°)	STUCR/L 1212F 11	0808	0809	12	12	16	80	TC1102
	STUCR/L 1616H 11	0810	0811	16	16	20	100	
	STUCR/L 2020K 16	0812	0813	20	20	25	125	TC16T3
	STUCR/L 2525M 16	0814	0815	25	25	32	150	
	STUCR/L 3232P 16	0816	0817	32	32	40	170	

Series	Size	Screw	Shim	Shim Screw	Torx Key
STFCR/L	..11	Y4008-M2.5x6	-	-	Y80-T08
	..16	Y4015-M3.5x14	YAATN-2-0001	YAAV-06-M3.5x11	Y80-T15
STGCR/L	..11	Y4008-M2.5x6	-	-	Y80-T08
	..16	Y4015-M3.5x14	YAATN-2-0001	YAAV-06-M3.5x11	Y80-T15
STJCR/L	..11	Y4008-M2.5x6	-	-	Y80-T08
	..16	Y4015-M3.5x14	YAATN-2-0001	YAAV-06-M3.5x11	Y80-T15
STUCR/L	..11	Y4008-M2.5x6	-	-	Y80-T08
	..16	Y4015-M3.5x14	YAATN-2-0001	YAAV-06-M3.5x11	Y80-T15

External Holders for TN Insert**

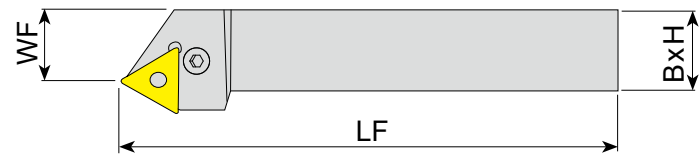

* 'C' Letter at Last : Optional Clamp Included

☐: p.43

Unit:mm

Series	Designation	EDP 2700.. R	L	H	B	WF	LF	Insert
 PTTNR/L (Lever Type 60°)	PTTNR/L 2020K 16	0429	0621	20	20	17	125	TN1604
	PTTNR/L 2525M 16	0622	0623	25	25	21.5	150	
	PTTNR/L 2525M 22C	0626	0627	25	25	20.5	150	TN2204
	PTTNR/L 3232P 22C	0628	0629	32	32	29	170	
 PTFNR/L (Lever Type 90°)	PTFNR/L 1616H 16	0560	0561	16	16	20	100	TN1604
	PTFNR/L 2020K 16	0049	0050	20	20	25	125	
	PTFNR/L 2525M 16	0051	0052	25	25	32	150	
	PTFNR/L 3232P 16	0562	0563	32	32	40	170	
 PTGNR/L (Lever Type 90°)	PTGNR/L 3232P 22C	0566	0567	32	32	40	170	TN2204
	PTGNR/L 1616H 16	0568	0569	16	16	20	100	TN1604
	PTGNR/L 2020K 16	0055	0056	20	20	25	125	
	PTGNR/L 2525M 16	0057	0058	25	25	32	150	
 TTGNR/L (Hole Clamp Type 90°)	PTGNR/L 2525M 22C	0570	0571	25	25	32	150	TN2204
	PTGNR/L 3232P 22C	0572	0573	32	32	40	170	
	TTGNR/L 2020K 16	0574	0575	20	20	25	125	TN1604
	TTGNR/L 2525M 16	0576	0577	25	25	32	150	
 TTGNR/L (Hole Clamp Type 90°)	TTGNR/L 3232P 16	0578	0579	32	32	40	170	TN2204
	TTGNR/L 2525M 22	0580	0581	25	25	32	150	
	TTGNR/L 3232P 22	0582	0583	32	32	40	170	TN2204
	TTGNR/L 4040S 22	0584	-	40	40	50	250	

▶ NEXT PAGE

Series	Size	Lever	Lever Screw	Clamp	Clamp Screw	Upper Ring	Lower Ring	Pin	Shim	Shim Screw	Shim Pin	Allen Key
PTTNR/L	..16	YAPL-01	YALV-02-M6x17	-	-	-	-	-	YAATN-3-0025	-	YAAY-01	YAAL-02-2.5
	..22C	YAPL-02	YALV-03-M8x19	YACK-05	Y4015-M4x11	-	-	-	YAATN-3-0015	-	YAAY-02	YAAL-03-3
PTFNR/L	..16	YAPL-01	YALV-02-M6x17	-	-	-	-	-	YAATN-3-0025	-	YAAY-01	YAAL-02-2.5
	..22C	YAPL-02	YALV-03-M8x19	YACK-05	Y4015-M4x11	-	-	-	YAATN-3-0015	-	YAAY-02	YAAL-03-3
PTGNR/L	..16	YAPL-01	YALV-02-M6x17	-	-	-	-	-	YAATN-3-0025	-	YAAY-01	YAAL-02-2.5
	..22C	YAPL-02	YALV-03-M8x19	YACK-05	Y4015-M4x11	-	-	-	YAATN-3-0015	-	YAAY-02	YAAL-02-2.5
TTGNR/L	..16	-	-	YATK-01	YAKV-01-M5x22	YABPL-01	-	-	YAATN-2-0002	YAAV-03-M5x12	-	YAAL-03-3
	..22	-	-	YATK-02	YAKV-30-M6x22	YABPL-01	YAS-01	-	YAATN-3-0015	YAAV-02-M5x12	-	YAAL-03-3

External Holders for TN Insert**

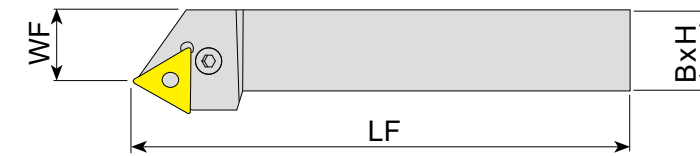

* 'C' Letter at Last : Optional Clamp Included

☐: p.43

Unit:mm

Series	Designation	EDP 2700.. R	L	H	B	WF	LF	Insert
 MTJNR/L (Pin + Top Clamp Type 93°)	MTJNR/L 2020K 16	0585	0586	20	20	25	125	TN1604
	MTJNR/L 2525M 16	0587	0588	25	25	32	150	
	MTJNR/L 3232P 16	0589	0590	32	32	40	170	TN2204
	MTJNR/L 2525M 22	0591	0592	25	25	32	150	
	MTJNR/L 3232P 22	0593	0594	32	32	40	170	
	MTJNR/L 4040S 22	0595	0596	40	40	50	250	
 PTJNR/L (Lever Type 93°)	PTJNR/L 1616H 16	0597	0598	16	16	20	100	TN1604
	PTJNR/L 2020K 16	0599	0600	20	20	25	125	
	PTJNR/L 2525M 16	0601	0602	25	25	32	150	TN2204
	PTJNR/L 3232P 16	0603	0604	32	32	40	170	
	PTJNR/L 2525M 22C	0605	0606	25	25	32	150	
	PTJNR/L 3232P 22C	0607	0608	32	32	40	170	
 TTJNR/L (Hole Clamp Type 93°)	TTJNR/L 2020K 16	0609	0610	20	20	25	125	TN1604
	TTJNR/L 2525M 16	0611	0612	25	25	32	150	
	TTJNR/L 3232P 16	0613	0614	32	32	40	170	TN2204
	TTJNR/L 2525M 22	0615	0616	25	25	32	150	
	TTJNR/L 3232P 22	0617	0618	32	32	40	170	

Series	Size	Lever	Lever Screw	Clamp	Clamp Screw	Upper Ring	Lower Ring	Pin	Shim	Shim Screw	Shim Pin	Allen Key
MTJNR/L	..16	-	-	YAMK-04	YAKV-30-M6x22	YABPL-01	YAS-01	YAPM-01	YAATN-2-0002	-	-	YAAL-03-3
	..22	-	-	YAMK-04	YAKV-30-M6x22	YABPL-01	YAS-01	YAPM-02	YAATN-3-0015	-	-	YAAL-03-3
PTJNR/L	..16	YAPL-01	YALV-02-M6x17	-	-	-	-	-	YAATN-3-0025	-	YAAY-01	YAAL-02-2.5
	..22C	YAPL-02	YALV-03-M8x19	YACK-05	Y4015-M4x11	-	-	-	YAATN-3-0015	-	YAAY-02	YAAL-03-3
TTJNR/L	..16	-	-	YATK-01	YAKV-01-M5x22	YABPL-01	-	-	YAATN-2-0002	YAAV-03-M5x12	-	YAAL-03-3
	..22	-	-	YATK-02	YAKV-30-M6x22	YABPL-01	YAS-01	-	YAATN-3-0015	YAAV-02-M5x12	-	YAAL-03-3

External Holders for VB Insert**

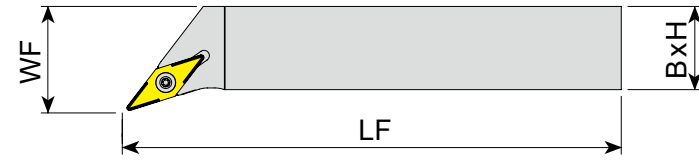

☐: p. 59 Unit:mm

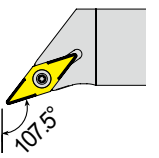
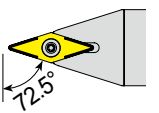
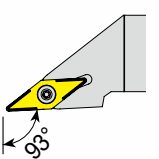
Series	Designation	EDP 2700..		H	B	WF	LF	Insert
		R	L					
 SVHBR/L (Screw Type 107.5°)	SVHBR/L 2020K 16	0818	0819	20	20	25	125	VB1604
	SVHBR/L 2525M 16	0820	0821	25	25	32	150	
	SVHBR/L 3232P 16	0822	0823	32	32	40	170	
 SVVBN (Screw Type 72.5°)	SVVBN 2020K 16	0131		20	20	10	125	VB1604
	SVVBN 2525M 16	0132		25	25	12.5	150	
	SVVBN 3232P 16	0827		32	32	16	170	
 SVJBR/L (Screw Type 93°)	SVJBR/L 1616H 16	0824	0825	16	16	20	100	VB1604
	SVJBR/L 2020K 16	0127	0128	20	20	25	125	
	SVJBR/L 2525M 16	0129	0130	25	25	32	150	
	SVJBR/L 3232P 16	0436	0826	32	32	40	170	

Series	Size	Screw	Shim	Shim Screw	Torx Key
SVHBR/L	..16	Y4015-M3.5x14	YAAVN-2-0002	YAAV-06-M3.5x11	Y80-T15
SVVBN	..16	Y4015-M3.5x14	YAAVN-2-0002	YAAV-06-M3.5x11	Y80-T15
SVJBR/L	..16	Y4015-M3.5x14	YAAVN-2-0002	YAAV-06-M3.5x11	Y80-T15

External Holders for VC Insert**

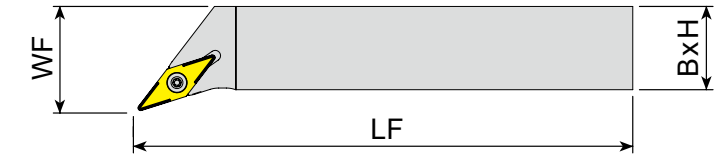

☐: p. 60 Unit:mm

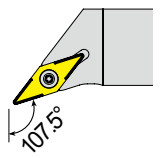
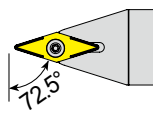
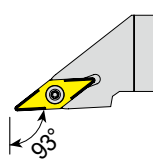
Series	Designation	EDP 2700..		H	B	WF	LF	Insert
		R	L					
 SVHCR/L (Screw Type 107.5°)	SVHCR/L 2020K 16	0828	0829	20	20	25	125	VC1604
	SVHCR/L 2525M 16	0830	0831	25	25	32	150	
	SVHCR/L 3232P 16	0832	0833	32	32	40	170	
 SVVCN (Screw Type 72.5°)	SVVCN 2525M 16	0147		25	25	12.5	150	VC1604
	SVVCN 3232P 16	0838		32	32	16	170	
 SVJCR/L (Screw Type 93°)	SVJCR/L 1212F 16	0834	0835	12	12	16	80	VC1604
	SVJCR/L 2020K 16	0139	0140	20	20	25	125	
	SVJCR/L 2525M 16	0141	0142	25	25	32	150	
	SVJCR/L 3232P 16	0836	0837	32	32	40	170	

Series	Size	Screw	Shim	Shim Screw	Torx Key
SVHCR/L	..16	Y4015-M3.5x14	YAAVN-2-0002	YAAV-06-M3.5x11	Y80-T15
SVVCN	..16	Y4015-M3.5x14	YAAVN-2-0002	YAAV-06-M3.5x11	Y80-T15
SVJCR/L	..1212..16	Y4015-M3.5x11	-	-	Y80-T15
	..2020~3232..16	Y4015-M3.5x14	YAAVN-2-0002	YAAV-06-M3.5x11	Y80-T15

External Holders for VN Insert**

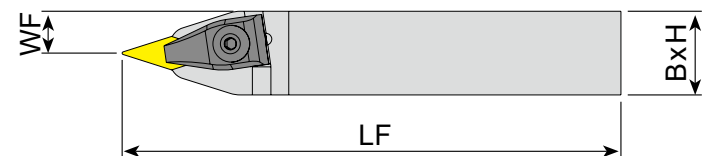

☐: p. 48 Unit:mm

Series	Designation	EDP 2700.. R L	H	B	WF	LF	Insert
 TVNN (Hole Clamp Type 72.5°)	TVVNN 2020K 16	0642	20	20	10	125	VN1604
	TVVNN 2525M 16	0643	25	25	12.5	150	
	TVVNN 3232P 16	0644	32	32	16	170	
 TVJNR/L (Hole Clamp Type 93°)	TVJNR/L 2020K 16	0636 0637	20	20	25	125	VN1604
	TVJNR/L 2525M 16	0638 0639	25	25	32	150	
	TVJNR/L 3232P 16	0640 0641	32	32	40	170	

Series	Size	Clamp	Clamp Screw	Upper Ring	Lower Ring	Shim	Shim Screw	Allen Key
TVVNN	..16	YATK-03	YAKV-30-M6x22	YABPL-01	YAS-01	YAAVN-2-0002	YAAV-04-M5x12	YAAL-03-3
TVJNR/L	..16	YATK-03	YAKV-30-M6x22	YABPL-01	YAS-01	YAAVN-2-0002	YAAV-04-M5x12	YAAL-03-3

External Holders for WN Insert**

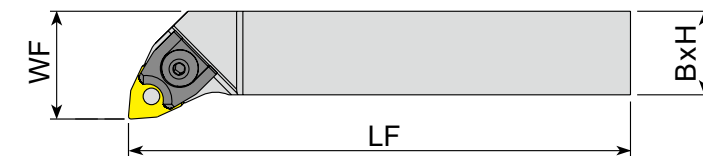

* 'C' Letter at Last : Optional Clamp Included ☐: p. 50 Unit:mm

Series	Designation	EDP 2700.. R L	H	B	WF	LF	Insert	
 MWLNR/L (Pin + Top Clamp Type 95°)	MWLNR/L 1616H 06	0645 0646	16	16	20	100	WN0604	
	MWLNR/L 2020K 06	0021 0022	20	20	25	125		
	MWLNR/L 2525M 06	0023 0024	25	25	32	150		
	MWLNR/L 2020K 08	0025 0026	20	20	25	125		
 PWLNR/L (Lever Type 95°)	MWLNR/L 2525M 08	0027 0028	25	25	32	150	WN0804	
	MWLNR/L 3232P 08	0029 0030	32	32	40	170		
	PWLNR/L 1616H 06	0647 0648	16	16	20	100		WN0604
	PWLNR/L 2020K 06	0649 0650	20	20	25	125		
PWLNR/L 2525M 06	0651 0652	25	25	32	150			
PWLNR/L 1616H 08	0653 0654	16	16	20	100	WN0804		
PWLNR/L 2020K 08C	0655 0656	20	20	25	125			
PWLNR/L 2525M 08C	0657 0658	25	25	32	150			
PWLNR/L 3232P 08C	0659 0660	32	32	40	170			
 TWLNR/L (Hole Clamp Type 95°)	PWLNR/L 1616H 06	0661 0662	16	16	20	100	WN0604	
	TWLNR/L 2020K 06	0663 0664	20	20	25	125		
	TWLNR/L 2525M 06	0665 0666	25	25	32	150		
	TWLNR/L 2020K 08	0667 0668	20	20	25	125		WN0804
	TWLNR/L 2525M 08	0669 0670	25	25	32	150		
	TWLNR/L 3232P 08	0671 0672	32	32	40	170		
TWLNR/L 4040S 08	0673 0674	40	40	50	250			

Series	Size	Lever	Lever Screw	Clamp	Clamp Screw	Upper Ring	Lower Ring	Pin	Shim	Shim Screw	Shim Pin	Allen Key
MWLNR/L	..06	-	-	YAMK-01	YAKV-04-M5x17	-	-	YAPM-08	-	-	-	YAAL-03-3
	..08	-	-	YAMK-05	YAKV-03-M6x22	YABPL-01	YAS-01	YAPM-02	YAAWN-3-0001	-	-	YAAL-03-3
PWLNR/L	..06	YAPL-01	YALV-02-M6x17	-	-	-	-	-	YAAWN-SW317	-	YAAY-01	YAAL-02-2.5
	..08	YAPL-02	YALV-03-M8x19	-	-	-	-	-	YAAWN-3-0001	-	YAAY-02	YAAL-03-3
	..08C	YAPL-02	YALV-03-M8x19	YACK-05	Y4015-M4x11	-	-	-	YAAWN-3-0001	-	YAAY-02	YAAL-03-3
TWLNR/L	..06	-	-	YATK-01	YAKV-01-M5x22	YABPL-01	-	-	YAAWN-SW317	YAAV-01-M3x10	-	YAAL-03-3
	..08	-	-	YATK-02	YAKV-30-M6x22	YABPL-01	YAS-01	-	YAAWN-3-0001	YAAV-02-M5x12	-	YAAL-03-3

Internal Holders for CC Insert**

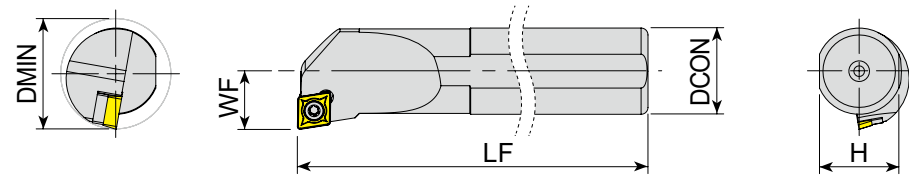

□: p. 54 Unit:mm

Series	Designation	EDP 2700.. R L	DMIN	DCON	H	WF	LF	Insert
	S08H - SCFCR/L 06	1102 1103	11	08	7.3	6	100	CC0602
X	S10K - SCFCR/L 06	1104 1105	13	10	9	7	125	
	S12K - SCFCR/L 06	1106 1107	16	12	11	9	125	
	S12K - SCFCR/L 09	1108 1109	16	12	11	9	125	CC09T3
X	S16P - SCFCR/L 09	1110 1111	20	16	14.8	11	170	
	S20R - SCFCR/L 09	1112 1113	25	20	18.3	13	200	
	S25S - SCFCR/L 09	1114 1115	32	25	23	17	250	CC1204
X	S25S - SCFCR/L 12	1116 -	32	25	23	17	250	

▶ NEXT PAGE

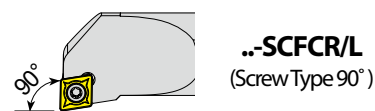

Series	Size	Screw	Shim	Shim Screw	Torx Key
..SCFCR/L	..06	Y4008-M2.5x6	-	-	Y80-T08
	..12..09	Y4015-M3.5x8	-	-	Y80-T15
	..16~20..09	Y4015-M3.5x9	-	-	Y80-T15
	..25..09	Y4015-M3.5x12	YAACN-2-0001	YAAV-08-M3.5x8	Y80-T15
	..12	Y4020-M4.5x12	YAACN-2-0003	YAAV-10-M4.5x8	Y80-T20

Internal Holders for CC Insert**

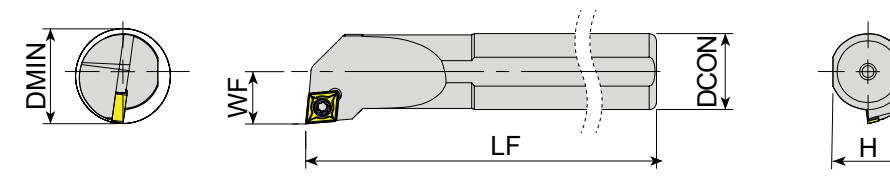

□: p. 54 Unit:mm

Series	Designation	EDP 2700.. R L	DMIN	DCON	H	WF	LF	Insert
	A08H - SCLCR/L 06	1117 1118	11	08	7.3	6	100	CC0602
●	A10H - SCLCR/L 06	1119 1120	13	10	9	7	100	
	A12H - SCLCR/L 06	1121 1122	16	12	11	9	100	
	S08H - SCLCR/L 06	1133 1134	11	08	7.3	6	100	CC0602
X	S10K - SCLCR/L 06	1135 1136	13	10	9	7	125	
	S12K - SCLCR/L 06	1137 1138	16	12	11	9	125	
	S16P - SCLCR/L 06	1139 1140	20	16	14.8	11	170	CC09T3
	A16M - SCLCR/L 09	1123 1124	20	16	14.8	11	150	
●	A20P - SCLCR/L 09	1125 1126	25	20	18.3	13	170	
	A25R - SCLCR/L 09	1127 1128	32	25	23	17	200	CC09T3
	A32S - SCLCR/L 09	1129 1130	40	32	30	22	250	
	S12K - SCLCR/L 09	1141 1142	16	12	11	9	125	
X	S16P - SCLCR/L 09	1474 1143	20	16	14.8	11	170	CC1204
	S20R - SCLCR/L 09	1144 1145	25	20	18.3	13	200	
	S25S - SCLCR/L 09	1146 1147	32	25	23	17	250	
	S32T - SCLCR/L 09	1148 1149	40	32	30	22	300	CC1204
●	A25R - SCLCR/L 12	1131 1132	32	25	23	17	200	
	S25S - SCLCR/L 12	1150 1151	32	25	23	17	250	
X	S32T - SCLCR/L 12	1152 1153	40	32	30	22	300	CC1204
	S40U - SCLCR/L 12	1154 1155	50	40	37.5	27	350	
	E08K - SCLCR/L 06	0325 1156	11	08	7.3	6	125	CC0602
●	E12Q - SCLCR/L 06	1157 1158	16	12	11	9	180	
	E16R - SCLCR/L 09	0329 1159	20	16	14.8	11	200	CC09T3
●	E20S - SCLCR/L 09	1160 1161	24	20	18.3	13	250	

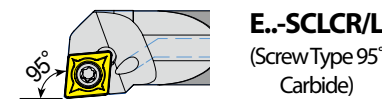
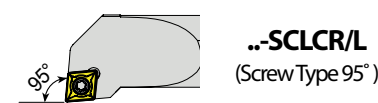

Series	Size	Screw	Shim	Shim Screw	Torx Key
..SCLCR/L	..06	Y4008-M2.5x6	-	-	Y80-T08
	..12..09	Y4015-M3.5x8	-	-	Y80-T15
	..16~20..09	Y4015-M3.5x9	-	-	Y80-T15
	..25~32..09	Y4015-M3.5x12	YAACN-2-0001	YAAV-08-M3.5x8	Y80-T15
	..25~32..12	Y4020-M4.5x12	YAACN-2-0003	YAAV-10-M4.5x8	Y80-T20
	..40..12	Y1020-M4.5x16	YAACN-2-0003	YAAV-07-M4.5x13	Y80-T20
E..SCLCR/L	..06	Y4008-M2.5x6	-	-	Y80-T08
	..09	Y4015-M3.5x9	-	-	Y80-T15

Internal Holders for CN Insert**

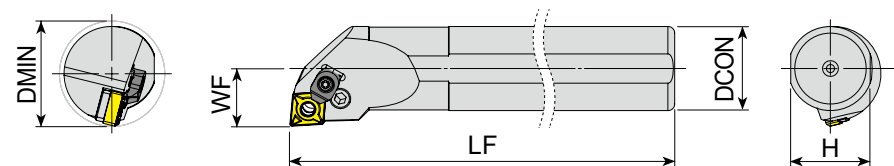

*'C' Letter at Last : Optional Clamp Included

☐ : p. 28

Unit:mm

Series	Designation	EDP 2700.. R L	DMIN	DCON	H	WF	LF	Insert			
●	A25R - PCLNR/L 12C	0839 0840	32	25	23	17	200	CN1204			
	A32S - PCLNR/L 12C	0841 0842	40	32	30	22	250				
	A40T - PCLNR/L 12C	0843 0844	50	40	37.5	27	300				
	A50U - PCLNR/L 12C	0845 0846	63	50	47	35	350				
	S25S - PCLNR/L 12C	0863 0864	32	25	23	17	250				
	X	S32T - PCLNR/L 12C	0865 0866	40	32	30	22		300		
		S40U - PCLNR/L 12C	0867 0868	50	40	37.5	27		350		
		S50V - PCLNR/L 12C	0869 0870	63	50	47	35		400		
		●	A32S - PCLNR/L 16C	0847 0848	40	32	30		22	250	CN1606
			A40T - PCLNR/L 16C	0849 0850	50	40	37.5		27	300	
A50U - PCLNR/L 16C	0851 0852		63	50	47	35	350				
S32T - PCLNR/L 16C	0871 0872		40	32	30	22	300				
X	S40U - PCLNR/L 16C		0873 0874	50	40	37.5	27	350			
	S50V - PCLNR/L 16C	0875 0876	63	50	47	35	400				
	●	A40T - PCLNR/L 19C	0853 0854	50	40	37.5	27	300	CN1906		
A50U - PCLNR/L 19C		0855 0856	63	50	47	35	350				
S40U - PCLNR/L 19C		0877 0878	50	40	37.5	27	350				
X		S50V - PCLNR/L 19C	0879 0880	63	50	47	35	400			
		X	S25S - TCLNR/L 12	0881 0882	32	25	23	17		250	CN1204
S32T - TCLNR/L 12	0883 0884		40	32	30	22	300				
S40U - TCLNR/L 12	0885 0886		50	40	37.5	27	350				
S50V - TCLNR/L 12	0887 0888		63	50	47	35	400				
S32T - TCLNR/L 16	0889 0890		40	32	30	22	300				
X	S40U - TCLNR/L 16	0891 0892	50	40	37.5	27	350	CN1606			
	S50V - TCLNR/L 16	0893 0894	63	50	47	35	400				

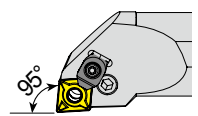

● **..PCLNR/L**
(Lever Type 95°)

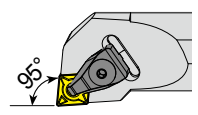

● **..TCLNR/L**
(Hole Clamp Type 95°)

Series	Size	Lever	Lever Screw	Clamp	Clamp Screw	Upper Ring	Lower Ring	Shim	Shim Screw	Shim Pin	Allen Key
..PCLNR/L	..25..12C	YAPL-02	YALV-08-M8x16	YACK-05	Y4015-M4x11	-	-	YAACN-3-0001	-	YAAY-02	YAAL-03-3
	..32~50..12C	YAPL-02	YALV-03-M8x19	YACK-05	Y4015-M4x11	-	-	YAACN-3-0001	-	YAAY-02	YAAL-03-3
	..16C	YAPL-04	YALV-04-M8x22	YACK-09	YAAV-05-M6x15	-	-	YAACN-3-0002	-	YAAY-03	YAAL-03-3
	..19C	YAPL-05	YALV-05-M10x27	YACK-09	YAAV-05-M6x15	-	-	YAACN-3-0003	-	YAAY-04	YAAL-05-4
..TCLNR/L	..25..12	-	-	YATK-02	YAKV-30-M6x22	YABPL-01	YAS-01	YAACN-3-0001	YAAV-13-M5x8	-	YAAL-03-3
	..32~50..12	-	-	YATK-02	YAKV-30-M6x22	YABPL-01	YAS-01	YAACN-3-0001	YAAV-02-M5x12	-	YAAL-03-3
	..16	-	-	YATK-04	YAKV-19-M7x25	YABPL-02	-	YAACN-3-0002	YAAV-05-M6x15	-	YAAL-05-4

Internal Holders for DC Insert**

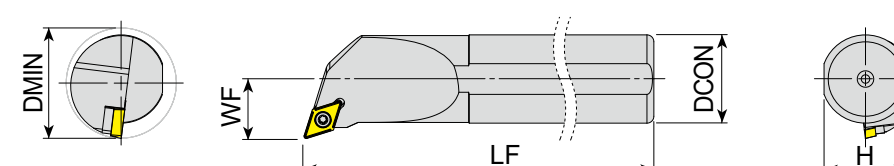

☐ : p. 55

Unit:mm

Series	Designation	EDP 2700.. R L	DMIN	DCON	H	WF	LF	Insert
●	A10H - SDQCR/L 07	1172 1173	13	10	9	7	100	DC0702
	A12H - SDQCR/L 07	1174 1175	16	12	11	9	100	
	A16M - SDQCR/L 07	1176 1177	20	16	14.8	11	150	
	A20P - SDQCR/L 07	1178 1179	25	20	18.3	13	170	
	S10K - SDQCR/L 07	1188 1189	13	10	9	7	125	
X	S12K - SDQCR/L 07	1190 1191	16	12	11	9	125	DC11T3
	S16P - SDQCR/L 07	1192 1193	20	16	14.8	11	170	
	S20R - SDQCR/L 07	1194 1195	25	20	18.3	13	200	
	●	A16M - SDQCR/L 11	1180 1181	20	16	14.8	11	
A20P - SDQCR/L 11		1182 1183	25	20	18.3	13	170	
A25R - SDQCR/L 11		1184 1185	32	25	23	17	200	
A32S - SDQCR/L 11		1186 1187	40	32	30	22	250	
X		S16P - SDQCR/L 11	1196 1197	20	16	14.8	11	170
	S20R - SDQCR/L 11	1198 1199	25	20	18.3	13	200	
	S25S - SDQCR/L 11	1200 1201	32	25	23	17	250	
	S32T - SDQCR/L 11	1202 1203	40	32	30	22	300	
X	S40U - SDQCR/L 11	1204 1205	50	40	37.5	27	350	

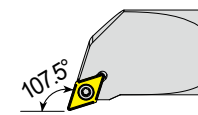

● **..SDQCR/L**
(Screw Type 107.5°)

▶ NEXT PAGE

Series	Size	Screw	Shim	Shim Screw	Torx Key
..SDQCR/L	..07	Y4008-M2.5x6	-	-	Y80-T08
	..16..11	Y4015-M3.5x9	-	-	Y80-T15
	..20..11	Y4015-M3.5x11	-	-	Y80-T15
	..25..11	Y4015-M3.5x12	YAADN-2-0001	YAAV-08-M3.5x8	Y80-T15
	..32..11	Y4015-M3.5x14	YAADN-2-0001	YAAV-06-M3.5x11	Y80-T15

Internal Holders for DC Insert**

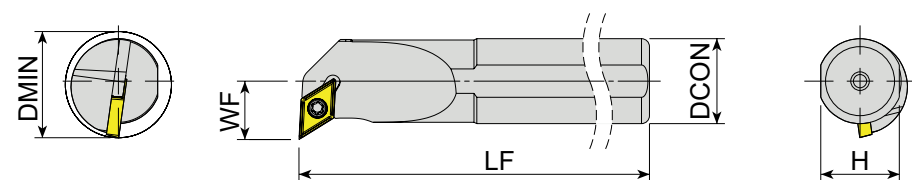

□: p.55 Unit:mm

Series	Designation	EDP 2700.. R L	DMIN	DCON	H	WF	LF	Insert		
●	A10H - SDUCR/L 07	1206 1207	13	10	9	8	100	DC0702		
	A12H - SDUCR/L 07	1208 1209	16	12	11	9	100			
	A16M - SDUCR/L 07	1210 1211	20	16	14.8	11	150			
	A20P - SDUCR/L 07	1212 1213	25	20	18.3	13	170			
	S10K - SDUCR/L 07	1222 1223	13	10	9	8	125			
	X S12K - SDUCR/L 07	1224 1225	16	12	11	9	125			
	S16P - SDUCR/L 07	1226 1227	20	16	14.8	11	170			
	S20R - SDUCR/L 07	1228 1229	25	20	18.3	13	200			
	●	A16M - SDUCR/L 11	1214 1215	20	16	14.8	11		150	DC11T3
		A20P - SDUCR/L 11	1216 1217	25	20	18.3	13		170	
A25R - SDUCR/L 11		1218 1219	32	25	23	17	200			
A32S - SDUCR/L 11		1220 1221	40	32	30	22	250			
S16P - SDUCR/L 11		1230 1231	20	16	14.8	11	170			
S20R - SDUCR/L 11		1232 1233	25	20	18.3	13	200			
X S25S - SDUCR/L 11		1234 1235	32	25	23	17	250			
X S32T - SDUCR/L 11		1236 1237	40	32	30	22	300			
S40U - SDUCR/L 11		1238 1239	50	40	37.5	27	350			
S50V - SDUCR/L 11		- 1240	63	50	47	35	400			
●	E10M - SDUCR/L 07	1241 1242	13	10	9	8	150	DC0702		
	E12Q - SDUCR/L 07	1243 1244	16	12	11	9	180			
	E16R - SDUCR/L 11	0339 1245	20	16	14.8	11	200	DC11T3		
	E20S - SDUCR/L 11	1246 1247	23	20	18.3	12	250			

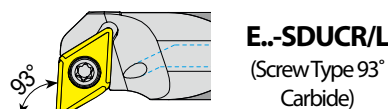
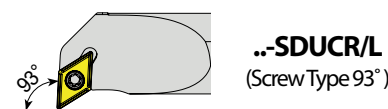

Series	Size	Screw	Shim	Shim Screw	Torx Key
..SDUCR/L	..07	Y4008-M2.5x6	-	-	Y80-T08
	..16..11	Y4015-M3.5x9	-	-	Y80-T15
	..20..11	Y4015-M3.5x11	-	-	Y80-T15
	..25..11	Y4015-M3.5x12	YAADN-2-0001	YAAV-08-M3.5x8	Y80-T15
	..32..11	Y4015-M3.5x14	YAADN-2-0001	YAAV-06-M3.5x11	Y80-T15
E..SDUCR/L	..07	Y4008-M2.5x6	-	-	Y80-T08
	..11	Y4015-M3.5x9	-	-	Y80-T15

Internal Holders for DN Insert**

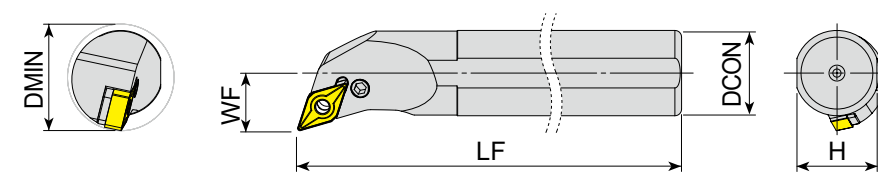

□: p.33 Unit:mm

Series	Designation	EDP 2700.. R L	DMIN	DCON	H	WF	LF	Insert
●	A32S - PDQNR/L 1504	0895 -	40	32	30	22	250	DN1504
	A40T - PDQNR/L 1504	0896 -	50	40	37.5	27	300	
	S32T - PDQNR/L 1504	0903 -	40	32	30	22	300	
	X S40U - PDQNR/L 1504	0904 -	50	40	37.5	27	350	
	S50V - PDQNR/L 1504	0905 -	63	50	47	35	400	
●	A32S - PDQNR/L 15	0897 0898	40	32	30	22	250	DN1506
	A40T - PDQNR/L 15	0899 0900	50	40	37.5	27	300	
	A50U - PDQNR/L 15	0901 0902	63	50	47	35	350	
	X S32T - PDQNR/L 15	0906 0907	40	32	30	22	300	
	X S40U - PDQNR/L 15	0908 0909	50	40	37.5	27	350	
●	S50V - PDQNR/L 15	0910 0911	63	50	47	35	400	DN1506
	S25S - TDQNR/L 15	0912 0913	32	25	23	17	250	
	X S32T - TDQNR/L 15	0914 0915	40	32	30	22	300	
	X S40U - TDQNR/L 15	0916 0917	50	40	37.5	27	350	
	S50V - TDQNR/L 15	0918 0919	63	50	47	35	400	
●	A32S - PDUNR/L 15	0920 0921	40	32	30	22	250	DN1506
	A40T - PDUNR/L 15	0922 0923	50	40	37.5	27	300	
	A50U - PDUNR/L 15	0924 0925	63	50	47	35	350	
	X S25S - PDUNR/L 15	0934 0935	32	25	23	19	250	
	X S32T - PDUNR/L 15	0936 0937	40	32	30	22	300	
●	S40U - PDUNR/L 15	0938 0939	50	40	37.5	27	350	DN1506
	S50V - PDUNR/L 15	0940 0941	63	50	47	35	400	
	S25S - TDUNR/L 15	0942 0943	34	25	23	17	250	
	X S32T - TDUNR/L 15	0944 0945	40	32	30	22	300	
	X S40U - TDUNR/L 15	0946 0947	50	40	37.5	27	350	
●	S50V - TDUNR/L 15	0948 0949	63	50	47	35	400	DN1506

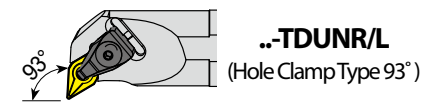
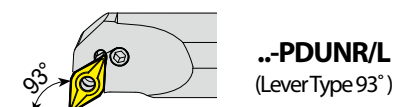
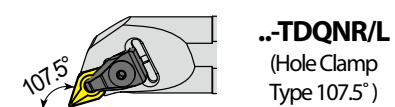
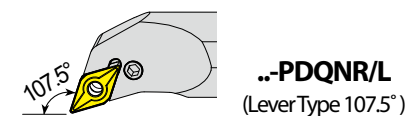

Series	Size	Lever	Lever Screw	Clamp	Clamp Screw	Upper Ring	Lower Ring	Shim	Shim Screw	Shim Pin	Allen Key
..PDQNR/L	..15	YAPL-03	YALV-03-M8x19	-	-	-	-	YAADN-3-0001	-	YAAV-02	YAAL-03-3
	..1504	YAPL-03	YALV-03-M8x19	-	-	-	-	YAADN-2-0003	-	YAAV-02	YAAL-03-3
..TDQNR/L	..25..15	-	-	YATK-02	YAKV-30-M6x22	YABPL-01	-	YAADN-3-0001	YAAV-13-M5x8	-	YAAL-03-3
	..32~50..15	-	-	YATK-02	YAKV-30-M6x22	YABPL-01	YAS-01	YAADN-3-0001	YAAV-02-M5x12	-	YAAL-03-3
..PDUNR/L	..25..15	YAPL-03	YALV-08-M8x16	-	-	-	-	YAADN-3-0001	-	YAAV-02	YAAL-03-3
	..32~50..15	YAPL-03	YALV-03-M8x19	-	-	-	-	YAADN-3-0001	-	YAAV-02	YAAL-03-3
..TDUNR/L	..25..15	-	-	YATK-02	YAKV-30-M6x22	YABPL-01	YAS-01	YAADN-3-0001	YAAV-13-M5x8	-	YAAL-03-3
	..32~50..15	-	-	YATK-02	YAKV-30-M6x22	YABPL-01	YAS-01	YAADN-3-0001	YAAV-02-M5x12	-	YAAL-03-3

Turning - Holder - Internal
Internal Holders for SN Insert**

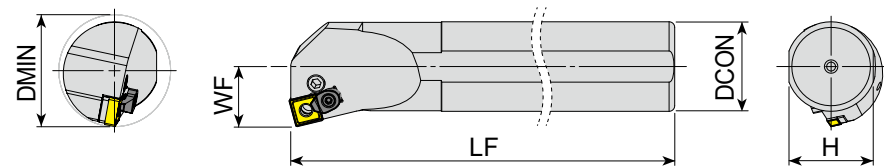

*'C' Letter at Last : Optional Clamp Included

□: p. 39 Unit:mm

Series	Designation	EDP 2700.. R L	DMIN	DCON	H	WF	LF	Insert
X ..-PSKNR/L (Lever Type 75°)	S25S - PSKNR/L 12C	0958 0959	32	25	23	17	250	SN1204
	S32T - PSKNR/L 12C	0960 0961	40	32	30	22	300	

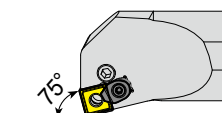

TURNING

PARTING & GROOVING

MILLING

DRILLING

TECHNICAL INFORMATION

Series	Size	Lever	Lever Screw	Clamp	Clamp Screw	Shim	Shim Pin	Allen Key
..-PSKNR/L	..25..12C	YAPL-02	YALV-08-M8x16	YACK-05	Y4015-M4x11	YAASN-3-0004	YAAY-02	YAAL-03-3
	..32..12C	YAPL-02	YALV-03-M8x19	YACK-05	Y4015-M4x11	YAASN-3-0004	YAAY-02	YAAL-03-3

Turning - Holder - Internal
Internal Holders for TC Insert**

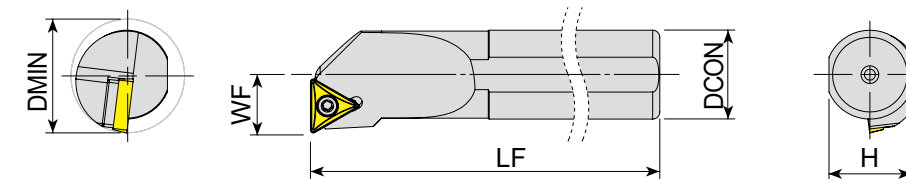

□: p. 58 Unit:mm

Series	Designation	EDP 2700.. R L	DMIN	DCON	H	WF	LF	Insert
X ..-STFCR/L (Screw Type 90°)	S12K - STFCR/L 11	1264 1265	17	12	11	9	125	TC1102
	S16P - STFCR/L 11	1266 1267	20	16	14.8	11	170	
	S20R - STFCR/L 11	1268 1269	25	20	18.3	13	200	
	S16P - STFCR/L 16	1270 1271	20	16	14.8	11	170	
X ..-STUCR/L (Screw Type 93°)	S20R - STFCR/L 16	1272 1273	25	20	18.3	13	200	TC16T3
	S25S - STFCR/L 16	1274 1275	32	25	23	17	250	
	S32T - STFCR/L 16	1276 1277	40	32	30	22	300	
	S40U - STFCR/L 16	1278 -	50	40	37.5	27	350	
X ..-STUCR/L (Screw Type 93°)	S12K - STUCR/L 11	1279 1280	17	12	11	9	125	TC1102
	S16P - STUCR/L 11	1281 1282	20	16	14.8	11	170	
	S20R - STUCR/L 11	1283 1284	25	20	18.3	13	200	TC16T3
	S16P - STUCR/L 16	1285 1286	20	16	14.8	11	170	
	S20R - STUCR/L 16	1287 1288	25	20	18.3	13	200	
	S25S - STUCR/L 16	1289 1290	32	25	23	17	250	
	S32T - STUCR/L 16	1291 1292	40	32	30	22	300	
	S40U - STUCR/L 16	1293 1294	50	40	37.5	27	350	

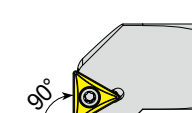
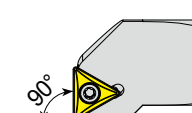

TURNING

PARTING & GROOVING

MILLING

DRILLING

TECHNICAL INFORMATION

Series	Size	Screw	Shim	Shim Screw	Torx Key
..-STFCR/L	..12~20..11	Y4008-M2.5x6	-	-	Y80-T08
	..16..16	Y4015-M3.5x9	-	-	Y80-T15
	..20..16	Y4015-M3.5x11	-	-	Y80-T15
	..25..16	Y4015-M3.5x14	YAATN-2-0001	YAAV-08-M3.5x8	Y80-T15
	..32~40..16	Y4015-M3.5x14	YAATN-2-0001	YAAV-06-M3.5x11	Y80-T15
..-STUCR/L	..11	Y4008-M2.5x6	-	-	Y80-T08
	..16..16	Y4015-M3.5x9	-	-	Y80-T15
	..20..16	Y4015-M3.5x11	-	-	Y80-T15
	..25..16	Y4015-M3.5x14	YAATN-2-0001	YAAV-08-M3.5x8	Y80-T15
	..32~40..16	Y4015-M3.5x14	YAATN-2-0001	YAAV-06-M3.5x11	Y80-T15

Internal Holders for TN Insert**

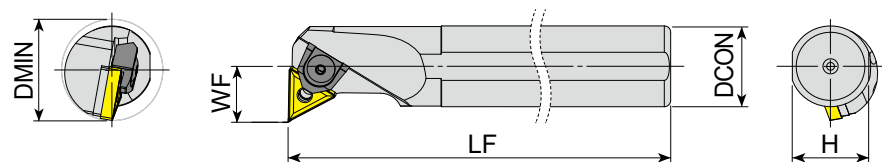

□: p.43 Unit:mm

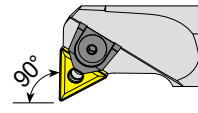
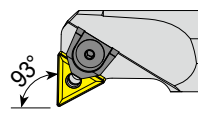
Series	Designation	EDP 2700.. R L	DMIN	DCON	H	WF	LF	Insert
 ..-MTFNR/L (Pin + Top Clamp Type 90°)	X S20R - MTFNR/L 16	0972 -	25	20	18.3	14	200	TN1604
	S25S - MTFNR/L 16	0973 0974	32	25	23	17	250	
	S32T - MTFNR/L 16	0975 0976	40	32	30	22	300	
	S40U - MTFNR/L 16	0977 0978	50	40	37.5	27	350	
	X S32T - MTFNR/L 22	0979 0980	40	32	30	22	300	
 ..-MTUNR/L (Pin + Top Clamp Type 93°)	X S40U - MTFNR/L 22	0981 0982	50	40	37.5	27	350	TN2204
	S50V - MTFNR/L 22	0983 -	63	50	47	35	400	
	S20R - MTUNR/L 16	0998 0999	25	20	18.3	13	200	TN1604
	S25S - MTUNR/L 16	1000 1001	32	25	23	17	250	
	X S32T - MTUNR/L 16	1002 1003	40	32	30	22	300	
S40U - MTUNR/L 16	1004 1005	50	40	37.5	27	350		
S50V - MTUNR/L 16	1006 1007	63	50	47	35	400		

▶ NEXT PAGE

Series	Size	Lever	Lever Screw	Clamp	Clamp Screw	Upper Ring	Lower Ring	Pin	Shim	Shim Screw	Shim Pin	Allen Key
..-MTFNR/L	..20..16	-	-	YAMK-02	YAKV-17-M5x15	-	-	YAPM-03	-	-	-	YAAL-03-3
	..25..16	-	-	YAMK-04	YAKV-30-M6x22	YABPL-01	YAS-01	YAPM-14	YAATN-2-0002	-	-	YAAL-03-3
	..32~40..16	-	-	YAMK-04	YAKV-30-M6x22	YABPL-01	YAS-01	YAPM-01	YAATN-2-0002	-	-	YAAL-03-3
	..22	-	-	YAMK-04	YAKV-30-M6x22	YABPL-01	YAS-01	YAPM-02	YAATN-3-0015	-	-	YAAL-03-3
..-MTUNR/L	..20..16	-	-	YAMK-02	YAKV-17-M5x15	-	-	YAPM-03	-	-	-	YAAL-03-3
	..25..16	-	-	YAMK-04	YAKV-30-M6x22	YABPL-01	YAS-01	YAPM-14	YAATN-2-0002	-	-	YAAL-03-3
	..32~50..16	-	-	YAMK-04	YAKV-30-M6x22	YABPL-01	YAS-01	YAPM-01	YAATN-2-0002	-	-	YAAL-03-3

Internal Holders for TN Insert**

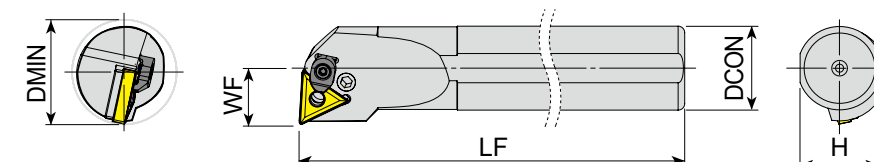

□: p.43 Unit:mm

* 'C' Letter at Last : Optional Clamp Included

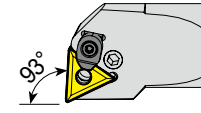
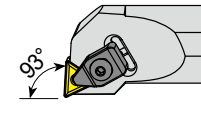
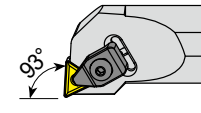
Series	Designation	EDP 2700.. R L	DMIN	DCON	H	WF	LF	Insert
 ..-PTUNR/L (Lever Type 93°)	S16P - PTUNR/L 16	1014 1015	20	16	14.8	11	170	TN1604
	X S20R - PTUNR/L 16	1016 1017	25	20	18.3	13	200	
	X S25S - PTUNR/L 16C	1018 1019	32	25	23	17	250	
	S32T - PTUNR/L 16C	1020 1021	40	32	30	22	300	
	S40U - PTUNR/L 16C	1022 1023	50	40	37.5	27	350	
 ..-TTUNR/L (Hole Clamp Type 93°)	X S32T - PTUNR/L 22C	1024 1025	40	32	30	22	300	TN2204
	X S40U - PTUNR/L 22C	1026 1027	50	40	37.5	27	350	TN2204
	S50V - PTUNR/L 22C	1028 1029	63	50	47	35	400	
	X S25S - TTUNR/L 16	1030 1031	32	25	23	17	250	TN1604
	X S32T - TTUNR/L 16	1032 1033	40	32	30	22	300	TN1604
 ..-TTUNR/L (Hole Clamp Type 93°)	S25S - TTUNR/L 22	1034 1035	32	25	23	17	250	TN2204
	X S32T - TTUNR/L 22	1036 1037	40	32	30	22	300	
	S40U - TTUNR/L 22	1038 1039	50	40	37.5	27	350	
	S50V - TTUNR/L 22	1040 1041	63	50	47	35	400	

Series	Size	Lever	Lever Screw	Clamp	Clamp Screw	Upper Ring	Lower Ring	Pin	Shim	Shim Screw	Shim Pin	Allen Key
..-PTUNR/L	..16..16	YAPL-08	YALV-07-M6x13	-	-	-	-	-	-	-	YAAY-07	YAAL-02-2.5
	..20..16	YAPL-01	YALV-01-M6x14	-	-	-	-	-	YAATN-3-0025	-	YAAY-01	YAAL-02-2.5
	..16C	YAPL-01	YALV-02-M6x17	YACK-05	Y4015-M4x11	-	-	-	YAATN-3-0025	-	YAAY-01	YAAL-02-2.5
	..22C	YAPL-02	YALV-03-M8x19	YACK-05	Y4015-M4x11	-	-	-	YAATN-3-0015	-	YAAY-02	YAAL-03-3
	..-TTUNR/L	..16	-	-	YATK-01	YAKV-01-M5x22	YABPL-01	-	-	YAATN-2-0002	YAAV-03-M5x12	-
..22		-	-	YATK-02	YAKV-30-M6x22	YABPL-01	YAS-01	-	YAATN-3-0015	YAAV-02-M5x12	-	YAAL-03-3

Internal Holders for VB Insert**

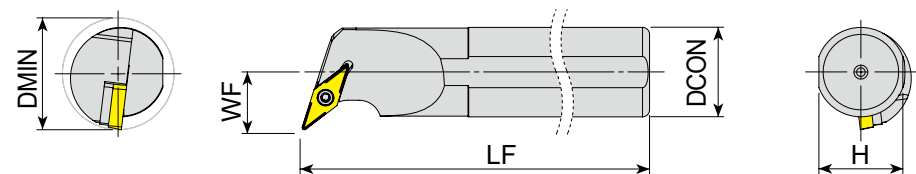

☐: p.59 Unit:mm

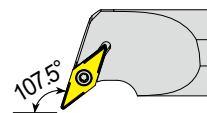
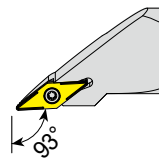
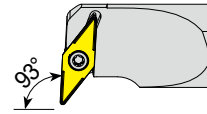
Series	Designation	EDP 2700.. R L	DMIN	DCON	H	WF	LF	Insert
 ..-SVQBR/L (Screw Type 107.5°)	A20Q - SVQBR/L 16	1299 1300	30	20	18.3	20	180	VB1604
	● A25S - SVQBR/L 16	1301 1302	32	25	23	17	250	
	A32S - SVQBR/L 16	1303 1304	40	32	30	22	250	
	S25S - SVQBR/L 16	1305 1306	32	25	23	17	250	
	X S32T - SVQBR/L 16	1307 1308	40	32	30	22	300	
S40U - SVQBR/L 16	1309 1310	50	40	37.5	27	350		
 ..-SVJBR/L (Screw Type 93°)	S25S - SVJBR/L 16	1295 1296	32	25	23	17	250	VB1604
	X S32T - SVJBR/L 16	1297 1298	40	32	30	22	300	
 ..-SVUBR/L (Screw Type 93°)	● A20Q - SVUBR/L 16	1311 -	30	20	18.3	20	180	VB1604
	A32S - SVUBR/L 16	1312 1313	40	32	30	22	250	
	S25S - SVUBR/L 16	1314 1315	32	25	23	19	250	
	X S32T - SVUBR/L 16	1316 1317	40	32	30	22	300	
	S40U - SVUBR/L 16	1318 1319	50	40	37.5	27	350	

Series	Size	Screw	Shim	Shim Screw	Torx Key
..-SVQBR/L	..20..16	Y4015-M3.5x11	-	-	Y80-T15
	A - ..25..16	Y4015-M3.5x14	YAAVN-2-0002	YAAV-06-M3.5x11	Y80-T15
	S - ..25..16	Y4015-M3.5x14	YAAVN-2-0002	YAAV-08-M3.5x8	Y80-T15
	..32~40..16	Y4015-M3.5x14	YAAVN-2-0002	YAAV-06-M3.5x11	Y80-T15
..-SVJBR/L	..16	Y4015-M3.5x12	YAAVN-2-0002	YAAV-08-M3.5x8	Y80-T15
..-SVUBR/L	..20..16	Y4015-M3.5x11	-	-	Y80-T15
	..25~40..16	Y4015-M3.5x14	YAAVN-2-0002	YAAV-06-M3.5x11	Y80-T15

Internal Holders for VC Insert**

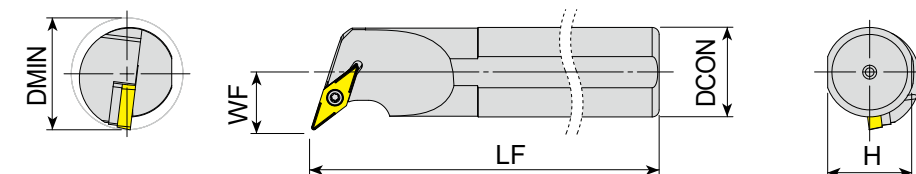

☐: p.60 Unit:mm

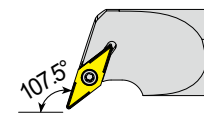
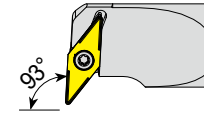
Series	Designation	EDP 2700.. R L	DMIN	DCON	H	WF	LF	Insert
 ..-SVQCR/L (Screw Type 107.5°)	S25S - SVQCR/L 16	1320 1321	32	25	23	17	250	VC1604
	X S32T - SVQCR/L 16	1322 1323	40	32	30	22	300	
	S40U - SVQCR/L 16	1324 1325	50	40	37.5	27	350	
 ..-SVUCR/L (Screw Type 93°)	● A25R - SVUCR/L 16	1326 -	32	25	23	19	200	VC1604
	S25S - SVUCR/L 16	1327 1328	32	25	23	19	250	
	X S32T - SVUCR/L 16	1329 1330	40	32	30	22	300	
	S40U - SVUCR/L 16	1331 1332	50	40	37.5	27	350	

Series	Size	Screw	Shim	Shim Screw	Torx Key
..-SVQCR/L	..25..16	Y4015-M3.5x14	YAAVN-2-0002	YAAV-08-M3.5x8	Y80-T15
	..32~40..16	Y4015-M3.5x14	YAAVN-2-0002	YAAV-06-M3.5x11	Y80-T15
..-SVUCR/L	..16	Y4015-M3.5x14	YAAVN-2-0002	YAAV-06-M3.5x11	Y80-T15

Internal Holders for VN Insert**

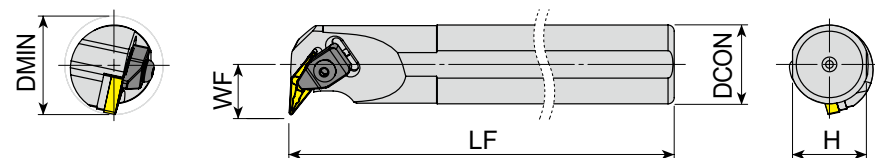

□: p. 48 Unit:mm

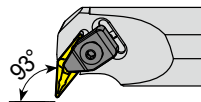
Series	Designation	EDP 2700.. R L	DMIN	DCON	H	WF	LF	Insert
 ..TVUNR/L (Hole Clamp Type 93°) X	S25S - TVUNR/L 16	1042 1043	36	25	23	20	250	VN1604
	S32T - TVUNR/L 16	1044 1045	40	32	30	22	300	
	S40U - TVUNR/L 16	1046 1047	50	40	37.5	27	350	

Series	Size	Clamp	Clamp Screw	Upper Ring	Shim	Shim Screw	Allen Key
..TVUNR/L	..16	YATK-01	YAKV-01-M5x22	YABPL-01	YAAVN-2-0002	YAAV-04-M5x12	YAAL-03-3

Internal Holders for WN Insert**

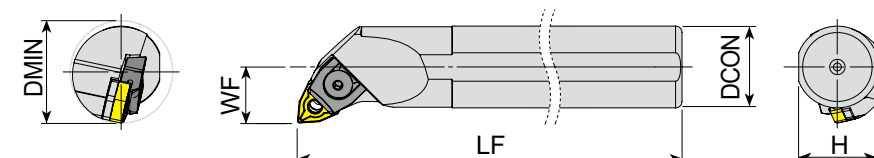

* 'C' Letter at Last : Optional Clamp Included □: p. 50 Unit:mm

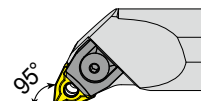
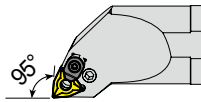
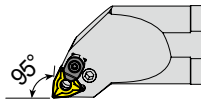
Series	Designation	EDP 2700.. R L	DMIN	DCON	H	WF	LF	Insert
 ..MWLNR/L (Pin + Top Clamp Type 95°) X	S16P - MWLNR/L 06	1064 1065	20	16	14.8	11	170	WN0604
	S20R - MWLNR/L 06	1066 1067	25	20	18.3	13	200	
	S25S - MWLNR/L 06	1068 1069	32	25	23	17	250	
	S32T - MWLNR/L 06	1070 1071	40	32	30	22	300	
 ..PWLNR/L (Lever Type 95°) X	S40U - MWLNR/L 08	1074 1075	50	40	37.5	27	350	WN0804
	A20P - PWLNR/L 06	1048 1049	25	20	18.3	13	170	
	A25R - PWLNR/L 06	1050 1051	32	25	23	17	200	
	A32S - PWLNR/L 06	1052 1053	40	32	30	22	250	
 ..PWLNR/L (Lever Type 95°) ●	S20R - PWLNR/L 06	1076 1077	25	20	18.3	13	200	WN0604
	S25S - PWLNR/L 06	1078 1079	32	25	23	17	250	
	S32T - PWLNR/L 06	1080 1081	40	32	30	22	300	
	A25R - PWLNR/L 08C	1054 1055	32	25	23	17	200	
	A32S - PWLNR/L 08C	1056 1057	40	32	30	22	250	
	A40T - PWLNR/L 08C	1058 1059	50	40	37.5	27	300	
	A50U - PWLNR/L 08C	1060 1061	63	50	47	35	350	
	S25S - PWLNR/L 08C	1082 1083	32	25	23	17	250	
	S32T - PWLNR/L 08C	1084 1085	40	32	30	22	300	
	S40U - PWLNR/L 08C	1086 1087	50	40	37.5	27	350	
S50V - PWLNR/L 08C	1088 1089	63	50	47	35	400		

Series	Size	Lever	Lever Screw	Clamp	Clamp Screw	Upper Ring	Lower Ring	Pin	Shim	Shim Screw	Shim Pin	Allen Key
..MWLNR/L	..16..06	-	-	YAMK-01	YAKV-17-M5x15	-	-	YAPM-09	-	-	-	-
	..20..06	-	-	YAMK-01	YAKV-04-M5x17	-	-	YAPM-10	-	-	-	-
	..25..06	-	-	YAMK-01	YAKV-04-M5x17	-	-	YAPM-08	-	-	-	-
	..25..08	-	-	YAMK-05	YAKV-27-M6x20	YABPL-01	YAS-01	YAPM-04	YAAWN-3-0001	-	-	YAAL-03-3
..PWLNR/L	..32~40..08	-	-	YAMK-05	YAKV-03-M6x22	YABPL-01	YAS-01	YAPM-02	YAAWN-3-0001	-	-	YAAL-03-3
	..20..06	YAPL-01	YALV-01-M6x14	-	-	-	-	-	YAAWN-SW317	-	YAAY-01	YAAL-02-2.5
..PWLNR/L	..25~32..06	YAPL-01	YALV-02-M6x17	-	-	-	-	-	YAAWN-SW317	-	YAAY-01	YAAL-02-2.5
	..08C	YAPL-02	YALV-03-M8x19	YACK-05	Y4015-M4x11	-	-	-	YAAWN-3-0001	-	YAAY-02	YAAL-03-3

Internal Holders for WN Insert**

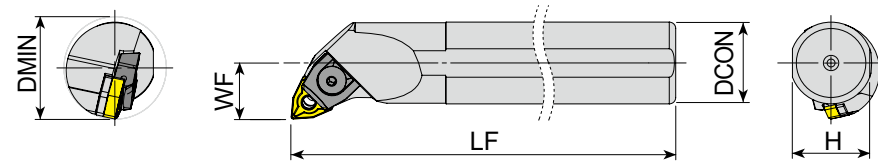

☐: p. 50 Unit:mm

Series	Designation	EDP 2700.. R L	DMIN	DCON	H	WF	LF	Insert
X	S25S - TWLNR/L 06	1090 1091	32	25	23	17	250	WN0604
	S32T - TWLNR/L 06	1092 1093	40	32	30	22	300	
●	A40T - TWLNR/L 08	1062 -	50	40	37.5	27	300	WN0804
	A50U - TWLNR/L 08	1063 -	63	50	47	35	350	
X	S25S - TWLNR/L 08	1094 1095	32	25	23	17	250	WN0804
	S32T - TWLNR/L 08	1096 1097	40	32	30	22	300	
	S40U - TWLNR/L 08	1098 1099	50	40	37.5	27	350	
	S50V - TWLNR/L 08	1100 1101	63	50	47	35	400	

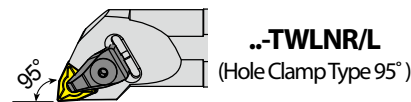

..-TWLNR/L
(Hole Clamp Type 95°)

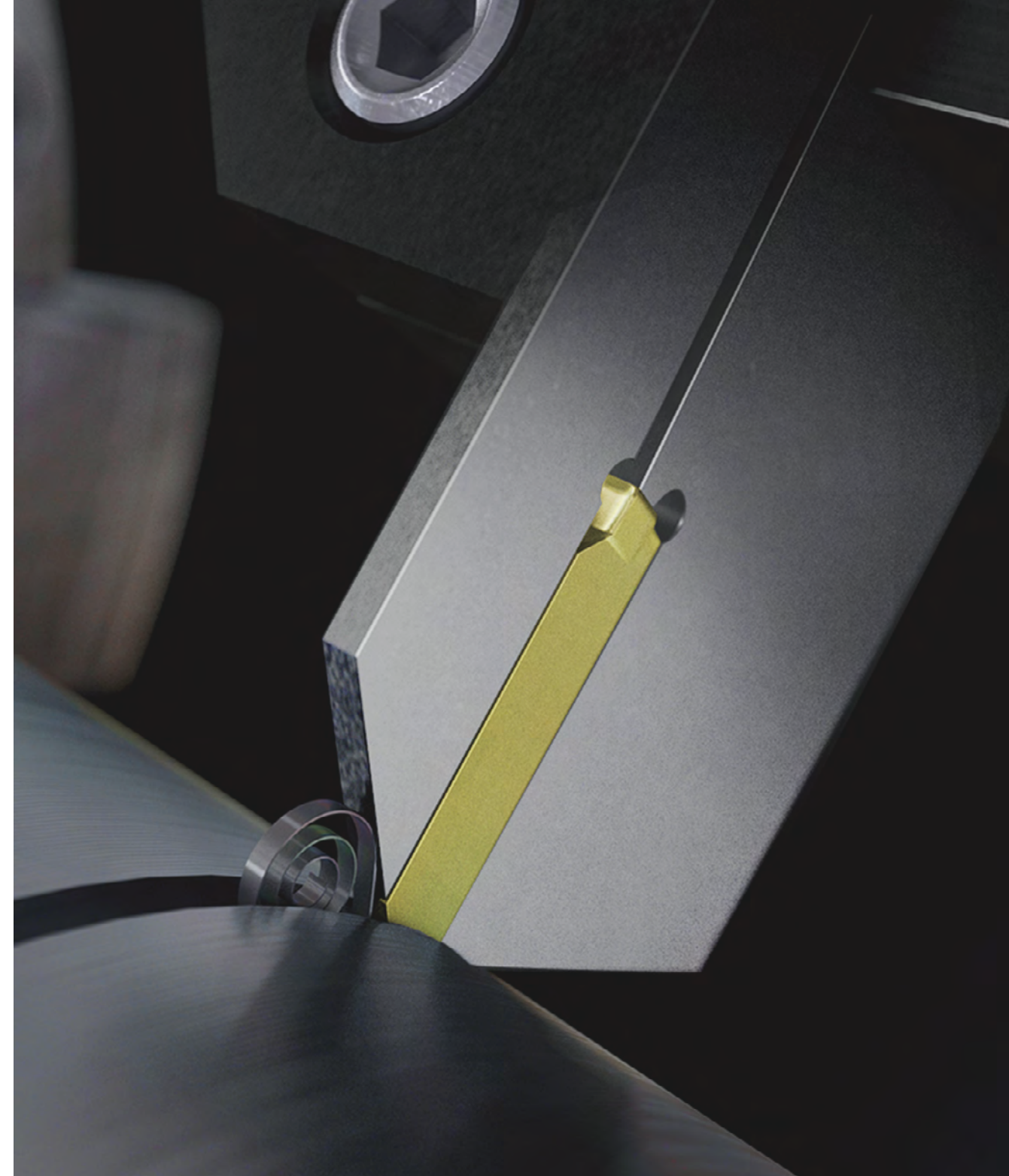

PARTING & GROOVING

Parting & Grooving Holders
Parting & Grooving Inserts Overview
Parting & Grooving Inserts (TD.)

Series	Size	Lever	Lever Screw	Clamp	Clamp Screw	Upper Ring	Lower Ring	Pin	Shim	Shim Screw	Shim Pin	Allen Key
..TWLNR/L	..06	-	-	YATK-01	YAKV-01-M5x22	YABPL-01	-	-	YAAWN-SW317	YAAV-01-M3x10	-	YAAL-03-3
	..25..08	-	-	YATK-02	YAKV-30-M6x22	YABPL-01	YAS-01	-	YAAWN-3-0001	YAAV-13-M5x8	-	YAAL-03-3
	..32~50..08	-	-	YATK-02	YAKV-30-M6x22	YABPL-01	YAS-01	-	YAAWN-3-0001	YAAV-02-M5x12	-	YAAL-03-3

Parting & Grooving - Holder - External
External holders for TD. insert

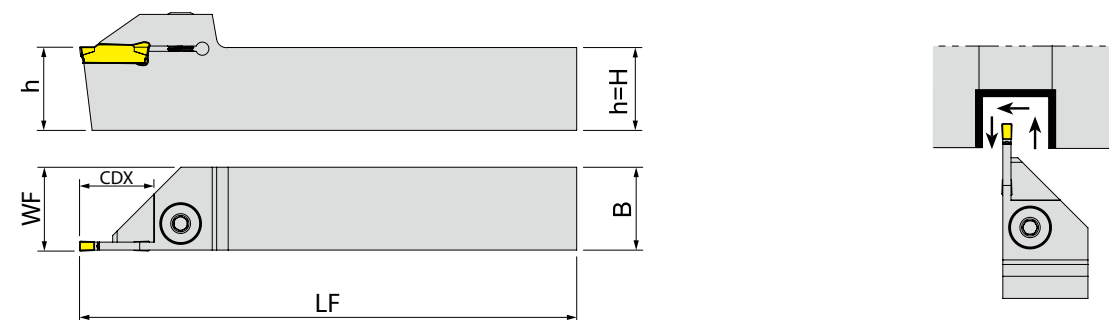

: p. 103 Unit :mm

Designation	EDP 5700.. R	L	CW	CDX	H	B	LF	WF	Insert
YTER/L 1212-2T15	0025	0024	2	15	12	12	100	12.3	TD2..
YTER/L 1616-2T15	0027	0026	2	15	16	16	125	16.3	
YTER/L 2020-2T15	0030	0029	2	15	20	20	125	20.3	
YTER/L 2020-2T20	0032	0031	2	20	20	20	125	20.3	
YTER/L 2020-2T9	0028	-	2	9	20	20	125	20.3	
YTER/L 2525-2T17	0034	0033	2	17	25	25	150	25.3	
YTER/L 1212-3T15	0036	0035	3	15	12	12	100	12.4	TD3..
YTER/L 1616-3T15	0038	0037	3	15	16	16	125	16.4	
YTER/L 2020-3T20	0040	0039	3	20	20	20	125	20.4	
YTER/L 2525-3T20	0044	0043	3	20	25	25	150	25.4	
YTER/L 2525-3T9	0042	0041	3	9	25	25	150	25.4	
YTER/L 3232-3T20	0045	-	3	20	32	32	170	32.4	
YTER/L 2525-4T20	0047	0046	4	20	25	25	150	25.5	TD4..
YTER/L 1212-2T15-C	● 0194	0171	2	15	12	12	100	12.3	TD2..
YTER/L 1616-2T15-C	● 0197	0174	2	15	16	16	125	16.3	
YTER/L 2020-2T15-C	● 0201	0178	2	15	20	20	125	20.3	
YTER/L 2020-2T17-C	● 0202		2	17	20	20	125	20.3	
YTER/L 2020-2T20-C	● 0203	0179	2	20	20	20	125	20.3	
YTER/L 2020-2T09-C	● 0204	0180	2	09	20	20	125	20.3	
YTER/L 2525-2T17-C	● 0208	0184	2	17	25	25	150	25.3	

▶ NEXT PAGE

Series	Size	Screw	Ring	Wrench
YTER/L	..2..	YAKV-02-M6x22	YABPL-01	YAAL-03-3
	..3../..4../..5..	Y2004-M8x1x20	-	YAAL-05-4

Parting & Grooving - Holder - External
External holders for TD. insert

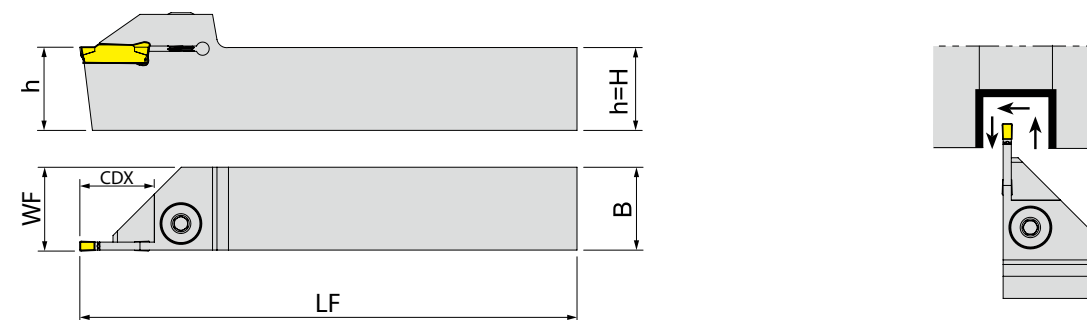

: p. 103 Unit :mm

Designation	EDP 5700.. R	L	CW	CDX	H	B	LF	WF	Insert
YTER/L 1212-3T15-C	● 0196	0173	3	15	12	12	100	12.4	TD3..
YTER/L 1616-3T15-C	● 0199	0176	3	15	16	16	125	16.4	
YTER/L 2020-3T20-C	● 0205	0181	3	20	20	20	125	20.4	
YTER/L 2020-3T25-C	● 0206	0182	3	25	20	20	125	20.4	
YTER/L 2020-3T30-C	● 0207	0183	3	30	20	20	125	20.4	
YTER/L 2525-3T22-C	● 0209	0185	3	22	25	25	150	25.4	
YTER/L 2525-3T25-C	● 0210	0186	3	25	25	25	150	25.4	
YTER/L 2525-3T30-C	● 0211	0187	3	30	25	25	150	25.4	
YTER/L 2525-3T09-C	● 0212	0188	3	09	25	25	150	25.4	
YTER/L 3232-3T25-C	● 0217	0192	3	25	32	32	170	32.4	
YTER/L 2525-4T22-C	● 0213	0189	4	22	25	25	150	25.5	
YTER/L 2525-4T25-C	● 0214		4	25	25	25	150	25.5	
YTER/L 2525-4T30-C	● 0215	0190	4	30	25	25	150	25.5	TD4..
YTER/L 2525-5T25-C	● 0216	0191	5	25	25	25	150	25.5	TD5..

Series	Size	Screw	Ring	Wrench
YTER/L	..2..	YAKV-02-M6x22	YABPL-01	YAAL-03-3
	..3../..4../..5..	Y2004-M8x1x20	-	YAAL-05-4

External holders (Swiss Lathe) for TD. insert

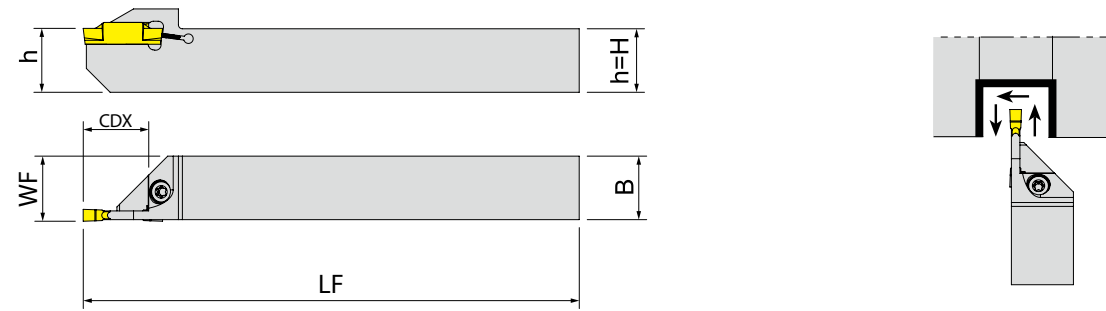

: p. 103 Unit :mm

Designation	EDP 5700.. R	L	CW	CDX	H	B	LF	WF	Insert
YTER/L 1212-2T12-S	0048	-	2	12	12	12	125	12.2	TD.2..
YTER/L 1616-2T16-S	0049	-	2	16	16	16	125	16.2	
YTER/L 1212-3T12-S	0051	0050	3	12	12	12	125	12.3	TD.3..
YTER/L 1616-3T16-S	0053	0052	3	16	16	16	125	16.3	
YTER/L 1212-2T12-S-C	● 0193	0170	2	12	12	12	125	12.2	TD.2..
YTER/L 1616-2T16-S-C	● 0198	0175	2	16	16	16	125	16.2	
YTER/L 1212-3T12-S-C	● 0195	0172	3	12	12	12	125	12.3	TD.3..
YTER/L 1616-3T16-S-C	● 0200	0177	3	16	16	16	125	16.3	

Series	Size	Screw	Wrench
YTER/L	..S	Y4015-M4x11	Y80-T15

Internal holders for TD. insert

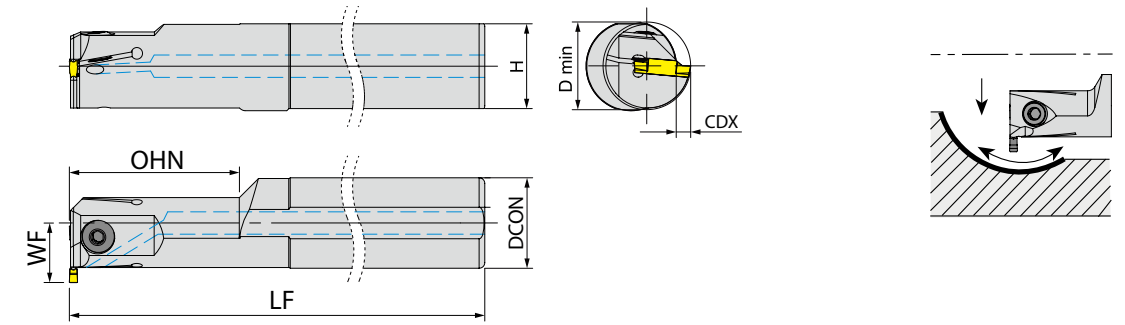

: p. 103 Unit :mm

Designation	EDP 5700.. R	L	CW	DMIN	CDX	DCON	H	OHN	LF	WF	Insert
YTIR/L 16-2T8.5-C	● 0222	0218	2	25	8.5	16	14.8	28	150	16.5	TD.2..
YTIR/L 20-3T06-C	● 0223	0219	3	25	6	20	18.3	40	170	16	
YTIR/L 25-3T06-C	● 0224	0220	3	25	6	25	23	40	200	18.5	TD.3..
YTIR/L 32-3T05-C	● 0225	0221	3	31	5	32	30	60	250	21	

Series	Size	Screw	Wrench
YTIR/L	16-2T..	Y2503-M4x10	YAAL-03-3
	20~25-3T..	Y2504-M5x12	YAAL-05-4
	32-3T..	Y2004-M8x1x20	YAAL-05-4

Parting & Grooving - Holder
Blade for TD. insert

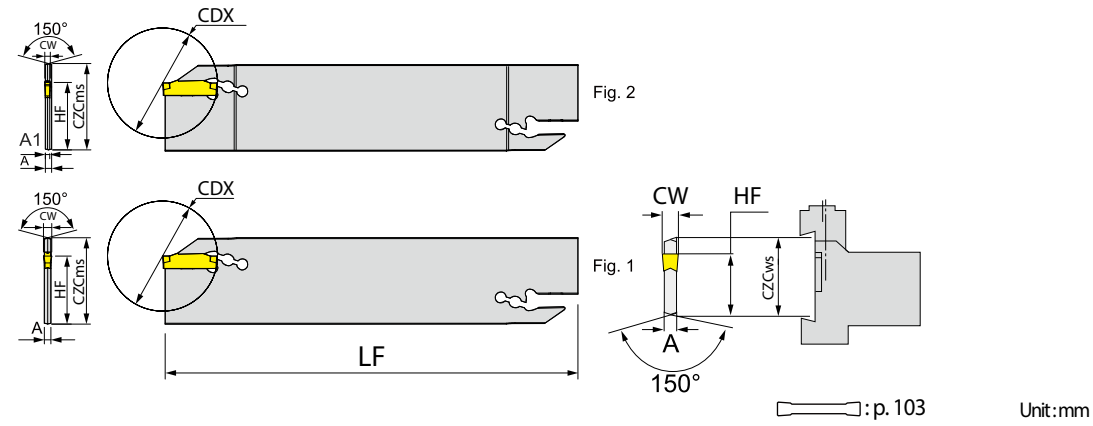

Designation	EDP 5700..	CZCms	CW	CDX	HF	LF	W	Insert
YGB 32-2	0058	32	2	20	25	150	2.4	TD.2..
YGB 32-3	0059	32	3	20	25	150	2.4	TD.3..
YGB 32-2-C	● 0226	32	2	20	25	150	2.4	TD.2..
YGB 32-3-C	● 0227	32	3	20	25	150	2.4	TD.3..

Series	Wrench
YGB ..	YALA-01

Parting & Grooving - Holder
Blade Block for TD. insert

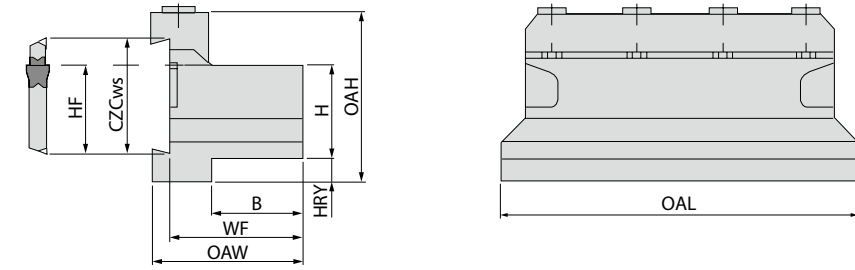

Designation	EDP 5700..	CZCws	H	B	HF	WF	HRY	OAL	OAH	OAW
YGBU 20-32	0060	32	20	19	25	32.7	13	100	50	38
YGBU 25-32	0061	32	25	23	25	36.7	8	110	50	42
YGBU 32-32	0062	32	32	29	25	42.7	5	110	54	48
YGBU 20-32-C	● 0228	32	20	19	25	32.7	13	100	50	38
YGBU 25-32-C	● 0229	32	25	23	25	36.7	8	110	50	42
YGBU 32-32-C	● 0230	32	32	29	25	42.7	5	110	54	48

Series	Size	Clamp	Screw	Wrench
YGBU	20-32	YABK-03	Y2505-M6x30	YAAL-07-5
	25~32-32	YABK-04	Y2505-M6x30	YAAL-07-5

Parting & Grooving Overview

Parting & Groove Turn Grades

Parting and Grooving Grades	P Steel				M Stainless steel				K Cast iron			N Non Ferrous		S Super Alloy	
	P10	P20	P30	P40	M10	M20	M30	M40	K10	K20	K30	N10	N20	S10	S20
PVD	YG602G (YG602)	602G			602G				602G					602G	
	YG603				603										

YG602G (YG602)

P20 - P35 M20 - M40
K20 - K40 S15 - S25

PVD - TiAlN

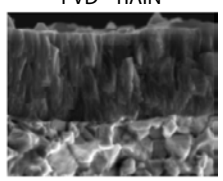

Universal grade for Parting & Groove Turn

- Ultra Dense PVD Coating with optimal thermal resistance & strength
- Sub-Micron substrate designed for demanding application
- YG602G : First Choice for Low Cutting Speed, Soft and Sticky Material with Low Hardness
- YG602 : First Choice for General Application

YG603

M30 - M50

PVD - TiAlN

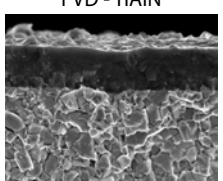







PVD Parting & Grooving Grade for Stainless Steel

- Ultra high toughness substrate and strong adhesion
- Excellent cutting edge strength and chipping resistance
- Stable machinability and tool life for stainless steel

Parting & Grooving Inserts

Inserts	TD. Series	2, 3, 4, 6
		

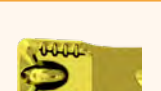
Parting & Grooving Chipbreakers

-P TDP			• Parting & Grooving (Positive)
-N TDN			• Parting & Grooving (General)
-Y TDY			• Turning, Parting & Grooving

Parting & Grooving Inserts

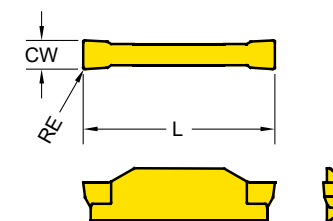

Series	L	CW
TD* 2	20	2
TD* 3	20	3
TD* 4	20	4
TD* 5	20	5

*CDX : Cutting Depth Maximum

EDP 5200.
● : Stock item ○ : Order made item

TD.	Designation	RE	Parting & Grooving		Turning		YG602	YG602G	YG603
			Fn (mm/rev.)	CDX (mm)	Fn (mm/rev.)	Ap (mm)			
-P 	TDP2002	0.2	0.04 ~ 0.12	19	-	-	● 0012	● 0036	● 0078
	TDP3002	0.2	0.05 ~ 0.16	19	-	-	● 0029	● 0030	● 0076
	TDP4003	0.3	0.06 ~ 0.18	19	-	-	● 0023	● 0038	● 0080
	TDPR2002-6	0.2	0.04 ~ 0.12	19	-	-	● 0045		
	TDPR3002-6	0.3	0.05 ~ 0.15	19	-	-	● 0048		
	TDPL2002-6	0.2	0.04 ~ 0.12	19	-	-	● 0046		
-N 	TDPL3002-6	0.3	0.05 ~ 0.15	19	-	-	● 0049		
	TDN2002	0.2	0.04 ~ 0.12	19	-	-	● 0010	● 0035	● 0077
	TDN3002	0.2	0.07 ~ 0.22	19	-	-	● 0024	● 0025	● 0075
	TDN4003	0.3	0.08 ~ 0.25	19	-	-	● 0022	● 0037	● 0079
	TDN5003	0.3	0.09 ~ 0.35	25	-	-	● 0042		
	TDNR2002-6	0.2	0.04 ~ 0.12	19	-	-	● 0043		
-Y 	TDNR3002-6	0.3	0.07 ~ 0.20	19	-	-	● 0040		
	TDNL2002-6	0.2	0.04 ~ 0.12	19	-	-	● 0044		
	TDNL3002-6	0.3	0.07 ~ 0.20	19	-	-	● 0047		
	TDY3E-0.4	0.4	0.10 ~ 0.20	19	0.10 ~ 0.38	0.50 ~ 2.20		● 0027	
	TDY4E-0.4	0.4	0.15 ~ 0.26	19	0.10 ~ 0.40	0.50 ~ 2.80		● 0020	

ISO	Cutting Speed		Vc (m/min.)			
	VDI	Sub Group	YG602G (YG602)		YG603	
			Min.	Max.	Min.	Max.
P	1~5	Non-Alloyed Steel	120	180		
	6~9	Low-Alloyed Steel	100	140		
	10~11	High-Alloyed Steel	80	110		
M	12~13	Ferritic & Martensitic	70	160	50	90
	14	Austenitic Stainless Steel	55	140	40	80
K	15~16	Grey Cast Iron	110	185		
	17~18	Nodular Cast Iron	110	140		
N	21~30	Non-Ferrous Metals (Al)	250	440		
S	31~37	Superalloys & Titanium	25	45		
H	38~41	Hard Materials	25	50		



MILLING

- Product Overview
- Application Guide
- Milling Inserts & Cutter Overview
- Milling Inserts & Cutter

Code Keys - Milling Cutters

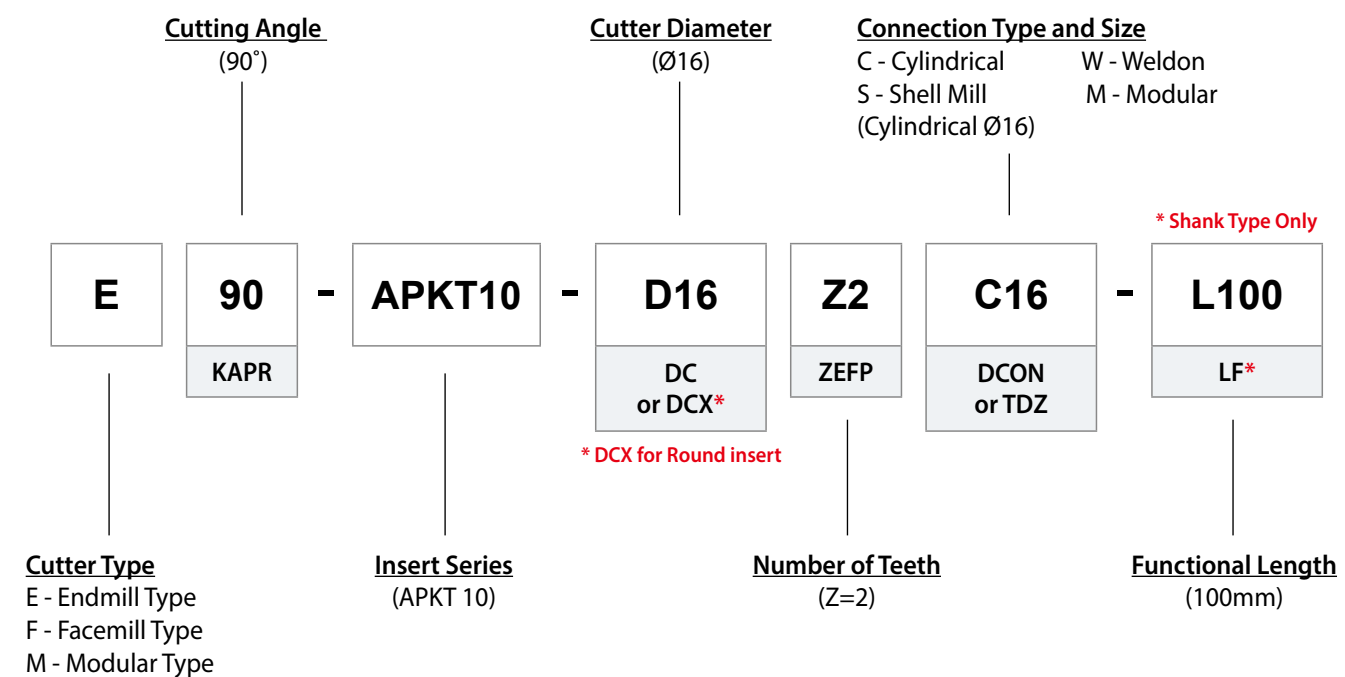
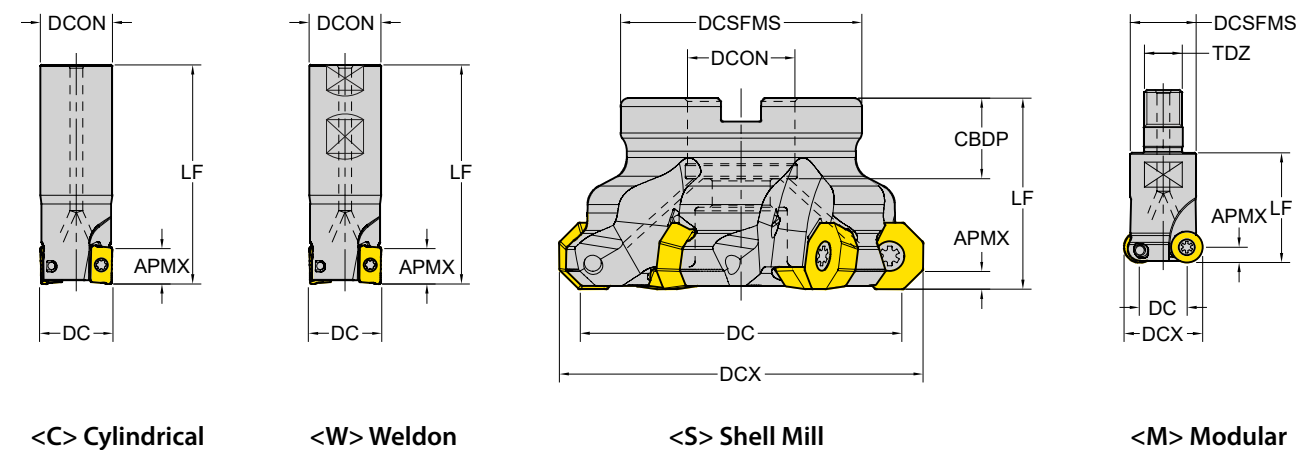

Milling - Code System
Insert ISO Code System

1 A Shape	2 P Relief Angle (AN)	3 K Tolerance	4 T Clamping & Chipbreaker	5 16 Insert Size	6 04 Insert Thickness (S)	7 08 CornerRadius
-------------------------------	---	-----------------------------------	--	--------------------------------------	---	---------------------------------------

1 - Shape

Symbol	Shape	Diagram
H	Hexagonal	
O	Octagonal	
P	Pentagonal	
S	Square	
T	Triangular	
V	Rhombic 35°	
W	Trigon	
L	Rectangular	
A	Parallelogram 80°	
R	.Round	

2 - Relief Angle (AN)

Symbol	Relief Angle (AN)	Diagram
N	No Relief Angle	
B	Relief 5°	
C	Relief 7°	
P	Relief 11°	
D	Relief 15°	
E	Relief 20°	
F	Relief 25°	
O	Special	

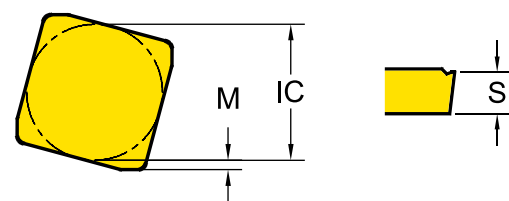

3 - Tolerance Class

Symbol	Inner Grade IC (mm)	Nose Height M (mm)	Thickness S (mm)
C	± 0.025	± 0.013	± 0.025
E	± 0.025	± 0.025	± 0.025
G	± 0.025	± 0.025	± 0.13
H	± 0.013	± 0.013	± 0.025
K*	± 0.05~0.15*	± 0.013	± 0.025
M*	± 0.05~0.15*	± 0.08~0.2*	± 0.13
U*	± 0.08~0.25*	± 0.13~0.38*	± 0.13

*Tolerance is different by insert IC size. Please see ISO 1832

4 - Clamping & Chipbreaker

Symbol	Clamping	Chipbreaker	Figure
N	No clamping hole	X	
R		One Face	
W	Screw Hole	X	
T		One Face	
U		Both Faces	
X		Special	

5 - Insert Size

* No Standard for milling insert size

6 - Insert Thickness

* No Standard for milling insert thickness

Milling - Code System
Insert ISO Code System

8 PDTR Corner Geometry	9 -TR Chipbreaker	10 YG602 Grade
--	---------------------------------------	------------------------------------

7 - Corner Radius (RE)

Symbol	Thickness - S (mm)	Symbol	Thickness - S (mm)
04	0.4	16	1.6
08	0.8	20	2.0
12	1.2	24	2.4

8 - Corner Geometry

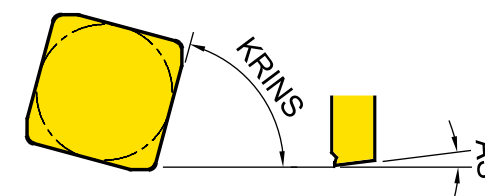

8-1 P Cutting Edge Angle (KRINS)	8-2 D Wiper Edge Clearance (AS)	8-3 T Edge Condition	8-4 R Feed Direction
--	---	--	--

*Refer to page. 109 for -AL, -ST, -TR... types

8-1 - Cutting Edge Angle (KRINS)

Symbol	Cutting Edge Angle (KRINS)
P	90°
A	45°
D	60°
E	75°
F	85°
Z	Special

8-2 - Wiper Edge Clearance (AS)

Symbol	Wiper Edge Clearance (AS)
N	0°
P	11°
D	15°
E	20°
F	25°
Z	Special

8-3 - Edge Condition

Symbol	Edge Condition	Diagram
F	Sharp	
E	Rounded	
T	Chamfered	
S	Chamfered and Rounded	

8-4 - Feed Direction

Symbol	Feed Direction	Diagram
R	Right-hand Insert	
N	Neutral Insert	
L	Left-hand Insert	

Milling Grades and Chipbreakers

Milling Grades

Milling Grades	P Steel					M Stainless steel				K Cast iron				N Non-ferrous				S Superalloys				
	P05	P15	P25	P35	P45	M05	M15	M25	M35	K05	K15	K25	K35	N05	N15	N25	N35	S05	S15	S25	S35	
PVD			602					602				602								602		
			622									622										
		712																				
		713																				
			613					613														
												501										
CVD												5020										
Uncoated															50							

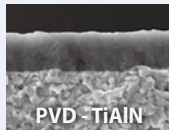
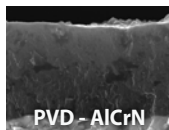
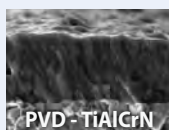
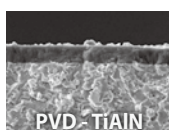
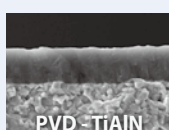

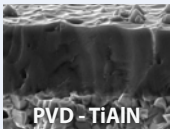
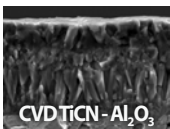
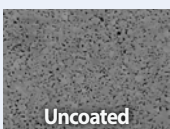

YG602 P20 - P35 M20 - M40 K20 - K40 S15 - S25	 <p>PVD - TiAlN</p>	Universal grade for General Milling Application <ul style="list-style-type: none"> Ultra Dense PVD Coating with optimal thermal resistance & strength Sub-Micron substrate designed for demanding application
YG622 P20 - P40 K20 - K40	 <p>PVD - AlCrN</p>	Optimized Grade for High Alloyed or Prehardened Steel Excellent hot hardness and oxidation resistance at high speed
YG712 P10 - P30	 <p>PVD - TiAlCrN</p>	Milling Grade for Medium of Steel Application <ul style="list-style-type: none"> Superior wear resistance and excellent toughness in high speed machining Coating layer with high hardness and oxidation resistance
YG713 P15 - P25	 <p>PVD - TiAlN</p>	Milling Grade for General Steel Application <ul style="list-style-type: none"> Multi-layer TiAlN structure realizes stronger crater and flank wear resistance Fine-grained carbide and balanced substrate
YG613 P30 - P50 M30 - M40	 <p>PVD - TiAlN</p>	Milling Grade for Stainless Steel Application <ul style="list-style-type: none"> New coating layer with high toughness and lubrication on ultra fine grain substrate with high toughness. The toughest substrates provides excellent cutting performance in stainless steel

Milling Grades and Chipbreakers

Milling Grades





YG501 K05 - K25 H05 - H25	 <p>PVD - TiAlN</p>	Hard Milling grade for Cast Iron <ul style="list-style-type: none"> Substrate especially designed for high wear resistance Excellent wear resistance in cast iron milling application
YG5020 K01 - K30	 <p>CVD TiCN - Al₂O₃</p>	CVD Milling grade for Cast Iron <ul style="list-style-type: none"> CVD coating for Excellent wear resistance Improved Toughness for chipping resistance
YG50 N05 - N20	 <p>Uncoated</p>	Uncoated Milling Grade for Aluminium <ul style="list-style-type: none"> Submicron carbide substrate for high wear resistance Preventing built up edge with shining surface

Milling Chipbreakers

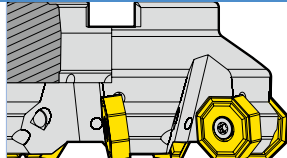
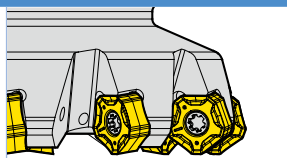
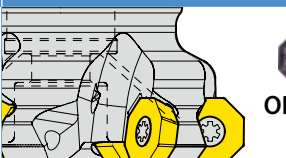
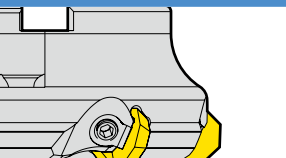
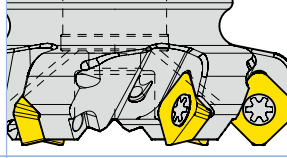

-AL		<ul style="list-style-type: none"> For Aluminum Very Sharp Geometry
-ST		<ul style="list-style-type: none"> For Stainless Steel, Super Alloy Sharp Geometry
General Inserts (No Description)		<ul style="list-style-type: none"> First Choice for General Application
-TR		<ul style="list-style-type: none"> For Hardened Steels Reinforced Geometry
...W / ...N		<ul style="list-style-type: none"> For Hardened Material and Cast Irons

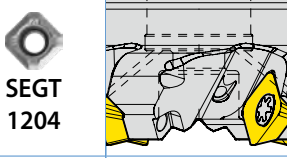
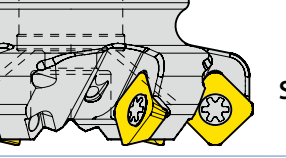
Milling Cutters Overview

Face Milling



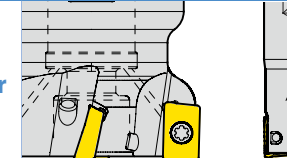
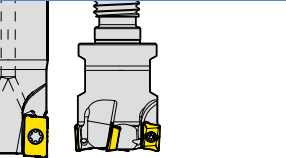

Negative Octagonal		Negative Square		Positive Octagonal		Positive Square		ISO	
Cutter									
APMX	5.5	4	3.5	5	6	6	6	8	8
DC	Ø63~315	Ø50~125	Ø63~125	Ø63~160	Ø40~160	Ø50~160	Ø50~160	Ø50~200	Ø50~200
page	p. 113	p. 116	p. 115	p. 115	p. 117			p. 118	

Shoulder Milling

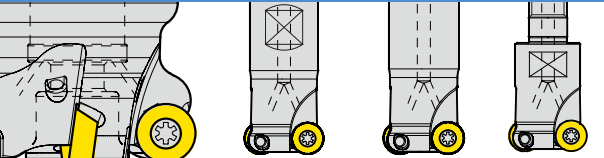
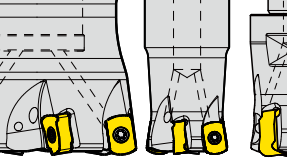

2 Corner Positive		ISO	
Cutter			
APMX	10	16	12
DC	Ø16~100	Ø25~200	Ø50~125
page	p.132-133		p. 136

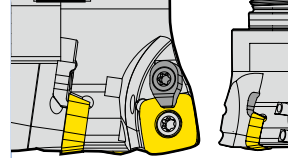
Milling Cutters Overview

Profiling

Round Positive		Negative 4 Corner		Positive 4 Corner	
Cutter					
APMX	0802	0.9	1	1.5	1.8
DCX	4	Ø16~18	Ø20~50	Ø25~125	Ø32~100
page	p. 143	p. 149 - 150			p. 151

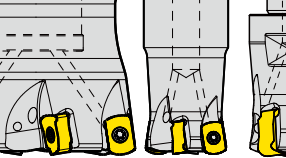
High Feed Milling

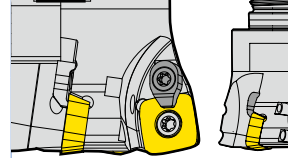
Negative 4 Corner		Positive 4 Corner		
Cutter				
APMX	0.9	1	1.5	
DCX	Ø16~18	Ø20~50	Ø25~125	
page	p. 149 - 150			p. 151

Modular Shank

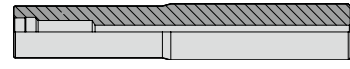
Modular Shank for Modular Head	
Cutter	 M08 ~ M16
page	p. 155

Milling Inserts Overview

A 2 Corner	 Positive	ADKT	ADKT 1505	p. 137
		AOMT	AOMT 1236	p. 137
		APKT	APKT 1003, 1604	p. 138
		APMT	APMT 1135, 1504, 1604	p. 139
		APXT	APXT 1135, 1604	p. 140
E 4 Corner	 Negative	ENMX	ENMX 0604 ENMX 0905	p. 152
O Octagon	 Positive	ODMT / ODMW	ODMT / ODMW 0605	p. 119
		OFER	OFER 0704	p. 120
		OFMT	OFMT 05T3	p. 120
	 Negative	ONMU / ONHU	ONMU / ONHU 0806	p. 121
P 10 Corner	 Negative	PNMU	PNMU1206	p. 122
R Round	 Positive Round	RDKT / RDKW	RDKT 0802, 10T3, 1204, 1604 RDKW 0501, 0702, 0802, 10T3, 1204	p. 145
		RDMT / RDMW	RDMT 0802, 0803, 10T3, 1204 RDMW 0802, 10T3, 1204	p. 146
		RPMT / RPMW	RPMT 08T2, 10T3, 1204 RPMW 1003, 1204	p. 147
		RBEX50	RBEX50	p. 148
	 Positive 3 Corner			
S Square	 High Feed	SDMT / SDMW	SDMT 1204, SDMW 1204	p. 154
	 Positive	SEKT	SEKT 12T3, 1204	p. 125
		SEGT	SEGT12T3, 1204	p. 126
		SEMT	SEMT1204, 13T3	p. 127
		SPMT	SPMT 1204	p. 130
		SDKN, SDCN (45°)	SDKN, SDCN 1203, 1504	p. 123
		SEKN / SEKR (45°)	SEKR, SEKN 1203	p. 124
	 ISO	SPKN / SPKR / SPCN(75°)	SPKN 1203, 1504 SPKR 1203 SPCN 1203, 1504	p. 129
		SPUN	SPUN 1203	p. 131
 Negative	SNMX	SNMX1206	p. 128	
T Triangle	 ISO	TPKN / TPKR / TPCN(90°)	TPKN 1603, 2204 TPKR 1603, 2204 TPCN 2204	p. 141
		TPUN	TPUN 1603	p. 142

Milling - Face Milling - Cutter Cutters for ONMU

Cutting Angle: 45°
16 Corner Negative

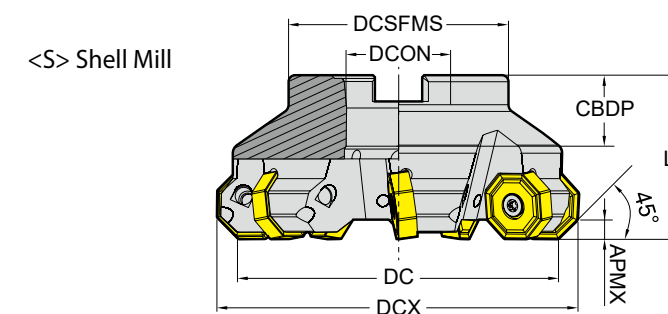

ZEFP : Effective Number of Cutting Edges
CICT : Number of Inserts
CDBP : Connection Bore Depth

□: p. 121 Unit:mm

Series	APMX	Designation	EDP 1700..	DC	DCX	ZEFP	LF	TYPE	DCON	CDBP	DCSFMS	PCD1	PCD2	
ONMU 0806	5.5	F45 - ONMU08 - D63Z5S22	0493	63	75	5	40	Shellmill	22	22	49	-	-	●
		F45 - ONMU08 - D80Z6S27	0494	80	92	6	50		27	25	58	-	-	●
		F45 - ONMU08 - D100Z7S32	0495	100	112	7	50		32	26	67	-	-	●
		F45 - ONMU08 - D125Z8S40 - WOC	0496	125	137	8	63		40	32	87	-	-	X
		F45 - ONMU08 - D160Z10S40 - WOC	0497	160	172	10	63		40	32	107	66.7	-	X
		F45 - ONMU08 - D200Z12S60 - WOC	0498	200	212	12	63		60	40	130	101.6	-	X
		F45 - ONMU08 - D315Z16S60 - WOC	0499	315	327	16	63	60	40	220	101.6	177.8	X	

► ONHU is Available for Wiper Insert

Milling - Face Milling - Cutter
Cutters for SNMX

Cutting Angle : 45°
8 Corner Negative

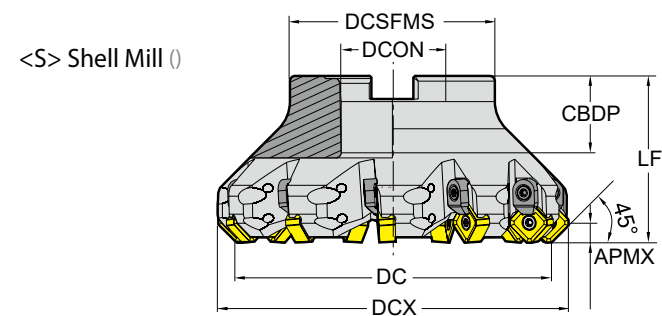

ZEFP : Effective Number of Cutting Edges
CICT : Number of Inserts
CBDP : Connection Bore Depth

□: p. 128 Unit:mm

Series	APMX	Designation	EDP 1700..	DC	DCX	ZEFP	LF	TYPE	DCON	CBDP	DCSFMS	PCD1	PCD2	☉
SNMX 1206	6.0	F45 - SNMX12 - D50Z4S22	0506	50	63	4	42	Shellmill	22	22	42	-	-	●
		F45 - SNMX12 - D50Z5S22	0507	50	63	5	42		22	22	42	-	-	●
		F45 - SNMX12 - D63Z6S22	0508	63	76	6	42		22	22	48	-	-	●
		F45 - SNMX12 - D63Z7S22	0509	63	76	7	42		22	22	48	-	-	●
		F45 - SNMX12 - D80Z7S27	0510	80	93	7	52		27	25	58	-	-	●
		F45 - SNMX12 - D80Z8S27	0511	80	93	8	52		27	25	58	-	-	●
		F45 - SNMX12 - D100Z10S32	0512	100	113	10	52		32	26	67	-	-	●
		F45 - SNMX12 - D100Z8S32	0513	100	113	8	52		32	26	67	-	-	●
		F45 - SNMX12 - D125Z11S40 - WOC	0514	125	138	11	65		40	32	80	-	-	X
		F45 - SNMX12 - D160Z12S40 - WOC	0515	160	173	12	65		40	32	110	66.7	-	X
F45 - SNMX12 - D200Z14S60 - WOC	0516	200	213	14	65	60	40	130	101.6	-	X			

Milling - Face Milling - Cutter
Cutters for OFER

Cutting Angle : 43°
8 Corner Positive

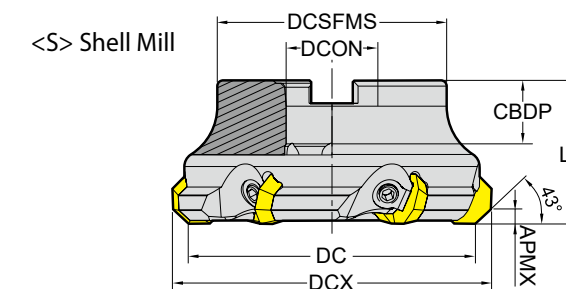

ZEFP : Effective Number of Cutting Edges
CICT : Number of Inserts
CBDP : Connection Bore Depth

□: p. 120 Unit:mm

Series	APMX	Designation	EDP 1700..	DC	DCX	ZEFP	LF	TYPE	DCON	CBDP	DCSFMS	PCD1	PCD2	☉
OFER 0704	5.0	F43 - OFER07 - D63Z4S22 - WOC	0484	63	75	4	45	Shellmill	22	22	48	-	-	X
		F43 - OFER07 - D80Z5S27 - WOC	0485	80	92	5	50		27	25	58	-	-	X
		F43 - OFER07 - D100Z6S32 - WOC	0486	100	112	6	50		32	26	80	-	-	X
		F43 - OFER07 - D125Z8S40 - WOC	0487	125	137	8	63		40	32	85	-	-	X
		F43 - OFER07 - D160Z9S40 - WOC	0488	160	172	9	63		40	32	110	66.7	-	X

Milling - Face Milling - Cutter
Cutters for ODMT, ODMW

Cutting Angle : 43°
8 Corner Positive

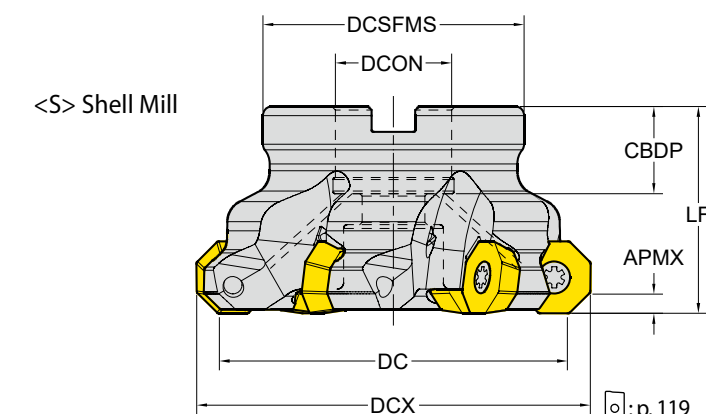

ZEFP : Effective Number of Cutting Edges
CICT : Number of Inserts
CBDP : Connection Bore Depth

□: p. 119 Unit:mm

Series	APMX	Designation	EDP 1700..	DC	DCX	ZEFP	LF	TYPE	DCON	CBDP	DCSFMS	PCD1	PCD2	☉
ODMT ODMW 0605	3.5	F43 - ODMT06 - D63Z5S22	0001	63	73	5	40	Shellmill	22	20	50	-	-	●
		F43 - ODMT06 - D80Z6S27	0002	80	90	6	50		27	23	56	-	-	●
		F43 - ODMT06 - D100Z7S32	0003	100	110	7	50		32	26	78	-	-	●
		F43 - ODMT06 - D125Z8S40	0004	125	135	8	63		40	28	89	-	-	●

Milling - Face Milling - Cutter
Cutters for PNMU

Cutting Angle : 36°
10 Corner Negative

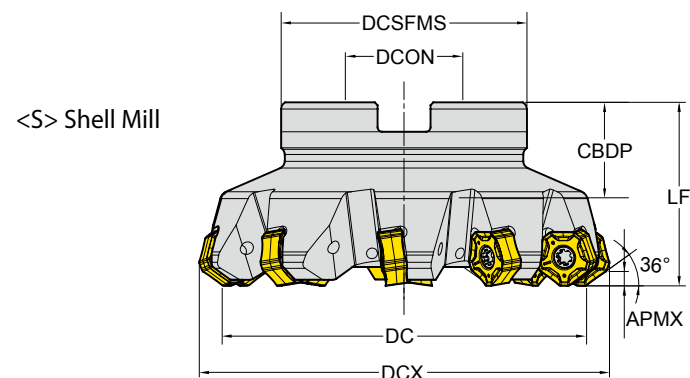

ZAFP : Effective Number of Cutting Edges
CICT : Number of Inserts
CBDP : Connection Bore Depth

□ : p. 122 Unit:mm

Series	APMX	Designation	EDP 1700..	DC	DCX	ZAFP	LF	TYPE	DCON	CBDP	DCSFMS	PCD1	PCD2	☉
PNMU 1206	4.0	F36-PNMU12-D50Z4S22	0774	50	83.6	4	40	Shell Mill	22	20	42	-	-	●
		F36-PNMU12-D50Z5S22	0785	50	83.6	5	40		22	20	42	-	-	●
		F36-PNMU12-D63Z5S22	0775	63	96.6	5	40		22	20	48	-	-	●
		F36-PNMU12-D63Z6S22	0483	63	96.6	6	40		22	20	48	-	-	●
		F36-PNMU12-D80Z8S27	0466	80	113.6	8	50		27	23	58	-	-	●
		F36-PNMU12-D100Z10S32	0467	100	133.6	10	50		32	26	67	-	-	●
		F36-PNMU12-D125Z10S40	0786	125	158.6	10	63		40	29	89	-	-	●

Milling - Face Milling - Cutter
Cutters for SEKT, SEGT

Cutting Angle : 45°
4 Corner Positive

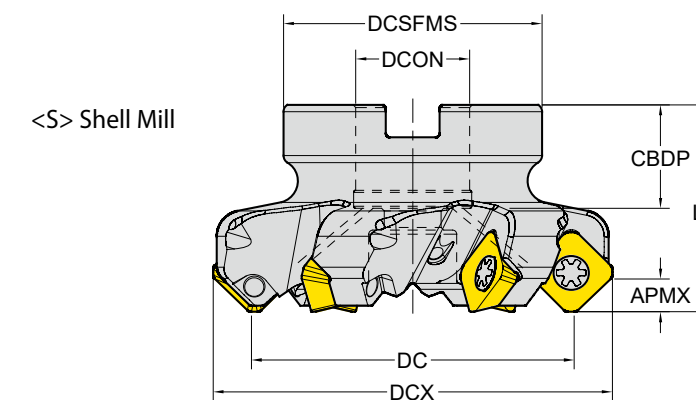

ZAFP : Effective Number of Cutting Edges
CICT : Number of Inserts
CBDP : Connection Bore Depth

□ : p. 125/126 Unit:mm

Series	APMX	Designation	EDP 1700..	DC	DCX	ZAFP	LF	TYPE	DCON	CBDP	DCSFMS	PCD1	PCD2	☉
SEKT SEGT 12T3	6.0	F45 - SE12T3 - D50Z4S22	0500	50	63	4	40	Shellmill	22	22	48	-	-	●
		F45 - SE12T3 - D63Z5S22	0501	63	76	5	40		22	22	48	-	-	●
		F45 - SE12T3 - D80Z6S27	0502	80	93	6	50		27	25	58	-	-	●
		F45 - SE12T3 - D100Z7S32	0503	100	113	7	50		32	26	65	-	-	●
		F45 - SE12T3 - D125Z8S40 - WOC	0504	125	138	8	63		40	32	85	-	-	X
		F45 - SE12T3 - D160Z10S40 - WOC	0505	160	173	10	63		40	32	110	66.7	-	X
		F45 - SEKT12 - D40Z4S16	0031	40	54	4	40		16	18	32	-	-	●
SEKT SEGT 1204	6.0	F45 - SEKT12 - D50Z5S22	0032	50	64	5	40	Shellmill	22	20	48	-	-	●
		F45 - SEKT12 - D63Z4S22	0033	63	77	4	40		22	20	50	-	-	●
		F45 - SEKT12 - D63Z6S22	0034	63	77	6	40		22	20	50	-	-	●
		F45 - SEKT12 - D80Z4S27	0035	80	94	4	50		27	22	56	-	-	●
		F45 - SEKT12 - D80Z7S27	0036	80	94	7	50		27	22	56	-	-	●
		F45 - SEKT12 - D100Z8S32	0037	100	114	8	50		32	25	78	-	-	●
		F45 - SEKT12 - D125Z10S40	0038	125	139	10	63		40	29	90	-	-	●
		F45 - SEKT12 - D160Z12S40	0039	160	174	12	63		40	30	114	-	-	X

Milling - Face Milling - Cutter

Cutters for SPKN, SPKR, SPCN

Cutting Angle : 75°
4 Corner Positive ISO

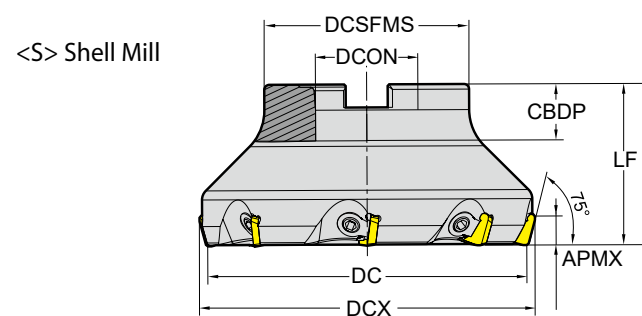

ZEFP : Effective Number of Cutting Edges
CIC : Number of Inserts
CDBP : Connection Bore Depth

Unit:mm

Series	APMX	Designation	EDP 1700..	DC	DCX	ZEFP	LF	TYPE	DCON	CDBP	DCSFMS	PCD1	PCD2	
SPKN SPKR SPCN 1203	8.0	F75 - SPKN12 - D50Z4S22 - WOC	0611	50	56	4	42	Shellmill	22	22	42	-	-	X
		F75 - SPKN12 - D63Z5S22 - WOC	0612	63	69	5	40	22	22	48	-	-	X	
		F75 - SPKN12 - D80Z6S27 - WOC	0613	80	86	6	50	27	25	58	-	-	X	
		F75 - SPKN12 - D100Z7S32 - WOC	0614	100	106	7	50	32	26	65	-	-	X	
		F75 - SPKN12 - D125Z8S40 - WOC	0615	125	131	8	63	40	32	80	-	-	X	
		F75 - SPKN12 - D160Z9S40 - WOC	0616	160	166	9	63	40	32	110	66.7	-	X	
		F75 - SPKN12 - D200Z12S60 - WOC	0617	200	206	12	63	60	40	130	101.6	-	X	

Milling - Face Milling - Inserts

ODMT, ODMW - Face Milling Positive (8 Corners)

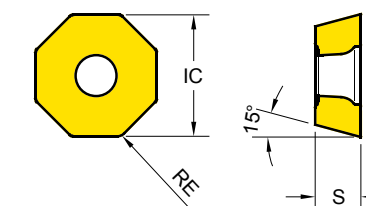

Series	IC	S
ODM*0605	15.9	5.6

EDP 1200..
● : Stock item ○ : Order made item

P25	P30	P20	P30	P40	K15
M30	K30	M40	H15	K15	
S20					

ODMT ODMW	Designation	RE (mm)	Fz (mm/tooth)	BS (mm)	YG602	YG622	YG712	YG713	YG613	YG501	YG5020
ODMT General	ODMT 060508	0.8	0.21 ~ 0.35		● 0030			● 0659	● 0675		
	ODMW 060508	0.8	0.26 ~ 0.40		● 0031						

ISO	VDI	Sub Group	Cutting Speed Vc (m/min.)													
			YG602		YG622		YG712		YG713		YG613		YG501		YG5020	
			Min	Max	Min	Max	Min	Max	Min	Max	Min	Max	Min	Max	Min	Max
P	1-5	Non-Alloyed Steel	180	380	140	400	170	300	200	300	100	210	-	-	-	-
	6-9	Low-Alloyed Steel	120	300	120	320	180	250	170	270	70	180	-	-	-	-
	10-11	High-Alloyed Steel	70	150	70	170	100	140	85	145	40	90	-	-	-	-
M	12-13	Ferritic & Martensitic	120	200	-	-	-	-	-	-	70	180	-	-	-	-
	14	Austenitic Stainless Steel	130	250	-	-	-	-	-	-	70	200	-	-	-	-
K	15-16	Grey Cast Iron	120	250	120	270	-	-	-	-	160	300	200	350	-	-
	17-18	Nodular Cast Iron	130	220	130	240	-	-	-	-	130	210	150	300	-	-
N	21-30	Non-Ferrous Metals (Al)	-	-	-	-	-	-	-	-	-	-	-	-	-	-
S	31-37	Superalloys & Titanium	25	45	-	-	-	-	-	-	-	-	-	-	-	-
H	38-41	Hard Materials	40	80	40	100	-	-	-	-	-	-	-	-	-	-

Milling - Face Milling - Inserts

OFER, OFMT - Face Milling Positive (8 Corners)

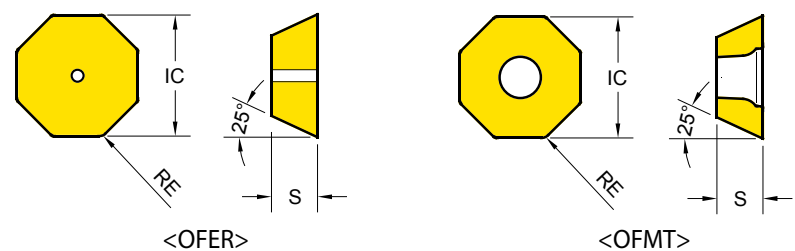

Series	IC	S
OFER 0704	18.05	4.78
OFMT 05T3	12.73	4.06

EDP 1200..

●: Stock item ○: Order made item

P25	P30	P20	P30	P40	K15	K15
M30				M40	H15	K15
K30	K30					
S20						

OFER	Designation	RE (mm)	Fz (mm/tooth)	BS (mm)	YG602	YG622	YG712	YG713	YG613	YG501	YG5020
OFER General	OFER 070405	0.5	0.22~0.50		● 0209						

OFMT	Designation	RE (mm)	Fz (mm/tooth)	BS (mm)	YG602	YG622	YG712	YG713	YG613	YG501	YG5020
OFMT General	OFMT 05T308	0.8	0.15~0.25		● 0032						

Cutting Speed			Vc (m/min.)													
ISO	VDI	Sub Group	YG602		YG622		YG712		YG713		YG613		YG501		YG5020	
			Min	Max	Min	Max	Min	Max	Min	Max	Min	Max	Min	Max	Min	Max
P	1~5	Non-Alloyed Steel	180	380	140	400	170	300	200	300	100	210	-	-	-	-
	6~9	Low-Alloyed Steel	120	300	120	320	180	250	170	270	70	180	-	-	-	-
	10~11	High-Alloyed Steel	70	150	70	170	100	140	85	145	40	90	-	-	-	-
M	12~13	Ferritic & Martensitic	120	200	-	-	-	-	-	-	70	180	-	-	-	-
	14	Austenitic Stainless Steel	130	250	-	-	-	-	-	-	70	200	-	-	-	-
K	15~16	Grey Cast Iron	120	250	120	270	-	-	-	-	-	-	160	300	200	350
	17~18	Nodular Cast Iron	130	220	130	240	-	-	-	-	-	-	130	210	150	300
N	21~30	Non-Ferrous Metals (Al)	-	-	-	-	-	-	-	-	-	-	-	-	-	-
S	31~37	Superalloys & Titanium	25	45	-	-	-	-	-	-	-	-	-	-	-	-
H	38~41	Hard Materials	40	80	40	100	-	-	-	-	-	-	-	-	-	-

Milling - Face Milling - Inserts

ONMU / ONHU - Face Milling Negative (16 Corners)

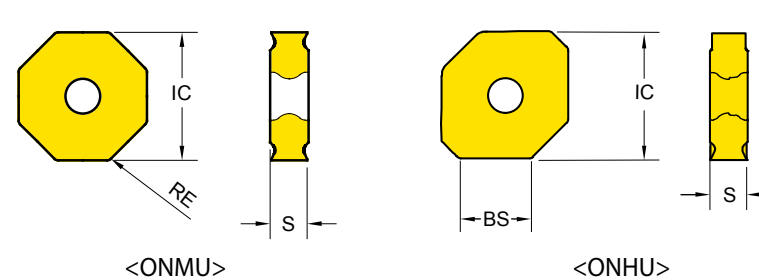

Series	IC	S
ON*U 0806	20.2	5.8

EDP 1200..

●: Stock item ○: Order made item

P25	P30	P20	P30	P40	K15	K15
M30				M40	H15	K15
K30	K30					
S20						

ONMU / ONHU	Designation	RE (mm)	Fz (mm/tooth)	BS (mm)	YG602	YG622	YG712	YG713	YG613	YG501	YG5020
ONMU General	ONMU 080608	0.8	0.22~0.50		● 0233			● 0657	● 0670		● 0414
	ONMU 080612	1.2	0.05~0.40					● 0615	● 0542		
ONHU Wiper Insert	ONHU 080612	1.2	0.08~0.25	10.6						● 0496	● 0482

Cutting Speed			Vc (m/min.)													
ISO	VDI	Sub Group	YG602		YG622		YG712		YG713		YG613		YG501		YG5020	
			Min	Max	Min	Max	Min	Max	Min	Max	Min	Max	Min	Max	Min	Max
P	1~5	Non-Alloyed Steel	180	380	140	400	170	300	200	300	100	210	-	-	-	-
	6~9	Low-Alloyed Steel	120	300	120	320	180	250	170	270	70	180	-	-	-	-
	10~11	High-Alloyed Steel	70	150	70	170	100	140	85	145	40	90	-	-	-	-
M	12~13	Ferritic & Martensitic	120	200	-	-	-	-	-	-	70	180	-	-	-	-
	14	Austenitic Stainless Steel	130	250	-	-	-	-	-	-	70	200	-	-	-	-
K	15~16	Grey Cast Iron	120	250	120	270	-	-	-	-	-	-	160	300	200	350
	17~18	Nodular Cast Iron	130	220	130	240	-	-	-	-	-	-	130	210	150	300
N	21~30	Non-Ferrous Metals (Al)	-	-	-	-	-	-	-	-	-	-	-	-	-	-
S	31~37	Superalloys & Titanium	25	45	-	-	-	-	-	-	-	-	-	-	-	-
H	38~41	Hard Materials	40	80	40	100	-	-	-	-	-	-	-	-	-	-

Milling - Face Milling - Inserts

PNMU - Face Milling Negative (10 Corners)

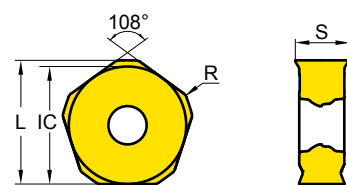

Series	KRINS	IC	S
PNMU 1206	36	14.0	5.84

EDP 1200..

●: Stock item ○: Order made item

P25	P30	P20	P30	P40	K15	K15
M30				M40	H15	
K30	K30					
S20						

PNMU	Designation	RE (mm)	Fz (mm/tooth)	BS (mm)	EDP 1200..						
					YG602	YG622	YG712	YG713	YG613	YG501	YG5020
General	PNMU1206ZNN	0.8	0.05~0.50	2.10	●	●	●	●	●	●	●
					○	○	○	○	○	○	○



Milling - Face Milling - Inserts

SDKN / CN - Face Milling Positive (4 Corners ISO)

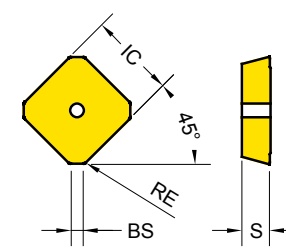

Series	AS	IC	S
SD** 1203	15°	12.70	3.18
SD** 1504	15°	15.88	4.76

EDP 1200..

●: Stock item ○: Order made item

P25	P30	P20	P30	P40	K15	K15
M30				M40	H15	
K30	K30					
S20						

SDKN SDCN	Designation	RE (mm)	Fz (mm/tooth)	BS (mm)	EDP 1200..						
					YG602	YG622	YG712	YG713	YG613	YG501	YG5020
Hard Materials	SDKN 1203 AETN	0.5	0.22~0.35	1.85	●						
	SDKN 1203 AETN -PW	0.4	0.22~0.35	1.98	●						
	SDKN 1203 AETN -GW	1.3	0.22~0.35	1.85	●						
	SDKN 1504 AETN	0.45	0.22~0.35	2.00	●						
	SDKN 1504 AETN -PW	0.4	0.22~0.40	1.95	●						
Ground insert	SDKN 1504 AETN -GW	1.3	0.22~0.40	2.05	●						
	SDCN 1203 AESN - M		0.05~0.2	2.04			●				
	SDCN 1504 AESN - M		0.05~0.2	2.19			●				
	SDCN 1504 AESN -MR	1.0	0.05~0.20	2.19			●				

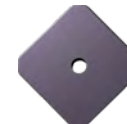

- PW : for Improved Surface Roughness
 - GW : Ground Wiper
 - M : for Mold & Die
 - MR : for Mold & Die Roughing

ISO	VDI	Sub Group	Cutting Speed Vc (m/min.)													
			YG602		YG622		YG712		YG713		YG613		YG501		YG5020	
P	1~5	Non-Alloyed Steel	180	380	140	400	170	300	200	300	100	210	-	-	-	-
	6~9	Low-Alloyed Steel	120	300	120	320	180	250	170	270	70	180	-	-	-	-
	10~11	High-Alloyed Steel	70	150	70	170	100	140	85	145	40	90	-	-	-	-
M	12~13	Ferritic & Martensitic	120	200	-	-	-	-	-	-	70	180	-	-	-	-
	14	Austenitic Stainless Steel	130	250	-	-	-	-	-	-	70	200	-	-	-	-
K	15~16	Grey Cast Iron	120	250	120	270	-	-	-	-	160	300	200	350	-	-
	17~18	Nodular Cast Iron	130	220	130	240	-	-	-	-	130	210	150	300	-	-
N	21~30	Non-Ferrous Metals (Al)	-	-	-	-	-	-	-	-	-	-	-	-	-	-
S	31~37	Superalloys & Titanium	25	45	-	-	-	-	-	-	-	-	-	-	-	-
H	38~41	Hard Materials	40	80	40	100	-	-	-	-	-	-	-	-	-	-

ISO	VDI	Sub Group	Cutting Speed Vc (m/min.)													
			YG602		YG622		YG712		YG713		YG613		YG501		YG5020	
P	1~5	Non-Alloyed Steel	180	380	140	400	170	300	200	300	100	210	-	-	-	-
	6~9	Low-Alloyed Steel	120	300	120	320	180	250	170	270	70	180	-	-	-	-
	10~11	High-Alloyed Steel	70	150	70	170	100	140	85	145	40	90	-	-	-	-
M	12~13	Ferritic & Martensitic	120	200	-	-	-	-	-	-	70	180	-	-	-	-
	14	Austenitic Stainless Steel	130	250	-	-	-	-	-	-	70	200	-	-	-	-
K	15~16	Grey Cast Iron	120	250	120	270	-	-	-	-	160	300	200	350	-	-
	17~18	Nodular Cast Iron	130	220	130	240	-	-	-	-	130	210	150	300	-	-
N	21~30	Non-Ferrous Metals (Al)	-	-	-	-	-	-	-	-	-	-	-	-	-	-
S	31~37	Superalloys & Titanium	25	45	-	-	-	-	-	-	-	-	-	-	-	-
H	38~41	Hard Materials	40	80	40	100	-	-	-	-	-	-	-	-	-	-

Milling - Face Milling - Inserts

SEKR / N - Face Milling Positive (4 Corners ISO)

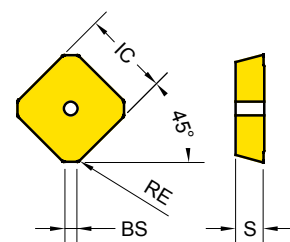

Series	AS	IC	S
SEK* 1203	20°	12.7	3.2

EDP 1200..

●: Stock item ○: Order made item

P25	P30	P20	P30	P40	K15	K15
M30				M40	H15	K15
K30	K30					
S20						

	SEKR SEKN	Designation	RE (mm)	Fz (mm/tooth)	BS (mm)	Material								
						YG602	YG622	YG712	YG713	YG613	YG501	YG5020		
SEKR General		SEKR 1203 AFTN	0.4	0.14~0.30	1.40	●								
		SEKR 1203 AFTN -PW	0.4	0.14~0.30	2.00	●								
SEKN Hard Materials		SEKN 1203 AFTN	0.4	0.22~0.35	1.40	●								
		SEKN 1203 AFTN -GW	0.4	0.23~0.35	2.00	●								
		SEKN 1203 AFTN -PW	0.4	0.22~0.35	2.00	●								

- PW : for Improved Surface Roughness
- GW : Ground Wiper

ISO	VDI	Sub Group	Cutting Speed Vc (m/min.)													
			YG602		YG622		YG712		YG713		YG613		YG501		YG5020	
			Min	Max	Min	Max	Min	Max	Min	Max	Min	Max	Min	Max	Min	Max
P	1~5	Non-Alloyed Steel	180	380	140	400	170	300	200	300	100	210	-	-	-	-
	6~9	Low-Alloyed Steel	120	300	120	320	180	250	170	270	70	180	-	-	-	-
	10~11	High-Alloyed Steel	70	150	70	170	100	140	85	145	40	90	-	-	-	-
M	12~13	Ferritic & Martensitic	120	200	-	-	-	-	-	-	70	180	-	-	-	-
	14	Austenitic Stainless Steel	130	250	-	-	-	-	-	-	70	200	-	-	-	-
K	15~16	Grey Cast Iron	120	250	120	270	-	-	-	-	160	300	200	350	-	
	17~18	Nodular Cast Iron	130	220	130	240	-	-	-	-	130	210	150	300	-	
N	21~30	Non-Ferrous Metals (Al)	-	-	-	-	-	-	-	-	-	-	-	-	-	
S	31~37	Superalloys & Titanium	25	45	-	-	-	-	-	-	-	-	-	-	-	
H	38~41	Hard Materials	40	80	40	100	-	-	-	-	-	-	-	-	-	

Milling - Face Milling - Inserts

SEKT - Face Milling Positive (4 Corners)

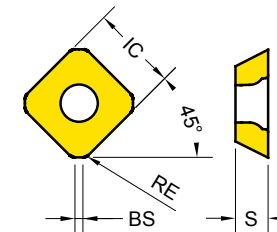

Series	IC	S
SEKT 1204	12.7	4.9
SEKT 12T3	13.4	4

EDP 1200..

●: Stock item ○: Order made item

P25	P30	P20	P30	P40	K15	K15
M30				M40	H15	K15
K30	K30					
S20						

	SEKT 1204	Designation	RE (mm)	Fz (mm/tooth)	BS (mm)	Material								
						YG602	YG622	YG712	YG713	YG613	YG501	YG5020		
SEKT 1204 General		SEKT 1204 AFTN	1.1	0.20~0.35	1.18	●	○							
		SEKT 1204 -ST	1.1	0.08~0.30	2.00	●								
-ST Stainless Steel Super Alloy		SEKT 1204 -ST	1.1	0.08~0.30	2.00	●								
		SEKT 1204 -ST	1.1	0.08~0.30	2.00	●								

	SEKT 12T3	Designation	RE (mm)	Fz (mm/tooth)	BS (mm)	Material								
						YG602	YG622	YG712	YG713	YG613	YG501	YG5020		
SEKT 12T3 General		SEKT 12T3 AGTN	1.5	0.15~0.30	1.30	●								
		SEKT 12T3 -ST	1.5	0.08~0.30	2.00	●				●				
-ST Stainless Steel Super Alloy		SEKT 12T3 -ST	1.5	0.08~0.30	2.00	●				●				
		SEKT 12T3 -ST	1.5	0.08~0.30	2.00	●				●				

ISO	VDI	Sub Group	Cutting Speed Vc (m/min.)													
			YG602		YG622		YG712		YG713		YG613		YG501		YG5020	
			Min	Max	Min	Max	Min	Max	Min	Max	Min	Max	Min	Max	Min	Max
P	1~5	Non-Alloyed Steel	180	380	140	400	170	300	200	300	100	210	-	-	-	-
	6~9	Low-Alloyed Steel	120	300	120	320	180	250	170	270	70	180	-	-	-	-
	10~11	High-Alloyed Steel	70	150	70	170	100	140	85	145	40	90	-	-	-	-
M	12~13	Ferritic & Martensitic	120	200	-	-	-	-	-	-	70	180	-	-	-	-
	14	Austenitic Stainless Steel	130	250	-	-	-	-	-	-	70	200	-	-	-	-
K	15~16	Grey Cast Iron	120	250	120	270	-	-	-	-	160	300	200	350	-	
	17~18	Nodular Cast Iron	130	220	130	240	-	-	-	-	130	210	150	300	-	
N	21~30	Non-Ferrous Metals (Al)	-	-	-	-	-	-	-	-	-	-	-	-	-	
S	31~37	Superalloys & Titanium	25	45	-	-	-	-	-	-	-	-	-	-	-	
H	38~41	Hard Materials	40	80	40	100	-	-	-	-	-	-	-	-	-	

Milling - Face Milling - Inserts

SEGT - Face Milling Positive (4 Corners)

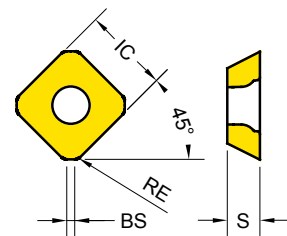

Series	IC	S
SEGT 1204	12.74	4.91
SEGT 12T3	13.40	4.03

EDP 1200..

●: Stock item ○: Order made item

P25	P30	P20	P30	P40	K15	N15
M30				M40		
K30	K30					
S20						

SEGT 1204	Designation	RE (mm)	Fz (mm/tooth)	BS (mm)	Material								
					YG602	YG622	YG712	YG713	YG613	YG5020	YG50		
	SEGT 1204-AL	1.1	0.1~0.35	2.01								●	0467

-AL
Aluminium

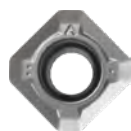

SEGT 12T3	Designation	RE (mm)	Fz (mm/tooth)	BS (mm)	Material								
					YG602	YG622	YG712	YG713	YG613	YG5020	YG50		
	SEGT 12T3-AL	1.5	0.1~0.35	1.94								●	0468

-AL
Aluminium



Cutting Speed			Vc (m/min.)													
ISO	VDI	Sub Group	YG602		YG622		YG712		YG713		YG613		YG5020		YG50	
			Min	Max	Min	Max	Min	Max	Min	Max	Min	Max	Min	Max	Min	Max
P	1~5	Non-Alloyed Steel	180	380	140	400	170	300	200	300	100	210	-	-	-	-
	6~9	Low-Alloyed Steel	120	300	120	320	180	250	170	270	70	180	-	-	-	-
	10~11	High-Alloyed Steel	70	150	70	170	100	140	85	145	40	90	-	-	-	-
M	12~13	Ferritic & Martensitic	120	200	-	-	-	-	-	-	70	180	-	-	-	-
	14	Austenitic Stainless Steel	130	250	-	-	-	-	-	-	70	200	-	-	-	-
K	15~16	Grey Cast Iron	120	250	120	270	-	-	-	-	-	200	350	-	-	
	17~18	Nodular Cast Iron	130	220	130	240	-	-	-	-	-	150	300	-	-	
N	21~30	Non-Ferrous Metals (Al)	-	-	-	-	-	-	-	-	-	-	-	300	800	
S	31~37	Superalloys & Titanium	25	45	-	-	-	-	-	-	-	-	-	-	-	
H	38~41	Hard Materials	40	80	40	100	-	-	-	-	-	-	-	-	-	

Milling - Face Milling - Inserts

SEMT - Face Milling Positive (4 Corners)

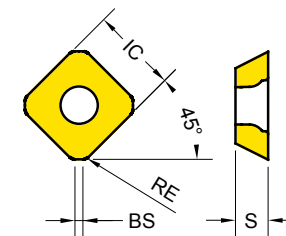

Series	IC	S
SEMT1204	12.92	5.1
SEMT13T3	13.40	4.0

EDP 1200..

●: Stock item ○: Order made item

P25	P30	P20	P30	P40	K15	K15
M30				M40	H15	K15
K30	K30					
S20						

SEMT	Designation	RE (mm)	Fz (mm/tooth)	BS (mm)	Material								
					YG602	YG622	YG712	YG713	YG613	YG501	YG5020		
SEMT 1204 General	SEMT 1204 AFTN	1.2	0.26~0.4	1.24	●								
					0052								
SEMT 13T3 General	SEMT 13T3 AGSN	1.5	0.15~0.3	1.31	●								
					0203								

SEMT 1204
General

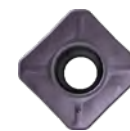

SEMT 13T3
General



Cutting Speed			Vc (m/min.)													
ISO	VDI	Sub Group	YG602		YG622		YG712		YG713		YG613		YG501		YG5020	
			Min	Max	Min	Max	Min	Max	Min	Max	Min	Max	Min	Max	Min	Max
P	1~5	Non-Alloyed Steel	180	380	140	400	170	300	200	300	100	210	-	-	-	-
	6~9	Low-Alloyed Steel	120	300	120	320	180	250	170	270	70	180	-	-	-	-
	10~11	High-Alloyed Steel	70	150	70	170	100	140	85	145	40	90	-	-	-	-
M	12~13	Ferritic & Martensitic	120	200	-	-	-	-	-	-	70	180	-	-	-	-
	14	Austenitic Stainless Steel	130	250	-	-	-	-	-	-	70	200	-	-	-	-
K	15~16	Grey Cast Iron	120	250	120	270	-	-	-	-	-	160	300	200	350	
	17~18	Nodular Cast Iron	130	220	130	240	-	-	-	-	-	130	210	150	300	
N	21~30	Non-Ferrous Metals (Al)	-	-	-	-	-	-	-	-	-	-	-	-	-	
S	31~37	Superalloys & Titanium	25	45	-	-	-	-	-	-	-	-	-	-	-	
H	38~41	Hard Materials	40	80	40	100	-	-	-	-	-	-	-	-	-	

Milling - Face Milling - Inserts
SNMX - Face Milling Negative (8 Corners)

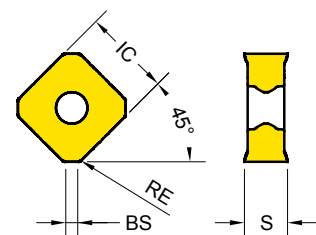

Series	IC	S
SNMX 1206	12.7	6.25

EDP 1200..
 ●: Stock item ○: Order made item

P25	P30	P20	P30	P40	K15	K15
M30				M40	H15	
K30	K30					
S20						

SNMX	Designation	RE (mm)	Fz (mm/tooth)	BS (mm)	EDP 1200..						
					YG602	YG622	YG712	YG713	YG613	YG501	YG5020
General	SNMX 1206 ANN	0.8	0.16~0.34	1.70	●			●	●		
					○231			○0658	○0674		

EDP 1200..
 ●: Stock item ○: Order made item

P25	P30	P20	P30	P40	K15	K15
M30				M40	H15	
K30	K30					
S20						

Milling - Face Milling - Inserts
SPKN / R / CN - Face Milling Positive (4 Corners ISO)

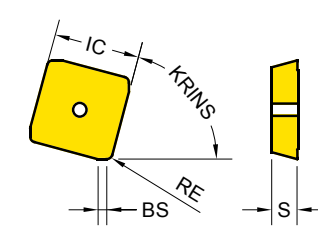

Series	KRINS	AS	IC	S
SP** 1203	75°	11°	12.70	3.18
SP** 1504	75°	11°	15.88	4.76

SPKR SPKN SPCN	Designation	RE (mm)	Fz (mm/tooth)	BS (mm)	EDP 1200..						
					YG602	YG622	YG712	YG713	YG613	YG501	YG5020
SPKR General	SPKR 1203 EDTR	0.8	0.15~0.35	1.40	●						
	SPKR 1203 EDTR-PW	0.8	0.15~0.35	1.54	○						
SPKN Hard Materials	SPKN 1203 EDTR	0.8	0.16~0.34	1.40	●						
	SPKN 1203 EDTR-GW	0.6	0.15~0.28	1.50	●						
	SPKN 1203 EDTR-PW	0.8	0.20~0.35	1.50	●						
	SPKN 1504 EDTR	0.8	0.15~0.34	1.30	●						
	SPKN 1504 EDTR-GW	0.8	0.25~0.40	2.20	●						
	SPKN 1504 EDTR-PW	0.8	0.25~0.40	2.13	●						
SPCN Ground insert	SPCN 1203 EDSR - M	0.8	0.1~0.2	1.82			●				
	SPCN 1203 EDSR - MR	0.8	0.1~0.2	1.77			●				
	SPCN 1504 EDSR - M	0.8	0.1~0.2	1.92			●				
	SPCN 1504 EDSR - MR	0.8	0.1~0.2	1.86			●				

- PW : for Improved Surface Roughness
 - GW : Ground Wiper
 - M : for Mold & Die
 - MR : for Mold & Die Roughing

ISO	VDI	Sub Group	Cutting Speed Vc (m/min.)													
			YG602		YG622		YG712		YG713		YG613		YG501		YG5020	
			Min	Max	Min	Max	Min	Max	Min	Max	Min	Max	Min	Max	Min	Max
P	1~5	Non-Alloyed Steel	180	380	140	400	170	300	200	300	100	210	-	-	-	-
	6~9	Low-Alloyed Steel	120	300	120	320	180	250	170	270	70	180	-	-	-	-
	10~11	High-Alloyed Steel	70	150	70	170	100	140	85	145	40	90	-	-	-	-
M	12~13	Ferritic & Martensitic	120	200	-	-	-	-	-	-	70	180	-	-	-	-
	14	Austenitic Stainless Steel	130	250	-	-	-	-	-	-	70	200	-	-	-	-
K	15~16	Grey Cast Iron	120	250	120	270	-	-	-	-	160	300	200	350	-	-
	17~18	Nodular Cast Iron	130	220	130	240	-	-	-	-	130	210	150	300	-	-
N	21~30	Non-Ferrous Metals (Al)	-	-	-	-	-	-	-	-	-	-	-	-	-	-
S	31~37	Superalloys & Titanium	25	45	-	-	-	-	-	-	-	-	-	-	-	-
H	38~41	Hard Materials	40	80	40	100	-	-	-	-	-	-	-	-	-	-

ISO	VDI	Sub Group	Cutting Speed Vc (m/min.)													
			YG602		YG622		YG712		YG713		YG613		YG501		YG5020	
			Min	Max	Min	Max	Min	Max	Min	Max	Min	Max	Min	Max	Min	Max
P	1~5	Non-Alloyed Steel	180	380	140	400	170	300	200	300	100	210	-	-	-	-
	6~9	Low-Alloyed Steel	120	300	120	320	180	250	170	270	70	180	-	-	-	-
	10~11	High-Alloyed Steel	70	150	70	170	100	140	85	145	40	90	-	-	-	-
M	12~13	Ferritic & Martensitic	120	200	-	-	-	-	-	-	70	180	-	-	-	-
	14	Austenitic Stainless Steel	130	250	-	-	-	-	-	-	70	200	-	-	-	-
K	15~16	Grey Cast Iron	120	250	120	270	-	-	-	-	160	300	200	350	-	-
	17~18	Nodular Cast Iron	130	220	130	240	-	-	-	-	130	210	150	300	-	-
N	21~30	Non-Ferrous Metals (Al)	-	-	-	-	-	-	-	-	-	-	-	-	-	-
S	31~37	Superalloys & Titanium	25	45	-	-	-	-	-	-	-	-	-	-	-	-
H	38~41	Hard Materials	40	80	40	100	-	-	-	-	-	-	-	-	-	-

Milling - Face Milling - Inserts

SPMT - Universal Positive (4 Corners)

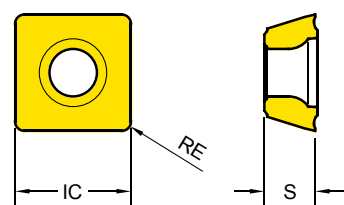

Series	AS	IC	S
SPMT 1204	11°	12.7	4.81

EDP 1200..

●: Stock item ○: Order made item

P25	P30	P20	P30	P40	K15	K15
M30				M40	H15	K15
K30	K30					
S20						

SPMT	Designation	RE (mm)	Fz (mm/tooth)	BS (mm)	YG602	YG622	YG712	YG713	YG613	YG501	YG5020
SPMT General	SPMT 120408	0.8	0.15~0.3		● 0223						



EDP 1200..

●: Stock item ○: Order made item

P25	P30	P20	P30	P40	K15	K15
M30				M40	H15	K15
K30	K30					
S20						

Milling - Face Milling - Inserts

SPUN - Universal Positive (4 Corners ISO)

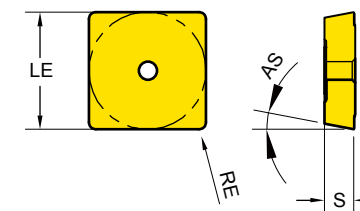

Series	AS	IC	S
SPUN 1203	11°	12.7	3.2

SPUN	Designation	RE (mm)	Fz (mm/tooth)	BS (mm)	YG602	YG622	YG712	YG713	YG613	YG501	YG5020
SPUN General	SPUN 120308	0.8			● 0224						



Cutting Speed			Vc (m/min.)													
ISO	VDI	Sub Group	YG602		YG622		YG712		YG713		YG613		YG501		YG5020	
			Min	Max	Min	Max	Min	Max	Min	Max	Min	Max	Min	Max	Min	Max
P	1~5	Non-Alloyed Steel	180	380	140	400	170	300	200	300	100	210	-	-	-	-
	6~9	Low-Alloyed Steel	120	300	120	320	180	250	170	270	70	180	-	-	-	-
	10~11	High-Alloyed Steel	70	150	70	170	100	140	85	145	40	90	-	-	-	-
M	12~13	Ferritic & Martensitic	120	200	-	-	-	-	-	-	70	180	-	-	-	-
	14	Austenitic Stainless Steel	130	250	-	-	-	-	-	-	70	200	-	-	-	-
K	15~16	Grey Cast Iron	120	250	120	270	-	-	-	-	160	300	200	350	-	-
	17~18	Nodular Cast Iron	130	220	130	240	-	-	-	-	130	210	150	300	-	-
N	21~30	Non-Ferrous Metals (Al)	-	-	-	-	-	-	-	-	-	-	-	-	-	-
S	31~37	Superalloys & Titanium	25	45	-	-	-	-	-	-	-	-	-	-	-	-
H	38~41	Hard Materials	40	80	40	100	-	-	-	-	-	-	-	-	-	-

Cutting Speed			Vc (m/min.)													
ISO	VDI	Sub Group	YG602		YG622		YG712		YG713		YG613		YG501		YG5020	
			Min	Max	Min	Max	Min	Max	Min	Max	Min	Max	Min	Max	Min	Max
P	1~5	Non-Alloyed Steel	180	380	140	400	170	300	200	300	100	210	-	-	-	-
	6~9	Low-Alloyed Steel	120	300	120	320	180	250	170	270	70	180	-	-	-	-
	10~11	High-Alloyed Steel	70	150	70	170	100	140	85	145	40	90	-	-	-	-
M	12~13	Ferritic & Martensitic	120	200	-	-	-	-	-	-	70	180	-	-	-	-
	14	Austenitic Stainless Steel	130	250	-	-	-	-	-	-	70	200	-	-	-	-
K	15~16	Grey Cast Iron	120	250	120	270	-	-	-	-	160	300	200	350	-	-
	17~18	Nodular Cast Iron	130	220	130	240	-	-	-	-	130	210	150	300	-	-
N	21~30	Non-Ferrous Metals (Al)	-	-	-	-	-	-	-	-	-	-	-	-	-	-
S	31~37	Superalloys & Titanium	25	45	-	-	-	-	-	-	-	-	-	-	-	-
H	38~41	Hard Materials	40	80	40	100	-	-	-	-	-	-	-	-	-	-

Milling - Shoulder Milling - Cutter
Cutters for APKT

Cutting Angle : 90°
2 Corner Positive

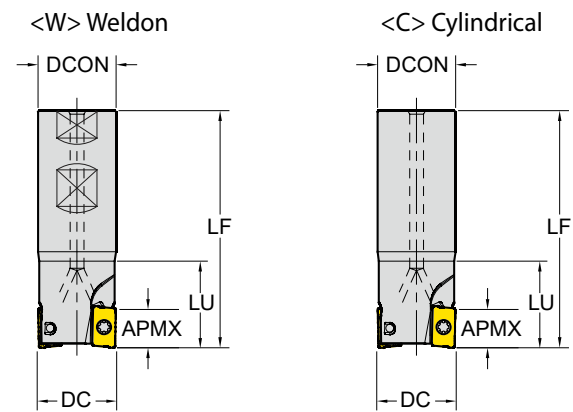

ZAFP : Effective Number of Cutting Edges
CICT : Number of Inserts
CBDP : Connection Bore Depth

p. 138 Unit:mm

Series	APMX	Designation	EDP 1700..	DC	ZAFP	LU	LF	TYPE	DCON	CBDP	DCSFMS	PCD1	PCD2	☉
APKT 1003	10.0	E90 - APKT10 - D16Z2C16 - L100	0083	16	2	40	100	Cylindrical	16	-	-	-	-	●
		E90 - APKT10 - D16Z2C16 - L120	0532	16	2	30	120		16	-	-	-	-	●
		E90 - APKT10 - D16Z2C16 - L150	0154	16	2	40	150		16	-	-	-	-	●
		E90 - APKT10 - D16Z2C16 - L200	0533	16	2	100	200		16	-	-	-	-	●
		E90 - APKT10 - D20Z2C20 - L250	0534	20	2	150	250		20	-	-	-	-	●
		E90 - APKT10 - D20Z3C20 - L100	0535	20	3	30	100		20	-	-	-	-	●
		E90 - APKT10 - D20Z3C20 - L120	0085	20	3	40	120		20	-	-	-	-	●
		E90 - APKT10 - D20Z3C20 - L150	0536	20	3	50	150		20	-	-	-	-	●
		E90 - APKT10 - D20Z3C20 - L200	0270	20	3	100	200		20	-	-	-	-	●
		E90 - APKT10 - D25Z3C25 - L100	0537	25	3	30	100		25	-	-	-	-	●
		E90 - APKT10 - D25Z3C25 - L120	0186	25	3	40	120	25	-	-	-	-	●	
		E90 - APKT10 - D30Z4C25 - L100	0122	30	4	30	100	25	-	-	-	-	●	
		E90 - APKT10 - D30Z4C25 - L120	0086	30	4	30	120	25	-	-	-	-	●	
		E90 - APKT10 - D32Z4C25 - L100	0538	32	4	35	100	25	-	-	-	-	●	
		E90 - APKT10 - D32Z4C25 - L150 - WOC	0539	32	4	35	150	25	-	-	-	-	X	
		E90 - APKT10 - D12Z1W16 - L100	0540	12	1	30	100	16	-	-	-	-	●	
		E90 - APKT10 - D14Z1W16 - L100	0541	14	1	30	100	16	-	-	-	-	●	
		E90 - APKT10 - D16Z2W16 - L100	0542	16	2	30	100	16	-	-	-	-	●	
		E90 - APKT10 - D16Z2W16 - L85	0082	16	2	-	85	16	-	-	-	-	●	
		E90 - APKT10 - D18Z2W16 - L100	0543	18	2	30	100	16	-	-	-	-	●	

▶ NEXT PAGE

Milling - Shoulder Milling - Cutter
Cutters for APKT

Cutting Angle : 90°
2 Corner Positive

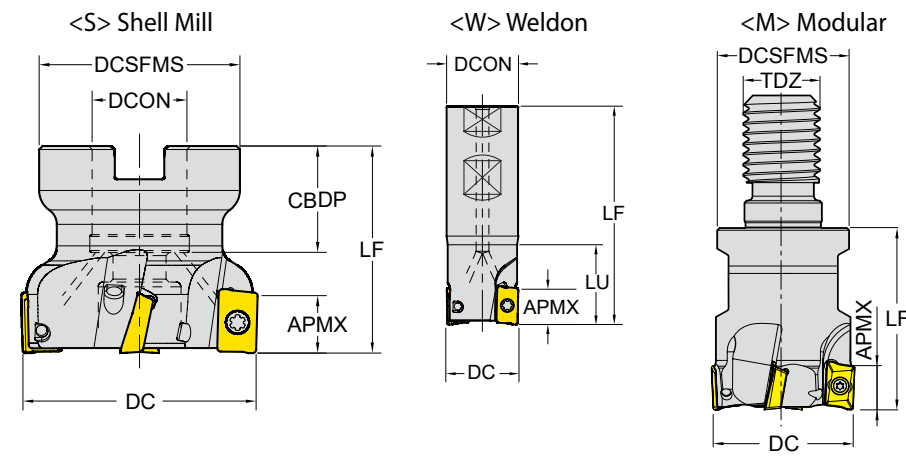

ZAFP : Effective Number of Cutting Edges
CICT : Number of Inserts
CBDP : Connection Bore Depth

p. 138 Unit:mm

Series	APMX	Designation	EDP 1700..	DC	ZAFP	LU	LF	TYPE	DCON /TDZ	CBDP	DCSFMS	PCD1	PCD2	☉
APKT 1003	10.0	E90 - APKT10 - D20Z3W20 - L100	0461	20	3	30	100	Weldon	20	-	-	-	-	●
		E90 - APKT10 - D20Z3W20 - L90	0084	20	3	40	90		20	-	-	-	-	●
		E90 - APKT10 - D22Z3W20 - L100	0544	22	3	30	100		20	-	-	-	-	●
		E90 - APKT10 - D25Z3W25 - L100	0545	25	3	30	100		25	-	-	-	-	●
		E90 - APKT10 - D25Z4W25 - L100	0546	25	4	30	100		25	-	-	-	-	●
		E90 - APKT10 - D32Z4W32 - L150 - WOC	0547	32	4	50	150		32	-	-	-	-	X
		F90 - APKT10 - D40Z4S16	0087	40	4	-	40		16	18	34	-	-	-
		F90 - APKT10 - D40Z5S16	0472	40	5	-	40	16	20	36	-	-	-	●
		F90 - APKT10 - D50Z6S22	0215	50	6	-	40	22	22	42	-	-	-	●
		F90 - APKT10 - D50Z7S22	0088	50	7	-	40	22	20	42	-	-	-	●
		F90 - APKT10 - D63Z7S22	0548	63	7	-	40	22	22	48	-	-	-	●
		F90 - APKT10 - D80Z8S27	0549	80	8	-	50	27	25	58	-	-	-	●
		F90 - APKT10 - D100Z9S32	0550	100	9	-	50	32	26	65	-	-	-	●
		M90 - APKT10 - D16Z2M08	0551	16	2	-	30	M08	-	14.75	-	-	-	●
		M90 - APKT10 - D20Z3M10	0552	20	3	-	30	M10	-	18	-	-	-	●
		M90 - APKT10 - D25Z3M12	0553	25	3	-	35	M12	-	21	-	-	-	●
		M90 - APKT10 - D32Z4M16	0554	32	4	-	35	M16	-	29	-	-	-	●
		M90 - APKT10 - D40Z5M16	0555	40	5	-	43	M16	-	29	-	-	-	●
		M90 - APKT10 - D42Z5M16	0556	42	5	-	43	M16	-	29	-	-	-	●

Milling - Shoulder Milling - Cutter
Cutters for APKT

Cutting Angle : 90°
2 Corner Positive

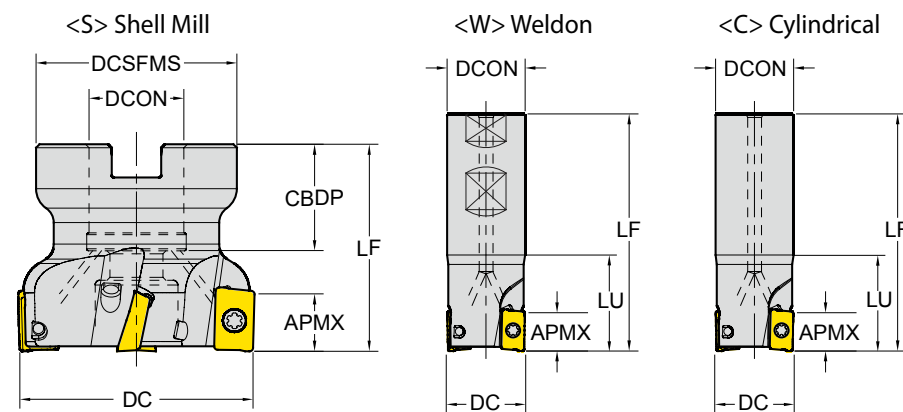

ZAFP : Effective Number of Cutting Edges
CICT : Number of Inserts
CBDP : Connection Bore Depth

□ : p. 138 Unit : mm

Series	APMX	Designation	EDP 1700..	DC	ZAFP	LU	LF	TYPE	DCON	CBDP	DCSFMS	PCD1	PCD2	☉	
APKT 1604	16.0	E90 - APKT16 - D25Z2C20 - L100	0091	25	2	-	100	Cylindrical	20	-	-	-	-	●	
		E90 - APKT16 - D25Z2C20 - L100 - WOC	0243	25	2	35	100		20	-	-	-	-	-	X
		E90 - APKT16 - D25Z2C25 - L250 - WOC	0557	25	2	100	250		25	-	-	-	-	-	X
		E90 - APKT16 - D32Z2C32 - L250 - WOC	0558	32	2	100	250		32	-	-	-	-	-	X
		E90 - APKT16 - D32Z3C25 - L110	0094	32	3	-	110		25	-	-	-	-	-	●
		E90 - APKT16 - D32Z3C25 - L200	0559	32	3	40	200		25	-	-	-	-	-	●
		E90 - APKT16 - D32Z3C32 - L150 - WOC	0250	32	3	50	150		32	-	-	-	-	-	X
		E90 - APKT16 - D32Z3C32 - L250 - WOC	0560	32	3	100	250		32	-	-	-	-	-	X
		E90 - APKT16 - D40Z4C32 - L150 - WOC	0561	40	4	40	150		32	-	-	-	-	-	X
		E90 - APKT16 - D25Z2W25 - L100	0562	25	2	35	100		25	-	-	-	-	-	●
		E90 - APKT16 - D25Z2W25 - L110	0092	25	2	-	110	25	-	-	-	-	-	●	
		E90 - APKT16 - D28Z3W25 - L100	0563	28	3	40	100	25	-	-	-	-	-	●	
		E90 - APKT16 - D30Z3W25 - L110	0564	30	3	40	110	25	-	-	-	-	-	●	
		E90 - APKT16 - D32Z3W25 - L110	0093	32	3	-	110	25	-	-	-	-	-	●	
		E90 - APKT16 - D32Z3W32 - L110	0565	32	3	40	110	32	-	-	-	-	-	●	
		E90 - APKT16 - D36Z3W32 - L110	0566	36	3	40	110	32	-	-	-	-	-	●	
		F90 - APKT16 - D40Z4S16	0275	40	4	-	40	16	20	36	-	-	-	●	
		F90 - APKT16 - D50Z5S22	0095	50	5	-	40	22	20	45	-	-	-	●	

▶ NEXT PAGE

Milling - Shoulder Milling - Cutter
Cutters for APKT

Cutting Angle : 90°
2 Corner Positive

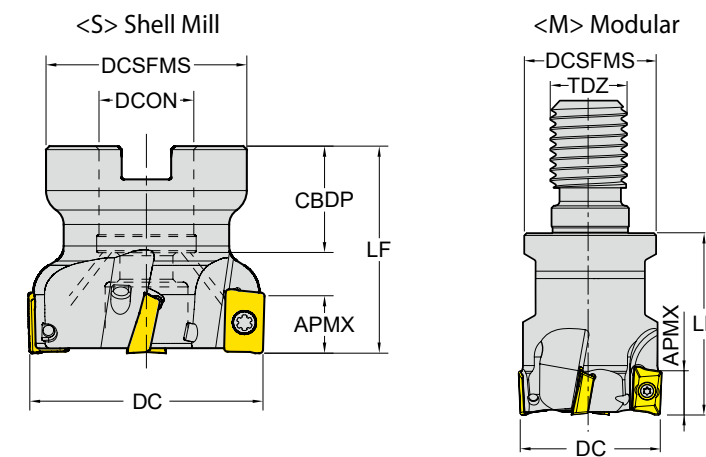

ZAFP : Effective Number of Cutting Edges
CICT : Number of Inserts
CBDP : Connection Bore Depth

□ : p. 138 Unit : mm

Series	APMX	Designation	EDP 1700..	DC	ZAFP	LU	LF	TYPE	DCON / TDZ	CBDP	DCSFMS	PCD1	PCD2	☉	
APKT 1604	16.0	F90 - APKT16 - D52Z5S22	0567	52	5	-	40	Shellmill	22	22	42	-	-	●	
		F90 - APKT16 - D63Z6S22	0096	63	6	-	40		22	20	50	-	-	●	
		F90 - APKT16 - D80Z7S27	0097	80	7	-	50		27	23	56	-	-	●	
		F90 - APKT16 - D100Z8S32	0181	100	8	-	50		32	26	65	-	-	●	
		F90 - APKT16 - D125Z9S40 - WOC	0238	125	9	-	63		40	32	80	-	-	X	
		F90 - APKT16 - D160Z10S40 - WOC	0568	160	10	-	63		40	32	110	66.7	-	X	
		F90 - APKT16 - D200Z12S60 - WOC	0569	200	12	-	63		60	40	130	101.6	-	X	
		M90 - APKT16 - D25Z2M12	0570	25	2	-	43		Modular	M12	-	21	-	-	●
		M90 - APKT16 - D32Z3M16	0571	32	3	-	43			M16	-	29	-	-	●
		M90 - APKT16 - D42Z4M16	0572	42	4	-	43			M16	-	29	-	-	●

Milling - Shoulder Milling - Cutter
Cutters for TPKN, TPKR, TPCN

Cutting Angle : 90°
 3 Corner Positive ISO

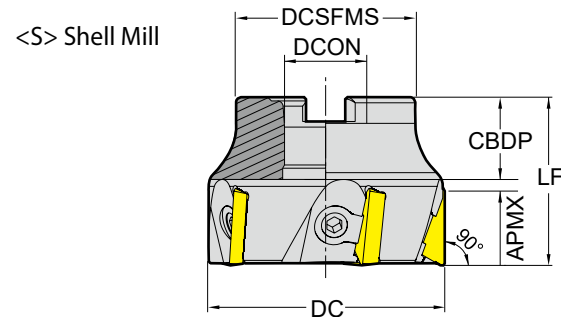

ZEFP : Effective Number of Cutting Edges
 CICT : Number of Inserts
 CBDP : Connection Bore Depth

□: p. 141 Unit:mm

Series	APMX	Designation	EDP 1700..	DC	ZEFP	LU	LF	TYPE	DCON	CBDP	DCSFMS	PCD1	PCD2	☉
TPKN TPKR TPCN 1603	12.0	F90-TPKN16-D50Z4S22-WOC	0618	50	4	-	40	Shellmill	22	22	42	-	-	X
		F90-TPKN16-D63Z6S22-WOC	0619	63	6	-	45		22	22	48	-	-	X
		F90-TPKN16-D80Z7S27-WOC	0620	80	7	-	50		27	25	58	-	-	X
		F90-TPKN16-D125Z8S40-WOC	0621	125	8	-	63		40	32	80	-	-	X
TPKN TPKR TPCN 2204	18.0	F90-TPKN22-D63Z5S22-WOC	0622	63	5	-	45	Shellmill	22	22	48	-	-	X
		F90-TPKN22-D80Z6S27-WOC	0623	80	6	-	50		27	25	58	-	-	X
		F90-TPKN22-D100Z7S32-WOC	0624	100	7	-	50		32	26	65	-	-	X
		F90-TPKN22-D125Z8S40-WOC	0625	125	8	-	63		40	32	80	-	-	X
		F90-TPKN22-D160Z9S40-WOC	0626	160	9	-	63		40	32	110	66.7	-	X
		F90-TPKN22-D200Z12S60-WOC	0627	200	12	-	63		60	40	130	101.6	-	X
		F90-TPKN22-D250Z15S60-WOC	0628	250	15	-	63		60	40	160	101.6	-	X
		F90-TPKN22-D315Z18S60-WOC	0629	315	18	-	63		60	40	220	101.6	177.8	X

Milling - Shoulder Milling - Inserts
ADKT / AOMT - Shoulder Milling Positive (2 Corner)

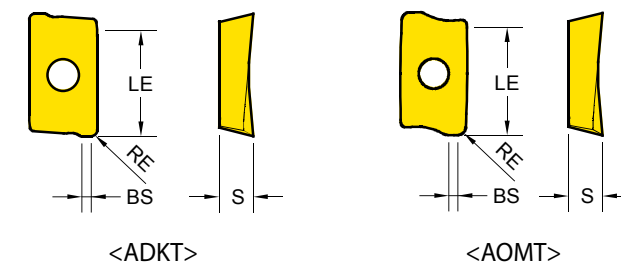

Series	LE	IC	S
ADKT 1505	13.7	9.7	5.8
AOMT 1236	10.5	6.6	3.6

EDP 1200..
 ●: Stock item ○: Order made item

P25	P30	P20	P30	P40	K15	K15
M30	K30	M40	H15	K15		
S20						

ADKT	Designation	RE (mm)	Fz (mm/tooth)	BS (mm)	YG602	YG622	YG712	YG713	YG613	YG501	YG5020
ADKT General	ADKT 150508 PDTR	0.8	0.16~0.30	1.87	● 0220						

AOMT	Designation	RE (mm)	Fz (mm/tooth)	BS (mm)	YG602	YG622	YG712	YG713	YG613	YG501	YG5020
AOMT General	AOMT 123604 PDTR	0.4	0.08~0.22	1.07	● 0217						
	AOMT 123608 PDTR	0.8	0.08~0.24	0.91	● 0218				● 0613		

Cutting Speed			Vc (m/min.)													
ISO	VDI	Sub Group	YG602		YG622		YG712		YG713		YG613		YG501		YG5020	
			Min	Max	Min	Max	Min	Max	Min	Max	Min	Max	Min	Max		
P	1-5	Non-Alloyed Steel	180	380	140	400	170	300	200	300	100	210	-	-	-	-
	6-9	Low-Alloyed Steel	120	300	120	320	180	250	170	270	70	180	-	-	-	-
	10-11	High-Alloyed Steel	70	150	70	170	100	140	85	145	40	90	-	-	-	-
M	12-13	Ferritic & Martensitic	120	200	-	-	-	-	-	-	70	180	-	-	-	-
	14	Austenitic Stainless Steel	130	250	-	-	-	-	-	-	70	200	-	-	-	-
K	15-16	Grey Cast Iron	120	250	120	270	-	-	-	-	-	-	160	300	200	350
	17-18	Nodular Cast Iron	130	220	130	240	-	-	-	-	-	-	130	210	150	300
N	21-30	Non-Ferrous Metals (Al)	-	-	-	-	-	-	-	-	-	-	-	-	-	-
S	31-37	Superalloys & Titanium	25	45	-	-	-	-	-	-	-	-	-	-	-	-
H	38-41	Hard Materials	40	80	40	100	-	-	-	-	-	-	-	-	-	-

Milling - Shoulder Milling - Inserts

APKT - Shoulder Milling Positive (2 Corner)

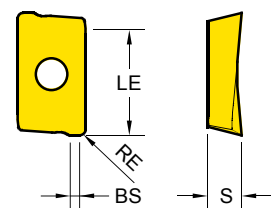

Series	LE	IC	S
APKT 1003	9.9	6.7	3.6
APKT 1604	15.2	9.4	5.3

EDP 1200..

●: Stock item ○: Order made item

P25	P30	P20	P30	P40	K15	K15
M30				M40	H15	K15
K30	K30					
S20						

APKT	Designation	RE (mm)	Fz (mm/tooth)	BS (mm)	EDP 1200..								
					YG602	YG622	YG712	YG713	YG613	YG501	YG5020		
APKT General	APKT 100305 PDTR	0.5	0.15~0.24	0.86	●	○		●	●				
	APKT 100308 PDTR	0.8	0.15~0.24	0.90	●	○		●	●				
	APKT 160404 PDTR	0.4	0.15~0.25	1.11	●			●					
	APKT 160408 PDTR	0.8	0.15~0.30	1.32	●			●	●				
	APKT 160412 PDTR	1.2	0.15~0.32	1.13	●			●					
	APKT 160416 PDTR	1.6	0.15~0.34	1.13	●			●					
	APKT 160424 PDTR	2.4	0.15~0.38		●			●					
-ST Stainless Steel Super Alloy	APKT 100305 -ST	0.5	0.08~0.22	0.86	●					●			
	APKT 160408 -ST	0.8	0.08~0.25	1.32	●					●			
-TR Hardened Steel	APKT 160404 -TR	0.4	0.26~0.40	2.12	●	○							
	APKT 160408 -TR	0.8	0.26~0.40	1.32	●	○		●					
	APKT 160412 -TR	1.2	0.26~0.40	2.40	●	○							
	APKT 160416 -TR	1.6	0.26~0.40	2.40	●	○							
	APKT 160424 -TR	2.4	0.26~0.40	1.50	●	○							

Milling - Shoulder Milling - Inserts

APMT - Shoulder Milling Positive (2 Corner)

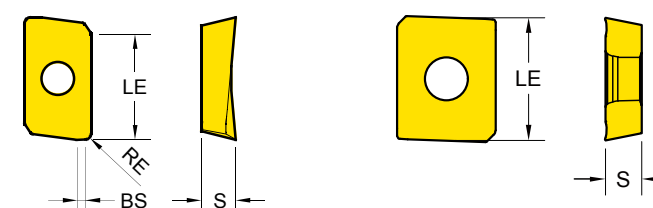

Series	LE	IC	S
APMT 1135	9.5	6.2	3.50
APMT 1604	14.6	9.2	4.76
APMT 1504	14.0	12.7	4.76

EDP 1200..

●: Stock item ○: Order made item

P25	P30	P20	P30	P40	K15	K15
M30				M40	H15	K15
K30	K30					
S20						

APMT	Designation	RE (mm)	Fz (mm/tooth)	BS (mm)	EDP 1200..								
					YG602	YG622	YG712	YG713	YG613	YG501	YG5020		
APMT General	APMT 113504 PDTR	0.4	0.15~0.22	1.26	●	○		●					
	APMT 113508 PDTR	0.8	0.15~0.25	1.07	●			●	●				
	APMT 160408 PDTR	0.8	0.16~0.30	1.11	●	○	●	●	●	●			
APMT 1504 General	APMT 1504		0.14~0.28		●	○							

ISO	VDI	Sub Group	Cutting Speed Vc (m/min.)													
			YG602		YG622		YG712		YG713		YG613		YG501		YG5020	
			Min	Max	Min	Max	Min	Max	Min	Max	Min	Max	Min	Max	Min	Max
P	1~5	Non-Alloyed Steel	180	380	140	400	170	300	200	300	100	210	-	-	-	-
	6~9	Low-Alloyed Steel	120	300	120	320	180	250	170	270	70	180	-	-	-	-
	10~11	High-Alloyed Steel	70	150	70	170	100	140	85	145	40	90	-	-	-	-
M	12~13	Ferritic & Martensitic	120	200	-	-	-	-	-	-	70	180	-	-	-	-
	14	Austenitic Stainless Steel	130	250	-	-	-	-	-	-	70	200	-	-	-	-
K	15~16	Grey Cast Iron	120	250	120	270	-	-	-	-	160	300	200	350	-	
	17~18	Nodular Cast Iron	130	220	130	240	-	-	-	-	130	210	150	300	-	
N	21~30	Non-Ferrous Metals (Al)	-	-	-	-	-	-	-	-	-	-	-	-	-	
S	31~37	Superalloys & Titanium	25	45	-	-	-	-	-	-	-	-	-	-	-	
H	38~41	Hard Materials	40	80	40	100	-	-	-	-	-	-	-	-	-	

ISO	VDI	Sub Group	Cutting Speed Vc (m/min.)													
			YG602		YG622		YG712		YG713		YG613		YG501		YG5020	
			Min	Max	Min	Max	Min	Max	Min	Max	Min	Max	Min	Max	Min	Max
P	1~5	Non-Alloyed Steel	180	380	140	400	170	300	200	300	100	210	-	-	-	-
	6~9	Low-Alloyed Steel	120	300	120	320	180	250	170	270	70	180	-	-	-	-
	10~11	High-Alloyed Steel	70	150	70	170	100	140	85	145	40	90	-	-	-	-
M	12~13	Ferritic & Martensitic	120	200	-	-	-	-	-	-	70	180	-	-	-	-
	14	Austenitic Stainless Steel	130	250	-	-	-	-	-	-	70	200	-	-	-	-
K	15~16	Grey Cast Iron	120	250	120	270	-	-	-	-	160	300	200	350	-	
	17~18	Nodular Cast Iron	130	220	130	240	-	-	-	-	130	210	150	300	-	
N	21~30	Non-Ferrous Metals (Al)	-	-	-	-	-	-	-	-	-	-	-	-	-	
S	31~37	Superalloys & Titanium	25	45	-	-	-	-	-	-	-	-	-	-	-	
H	38~41	Hard Materials	40	80	40	100	-	-	-	-	-	-	-	-	-	

Milling - Shoulder Milling - Inserts

APXT - Shoulder Milling Positive (2 Corner)

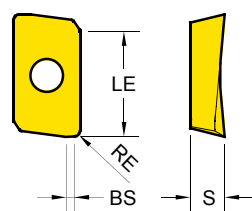

Series	LE	IC	S
APXT 1135	9.5	6.20	3.58
APXT 1604	14.6	9.2	4.8

EDP 1200..

●: Stock item ○: Order made item

P25	P30	P20	P30	P40	K15	N15
M30				M40		
K30	K30					
S20						

APXT	Designation	RE (mm)	Fz (mm/tooth)	BS (mm)	EDP 1200..							
					YG602	YG622	YG712	YG713	YG613	YG5020	YG50	
-AL Aluminium	APXT 113508-AL	0.8	0.05~0.30	1.52							●	0605
	APXT 160408-AL	0.8	0.10~1.30	1.75							●	0528



Milling - Shoulder Milling - Inserts

TPKN / KR / CN - Shoulder Milling Positive (3 Corner ISO)

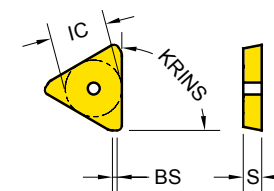

Series	KRINS	IC	S
TP** 1603	90°	9.53	3.18
TP** 2204	90°	12.70	4.76

EDP 1200..

●: Stock item ○: Order made item

P25	P30	P20	P30	P40	K15	K15
M30				M40	H15	
K30	K30					
S20						

TPKR TPKN TPCN	Designation	RE (mm)	Fz (mm/tooth)	BS (mm)	EDP 1200..							
					YG602	YG622	YG712	YG713	YG613	YG501	YG5020	
TPKR General	TPKR 1603 PDTR		0.15~0.28	1.2	●						●	0690
	TPKR 1603 PDTR-PW		0.11~0.20	1.2	●							
	TPKR 2204 PDTR		0.18~0.35	1.7	●						●	0715
TPKN Hard Materials	TPKR 2204 PDTR-PW		0.18~0.35	1.7	●							
	TPKN 1603 PDTR		0.15~0.30	1.2	●							
	TPKN 1603 PDTR-GW		0.15~0.30	1.6	●							
	TPKN 1603 PDTR-PW		0.15~0.28	1.2	●							
	TPKN 2204 PDTR		0.17~0.30	1.7	●							
	TPKN 2204 PDTR-GW		0.24~0.40	2.5	●							
TPCN Ground insert	TPKN 2204 PDTR-PW		0.24~0.40	1.7	●							
	TPCN 2204 PDSR-M		0.05~0.20	1.76						●	0180	
	TPCN 2204 PDSR-MR		0.05~0.20	1.76						●	0202	

- PW : for Improved Surface Roughness
- GW : Ground Wiper
- M : for Mold & Die
- MR : for Mold & Die Roughing

ISO	VDI	Sub Group	Cutting Speed Vc (m/min.)													
			YG602		YG622		YG712		YG713		YG613		YG5020		YG50	
			Min	Max	Min	Max	Min	Max	Min	Max	Min	Max	Min	Max	Min	Max
P	1~5	Non-Alloyed Steel	180	380	140	400	170	300	200	300	100	210	-	-	-	-
	6~9	Low-Alloyed Steel	120	300	120	320	180	250	170	270	70	180	-	-	-	-
	10~11	High-Alloyed Steel	70	150	70	170	100	140	85	145	40	90	-	-	-	-
M	12~13	Ferritic & Martensitic	120	200	-	-	-	-	-	-	70	180	-	-	-	-
	14	Austenitic Stainless Steel	130	250	-	-	-	-	-	-	70	200	-	-	-	-
K	15~16	Grey Cast Iron	120	250	120	270	-	-	-	-	200	350	-	-	-	-
	17~18	Nodular Cast Iron	130	220	130	240	-	-	-	-	150	300	-	-	-	-
N	21~30	Non-Ferrous Metals (Al)	-	-	-	-	-	-	-	-	-	-	300	800	-	-
S	31~37	Superalloys & Titanium	25	45	-	-	-	-	-	-	-	-	-	-	-	-
H	38~41	Hard Materials	40	80	40	100	-	-	-	-	-	-	-	-	-	-

ISO	VDI	Sub Group	Cutting Speed Vc (m/min.)													
			YG602		YG622		YG712		YG713		YG613		YG501		YG5020	
			Min	Max	Min	Max	Min	Max	Min	Max	Min	Max	Min	Max	Min	Max
P	1~5	Non-Alloyed Steel	180	380	140	400	170	300	200	300	100	210	-	-	-	-
	6~9	Low-Alloyed Steel	120	300	120	320	180	250	170	270	70	180	-	-	-	-
	10~11	High-Alloyed Steel	70	150	70	170	100	140	85	145	40	90	-	-	-	-
M	12~13	Ferritic & Martensitic	120	200	-	-	-	-	-	-	70	180	-	-	-	-
	14	Austenitic Stainless Steel	130	250	-	-	-	-	-	-	70	200	-	-	-	-
K	15~16	Grey Cast Iron	120	250	120	270	-	-	-	-	160	300	200	350	-	-
	17~18	Nodular Cast Iron	130	220	130	240	-	-	-	-	130	210	150	300	-	-
N	21~30	Non-Ferrous Metals (Al)	-	-	-	-	-	-	-	-	-	-	-	-	-	-
S	31~37	Superalloys & Titanium	25	45	-	-	-	-	-	-	-	-	-	-	-	-
H	38~41	Hard Materials	40	80	40	100	-	-	-	-	-	-	-	-	-	-

Milling - Shoulder Milling - Inserts

TPUN - Universal Positive (3 Corners ISO)

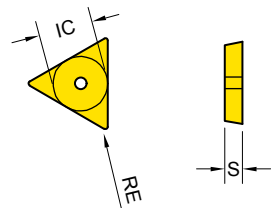

Series	IC	S
TPUN 1603	9.53	3.18

EDP 1200..

●: Stock item ○: Order made item

P25	P30	P20	P30	P40	K15	K15
M30				M40	H15	
K30	K30					
S20						

TPUN	Designation	RE (mm)	Fz (mm/tooth)	BS (mm)	YG602	YG622	YG712	YG713	YG613	YG501	YG5020
	TPUN 160308	0.8	0.08~0.15		●						
					○						



MILLING

DRILLING

TECHNICAL INFORMATION

Cutting Speed			Vc (m/min.)													
ISO	VDI	Sub Group	YG602		YG622		YG712		YG713		YG613		YG501		YG5020	
			Min	Max	Min	Max	Min	Max	Min	Max	Min	Max	Min	Max	Min	Max
P	1~5	Non-Alloyed Steel	180	380	140	400	170	300	200	300	100	210	-	-	-	-
	6~9	Low-Alloyed Steel	120	300	120	320	180	250	170	270	70	180	-	-	-	-
	10~11	High-Alloyed Steel	70	150	70	170	100	140	85	145	40	90	-	-	-	-
M	12~13	Ferritic & Martensitic	120	200	-	-	-	-	-	-	70	180	-	-	-	-
	14	Austenitic Stainless Steel	130	250	-	-	-	-	-	-	70	200	-	-	-	-
K	15~16	Grey Cast Iron	120	250	120	270	-	-	-	-	-	-	160	300	200	350
	17~18	Nodular Cast Iron	130	220	130	240	-	-	-	-	-	-	130	210	150	300
N	21~30	Non-Ferrous Metals (Al)	-	-	-	-	-	-	-	-	-	-	-	-	-	-
S	31~37	Superalloys & Titanium	25	45	-	-	-	-	-	-	-	-	-	-	-	-
H	38~41	Hard Materials	40	80	40	100	-	-	-	-	-	-	-	-	-	-

Milling - Profiling - Cutter

Cutters for RDKT, RDKW

Round Positive

<S> Shell Mill

<W> Weldon

<C> Cylindrical

<M> Modular

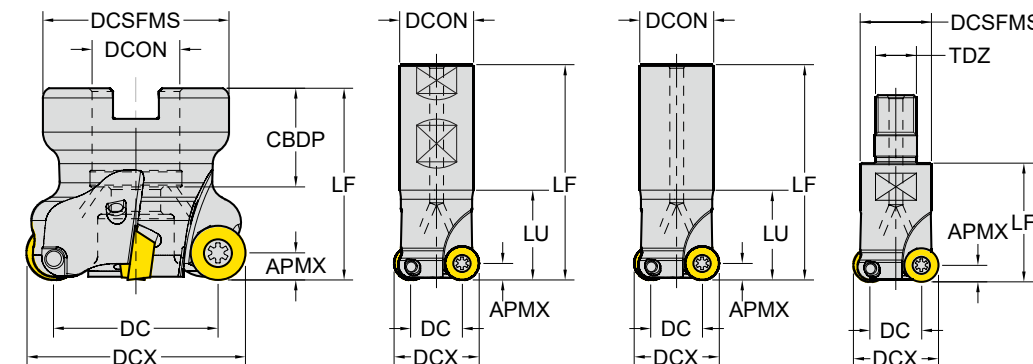

ZAFP : Effective Number of Cutting Edges
CDBP : Connection Bore Depth

□: p. 145 Unit : mm

Series	APMX	Designation	EDP 1700..	DC	DCX	ZAFP	LU	LF	TYPE	DCON / TDZ	CDBP	DCSFMS	●
RDKT RDKW 0802	4.0	E - RDKT08 - D16Z2C16 - L160	0005	8	16	2	-	160	Cylindrical	16	-	-	●
		E - RDKT08 - D20Z2C20 - L180	0007	12	20	2	-	180		20	-	-	●
		E - RDKT08 - D25Z3C20 - L180	0009	17	25	3	-	180		20	-	-	●
		M - RDKT08 - D16Z2M08	0010	8	16	2	-	23	Modular	M08	-	13	●
		M - RDKT08 - D20Z2M10	0011	12	20	2	-	30		M10	-	18	●
		M - RDKT08 - D25Z3M12	0012	17	25	3	-	35	M12	-	21	●	
RDKT RDKW 10T3	5.0	E - RDKT10 - D20Z2C20 - L150 - WOC	0576	10	20	2	60	150	Cylindrical	20	-	-	X
		E - RDKT10 - D20Z2C20 - L180	0013	10	20	2	-	180		20	-	-	●
		E - RDKT10 - D25Z2C25 - L150 - WOC	0299	15	25	2	60	150		25	-	-	X
		E - RDKT10 - D25Z2C25 - L180	0015	15	25	2	-	180		25	-	-	●
		E - RDKT10 - D20Z2W20 - L150 - WOC	0577	10	20	2	60	150	Weldon	20	-	-	X
		E - RDKT10 - D25Z2W25 - L150 - WOC	0578	15	25	2	60	150		25	-	-	X
		E - RDKT10 - D32Z3W32 - L150 - WOC	0579	22	32	3	60	150	Shellmill	32	-	-	X
		F - RDKT10 - D40Z5S16	0019	30	40	5	-	40		16	18	34	●
		F - RDKT10 - D50Z5S22	0580	40	50	5	-	50		22	22	42	●
		F - RDKT10 - D50Z6S22	0020	40	50	6	-	50		22	22	42	●
		F - RDKT10 - D63Z6S22	0581	53	63	6	-	50	22	22	48	●	
		M - RDKT10 - D20Z2M10	0017	10	20	2	-	30	Modular	M10	-	18	●
		M - RDKT10 - D25Z3M12	0018	15	25	3	-	35		M12	-	21	●

Milling - Profiling - Cutter
Cutters for RDKT, RDKW

Round Positive

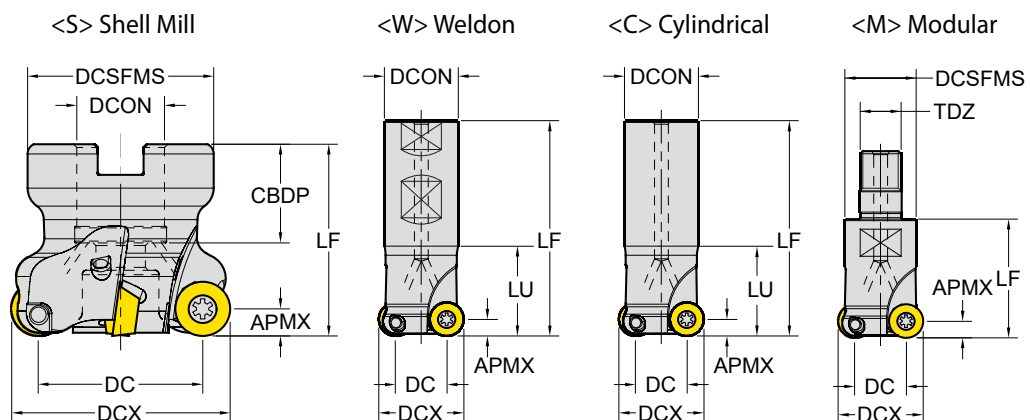

ZEFP : Effective Number of Cutting Edges
CDBP : Connection Bore Depth

p. 145 Unit : mm

Series	APMX	Designation	EDP 1700..	DC	DCX	ZEFP	LU	LF	TYPE	DCON /TDZ	CDBP	DCSFMS	Material
RDKT RDKW 1204	6.0	E - RDKT12 - D25Z2C25 - L180	0021	13	25	2	80	180	Cylindrical	25	-	-	●
		E - RDKT12 - D32Z2C32 - L200	0023	20	32	2	60	200		32	-	-	●
		E - RDKT12 - D32Z3C32 - L160	0024	20	32	3	60	160		32	-	-	●
		E - RDKT12 - D32Z3C32 - L160 - WOC	0582	20	32	3	70	160		32	-	-	X
		E - RDKT12 - D33Z3C32 - L160 - WOC	0583	21	33	3	70	160		32	-	-	X
		E - RDKT12 - D32Z3W32 - L160 - WOC	0584	20	32	3	50	160	32	-	-	X	Weldon
		F - RDKT12 - D40Z4S16	0028	28	40	4	-	40	16	18	32	●	
		F - RDKT12 - D50Z5S22	0029	38	50	5	-	50	22	20	40	●	
		F - RDKT12 - D52Z5S22	0585	40	52	5	-	50	22	22	42	●	
		F - RDKT12 - D63Z6S22	0030	51	63	6	-	50	22	20	48	●	
		F - RDKT12 - D80Z7S27	0586	68	80	7	-	50	27	25	58	●	
		F - RDKT12 - D100Z7S32	0587	88	100	7	-	50	32	26	65	●	
F - RDKT12 - D100Z8S32	0588	88	100	8	-	50	32	26	65	●			
M - RDKT12 - D25Z2M12	0026	13	25	2	-	35	M12	-	21	●	Modular		
M - RDKT12 - D32Z3M16	0027	20	32	3	-	42	M16	-	29	●			
M - RDKT12 - D42Z4M16	0589	30	42	4	-	43	M16	-	29	●			

Milling - Profiling - Inserts
RDKT / W - Profiling Positive (Round)

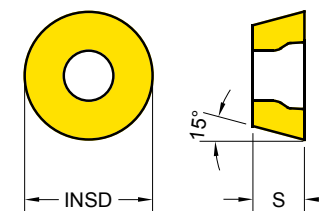

Series	INSD	S	Series	INSD	S
RDK* 0501	5	1.4	RDK* 10T3	10	4.0
RDK* 0702	7	2.4	RDK* 1204	12	4.8
RDK* 0802	8	2.4			

EDP 1200..
● : Stock item ○ : Order made item

P25	P30	P20	P30	P40	K15	K15
M30	K30	M40	H15			
S20						

RDKT / RDKW	Designation	Fz (mm/tooth)	YG602	YG622	YG712	YG713	YG613	YG501	YG5020
RDKT General	RDKT 0802M0	0.15 ~ 0.25	●						
	RDKT 10T3M0	0.15 ~ 0.28	●						
	RDKT 1204M0	0.20 ~ 0.30	●			●			
-ST Stainless Steel Super Alloy	RDKT 1604M0	0.30 ~ 0.60	●						
	RDKT 0802M0 - ST	0.08 ~ 0.25	●						
	RDKT 10T3M0 - ST	0.08 ~ 0.28	●				●		
-TR Hardened Steel	RDKT 1204M0 - ST	0.10 ~ 0.30	●				●		
	RDKT 0802M0 - TR	0.18 ~ 0.35	●	○					
	RDKT 10T3M0 - TR	0.22 ~ 0.40	●	○			●		
RDKW Hard Materials	RDKT 1204M0 - TR	0.22 ~ 0.40	●	○			●		
	RDKW 0501M0	0.10 ~ 0.20	●	○					
	RDKW 0702M0	0.12 ~ 0.25	●	○			●		
	RDKW 0802M0	0.13 ~ 0.25	●	○					
	RDKW 10T3M0	0.16 ~ 0.30	●	○					
	RDKW 1204M0	0.16 ~ 0.35	●	○			●		

ISO	VDI	Sub Group	Cutting Speed Vc (m/min.)													
			YG602		YG622		YG712		YG713		YG613		YG501		YG5020	
P	1-5	Non-Alloyed Steel	180	380	140	400	170	300	200	300	100	210	-	-	-	-
	6-9	Low-Alloyed Steel	120	300	120	320	180	250	170	270	70	180	-	-	-	-
	10-11	High-Alloyed Steel	70	150	70	170	100	140	85	145	40	90	-	-	-	-
M	12-13	Ferritic & Martensitic	120	200	-	-	-	-	-	-	70	180	-	-	-	-
	14	Austenitic Stainless Steel	130	250	-	-	-	-	-	-	70	200	-	-	-	-
K	15-16	Grey Cast Iron	120	250	120	270	-	-	-	-	-	160	300	200	350	
	17-18	Nodular Cast Iron	130	220	130	240	-	-	-	-	-	130	210	150	300	
N	21-30	Non-Ferrous Metals (Al)	-	-	-	-	-	-	-	-	-	-	-	-	-	
S	31-37	Superalloys & Titanium	25	45	-	-	-	-	-	-	-	-	-	-	-	
H	38-41	Hard Materials	40	80	40	100	-	-	-	-	-	-	-	-	-	

Milling - Profiling - Inserts
RDMT / W - Profiling Positive (Round)

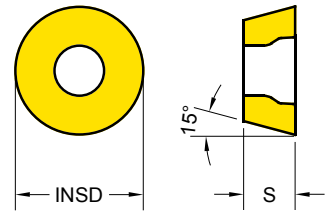

Series	INSD	S	Series	INSD	S
RDM* 0802	8	2.38	RDM* 10T3	10	3.97
RDM* 0803	8	3.18	RDM* 1204	12	4.76

EDP 1200..
 ●: Stock item ○: Order made item

P25	P30	P20	P30	P40	K15	K15
M30				M40	H15	
K30	K30					
S20						

	RDMT RDMW	Designation	Fz (mm/tooth)	EDP 1200..						
				YG602	YG622	YG712	YG713	YG613	YG501	YG5020
RDMT General		RDMT 0802M0	0.15 ~ 0.25	●						
		RDMT 0803M0	0.15 ~ 0.25	●						
		RDMT 10T3M0	0.18 ~ 0.28	●						
		RDMT 1204M0	0.2 ~ 0.3	●						
RDMW Hard Materials		RDMW 0802M0	0.05 ~ 0.15	●						
		RDMW 10T3M0	0.1 ~ 0.25	●						
		RDMW 1204M0	0.16 ~ 0.3	●						

EDP 1200..
 ●: Stock item ○: Order made item

P25	P30	P20	P30	P40	K15	K15
M30				M40	H15	
K30	K30					
S20						

Milling - Profiling - Inserts
RPMT / W - Profiling Positive (Round)

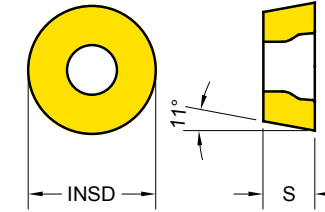

Series	INSD	S	Series	INSD	S
RPM* 08T2	8	2.78	RPM* 10T3	10	3.97
RPM* 1003	10	3.18	RPM* 1204	12	4.76

	RPMT RPMW	Designation	Fz (mm/tooth)	EDP 1200..						
				YG602	YG622	YG712	YG713	YG613	YG501	YG5020
RPMT General		RPMT 08T2M0	0.10 ~ 0.24	●			●	●		
		RPMT 10T3M0	0.16 ~ 0.30	●			●	●		
		RPMT 1204M0	0.20 ~ 0.35	●	○	●	●	●	●	
-ST Stainless Steel Super Alloy		RPMT 1204M0 - ST	0.10 ~ 0.30	●				●		
RPMW Hard Materials		RPMW 1003M0	0.16 ~ 0.30	●	○		●			
		RPMW 1204M0	0.16 ~ 0.35	●			●			

Cutting Speed			Vc (m/min.)													
ISO	VDI	Sub Group	YG602		YG622		YG712		YG713		YG613		YG501		YG5020	
			Min	Max	Min	Max	Min	Max	Min	Max	Min	Max	Min	Max	Min	Max
P	1~5	Non-Alloyed Steel	180	380	140	400	170	300	200	300	100	210	-	-	-	-
	6~9	Low-Alloyed Steel	120	300	120	320	180	250	170	270	70	180	-	-	-	-
	10~11	High-Alloyed Steel	70	150	70	170	100	140	85	145	40	90	-	-	-	-
M	12~13	Ferritic & Martensitic	120	200	-	-	-	-	-	-	70	180	-	-	-	-
	14	Austenitic Stainless Steel	130	250	-	-	-	-	-	-	70	200	-	-	-	-
K	15~16	Grey Cast Iron	120	250	120	270	-	-	-	-	-	160	300	200	350	
	17~18	Nodular Cast Iron	130	220	130	240	-	-	-	-	-	130	210	150	300	
N	21~30	Non-Ferrous Metals (Al)	-	-	-	-	-	-	-	-	-	-	-	-	-	
S	31~37	Superalloys & Titanium	25	45	-	-	-	-	-	-	-	-	-	-	-	
H	38~41	Hard Materials	40	80	40	100	-	-	-	-	-	-	-	-	-	

Cutting Speed			Vc (m/min.)													
ISO	VDI	Sub Group	YG602		YG622		YG712		YG713		YG613		YG501		YG5020	
			Min	Max	Min	Max	Min	Max	Min	Max	Min	Max	Min	Max	Min	Max
P	1~5	Non-Alloyed Steel	180	380	140	400	170	300	200	300	100	210	-	-	-	-
	6~9	Low-Alloyed Steel	120	300	120	320	180	250	170	270	70	180	-	-	-	-
	10~11	High-Alloyed Steel	70	150	70	170	100	140	85	145	40	90	-	-	-	-
M	12~13	Ferritic & Martensitic	120	200	-	-	-	-	-	-	70	180	-	-	-	-
	14	Austenitic Stainless Steel	130	250	-	-	-	-	-	-	70	200	-	-	-	-
K	15~16	Grey Cast Iron	120	250	120	270	-	-	-	-	-	160	300	200	350	
	17~18	Nodular Cast Iron	130	220	130	240	-	-	-	-	-	130	210	150	300	
N	21~30	Non-Ferrous Metals (Al)	-	-	-	-	-	-	-	-	-	-	-	-	-	
S	31~37	Superalloys & Titanium	25	45	-	-	-	-	-	-	-	-	-	-	-	
H	38~41	Hard Materials	40	80	40	100	-	-	-	-	-	-	-	-	-	

Milling - Profiling - Inserts

RBEX50 - Profiling / Highfeed (3 Corner)

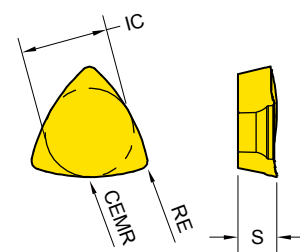

Series	CEMR	IC	S
RBEX50	25	12.7	5.55

EDP 1200..

●: Stock item ○: Order made item

P25	P30	P20	P30	P40	K15	K15
M30				M40	H15	
K30	K30					
S20						

RBEX50	Designation	RE (mm)	Fz (mm/tooth)	YG602	YG622	YG712	YG713	YG613	YG501	YG5020
General	RBEX 50	1.2	0.2~0.4	○ 0277	○ 0443					



RBEX50
General

Cutting Speed			Vc (m/min.)													
ISO	VDI	Sub Group	YG602		YG622		YG712		YG713		YG613		YG501		YG5020	
			Min	Max	Min	Max	Min	Max	Min	Max	Min	Max	Min	Max	Min	Max
P	1~5	Non-Alloyed Steel	180	380	140	400	170	300	200	300	100	210	-	-	-	-
	6~9	Low-Alloyed Steel	120	300	120	320	180	250	170	270	70	180	-	-	-	-
	10~11	High-Alloyed Steel	70	150	70	170	100	140	85	145	40	90	-	-	-	-
M	12~13	Ferritic & Martensitic	120	200	-	-	-	-	-	-	70	180	-	-	-	-
	14	Austenitic Stainless Steel	130	250	-	-	-	-	-	-	70	200	-	-	-	-
K	15~16	Grey Cast Iron	120	250	120	270	-	-	-	-	-	-	160	300	200	350
	17~18	Nodular Cast Iron	130	220	130	240	-	-	-	-	-	-	130	210	150	300
N	21~30	Non-Ferrous Metals (Al)	-	-	-	-	-	-	-	-	-	-	-	-	-	-
S	31~37	Superalloys & Titanium	25	45	-	-	-	-	-	-	-	-	-	-	-	-
H	38~41	Hard Materials	40	80	40	100	-	-	-	-	-	-	-	-	-	-

Milling - High Feed Milling - Cutter

Cutters for ENMX

Cutting Angle : 10°
4 Corner Negative

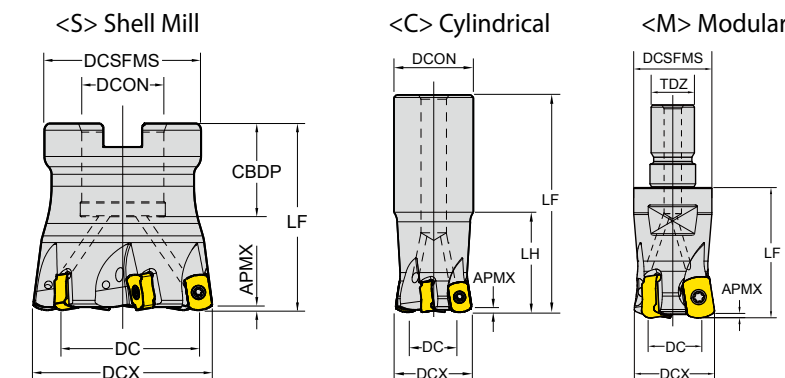

ZEFP : Effective Number of Cutting Edges
CDBP : Connection Bore Depth

□: p. 152 Unit : mm

Series	APMX	Designation	EDP 1700..	DC	DCX	ZEFP	LF	Type	DCON /TDZ	LH	CDBP	DCSFS	●
ENMX 0604	0.9	EHF-ENMX06-D16Z2C16-L100	0644	9.0	16	2	100	Cylindrical	16	30	-	-	●
		EHF-ENMX06-D16Z2C16-L150	0645	9.0	16	2	150		16	50	-	-	●
		EHF-ENMX06-D17Z2C16-L100	0674	10.0	17	2	100		16	20	-	-	●
		EHF-ENMX06-D17Z2C16-L150	0473	10.0	17	2	150		16	20	-	-	●
	1	Cylindrical	EHF-ENMX06-D20Z3C20-L130	0463	12.6	20	3	130	20	50	-	-	●
			EHF-ENMX06-D20Z3C20-L160	0646	12.6	20	3	160	20	80	-	-	●
			EHF-ENMX06-D21Z3C20-L150	0475	13.6	21	3	150	20	20	-	-	●
			EHF-ENMX06-D21Z3C20-L200	0476	13.6	21	3	200	20	20	-	-	●
			EHF-ENMX06-D25Z4C25-L140	0647	17.6	25	4	140	25	60	-	-	●
			EHF-ENMX06-D25Z4C25-L180	0464	17.6	25	4	180	25	80	-	-	●
			EHF-ENMX06-D25Z4C25-L250	0648	17.6	25	4	250	25	120	-	-	●
			EHF-ENMX06-D26Z4C25-L150	0479	18.6	26	4	150	25	30	-	-	●
			EHF-ENMX06-D26Z4C25-L200	0480	18.6	26	4	200	25	30	-	-	●
			EHF-ENMX06-D32Z5C32-L150	0649	24.6	32	5	150	32	70	-	-	●
EHF-ENMX06-D32Z5C32-L200	0465	24.6	32	5	200	32	100	-	-	●			
0.9	Modular	MHF-ENMX06-D16Z2M08	0691	9.0	16	2	23	M08	-	-	13	●	
		MHF-ENMX06-D18Z2M08	0730	11.0	18	2	23	M08	-	-	13	●	
		MHF-ENMX06-D20Z3M10	0692	12.6	20	3	30	M10	-	-	18	●	
		MHF-ENMX06-D25Z4M12	0693	17.6	25	4	35	M12	-	-	21	●	
		MHF-ENMX06-D32Z5M16	0694	24.6	32	5	42	M16	-	-	29	●	
		MHF-ENMX06-D35Z5M16	0695	27.6	35	5	42	M16	-	-	29	●	
1	Modular	MHF-ENMX06-D40Z6M16	0732	32.6	40	6	42	M16	-	-	29	●	
		MHF-ENMX06-D42Z6M16	0696	34.6	42	6	42	M16	-	-	29	●	
		FHF-ENMX06-D40Z6S16	0482	32.6	40	6	40	Shell Mill	16	-	18	37	●
		FHF-ENMX06-D50Z6S22	0471	42.6	50	6	50		22	-	25	42	●

Milling - High Feed Milling - Cutter
Cutters for ENMX

Cutting Angle : 10°
4 Corner Negative

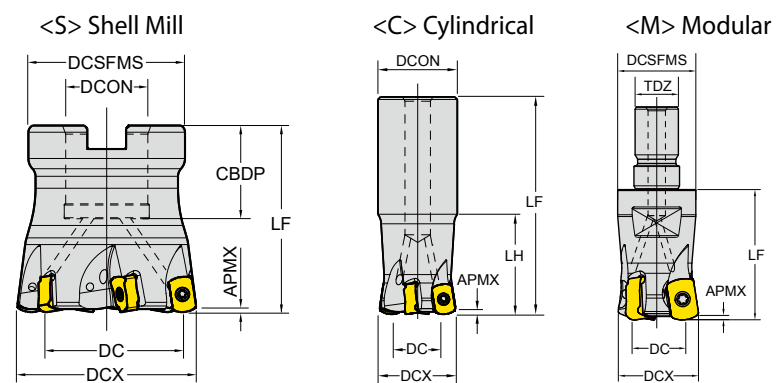

ZEFP : Effective Number of Cutting Edges
CBDP : Connection Bore Depth

Unit : mm

Series	APMX	Designation	EDP 1700..	DC	DCX	ZEFP	LF	Type	DCON /TDZ	LH	CBDP	DCSFMS	Watermark
ENMX 0905	1.5	EHF-ENMX09-D25Z2C25-L150	0745	20	25	2	150	Cylindrical	25	70	-	-	●
		EHF-ENMX09-D26Z2C25-L200	0746	21	26	2	200		25	30	-	-	●
		EHF-ENMX09-D26Z3C25-L200	0747	21	26	3	200		25	30	-	-	●
		EHF-ENMX09-D32Z3C32-L160	0748	27	32	3	160		32	70	-	-	●
		EHF-ENMX09-D33Z3C32-L200	0749	28	33	3	200		32	30	-	-	●
		EHF-ENMX09-D33Z4C32-L200	0750	28	33	4	200		32	40	-	-	●
	EHF-ENMX09-D40Z5C32-L180	0751	35	40	5	180	32	40	-	-	●		
	1.5	FHF-ENMX09-D50Z3S22	0820	45	50	3	50	Shell Mill	22	-	20	42	●
		FHF-ENMX09-D50Z4S22	0821	45	50	4	50		22	-	20	42	●
		FHF-ENMX09-D50Z5S22	0752	45	50	5	50		22	-	20	42	●
		FHF-ENMX09-D63Z4S22	0822	57	63	4	50		22	-	20	48	●
		FHF-ENMX09-D63Z5S22	0823	57	63	5	50		22	-	20	48	●
		FHF-ENMX09-D63Z6S22	0753	57	63	6	50		22	-	20	48	●
		FHF-ENMX09-D63Z7S22	0754	57	63	7	50		22	-	20	48	●
		FHF-ENMX09-D80Z8S27	0755	74	80	8	50		27	-	23	56	●
		FHF-ENMX09-D100Z10S32	0824	84	100	10	63		32	-	26	78	●
		FHF-ENMX09-D125Z12S40	0825	109	125	12	63		40	-	28	89	●

Milling - High Feed Milling - Cutter
Cutters for SDMT, SDMW

Cutting Angle : 10°
4 Corner Positive

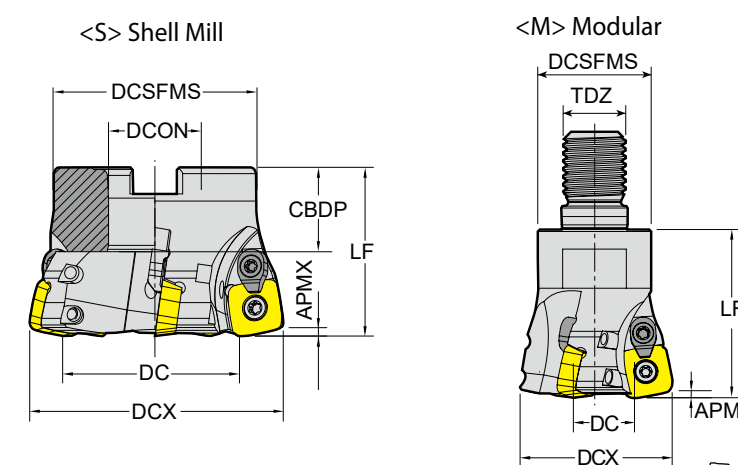

ZEFP : Effective Number of Cutting Edges
CBDP : Connection Bore Depth

Unit : mm

Series	APMX	Designation	EDP 1700..	DC	DCX	ZEFP	LF	TYPE	DCON /TDZ	CBDP	DCSFMS	Watermark
SDMT SDMW 1204	1.8	FHF - SDMW12 - D50Z4S22	0604	32.4	50	4	40	Shellmill	22	22	42	●
		FHF - SDMW12 - D63Z5S22	0605	45.4	63	5	40		22	22	48	●
		FHF - SDMW12 - D80Z6S27	0606	62.4	80	6	50		27	25	58	●
		FHF - SDMW12 - D100Z8S32	0607	82.4	100	8	50		32	26	65	●
		MHF - SDMW12 - D32Z2M16	0608	14.4	32	2	43	Modular	M16	-	29	●
		MHF - SDMW12 - D40Z3M16	0609	22.4	40	3	43		M16	-	29	●



Click for the ENMX Catalog

Milling - High Feed Milling - Inserts
ENMX - High Feed Negative (4 Corners)

Series	IC	S
ENMX 0604	6.3	4.21
ENMX 0905	9.0	5.40

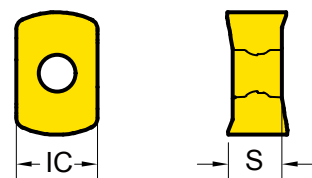

EDP 1200..

●: Stock item ○: Order made item

P25	P30	P20	P30	P40	K15	K15
M30				M40	H15	
K30	K30					
S20						

ENMX	Designation	RE (mm)	Fz (mm/tooth)	BS (mm)	YG602	YG622	YG712	YG713	YG613	YG501	YG5020
ENMX General	ENMX 0604		0.3 ~ 2.0		● 0474				● 0606		
	ENMX 0905		0.3 ~ 2.5		● 0702				● 0703		
-ST Stainless Steel	ENMX 0604-ST		0.1 ~ 0.8		● 0623				● 0625		
	ENMX 0905-ST		0.2 ~ 1.2		● 0705				● 0706		
-TR Hardened Steel	ENMX 0604-TR		0.3 ~ 2.5		● 0459		● 0504	● 0636			
	ENMX 0905-TR		0.3 ~ 3.0		● 0600						

Cutting Speed			Vc (m/min.)													
ISO	VDI	Sub Group	YG602		YG622		YG712		YG713		YG613		YG501		YG5020	
			Min	Max	Min	Max	Min	Max	Min	Max	Min	Max	Min	Max	Min	Max
P	1~5	Non-Alloyed Steel	180	380	140	400	170	300	200	300	100	210	-	-	-	-
	6~9	Low-Alloyed Steel	120	300	120	320	180	250	170	270	70	180	-	-	-	-
	10~11	High-Alloyed Steel	70	150	70	170	100	140	85	145	40	90	-	-	-	-
M	12~13	Ferritic & Martensitic	120	200	-	-	-	-	-	-	70	180	-	-	-	-
	14	Austenitic Stainless Steel	130	250	-	-	-	-	-	-	70	200	-	-	-	-
K	15~16	Grey Cast Iron	120	250	120	270	-	-	-	-	-	160	300	200	350	
	17~18	Nodular Cast Iron	130	220	130	240	-	-	-	-	-	130	210	150	300	
N	21~30	Non-Ferrous Metals (Al)	-	-	-	-	-	-	-	-	-	-	-	-	-	
S	31~37	Superalloys & Titanium	25	45	-	-	-	-	-	-	-	-	-	-	-	
H	38~41	Hard Materials	40	80	40	100	-	-	-	-	-	-	-	-	-	

Milling - High Feed Milling - Inserts
ENMX - High Feed Negative (4 Corners) Technical Information

ENMX 0604

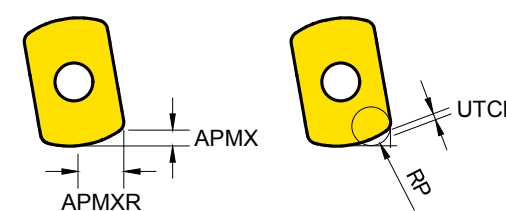

DCX Cutting Diameter Maximum	APMXR Radial AP Max	RP Programmed Corner R	UTCN Uncut Thickness	Overcut
16	3.5	R2.0	0.31	0.00
16~	3.7	R2.5	0.18	0.18
		R3.0	0.07	0.36



DCX External Cutter Diameter	APMX Maximum Depth of Cut	APMXR Maximum Radial Depth of Cut	RMPX Maximum Ramping Angle(°)	RP Programmed Corner Radius	UTCN Uncut Thickness	Diameter Minimum Cutting Diameter	Diameter Maximum Cutting Diameter	Pitch Helical Interpolation Pitch	Ae Enlarge Width
16	0.9	3.5	3.5°	R2.0	0.3	21	30	0.9	12.5
20	1	3.7	1.8°	R2.0	0.31	29	38	1	16.3
25	1	3.7	1.2°	R2.0	0.31	39	48	1	21.3
32	1	3.7	0.8°	R2.0	0.31	53	62	1	28.3
40	1	3.7	0.6°	R2.0	0.31	69	78	1	36.3
50	1	3.7	0.5°	R2.0	0.31	89	98	1	46.3

ENMX 0905

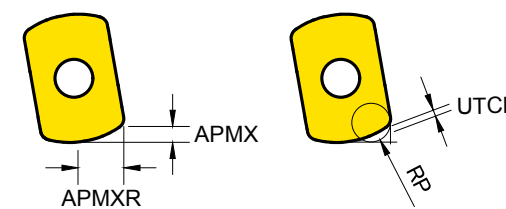

APMXR Radial AP Max	RP Programmed Corner R	UTCN Uncut Thickness	Overcut
4.7	R2.5	0.56	0
	R3.0	0.40	0.10
	R3.5	0.24	0.25
	R4.0	0.10	0.41
	R4.5	0	0.49



DCX External Cutter Diameter	APMX Maximum Depth of Cut	APMXR Maximum Radial Depth of Cut	RMPX Maximum Ramping Angle(°)	RP Programmed Corner Radius	UTCN Uncut Thickness	Diameter Minimum Cutting Diameter	Diameter Maximum Cutting Diameter	Pitch Helical Interpolation Pitch	Ae Enlarge Width
25	1.5	4.7	3.8°	2.5	0.56	42	48	1.5	20
26	1.5	4.7	3.5°	2.5	0.56	44	50	1.5	21
32	1.5	4.7	2.4°	2.5	0.56	56	62	1.5	27
33	1.5	4.7	2.2°	2.5	0.56	58	64	1.5	28
40	1.5	4.7	1.6°	2.5	0.56	72	78	1.5	35
50	1.5	4.7	1.1°	2.5	0.56	92	98	1.5	45
63	1.5	4.7	0.8°	2.5	0.56	118	124	1.5	57
80	1.5	4.7	0.6°	2.5	0.56	152	158	1.5	74

Milling - High Feed Milling - Inserts
SDMT / W - High Feed Positive (4 Corners)

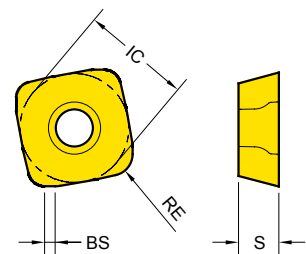

Series	IC	S
SDM* 1204	12.7	4.7

EDP 1200..

●: Stock item ○: Order made item

P25	P30	P20	P30	P40	K15	K15
M30				M40	H15	
K30	K30					
S20						

SDMT / SDM W	Designation	RE (mm)	Fz (mm/tooth)	BS (mm)	YG602	YG622	YG712	YG713	YG613	YG501	YG5020
-ST Stainless Steel Super Alloy	SDMT 120420-ST	1.9	0.60~1.20	1.45	● 0274				● 0666		
SDMW Hard Materials	SDMW 120420	1.9	0.60~1.40	1.4	● 0273	○ 0341		● 0634	● 0691		

Technical Information

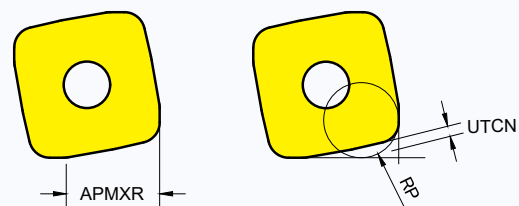

APMXR	RP	UTCN
Radial AP Max	Programmed Corner R	Uncut Thickness
8.6	R3.5	0.94

Cutting Speed			Vc (m/min.)													
ISO	VDI	Sub Group	YG602		YG622		YG712		YG713		YG613		YG501		YG5020	
			Min	Max	Min	Max	Min	Max	Min	Max	Min	Max	Min	Max	Min	Max
P	1~5	Non-Alloyed Steel	180	380	140	400	170	300	200	300	100	210	-	-	-	-
	6~9	Low-Alloyed Steel	120	300	120	320	180	250	170	270	70	180	-	-	-	-
	10~11	High-Alloyed Steel	70	150	70	170	100	140	85	145	40	90	-	-	-	-
M	12~13	Ferritic & Martensitic	120	200	-	-	-	-	-	-	70	180	-	-	-	-
	14	Austenitic Stainless Steel	130	250	-	-	-	-	-	-	70	200	-	-	-	-
K	15~16	Grey Cast Iron	120	250	120	270	-	-	-	-	-	160	300	200	350	
	17~18	Nodular Cast Iron	130	220	130	240	-	-	-	-	-	130	210	150	300	
N	21~30	Non-Ferrous Metals (Al)	-	-	-	-	-	-	-	-	-	-	-	-	-	
S	31~37	Superalloys & Titanium	25	45	-	-	-	-	-	-	-	-	-	-	-	
H	38~41	Hard Materials	40	80	40	100	-	-	-	-	-	-	-	-	-	

Milling - Modular Shank
Modular Shanks

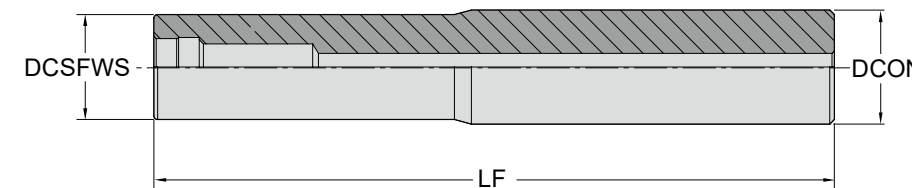

Series	Designation	EDP 1700..	DCSFWS	LF	TYPE	DCON	Unit:mm
M08	EM - M08 - D16ZC16 - L100	0634	13	100	Cylindrical	16	●
	EM - M08 - D16ZC16 - L130	0635	15	130		16	●
M10	EM - M10 - D20ZC20 - L130	0636	18	130	Cylindrical	20	●
	EM - M12 - D25ZC25 - L150	0637	25	150		25	●
M12	EM - M12 - D25ZC25 - L200	0638	23	200	Cylindrical	25	●
	EM - M12 - D25ZC25 - L250	0639	23	250		25	●
M16	EM - M16 - D32ZC32 - L150	0640	30	150	Cylindrical	32	●
	EM - M16 - D32ZC32 - L200	0641	30	200		32	●
	EM - M16 - D32ZC32 - L250	0642	30	250		32	●
	EM - M16 - D32ZC32 - L300	0643	30	300		32	●



DRILLING

Drilling Overview

Drill Holder

Drilling Inserts (SPMX)

Drilling Inserts (WCMX)

Drilling Overview

Drilling Grades

Drilling Grades	P Steel					M Stainless steel					K Cast iron				
	P05	P15	P25	P35	P45	M05	M15	M25	M35	M45	K05	K15	K25	K35	K45
PVD	YG602			602					602				602		
	YG713		713												
	YG613				613				613						

YG602 P20 - P35 M20 - M40 K20 - K40 S15 - S25	PVD - TiAlN 	Universal grade for General Drilling Application <ul style="list-style-type: none"> Ultra Dense PVD Coating with optimal thermal resistance & strength Sub-Micron substrate designed for demanding application
YG713 P15 - P25	PVD - TiAlN 	Drilling Grade for General Steel Application <ul style="list-style-type: none"> Multi-layer TiAlN structure realizes stronger crater and flank wear resistance Fine-grained carbide and balanced substrate
YG613 P30 - P50 M30 - M50	PVD - TiAlN 	Drilling Grade for Stainless Steel Application <ul style="list-style-type: none"> New coating layer with high toughness and lubrication on ultra fine grain substrate with high toughness. The toughest substrates provides excellent cutting performance in stainless steel

Universal Drilling Inserts

	4 Corner	SPMX Series	SPMX	05, 06, 07, 09, 11, 14
	ISO 3 Corner	WCMX Series	WCMX	03, 04, 05, 06, 08

Drilling Chipbreakers

P	M	K		
	M		-ST	 <ul style="list-style-type: none"> Sharp Geometry Sticky Material, Stainless Steel
P	M	K	General Inserts (No Description)	 <ul style="list-style-type: none"> First Choice for General Application

Drilling - Drill Holder
SPMX 050204 Drill (DC 13~15)

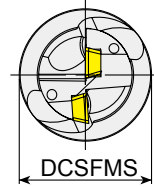
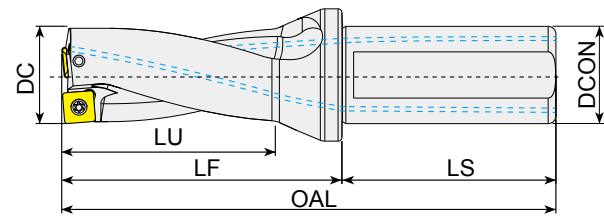

Screw	Wrench
T062043D	TWFT06

☐: p.169 Unit:mm

Series	DC	LU	Designation	EDP 3700..	LF	OAL	DCON	DCSFMS	LS
SPMX 050204	13	26	YGSP2-13S20F026-05	0001	44	94	20	25	50
		39	YGSP3-13S20F039-05	0004	57	107			
		65	YGSP5-13S20F065-05	0007	83	133			
	14	28	YGSP2-14S20F028-05	0002	46	96			
		42	YGSP3-14S20F042-05	0005	60	110			
		70	YGSP5-14S20F070-05	0008	88	138			
	15	30	YGSP2-15S20F030-05	0003	48	98			
		45	YGSP3-15S20F045-05	0006	63	113			
		75	YGSP5-15S20F075-05	0009	93	143			

* Call for us DC size increments of 0.5

Drilling - Drill Holder
SPMX 060204 Drill (DC 16~21)

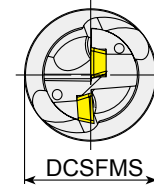
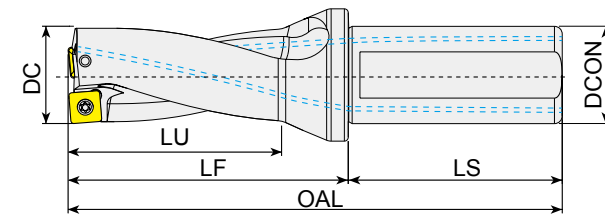

Screw	Wrench
T072252D	TWFT07

☐: p.169 Unit:mm

Series	DC	LU	Designation	EDP 3700..	LF	OAL	DCON	DCSFMS	LS
SPMX 060204	16	32	YGSP2-16S25F032-06	0010	53	109	25	32	56
		48	YGSP3-16S25F048-06	0016	69	125			
		80	YGSP5-16S25F080-06	0022	101	157			
	17	34	YGSP2-17S25F034-06	0011	55	111			
		51	YGSP3-17S25F051-06	0017	72	128			
		85	YGSP5-17S25F085-06	0023	106	162			
	18	36	YGSP2-18S25F036-06	0012	57	113			
		54	YGSP3-18S25F054-06	0018	75	131			
		90	YGSP5-18S25F090-06	0024	111	167			
	19	38	YGSP2-19S25F038-06	0013	59	115			
		57	YGSP3-19S25F057-06	0019	78	134			
		95	YGSP5-19S25F095-06	0025	116	172			
	20	40	YGSP2-20S25F040-06	0014	62	118			
		60	YGSP3-20S25F060-06	0020	82	138			
		100	YGSP5-20S25F100-06	0026	122	178			
	21	42	YGSP2-21S25F042-06	0015	64	120			
		63	YGSP3-21S25F063-06	0021	85	141			
		105	YGSP5-21S25F105-06	0027	127	183			

* Call for us DC size increments of 0.5

Drilling - Drill Holder

SPMX 07T308 Drill (DC 22~27)

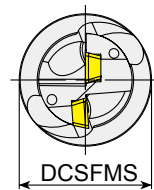
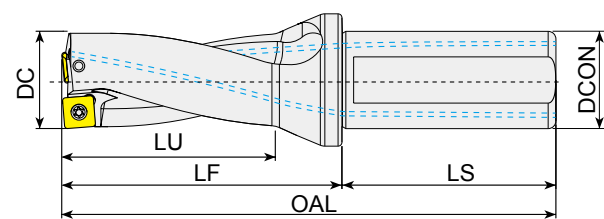

Screw	Wrench
T082564D	TWFT08

☐: p.169 Unit:mm

Series	DC	LU	Designation	EDP 3700..	LF	OAL	DCON	DCSFMS	LS
SPMX 07T308	22	44	YGSP2-22S32F044-07	0028	74	134	32	45	60
		66	YGSP3-22S32F066-07	0034	96	156			
		110	YGSP5-22S32F110-07	0040	140	200			
	23	46	YGSP2-23S32F046-07	0029	76	136			
		69	YGSP3-23S32F069-07	0035	99	159			
	24	115	YGSP5-23S32F115-07	0041	145	205			
		48	YGSP2-24S32F048-07	0030	78	138			
	25	72	YGSP3-24S32F072-07	0036	102	162			
		120	YGSP5-24S32F120-07	0042	150	210			
		50	YGSP2-25S32F050-07	0031	80	140			
	26	75	YGSP3-25S32F075-07	0037	105	165			
		125	YGSP5-25S32F125-07	0043	155	215			
		52	YGSP2-26S32F052-07	0032	82	142			
	27	78	YGSP3-26S32F078-07	0038	108	168			
		130	YGSP5-26S32F130-07	0044	160	220			
	27	54	YGSP2-27S32F054-07	0033	84	144			
		81	YGSP3-27S32F081-07	0039	111	171			
		135	YGSP5-27S32F135-07	0045	165	225			

* Call for us DC size increments of 0.5

Drilling - Drill Holder

SPMX 090408 Drill (DC 28~33)

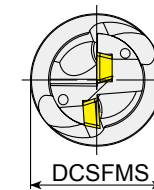
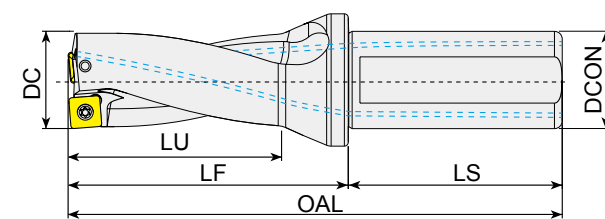

Screw	Wrench
T103588D	TWFT10

☐: p.169 Unit:mm

Series	DC	LU	Designation	EDP 3700..	LF	OAL	DCON	DCSFMS	LS
SPMX 090408	28	56	YGSP2-28S32F056-09	0046	86	146	32	45	60
		84	YGSP3-28S32F084-09	0052	114	174			
		140	YGSP5-28S32F140-09	0058	170	230			
	29	58	YGSP2-29S32F058-09	0047	88	148			
		87	YGSP3-29S32F087-09	0053	117	177			
	30	145	YGSP5-29S32F145-09	0059	175	235			
		60	YGSP2-30S32F060-09	0048	91	151			
	31	90	YGSP3-30S32F090-09	0054	121	181			
		150	YGSP5-30S32F150-09	0060	181	241			
		62	YGSP2-31S32F062-09	0049	93	153			
	32	93	YGSP3-31S32F093-09	0055	124	184			
		155	YGSP5-31S32F155-09	0061	186	246			
		64	YGSP2-32S32F064-09	0050	95	155			
	33	96	YGSP3-32S32F096-09	0056	127	187			
		160	YGSP5-32S32F160-09	0062	191	251			
		66	YGSP2-33S32F066-09	0051	97	157			
	33	99	YGSP3-33S32F099-09	0057	130	190			
		165	YGSP5-33S32F165-09	0063	196	256			

* Call for us DC size increments of 0.5

Drilling - Drill Holder

WCMX 030208 Drill (DC 16~19.5)

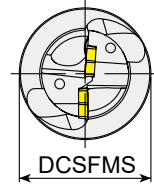
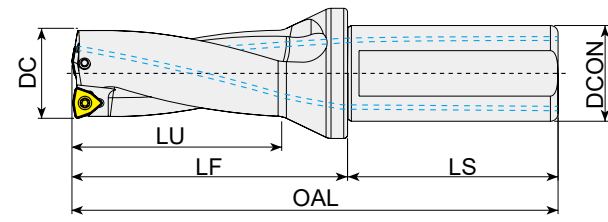

Screw	Wrench
Y3008-M2.5x6	Y80-T08

△: p. 170 Unit:mm

Series	DC	LU	Designation	EDP 3700..	LF	OAL	DCON	DCSFMS	LS
WCMX 030208	16	32	YGWC2-16S25F032-03	0253	54	110	25	34	56
		48	YGWC3-16S25F048-03	0296	70	126			
		64	YGWC4-16S25F064-03	0339	86	142			
	16.5	32	YGWC2-16.5S25F032-03	0780	54	110			
		48	YGWC3-16.5S25F048-03	0781	70	126			
		64	YGWC4-16.5S25F064-03	0782	86	142			
	17	34	YGWC2-17S25F034-03	0254	56	112			
		51	YGWC3-17S25F051-03	0297	73	129			
		68	YGWC4-17S25F068-03	0340	90	146			
	17.5	34	YGWC2-17.5S25F034-03	0783	56	112			
		51	YGWC3-17.5S25F051-03	0784	73	129			
		68	YGWC4-17.5S25F068-03	0785	90	146			
	18	36	YGWC2-18S25F036-03	0255	58	114			
		54	YGWC3-18S25F054-03	0298	76	132			
		72	YGWC4-18S25F072-03	0341	94	150			
	18.5	36	YGWC2-18.5S25F036-03	0786	58	114			
		54	YGWC3-18.5S25F054-03	0787	76	132			
		72	YGWC4-18.5S25F072-03	0788	94	150			
	19	38	YGWC2-19S25F038-03	0256	60	116			
		57	YGWC3-19S25F057-03	0299	79	135			
		76	YGWC4-19S25F076-03	0342	98	154			
	19.5	38	YGWC2-19.5S25F038-03	0789	60	116			
		57	YGWC3-19.5S25F057-03	0790	79	135			
		76	YGWC4-19.5S25F076-03	0791	98	154			

Drilling - Drill Holder

WCMX 040208 Drill (DC 20~23.5)

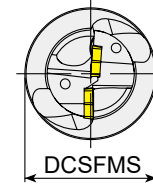
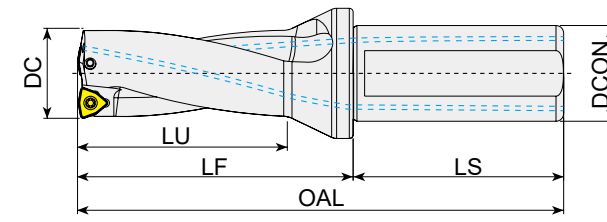

Screw	Wrench
Y3008-M2.5x6	Y80-T08

△: p. 170 Unit:mm

Series	DC	LU	Designation	EDP 3700..	LF	OAL	DCON	DCSFMS	LS
WCMX 040208	20	40	YGWC2-20S25F040-04	0257	62	118	25	34	56
		60	YGWC3-20S25F060-04	0300	82	138			
		80	YGWC4-20S25F080-04	0343	102	158			
	20.5	40	YGWC2-20.5S25F040-04	0726	62	118			
		60	YGWC3-20.5S25F060-04	0727	82	138			
		42	YGWC2-21S25F042-04	0258	64	120			
	21	63	YGWC3-21S25F063-04	0301	85	141			
		84	YGWC4-21S25F084-04	0344	106	162			
		42	YGWC2-21.5S25F042-04	0728	64	120			
	21.5	63	YGWC3-21.5S25F063-04	0729	85	141			
		44	YGWC2-22S25F044-04	0259	66	122			
		66	YGWC3-22S25F066-04	0302	88	144			
	22	88	YGWC4-22S25F088-04	0345	110	166			
		44	YGWC2-22.5S25F044-04	0730	66	122			
		66	YGWC3-22.5S25F066-04	0731	88	144			
	22.5	88	YGWC4-22.5S25F088-04	0732	110	166			
		46	YGWC2-23S25F046-04	0260	68	124			
		69	YGWC3-23S25F069-04	0303	91	147			
	23	92	YGWC4-23S25F092-04	0346	114	170			
		46	YGWC2-23.5S25F046-04	0733	68	124			
		69	YGWC3-23.5S25F069-04	0734	91	147			

Drilling - Drill Holder

WCMX 050308 Drill (DC 24~29.5)

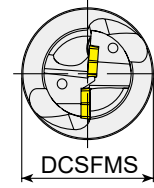
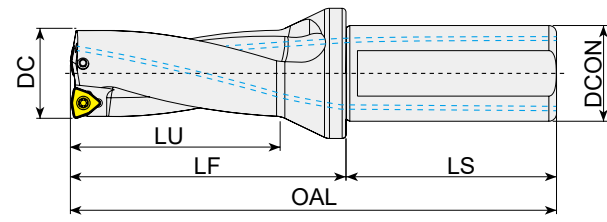

Screw	Wrench
Y3008-M3x8	Y80-T08

△: p. 170 Unit:mm

Series	DC	LU	Designation	EDP 3700..	LF	OAL	DCON	DCSFMS	LS
WCMX 050308	24	48	YGWC2 - 24S25F048 - 05	0261	70	126	25	34	56
		72	YGWC3 - 24S25F072 - 05	0304	94	150			
		96	YGWC4 - 24S25F096 - 05	0347	118	174			
	24.5	48	YGWC2 - 24.5S25F048 - 05	0735	70	126			
		72	YGWC3 - 24.5S25F072 - 05	0736	94	150			
		50	YGWC2 - 25S25F050 - 05	0262	72	128			
	25	75	YGWC3 - 25S25F075 - 05	0305	97	153			
		100	YGWC4 - 25S25F100 - 05	0251	122	178			
		50	YGWC2 - 25.5S25F050 - 05	0737	72	128			
	25.5	75	YGWC3 - 25.5S25F075 - 05	0738	97	153			
		52	YGWC2 - 26S25F052 - 05	0263	74	130			
		78	YGWC3 - 26S25F078 - 05	0306	100	156			
	26	104	YGWC4 - 26S25F104 - 05	0349	126	182			
		52	YGWC2 - 26.5S25F052 - 05	0739	74	130			
		78	YGWC3 - 26.5S25F078 - 05	0741	100	156			
	26.5	104	YGWC4 - 26.5S25F104 - 05	0742	126	182			
		54	YGWC2 - 27S25F054 - 05	0264	76	132			
		81	YGWC3 - 27S25F081 - 05	0307	103	159			
	27	108	YGWC4 - 27S25F108 - 05	0350	130	186			
		54	YGWC2 - 27.5S25F054 - 05	0743	76	132			
		81	YGWC3 - 27.5S25F081 - 05	0744	103	159			
	27.5	56	YGWC2 - 28S25F056 - 05	0265	78	134			
		84	YGWC3 - 28S25F084 - 05	0308	106	162			
		112	YGWC4 - 28S25F112 - 05	0351	134	190			
28	56	YGWC2 - 28.5S25F056 - 05	0745	78	134				
	84	YGWC3 - 28.5S25F084 - 05	0746	106	162				
	112	YGWC4 - 28.5S25F112 - 05	0747	134	190				
28.5	58	YGWC2 - 29S25F058 - 05	0266	80	136				
	87	YGWC3 - 29S25F087 - 05	0309	109	165				
	116	YGWC4 - 29S25F116 - 05	0352	138	194				
29	58	YGWC2 - 29.5S25F058 - 05	0748	80	136				
	87	YGWC3 - 29.5S25F087 - 05	0749	109	165				

Drilling - Drill Holder

WCMX 06T308 Drill (DC 30~44.5)

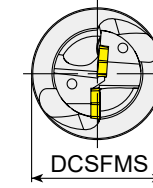
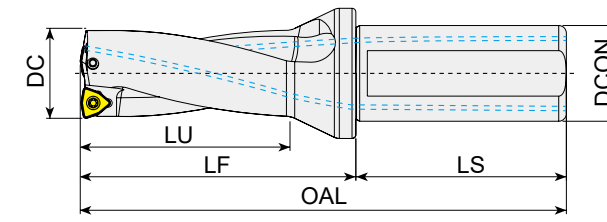

Screw	Wrench
Y3010-M3.5x9	Y80-T10

△: p. 170 Unit:mm

Series	DC	LU	Designation	EDP 3700..	LF	OAL	DCON	DCSFMS	LS
WCMX 06T308	30	60	YGWC2 - 30S32F060 - 06	0267	87	147	32	44	60
		90	YGWC3 - 30S32F090 - 06	0310	117	177			
		120	YGWC4 - 30S32F120 - 06	0353	147	207			
	30.5	90	YGWC3 - 30.5S32F090 - 06	0750	117	177			
		62	YGWC2 - 31S32F062 - 06	0268	89	149			
		93	YGWC3 - 31S32F093 - 06	0311	120	180			
	31	124	YGWC4 - 31S32F124 - 06	0354	151	211			
		93	YGWC3 - 31.5S32F093 - 06	0751	120	180			
		64	YGWC2 - 32S32F064 - 06	0269	91	151			
	31.5	96	YGWC3 - 32S32F096 - 06	0312	123	183			
		128	YGWC4 - 32S32F128 - 06	0252	155	215			
		96	YGWC3 - 32.5S32F096 - 06	0752	123	183			
	32	66	YGWC2 - 33S32F066 - 06	0753	93	153			
		99	YGWC3 - 33S32F099 - 06	0754	126	186			
		132	YGWC4 - 33S32F132 - 06	0755	159	219			
	33	99	YGWC3 - 33.5S32F099 - 06	0756	126	186			
		132	YGWC4 - 33.5S32F132 - 06	0757	159	219			
		68	YGWC2 - 34S32F068 - 06	0271	95	155			
	33.5	102	YGWC3 - 34S32F102 - 06	0314	129	189			
		136	YGWC4 - 34S32F136 - 06	0357	163	223			
		102	YGWC3 - 34.5S32F102 - 06	0758	129	189			
	34	70	YGWC2 - 35S32F070 - 06	0272	97	157			
		105	YGWC3 - 35S32F105 - 06	0315	132	192			
		140	YGWC4 - 35S32F140 - 06	0358	167	227			
	34.5	105	YGWC3 - 35.5S32F105 - 06	0759	132	192			
		72	YGWC2 - 36S32F072 - 06	0273	99	159			
		108	YGWC3 - 36S32F108 - 06	0316	135	195			
	35	144	YGWC4 - 36S32F144 - 06	0359	171	231			
		108	YGWC3 - 36.5S32F108 - 06	0760	135	195			
		74	YGWC2 - 37S32F074 - 06	0274	101	161			
35.5	111	YGWC3 - 37S32F111 - 06	0317	138	198				
	148	YGWC4 - 37S32F148 - 06	0360	175	235				

▶ NEXT PAGE

WCMX 06T308 Drill (DC 30~44.5)

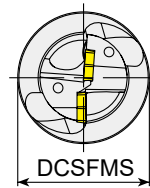
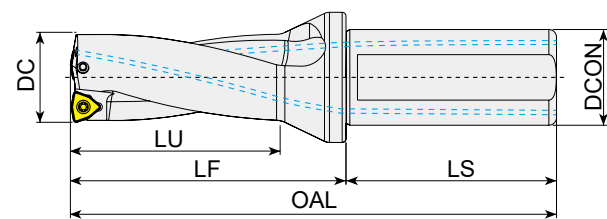

Screw	Wrench
Y3010-M3.5x9	Y80-T10

△: p. 170 Unit:mm

Series	DC	LU	Designation	EDP 3700..	LF	OAL	DCON	DCSFMS	LS
WCMX 06T308	37.5	111	YGWC3 - 37.5S32F111 - 06	0761	138	198	32	44	60
		76	YGWC2 - 38S32F076 - 06	0275	103	163			
	38	114	YGWC3 - 38S32F114 - 06	0318	141	201			
		152	YGWC4 - 38S32F152 - 06	0361	179	239			
	38.5	114	YGWC3 - 38.5S32F114 - 06	0762	141	201			
		152	YGWC4 - 38.5S32F152 - 06	0763	179	239			
	39	78	YGWC2 - 39S32F078 - 06	0276	105	165			
		117	YGWC3 - 39S32F117 - 06	0319	144	204			
	39.5	156	YGWC4 - 39S32F156 - 06	0362	183	243			
		117	YGWC3 - 39.5S32F117 - 06	0764	144	204			
	40	80	YGWC2 - 40S32F080 - 06	0277	107	167			
		120	YGWC3 - 40S32F120 - 06	0320	147	207			
		160	YGWC4 - 40S32F160 - 06	0363	187	247			
	40.5	120	YGWC3 - 40.5S32F120 - 06	0765	147	207			
		82	YGWC2 - 41S32F082 - 06	0278	109	169			
		123	YGWC3 - 41S32F123 - 06	0321	150	210			
	41	164	YGWC4 - 41S32F164 - 06	0364	191	251			
		123	YGWC3 - 41.5S32F123 - 06	0766	150	210			
	41.5	84	YGWC2 - 42S32F084 - 06	0279	111	171			
		126	YGWC3 - 42S32F126 - 06	0322	153	213			
	42	168	YGWC4 - 42S32F168 - 06	0365	195	255			
		126	YGWC3 - 42.5S32F126 - 06	0767	153	213			
	42.5	86	YGWC2 - 43S32F086 - 06	0280	113	173			
		129	YGWC3 - 43S32F129 - 06	0323	156	216			
43	172	YGWC4 - 43S32F172 - 06	0366	199	259				
	129	YGWC3 - 43.5S32F129 - 06	0768	156	216				
43.5	88	YGWC2 - 44S32F088 - 06	0281	115	175				
	132	YGWC3 - 44S32F132 - 06	0324	159	219				
44	176	YGWC4 - 44S32F176 - 06	0367	203	263				
	132	YGWC3 - 44.5S32F132 - 06	0769	159	219				

WCMX 080412 Drill (DC 45~60)

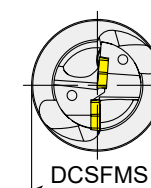
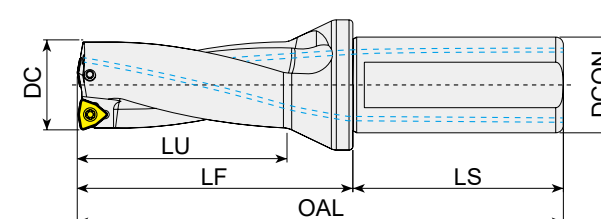

Screw	Wrench
Y4015-M4x11	Y80-T15

△: p. 170 Unit:mm

Series	DC	LU	Designation	EDP 3700..	LF	OAL	DCON	DCSFMS	LS
WCMX 080412	45	90	YGWC2 - 45S40F090 - 08	0282	122	192	40	54	70
		135	YGWC3 - 45S40F135 - 08	0325	167	237			
	45.5	180	YGWC4 - 45S40F180 - 08	0368	212	282			
		135	YGWC3 - 45.5S40F135 - 08	0770	167	237			
	46	92	YGWC2 - 46S40F092 - 08	0283	124	194			
		138	YGWC3 - 46S40F138 - 08	0326	170	240			
	46.5	184	YGWC4 - 46S40F184 - 08	0369	216	286			
		94	YGWC2 - 47S40F094 - 08	0284	126	196			
	47	141	YGWC3 - 47S40F141 - 08	0327	173	243			
		188	YGWC4 - 47S40F188 - 08	0370	220	290			
	48	96	YGWC2 - 48S40F096 - 08	0285	128	198			
		144	YGWC3 - 48S40F144 - 08	0328	176	246			
	48.5	192	YGWC4 - 48S40F192 - 08	0371	224	294			
		98	YGWC2 - 49S40F098 - 08	0286	130	200			
	49	147	YGWC3 - 49S40F147 - 08	0329	179	249			
		196	YGWC4 - 49S40F196 - 08	0372	228	298			
	50	100	YGWC2 - 50S40F100 - 08	0287	132	202			
		150	YGWC3 - 50S40F150 - 08	0330	182	252			
	50.5	200	YGWC4 - 50S40F200 - 08	0373	232	302			
		102	YGWC2 - 51S40F102 - 08	0288	134	204			
	51	153	YGWC3 - 51S40F153 - 08	0331	185	255			

▶ NEXT PAGE

WCMX 080412 Drill (DC 45~60)

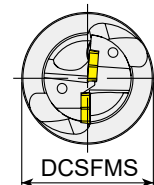
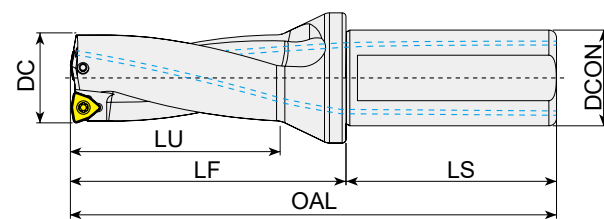

Screw	Wrench
Y4015-M4x11	Y80-T15

△: p. 170 Unit:mm

Series	DC	LU	Designation	EDP 3700..	LF	OAL	DCON	DCSFMS	LS
WCMX 080412	52	104	YGWC2 - 52S40F104 - 08	0289	136	206	40	54	70
		156	YGWC3 - 52S40F156 - 08	0332	188	258			
	53	106	YGWC2 - 53S40F106 - 08	0290	138	208			
		159	YGWC3 - 53S40F159 - 08	0333	191	261			
	54	108	YGWC2 - 54S40F108 - 08	0291	140	210			
		162	YGWC3 - 54S40F162 - 08	0334	194	264			
	55	110	YGWC2 - 55S40F110 - 08	0292	142	212			
		165	YGWC3 - 55S40F165 - 08	0335	197	267			
	56	112	YGWC2 - 56S40F112 - 08	0293	144	214			
		168	YGWC3 - 56S40F168 - 08	0336	200	270			
	57	114	YGWC2 - 57S40F114 - 08	0294	146	216			
		171	YGWC3 - 57S40F171 - 08	0337	203	273			
	58	116	YGWC2 - 58S40F116 - 08	0295	148	218			
		174	YGWC3 - 58S40F174 - 08	0338	206	276			
	59	118	YGWC2 - 59S40F118 - 08	0771	150	220			
		177	YGWC3 - 59S40F177 - 08	0772	209	279			
	60	120	YGWC2 - 60S40F120 - 08	0773	152	222			
		180	YGWC3 - 60S40F180 - 08	0774	212	282			

Drilling Inserts (SPMX)

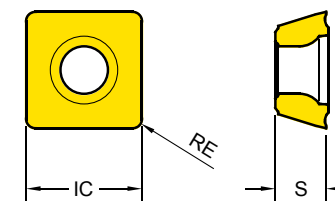

Series	IC	S
SPMX 0502	5.00	2.38
SPMX 0602	6.00	2.41
SPMX 07T3	7.94	3.97
SPMX 0904	9.80	4.30
SPMX 1104	11.50	4.80
SPMX 1405	14.30	5.20

SPMX	Designation	Fn (mm/rev.)	EDP 3200..		
			YG602	YG713	YG613
SPMX General	SPMX 050204	0.07~0.14	● 0005	● 0062	● 0077
	SPMX 060204	0.08~0.14	● 0006	● 0063	● 0078
	SPMX 07T308	0.08~0.16	● 0007	● 0064	● 0061
	SPMX 090408	0.08~0.16	● 0008	● 0065	● 0079
	SPMX 110408	0.10~0.18	● 0009	● 0066	● 0080
	SPMX 140512	0.10~0.20	● 0010	● 0067	
-ST Stainless Steel	SPMX 050204-ST	0.03~0.10	● 0011		● 0070
	SPMX 060204-ST	0.04~0.11	● 0012		● 0071
	SPMX 07T308-ST	0.04~0.11	● 0013		● 0068
	SPMX 090408-ST	0.05~0.12	● 0014		● 0072
	SPMX 110408-ST	0.05~0.12			● 0073
	SPMX 140512-ST	0.05~0.16			● 0074

ISO	VDI	Sub Group	Cutting Speed Vc (m/min.)					
			YG602		YG713		YG613	
			Min	Max	Min	Max	Min	Max
P	1~5	Non-Alloyed Steel	180	380	200	300	100	210
	6~9	Low-Alloyed Steel	120	300	170	270	70	180
	10~11	High-Alloyed Steel	70	150	85	145	40	90
M	12~13	Ferritic & Martensitic	120	200	-	-	70	180
	14	Austenitic Stainless Steel	130	250	-	-	70	200
K	15~16	Grey Cast Iron	120	250	-	-	-	-
	17~18	Nodular Cast Iron	130	220	-	-	-	-
H	38~41	Hard Materials	-	-	-	-	-	-

Drilling Inserts (WCMX)

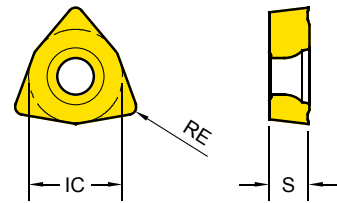

Series	IC	S
WCMX 0302	5.56	2.38
WCMX 0402	6.35	2.38
WCMX 0503	7.94	3.18
WCMX 06T3	9.53	3.97
WCMX 0804	12.70	4.76

EDP 3200..

WCMX	Designation	Fn (mm/rev.)	EDP 3200..	
			YG602	YG713
WCMX General 	WCMX 030208	0.05 ~ 0.12	● 0031	● 0086
	WCMX 040208	0.05 ~ 0.12	● 0003	● 0087
	WCMX 050308	0.06 ~ 0.14	● 0001	● 0088
	WCMX 06T308	0.08 ~ 0.14	● 0002	● 0089
	WCMX 080412	0.08 ~ 0.14	● 0004	● 0090

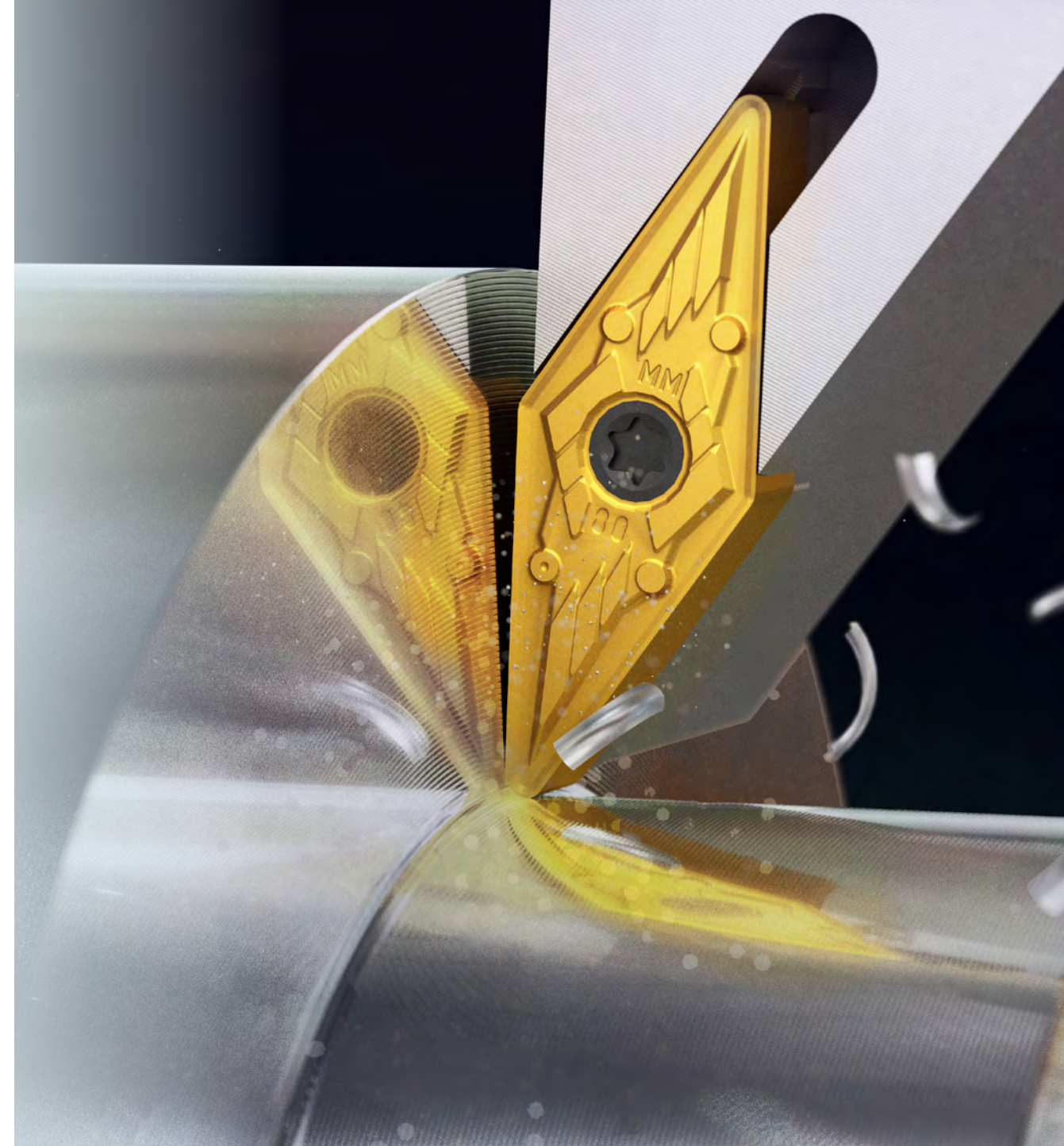

TECHNICAL INFORMATION

- ISO 13399 Terms
- Hardness Conversion Table
- Formulas
- Material Groups
- Comparison Chart
- ISO ↔ ANSI
- Search

ISO	Cutting Speed		Vc (m/min.)			
	VDI	Sub Group	YG602		YG713	
			Min	Max	Min	Max
P	1~5	Non-Alloyed Steel	180	380	200	300
	6~9	Low-Alloyed Steel	120	300	170	270
	10~11	High-Alloyed Steel	70	150	85	145
M	12~13	Ferritic & Martensitic	120	200	-	-
	14	Austenitic Stainless Steel	130	250	-	-
K	15~16	Grey Cast Iron	120	250	-	-
	17~18	Nodular Cast Iron	130	220	-	-

Technical Information

ISO 13399 Terms

AN	Clearance angle major	INSD	Insert diameter
APMX	Depth of cut maximum	KAPR	Tool cutting edge angle
AS	Clearance angle wiper edge	KRINS	Cutting edge angle major
B	Shank width	KWW	Keyway width
BS	Wiper edge length	L	Cutting edge length
CBDP	Connection bore depth	LE	Cutting edge effective length
CDX	cutting depth maximum	LF	Functional length
CICT	Number of Inserts	LH	Head length
CW	Cutting width	LS	Shank length
CZC	Connection size code	LU	Usable length
DC	Cutting diameter	LUX	Usable length maximum
DCON	Connection diameter	M	Nose (or Wiper) Height
DCSFMS	Contact surface diameter machine side	OAL	Overall length
DCX	Cutting diameter maximum	RE	Corner radius
DMIN	Minimum bore diameter	RMPX	Maximum ramping angle
DMM	Shank diameter	RPMX	Rotational speed maximum
EPSR	Insert included angle	S	Insert thickness
H	Shank height	TDZ	Thread diameter size
HAND	Hand	WF	Functional width
IC	Inscribed circle diameter	ZEFP	Peripheral effective cutting edge count

Technical Information

Hardness Conversion Table

HB	HRc	HRB	HV	N/mm ²
199	15	93	199	667
203	16	94	201	680
208	17	95	210	696
212	18	95	218	706
216	19	96	222	716
223	20	97	227	755
229	21	98	235	775
233	22	99	241	794
240	23	100	247	824
245	24	100	252	838
250	25	101	255	853
255	26	102	258	870
262	27	103	262	880
264	28	103	271	892
271	29	104	277	941
277	30	105	285	971
290	31	106	292	990
300	32	107	303	1020
308	33	107	311	1035
314	34	108	320	1049
322	35	108	332	1089
331	36	109	342	1118
341	37	109	351	1157
348	38	110	361	1187
360	39	111	376	1236
373	40	111	388	1265
375	41	112	393	1314
388	42	113	406	1363
402	43	114	424	1390
415	44	114	438	1422
419	45	114	448	1447
430	46	115	458	1471
445	47	115	474	1520
456	48	116	490	1569
468	49	117	497	
469	50	117	505	
486	51	118	531	
504	52	118	549	
513	53	119	567	
534	54	120	589	
552	55		649	
572	56		694	
592	57		727	
601	58		746	
613	59			
627	60			
642	61			
658	62			
681	63			
695	64			
HB	HRc	HRB	HV	N/mm ²

Technical Information

Formulas

Formulas

Cutting Speed (Vc)	Metric $Vc = D \times RPM \times 0.0031$ (m/min.)	Inch $Vc = D \times RPM \times .262$ (ft/min.)
	Metric Vc to Inch Vc $Inch\ Vc = Metric\ Vc \times 3.28$ (ft/min.)	
	Inch Vc to Metric Vc $Metric\ Vc = Inch\ Vc \times .305$ (m/min.)	

Turning Formulas

Spindle Speed (RPM)	Metric $RPM = Vc \times 318.3 \div D$ (rev./min.)	Inch $RPM = Vc \times 3.82 \div D$ (rev./min.)
----------------------------	---	--

Feed Rate (Vf = Table Feed)	$Vf = Fn \times RPM$ (mm/min. or in./min.)
------------------------------------	--

Feed per Revolution (Fn)	$Fn = Vf \div RPM$ (mm/rev. or in./rev.)
---------------------------------	--

Metal Removal Rate (Q)	Metric $Q = Vc \times Fn \times Ap$ (cm ³ /min.)	Inch $Q = Vc \times Fn \times Ap \times 12$ (in ³ /min.)
-------------------------------	---	---

Cutting Time	$T = L \div Vf$ (min.)
---------------------	------------------------

Milling Formulas

Feed per Revolution (Fn)	$Fn = Vf \div RPM$ (mm/rev. or in./rev.) $= Fz \times \text{Number of tooth}$ (mm/rev. or in./rev.)
---------------------------------	--

Feed per Tooth (Fz)	$Fz = Vf \div RPM \div \text{Number of tooth}$ (mm/rev. or in./rev.) $= Fn \div \text{Number of tooth}$ (mm/rev. or in./rev.)
----------------------------	--

Metal Removal Rate (Q)	Metric $Q = Ap \times Ae \times Vf \div 1000$ (cm ³ /min.)	Inch $Q = Ap \times Ae \times Vf$ (in ³ /min.)
-------------------------------	---	---

Cutting Time	$T = L \div Vf$ (min.)
---------------------	------------------------

Power Consumption (Pc)	Metric $Pc = Ap \times Ae \times Vf \times Kc \times 0.00000017$ (kW)	Inch $Pc = Ap \times Ae \times Vf \times Kc \times 0.00000253$ (Hp)
-------------------------------	---	---

Drilling Formulas

Power Consumption (Pc)	Metric $Pc = Fn \times Vc \times D \times Kc \times 0.0000042$ (kW)	Inch $Pc = Fn \times Vc \times D \times Kc \times 0.0000076$ (Hp)
-------------------------------	---	---

Torque (Mc)	Metric $Mc = Pc \times 9554.1 \div RPM$ (Nm)	Inch $Mc = Pc \times 5255 \div RPM$ (lbf ft)
--------------------	--	--

Thrust (T)	$T \approx 0.5 \times Kc \times DC/2 \times Fn \times \sin\ KAPR$ (N)
-------------------	---

Terms

RPM (n)	Spindle Speed (Revolution per minute)
Vc	Cutting Speed
D	Work Diameter
Vf	Feed Rate (Table Feed)
Fn	Feed per Revolution
Ap	Depth of Cut
Q	Metal Removal Rate
L	Length of cut
T	Cutting Time (min.)

Technical Information

Material Groups

ISO	VDI 3323	Material Description	Composition / Structure / Heat Treatment	HB	HRC	Examples	Page	
P	1	Non-alloyed steel	About 0.15% C	Annealed	125	S15C, C15, 1015	176	
	2		About 0.45% C	Annealed	190	13		
	3		About 0.45% C	Quenched & Tempered	250	25		S45C, C45, 1045
	4		About 0.75% C	Annealed	270	28		SK5, CK75, 1080
	5		About 0.75% C	Quenched & Tempered	300	32		
	6	Low-alloyed Steel		Annealed	180	10		SCM440, 42CrMo4, 410
	7			Quenched & Tempered	275	29		
	8			Quenched & Tempered	300	32		
	9			Quenched & Tempered	350	38		
	10	High-alloyed steel, and tool steel		Annealed	200	15		SKD, D2
	11			Quenched & Tempered	325	35		SKH, SUH, M42
M	12	Stainless Steel	Ferritic / Martensitic	Annealed	200	15	SUS 420, X40Cr13, 420	
	13		Martensitic	Quenched & Tempered	240	23		
	14		Austenitic		180	10		SUS 316, 316, X5CrNiMo 17 12 2
K	15	Grey cast iron	Pearlitic / Ferritic		180	10	185	
	16		Pearlitic (Martensitic)		260	26		
	17	Nodular cast iron	Ferritic		160	3		
	18		Pearlitic		250	25		
	19	Malleable cast iron	Ferritic		130			
20	Pearlitic			230	21	FCMW, FCMP, GTS, GJMB350-10		
N	21	Aluminum-wrought alloy	Not Curable		60	SAE 1000, AlMg 1, 3.3315	187	
	22		Curable	Hardened	100	SAE 7050, AlCuMg 1, 3.1325		
	23		$\leq 12\% Si$, Not Curable		75	ADC12, G-AlSi12, 3.2581		
	24	Aluminum-cast, alloyed	$\leq 12\% Si$, Curable	Hardened	90	C4BS, G-AlSi10Mg, 3.2381		
	25		$> 12\% Si$, Not Curable		130			
	26		Cutting Alloys, PB>1%		110	CuZn36Pb 3, 2.0375		
	27	Copper and copper alloys (Bronze / Brass)	CuZn, CuSnZn (Brass)		90	CuZn 15, 2.0240		
	28		CuSn, lead-free copper and electrolytic copper		100	G-CuZn40Fe, 2.0590		
	29	Non-metallic materials	Duroplastic, Fiber Reinforced Plastic			CFRP		
	30		Rubber, Wood, etc.					
S	31	Heat resistant super alloys	Fe Based	Annealed	200	15	189	
	32			Aged	280	30		
	33			Annealed	250	25		Inconel 718, NiCr20TiAl, 2.4631
	34	Ni or Co Based	Aged	350	38	NiCu30Al, 2.4375		
	35		Cast	320	34	G-X120Mn12, 1.3401		
	36	Titanium alloys	Pure Titanium		400 Rm			
37	Alpha + Beta Alloys		Hardened	1050Rm	TiAl6V4, 3.7165			
H	38	Hardened steel		Hardened	550	55	191	
	39			Hardened	630	60		
	40	Chilled cast iron		Cast	400	42		
	41	Hardened cast iron		Hardened	550	55		

Technical Information

Material Groups

Mat'l No.	JIS	DIN	Material Description			Composition / Structure / Heat Treatment					HB	HRC
			VDI 3323 1	Non-alloyed steel		About 0.15% C, Annealed						
			AISI/ASTM/SAE	BS	EN	AFNOR	SS	UNI	UNE / IHA	UNS	GOST	Brands
1.0037	STKM 12 C	St 37-2	-	4360 40 B	S235JR	E24-2	1311	Fe 360 B			16D	
1.0038	STKM 12 A	St 37-3	A570.36	4360 40 C	S275J2G3	E28-3	1312	Fe 360 D FF			ST14KP	
1.0045	SM 490 YA	S 355 JR	-	-	S 1207	E36-2	-	Fe 510 BFN				
1.0050	SS 50	St 50-2	A570 Gr.50	4360 50 B	E 295	A50-2	2172	Fe 490			STSPS	
1.0060	SM 58	St 60-2	A572 Gr.65	4360 55 E	-	A60-2	1650	Fe 60-2			ST6PS	
1.0114		S 235 J0	-	En 40C	S 235 J0	E24-3		Fe 360 CFN				
1.0143		S 275 J0	-	-	S 275 J0	E28-3	1414	Fe 430 C				
1.0144	SM41C, SM400	St 44-3 N	A573 Gr.81	4360 43C	S 275 J2 G3	E28-3	1412	Fe 430 D FF			ST14KP	
1.0149		Ro St 44-2	-	43C	S 275 J0 H	-	1412	Fe430C				
1.0301	S10C	C10	1010	045M10	C10	34C10, XC10		C10	F1511	G10100	10	
1.0330	SPCC	St 12	-	DC01	Fe P01	DC01/Fe P01	1142	Fe P01			15KP	
1.0335	SPHE	DD 13 (StW 24)	A622(1008)	H S 3	DD 13	3C		FeP13			08KP	
1.0338	SPCE	St 4	A620(1008)	14491CR	Fe P04	Fe 14	1147	DC04/FeP04			08JU	
1.0345	SPV 50	P235 GH	A516 Gr.65	P 235 GH	P 235 GH	A 37 CP	1330	Fe E 235		K02503		
1.0401	S15C	C15	1015	080M15	-	C18RR, XC18	1350	C15, C16	F1110	G10170	15	
1.0402	S20C	C22	1020	050 A 20	1 C 22	C20	1450	C 20	F1120	G10200	20	
1.0425	SPV315	P265GH/HIL				A42CP	1430	Fe4101KW		K02801	16K	
1.0443	SC 450	GS-45	A2765-35	A1		E23-45M	1305					
1.0539		S355NH				TSE355-4	2134	Fe510B				
1.0545		S355N		4360-50E		E355R	2334	FeE355KG				
1.0546		S355NL		4360-50EE		E355FP	2135	FeE355KT				
1.0547		S355J0H		4360-50C		TSE355-3	2172	Fe510C				
1.0549		S355NLH					2135	Fe510D				
1.0553	SM 520 M	S152-3U	A14880-40	4360-50C		320-560M	1606	Fe510C				
1.0562	SM490A	St E 355	A633 Gr.C	P 355 N		FeE355KGN	2132	Fe E 355 KG		K12000	15GF	
1.0565		W St E 355		P 355 NH		P 355 NH	2106	Fe E 355 KW		K01600		
1.0566	SLA 37	T St E 355		P 355 NL1		P 355 NL1	2107	Fe E 355 KT				
1.0570	SM 50 YA	St 52-3	1	4360-50 C	S355JR	E36-3	2172	Fe 510 B			17G15	
1.0715	SUM22	9SMn28	1213	230M07		S250	1912	CF5Mn28	F2111	G12130		
1.0718	SUM22L	9SMnPb28	12L13			S250Pb	1914	CF9SMnPb28	F2112	G12134		
1.0721		10S20	1108	10S20		10S20		CF10S20	F2121	G11080		
1.0722		10SPb20	11L08			10PbF2		CF10SPb20		G11084		
1.0736	SUM25	9SMn36	1215			S300		CF9Mn36	F2113	G12150		
1.0737		9SMnPb36	12L14			S300Pb	1926	CF9SMnPb36	F2114	G12144		
1.0972		S315MC		1501-40F30		E315D						
1.0976		S355MC		1501-43F35		E355D	2642	FeE355TM				
1.0982		S460MC		1501-50F45								
1.0984		S500MC				E490D	2662	FeE490TM				
1.0986		S500MC		1501-60F55		E560D		FeE560TM				
1.1121	S10C	CK10	1010	040A10		XC10	1265	C10	F1510	G10100	10	
1.1141	S15	CK15	1015	040A15	32C	XC15	1370	C15	F1110	G10150	15	
1.1151	S20C	C22E	1020	055M15		2C22	1450	C20	F1120	G10230	20	
1.8900	S25C	StE380	A572-60	436055E			2145	FeE390KG				
		St44-2	A36	436043A		NFA35-501E28	1411					
		StE320-3Z		1501160			1421					

Technical Information

Material Groups

Mat'l No.	JIS	DIN	Material Description			Composition / Structure / Heat Treatment					HB	HRC
			VDI 3323 2	Non-alloyed steel		About 0.45% C, Annealed						
			AISI/ASTM/SAE	BS	EN	AFNOR	SS	UNI	UNE / IHA	UNS	GOST	Brands
1.0501	S35C	C35	1035	080A32		1C35	1572	C35	F.113	G10350	35	
1.0503	S45C	C45	1045	060A47		XC42H1TS	1672	C45	F.114	G10450	45	
1.0511	S40C	C40	1040	080M40		1C40		C40	F.114A	G10400	40	
1.0540	S50 C	C50					1674	C50		G10500		
1.0551		GS-52	A2770-36	A2		280-480M	1505					
1.0553	SM 520 M	S152-3U	A14880-40	4360-50C		320-560M	1606	Fe510C				
1.0577		S 355 J 2 G 4	A738	Fe 510 D 2 FF		A52FP	2107					
1.0726		35S20	1140	212M36	8M	35MF6	1957			G11400	40	
1.0727		45S20	1146			45MF4	1973			G11460		
1.1157		40Mn4	1039	150M36	15	40M5				G10390	40G	
1.1158	S25C	C25E	1025	070M25		XC25		C25	F.1120	G10250	25	
1.1166	SMn433H	34Mn5	1536						TO.B	G15360		
1.1167	SMn438(H)	36Mn5	1335	150M36		40M5	2120	36Mn6	F.1203	G13350	35G2	
1.1170	SCMn1	28Mn6	1330	150M28	14A	20M5		C28Mn	28Mn6	G13300	30G	
1.1178	S 30 C	C30E		080M30		XC32		C30	2C30	G10300		
1.1180		C35R	1035	080A35		3C35	1572		F.1135	G10350		
1.1181	S35C	C35E	1035	080A35		XC38	1572	C36	F.1130	G10340	35	
1.1191	S45C	CK45	1045	080A46		XC45	1672	C45	F.1140		45	
1.1206	S 50 C	C50E	1050	080M50		2C50	1674	C50		G10500	50	
1.1213	S50C	CF53	1050	070M55		XC48HTS	1674	C53		G10500	50	

Mat'l No.	JIS	DIN	Material Description			Composition / Structure / Heat Treatment					HB	HRC
			VDI 3323 3	Non-alloyed steel		About 0.45% C, Annealed						
			AISI/ASTM/SAE	BS	EN	AFNOR	SS	UNI	UNE / IHA	UNS	GOST	Brands
1.0481	SG365	17 Mn 4/P 295 GH	A516 Gr.70	224-460B	P 295 GH	A 48 CP	2102	Fe E 295	A47RC1	K03501	14G2	
1.0501	S35C	C35	1035	080A32		1C35	1572	C35	F.1130	G10350	35	
1.0503	S45C	C45	1045	060A47		XC42H1TS	1672	C45	F.1140	G10450	45	
1.0614		C76D	1074			XC75				G10750		
1.0616		C86D	1086			XC80		C85		G10860		
1.0618		C92D	1095			XC90				G10950		
1.0726		35S20	1140	212M36	8M	35MF6	1957			G11400	40	
1.1157		40Mn4	1039	150M36	15	40M5				G10390	40G	
1.1165	SMn433H	30Mn5	1036	120M36		35M5		30Mn5	F8211	K13300	30G2	
1.1167	SMn438(H)	36Mn5	1335	150M36		40M5	2120	36Mn6	F.1203	G13350	35G2	
1.1186	S40C	C40E	1040	060A40		2C40		C40		G10400		
1.1191	S45C	CK45	1045	080M46		2C45	1672	C45	F.1140		45	
1.1201	S50C	C45R	1049	080M46		3C45	1660	C45	F.1145		38HM	
1.1213	S50C	CF53	1050	070M55		XC48HTS	1674	C53		G10500	50	
1.7242	SCM418 H	18CrMo4										
1.7337		16CrMo4-4	A387 Gr.12					A18CrMo45KW		K11564	15CM	
1.7362	SCMV6	12CrMo195		3606-625		Z10CD5-05		16CrMo205		K41545		
		17MnV6	A572-60	436055E		NFA35-501E36	2142					



Technical Information Material Groups

Mat'l No.	JIS	DIN	Material Description			Composition / Structure / Heat Treatment					HB	HRC
			AISI/ASTM/SAE	BS	EN	AFNOR	SS	UNI	UNE / IHA	UNS		
1.0603	S70C-CSP	C67	107	080A67		XC65		C67		G10700		
1.0605		C75	1075	144980HS				C75		G10740	75	
1.1203	S55C	Ck55	1055	060A57		2C55	1655	C55	F.1150	G10550	55	
1.1209		C55R	1055	070M55		3C55		C55	F.1155	G10550		
1.1221	S58C	Ck60	1060	060A62	43D	2C60	1678	C60	F.1150	G10640	60	
1.1231	S70C-CSP	C67E	1070	060A67		XC68	1770	C70	F5103	G10700	65GA	
1.1248	C75	C75E	1074	060A78		XC75	1774	C75	F5107	G10800	75(A)	
1.1269	SK5-CSP	C85E	1086			XC90		C90		G10900	85(A)	
1.1274	SUP4	Ck101	1095	060A96	C100S	XC100	1870	C100	F5117	G10950		
1.1545	SK3	C105W1	W1	BW2	C105U	Y1105	1880	C100KU	F5118		U10A	
1.1663	SK2	C125W	W112			Y2120					U13	

Mat'l No.	JIS	DIN	Material Description			Composition / Structure / Heat Treatment					HB	HRC
			AISI/ASTM/SAE	BS	EN	AFNOR	SS	UNI	UNE / IHA	UNS		
1.0070		St70-2	1055	Fe690-2FN	-	A70-2	1655	Fe690	F.1150		55	
1.0535	S55C	C55	1055	070M55		1C55	1655	C55		J05000	55	
1.0601	S58C	C60	1060	060A62	43D	1C60		C60		G10600	60(G)	
1.1203	S55C	Ck55	1055	060A57		2C55	1655	C55	F.1150	G10550	55	
1.1221	S58C	Ck60	1060	060A62	43D	2C60	1678	C60	F.1150	G10640	60	
1.1274	SUP4	Ck101	1095	060A96	C100S	XC100	1870	C100	F5117	G10950		
1.1545	SK3	C105W1	W1	BW2	C105U	Y1105	1880	C100KU	F5118		U10A	
1.1663	SK2	C125W	W112			Y2120					U13	
1.5120		38MnSi4										
1.5710	SNC236	36NiCr6	3135	640A35	111A	35NC6						
1.7701		51CrMoV4						51CrMoV4				



Technical Information Material Groups

Mat'l No.	JIS	DIN	Material Description			Composition / Structure / Heat Treatment					HB	HRC
			AISI/ASTM/SAE	BS	EN	AFNOR	SS	UNI	UNE / IHA	UNS		
1.0116		St37-3	A570Gr.36	4360-40C	S235J2G3	E24-3	1312	Fe360D1(2)	AE235D		ST3KP	
1.0904	SKH1, SKT4	55Si7	9255	250A53	45	55S7	2085	55Si8	56Si7	G92550	55S2	
1.0961	SUP7	60SiCr7	9262			60SiCr6		60SiCr8	60SiCr8	G92620		
1.2067		100Cr6	L3	BL3		Y100C6				100Cr6		
1.2108		90CrSi5	L1				2092	105WCr5				
1.2210		115CrV3	L2				100C3	107CrV3KU	F520L		11KHF	
1.2241		51CrV4										
1.2330	SCM435TK	35CrMo4	4135	708A37		34CD4	2234	35CrMo4			35KHM	
1.2419	SKS31	105WCr6		105WC13		105WC13	2140	10WCr6			CWG	
1.2510	SKS3	100MnCrW4	O1	B01		90MWCV5	2140	95MnWCr5KU	F5220		9KHVG	
1.2542		45WCrV7	S1	BS1			2710	45WCrV8KU			5CW2SF	
1.2550		60WCrV7	S1			55WC20	2710	58WCr9KU			5KHV2SF	
1.2713	SKT4	55NiCrMoV6	L6			55NCDV7			F520S		5CNM	
1.2721		50NiCr13	L6			55NVC6	2550		F528			
1.2842		90MnCrV8	O2	BO2		90MV8				T31502	9G2F	
1.3501		100Cr2	E50100									
1.3505	SUJ2	100Cr6	52100	25135	31	100C6	2258	100Cr6	F1310		SCC15	
1.5024		46Si7					45S7	46Si7	F1451			
1.5025		51Si7	9259H		50Si7	51S7	2090	50Si7	F1450			
1.5026		55Si7			56Si7	55S7	2085	55Si7	F1440	G92550	55S2	
1.5027		60Si7	9260	251A60	60Si7	60S7		60Si7	F1441	G92600	60S2	
1.5028	SUP7	65Si7	9260H									
1.5415	STFA12	15Mo3	A204GrA	1503-243B		15D3	2912	16Mo3(KG)	F2601	K11820		
1.5419	SCPH11	20Mo4	4419	1503-243-430			2512	G20Mo5		G44190		
1.5423	SB450M	16Mo5	4520	1503-245-420				16Mo5(KG)	F2602	K11522		
1.5622		14Ni6	A350-LF5					14Ni6(KG)	F2641			
1.5732	SNC415(H)	14NiCr10	3415			14NC11		16NiCr11				
1.5752	SNC815(H)	14NiCr14	3310	655M13	36A	12NC15					20X2H4A	
1.6511	SUP10	36CrNiMo4	9840	816M40	110	40NCD3		36NiCrMo4(KB)			40CN2MA	
1.6523	SNCM220(H)	21NiCrMo2	8620	805M20	362	20NCD2	2506	20NiCrMo2			20CGNM	
1.6546	SNCM240	40NiCrMo2-2	8740	311-Tyre7				40NiCrMo2(KB)			38CGNM	
1.6566		17NiCrMo6-4										
1.6587		17CrNiMo6		820A16		18NCD6		14NiCrMo13				
1.6657		10NiCrMo13-4						14NiCrMo131				
1.7015	SCr415(H)	10Cr3	5015	523M15		12C3				G50150	15C	
1.7033	SCr430(H)	34Cr4	5132	530A32	18B	32C4		34Cr4(KB)		G51300	35C	
1.7035	SCr440(H)	41Cr4	5140	530M40	18	42C4	2245	41Cr4		G51400	40H	
1.7131	SCR415	16MnCr5	5115	527M17		16MCS	2511	16MnCr5		G51150	12KHN2	
1.7139		16MnCr5S					2127				18HG	
1.7176	SUP9(A)	55Cr3	5155	527A60	48	55C3	2253	55Cr3			50CGA	
1.7218	SCM420	25CrMo4	4130	CDS110		25CD4	2225	25CrMo4(KB)			20CM	
1.7220	SCM432	34CrMo4	4135	708A37		35CD4	2234	34CrMo4			35CM	
1.7223	SNB22-1	41CrMo4	4142					41CrMo4			40CFA	
1.7225	SCM440(H)	42CrMo4	4140	708M40	42CrMo4	42CD4	2244	42CrMo4	F1252		38HM	
1.7228		55NiCrMoV6G		823M30	33		2512	653M31				
1.7262	SCM415(H)	15CrMo5				12CD4	2216	12CrMo4				
1.7321		20mCr4					2625					
1.7335	SCM415(H)	13CrMo4-4	A182-F11	1501-620		15CD4-5	2216	14CrMo45			12CM	
1.7361		32CrMo12		722M24	40B	30CD12	2240	30CrMo12	F124A			
1.7380		10CrMo9-10	A182F22	1501-622		12CD9-10	2218	12CrMo9			12KH8	

Technical Information Material Groups

Mat'l No.	JIS	DIN	Material Description			Composition / Structure / Heat Treatment					HB	HRC	
			AISI/ASTM/SAE	BS	EN	Annealed							
1.7715		14MoV6-3		1503-660-440									
1.8159	SUP 10	50CrV4	6150	735A50	47	50CrV4	2230	50CrV4		G61500	50C GFA		
1.8161		58CrV4											
1.8509	SACM645	41CrAlMo7	A355A	905M39	41B	40CAD6-12	2940	41CrAlMo7					
1.8523		39CrMoV13-9		897M39	40C			36CrMoV12					

Mat'l No.	JIS	DIN	Material Description			Composition / Structure / Heat Treatment					HB	HRC
			AISI/ASTM/SAE	BS	EN	Quenched & Tempered						
1.5415	STFA 12	15Mo3	A204GrA	1503-243B		15D3	2912	16Mo3(KG)	F2601	K11820		
1.5423	SB450M	16Mo5	4520	1503-245-420				16Mo5(KG)	F2602	K11522		
1.5622		14Ni6	A350-LF5			16N6		14Ni6(KG)	F2641			
1.5732	SNC415(H)	14NiCr10	3415			14NC11		16NiCr11				
1.5752	SNC815(H)	14NiCr14	3310	655M13	36A	12NC15				20X2H4A		
1.5755	SNC236	31NiCr14		653M31		18NC13	2534			F1270		
1.6565	SNCM447	40NiCrMo6	4340	817M40	24	35NCD6	2541	35NiCrMo6(KB)		38C 2N2MA		
1.6587		17CrNiMo6		820A16		18NCD6		14NiCrMo13				
1.6657		10NiCrMo13-4						14NiCrMo131				
1.6957		26NiCrMoV14-5										
1.7015	SCr415(H)	10Cr3	5015	523M15		12C3				G50150	15C	
1.7262	SCM415(H)	15CrMo5				12CD4	2216	12CrMo4				
1.7335	SCM415(H)	13CrMo4-4	A182-F11	1501-620		15CD4-5	2216	14CrMo45			12C M	
1.7380		10CrMo9-10	A182F22	1501-622		12CD9-10	2218	12CrMo9			12KH8	
1.7715		14MoV6-3		1503-660-440				13MoCrV6				
1.7733		24CrMoV55				20CDV6		21CrMoV511				
1.7755		GS-45CrMoV10-4										
1.8070		21CrMoV511						35NiCr9				

Mat'l No.	JIS	DIN	Material Description			Composition / Structure / Heat Treatment					HB	HRC
			AISI/ASTM/SAE	BS	EN	Quenched & tempered						
1.1730		C45W3	C45W			XC48						
1.2332	SCM(440)	47CrMo4	4142	708M40	19A	42CD4	2244	42CrMo4				
1.5736	SNC 631 (H)	36NiCr10	3435			30NC11						
1.6523	SNCM220(H)	21NiCrMo2	8620	805M20	362	20NCD2	2506	20NiCrMo2		20C GNM		
1.7033	SCr430(H)	34Cr4	5132	530A32	18B	32C4		34Cr4(KB)		G51300	35C	
1.7218	SCM420	25CrMo4	4130	CDS110		25CD4	2225	25CrMo4(KB)		20C M		
1.8515		32CrMo12		722M24	40B	30CD12	2240	32CrMo12	F124A			

Technical Information Material Groups

Mat'l No.	JIS	DIN	Material Description			Composition / Structure / Heat Treatment					HB	HRC
			AISI/ASTM/SAE	BS	EN	Quenched & Tempered						
1.0904	SKH 1, SKT 4	55Si7	9255	250A53	45	55S7	2085	55Si8		G92550	55S2	
1.0961	SUP 7	60SiCr7	9262			60SC6		60SiCr8		G92620		
1.2067		100Cr6	L3	BL3		Y100C6		100Cr6				
1.2419	SKS31	105WCr6		105WC13		105WC13	2140	10WC6			CWG	
1.2542		45WCrV7	S1	BS1			2710	45WCrV8KU			5CW25F	
1.2713	SKT4	55NiCrMoV6	L6					55NCDV7		F5205	5C NM	
1.4882		X50CrMnNiNbN219						Z50CMNNb21-09				
1.5120		38MnSi4										
1.5710	SNC236	36NiCr6	3135	640A35	111A	35NC6						
1.5755	SNC236	31NiCr14		830m31		18NC13	2534			F1270		
1.6511	SUP10	36CrNiMo4	9840	816M40	110	40NCD3		36NiCrMo4(KB)			40C N2MA	
1.6546	SNCM240	40NiCrMo2-2	8740	311-Tyre7				40NiCrMo2(KB)			38C GNM	
1.7035	SCr440(H)	41Cr4	5140	530M40	18	42C4	2245	41Cr4		G51400	40H	
1.7176	SUP9(A)	55Cr3	5155	527A60	48	55C3	2253	55Cr3			50C GA	
1.7220	SCM432	34CrMo4	4135	708Aa37		35CD4	2234	34CrMo4			35C M	
1.7223	SNB22-1	41CrMo4	4142					41CrMo4			40C FA	
1.7225	SCM 440 (H)	42CrMo4	4140	708 M 40	42 CrMo 4	42 CD 4	2244	42 CrMo 4	F1252		38HM	
1.7361		32CrMo12		722M24	40B	30CD12	2240	30CrMo12	F124A			
1.8159	SUP 10	50CrV4	6150	735A50	47	50CrV4	2230	50CrV4	51CrV4	G61500	50C GFA	
1.8161		58CrV4										
1.8509	SACM 645	41CrAlMo7	A355A	905M39	41B	40CAD6-12	2940	41CrAlMo7				
1.8523		39CrMoV13-9		897M39	40C			36CrMoV12				

Mat'l No.	JIS	DIN	Material Description			Composition / Structure / Heat Treatment					HB	HRC
			AISI/ASTM/SAE	BS	EN	Annealed						
1.0347	SPCD	RRSt 3	A619	CR 3	Fe P03	F 13		DC03/FeP03			08JU	
1.0723	SUM32	15S22		210A15			1922			F210F		
1.2080	SKD1	X210Cr12	D3	BD3	X210Cr12	Z200C12		X205Cr12KU		T30403	KH12	
1.2162	SCR 420 H	21MnCr5				20MCS						
1.2311		40CrMnMo7				40CMD8		35CrM08KU				
1.2312		40CrMnMoS8.6	P20+S			40CMD8S						
1.2316		X36CrMo17			X38CrMo16							
1.2343	SKD 6	X38CrMoV5-1	H11	BH11		Z38CDV5		X37CrMoV51KU		T20811	4C 5MFS	
1.2344	SKD61	X40CrMoV5-1	H13	BH13		Z40CDV5	2242	X40CrMoV511KU	F5318	T20813	4C 5MF15	
1.2363	SKD12	X100CrMoV5-1	A2	BA2		Z100CDV5	2260	X100CrMoV51KU	F5227		9KH5VF	
1.2379	SKD11	X155CrMo121	D2	BD2		Z160CDV12	2310	X165CrMoW12KU		T30402	KH12MF	KRUPP2379
1.2436	SKD 2	X210CrW12	D4(D6)	BD6		Z200CD12	2312	X215CrW121KU	F5213		KH12	

Technical Information Material Groups

Mat'l No.	JIS	DIN	AISI/ASTM/SAE	BS	EN	AFNOR	SS	UNI	UNE / IHA	UNS	GOST	Brands	K	VDI 3323 19	Material Description Malleable cast iron	Composition / Structure / Heat Treatment Ferritic	HB 130	HRc
0.8135	FCMW330	GTS-35	32510	B 340-12	GJMB350-10	MN 35-10	0815	GMN 35	GTS35		Kc 35-10							

Mat'l No.	JIS	DIN	AISI/ASTM/SAE	BS	EN	AFNOR	SS	UNI	UNE / IHA	UNS	GOST	Brands	K	VDI 3323 20	Material Description Malleable cast iron	Composition / Structure / Heat Treatment Pearlitic	HB 230	HRc 21
0.8145	FCMW370	GTS-45	A220-40010	P 440-7	GJMB450-6	MN 450	0852	GMN 45										
0.8155	FCMP490	GTS-55	50005	P 510-4	GJMB-550-4	MP 50-5	0854	GMN 55			Kc 60-3							
0.8165	FCMP590	GTS-65	70003	P 570-3	GJMB-650-2	MN 650-3	0856	GMN 65										
0.8170	FCMP690	GTS-70	90001	P 690-2	GJMB-700-2	MN 700-2	0862	GMN 70			Kc 70-2							

Technical Information Material Groups

Mat'l No.	JIS	DIN	AISI/ASTM/SAE	BS	EN	AFNOR	SS	UNI	UNE / IHA	UNS	GOST	Brands	N	VDI 3323 21	Material Description Aluminum-wrought alloy	Composition / Structure / Heat Treatment Not Curable	HB 60	HRc
3.0205		A199	A199															
3.0255	(A1050)	A199.5	1000	L31		A59050C					D1							
3.3315		AlMg1																

Mat'l No.	JIS	DIN	AISI/ASTM/SAE	BS	EN	AFNOR	SS	UNI	UNE / IHA	UNS	GOST	Brands	N	VDI 3323 22	Material Description Aluminum-wrought alloy	Composition / Structure / Heat Treatment Curable, Hardened	HB 100	HRc
3.1325		AlCuMg1									AD35							
3.1655	A2011	AlCuSiPb																
3.2315		AlMgSi1									AK9							
3.4345		AlZnMgCuO.5	7050	L86		AZ4GU/9051		811-04										
3.4365	7075	AlZnMgCu1.5	7075	7075		7075		AlZn5.8MgCuCr			B95							

Mat'l No.	JIS	DIN	AISI/ASTM/SAE	BS	EN	AFNOR	SS	UNI	UNE / IHA	UNS	GOST	Brands	N	VDI 3323 23	Material Description Aluminum-cast, alloyed	Composition / Structure / Heat Treatment ≤ 12% Si, Not Curable	HB 75	HRc
3.2163		G-AlSi9Cu3									VAL8							
3.2382		GD-AlSi10Mg																
3.2383		G-AlSi0Mg(Cu)	A360.2	LM9			4253											
3.2581		G-AlSi12																
3.3561		G-AlMg5																
3.5101		G-MgZn4sE1Zr1	ZE41	MAG5														
3.5103		MgSE3Zn27r1	EZ33	MAG6		G-TR322												
3.5812		G-MgAl8Zn1	AZ81	NMAG1														
3.5912		G-MgAl9Zn1	AZ91	MAG7														
			A356-72	2789		NFA32-201												
A5052		G-AlSi12	356.1	LM25			4244				AK7							
		G-AlSi12	A413.2	LM6			4261											
ADC12		G-AlSi12(Cu)	A413.1	LM20			4260				AK12							
A6061		GD-AlSi12	A413.0				4247											
A7075		GD-AlSi8Cu3	A380.1	LM24			4250											

Technical Information Material Groups

Mat'l No.	JIS	DIN	Material Description			Composition / Structure / Heat Treatment					HB	HRc	
			AISI/ASTM/SAE	BS	EN	AFNOR	SS	UNI	UNE / IHA	UNS			GOST
N VDI 3323 24 Aluminum-cast, alloyed ≤ 12% Si, Curable, Hardened 90													
2.1871		G-AlCu4TiMg											
3.1754		G-AlCu5Ni1,5											
3.2371		G-AlSi7Mg	4218B									AK8	
3.2373	C4BS	G-AlSi9MgWA	SC64D			A-57G		4251				AK9	
3.2381		G-AlSi10Mg										AK12	
3.5106		G-MgAg3SE2Zr1	QE22	mag12									
		G-ALMG5	GD-AlSi12	LMS		A-SU12		4252					

Mat'l No.	JIS	DIN	Material Description			Composition / Structure / Heat Treatment					HB	HRc	
			AISI/ASTM/SAE	BS	EN	AFNOR	SS	UNI	UNE / IHA	UNS			GOST
N VDI 3323 26 Copper and Copper Alloys (Bronze / Brass) Cutting alloys, PB>1% 110													
2.0375		CuZn36Pb3										LS60-2	
2.1090		G-CuSn75pb	C93200			U-E7Z5pb4							
2.1096		G-CuSn5ZnPb	c83600	LG2									
2.1098		G-CuSn2Znpb	C83600										
2.1182		G-CuPb15Sn	C23000	LB1		U-pb15E8							

Mat'l No.	JIS	DIN	Material Description			Composition / Structure / Heat Treatment					HB	HRc	
			AISI/ASTM/SAE	BS	EN	AFNOR	SS	UNI	UNE / IHA	UNS			GOST
N VDI 3323 27 Copper and copper alloys (Bronze / Brass) CuZn, CuSnZn (Brass) 90													
2.0240	C2300	CuZn15										L90	
2.0321		CuZn37	C27200	cz108		CuZn36,CuZn37		C2700				L63	
2.0590		G-CuZn40Fe											
2.0592		G-CuZn35Al1	C86500	U-Z36N3		HTB1							
2.0596		G-CuZn34Al2	C86200	HTB1		U-Z36N3						LTs23AD	
2.1293		CuCrZr	C18200	CC102		U-Cr0-8Zr							

Mat'l No.	JIS	DIN	Material Description			Composition / Structure / Heat Treatment					HB	HRc	
			AISI/ASTM/SAE	BS	EN	AFNOR	SS	UNI	UNE / IHA	UNS			GOST
N VDI 3323 28 Copper and copper alloys (Bronze / Brass) CuSn, lead-free copper and electrolytic copper 100													
2.0060		E-Cu57											
2.0966		CuAl10Ni5Fe4	C63000	Ca104		U-A10N						BrAD	
2.0975		G-CuAl10Ni	B-148-52										
2.1050		G-CuSn10	c90700	CT1									
2.1052		G-CuSn12	C90800	pb2		UE12P							
2.1292		G-CuCrF35	C81500	CC1-FF									

Technical Information Material Groups

Mat'l No.	JIS	DIN	Material Description			Composition / Structure / Heat Treatment					HB	HRc	
			AISI/ASTM/SAE	BS	EN	AFNOR	SS	UNI	UNE / IHA	UNS			GOST
S VDI 3323 31 Heat resistant super alloys Fe Based, Annealed 200 15													
1.4558	NCF 800TB	X2NiCrAlTi3220	N08800	NA15									
1.4562		X1NiCrMoCu32287	N08031										
1.4563		X1NiCrMoCuNi31274	N08028			Z1NCDU31-27-03		2584				EK77	
1.4864	SUH330	X12NiCrSi36-16	330	NA17		Z12NCS37-18						N08330	
1.4865	SCH15	GX40NiCrSi38-18		330C40					XG50NiCr3919			J94605	
1.4958		X5NiCrAlTi3120											

Mat'l No.	JIS	DIN	Material Description			Composition / Structure / Heat Treatment					HB	HRc	
			AISI/ASTM/SAE	BS	EN	AFNOR	SS	UNI	UNE / IHA	UNS			GOST
S VDI 3323 32 Heat resistant super alloys Fe Based, Aged 280 30													
1.4977		X40CoCrNi2020				Z42CNKDWNb							

Mat'l No.	JIS	DIN	Material Description			Composition / Structure / Heat Treatment					HB	HRc	
			AISI/ASTM/SAE	BS	EN	AFNOR	SS	UNI	UNE / IHA	UNS			GOST
S VDI 3323 33 Heat resistant super alloys Ni or Co Based, Annealed 250 25													
2.4360		NiCu30Fe		NA13		NU30				N04400		Monel400	
2.4603		NiCr 30 FeMo	5390A			NC22FeD						Hastelloy G-30	
2.4610		NiMo16Cr16Ti								N026455		Hastelloy C-4	
2.4630		NiCr20Ti		HRS,203-4		NC20T				N06075		Nimonic75	
2.4631	NCF 80A	NiCr20TiAl		Hr40		NC20TA				N07080	KHN77TYuR	Nimonic 80A	
2.4642	NCF 690	NiCr29Fe				Nnc30Fe				N06690		Inconel 690	
2.4856		NiCr22Mo9Nb		NA21		NC22FeDNb				N06625		Inconel 625	
2.4858		NiCr21Mo		NA16		NC21FeDU				N08825	KHN38VT	Incoloy 825	

Mat'l No.	JIS	DIN	Material Description			Composition / Structure / Heat Treatment					HB	HRc	
			AISI/ASTM/SAE	BS	EN	AFNOR	SS	UNI	UNE / IHA	UNS			GOST
S VDI 3323 34 Heat resistant super alloys Ni or Co Based, Aged 350 38													
2.4375		NiCu30Al	4676	NA18		NU30AT				N05500		MonelK500	
2.4662		NiFe35Cr14MoTi	5660			ZSNCDT42				N09901		Incoloy 901	
2.4668		NiCr19Fe19NbMo	5383	HR8		NC19eNB				N07718		Inconel 718	
2.4670		S-NiCr13Al6MoNb	5391	Mar-46		NC12AD						Nimocast 713	
2.4694		NiCr16IE7TiAl								N07751		Inconel 751	
2.4955		NiFe25Cr20NbTi											
2.4964		CoCr20W15Ni	5772			KC20WN						Haynes 25	
		CoCr22W14Ni	AMS 5772			KC22WN							

Technical Information Material Groups

Mat'l No.	JIS	DIN	Material Description			Composition / Structure / Heat Treatment					HB	HRc	
			AISI/ASTM/SAE	BS	EN	AFNOR	SS	UNI	UNE / IHA	UNS			GOST
S VDI 3323 35 Heat resistant super alloys Ni or Co Based, Cast HB 320 HRc 34													
2.4669		NiCr15Fe7TiAl				NC15TNbA					N07750		Inconel X750
2.4685		G-NiMo28									N10665		Hastelloy B
2.4810		G-NiMo30											Hastelloy C
2.4973		NiCr19Co11MoTi	AMS 5399			NC19KDT					VT5-1		
3.7115		TiAl5Sn2									R54520	VT1-00	ATI Grade 6

Mat'l No.	JIS	DIN	Material Description			Composition / Structure / Heat Treatment					HB	HRc	
			AISI/ASTM/SAE	BS	EN	AFNOR	SS	UNI	UNE / IHA	UNS			GOST
S VDI 3323 36 Titanium alloys Pure Titanium HB 400 Rm													
2.4674		NiCo15Cr10MoAlTi	AMS 5397								N13100		IN 100
3.7025		Ti1	R50250	2TA1							R50250		ATI 30 CP Gr. 1
3.7225		Ti1pd	R52250	TP1							R52250		

Mat'l No.	JIS	DIN	Material Description			Composition / Structure / Heat Treatment					HB	HRc	
			AISI/ASTM/SAE	BS	EN	AFNOR	SS	UNI	UNE / IHA	UNS			GOST
S VDI 3323 37 Titanium alloys Alpha + Beta Alloys, Hardened HB 1050 Rm													
3.7124		TiCu2		2TA21-24									
3.7145		TiAl6Sn2Zr4Mo2Si	R54620								R54620		
3.7165		TiAl6V4	AMS R56400	TA10-13		T-A6V						VT6	
3.7185		TiAl4Mo4Sn2		TA45-51									
3.7195		TiAl3V2.5									R56320		ATI 3-2.5
		TiAl4Mo4Sn4Si0.5											
		TiAl5Sn2.5	AMS R54520	TA14/17		T-ASE							
		Ti6Al4VELI	AMS R56401	TA11									

Technical Information Material Groups

Mat'l No.	JIS	DIN	Material Description			Composition / Structure / Heat Treatment					HB	HRc	
			AISI/ASTM/SAE	BS	EN	AFNOR	SS	UNI	UNE / IHA	UNS			GOST
H VDI 3323 38 Hardened steel Hardened HB 550 HRc 55													
1.1231	S70 C-CSP	Ck 67	1070	060 A 67	C 67S	XC 68	1770	C 70	F5103		70		
1.1248	C75	Ck 75	1078, 1080	060 A 78	C 75S	XC 75	1774	C 75	F5107		75		
1.1274	SUP 4	Ck 101	1095	060 A 96	C 100S	XC100	1870	C100	F5117				
1.1545	SK 3	C 105 W1	W1	BW 2	C 105U	Y1 105	1880	C 100 KU	F5118		U10A		
1.2762		75CrMoNiW67	-	-	-	-	-	-	-		-		
1.3401	SCMnH1	GX120Mn12	A128(A)			Z120M12	2183	GX120Mn12	F8251		110G13L		
1.4021	SUS 420 J1	X 20 Cr 13	420	420 S 37	X 20 Cr 13	Z 20 C 13	2303	X 20 Cr 13	F5261		20KH13	ATI 420	
1.4109	SUS 440 A	X 65 CrMo 14	440 A	-	X 70 CrMo 15	Z 70 D 14	-	-	-		-	ATI 440A	
1.4112	SUS 440 B	X 90 CrMoV 18	440 B	409 S 19	X 90 CrMoV 18	Z 2 CND 18 05	2327	X CrTi 12					
1.4125	SUS 440 C	X 105 CrMo 17	440 C	-	X 105 CrMo 17	Z 100 CD 17	-	X 105 CrMo 17			95KH18	ATI 440C	
1.6746		32NiCrMo14-5	-	832M31	32nicRmO145	35NCD14	-	-					
1.7176	SUP9(A)	55Cr3	5155	527A60	48	55C3	2253	55Cr3					
1.7225	SCM 440 (H)	42CrMo4	4140	708 M 40	42 CrMo 4	42 CD 4	2244	42 CrMo 4	F.1252		38HM		

Mat'l No.	JIS	DIN	Material Description			Composition / Structure / Heat Treatment					HB	HRc
			AISI/ASTM/SAE	BS	EN	AFNOR	SS	UNI	UNE / IHA	UNS		
H VDI 3323 40 Chilled cast iron Cast HB 400 HRc 42												
0.9620		GX260NiCr42	A532 IB	Grade 2 A	GJN-HV520	FB Ni4 Cr2 BC	0512	-		F45001		Ni-Hard2
0.9625		GX330NiCr42	A532 IA	Grade 2 B	GJN-HV550	FB Ni4 Cr2 HC	0513	-		F45000		Ni-Hard1
0.9630		GX300 CrNiSi 9 5 2	A532 ID	Grade 2 C	GJN-HV600	FB Cr9 Ni5	0457	-		F45003		Ni-Hard 4
0.9640		GX300CrMoNi1521	-	-	-	-	-	-		F45005		
0.9650		GX260Cr27	-	Grade 3 D	-	-	0466	-				
0.9655		GX300CrNiMo271	-	Grade 3 E	-	-	-	-			20C 25N20S2	
1.4841	SUH 310	X15CrNiSi25-20	310	314531	X 15 CrNiSi 25 20	Z15CNS25-20	-	-		S31400		Cronifer 2520

Mat'l No.	JIS	DIN	Material Description			Composition / Structure / Heat Treatment					HB	HRc	
			AISI/ASTM/SAE	BS	EN	AFNOR	SS	UNI	UNE / IHA	UNS			GOST
H VDI 3323 41 Hardened cast iron Hardened HB 550 HRc 55													
0.9635		GX300 CrMo 15 3	-	-	-	-	-	-					
0.9645		GX260 CrMoNi 20 21	-	-	-	-	-	-			F45007		

Technical Information

Comparison Chart - Turning Chipbreakers

Negative Inserts

Material	YG	Sandvik	Iscar	Kenna metal	Seco	Walter	Mitsu bishi	Kyocera	Tungaloy	Sumi tomo	Taegutec	Korloy	Duracarb
STEEL	UF	PF	F3P NF	FF FN	F1 MF2	FP5	FH LP	GP PP	TF	FL SP	FG FA	VF HU	41
	UL		PP NF			FP5	FY SY	CQ VF	TSF	LU	FC FT	HC	43
	UM		TF	MN	M3	MP3	MP	HS	TM	GU UX	MC PC	VM GM	46
	UG	PM	GN M3P	MN	M3 MR3	MP5	MP MA	PS	TM	UG	MT PC	GR HR	45
	UC	PR	NR	MP RP	MR4	RP5	Standard	Standard	TH	UZ	MG-	B25	53
	UR	PR	NR R3P	UN RN MG-	MR3 MR6	RP7	RP MH RK	PT PH	THS	ME MU	RT	GR	
STAINLESS STEEL	MF	MF	SF	FF	MF1	NF4	LM	MQ	SF HRF	SU	EA ML	HA	
	MM	MM	M3M	MP	MF3 MF4	NM4	MM	MS	SM	GU	EM	GS	42
	MG	MM	TF, VL, M3M	MP, UP	MF4	MM5	MS, GM	MU, MS	SS	EX, UP	ML	HS, MM	42
	MR	MR	F3M	RF	M5	NR4	RM	MS MU	SH	EM	ET RT	RM	
CAST IRON	UC	PR	NR	MP RP	MR4	MK5	Standard	Standard	All Round	UZ	MG-	B25	53
	UR	PR	NR R3P	UN RN MG-	MR3 MR6	RK5 RK7	RP MH RK	PT PH	CH	ME MU	RT	GR	
	..MA			RP	MR7	..MA	MG-	C	CH	GZ	..MA		53
SUPER ALLOYS	SF	SF, XF	SF, PF, PP	FS, LF, UP	M1, MF1	NF4, NFT	FJ, LS	MQ, SK, TK	SF, HMM	EF, UP, EG	EA, ML	VP1, VP2	41
	SM	SM, XM	TF	MS, GP	MF4, MR3	NMS, NMT	MS	MS	HRF	EX	EM	VP3	42
	SR	XMR	MR	RP	MR4	NRS, NRT	RS, GJ	MU	HRM	MU	ET	VP4	45

Positive Inserts

Material	YG	Sandvik	Iscar	Kenna metal	Seco	Walter	Mitsu bishi	Kyocera	Tungaloy	Sumi tomo	Taegutec	Korloy	Duracarb
STEEL	UF	PF	PF	LF UF	MF2	PF2 FP4	FM LM LP	GQ PP	01 PSF	FP	FG	HFP	41
	UG	PM		MF	MF3	MP4 FP6	MP Standard MM MV	HQ	PS PM	MU	MT	C25	51
STAINLESS STEEL	UF	PF	PF	LF	MF2	MM4 PS5	FM LM LP	GQ PP	PM	FP	FG	HFP	41
CAST IRON	UG	PM		UF	MF3	MK4 RK4	MP Standard MM MV	HQ	CM	MU	MT	C25	51
ALUMINUM	AL		AS	MF	AL	PF2 PM2	AZ	CF CK	AL	AG	FL	AK	AU

Technical Information

Comparison Chart - Turning Grades

ISO	YG	Sandvik	Iscar	Kenna metal	Seco	Walter	Mitsu bishi	Kyocera	Tungaloy	Sumi tomo	Taegutec	Korloy	Duracarb
P05	YG1001	GC4205 GC4305		KCPK05	TP0500 TP0501	WPP05S	UE6105						
P10	YG3010		IC8005 IC428	KCP05 KC9105 KCP05B KCP10 KCP10B KC9110		WPP01 WPP10S	UE6110	CA5505 CA510	T9105 T9205	AC810P	TT8115	NC3010	DC9015
P15	YG3015	GC4315 GC4215	IC8150 IC9015	KCP10	TP1501 TP1500		MC6015	CA5515 CA515	T9115 T9215	AC8015P	TT8115	NC3215	DC9015
P20	YG3020 (YG801)	GC4325 GC4225	IC8250 IC9015	KCP25 KC9125 KCP25B	TP2501 TP2500	WPP20S	MC6025 UE6020	CA5525 CA525	T9125 T9225	AC8025P AC820P	TT8125	NC3220 NC3225 NC3120	DC9025
P30	YG3030	GC4335 GC4235	IC8350 IC8025	KCP30 KCP30B KCP40B KC9140	TP3501 TP3500	WPP30S	MC6035 UE6035 VP15TF	CA5535 CA530 CR9025	T9135 T9235	AC8035P AC830P AC630M	TT5100 TT8135	NC3030 NC5330 PC3545	DC9025 DC8035
M10	YG211	GC2015 GC1115	IC807 IC6015 IC8150	KCU10 KCM15 KCM15B KC5010	CP200 TS2000	WSM10S	MC7015 VP10RT US7020	CA6515 PR930	T6120 AH110 AH8005 AH8015	AC610M	TT9215 TT5080	PC8105 PC8110	
M20	YG3030	GC2025 GC1125	IC3028 IC8250	KCM25 KCM25B	TM2000 TS2500	WMP20S	MC7205 VP15TF VP20MF UP20M	CA6525	T6130 AH120 AH725 SH725 GH330	AC6030M AC610M AC520U	TT9225	PC8115 NC9115 PC5300	
M30	YG213	GC2220	IC808 IC6025 IC8350	KCU25 KC5025	CP500	WSM20S WSM21	US735 MP7035 VP15RT VP20RT	PR1025 PR1125 PR1425 PR1535	AH630 SH730 GH730	AC6030M AC630M AC830P	TT9235 TT9020 TT9080	NC9125 NC5330 PC9030	DC8035
M40	YG214	GC2035		KCM35 KCM35B	CP600 TM4000 TP40	WSM30S	US735 MP7035		AH645	AC6040M AC530U	TT9235 TT8020 TT8080	NC9135 PC5400	
K10	YG1010	GC3205 GC3210	IC5005 IC5010	KCK05	TK1001 TK1000	WKK10S	MC5005 MC5015 UC5105 UC5115	CA4505 CA4010	T5105 T515	AC405K	TT7005	NC6205	DC820 DC610
K15	YG1001 (YG3010)	GC3215	IC5100 IC8150	KCK15 KCK20	TK2001 TK2000	WKK20S WKP30S	UE6110 VP15TF	CA4515 CA4115 CA4120	T5125	AC415K AC420K	TT6300 TT7015 TT7025 TT7310	NC6210 NC6215	
S10	YG401 (YG211)	GC1105 S05F H13A	IC807 IC808	K313 K68 KCS10 KCU10 KC5010	TS2000 TS2050 TS2500 CP200	WSM10S WS10	VP05RT MP9005 VP10RT MP9015	CA6515 PR1305 PR1310	AH110 AH120 AH8005 AH8015 AH905 SH730	AC510U	TT9215 TT5080	PC8105 PC8110 PC8115	DC820 DC610
S20	YG401 (YG213)	GC1115	IC806	KCU25 KC5025	890 883	WSM20S WSM21	VP15TF VP20RT	CA6525 PR1125 PR1325 PR1535	AH725	AC520U	TT9225 TT9080	NC9125 NC9135 PC5300	
S30	YG214	GC1125			CP500 CP600	WSM30S		PR1125 PR1535			TT9235 TT8020 TT8080	PC5400	

Technical Information Comparison Chart - Milling Grades

ISO	YG-1	Sandvik	Iscar	Kennametal	Seco	Walter	Mitsubishi	Kyocera	Tungaloy	Sumitomo	Taegutec	Korloy
P20	YG712	GC4220 GC4230	IC950	KCPM20 KC522M	MP2500 MP3000 T250M	WKP25 WKP25S	MP6120 VP15TF	PR720 PR1025 PR1225	T3130 AH330 GH330	ACP200	TT7080 TT7030	NC5330 PC3500 PC3600
P30	YG713 YG622 YG602	GC1025 GC1030	IC808 IC907 IC908	KC522M KC635M KC927M	F25M F30M	WAM30 WKP35	MP6120 VP15TF MP6130 F7030	PR630 PR830 PR1230	AH725 AH730 AH120 GH130	ACP300 ACZ350	TT9080 TT9030	NC5340 NCM325 PC5300
P40	YG613	GC1030	IC928	KC935M	F40M	WKP45	VP30RT	PR660 PR1535	AH3135		TT8020 TT8080	PC5400
M20	YG613 YG602	GC1025 GC2030	IC808 IC907 IC908	KC522M KC635M	MP2500 F25M F30M	WQM35 WSM35S	VP15TF VP20RT	PR730 PR1025 PR1225	T3030 AH725 AH120 AH4035	ACP200 ACM100 ACM200	TT9030 TT9080	NC5330 PC5300 PC9530 NC5340 NCM325
M30	YG613	GC2040	IC328 IC330	KC722 KC725M	F40M	WSM40	F7030 MP7130 VP30RT	PR1535	AH3135	ACM300	TT8020 TT8080	PC5400
K10	YG5020 YG501	GC3330	IC5100	KC915M	MK1500 MP1500	WAK15	MP8010 MC5020			ACK100	TT7515	PC8110 PC6510
K20	YG622	GC3040	IC810 IC910	KCK15 KC520M	MK2050	WKK25	VP15TF	PR1210 PR1510	T1115 AH110	ACK200 ACK300	TT6080	NC5330 PC5300 NC5340
S20	YG613	GC1040 S40T	IC328 IC408	KCU30M	MS2050	WSM35S	MP9130	PR905 PR1025	AH725	AC520U	TT8020	PC5400

ISO ↔ ANSI

ISO	ANSI	ISO	ANSI
CC.. 060202	CC.. 21.50.5	SE.. 1203	SE.. 42
CC.. 060204	CC.. 21.51	SN.. 120404	SN.. 431
CC.. 060208	CC.. 21.52	SN.. 120408	SN.. 432
CC.. 09T302	CC.. 32.50.5	SN.. 120412	SN.. 433
CC.. 09T304	CC.. 32.51	SN.. 120416	SN.. 434
CC.. 09T308	CC.. 32.52	SN.. 150612	SN.. 543
CC.. 120402	CC.. 430.5	SN.. 190616	SN.. 644
CC.. 120404	CC.. 431	SP.. 1203	SP.. 42
CC.. 120408	CC.. 432	SP.. 120308	SP.. 422
CC.. 120412	CC.. 433	SP.. 1504	SP.. 53
CN.. 090308	CN.. 322	TC.. 110204	TC.. 21.51
CN.. 090312	CN.. 323	TC.. 110208	TC.. 21.52
CN.. 090408	CN.. 332	TC.. 16T302	TC.. 32.50.5
CN.. 090412	CN.. 333	TC.. 16T304	TC.. 32.51
CN.. 120404	CN.. 431	TC.. 16T308	TC.. 32.52
CN.. 120408	CN.. 432	TN.. 160404	TN.. 331
CN.. 120412	CN.. 433	TN.. 160408	TN.. 332
CN.. 120416	CN.. 434	TN.. 160412	TN.. 333
CN.. 160608	CN.. 542	TN.. 220404	TN.. 431
CN.. 160612	CN.. 543	TN.. 220408	TN.. 432
CN.. 160616	CN.. 544	TN.. 220412	TN.. 433
CN.. 190608	CN.. 642	TN.. 220416	TN.. 434
CN.. 190612	CN.. 643	TP.. 1603	TP.. 32
CN.. 190616	CN.. 644	TP.. 160308	TP.. 322
DC.. 070202	DC.. 21.50.5	TP.. 2204	TP.. 43
DC.. 070204	DC.. 21.51	VB.. 160404	VB.. 331
DC.. 070208	DC.. 21.52	VB.. 160408	VB.. 332
DC.. 11T302	DC.. 32.50.5	VC.. 110301	VC.. 220
DC.. 11T304	DC.. 32.51	VC.. 110302	VC.. 220.5
DC.. 11T308	DC.. 32.52	VC.. 110304	VC.. 221
DN.. 110404	DN.. 331	VC.. 160402	VC.. 330.5
DN.. 110408	DN.. 332	VC.. 160404	VC.. 331
DN.. 150404	DN.. 431	VC.. 160408	VC.. 332
DN.. 150408	DN.. 432	VN.. 160404	VN.. 331
DN.. 150412	DN.. 433	VN.. 160408	VN.. 332
DN.. 150604	DN.. 441	VN.. 160412	VN.. 333
DN.. 150608	DN.. 442	WN.. 060404	WN.. 331
DN.. 150612	DN.. 443	WN.. 060408	WN.. 332
SC.. 09T304	SC.. 32.51	WN.. 060412	WN.. 333
SC.. 09T308	SC.. 32.52	WN.. 080404	WN.. 431
SC.. 120408	SC.. 432	WN.. 080408	WN.. 432
SD.. 1203	SD.. 42	WN.. 080412	WN.. 433
SD.. 120420	SD.. 435	WN.. 080416	WN.. 434
SD.. 1504	SD.. 53	WN.. 080416	WN.. 434

Search

Description	Page
INSERT	
ADKT	137
AOMT	137
APKT	138
APMT	139
APXT	140
CCGT	54
CCMT	54
CNGG	32
CNMA	28
CNMG	28
DCGT	55
DCMT	55
DNGG	36
DNMA	33
DNMG	33
DNUX	37
ENMX	152
KNUX	38
ODMT	119
ODMW	119
OFER	120
OFMT	120
ONHU	121
ONMU	121
RBEX	148
PNMU	122
RCMT	56
RDKT	145
RDKW	145
RDMT	146
RDMW	146
RPMT	147
RPMW	147
SCGT	57
SCMT	57
SDCN	123
SDKN	123
SDMT	154
SDMW	154
SEKN	124
SEKR	124
SEKT	125
SEGT	126
SEMT	127
SNMA	39
SNMG	39
SNMX	128
SPCN	129
SPKN	129
SPKR	129
SPMT	130
SPMX	169
SPUN	131
TCGT	58
TCMT	58
TDN	103
TDP	103
TDY	103
TNMA	43

Description	Page
TNMG	43
TNUX	47
TPCN	141
TPKN	141
TPKR	141
TPUN	142
VBMT	59
VCMT	60
VCMT	60
VNMA	48
VNMG	48
WCMX	170
WNGG	53
WNMA	50
WNMG	50

MILLING CUTTER

...-APKT10-...	132
...-APKT16-...	134
...-ENMX06-...	149
...-ENMX09-...	150
...-M08-...	155
...-M10-...	155
...-M12-...	155
...-M16-...	155
...-ODMT06-...	115
...-OFER07-...	115
...-ONMU08-...	113
...-PNMU12-...	116
...-RDKT08-...	143
...-RDKT10-...	143
...-RDKT12-...	144
...-SDMW12-...	151
...-SE12T3-...	117
...-SEKT12-...	117
...-SNMX12-...	114
...-SPKN12-...	118
...-TPKN16-...	136
...-TPKN22-...	136

DRILL HOLDER

YGSP	158
YGWC	162

TURNING HOLDER

CKJNR/L	69
MTJNR/L	75
MWLNRL	79
PCBNR/L	66
PCLNR/L	66
PDJNR/L	68
PDNNN	68
PSBNR/L	72
PSDNN	72
PSKNR/L	72
PSSNR/L	72
PTFNR/L	74

Description	Page
PTGNR/L	74
PTJNR/L	75
PTTNR/L	74
PWLNRL	79
SCACR/L	65
SCLCR/L	65
SDJCR/L	67
SDNCN	67
SRDCN	70
SRGCR/L	70
SSDCN	71
SSSCR/L	71
STFCR/L	73
STGCR/L	73
STJCR/L	73
STUCR/L	73
SVHBR/L	76
SVHCR/L	77
SVJBR/L	76
SVJCR/L	77
SVVBN	76
SVVCN	77
TCLNR/L	66
TDHNR/L	68
TDJNR/L	68
TDNNN	68
TSDNN	72
TSKNR/L	72
TSSNR/L	72
TTGNR/L	74
TTJNR/L	75
TVJNR/L	78
TVVNN	78
TWLNRL	79
...-MTFNR/L	88
...-MTUNR/L	88
...-MWLNRL	93
...-PCLNR/L	82
...-PDQNR/L	85
...-PDUNR/L	85
...-PSKNR/L	86
...-PTUNR/L	89
...-PWLNRL	93
...-SCFCR/L	80
...-SCLCR/L	81
...-SDQCR/L	83
...-SDUCR/L	84
...-STFCR/L	87
...-STUCR/L	87
...-SVJBR/L	90
...-SVQBR/L	90
...-SVQCR/L	91
...-SVUBR/L	90
...-SVUCR/L	91
...-TCLNR/L	82
...-TDQNR/L	85
...-TDUNR/L	85
...-TTUNR/L	89
...-TVUNR/L	92
...-TWLNRL	94

MEMO



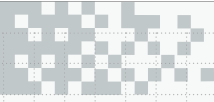

HIGH QUALITY PRODUCTS and ON TIME DELIVERY for WORLD-WIDE CUSTOMERS

Since 1982, YG-1 has been committed to quality, innovation and the unique customer experience. Our performance and experience have granted YG-1 the global impression of one of the leading manufacturers of high quality cutting tool solutions. This global footprint expands over 75 countries, with international logistic centers, pledging to our customers to give the best service available today - and tomorrow.

EUROPE

BELGIUM	FINLAND	ITALY	PORTUGAL	SLOVENIA	THE NETHERLANDS
CROATIA	FRANCE	LITHUANIA	ROMANIA	SPAIN	TURKEY
CZECH REPUBLIC	GERMANY	NORWAY	RUSSIA	SWEDEN	UNITED KINGDOM
DENMARK	HUNGARY	POLAND	SERBIA	SWITZERLAND	

ASIA PACIFIC

AUSTRALIA	INDONESIA	MALAYSIA	SINGAPORE	UNITED ARAB EMIRATES
CHINA	ISRAEL	PAKISTAN	SOUTH KOREA	VIETNAM
HONG KONG	JAPAN	PHILIPPINES	TAIWAN	
INDIA	KINGDOM OF SAUDI ARABIA	THAILAND		

AMERICAS

BRAZIL	CANADA	COLOMBIA	MEXICO	UNITED STATES
--------	--------	----------	--------	---------------

AFRICA

EGYPT	SOUTH AFRICA
-------	--------------

YG-1 CO., LTD.

* For the more information on sales network, please contact the head office as below;

YG-1 HEAD OFFICE 13-40, Songdogwahak-ro 16beon-gil, Yeonsu-gu, Incheon 21984, South Korea

Notice YG-1 Global head office is relocating from December 2020 to a new address as above;
Phone : +82-32-526-0909 e-mail : yg1@yg1.kr www.yg1.kr



HEAD OFFICE

13-40, Songdogwahak-ro 16beon-gil, Yeonsu-gu, Incheon 21984, South Korea

Notice YG-1 Global head office is relocating from December 2020 to a new address as above;

Phone: +82-32-526-0909

Https://www.yg1.kr E-mail: yg1@yg1.kr

Note The information is provided for reference only. Tool specifications are subject to change without prior notice. Although we endeavor to supply accurate and timely information, there can be no guarantee to cover every particular application. YG-1 or publishers are not liable for any damage for use of the information.



Search 'YG-1' on social media outlets

YG1YEIT210705003